

Uniform Random Planar Graphs with Degree Constraints

Chris Dowden

August 11, 2008

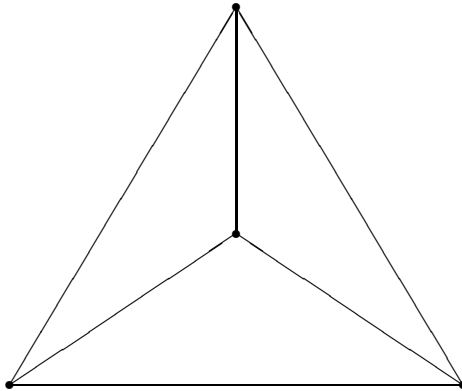

Uniform Random Planar Graphs with Degree Constraints

Chris Dowden (Merton College)

D.Phil. thesis, Trinity 2008

Abstract

Random planar graphs have been the subject of much recent work. Many basic properties of the standard uniform random planar graph P_n , by which we mean a graph chosen uniformly at random from the set of all planar graphs with vertex set $\{1, 2, \dots, n\}$, are now known, and variations on this standard random graph are also attracting interest.

Prominent among the work on P_n have been asymptotic results for the probability that P_n will be connected or contain given components/subgraphs. Such progress has been achieved through a combination of counting arguments [16] and a generating function approach [11].

More recently, attention has turned to $P_{n,m}$, the graph taken uniformly at random from the set of all planar graphs on $\{1, 2, \dots, n\}$ with exactly $m(n)$ edges (this can be thought of as a uniform random planar graph with a constraint on the average degree). In [9] and [11], the case when $m(n) = \lfloor qn \rfloor$ for fixed $q \in (1, 3)$ has been investigated, and results obtained for the events that $P_{n, \lfloor qn \rfloor}$ will be connected and that $P_{n, \lfloor qn \rfloor}$ will contain given subgraphs.

In Part I of this thesis, we use elementary counting arguments to extend the current knowledge of $P_{n,m}$. We investigate the probability that $P_{n,m}$ will contain given components, the probability that $P_{n,m}$ will contain given subgraphs, and the probability that $P_{n,m}$ will be connected, all for general $m(n)$, and show that there is different behaviour depending on which ‘region’ the ratio $\frac{m(n)}{n}$ falls into. In Part II, we investigate the same three topics for a uniform random planar graph with constraints on the maximum and minimum degrees.

Acknowledgements

I would like to thank the University of Oxford, Merton College, the Statistics Department and the Mathematical Institute for the use of various resources, and the Engineering and Physical Sciences Research Council for providing me with funding. I would also like to thank Louigi Addario-Berry for his work on Section 18, and Stefanie Gerke and Alex Scott for refereeing the thesis.

On a personal note, I am grateful to Dominic Welsh and Colin McDiarmid for taking the time to reply to my enquiries about coming to Oxford, and also to the latter for supervising me. Most importantly, I would like to thank my parents for their love and support.

Contents

1	Introduction	6
I	The Evolution of Uniform Random Planar Graphs	11
2	Outline of Part I	11
3	Previous Results	15
4	Pendant Edges	22
5	Addable Edges	32
6	Components I: Lower Bounds	49
7	Connectivity & $\kappa(P_{n,m})$	61
8	Components II: Upper Bounds	74
9	General Subgraphs & Acyclic Subgraphs	81
10	Unicyclic Subgraphs	95
11	Multicyclic Subgraphs	106

II Random Planar Graphs with Bounds on the Minimum and Maximum Degrees	110
12 Outline of Part II	110
13 Connectivity	113
14 Growth Constants	121
15 Appearances	126
16 Components	146
17 Subgraphs	155
18 Subgraphs of 4-Regular Graphs	165
19 General Bounds	188
20 $D_1(n) \rightarrow \infty$	196

1 Introduction

Random Graphs

Over the last 50 years, random graphs have been the subject of much activity. Two main types of random graph have been studied in particular — the random graph with edge probability p and the uniform random graph with m edges (where we take ‘graph’ to mean ‘simple labelled graph’, as throughout this thesis).

The *random graph with edge probability p* is the random graph on the vertex set $\{1, 2, \dots, n\}$ where each of the $\binom{n}{2}$ possible edges occur independently with probability $p = p(n)$. Thus, we would expect the number of edges to be around $p\binom{n}{2}$, but any number is possible. By contrast, the *uniform random graph with m edges* is the graph taken uniformly at random from among all the graphs on $\{1, 2, \dots, n\}$ that have *exactly* $m = m(n)$ edges. Thus, each edge occurs with probability $\frac{m}{\binom{n}{2}}$, but not independently of the other edges.

An alternative way to define the uniform random graph with m edges is via the *random graph process*, where one starts at stage zero with an empty graph and inserts all $\binom{n}{2}$ edges one by one in a (uniformly) random order. The m th stage of this random graph process is a uniform random graph with m edges.

Much is known about how the properties of our two types of random graph depend on the functions $p(n)$ and $m(n)$. For example, it is known that $n^{-1} \log n$ is a ‘threshold’ for the property that a random graph with edge probability p will be connected, meaning that

$$\mathbf{P}[\text{connected}] \rightarrow \begin{cases} 0 & \text{if } \frac{np(n)}{\log n} \rightarrow 0 \text{ as } n \rightarrow \infty \\ 1 & \text{if } \frac{np(n)}{\log n} \rightarrow \infty \text{ as } n \rightarrow \infty. \end{cases}$$

Thresholds (for both types of random graphs) are also known for properties such as ‘containing a subgraph isomorphic to H ’ or ‘containing a component isomorphic to H ’ and it has become customary to refer to this development of

random graphs as p or m grows as the ‘evolution’ of the random graph.

An important tool in the investigation of the random graph with edge probability p is the use of probabilistic methods. For example, if X is a function of a graph (such as ‘the number of subgraphs isomorphic to H in a graph’) and we wish to know bounds for $\mathbf{P}[X = 0]$, then it is often helpful to work out $\mathbf{E}(X)$ and $\text{var}(X)$, the calculation of which is facilitated by the fact that each edge occurs independently of all the others. Certain results can then be transferred over to uniform random graphs, since it can be shown that a close relationship exists between the random graph with edge probability p and the uniform random graph with $m = p \binom{n}{2}$ edges.

Planar Graphs

A graph is said to be *planar* if it is possible to draw it in the plane (or, equivalently, on the sphere) in such a way that the edges do not cross, meeting only at vertices. For example, K_4 is planar, since it can be drawn as on the title page. In the rest of this subsection, we shall collect together (without proof) various basic properties of planar graphs that will be useful later.

Throughout this thesis, we shall use $\mathcal{P}(n)$ to denote the class of all planar graphs on the vertex set $\{1, 2, \dots, n\}$. It can be shown that, for $n \geq 3$, the maximum number of edges of a graph in $\mathcal{P}(n)$ is $3n - 6$, so K_5 , for example, cannot be planar, since it has 10 edges. The maximum size (where we use ‘size’ to mean the number of edges) is achieved if and only if a graph is a *triangulation*, i.e. if and only if it is possible to draw the graph in the plane in such a way that each face, including the outside face, is a triangle. It is always possible to extend a planar graph to a triangulation by inserting extra edges.

Another useful property of $\mathcal{P}(n)$ is *edge-addability*: for each graph G in $\mathcal{P}(n)$,

any graph that is obtained from G by adding an edge between two vertices in different components is also in $\mathcal{P}(n)$. This follows from the important fact that we may draw G in such a way that any given face is on the outside.

Random Planar Graphs

Since they were first investigated in [4], random planar graphs have generated much interest. There are three main models — the random planar graph with edge probability p , the random planar graph process, and the uniform random planar graph with m edges.

The *random planar graph with edge probability p* is defined to be the graph obtained by repeatedly sampling a (general) random graph with edge probability p until we find one that is planar. Note that this planarity condition distorts the randomness in such a way that the probabilistic methods used for the original case are no longer helpful, making this model difficult to study.

However, if we let $p = \frac{1}{2}$ then we obtain P_n , the graph taken uniformly at random from the set of all graphs in $\mathcal{P}(n)$. In [16], the limiting probability (as $n \rightarrow \infty$) was found for the event that P_n will contain a component isomorphic to an arbitrary fixed connected planar graph. This result was proven using ‘counting’ methods: to calculate the proportion of graphs with a particular property, we think of a way to construct graphs with this property, we count how many graphs we can create this way, and we count how many times each graph will be constructed (i.e. the amount of double-counting). An inherent difficulty with this approach is that we need to be able to count with accuracy.

A vital tool in the aforementioned result of [16] was a rather precise asymptotic estimate of $|\mathcal{P}(n)|$, which was proven in [11] using the concept of generating

functions. The *exponential generating function* for a class \mathcal{A} is defined to be $A(x) = \sum_{n \geq 0} \frac{a_n}{n!} x^n$, where a_n denotes the number of elements of \mathcal{A} that have parameter n (e.g. \mathcal{A} could be the class of planar graphs and a_n could be $|\mathcal{P}(n)|$). The structure of \mathcal{A} can sometimes be used to produce algebraic equations involving $A(x)$ and its derivatives, which can then be solved to find $A(x)$ explicitly. By analysing the singularities of $A(x)$, one may then be able to derive the asymptotic behaviour of a_n . Unfortunately, the equations involved may be extremely difficult to solve.

The *random planar graph process* is a random graph process equipped with an additional acceptance test: before we insert an edge, we check whether the resulting graph would be planar and, if not, we reject the edge (and never look at it again). Properties such as connectivity and containing given subgraphs were studied for this model in [10], using counting methods.

The *uniform random planar graph with m edges*, $P_{n,m}$, is the graph taken uniformly at random from the set of all graphs in $\mathcal{P}(n)$ with exactly m edges. We shall use $\mathcal{P}(n, m)$ to denote this set. Thus, the probability that $P_{n,m}$ will have a particular property is simply equal to the proportion of graphs in $\mathcal{P}(n, m)$ that have that property. Unlike with general random graphs, it turns out that $P_{n,m}$ is not equivalent to the graph obtained by the random planar graph process after m edges have been accepted.

It is known from general uniform random graph theory (see, for example, Theorem 5.5 of [14]) that, *asymptotically almost surely* (a.a.s., that is, with probability tending to 1 as n tends to infinity), a graph taken uniformly at random from the class of all size m graphs on $\{1, 2, \dots, n\}$ will be planar if $\frac{m(n)}{n}$ is bounded above by $C < \frac{1}{2}$. Thus, for this region of m , uniform random planar graphs behave in the same way as general uniform random graphs. Since the latter have already been extensively investigated, the interest for planar graphs

lies with the case when $m \geq Cn$. Also, recall that (for $n \geq 3$) we must have $m \leq 3n - 6$ for planarity to be possible.

Generating functions were used in [11] to give rather precise asymptotic expressions for both $|\mathcal{P}(n, \lfloor qn \rfloor)|$ and $|\mathcal{P}_c(n, \lfloor qn \rfloor)|$ for fixed $q \in (1, 3)$, where $\mathcal{P}_c(n, m)$ denotes the class of connected graphs in $\mathcal{P}(n, m)$, and these results can be combined to give an expression for $\mathbf{P}[P_{n, \lfloor qn \rfloor} \text{ will be connected}]$ for $q \in (1, 3)$. Also, $\mathbf{P}[P_{n, \lfloor qn \rfloor} \text{ will contain a given subgraph}]$ has been investigated in [9] using counting methods. A more detailed summary of all such results shall be given in Section 3.

Overview of Thesis

This thesis shall be split into two distinct parts. These shall deal, respectively, with uniform random planar graphs with m edges, adding to the existing literature, and then with the unexplored topic of random planar graphs with bounds on the minimum and maximum degrees.

In Part I, we shall use counting methods to investigate the behaviour of $P_{n, m}$, the uniform random planar graph with n vertices and m edges, as $m(n)$ varies. We will extend the connectivity and subgraph results of [9] and [11] to cover the case when m is not of the form $\lfloor qn \rfloor$, as well as investigating the largely uncharted region of $m \leq (1 + o(1))n$. We shall also examine the thresholds for $P_{n, m}$ containing given components. A summary of our main results is given on page 14.

Clearly, $P_{n, m}$ can be thought of as a random planar graph with constraints on the average degree. In Part II, we shall instead look at random planar graphs with constraints on the minimum and maximum degrees. Again, we shall use counting methods to investigate the typical properties of such graphs and see how these vary with our constraints. A summary of these results is given on page 112.

Part I

The Evolution of Uniform Random Planar Graphs

2 Outline of Part I

As already mentioned in Section 1, we shall now investigate how the properties of planar graphs change depending on the number of edges. In particular, we will look at a graph $P_{n,m(n)}$ taken uniformly at random from the set of all labelled planar graphs on $\{1, 2, \dots, n\}$ with $m(n)$ edges, and see how the behaviour of $P_{n,m}$ varies with the ratio $\frac{m(n)}{n}$ (as mentioned in Section 1, we may assume that $\liminf_{n \rightarrow \infty} \frac{m}{n} > 0$, since otherwise our planarity condition has no impact). We shall focus on three topics: the probability that $P_{n,m}$ will contain given components, the probability that $P_{n,m}$ will be connected, and the probability that $P_{n,m}$ will contain given subgraphs. Our objective will be to show exactly when, in terms of $\frac{m(n)}{n}$, these probabilities converge to 0, converge to 1, or are bounded away from both 0 and 1.

We shall start in Section 3 by giving a detailed summary of the state of knowledge of $P_{n,m}$ prior to this thesis. We will also include results for P_n , the graph taken uniformly at random from the set of all labelled planar graphs on $\{1, 2, \dots, n\}$, since this model is closely related to $P_{n,m}$.

In Sections 4 and 5 of this thesis, we shall then do the groundwork for our later theorems by investigating the number of pendant edges (i.e. the number of edges incident to a vertex of degree 1) and the number of addable edges (i.e. the number of edges that can be added individually to a planar graph without destroying planarity). These results will be important ingredients for our later counting arguments.

We shall then start to use our ingredients to examine the probability that $P_{n,m}$ will contain a component isomorphic to a given graph H , the results for which are summarised on page 14. First, in Section 6, we will produce various lower bounds for this probability (splitting into different cases depending on both $e(H) - |H|$ and $m(n)$), where by ‘lower bound’ we mean results such as $\mathbf{P}[P_{n,m} \text{ will contain a component isomorphic to } H] \rightarrow 1$ as $n \rightarrow \infty$ or $\liminf_{n \rightarrow \infty} \mathbf{P}[P_{n,m} \text{ will contain a component isomorphic to } H] > 0$, rather than precise figures. In Sections 7 and 8, we shall then obtain exactly complementary upper bounds.

The upper bounds of Section 7 will, in fact, be obtained through achieving another of our objectives by producing an account of the probability that $P_{n,m}$ will be connected (in which case it clearly won’t contain any component of order $< n$), and a summary of the results for this topic is also given on page 14. As a spin-off, we shall obtain (in the second half of Section 7) some results on the total number of components in $P_{n,m}$, which (although not one of our primary themes) is quite an interesting subject in its own right.

In Sections 9–11, we will turn our attention to $\mathbf{P}[P_{n,m} \text{ will contain a given subgraph}]$, again dealing separately with different cases depending on the number of edges of the subgraph. These results are again summarised on page 14, for the simplified case when the subgraph is connected.

Often we may prove slightly stronger results than those stated on page 14. For example, we might show that the probability that $P_{n,m}$ has at least t *vertex-disjoint induced order-preserving* copies of H converges to 1, rather than just $\mathbf{P}[P_{n,m} \text{ has a copy of } H] \rightarrow 1$, or $\mathbf{P}[P_{n,m} \text{ has a component isomorphic to } H] > 1 - e^{-\Omega(n)}$ rather than just $\mathbf{P}[P_{n,m} \text{ has a component isomorphic to } H] \rightarrow 1$. Typically, these extensions will not alter the idea of a proof, but may make some of the details slightly more complicated.

Throughout, we shall use ‘Lemma’, ‘Theorem’ and ‘Corollary’ in the usual way, with ‘Proposition’ reserved for those results that are at a tangent to our

three main objectives (such as when we look at the total number of components in $P_{n,m}$) and also for results that were given in other papers.

To aid the reader, a diagram will be given at the start of each section to illustrate how it is structured. Arrows are used to show the relationship between the results, with those of that section highlighted in bold, and the main theorems circled.

Summary of Component Results

For a connected planar graph H , let $\mathbf{P} := \mathbf{P}[P_{n,m}$ will have a component $\cong H]$.

	$e(H) < H $	$e(H) = H $	$e(H) > H $
$0 < \underline{\lim} \frac{m}{n}$ & $\frac{m}{n} \leq 1 + o(1)$	$\mathbf{P} \rightarrow 1$ (Cor. 39)	$\underline{\lim} \mathbf{P} > 0$ (T37) $\overline{\lim} \mathbf{P} < 1$ (L52)	$\mathbf{P} \rightarrow 0$ (Thm. 51)
$1 < \underline{\lim} \frac{m}{n}$ & $\overline{\lim} \frac{m}{n} < 3$	$\underline{\lim} \mathbf{P} > 0$ (T36) $\overline{\lim} \mathbf{P} < 1$ (L42)	$\underline{\lim} \mathbf{P} > 0$ (T36) $\overline{\lim} \mathbf{P} < 1$ (L42)	$\underline{\lim} \mathbf{P} > 0$ (T36) $\overline{\lim} \mathbf{P} < 1$ (L42)
$\frac{m}{n} \rightarrow 3$	$\mathbf{P} \rightarrow 0$ (Cor. 45)	$\mathbf{P} \rightarrow 0$ (Cor. 45)	$\mathbf{P} \rightarrow 0$ (Cor. 45)

Summary of Connectivity Results

Let $\mathbf{P}_c := \mathbf{P}[P_{n,m}$ will be connected].

$\frac{m}{n} \leq 1 + o(1)$	$\mathbf{P}_c \rightarrow 0$ (Corollary 39)
$1 < \underline{\lim} \frac{m}{n}$ & $\overline{\lim} \frac{m}{n} < 3$	$\underline{\lim} \mathbf{P}_c > 0$ (Lemma 42) $\overline{\lim} \mathbf{P}_c < 1$ (Theorem 37)
$\frac{m}{n} \rightarrow 3$	$\mathbf{P}_c \rightarrow 1$ (Corollary 45)

Summary of Subgraph Results

For a connected planar graph H , let $\mathbf{P}_s := \mathbf{P}[P_{n,m}$ will have a copy of $H]$.

	$e(H) < H $	$e(H) = H $	$e(H) > H $
$0 < \underline{\lim} \frac{m}{n}$ & $\overline{\lim} \frac{m}{n} < 1$	$\mathbf{P}_s \rightarrow 1$ (Cor. 39)	$\underline{\lim} \mathbf{P}_s > 0$ (T37) $\overline{\lim} \mathbf{P}_s < 1$ (T64)	$\mathbf{P}_s \rightarrow 0$ (C69)
$\frac{m}{n} \rightarrow 1$	$\mathbf{P}_s \rightarrow 1$ (Cor. 39)	$\mathbf{P}_s \rightarrow 1$ (Lem. 65)	Unknown (see Section 11)
$\underline{\lim} \frac{m}{n} > 1$	$\mathbf{P}_s \rightarrow 1$ (Thm. 61)	$\mathbf{P}_s \rightarrow 1$ (Thm. 61)	$\mathbf{P}_s \rightarrow 1$ (T61)

3 Previous Results

Recall that P_n is the graph taken uniformly at random from the set of all graphs in $\mathcal{P}(n)$ and that $P_{n,m}$ is the graph taken uniformly at random from the set of all graphs in $\mathcal{P}(n, m)$. In this section, a detailed account of the existing results on P_n and $P_{n,m}$ will be given, with sketch-proofs of some of the major theorems.

We shall begin by looking at P_n . We will see results on the number of components in P_n that are isomorphic to a given H (Proposition 2), the number of special copies of H (called ‘appearances’) in P_n (Proposition 4), the probability that P_n is connected (Propositions 5 & 6), and the total number of components in P_n (also Propositions 5 & 6). In addition, we shall see (in Proposition 1) a precise asymptotic estimate for $|\mathcal{P}(n)|$, the number of planar graphs of order n .

We will then summarise results about $P_{n,m}$. Again, we shall see results concerning appearances (Proposition 10), connectivity (Proposition 7), and the total number of components (Propositions 11 & 12), as well as estimates for $|\mathcal{P}(n, m)|$ (Propositions 7 & 8).

We start with an estimate of how many planar graphs there are:

Proposition 1 ([11], **Theorem 1**)

$$|\mathcal{P}(n)| \sim g \cdot n^{-7/2} \gamma_l^n n!,$$

where $g \approx 0.4260938569 \cdot 10^{-5}$ and $\gamma_l \approx 27.2268777685$ are constants given by explicit analytic expressions.

Sketch of Proof Since a planar graph is a set of connected planar graphs, the e.g.f. (exponential generating function) for the class of planar graphs can

be expressed in terms of the e.g.f. for the class of connected planar graphs. Similarly, a connected planar graph may be decomposed into 2-connected components, and so this enables us to relate the e.g.f. for the class of connected planar graphs to the e.g.f. for the class of 2-connected planar graphs. This latter class has already been analysed in [2], via a further decomposition into 3-connected components (which have a unique embedding in the sphere [20]) and the use of known results on planar map enumeration. Hence, we are then able to use the e.g.f. equations (together with a large amount of algebraic manipulation) to obtain our asymptotic estimate for $|\mathcal{P}(n)|$. \square

Note that Proposition 1 implies that $\left(\frac{|\mathcal{P}(n)|}{n!}\right)^{1/n} \rightarrow \gamma_l$ as $n \rightarrow \infty$. Thus, we call γ_l the *labelled planar graph growth constant*.

The precise nature of Proposition 1 enables the structure of P_n to be investigated in detail. The main theorem is:

Proposition 2 (implicit in [16]) *Let H_1, \dots, H_r denote a fixed collection of pairwise non-isomorphic connected planar graphs, and let $X_n^{(i)}$ denote a random variable which counts the number of components isomorphic to H_i in P_n . Then $(X_n^{(1)}, \dots, X_n^{(r)}) \xrightarrow{d} (Z_1, \dots, Z_r)$, where $Z_i \in \text{Poi}\left(\left(|\text{Aut}(H_i)|\gamma_l^{|H_i|}\right)^{-1}\right)$ are independent.*

Sketch of Proof We construct graphs of order n with at least k_i components isomorphic to H_i , for all i , and find that we have built $|\mathcal{P}(n)|\mathbf{E}\left[\prod_{i \leq r} \left((X_n^{(i)})_{k_i}\right)\right]$ graphs in total, where $(X)_k = X(X-1)\cdots(X-k+1)$ denotes the k th factorial moment. Thus, we obtain a formula for $\mathbf{E}\left[\prod_{i \leq r} \left((X_n^{(i)})_{k_i}\right)\right]$, which turns out to simplify in terms of I_n , the expected number of isolated vertices in P_n . But $I_n = n\mathbf{P}[v_n \text{ is isolated in } P_n] = \frac{n|\mathcal{P}(n-1)|}{|\mathcal{P}(n)|} \rightarrow \gamma_l^{-1}$, by Theorem 1. A standard

result on the factorial moments of the Poisson distribution then completes the proof. \square

As a corollary to Theorem 2, we can see that the limiting probability for P_n having a component isomorphic to H is $1 - e^{-\frac{1}{(|\text{Aut}(H)|\gamma_t^{|H|})}}$.

It is easier to investigate the number of components isomorphic to H than the number of subgraphs, since components do not interfere with one another. However, subgraphs may be approached via the concept of ‘appearances’:

Definition 3 Let H be a graph on the vertex set $\{1, 2, \dots, h\}$, and let G be a graph on the vertex set $\{1, 2, \dots, n\}$, where $n > h$. Let $W \subset V(G)$ with $|W| = h$, and let the ‘root’ r_W denote the least element in W . We say that H **appears** at W in G if (a) the increasing bijection from $1, \dots, h$ to W gives an isomorphism between H and the induced subgraph $G[W]$ of G ; and (b) there is exactly one edge in G between W and the rest of G , and this edge is incident with the root r_W . We let $\mathbf{f}_H(\mathbf{G})$ denote the number of appearances of H in G , that is the number of sets $W \subset V(G)$ such that H appears at W in G .

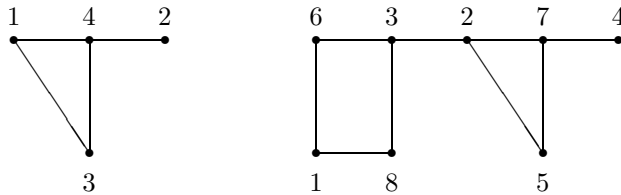

Figure 1: A graph H and an appearance of H .

The clean structure of an appearance makes it a suitable candidate for the generating function approach. Hence, we may obtain:

Proposition 4 ([11], **Theorem 4**) *Let H be a fixed connected planar graph on the vertex set $\{1, \dots, h\}$. Then $f_H(P_n)$ is asymptotically Normal, and the mean μ_n and variance σ_n^2 satisfy $\mu_n \sim \frac{n}{\gamma^h h!}$ and $\sigma_n^2 \sim \frac{n}{\gamma^h}$.*

Thus, a.a.s. P_n will contain at least linearly many copies of any given connected planar graph.

One further topic that has been looked at is that of connectivity and the number of components of P_n . Recall (from page 7) that $\mathcal{P}(n)$ is edge-addable. By a counting argument based on this, it is shown in [16] that we have:

Proposition 5 ([16], **2.1**) *The random number $\kappa(P_n)$ of components of P_n is stochastically dominated¹ by $1 + X$, where X has the Poisson distribution with mean 1. In particular,*

$$\mathbf{P}[P_n \text{ connected}] \geq 1/e \text{ and } \mathbf{E}[\kappa(P_n)] \leq 2.$$

These bounds hold for all n , but they may be significantly improved in the asymptotic case by using generating functions:

Proposition 6 ([11], **Theorem 6 & Corollary 1**) *Asymptotically, $\kappa(P_n) - 1$ is distributed like a Poisson law of parameter v , where $v \approx 0.0374393660$ is a constant given by an explicit analytic expression. In particular,*

$$\begin{aligned} \mathbf{P}[P_n \text{ connected}] &\rightarrow e^{-v} \approx 0.9632528217 \\ \text{and } \mathbf{E}[\kappa(P_n)] &\rightarrow 1 + v \approx 1.0374393660. \end{aligned}$$

¹We say the distribution (p_j) is *stochastically dominated* by the distribution (q_j) to mean that we have $\sum_{k \leq l} p_k \geq \sum_{k \leq l} q_k \quad \forall l$.

We now turn our attention to planar graphs with n vertices and m edges. Again, precise estimates for $|\mathcal{P}(n, m)|$ and $|\mathcal{P}_c(n, m)|$, the number of connected graphs in $\mathcal{P}(n, m)$, are given in [11]:

Proposition 7 ([11], implicit in Theorem 3) *Let $q \in (1, 3)$. Then*

$$|\mathcal{P}(n, \lfloor qn \rfloor)| \sim g(q) \cdot (u(q))^{qn - \lfloor qn \rfloor} \cdot n^{-4} \gamma(q)^n n!$$

$$\text{and } |\mathcal{P}_c(n, \lfloor qn \rfloor)| \sim g_c(q) \cdot (u(q))^{qn - \lfloor qn \rfloor} \cdot n^{-4} \gamma(q)^n n!,$$

where $g(q)$, $g_c(q)$, $u(q)$ and $\gamma(q) > 0$ are computable analytic functions.

Sketch of Proof We define the *bivariate exponential generating function* for a class of graphs, \mathcal{A} , to be $A(x, y) = \sum_{n, m \geq 0} \frac{a_{n, m}}{n!} x^n y^m$, where $a_{n, m}$ denotes the number of graphs in \mathcal{A} that have order n and size m . Hence, we may again use the decomposition of the proof of Proposition 1 to obtain the given asymptotic estimates. \square

Note this provides an expression for $\lim_{n \rightarrow \infty} \mathbf{P}[P_{n, \lfloor qn \rfloor} \text{ will be connected}]$. As it turns out, this limit is strictly between 0 and 1 for all $q \in (1, 3)$.

Analogously to with γ_l , we call $\gamma(q)$ the *growth function for q* . A fairly detailed picture of this function is given in [9] and [11]:

Proposition 8 ([9] and [11]) *For each $q \in [0, 3]$, there is a finite constant $\gamma(q) \geq 0$ such that, as $n \rightarrow \infty$, if $0 \leq q < 3$ then both $(|\mathcal{P}_c(n, \lfloor qn \rfloor)|/n!)^{1/n}$ and $(|\mathcal{P}(n, \lfloor qn \rfloor)|/n!)^{1/n}$ tend to $\gamma(q)$, and $(|\mathcal{P}(n, 3n - 6)|/n!)^{1/n}$ tends to $\gamma(3)$.*

The function $\gamma(q)$ is equal to 0 for $q \in [0, 1)$ and is then unimodal and uniformly continuous on $[1, 3]$, satisfying $\gamma(1) = e$, $\gamma(3) = 256/27$ and achieving a maximum value of γ_l at $q = \mathbf{E}(e(P_n)) \approx 2.2132652385$.

It is also shown in [9] that there is *uniform* convergence to $\gamma(q)$, in the following sense:

Proposition 9 ([9], Lemma 2.9) *Let $a \in (1, 3)$ and let $\eta > 0$. Then there exists n_0 such that for all $n \geq n_0$ and all $s \in [an, 3n - 6]$ we have*

$$\left| \left(\frac{|\mathcal{P}(n, s)|}{n!} \right)^{1/n} - \gamma \left(\frac{s}{n} \right) \right| < \eta.$$

No analogue to Proposition 2 has been given for $P_{n, \lfloor qn \rfloor}$. However, via counting arguments we do have a (less precise) version of Proposition 4:

Proposition 10 ([9], Theorem 3.1) *Let $q \in [1, 3)$ and let H be a fixed connected planar graph on the vertices $\{1, \dots, h\}$, with the extra condition that H is a tree if $q = 1$. Then there exists $\alpha = \alpha(H, q) > 0$ such that*

$$\mathbf{P} [f_H (P_{n, \lfloor qn \rfloor}) \leq \alpha n] = e^{-\Omega(n)}.$$

Thus, similarly to with P_n , we know that (a.a.s.) $P_{n, \lfloor qn \rfloor}$ will contain at least linearly many copies of any given connected planar graph, if $q > 1$.

We finish with two upper bounds for the number of components in $P_{n, m}$. The first deals with when $m = \lfloor qn \rfloor$ for $q \geq 1$, and the second with when m is slightly below n :

Proposition 11 ([9], Lemma 2.6) *Let $q \in [1, 3)$ and let $c > \ln \frac{\gamma}{\gamma(q)}$. Then*

$$\mathbf{P} [\kappa (P_{n, \lfloor qn \rfloor}) > \lceil cn / \ln n \rceil] = e^{-\Omega(n)}.$$

Proposition 12 ([8], Lemma 6.6) *Let $\beta > 0$ be fixed, and let $m = m(n) = n - (\beta + o(1))(n/\ln n)$. Let the constant $c > 0$ satisfy $c > \beta + \ln \gamma_l - 1$. Then*

$$\mathbf{P}[\kappa(P_{n,m}) > cn/\ln n] = e^{-\Omega(n)}.$$

It is the aim of this project to expand on the current state of knowledge of $P_{n,m}$.

4 Pendant Edges

In this section, we will do some groundwork by investigating the number of pendant edges in random planar graphs, which will be an important ingredient in later sections. The key result here will be Theorem 16, where we shall see that (a.a.s.) $P_{n,m}$ will have linearly many pendant edges, provided that $\frac{m}{n}$ is bounded away from both 0 and 3.

Clearly, it suffices to show that (a.a.s.) $P_{n,m}$ will have linearly many vertices of degree 1. We will first see (in Corollary 14) that the part of this result dealing with the case when $\frac{m}{n} \in [b, B]$, where $b > 1$ and $B < 3$, may be deduced fairly easily by analysing an important result from Section 3 concerning the concept of appearances. We shall then (in Lemma 15) also prove our result for smaller values of $\frac{m}{n}$, using counting arguments.

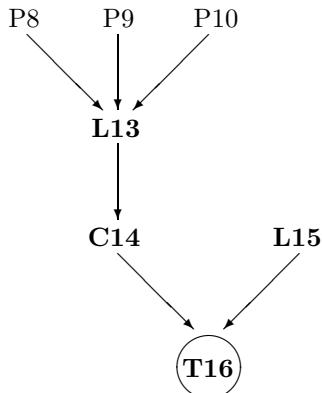

Figure 2: The structure of Section 4.

We start by recalling our result on appearances in $P_{n,[qn]}$:

Proposition 10 ([9], Theorem 3.1) *Let $q \in [1, 3)$ and let H be a fixed connected planar graph on the vertices $\{1, \dots, h\}$, with the extra condition that H is a tree if $q = 1$. Then there exists $\alpha = \alpha(H, q) > 0$ such that*

$$\mathbf{P} [f_H (P_{n,[qn]}) \leq \alpha n] = e^{-\Omega(n)}.$$

By analysing the proof of Proposition 10, we may in fact obtain the following useful improved version:

Lemma 13 *Let H be a fixed connected planar graph on the vertices $\{1, 2, \dots, h\}$, let $b > 1$ and $B < 3$ be given constants, and let $m = m(n) \in [bn, Bn] \forall n$. Then there exist constants $N(H, b, B)$ and $\alpha(H, b, B) > 0$ such that*

$$\mathbf{P}[f_H(P_{n,m}) \leq \alpha n] < e^{-\alpha n} \forall n \geq N.$$

Proof In the proof of Proposition 10 in [9], it is actually shown that $\exists N(H, q)$ and $\alpha(H, q) > 0$ such that $\mathbf{P}[f_H(P_{n, \lfloor qn \rfloor}) \leq \alpha n] < e^{-\alpha n} \forall n \geq N$. It will suffice to show that this holds uniformly, in the sense that $\exists N(H, b, B)$ and $\alpha(H, b, B) > 0$ such that, for all $q \in [b, B]$, we have $\mathbf{P}[f_H(P_{n, \lfloor qn \rfloor}) \leq \alpha n] < e^{-\alpha n} \forall n \geq N$.

The proof of Proposition 10 given in [9] implicitly provides us with the value $\alpha(H, q) = \frac{1}{9e^2(\gamma(q))^{h+x}(h+x+2)(h+x)!}$, where x is the least integer such that $\frac{x+2}{x+1} \leq q$ and $\frac{3x-5}{x+1} > q$. Recall from Proposition 8 that $\gamma(q) \in [e, \gamma_l] \forall q \in [1, 3]$. Thus, it follows that we may take α , independently of q , to be $\frac{1}{9e^2\gamma_l^{h+z}(h+z+2)(h+z)!}$, where z is the least integer such that $\frac{z+2}{z+1} \leq b$ and $\frac{3z-5}{z+1} > B$.

The value of $N(H, q)$ provided by the proof of Proposition 10 given in [9] depends on q only in that we must have

$$(1 - \epsilon)^n n! (\gamma(q))^n \leq |\mathcal{P}(n, \lfloor qn \rfloor)| \leq (1 + \epsilon)^n n! (\gamma(q))^n \forall n \geq N,$$

where ϵ is defined by the equation $(\frac{1}{9})^\alpha = 1 - 3\epsilon$. Thus, since our ϵ will only be a function of H, b and B , it suffices for us to prove $\exists N(b, B, \epsilon)$ such that, for all $q \in [b, B]$, we have

$$(1 - \epsilon)^n n! (\gamma(q))^n \leq |\mathcal{P}(n, \lfloor qn \rfloor)| \leq (1 + \epsilon)^n n! (\gamma(q))^n \forall n \geq N.$$

By uniform convergence (Proposition 9), we know that $\exists N_1(b, \epsilon)$ such that, for all $q \in [b, 3]$, we have $\left| \left(\frac{|\mathcal{P}(n, \lfloor qn \rfloor)|}{n!} \right)^{1/n} - \gamma \left(\frac{\lfloor qn \rfloor}{n} \right) \right| < \frac{\epsilon e}{2} \forall n \geq N_1$. But since $\gamma(q)$ is uniformly continuous on $[1, 3]$ (Proposition 8), we also know $\exists N_2(\epsilon)$ such

that, for all $q \in [1, 3]$, we have $\left| \gamma\left(\frac{\lfloor qn \rfloor}{n}\right) - \gamma(q) \right| < \frac{\epsilon\epsilon}{2} \forall n \geq N_2$. Thus, for all $q \in [b, 3)$, we have

$$\left| \left(\frac{|\mathcal{P}(n, \lfloor qn \rfloor)|}{n!} \right)^{1/n} - \gamma(q) \right| < \epsilon\epsilon \leq \epsilon\gamma(q) \forall n \geq N(b, B, \epsilon) = \max\{N_1, N_2\}.$$

Hence, we are done. \square

The first part of our pendant edges/vertices of degree 1 result now follows:

Corollary 14 *Let $b > 1$ and $B < 3$ be given constants and let $m = m(n) \in [bn, Bn] \forall n$. Then there exist constants $N(b, B)$ and $\beta(b, B) > 0$ such that*

$$\mathbf{P}[P_{n,m} \text{ will have } < \beta n \text{ vertices of degree 1}] < e^{-\beta n} \forall n \geq N.$$

Proof This follows from Lemma 13, with H as an isolated vertex. \square

We are left with proving the result for the case when $\frac{m}{n}$ is small:

Lemma 15 *Let $c > 0$ and $\delta < 1/8$ be given constants and let $m = m(n) \in [cn, (1 + \delta)n]$ for all large n . Then there exists a constant $\beta(c, \delta) > 0$ such that*

$$\mathbf{P}[P_{n,m} \text{ will have } < \beta n \text{ vertices of degree 1}] < e^{-\beta n} \text{ for all large } n.$$

Sketch of Proof We suppose, hoping for a contradiction, that there will be a decent proportion of graphs in $\mathcal{P}(n, m)$ with only ‘a few’ vertices of degree 1 and we consider separately the cases when (a) there are also ‘many’ isolated vertices and (b) there are not ‘many’ isolated vertices.

For case (a), we construct new graphs in $\mathcal{P}(n, m)$ by turning some of the isolated vertices into vertices of degree 1 (and deleting some edges elsewhere) and find that we can construct so many graphs that we obtain our desired contradiction.

For case (b), we note that we must have ‘lots’ of vertices of degree 2. In fact, we must have ‘lots’ of vertices of degree 2 that are adjacent only to other vertices of degree 2. Such a vertex must belong either to a component that is a triangle or to a larger component. In both cases, we construct new graphs by turning the chosen vertex into a vertex of degree 1 (and inserting an edge elsewhere). Again, we find that we can construct so many graphs that we obtain our desired contradiction.

In all cases of the proof, the key idea is to construct our graphs in such a way that there is not much double-counting. This is helped by our assumption that we started with only ‘a few’ vertices of degree 1.

Full Proof Choose $\beta > 0$ and suppose \exists arbitrarily large n such that

$$\mathbf{P}[P_{n,m} \text{ will have } < \beta n \text{ vertices of degree 1}] \geq e^{-\beta n}.$$

Consider one of these n and let \mathcal{G}_n denote the set of graphs in $\mathcal{P}(n, m)$ with $< \beta n$ vertices of degree 1. Thus, $|\mathcal{G}_n| \geq e^{-\beta n} |\mathcal{P}(n, m)|$.

Choose $\epsilon > 0$, let \mathcal{H}_n denote the set of graphs in $\mathcal{P}(n, m)$ with $< \beta n$ vertices of degree 1 and with $> \epsilon n$ vertices of degree 0, and let \mathcal{J}_n denote the set of graphs in $\mathcal{P}(n, m)$ with $< \beta n$ vertices of degree 1 and with $\leq \epsilon n$ vertices of degree 0. Then $|\mathcal{H}_n| + |\mathcal{J}_n| = |\mathcal{G}_n| \geq e^{-\beta n} |\mathcal{P}(n, m)|$. Thus, either $|\mathcal{H}_n| \geq \frac{e^{-\beta n}}{2} |\mathcal{P}(n, m)|$ or $|\mathcal{J}_n| \geq \frac{e^{-\beta n}}{2} |\mathcal{P}(n, m)|$.

In a moment, we shall split our proof into two cases based on the observation of the previous sentence. First, though, we should just note that there will be several places later where we shall require that our choices of β , ϵ and n satisfy various inequalities. Formally, this can be done by assuming that we first chose ϵ to be ‘sufficiently’ small (depending on c and δ), that we then chose β to be ‘sufficiently’ small (depending on c , δ and ϵ), and that we finally chose n to be ‘sufficiently’ large (depending on c , δ , ϵ and β).

Case(a)

Suppose $|\mathcal{H}_n| \geq \frac{e^{-\beta n}}{2} |\mathcal{P}(n, m)|$ and consider a graph $G \in \mathcal{H}_n$. Using G , we shall construct a graph (in $\mathcal{P}(n, m)$) with $\geq \beta n$ vertices of degree 1 as follows:

Stage 1:

Choose $\lceil \beta n \rceil$ isolated vertices (we have $\binom{d_0}{\lceil \beta n \rceil} > \binom{\epsilon n}{\lceil \beta n \rceil}$ choices ² for these, where d_0 denotes the number of vertices of degree 0). Let us denote the chosen vertices, in order of their labels, as $v_1, v_2, \dots, v_{\lceil \beta n \rceil}$, and let $i = 1$.

Stage 2:

Choose a vertex u_i that was non-isolated in G and that was also not incident to any of the edges e_1, e_2, \dots, e_{i-1} defined in previous iterations (we have at least $n - d_0 - 2(i - 1)$ choices, and we may assume that $\beta > 0$ is sufficiently small that this is positive $\forall i \leq \lceil \beta n \rceil$, since by planarity $n - d_0 > \frac{m}{3} \geq \frac{\epsilon n}{3}$); delete an edge e_i incident to u_i ; and join u_i to v_i (see Figure 3).

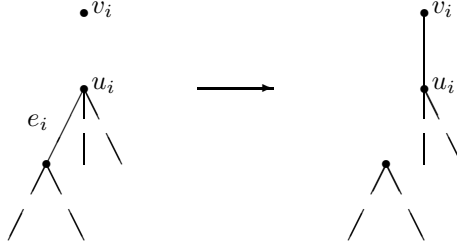

Figure 3: Constructing a vertex of degree 1 in Stage 2.

Stage 3:

If $i = \lceil \beta n \rceil$, then we terminate the algorithm. Otherwise, we increase i by 1 and return to Stage 2.

²We use the definition $\binom{\epsilon n}{\lceil \beta n \rceil} := \frac{\epsilon n \cdot (\epsilon n - 1) \cdots (\epsilon n - \lceil \beta n \rceil + 1)}{\lceil \beta n \rceil!}$ if ϵn is non-integral, as is standard.

By considering all possible initial graphs $G \in \mathcal{H}_n$, it is clear to see that the number of ways to build a graph with $\geq \beta n$ vertices of degree 1 is at least $\binom{\epsilon n}{\lceil \beta n \rceil} \left(\prod_{i=1}^{\lceil \beta n \rceil - 1} (n - d_0 - 2(i-1)) \right) |\mathcal{H}_n| \geq \binom{\epsilon n}{\lceil \beta n \rceil} \left(\frac{m}{3} - 2\lceil \beta n \rceil \right)^{\lceil \beta n \rceil} \frac{e^{-\beta n}}{2} |\mathcal{P}(n, m)|$.

We will now consider the amount of double-counting, i.e. how many times each new graph will be constructed. We know that each new graph will contain at most $3\lceil \beta n \rceil$ vertices of degree 1 (since there were $< \beta n$ to begin with; we have deliberately added $\lceil \beta n \rceil$; and we may have created at most one extra one each time we deleted an edge), so we will have at most $\binom{3\lceil \beta n \rceil}{\lceil \beta n \rceil}$ possibilities for which were our chosen (originally isolated) vertices $v_1, v_2, \dots, v_{\lceil \beta n \rceil}$. We will then have $< (n - \lceil \beta n \rceil)^{\lceil \beta n \rceil}$ possibilities for where the edges attached to these vertices were originally. Thus, we will build each graph at most $\binom{3\lceil \beta n \rceil}{\lceil \beta n \rceil} (n - \lceil \beta n \rceil)^{\lceil \beta n \rceil}$ times.

Therefore, the number of distinct graphs in $\mathcal{P}(n, m)$ with $\geq \beta n$ vertices of degree 1 is at least

$$\begin{aligned}
& \frac{\binom{\epsilon n}{\lceil \beta n \rceil} \left(\frac{m}{3} - 2\lceil \beta n \rceil \right)^{\lceil \beta n \rceil} \frac{e^{-\beta n}}{2} |\mathcal{P}(n, m)|}{\binom{3\lceil \beta n \rceil}{\lceil \beta n \rceil} (n - \lceil \beta n \rceil)^{\lceil \beta n \rceil}} \\
& \geq \left(\frac{\epsilon n}{3\lceil \beta n \rceil} \right)^{\lceil \beta n \rceil} \left(\frac{\frac{m}{3} - 2\lceil \beta n \rceil}{n - \lceil \beta n \rceil} \right)^{\lceil \beta n \rceil} \frac{e^{-\beta n}}{2} |\mathcal{P}(n, m)| \\
& \quad \text{since } \frac{\binom{x}{y}}{\binom{z}{y}} = \frac{x(x-1)\cdots(x-y+1)}{z(z-1)\cdots(z-y+1)} \geq \left(\frac{x}{z} \right)^y \text{ if } z \leq x \\
& \quad \text{and here we may assume } 3\lceil \beta n \rceil \leq \epsilon n \\
& > \left(\left(\frac{\epsilon}{4\beta} \right) \left(\frac{\frac{c}{3} - 3\beta}{1 - \beta} \right) \right)^{\lceil \beta n \rceil} \frac{e^{-\beta n}}{2} |\mathcal{P}(n, m)| \quad \text{for sufficiently large } n \\
& > 3^{\lceil \beta n \rceil} \frac{e^{-\beta n}}{2} |\mathcal{P}(n, m)| \quad \text{for sufficiently small } \beta, \\
& \quad \text{since } \left(\frac{\epsilon}{4\beta} \right) \left(\frac{\frac{c}{3} - 3\beta}{1 - \beta} \right) \rightarrow \infty \text{ as } \beta \rightarrow 0 \\
& > |\mathcal{P}(n, m)| \quad \text{for sufficiently large } n \text{ (since } 3 > e),
\end{aligned}$$

which is a contradiction.

Case(b)

Suppose instead that $|\mathcal{J}_n| \geq \frac{e^{-\beta n}}{2} |\mathcal{P}(n, m)|$ and consider a graph $G \in \mathcal{J}_n$. We shall start by showing the intuitive fact that G must contain many vertices of degree 2.

Let d_i denote the number of vertices of degree i in G . Then

$$\begin{aligned}
 d_1 + 2d_2 + 3 \sum_{i \geq 3} d_i &\leq \sum_{i \geq 1} id_i \\
 &= 2m \\
 &\leq 2n + 2\delta n \\
 &= 2d_0 + 2d_1 + 2d_2 + 2 \sum_{i \geq 3} d_i + 2\delta n. \tag{1}
 \end{aligned}$$

Thus,

$$\begin{aligned}
 \sum_{i \geq 3} d_i &\leq 2d_0 + d_1 + 2\delta n \\
 &< 2\epsilon n + \beta n + 2\delta n \tag{2}
 \end{aligned}$$

and so

$$\begin{aligned}
 d_2 &= n - \sum_{i \geq 3} d_i - d_1 - d_0 \\
 &> n - 2\epsilon n - \beta n - 2\delta n - \beta n - \epsilon n \\
 &= (1 - 3\epsilon - 2\beta - 2\delta)n.
 \end{aligned}$$

We shall now see that, in fact, G must contain many vertices of degree 2 that are adjacent only to other vertices of degree 2. Recall from (1) that we have $\sum_{i \geq 1} id_i \leq 2d_0 + 2d_1 + 2d_2 + 2 \sum_{i \geq 3} d_i + 2\delta n$. Thus,

$$\begin{aligned}
 \sum_{i \geq 3} id_i &\leq 2d_0 + d_1 + 2 \sum_{i \geq 3} d_i + 2\delta n \\
 &< 2\epsilon n + \beta n + 2(2\epsilon n + \beta n + 2\delta n) + 2\delta n \quad \text{by (2)} \\
 &= (6\epsilon + 3\beta + 6\delta)n.
 \end{aligned}$$

Therefore, at most $(6\epsilon + 3\beta + 6\delta)n$ of the degree 2 vertices will be adjacent to a vertex of degree ≥ 3 . Similarly, at most $d_1 < \beta n$ of the degree 2 vertices will

be adjacent to a vertex of degree 1. Hence, at least $d_2 - \beta n - (6\epsilon + 3\beta + 6\delta)n > (1 - 3\epsilon - 2\beta - 2\delta)n - \beta n - (6\epsilon + 3\beta + 6\delta)n = (1 - 9\epsilon - 6\beta - 8\delta)n$ of the degree 2 vertices will be adjacent only to other degree 2 vertices.

Let A denote the set of vertices of degree 2 that are adjacent only to other degree 2 vertices. Using G , we shall construct a graph (in $\mathcal{P}(n, m)$) with $\geq \beta n$ vertices of degree 1 by the following algorithm:

Stage 1:

Let $B_0 = \emptyset$ and let $i = 1$.

Stage 2:

Choose a vertex, v_i , in $A - B_{i-1}$ (it will become clear that v_i will still be a degree 2 vertex that is adjacent only to other degree 2 vertices). Let the vertices adjacent to v_i be denoted by u_i and w_i .

Stage 3a (If $u_i w_i \in E(G)$):

If $u_i w_i$ is an edge in G (in which case $\{u_i, v_i, w_i\}$ form a component that is a triangle, since $d(u_i) = d(v_i) = d(w_i) = 2$), then delete the edge $v_i w_i$ and join w_i to a vertex $x_i \notin (B_{i-1} \cup \{u_i, v_i\})$ (see Figure 4). This is possible if $i \leq \lceil \beta n \rceil$, since it will become clear that $|B_{i-1}| + 2 \leq 6(i-1) + 2 < 6(\lceil \beta n \rceil - 1) + 2 < n$ if $\beta < \frac{1}{6}$. Planarity will be maintained, since w_i and x_i were in separate components.

If $d(x_i) \neq 2$, let $B_i = B_{i-1} \cup \{u_i, v_i, w_i\}$. If $d(x_i) = 2$, let the vertices adjacent to x_i be denoted by y_i and z_i and let $B_i = B_{i-1} \cup \{u_i, v_i, w_i, x_i, y_i, z_i\}$. Thus, as already mentioned, it is clear that $|B_i|$ increases by at most 6 in each iteration and that $A - B_i$ still just contains degree 2 vertices that are adjacent only to other degree 2 vertices.

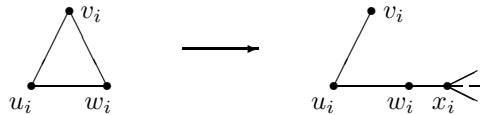

Figure 4: Constructing a vertex of degree 1 in Stage 3a.

Stage 3b (If $u_i w_i \notin E(G)$):

If $u_i w_i$ is not an edge in G , then insert an edge between u_i and w_i (this can be done arbitrarily close to the edges $u_i v_i$ and $v_i w_i$, so planarity is maintained). Delete the edge $v_i w_i$. Let x_i denote the neighbour of u_i that is not v_i or w_i and let $B_i = B_{i-1} \cup \{u_i, v_i, w_i, x_i\}$.

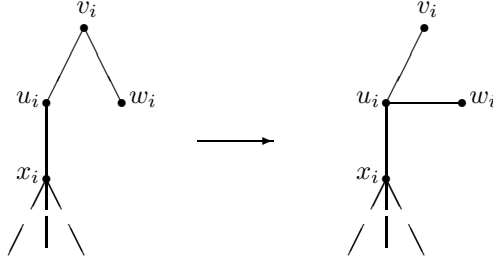

Figure 5: Constructing a vertex of degree 1 in Stage 3b.

Stage 4:

If $i = \lceil \beta n \rceil$, then we terminate the algorithm. Otherwise, we increase i by 1 and return to Stage 2.

Note that we have $d(v_i) = 1 \forall i$ in our new graph. At each iteration, we had $|A - B_{i-1}| \geq (1 - 9\epsilon - 6\beta - 8\delta)n - 6\beta n = (1 - 9\epsilon - 12\beta - 8\delta)n$ choices for v_i . Thus, by considering all possible initial graphs $G \in \mathcal{J}_n$, we have at least $(1 - 9\epsilon - 12\beta - 8\delta)^{\lceil \beta n \rceil} n^{\lceil \beta n \rceil} \frac{e^{-\beta n}}{2} |\mathcal{P}(n, m)|$ ways to construct a graph with $\geq \beta n$ vertices of degree 1, and so it remains only to consider the amount of double-counting.

Each new graph will contain at most $3\lceil \beta n \rceil$ vertices of degree 1 (since there were $< \lceil \beta n \rceil$ to begin with; we have deliberately created $\lceil \beta n \rceil$; and we may have created at most one extra one each time we used Stage 3a, if x_i was an isolated vertex). Thus, we have $\leq 3\lceil \beta n \rceil$ possibilities for which vertex was $v_{\lceil \beta n \rceil}$, which will now be adjacent only to $u_{\lceil \beta n \rceil}$.

If $u_{\lceil \beta n \rceil}$ now has degree 2, then we must have used Stage 3a in the final iteration and hence $w_{\lceil \beta n \rceil}$ is the other neighbour of $u_{\lceil \beta n \rceil}$ and $x_{\lceil \beta n \rceil}$ is the

remaining neighbour of $w_{\lceil \beta n \rceil}$. Thus, we know how the graph changed during the final iteration.

If $u_{\lceil \beta n \rceil}$ now has degree 3, then we must have used Stage 3b in the final iteration and hence we have two possibilities for which vertex was $w_{\lceil \beta n \rceil}$ (since it must be one of the other neighbours of $u_{\lceil \beta n \rceil}$ in the new graph). Thus, we have two possibilities for how the graph changed during the final iteration.

Therefore, we have at most $6\lceil \beta n \rceil$ possibilities in total for which vertex was $v_{\lceil \beta n \rceil}$ and how the graph looked before the final iteration. Repeating this argument, we find that we have at most $(6\lceil \beta n \rceil)^{\lceil \beta n \rceil}$ possibilities for what the original graph was and which vertices were $v_1, v_2, \dots, v_{\lceil \beta n \rceil}$ (in order). Hence, we have built each of our new graphs at most $(6\lceil \beta n \rceil)^{\lceil \beta n \rceil}$ times and, therefore, the number of graphs in $\mathcal{P}(n, m)$ with $\geq \beta n$ vertices of degree 1 is at least $\left(\frac{(1-9\epsilon-12\beta-8\delta)n}{6\lceil \beta n \rceil}\right)^{\lceil \beta n \rceil} \frac{e^{-\beta n}}{2} |\mathcal{P}(n, m)|$.

Recall that $\delta < 1/8$. Thus, since we were free to choose ϵ and β arbitrarily small, we may assume that $\left(\frac{1-9\epsilon-12\beta-8\delta}{6\beta}\right) > 3$. Therefore, for sufficiently large n , we have $\left(\frac{(1-9\epsilon-12\beta-8\delta)n}{6\lceil \beta n \rceil}\right)^{\lceil \beta n \rceil} \frac{e^{-\beta n}}{2} |\mathcal{P}(n, m)| > 3^{\lceil \beta n \rceil} \frac{e^{-\beta n}}{2} |\mathcal{P}(n, m)| > |\mathcal{P}(n, m)|$, which provides us with a contradiction.

Thus, we get a contradiction whether $\frac{|\mathcal{H}_n|}{|\mathcal{P}(n, m)|} \geq \frac{e^{-\beta n}}{2}$ or $\frac{|\mathcal{J}_n|}{|\mathcal{P}(n, m)|} \geq \frac{e^{-\beta n}}{2}$. \square

By combining Corollary 14 and Lemma 15, we obtain our main result of this section:

Theorem 16 *Let $b > 0$ and $B < 3$ be given constants and let $m(n) \in [bn, Bn]$ for all large n . Then there exists a constant $\alpha(b, B) > 0$ such that*

$$\mathbf{P}[P_{n,m} \text{ will have } < \alpha n \text{ pendant edges}] < e^{-\alpha n} \text{ for all large } n.$$

Proof The number of vertices of degree 1 is at most twice the number of edges incident to a vertex of degree 1. \square

5 Addable Edges

In this section, we will continue to lay the groundwork for later counting arguments. In future sections, we shall often wish to choose an edge to insert into a graph without violating planarity, and so our focus here will be to examine how many choices we have.

Definition 17 *Given a planar graph G , we call a non-edge e **addable** in G if the graph $G + e$ obtained by adding e as an edge is still planar. We let $\mathbf{add}(G)$ denote the set of addable non-edges of G (note that the graph obtained by adding all the edges in $\mathbf{add}(G)$ may well not be planar) and we let $\mathbf{add}(n, m)$ denote the minimum value of $|\mathbf{add}(G)|$ over all graphs $G \in \mathcal{P}(n, m)$.*

In later sections, we will require bounds (both lower and upper) on $\mathbf{add}(n, m)$ for the case when $m \leq (1 + o(1))n$, and so that is our main purpose here. However, as an interesting aside, we shall also provide results for larger values of m (recall that we use ‘Proposition’ for such asides). Hence, we will in fact build up a fairly complete description, showing that there are four main results:

$$\mathbf{add}(n, m(n)) = \begin{cases} \Theta(dn) & \text{if } d = n - m > 0 \text{ is such that } d = \Omega(n^{1/2}) \\ & \text{(Theorems 19 \& 28)} \\ \Theta(n^{3/2}) & \text{if } |m - n| = O(n^{1/2}) \text{ (Theorems 24 \& 31)} \\ \Theta\left(\frac{n^2}{d}\right) & \text{if } d = m - n > 0 \text{ is such that} \\ & d = \Omega(n^{1/2}) \text{ and } \limsup \frac{d}{n} < 2 \text{ (Thms. 25 \& 32)} \\ \Theta(3n - m) & \text{if } m = \Omega(n) \text{ (Props. 27 \& 34 and Thm. 32)} \end{cases}$$

Table 1: The four main addability results.

The bounds of Table 1 will be sufficient for the rest of this thesis. However, as the topic of addable edges is quite interesting, we shall flesh out our account by also giving more detailed results for seven special cases:

$$\text{add}(n, m(n)) = \left\{ \begin{array}{ll} (1 + o(1)) \frac{(1-A)(1+A)}{2} n^2 & \text{if } m = An + o(n), \text{ for } A < 1 \\ & \text{(Propositions 21 \& 29)} \\ (1 + o(1)) dn & \text{if } d = n - m > 0 \text{ is such that} \\ & d = \omega(n^{1/2}) \text{ and } o(n) \\ & \text{(Propositions 20 \& 30)} \\ (1 + o(1))(2 - \lambda)n^{3/2} & \text{if } m = n + \lambda n^{1/2} + o(n^{1/2}), \\ & \text{for } \lambda \leq 1 \quad \text{(Thms. 24 \& 31)} \\ (1 + o(1)) \frac{1}{\lambda} n^{3/2} & \text{if } m = n + \lambda n^{1/2} + o(n^{1/2}), \\ & \text{for } \lambda \geq 1 \quad \text{(Thms. 24 \& 31)} \\ \frac{n^2}{d} + O(n) & \text{if } d = m - n > 0 \text{ is such that} \\ & d = \omega(n^{1/2}) \text{ and } o(n) \\ & \text{(Propositions 26 \& 33)} \\ \mu(c)n + O(1) \text{ (for known } \mu) & \text{if } m = cn + O(1), \text{ for } c \in (1, 3] \\ & \text{(Proposition 22([7], 1.2))} \\ \lceil \frac{3}{2}(3n - 6 - m) \rceil & \text{if } n \geq 6 \text{ and } m \geq 2n - 3 \\ & \text{(Propositions 27 \& 34)} \end{array} \right.$$

Table 2: Seven secondary addability results.

The results of Table 1, together with the regions detailed in Table 2, are illustrated pictorially in Figure 6:

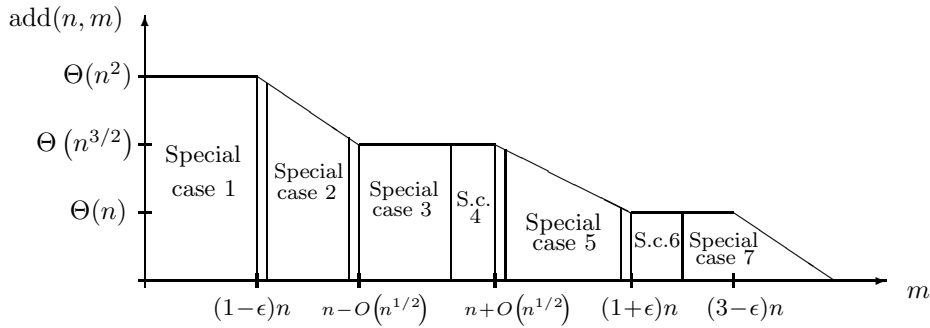

Figure 6: Summary of results on $\text{add}(n, m)$.

We shall prove the lower bounds first. We will start (in Lemma 18) with a simple argument that gives us a useful result for when $m < n$, and from this we shall derive Theorem 19 and Propositions 20–21. We will then prove the remaining lower bounds (in Theorem 24 to Proposition 27) by using some very helpful detailed results from [7].

In the second half of this section (Theorem 28 to Proposition 34) we will prove the upper bounds, by copying a construction used in [7].

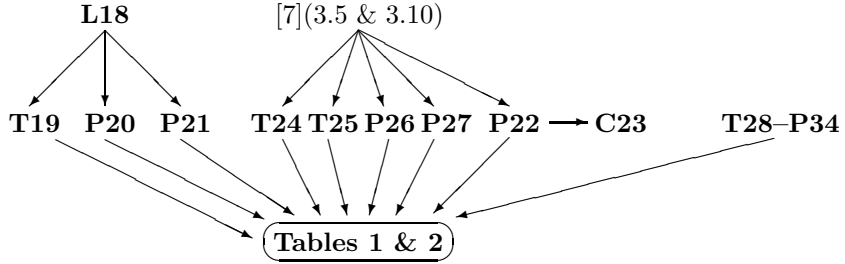

Figure 7: The structure of Section 5.

As mentioned, we shall now start with lower bounds and, in particular, with a result which will be useful for when $m < n$:

Lemma 18 *Let $m = m(n)$. Then*

$$\text{add}(n, m) \geq \frac{(n + m)(n - m - 1)}{2}.$$

Proof Let $G \in \mathcal{P}(n, m)$. Clearly, G must have at least $n - m$ components, and we know that any non-edge between two vertices in different components is addable.

Note that the number of possible edges between disjoint sets X and Y is $|X||Y|$ and that if $|X| \leq |Y|$ then $|X||Y| > (|X| - 1)(|Y| + 1)$. Hence, it follows

that the number of addable edges between vertices in different components is minimized when we have $\kappa(G) - 1$ isolated vertices and one component of $n - \kappa(G) + 1$ vertices. Thus,

$$\begin{aligned} |\text{add}(G)| &\geq \binom{\kappa(G)-1}{2} + (\kappa(G) - 1)(n - \kappa(G) + 1) \\ &= \frac{(\kappa(G) - 1)(\kappa(G) - 2)}{2} + (\kappa(G) - 1)(n - \kappa(G) + 1) \\ &= (\kappa(G) - 1) \left(n - \frac{\kappa(G)}{2} \right). \end{aligned}$$

By differentiation, it can be seen that taking $\kappa(G)$ to be $n - m$ minimizes $(\kappa(G) - 1) \left(n - \frac{\kappa(G)}{2} \right)$ in the region $\kappa(G) \in [n - m, n]$. Thus, $|\text{add}(G)| \geq (n - m - 1) \left(n - \frac{n-m}{2} \right) = \frac{(n+m)(n-m-1)}{2}$. \square

Lemma 18 provides us with the lower bound for the first of our four main results from Table 1:

Theorem 19 *Let $d = d(n) > 0$ be such that $d = \Omega(n^{1/2})$. Then*

$$\text{add}(n, n - d) = \Omega(dn).$$

(Note that we could improve the $d = \Omega(n^{1/2})$ condition to just $d > 1$, directly from Lemma 18, or even beyond if we altered the proof of the lemma slightly, but we won't bother with this here as we shall see a stronger result for when $|m - n| = O(n^{1/2})$ in Theorem 24).

Similarly, Lemma 18 also provides us with the lower bounds for the first two of our six secondary results from Table 2:

Proposition 20 *Let $d = d(n) > 0$ be such that $d = \Omega(n^{1/2})$ and $d = o(n)$.*

Then

$$\text{add}(n, n - d) \geq (1 + o(1))dn.$$

Proposition 21 *Let $A < 1$ be a fixed constant and let $m(n)$ be such that $m \leq An$ for all large n . Then*

$$\text{add}(n, m) \geq (1 + o(1)) \frac{(1 - A)(1 + A)}{2} n^2.$$

Proof Note that $\text{add}(n, m)$ is clearly monotonic in m , so it suffices to consider the case when $m = An$. \square

The remainder of this section relies heavily on the work carried out in [7], in which the sixth of our secondary results was given. Hence, we will state that result now, together with some helpful details from the proof:

Proposition 22 ([7], 1.2) *Let $c \in (1, 3]$ and suppose that $m = m(n) = cn + O(1)$ as $n \rightarrow \infty$. Then*

$$\text{add}(n, m) = \mu(c)n + O(1),$$

where $\mu(c)$, given explicitly in [7], satisfies $\mu(3) = 0$, $\mu(c) > 0 \forall c < 3$ and $\mu(c) \rightarrow \infty$ as $c \rightarrow 1$.

Sketch of Proof It is shown that there must exist a graph attaining $\text{add}(n, m)$ that belongs to a particular family for which it happens to be relatively simple to obtain a lower bound for add . To be more precise, it is shown in Lemmas 3.5 and 3.10 of [7] that, if $n \geq 6$ and $8 \leq m \leq 3n - 6$, there is a graph $G \in \mathcal{P}(n, m)$ with

(i) $i(= i_n)$ isolated vertices

and (ii) a plane embedding with $f_k(= f_{k,n})$ faces of size k

such that

(iii) G is connected apart from the isolated vertices

and (iv) $\text{add}(n, m) = |\text{add}(G)| \geq \frac{1}{4} \sum_{k=3}^n (k-3)(k+2)f_k + i(n - \frac{i+1}{2})$.

A lower bound for $\text{add}(n, m)$ is then obtained using (iv), while a close upper bound is demonstrated by constructing a subdivided triangulation with few addable edges (following an idea from [15]). \square

A corollary which will be very useful in later sections is:

Corollary 23 *Let $m = m(n) \leq (1 + o(1))n$. Then*

$$\text{add}(n, m) = \omega(n).$$

Proof This follows from the monotonicity of $\text{add}(n, m)$. \square

We will now see how to modify the proof of Proposition 22 to obtain the lower bound for the second of our four main results, which improves on Lemma 18 for the case when $n - m$ is small. Simultaneously, we will be provided with the lower bounds for the third and fourth of our secondary results. The idea of the proof is due to Colin McDiarmid.

Theorem 24 *Let λ be a (not necessarily positive) fixed constant and let $m = m(n)$ be such that $m \leq n + \lambda n^{1/2} + o(n^{1/2})$. Then*

$$\text{add}(n, m) \geq (1 + o(1)) \begin{cases} (2 - \lambda) n^{3/2} & \text{if } \lambda \leq 1 \\ \frac{1}{\lambda} n^{3/2} & \text{if } \lambda \geq 1 \end{cases}$$

Proof Note that given any $\alpha > \lambda$, we have $\text{add}(n, m) \geq \text{add}(n, n + \lfloor \alpha n^{1/2} \rfloor)$ for all sufficiently large n , by the monotonicity of add . Thus, since this holds

with α arbitrarily close to λ and since the function $f(\alpha) = \begin{cases} (2 - \alpha) & \text{if } \alpha \leq 1 \\ \frac{1}{\alpha} & \text{if } \alpha \geq 1 \end{cases}$ is continuous in α , it suffices to show $\text{add}(n, n + \lfloor \alpha n^{1/2} \rfloor) \geq (1 + o(1))f(\alpha)n^{3/2}$. Hence, without loss of generality, we may assume that $m = n + \lfloor \lambda n^{1/2} \rfloor \forall n$ (in fact, for this case we shall be able to show $\text{add}(n, m) \geq f(\lambda)n^{3/2} + O(n)$).

Clearly, it suffices for us to consider the case when n is large enough that $n \geq 6$ and $8 \leq n + \lfloor \lambda n^{1/2} \rfloor \leq 3n - 6$. Thus, using the proof of Proposition 22, we know there is a graph $G \in \mathcal{P}(n, n + \lfloor \lambda n^{1/2} \rfloor)$ with

(i) $i (= i_n)$ isolated vertices

and (ii) a plane embedding with $f_k (= f_{k,n})$ faces of size k

such that

(iii) G is connected apart from the isolated vertices

and (iv) $\text{add}(n, n + \lfloor \lambda n^{1/2} \rfloor) = |\text{add}(G)| \geq \frac{1}{4} \sum_{k=3}^n (k-3)(k+2)f_k + i(n - \frac{i+1}{2})$.

Note that, by (ii), we have

$$\sum_{k=3}^n k f_k = 2(n + \lfloor \lambda n^{1/2} \rfloor), \quad (3)$$

and, by (iii) and Euler's formula, we have

$$\sum_{k=3}^n f_k = \lfloor \lambda n^{1/2} \rfloor + i + 2. \quad (4)$$

Using (iv) and the fact that $i \leq n$, we have $\text{add}(n, n + \lfloor \lambda n^{1/2} \rfloor) \geq i(n - \frac{i+1}{2}) \geq i(\frac{n-1}{2}) > \frac{in}{3}$. Let $x = \max\{6, 6 - 3\lambda\}$. Then, for those values of n for which $i = i_n \geq xn^{1/2}$, we have

$$\begin{aligned} \text{add}(n, n + \lfloor \lambda n^{1/2} \rfloor) &> \frac{xn^{3/2}}{3} \\ &= \max\{2, 2 - \lambda\}n^{3/2} \\ &\geq f(\lambda)n^{3/2}. \end{aligned} \quad (5)$$

We shall now also obtain a lower bound on $\text{add}(n, n + \lambda n^{1/2})$ for those values of n for which $i = i_n < xn^{1/2}$. By (iv), it suffices to minimize $h = h(i, k_3, k_4, \dots, k_n) = \frac{1}{4} \sum_{k=3}^n (k-3)(k+2)f_k + i(n - \frac{i+1}{2})$ over all remaining choices of non-negative integers i, k_3, k_4, \dots, k_n , subject to constraints (3) and (4).

Note that the formula $(k-3)(k+2)$ yields a convex function of k . Thus, as observed in the proof of Theorem 1.2 of [7], the minimum value of h under constraints (3) and (4) is attained with either a single non-zero value f_l or with two ‘adjacent’ non-zero values f_l and f_{l+1} . Thus (with $f_{l+1} = 0$ if appropriate), by (3) we have $2(n + \lfloor \lambda n^{1/2} \rfloor) = lf_l + (l+1)f_{l+1} < (l+1)(f_l + f_{l+1}) = (l+1)(\lfloor \lambda n^{1/2} \rfloor + i + 2)$ by (4). Hence, $l-3 > \frac{2(n + \lfloor \lambda n^{1/2} \rfloor)}{\lfloor \lambda n^{1/2} \rfloor + i + 2} - 4$. Therefore,

$$\begin{aligned}
& \text{add}(n, n + \lfloor \lambda n^{1/2} \rfloor) \\
& \geq \frac{1}{4} ((l-3)(l+2)f_l + (l-2)(l+3)f_{l+1}) + i \left(n - \frac{i+1}{2} \right) \\
& > \left(\frac{(n + \lfloor \lambda n^{1/2} \rfloor)}{2(\lfloor \lambda n^{1/2} \rfloor + i + 2)} - 1 \right) ((l+2)f_l + (l+3)f_{l+1}) + i \left(n - \frac{i+1}{2} \right) \\
& > \left(\frac{(n + \lfloor \lambda n^{1/2} \rfloor)}{2(\lfloor \lambda n^{1/2} \rfloor + i + 2)} - 1 \right) (lf_l + (l+1)f_{l+1}) + i \left(n - \frac{i+1}{2} \right) \\
& \stackrel{\text{by (3)}}{>} \frac{(n + \lfloor \lambda n^{1/2} \rfloor)^2}{(\lfloor \lambda n^{1/2} \rfloor + i + 2)} - 2(n + \lfloor \lambda n^{1/2} \rfloor) + i \left(n - \frac{i+1}{2} \right) \tag{6} \\
& = \frac{n^2}{\lambda n^{1/2} + i + 2} + in + O(n) \quad \text{if } i < xn^{1/2} \\
& \geq \begin{cases} (2-\lambda)n^{3/2} + O(n) & \text{if } \lambda < 1 \\ \frac{1}{\lambda}n^{3/2} + O(n) & \text{if } \lambda \geq 1, \end{cases} \\
& \text{since, by differentiation, } i = \max\{0, (1-\lambda)n^{1/2} - 2\} \\
& \text{minimizes } \frac{n^2}{\lambda n^{1/2} + i + 2} + in \text{ in the region } i \geq 0.
\end{aligned}$$

Thus, regardless of whether or not $i_n \geq xn^{1/2}$, we have

$$\text{add}(n, n + \lfloor \lambda n^{1/2} \rfloor) \geq \begin{cases} (2-\lambda)n^{3/2} + O(n) & \text{if } \lambda < 1 \\ \frac{1}{\lambda}n^{3/2} + O(n) & \text{if } \lambda \geq 1. \end{cases} \quad \square$$

By the same method as in the proof of Theorem 24, we also obtain the lower bound for our third main result:

Theorem 25 *Let $d = d(n) > 0$ be such that $d = \Omega(n^{1/2})$ and $\limsup \frac{d}{n} < 2$. Then*

$$\text{add}(n, n + d) = \Omega\left(\frac{n^2}{d}\right).$$

Proof Let $\epsilon \in \{0, 1\}$ be arbitrary. Then for those values of n for which $d \geq \epsilon n$, the result is equivalent to showing that $\text{add}(n, n + d) = \Omega(n)$, which follows immediately from Proposition 22 (since $\limsup_{n \rightarrow \infty} \frac{d}{n} < 2$ and add is monotonic). Hence, we may assume that $d \leq \epsilon n \forall n$.

We now follow the proof of Theorem 24, with $\lfloor \lambda n^{1/2} \rfloor$ replaced by d . As before, we find (by (5)) that if $i \geq xn^{1/2}$ (where x is an arbitrary constant) then $\text{add}(n, n + d) > \frac{xn^{3/2}}{3} = \Omega(n^{3/2})$, and (analogously to (6)) that if $i < xn^{1/2}$ then $\text{add}(n, n + d) > \frac{(n+d)^2}{d+i+2} - 2(n+d) + i\left(n - \frac{i+1}{2}\right) \geq \frac{(n+d)^2}{d+i+2} - 2(n+d) = \Omega\left(\frac{n^2}{d}\right)$, since $\frac{d}{n} \leq \epsilon < 1$ (and so $\frac{(n+d)^2}{d+i+1} > 2(n+d)$). Thus, we obtain $\text{add}(n, n + d) \geq \min\left\{\Omega(n^{3/2}), \Omega\left(\frac{n^2}{d}\right)\right\} = \Omega\left(\frac{n^2}{d}\right)$. \square

Similarly, we may obtain the lower bound for our fifth secondary result:

Proposition 26 *Let $d = d(n) > 0$ be such that $d = \omega(n^{1/2})$ and $d = o(n)$. Then*

$$\text{add}(n, n + d) \geq \frac{n^2}{d} + O(n).$$

Proof We copy the proof of Theorem 25, except that for the case when $i < xn^{1/2}$ we now have $\text{add}(n, n + d) > \frac{(n+d)^2}{d+i+2} - 2(n+d) + i\left(n - \frac{i+1}{2}\right) \geq \frac{n^2}{d} + O(n)$. \square

Finally for this part of the section, we shall obtain the lower bound for our last secondary result (which also gives us the lower bound for our final main result):

Proposition 27 *Let $n \geq 6$ and let $m \geq 8$. Then*

$$\text{add}(n, m) \geq \left\lceil \frac{3}{2}(3n - 6 - m) \right\rceil.$$

Proof Since $\text{add}(n, m)$ is integral, it clearly suffices to show that $\text{add}(n, m) \geq \frac{3}{2}(3n - 6 - m)$.

As in the proof of Proposition 22, since $n \geq 6$ and $m \geq 8$, we have a graph $G \in \mathcal{P}(n, m)$ with

(i) $i (= i_n)$ isolated vertices

and (ii) a plane embedding with $f_k (= f_{k,n})$ faces of size k

such that

(iii) G is connected apart from the isolated vertices

and (iv) $\text{add}(n, m) = |\text{add}(G)| \geq \frac{1}{4} \sum_{k=3}^n (k-3)(k+2)f_k + i(n - \frac{i+1}{2})$.

Thus,

$$\begin{aligned} \sum_{k \geq 3} (k-3)f_k &= \sum_{k \geq 3} k f_k - 3 \sum_{k \geq 3} f_k \\ &= 2m - 3(m - n + i + 2) \quad \text{by (iii) and Euler's formula.} \\ &= 3n - 6 - m - 3i. \end{aligned}$$

Hence, $\frac{1}{4} \sum_{k=3}^n (k-3)(k+2)f_k \geq \frac{3}{2} \sum_{k \geq 3} (k-3)f_k = \frac{3}{2}(3n - 6 - m - 3i)$, and so $\text{add}(n, m) \geq \frac{3}{2}(3n - 6 - m - 3i) + i(n - \frac{i+1}{2}) = \frac{3}{2}(3n - 6 - m) + i(n - \frac{i}{2} - 5)$. Thus, we certainly have $\text{add}(n, m) \geq \frac{3}{2}(3n - 6 - m)$ for those values of n for which $i = i_n \leq 2(n - 5)$.

It now only remains to consider the values of n for which $i = i_n > 2(n - 5)$. But recall $\text{add}(n, m) \geq \frac{1}{4} \sum_{k=3}^n (k-3)(k+2)f_k + i(n - \frac{i+1}{2}) \geq i(n - \frac{i+1}{2})$ and note that $i = 2n - 9$ minimizes $i(n - \frac{i+1}{2})$ in the region $i \in \{2n - 9, n\}$. Thus, for those values of n for which $i = i_n > 2(n - 5)$, we must have $\text{add}(n, m) \geq (2n - 9)(n - \frac{2n-8}{2}) = 8n - 36 \geq \frac{3}{2}(3n - 6 - m)$, since $n \geq 6$ and $m \geq 8$. \square

We shall now spend the remainder of this section providing upper bounds to show that our lower bounds are actually all tight.

We start with the upper bound for the first of our main results:

Theorem 28 *Let $d = d(n) > 0$ be such that $d = \Omega(n^{1/2})$. Then*

$$\text{add}(n, n - d) = O(dn).$$

Proof Clearly, $\text{add}(n, m) \leq \binom{n}{2} = O(n^2)$. Thus, it suffices to prove the result for the case when $d \leq \epsilon n \forall n$, where $\epsilon > 0$ is an arbitrary (small) constant.

By the monotonicity of add , it suffices to construct a planar graph, G , with $e(G) \leq n - d$ and $\text{add}(G)$ sufficiently small. We shall use the same construction as in the proof of Proposition 22 ([7], 1.2), which itself follows an idea from [15].

Let $x > 0$ be an arbitrary constant and consider the following triangulation on $\lfloor xd \rfloor$ vertices:

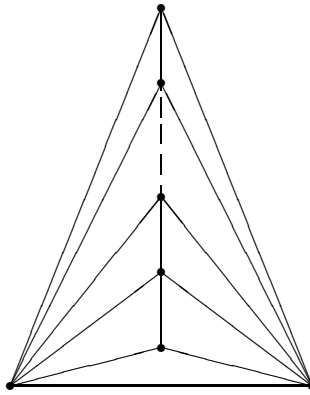

Figure 8: Our triangulation.

From now on, we shall refer to the vertices in this triangulation as ‘core vertices’, and to the two vertices of degree > 4 as ‘base vertices’. We shall use the term ‘spine line’ to denote an edge between two non-base core vertices or between the two base vertices.

Let $i = 2x + 1$ and note that we may assume that $n - \lfloor xd \rfloor - \lfloor id \rfloor > 0$, since x may be taken to be arbitrarily small and $d \leq \epsilon n$. Let us insert $n - \lfloor xd \rfloor - \lfloor id \rfloor$ new vertices as evenly as possible on the $\lfloor xd \rfloor - 2$ spine lines (i.e. so that between $\lfloor \frac{n - \lfloor xd \rfloor - \lfloor id \rfloor}{\lfloor xd \rfloor - 2} \rfloor$ and $\lfloor \frac{n - \lfloor xd \rfloor - \lfloor id \rfloor}{\lfloor xd \rfloor - 2} \rfloor + 1$ new vertices are inserted on each spine line). Then our new graph is a subdivision of our triangulation, which was 3-connected. Thus, by a theorem of Whitney [20], our new graph has the following *unique* embedding in the plane:

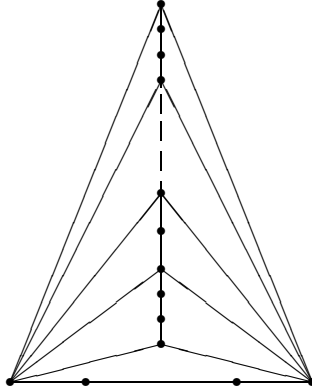

Figure 9: The unique embedding in the plane of our new graph.

Let us also include $\lfloor id \rfloor$ isolated vertices in our graph, which we shall call G . Then the total number of vertices in G is $\lfloor xd \rfloor + (n - \lfloor xd \rfloor - \lfloor id \rfloor) + \lfloor id \rfloor = n$ and the total number of edges is $(3\lfloor xd \rfloor - 6) + (n - \lfloor xd \rfloor - \lfloor id \rfloor) = n + 2\lfloor xd \rfloor - \lfloor id \rfloor - 6$.

Note that $n - d > n + 2\lfloor xd \rfloor - \lfloor (2x + 1)d \rfloor - 6 = n + 2\lfloor xd \rfloor - \lfloor id \rfloor - 6$, so $\text{add}(n, n - d) \leq \text{add}(G)$.

Let us now consider $\text{add}(G)$. The only addable non-edges are those between: (i) two isolated vertices; (ii) an isolated vertex and another vertex; (iii) a non-isolated new vertex and another new vertex on the same spine line; (iv) a non-base core vertex and a new vertex from one of two spine lines; (v) a non-base core vertex and at most two other non-base core vertices; or (vi) a base vertex and another vertex.

Thus,

$$\begin{aligned}
\text{add}(n, n-d) &\leq \text{add}(G) \\
&\leq \binom{\lfloor id \rfloor}{2} \\
&\quad + \lfloor id \rfloor (n - \lfloor id \rfloor) \\
&\quad + \frac{1}{2} \left((n - \lfloor id \rfloor - \lfloor xd \rfloor) \left(\left\lceil \frac{n - \lfloor id \rfloor - \lfloor xd \rfloor}{\lfloor xd \rfloor - 2} \right\rceil \right) \right) \\
&\quad + \lfloor xd \rfloor \left(2 \left\lceil \frac{n - \lfloor id \rfloor - \lfloor xd \rfloor}{\lfloor xd \rfloor - 2} \right\rceil \right) \\
&\quad + \lfloor xd \rfloor \\
&\quad + 2n \\
&= O(dn), \text{ since } d = \Omega(n^{1/2}). \quad \square
\end{aligned}$$

By the same method, we may also obtain the upper bounds for the first two of our secondary results:

Proposition 29 *Let $A < 1$ be a fixed constant and let $m = m(n)$ be such that $m \geq An + o(n)$ for all large n . Then*

$$\text{add}(n, m) \leq (1 + o(1)) \frac{(1-A)(1+A)}{2} n^2.$$

Proof As in the proof of Theorem 28, with $d = (1-A)n$, we obtain

$$\begin{aligned}
\text{add}(n, An) &\leq \binom{\lfloor i(1-A)n \rfloor}{2} \\
&\quad + \lfloor i(1-A)n \rfloor (n - \lfloor i(1-A)n \rfloor) \\
&\quad + \frac{1}{2} \left(n - \lfloor i(1-A)n \rfloor - \lfloor x(1-A)n \rfloor \right) \\
&\quad \cdot \left(\left\lceil \frac{n - \lfloor i(1-A)n \rfloor - \lfloor x(1-A)n \rfloor}{\lfloor x(1-A)n \rfloor - 2} \right\rceil \right) \\
&\quad + \lfloor x(1-A)n \rfloor \left(2 \left\lceil \frac{n - \lfloor i(1-A)n \rfloor - \lfloor x(1-A)n \rfloor}{\lfloor x(1-A)n \rfloor - 2} \right\rceil \right) \\
&\quad + \lfloor x(1-A)n \rfloor \\
&\quad + 2n
\end{aligned}$$

$$\begin{aligned}
&= (1 + o(1)) \left(\frac{i^2(1-A)^2 n^2}{2} + i(1-A)n(n - i(1-A)n) \right) \\
&= (1 + o(1))i(1-A)n^2 \left(1 - \frac{i(1-A)}{2} \right).
\end{aligned}$$

Since this holds with i arbitrarily close to 1, we must have

$$\begin{aligned}
\text{add}(n, An) &\leq (1 + o(1))(1-A)n^2 \left(1 - \frac{1-A}{2} \right) \\
&= (1 + o(1)) \frac{(1-A)(1+A)}{2} n^2. \quad \square
\end{aligned}$$

Proposition 30 *Let $d = d(n) > 0$ be such that $d = \omega(n^{1/2})$ and $d = o(n)$.*

Then

$$\text{add}(n, n-d) \leq (1 + o(1))dn.$$

Proof By the same method as in Theorem 28, we obtain

$$\begin{aligned}
\text{add}(n, n-d) &\leq \binom{\lfloor id \rfloor}{2} \\
&\quad + \lfloor id \rfloor (n - \lfloor id \rfloor) \\
&\quad + \frac{1}{2} \left((n - \lfloor id \rfloor - \lfloor xd \rfloor) \left(\left\lceil \frac{n - \lfloor id \rfloor - \lfloor xd \rfloor}{\lfloor xd \rfloor - 2} \right\rceil \right) \right) \\
&\quad + \lfloor xd \rfloor \left(2 \left\lceil \frac{n - \lfloor id \rfloor - \lfloor xd \rfloor}{\lfloor xd \rfloor - 2} \right\rceil \right) \\
&\quad + \lfloor xd \rfloor \\
&\quad + 2n \\
&= (1 + o(1))idn.
\end{aligned}$$

Since this holds with i arbitrarily close to 1, we must have $\text{add}(n, n-d) \leq (1 + o(1))dn$. \square

We may also use the same method to obtain the upper bound for the second of our main results, and simultaneously the third and fourth of our secondary results:

Theorem 31 *Let λ be a (not necessarily positive) fixed constant and let $m = m(n)$ be such that $m \geq n + \lambda n^{1/2} + o(n^{1/2})$. Then*

$$\text{add}(n, m) \leq (1 + o(1)) \begin{cases} (2 - \lambda) n^{3/2} & \text{if } \lambda \leq 1 \\ \frac{1}{\lambda} n^{3/2} & \text{if } \lambda \geq 1 \end{cases}$$

Proof By the same argument as in the proof of Theorem 24, we may without loss of generality assume that $m = n + \lfloor \lambda n^{1/2} \rfloor \forall n$. Again, for this case we shall be able to show that $\text{add}(n, m) \leq \begin{cases} (2 - \lambda) n^{3/2} + O(n) & \text{if } \lambda \leq 1 \\ \frac{1}{\lambda} n^{3/2} + O(n) & \text{if } \lambda \geq 1. \end{cases}$

By the monotonicity of add , it suffices to construct a planar graph, G , with $e(G) \leq n + \lambda n^{1/2}$ and $\text{add}(G)$ sufficiently small.

Let $x = \max\{\frac{1}{2}, \frac{\lambda}{2}\}$ and let $i = 2x - \lambda$. We take the triangulation of Theorem 28 with $\lfloor xn^{1/2} \rfloor$ ‘core vertices’ and insert $n - \lfloor xn^{1/2} \rfloor - \lfloor in^{1/2} \rfloor$ new vertices as evenly as possible on the ‘spine lines’. We also include $\lfloor in^{1/2} \rfloor$ isolated vertices in our graph.

The total number of vertices in our new graph, G , is n and the number of edges is $(3\lfloor xn^{1/2} \rfloor - 6) + (n - \lfloor xn^{1/2} \rfloor - \lfloor in^{1/2} \rfloor) = n + 2\lfloor xn^{1/2} \rfloor - \lfloor in^{1/2} \rfloor - 6$. Note that $\lfloor \lambda n^{1/2} \rfloor = \lfloor (2x - i)n^{1/2} \rfloor > 2\lfloor xn^{1/2} \rfloor - \lfloor in^{1/2} \rfloor - 6$, so $\text{add}(n, m) \leq \text{add}(G)$.

Similarly to with the proof of Theorem 28, we obtain

$$\begin{aligned} \text{add}(G) &\leq \binom{\lfloor in^{1/2} \rfloor}{2} \\ &\quad + \lfloor in^{1/2} \rfloor (n - \lfloor in^{1/2} \rfloor) \\ &\quad + \frac{1}{2} \left((n - \lfloor in^{1/2} \rfloor - \lfloor xn^{1/2} \rfloor) \left(\left\lceil \frac{n - \lfloor in^{1/2} \rfloor - \lfloor xn^{1/2} \rfloor}{\lfloor xn^{1/2} \rfloor - 2} \right\rceil \right) \right) \\ &\quad + \lfloor xn^{1/2} \rfloor \left(2 \left\lceil \frac{n - \lfloor in^{1/2} \rfloor - \lfloor xn^{1/2} \rfloor}{\lfloor xn^{1/2} \rfloor - 2} \right\rceil \right) \\ &\quad + \lfloor xn^{1/2} \rfloor \\ &\quad + 2n \\ &= \left(i + \frac{1}{2x} \right) n^{3/2} + O(n) \\ &= \begin{cases} (2 - \lambda) n^{3/2} + O(n) & \text{if } \lambda \leq 1 \\ \frac{1}{\lambda} n^{3/2} + O(n) & \text{if } \lambda \geq 1. \end{cases} \quad \square \end{aligned}$$

Similarly, we may use the same method to obtain the upper bound for the third of our main results:

Theorem 32 *Let $d = d(n) > 0$ be such that $d = O(n)$. Then*

$$\text{add}(n, n + d) = O\left(\frac{n^2}{d}\right).$$

Proof We take the triangulation of Theorem 28 with $\lfloor \frac{d}{2} \rfloor$ ‘core vertices’ and insert $n - \lfloor \frac{d}{2} \rfloor$ new vertices as evenly as possible on the ‘spine lines’.

The total number of vertices in our new graph, G , is n and the total number of edges is $(3\lfloor \frac{d}{2} \rfloor - 6) + (n - \lfloor \frac{d}{2} \rfloor) = n + 2\lfloor \frac{d}{2} \rfloor - 6$.

Similarly to with the proof of Theorem 28, we have

$$\begin{aligned} \text{add}(n, n + d) &\leq \text{add}(n, n + 2\lfloor d/2 \rfloor - 6) \\ &\leq \text{add}(G) \\ &\leq \frac{1}{2} \left(\left(n - \lfloor \frac{d}{2} \rfloor \right) \left(\left\lceil \frac{n - \lfloor \frac{d}{2} \rfloor}{\lfloor \frac{d}{2} \rfloor - 2} \right\rceil \right) \right) \\ &\quad + \lfloor \frac{d}{2} \rfloor \left(2 \left\lceil \frac{n - \lfloor \frac{d}{2} \rfloor}{\lfloor \frac{d}{2} \rfloor - 2} \right\rceil \right) + \lfloor \frac{d}{2} \rfloor + 2n \\ &= O\left(\frac{n^2}{d}\right). \quad \square \end{aligned}$$

The same calculations also provide us with the upper bound for our fifth secondary result:

Proposition 33 *Let $d = d(n) > 0$ be such that $d = o(n)$. Then*

$$\text{add}(n, n + d) \leq \frac{n^2}{d} + O(n).$$

Finally, we may obtain the upper bound for our last secondary result (which combines with Theorem 32 to also give us the upper bound for our final main result):

Proposition 34 *Let $m \geq 2n - 3$. Then*

$$\text{add}(n, m) \leq \left\lceil \frac{3}{2}(3n - 6 - m) \right\rceil.$$

Proof We take the triangulation of Theorem 28 with $\lfloor \frac{m-n}{2} \rfloor + 3$ ‘core vertices’ and insert $\lceil \frac{3n-m}{2} \rceil - 3$ new vertices as evenly as possible on the ‘spine lines’. If $m - n$ is odd, we also insert a new edge from one new vertex to one base vertex.

The total number of vertices in our new graph, G , is n (since $m - n$ and $3n - m$ have the same parity) and the total number of edges is $3(\lfloor \frac{m-n}{2} \rfloor + 3) - 6 + \lceil \frac{3n-m}{2} \rceil - 3 + \mathbf{1}\{m - n \text{ odd}\} = 3\lfloor \frac{m-n}{2} \rfloor + \lceil \frac{3n-m}{2} \rceil + \mathbf{1}\{m - n \text{ odd}\} = m$.

Note that the number of spine lines is $\lfloor \frac{m-n}{2} \rfloor + 1 \geq \lceil \frac{3n-m}{2} \rceil - 3$, since $m \geq 2n - 3$. Thus, we will have at most one new vertex on each spine line, and so G is as shown in Figure 10. It is then clear that

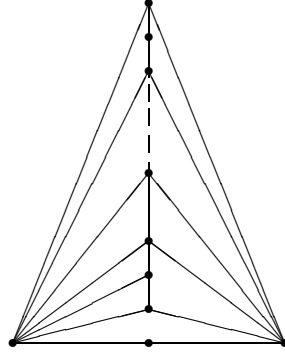

Figure 10: The unique embedding in the plane of our new graph, G .

$$\begin{aligned} |\text{add}(G)| &= 3 \times (\text{number of new vertices}) - \mathbf{1}\{m - n \text{ odd}\} \\ &= 3 \left\lceil \frac{3n - m}{2} \right\rceil - 9 - \mathbf{1}\{m - n \text{ odd}\} \\ &= \left\lceil \frac{9n - 3m}{2} - 9 \right\rceil \\ &= \left\lceil \frac{3}{2}(3n - 6 - m) \right\rceil. \quad \square \end{aligned}$$

6 Components I: Lower Bounds

We now come to our first main section, where we shall start to look at lower bounds for $\mathbf{P}[P_{n,m}$ will have a component isomorphic to H]. We will see (in Theorem 36) that, for any connected planar graph H , the probability that $P_{n,m}$ will have a component isomorphic to H is bounded away from 0 for sufficiently large n if $\frac{m}{n}$ is bounded below by $b > 1$ and above by $B < 3$. We shall then see (in Theorem 37) that, in fact, the lower bound need only be $c > 0$ if H has at most one cycle. Finally, we will discover (in Corollary 39 via Theorem 38) that the probability actually converges to 1 if H is a tree and $\frac{m}{n} \in [c, 1 + o(1)]$ as $n \rightarrow \infty$.

The proofs of our results will be based on counting: we will construct graphs with components isomorphic to H from other graphs in $\mathcal{P}(n, m)$ by deleting and inserting ‘suitable’ edges in carefully chosen ways, and we will then show that there isn’t too much double-counting. The properties shown in Sections 4 and 5 will play a crucial role.

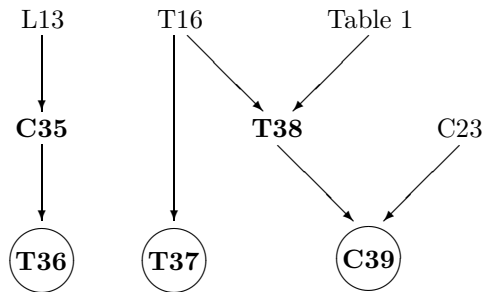

Figure 11: The structure of Section 6.

We start by noting a simple corollary to Lemma 13:

Corollary 35 *Let $b > 1$ and $B < 3$ be fixed constants and let $m(n) \in [bn, Bn] \forall n$.*

Then there exist constants $N(b, B)$ and $\delta(b, B) > 0$ such that

$$\mathbf{P}[P_{n,m} \text{ will have } < \delta n \text{ edge-disjoint appearances of } K_4] < e^{-\delta n} \forall n \geq N.$$

Proof Any appearances of K_4 must be edge-disjoint, by 2-edge-connectivity (in fact, they must be vertex-disjoint). Hence, the result follows from Lemma 13. \square

We will now use Corollary 35 to prove the first of our aforementioned theorems. In fact, we shall actually show a slightly stronger version than that advertised, involving several components at once:

Theorem 36 *Let $b > 1$ and $B < 3$ be fixed constants and let $m(n) \in [bn, Bn]$ for all large n . Let H_1, H_2, \dots, H_l be (fixed) connected planar graphs and let t be a fixed constant. Then there exist constants $\epsilon > 0$ and N such that*

$$\mathbf{P}\left[\bigcap_{i=1}^l (P_{n,m} \text{ will have } \geq t \text{ components with an order-preserving isomorphism to } H_i)\right] \geq \epsilon \forall n \geq N.$$

Sketch of Proof By symmetry, it suffices to prove the result without the order-preserving condition. The proof is then by induction on l . We shall suppose that the result is true for $l = j$, but false for $l = j+1$. Thus, using Corollary 35, there must be a decent proportion of graphs in $\mathcal{P}(n, m)$ that have (a) $\geq t$ components isomorphic to $H_i \forall i \leq j$, (b) $< t$ components isomorphic to H_{j+1} , and (c) many edge-disjoint appearances of K_4 .

For each such graph, we can delete edges from some of these appearances of K_4 to create isolated vertices, on which we may then construct t components isomorphic to H_{j+1} . By inserting extra edges in appropriate places elsewhere, we may hence obtain graphs in $\mathcal{P}(n, m)$. The fact that the original graphs contained few components isomorphic to H_{j+1} can then be used to show that there isn't too much double-counting, and so we find that we have actually constructed a decent proportion of *distinct* graphs in $\mathcal{P}(n, m)$.

By carefully selecting where we delete/insert edges, we may ensure that these new graphs still have $\geq t$ components isomorphic to $H_i \forall i \leq j$, and so we are done.

Full Proof As mentioned, it suffices to prove the result without the order-preserving condition, since given any collection of tl components such that exactly t are isomorphic to $H_i \forall i$, the probability that they are all order-preserving is $\prod_{i=1}^l \left(\left(\frac{|\text{Aut}(H_i)|}{|H_i|!} \right)^t \right)$.

We shall now prove the simplified version of the result by induction on l . Suppose it is true for $l = j$, i.e. $\exists \epsilon_j > 0$ and $\exists N_j$ such that

$$\mathbf{P} \left[\bigcap_{i=1}^j (P_{n,m} \text{ will have } \geq t \text{ components isomorphic to } H_i) \right] \geq \epsilon_j \forall n \geq N_j.$$

Let $\mathcal{L}_{n,r}$ denote the set of graphs in $\mathcal{P}(n, m)$ that have $\geq t$ components isomorphic to $H_i \forall i \leq r$. Then $|\mathcal{L}_{n,j}| \geq \epsilon_j |\mathcal{P}(n, m)| \forall n \geq N_j$.

We have $\frac{m}{n} \in [b, B] \forall$ large n . Thus, by Corollary 35, there are constants $\delta = \delta(b, B) > 0$ and $N'(b, B)$ such that, for all $n \geq N'$,

$$\mathbf{P}[P_{n,m} \text{ will have at least } \delta n \text{ edge-disjoint appearances of } K_4] \geq \left(1 - \frac{\epsilon_j}{3}\right).$$

Let \mathcal{I}_n denote the set of graphs in $\mathcal{P}(n, m)$ that have $\geq \delta n$ edge-disjoint appearances of K_4 . Then $|\mathcal{I}_n \cap \mathcal{L}_{n,j}| \geq \frac{2\epsilon_j}{3} |\mathcal{P}(n, m)| \forall n \geq N = \max\{N', N_j\}$.

Consider an $n \geq N$ and suppose that $|\mathcal{L}_{n,j+1}| \leq \frac{\epsilon_j}{3} |\mathcal{P}(n, m)|$ (if not, then we are done). Let $\mathcal{G}_{n,j}$ denote the set of graphs in $\mathcal{L}_{n,j}$ with (i) $< t$ components isomorphic to H_{j+1} and (ii) at least δn edge-disjoint appearances of K_4 . Then, under our assumption, we have $|\mathcal{G}_{n,j}| \geq \frac{\epsilon_j}{3} |\mathcal{P}(n, m)|$. We shall use $\mathcal{G}_{n,j}$ to construct graphs in $\mathcal{L}_{n,j}$ with $\geq t$ components isomorphic to H_{j+1} .

Consider a graph $G \in \mathcal{G}_{n,j}$. Then G contains a subgraph F consisting of jt components such that, for all $i \leq j$, exactly t of these components isomorphic to H_i . Also, G has a set of at least δn edge-disjoint appearances of K_4 . Note

that at least $\delta n - t \sum_{i=1}^j \left\lfloor \frac{e(H_i)}{6} \right\rfloor$ of these edge-disjoint appearances of K_4 must lie in $G \setminus F$. Let $s = t \sum_{i=1}^j \left\lfloor \frac{e(H_i)}{6} \right\rfloor$, let $H = H_{j+1}$, and let $k = |H|$. We may assume that n is large enough that $\delta n - s \geq tk$. Thus, we may choose tk of the edge-disjoint appearances of K_4 in $G \setminus F$ (at least $\binom{\lceil \delta n \rceil - s}{tk}$ choices), and for each of these chosen appearances we may choose a ‘special’ vertex in the K_4 that is not the root (3^{tk} choices). Let us then delete all $3tk$ edges that are incident to the ‘special’ vertices and insert edges between these tk newly isolated vertices in such a way that they now form t components isomorphic to H (at least $\binom{tk}{k, \dots, k} \frac{1}{t!}$ choices).

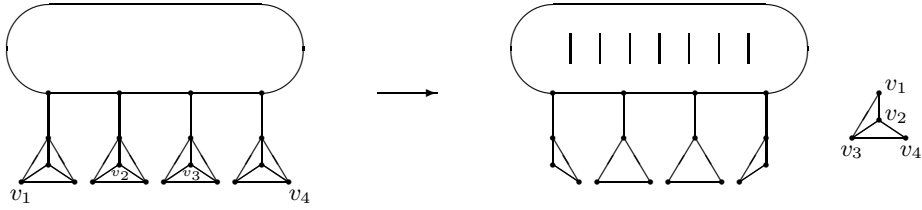

Figure 12: Constructing a component isomorphic to H .

To maintain the correct number of edges, we should insert $t(3k - e(H))$ extra ones somewhere into the graph, making sure that we maintain planarity. We will do this in such a way that we do not interfere with our new components, with the chosen appearances of K_4 (which are now appearances of K_3), or with F . Thus, the part of the graph where we wish to insert edges contains $n - 4tk - |F|$ vertices and $m - 7tk - e(F)$ edges. We know that there exists a triangulation on these vertices containing these edges, and clearly inserting an edge from this triangulation would not violate planarity. Thus, we have at least $\binom{3(n-4tk-|F|)-6-(m-7tk-e(F))}{t(3k-l)}$ choices for where to add the edges, where $l = e(H)$.

Therefore, we have at least

$$\begin{aligned}
& |\mathcal{G}_{n,j}| \binom{\lceil \delta n \rceil - s}{tk} 3^{tk} \binom{tk}{k, \dots, k} \frac{1}{t!} \binom{3(n - 4tk - |F|) - 6 - (m - 7tk - e(F))}{t(3k - l)} \\
&= |\mathcal{G}_{n,j}| \Theta \left(n^{t(4k-l)} \right) \quad \left(\text{recalling that } \frac{m}{n} \text{ is bounded away from } 3 \right)
\end{aligned}$$

ways to build (not necessarily distinct) graphs in $\mathcal{L}_{n,j}$ that have at least t components isomorphic to H .

We will now consider the amount of double-counting:

Each of our constructed graphs will contain at most $t(4k - l + 2) - 1$ components isomorphic to H (since there were at most $t - 1$ already; we have deliberately added t ; and we may have created at most one extra one each time we cut a ‘special’ vertex away from its K_4 or added an edge in the rest of the graph). Hence, we have at most $\binom{t(4k-l+2)-1}{t}$ possibilities for which were our tk ‘special’ vertices. Since appearances of K_3 must be vertex-disjoint, by 2-edge-connectedness, we have at most $\frac{n}{3}$ of them and hence at most $\left(\frac{n}{3}\right)^{tk}$ possibilities for where the ‘special’ vertices were originally. There are then at most $\binom{m-tl-4tk}{t(3k-l)}$ possibilities for which edges were added in the rest of the graph (i.e. away from the constructed components isomorphic to H and these appearances of K_3). Thus, the amount of double-counting is at most $\binom{t(4k-l+2)-1}{t} \left(\frac{n}{3}\right)^{tk} \binom{m-tl-4tk}{t(3k-l)} = \Theta \left(n^{t(4k-l)} \right)$, recalling that $m = \Theta(n)$.

Hence, under our assumption that $|\mathcal{G}_{n,j}| \geq \frac{\epsilon_j |\mathcal{P}(n,m)|}{3}$, we find that the number of graphs in $\mathcal{L}_{n,j}$ that have $\geq t$ components isomorphic to H is at least $\Theta(|\mathcal{P}(n,m)|)$.

But the set of graphs in $\mathcal{L}_{n,j}$ that have $\geq t$ components isomorphic to H is exactly $\mathcal{L}_{n,j+1}$. Thus, by assuming that $|\mathcal{L}_{n,j+1}| \leq \frac{\epsilon_j}{3} |\mathcal{P}(n,m)|$, we have proved $\exists \zeta > 0$ such that $\frac{|\mathcal{L}_{n,j+1}|}{|\mathcal{P}(n,m)|} \geq \zeta$. Therefore, $\frac{|\mathcal{L}_{n,j+1}|}{|\mathcal{P}(n,m)|} \geq \epsilon_{j+1} = \min\{\zeta, \frac{\epsilon_j}{3}\} > 0$.

Hence, we are done, by induction. \square

Note that in the previous proof, we could have constructed components isomorphic to H directly from appearances of H . We chose to instead build the components from isolated vertices cut from appearances of K_4 , as this technique generalises more easily to our next proof, as we shall now explain.

Recall that when we cut the isolated vertices from the appearances of K_4 , this involved deleting three edges for each isolated vertex that we created, which crucially meant that we had enough edges to play with when we wanted to turn these isolated vertices into components isomorphic to H . Notice, though, that the proof was only made possible by the fact that we had lots of appearances of K_4 to choose from, which was why we needed to restrict $\frac{m}{n}$ to the region $[b, B]$, where $b > 1$ and $B < 3$.

However, if $e(H) \leq |H|$ then we would have enough edges to play with even if we only deleted one edge for each isolated vertex that we created. Thus, we may replace the role of the appearances of K_4 by pendant edges, which we know are plentiful even for small values of $\frac{m}{n}$, by Theorem 16. Hence, we may obtain:

Theorem 37 *Let $c > 0$ and $B < 3$ be fixed constants and let $m(n) \in [cn, Bn]$ for all large n . Let H_1, H_2, \dots, H_l be (fixed) connected planar graphs with at most one cycle each and let t be a fixed constant. Then there exist constants $\epsilon > 0$ and N such that*

$$\mathbf{P} \left[\bigcap_{i=1}^l (P_{n,m} \text{ will have } \geq t \text{ components with} \right. \\ \left. \text{an order-preserving isomorphism to } H_i) \right] \geq \epsilon \quad \forall n \geq N.$$

Proof As with Theorem 36, it suffices to prove the result without the order-preserving condition, and again the proof is by induction on l . Suppose the result is true for $l = j$, but false for $l = j + 1$. Then, similarly to with the proof of Theorem 36, we have a set $\mathcal{G}_{n,j}$ of at least $\frac{\epsilon_j}{3} |\mathcal{P}(n, m)|$ graphs with (i) $\geq t$ components isomorphic to $H_i \forall i \leq j$, (ii) $< t$ components isomorphic to H_{j+1} and (iii) at least δn pendant edges (using Theorem 16).

Given a graph $G \in \mathcal{G}_{n,j}$, we may delete $t|H_{j+1}|$ of the pendant edges (taking care not to interfere with our components isomorphic to H_i for $i \leq j$) and use the resulting isolated vertices to construct t components isomorphic to H_{j+1} . If H_{j+1} is a tree, then we should also add t edges in suitable places somewhere in the rest of the graph.

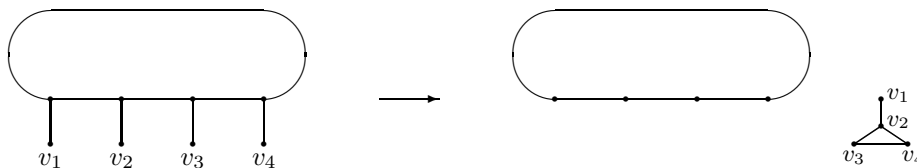

Figure 13: Constructing a component isomorphic to H_{j+1} .

By similar counting arguments to those used in the proof of Theorem 36, we achieve our result. \square

We shall now finish this section by looking specifically at the case when H is a tree. We already know from Theorem 37 that the probability that $P_{n,m}$ will contain a component isomorphic to a given fixed tree is certainly bounded away from 0 for large n if $\frac{m}{n}$ is bounded below by $c > 0$ and above by $B < 3$. We will now see (in Corollary 39) that the limiting probability is, in fact, 1 if $\frac{m}{n} \in [c, 1 + o(1)]$ as $n \rightarrow \infty$. Note that this result can actually be shown by exactly the same proof as for Theorem 37, using the additional ingredient that $\text{add}(n, m) = \omega(n)$ if $\frac{m}{n} \leq 1 + o(1)$ (from Corollary 23). However, we shall instead aim to give (in Theorem 38) a more detailed account of the number of components isomorphic to H , which will include Corollary 39. The proof will again involve deleting pendant edges and inserting edges elsewhere, but the calculations will now be more complicated:

Theorem 38 *Let H be a (fixed) tree, let $c > 0$ be a fixed constant and let $m = m(n) \in [cn, (1 + o(1))n]$. Then $\exists \lambda(H, c) > 0$ such that*

$$\mathbf{P}\left[P_{n,m} \text{ will have } < \left\lceil \frac{\lambda_{\text{add}}(n,m)}{n} \right\rceil \text{ components with an order-preserving isomorphism to } H\right] < e^{-\left\lceil \frac{\lambda_{\text{add}}(n,m)}{n} \right\rceil} \text{ for all large } n.$$

Sketch of Proof We suppose that the result is false. Thus, using Theorem 16, there must be a decent proportion of graphs in $\mathcal{P}(n, m)$ that have (i) ‘few’ components with an order-preserving isomorphism to H and (ii) many pendant edges. For each such graph, we can delete some of these pendant edges and use the resulting isolated vertices to construct components with an order-preserving isomorphism to H . By inserting extra edges elsewhere, we may thus construct lots of graphs in $\mathcal{P}(n, m)$. The fact that the original graphs contained few components with order-preserving isomorphism to H can then be used to show that there is not much double-counting, and so we find that we have actually constructed more than $|\mathcal{P}(n, m)|$ distinct graphs in $\mathcal{P}(n, m)$, which is a contradiction.

Full Proof By Theorem 16, there exist constants $\alpha > 0$ and n_0 such that

$$\mathbf{P}[P_{n,m} \text{ will have } < \alpha n \text{ pendant edges}] < e^{-\alpha n} \quad \forall n \geq n_0.$$

Let λ be a small positive constant (whose value we shall choose later), let $t = t(n) = \left\lceil \frac{\lambda_{\text{add}}(n,m)}{n} \right\rceil$ and suppose $\exists n \geq n_0$ such that

$$\mathbf{P}[P_{n,m} \text{ will have } < t \text{ components with an order-preserving isomorphism to } H] \geq e^{-t}.$$

Then there is a set \mathcal{G}_n of at least a proportion $e^{-t} - e^{-\alpha n}$ of the graphs in $\mathcal{P}(n, m)$ with (i) $< t$ components with an order-preserving isomorphism to H and (ii) at least αn pendant edges.

Let $k = |H|$. Since $\text{add}(n, m) \leq \binom{n}{2}$, we may assume that n is large enough (and λ small enough) that $\alpha n \geq tk$ and $e^{-t} - e^{-\alpha n} \geq \frac{1}{2}e^{-t}$.

To build graphs with $\geq t$ components with an order-preserving isomorphism to H , one can start with a graph $G \in \mathcal{G}_n$ ($|\mathcal{G}_n|$ choices), delete tk of the pendant edges (at least $\binom{\lceil \alpha n \rceil}{tk}$ choices), and insert edges between tk of the newly-isolated vertices (choosing one from each pendant edge) in such a way that they now form t components, each with an order-preserving isomorphism to H (at least $\binom{tk}{k, \dots, k} \frac{1}{t!}$ choices). We should then add t edges somewhere in the rest of the graph (i.e. away from our newly constructed components) to maintain the correct number of edges overall (at least $\prod_{i=0}^{t-1} \text{add}(n - tk, m - tk + i) \geq (\text{add}(n - tk, m - tk + t - 1))^t$ choices).

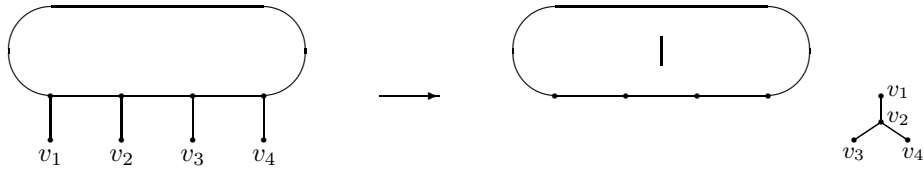

Figure 14: Constructing a component isomorphic to H .

Let us now consider the amount of double-counting: Each of our constructed graphs will contain at most $t(k+3) - 1$ components with an order-preserving isomorphism to H (since there were at most $t - 1$ already in G ; we have deliberately added t ; and we may have created at most one extra one each time we deleted a pendant edge or added an edge in the rest of the graph), so we have at most $\binom{t(k+3)-1}{t} \leq \frac{1}{t!} (t(k+3))^t$ possibilities for which are our created components. We then have at most n^{tk} possibilities for where the vertices in our created components were attached originally and at most $\binom{m}{t} \leq (3n)^t$ possibilities for which edges was added.

Hence, putting everything together, we find that the number of *distinct* graphs in $\mathcal{P}(n, m)$ that have $\geq t$ components with an order-preserving isomor-

phism to H is at least

$$\begin{aligned} & \frac{\binom{\lceil \alpha n \rceil}{k, \dots, k, \lceil \alpha n \rceil - tk}}{n^{tk}} \left(\frac{(\text{add}(n - tk, m - tk + t - 1))^t}{(3n)^t} \right) \frac{|\mathcal{G}_n|}{(t(k+3))^t} \\ \geq & \left(\frac{\alpha^k}{2^k k! 3(k+3)} \cdot \frac{\text{add}(n - tk, m - tk + t - 1)}{tn} \right)^t |\mathcal{G}_n|, \quad \text{since we may} \\ & \text{assume } \lambda \text{ is sufficiently small and } n \text{ sufficiently large that } \alpha n - tk \geq \frac{\alpha n}{2}. \end{aligned}$$

The main thrust of the proof is now over, and we are left with the fiddly task of evaluating $\text{add}(n - tk, m - tk + t - 1)$. We shall see that it is at least $C \text{add}(n, m)$ (for an appropriate constant $C > 0$, independent of λ), which is roughly $\frac{C}{\lambda} tn$. Our desired contradiction will then follow by taking λ to be sufficiently small.

Let $i = n - tk$ and let $s = t - 1$. Then

$$\text{add}(n - tk, m - tk + t - 1) = \text{add}(i, i + (m - n + s)). \quad (7)$$

Since $\text{add}(i, i + l)$ is quite sensitive to changes in l , we shall need to investigate the value of $m - n + s$ in detail.

Recall that $s = \left\lceil \frac{\lambda \text{add}(n, m)}{n} \right\rceil - 1$. From the upper bounds of Section 5, we know there exist constants $B > 0$ and N such that $\forall n \geq N$ we have

$$\text{add}(n, m) \leq \begin{cases} Bn(n - m) & \text{if } m - n < 0 \text{ and } n^{1/2} \leq n - m \leq n \\ Bn^{3/2} & \text{if } |m - n| \leq n^{1/2} \\ B \frac{n^2}{m - n} & \text{if } m - n > 0 \text{ and } n^{1/2} \leq m - n \leq \frac{n}{2}. \end{cases}$$

Thus, since we may assume that λ is sufficiently small that $\lambda B \leq 1/2$, $\forall n \geq N$ we have

$$s < \frac{\lambda \text{add}(n, m)}{n} \leq \left\{ \begin{array}{ll} \frac{n-m}{2} & \text{if } m - n < 0 \text{ and } n^{1/2} \leq |m - n| \leq n \\ \frac{n^{1/2}}{2} & \text{if } |m - n| \leq n^{1/2} \\ \frac{n}{2(m-n)} & \text{if } m - n > 0 \text{ and } n^{1/2} \leq |m - n| \leq \frac{n}{2}. \end{array} \right\} \quad (8)$$

Hence (combining (8) with the fact that we may assume that λ is sufficiently small that $i \geq \frac{n}{2}$), for all $n \geq N$ we have

$$\left. \begin{array}{l} m - n < 0 \text{ and } n^{1/2} \leq |m - n| \leq n \Rightarrow m - n + s < 0 \text{ and} \\ \qquad \qquad \qquad \frac{i^{1/2}}{2} \leq \frac{n^{1/2}}{2} \leq |m - n + s| \\ \qquad \qquad \qquad \leq n \leq 2i \\ |m - n| \leq n^{1/2} \Rightarrow |m - n + s| \leq \frac{3n^{1/2}}{2} \leq 3i^{1/2} \\ m - n > 0 \text{ and } n^{1/2} \leq |m - n| \leq \frac{n}{2} \Rightarrow m - n + s > 0 \text{ and} \\ \qquad \qquad \qquad i^{1/2} \leq n^{1/2} \leq |m - n + s| \\ \qquad \qquad \qquad \leq \frac{n}{2} + \frac{n^{1/2}}{2} \leq i + i^{1/2}. \end{array} \right\} (9)$$

Recall that we are interested in $\text{add}(i, i + (m - n + s))$, where $i = n - tk$. We know from the lower bounds of Section 5 that there exist constants $b > 0$ and N_2 such that $\forall i \geq N_2$ we have

$$\text{add}(i, i + (m - n + s)) \geq \begin{cases} bi|m - n + s| & \text{if } m - n + s < 0 \\ & \text{and } \frac{i^{1/2}}{2} \leq |m - n + s| \leq 2i \\ bi^{3/2} & \text{if } |m - n + s| \leq 3i^{1/2} \\ b \frac{i^2}{|m - n + s|} & \text{if } m - n + s > 0 \\ & \text{and } i^{1/2} \leq |m - n + s| \leq i + i^{1/2}. \end{cases}$$

Thus, combining this with (7) and (9) (and the fact that $i \geq \frac{n}{2}$), for all large n we have

$$\text{add}(n - tk, m - tk + s) \geq \begin{cases} \frac{bn}{2}|m - n + s| & \text{if } m - n < 0 \\ & \text{and } n^{1/2} \leq |m - n| \leq n \\ \frac{bn^{3/2}}{2} & \text{if } |m - n| \leq n^{1/2} \\ \frac{b}{2} \frac{n^2}{|m - n + s|} & \text{if } m - n > 0 \\ & \text{and } n^{1/2} \leq |m - n| \leq \frac{n}{2} \end{cases}$$

$$\begin{aligned}
& \text{by (8)} \\
& \geq \begin{cases} \frac{bn}{4}|m-n| & \text{if } m-n < 0 \\ & \text{and } n^{1/2} \leq |m-n| \leq n \\ \frac{bn^{3/2}}{2} & \text{if } |m-n| \leq n^{1/2} \\ \frac{b}{3} \frac{n^2}{|m-n|} & \text{if } m-n > 0 \\ & \text{and } n^{1/2} \leq |m-n| \leq \frac{n}{2} \end{cases} \\
& \geq C \text{add}(n, m) \text{ if } m \leq \frac{3n}{2}, \text{ by Section 5} \\
& \quad (\text{for some } C > 0 \text{ and sufficiently large } n).
\end{aligned}$$

Hence, continuing from where we left off, the number of graphs in $\mathcal{P}(n, m)$ that have $\geq t$ components with an order-preserving isomorphism to H is at least $\left(\frac{\alpha^k}{2^k k! 3^{k+3}} \cdot \frac{C \text{add}(n, m)}{tn}\right)^t |\mathcal{G}_n| = \left((1 + o(1)) \frac{\alpha^k C}{2^k k! 3^{k+3} \lambda}\right)^t |\mathcal{G}_n|$. But this is more than $|\mathcal{P}(n, m)|$ for large n , if λ is sufficiently small, since we recall our assumption that $|\mathcal{G}_n| \geq \frac{1}{2} e^{-t} |\mathcal{P}(n, m)|$.

Thus, by proof by contradiction, it must be that

$$\begin{aligned}
& \mathbf{P}\left[P_{n,m} \text{ will have } < \lceil \frac{\lambda \text{add}(n, m)}{n} \rceil \text{ components with} \right. \\
& \quad \left. \text{an order-preserving isomorphism to } H \right] \\
& < e^{-\lceil \frac{\lambda \text{add}(n, m)}{n} \rceil} \text{ for all large } n. \quad \square
\end{aligned}$$

Our aforementioned corollary now follows easily:

Corollary 39 *Let H be a (fixed) tree, let t and $c > 0$ be fixed constants and let $m = m(n) \in [cn, (1 + o(1))n]$ as $n \rightarrow \infty$. Then*

$$\begin{aligned}
& \mathbf{P}[P_{n,m} \text{ will have } \geq t \text{ components with an order-preserving isomorphism to } H] \\
& \rightarrow 1 \text{ as } n \rightarrow \infty.
\end{aligned}$$

Proof By Corollary 23, we know $\text{add}(n, m) = \omega(n)$. Thus, the result follows from Theorem 38. \square

7 Connectivity & $\kappa(P_{n,m})$

In this section, we shall look indirectly at the chances of $P_{n,m}$ containing specific components by investigating the probability that it will be connected (in which case it clearly won't contain any component of order $< n$). This is also an interesting topic in its own right.

We already know (from Corollary 39) that the probability that $P_{n,m}$ will be connected converges to 0 if $m \leq (1 + o(1))n$, and (from Theorem 37) that it is bounded away from 1 for sufficiently large n if $\limsup_{n \rightarrow \infty} \frac{m}{n} < 3$. Conversely, we will now see (in Theorem 44) that the probability is bounded away from 0 if $\liminf_{n \rightarrow \infty} \frac{m}{n} > 1$, and (in Corollary 45) that it converges to 1 if $\frac{m}{n} \rightarrow 3$. Note that we shall then have a complete description of $\mathbf{P}[P_{n,m} \text{ will be connected}]$, in terms of exactly when it is bounded away from 0 and 1.

The proofs will be in two parts, Lemmas 42 and 43, dealing with the cases when $\frac{m}{n}$ is or isn't, respectively, bounded away from 3. As a tool for obtaining Lemma 42, we shall first work towards a result (Lemma 41) on $\kappa(P_{n,m})$, the number of components in $P_{n,m}$. Although not one of the main objectives of this thesis, it is interesting to note that we may obtain quite a lot of information on $\kappa(P_{n,m})$, and so we will explore this topic in more detail during the second half of this section (in particular with Propositions 48 and 50). We will then collect up all our results on $\kappa(P_{n,m})$, including some lower bounds derived from Section 6, on page 73.

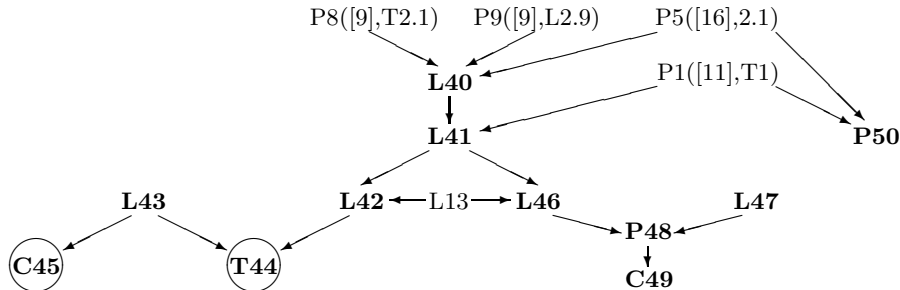

Figure 15: The structure of Section 7.

We start by obtaining a lower bound for $\left(\frac{|\mathcal{P}(n,m)|}{n!}\right)^{1/n}$, which we will use in the proof of Lemma 41 on $\kappa(P_{n,m})$.

Lemma 40 *Let $m = m(n) \in [n, 3n - 6]$ for all large n . Then*

$$\liminf_{n \rightarrow \infty} \left(\frac{|\mathcal{P}(n,m)|}{n!} \right)^{1/n} \geq \gamma(1) = e.$$

Proof The case when $\frac{m}{n}$ is bounded away from 1 follows fairly simply from uniform convergence:

Let $\eta > 0$. Then, by Proposition 9 with $a = \frac{5}{4}$ (for example), $\exists n_0$ such that $\left(\frac{|\mathcal{P}(n,m)|}{n!}\right)^{1/n} > \gamma\left(\frac{m}{n}\right) - \eta \quad \forall m \in \left[\frac{5n}{4}, 3n - 6\right] \quad \forall n \geq n_0$. Recall (from Proposition 8) that $\gamma\left(\frac{m}{n}\right) \geq \gamma(1)$. Thus, since η was an arbitrary positive constant, we are done.

We shall now consider the case $m \in [n, \frac{5n}{4}]$:

Let $m < 3n - 6$. Given a graph, G , in $\mathcal{P}(n, m)$, we may construct a graph in $\mathcal{P}(n, m + 1)$ by inserting an extra edge into G in such a way that we maintain planarity. Since there exists a (planar) triangulation of order n that contains G as a subgraph, we have at least $3n - 6 - m$ choices for the edge to insert. Thus, taking any possible double-counting into account, we have $|\mathcal{P}(n, m + 1)| \geq \frac{3n - 6 - m}{m + 1} |\mathcal{P}(n, m)|$. Hence, if $m \leq \frac{3n - 7}{2}$ then $|\mathcal{P}(n, m)| \leq |\mathcal{P}(n, m + 1)|$. Thus, since $\frac{5n}{4} \leq \frac{3n - 7}{2}$ for sufficiently large n , it suffices to consider the case when $m = n$. But this holds by Proposition 8.

Thus, the result holds for all $m \in [n, 3n - 6]$, by considering the cases $m \in [\frac{5n}{4}, 3n - 6]$ and $m \in [n, \frac{5n}{4}]$ separately. \square

We are now ready to obtain our aforementioned first result on the number of components in $P_{n,m}$, which will turn out to be useful to us later when investigating $\mathbf{P}[P_{n,m} \text{ will be connected}]$. We follow the method of proof of Proposition 11 ([9], Lemma 2.6), which dealt with the case $m = \lfloor qn \rfloor$ for fixed $q \in [1, 3]$.

Lemma 41 *Let $m = m(n) \in [n, 3n - 6]$ for all large n and let the constant c satisfy $c > \ln \gamma_l - 1$. Then*

$$\mathbf{P} \left[\kappa(P_{n,m}) > \left\lceil \frac{cn}{\ln n} \right\rceil \right] = e^{-\Omega(n)}.$$

Proof Let $k = k(n) = \lceil \frac{cn}{\ln n} \rceil$. Then we have $|G \in \mathcal{P}(n, m) : \kappa(G) > k| \leq |G \in \mathcal{P}(n) : \kappa(G) > k| \leq \frac{|\mathcal{P}(n)|}{k!}$, using Proposition 5. Hence, it must be that $\left(\frac{|G \in \mathcal{P}(n, m) : \kappa(G) > k|}{|\mathcal{P}(n, m)|} \right)^{\frac{1}{n}} \leq \left(\frac{1}{k!} \frac{|\mathcal{P}(n)|}{|\mathcal{P}(n, m)|} \right)^{\frac{1}{n}}$.

As $n \rightarrow \infty$, recall that we have $\left(\frac{|\mathcal{P}(n)|}{n!} \right)^{\frac{1}{n}} \rightarrow \gamma_l$ (by Proposition 1) and $\liminf \left(\frac{|\mathcal{P}(n, m)|}{n!} \right)^{\frac{1}{n}} \geq e$ (by Lemma 40). Thus, $\limsup_{n \rightarrow \infty} \left(\frac{|\mathcal{P}(n)|}{|\mathcal{P}(n, m)|} \right)^{\frac{1}{n}} \leq e^{-1} \gamma_l$.

By Stirling's formula, $k! \sim \sqrt{2\pi k} k^k e^{-k}$ as n (and hence k) $\rightarrow \infty$. Thus,

$$\begin{aligned} (k!)^{\frac{1}{n}} &\sim k^{\frac{k}{n}} e^{-\frac{k}{n}} \quad \text{as } n \rightarrow \infty \\ &\sim k^{\frac{k}{n}}, \quad \text{since } \frac{k}{n} \rightarrow 0 \text{ as } n \rightarrow \infty \\ &\sim \left(\frac{cn}{\ln n} \right)^{\frac{c}{\ln n}}, \quad \text{by definition of } k \\ &\sim n^{\frac{c}{\ln n}}, \quad \text{since } \left(\frac{c}{\ln n} \right)^{\frac{c}{\ln n}} \rightarrow 1 \text{ as } \frac{c}{\ln n} \rightarrow 0 \\ &= e^{\frac{c}{\ln n} \ln n} \\ &= e^c. \end{aligned}$$

Therefore, $\limsup_{n \rightarrow \infty} \left(\frac{1}{k!} \frac{|\mathcal{P}(n)|}{|\mathcal{P}(n, m)|} \right)^{\frac{1}{n}} \leq e^{-(1+c)} \gamma_l$, and the theorem follows from the fact that $c > \ln \gamma_l - 1$. \square

We will now use Lemma 41 to work towards Theorem 44, where we shall show that $\mathbf{P}[P_{n,m} \text{ will be connected}]$ is bounded away from 0 if $\liminf_{n \rightarrow \infty} \frac{m}{n} > 1$. At first, we shall restrict ourselves to the case when we also have $\limsup_{n \rightarrow \infty} \frac{m}{n} < 3$, so that we can use the topic of appearances.

Lemma 42 *Let $b > 1$ and $B < 3$ be fixed constants and let $m(n) \in [bn, Bn] \forall n$. Then $\exists c(b, B) > 0$ such that*

$$\mathbf{P}[P_{n,m} \text{ will be connected}] \geq c \forall n.$$

Sketch of Proof By Lemmas 13 and 41, it suffices to consider the set of graphs in $\mathcal{P}(n, m)$ with ‘few’ components and with ‘many’ appearances of a suitable H . Given one of these graphs, we may construct another graph in $\mathcal{P}(n, m)$ with one less component by deleting a non-cut-edge from an appearance of H (to create an appearance of $H - f$, for a suitable f) and inserting an edge between two components. By cascading this result downwards, we find that the proportion of graphs in $\mathcal{P}(n, m)$ with exactly one component must be quite decent. The crucial ingredient in this counting argument is that we have $\Omega(n)$ appearances of H in our given graph and only $O(n)$ appearances of $H - f$ in our constructed graph.

Full Proof Let H be a 2-edge-connected planar graph (for example, we could take H to be K_4) and let $f \in E(H)$. By Lemma 13, $\exists \alpha = \alpha(b, B) > 0$ such that $\mathbf{P}[f_H(P_{n,m}) \leq \alpha n] = e^{-\Omega(n)}$. Let us define \mathcal{G}_n to denote the set of graphs in $\mathcal{P}(n, m)$ such that $G \in \mathcal{G}_n$ iff $f_H(G) \geq \alpha n$. Then we have $|\mathcal{G}_n| > (1 - e^{-\Omega(n)}) |\mathcal{P}(n, m)|$.

Let \mathcal{H}_n denote the set of graphs in $\mathcal{P}(n, m)$ with less than $\frac{\alpha n}{6}$ components. Then, by Lemma 41, we also have $|\mathcal{H}_n| > (1 - e^{-\Omega(n)}) |\mathcal{P}(n, m)|$.

Let \mathcal{L}_n denote the set of graphs in $\mathcal{P}(n, m)$ such that $G \in \mathcal{L}_n$ iff $f_H(G) \geq \frac{\alpha n}{2} + 3\kappa(G)$ and $\kappa(G) \leq \frac{\alpha n}{6}$. Note $\mathcal{L}_n \supset \mathcal{G}_n \cap \mathcal{H}_n$, so $|\mathcal{L}_n| > (1 - e^{-\Omega(n)}) |\mathcal{P}(n, m)|$. Thus, $\exists N = N(b, B)$ such that $|\mathcal{L}_n| > \frac{1}{2} |\mathcal{P}(n, m)| \forall n \geq N$.

Let $n \geq N$ and let $\mathcal{L}_{n,k}$ denote the set of graphs in \mathcal{L}_n with exactly k components. If $2 \leq k+1 \leq \frac{\alpha n}{6}$, we may construct a graph in $\mathcal{L}_{n,k}$ from a graph in $\mathcal{L}_{n,k+1}$ by the following method (see Figure 16): choose a graph $G \in \mathcal{L}_{n,k+1}$; choose an appearance of H in G and delete the edge corresponding to f in this appearance (we have at least $\frac{\alpha n}{2} + 3(k+1) \geq \frac{\alpha n}{2}$ choices for this edge, since clearly all appearances of H are disjoint, by 2-edge-connectivity); and insert an edge between two vertices in different components, making sure that we don’t interfere with a vertex that was in our chosen appearance of H (we have a_k , say, choices for this edge).

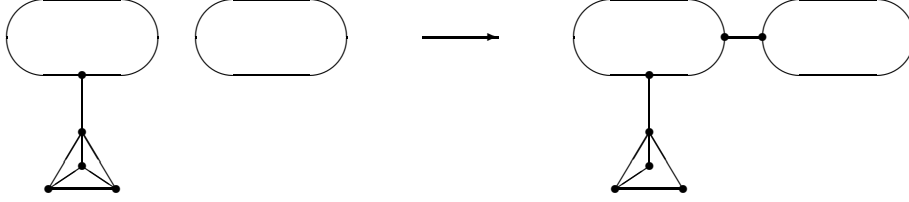

Figure 16: Constructing a graph in $\mathcal{L}_{n,k}$ from a graph in $\mathcal{L}_{n,k+1}$.

It is clear that the number of components in our new graph, G' , will be k . Also, we have $f_H(G') \geq \frac{\alpha n}{2} + 3(k+1) - 3 = \frac{\alpha n}{2} - 3k$ (since we had $f_H(G) \geq \frac{\alpha n}{2} + 3(k+1)$), we deliberately interfered with one appearance in the set Z , and we may have interfered with at most two more when we inserted an edge). Thus, our new graph is indeed in $\mathcal{L}_{n,k}$.

Note that the number of possible edges between disjoint sets X and Y is $|X||Y|$ and that if $|X| \leq |Y|$ then $|X||Y| > (|X| - 1)(|Y| + 1)$, so it follows that the number of choices for the edge to insert is minimized when the $n - |H|$ vertices that are not in our chosen appearance of H are k isolated vertices and one component of $n - |H| - k$ vertices. Thus, $a_k \geq \binom{k}{2} + k(n - |H| - k)$. Hence, we have created at least $|\mathcal{L}_{n,k+1}| \frac{\alpha n}{2} \left(\binom{k}{2} + k(n - |H| - k) \right)$ graphs in $\mathcal{L}_{n,k}$.

Given one of our created graphs in $\mathcal{L}_{n,k}$, there are at most $6n$ possibilities for where the deleted edge was originally, since it must have been in what is now an appearance of $H - f$ (and clearly $f_{H-f}(G') \leq 2m$, since each edge in G' can only be the cut-edge for at most 2 appearances). There are then b_k , say, possibilities for which was the inserted edge. Since this edge must be a cut-edge that doesn't interfere with the appearance of $H - f$, we have $b_k \leq n - |H| - k$ (since the number of edges in a spanning forest of a graph with k components and $n - |H|$ vertices is $n - |H| - k$). Hence, we have built each graph at most $6n(n - |H| - k)$ times.

Clearly, $\frac{|\mathcal{L}_{n,k+1}| \frac{1}{2} \alpha n \left(\binom{k}{2} + k(n - |H| - k) \right)}{6n(n - |H| - k)} \geq \frac{1}{12} |\mathcal{L}_{n,k+1}| \alpha k$. Thus, for $2 \leq k+1 \leq \frac{\alpha n}{6}$, we have $|\mathcal{L}_{n,k+1}| \leq \frac{12 |\mathcal{L}_{n,k}|}{\alpha k}$.

Let $p_k = \frac{|\mathcal{L}_{n,k+1}|}{|\mathcal{L}_n|}$ and let $p = p_0 = \frac{|\mathcal{L}_{n,1}|}{|\mathcal{L}_n|}$. Then (remembering that $|\mathcal{L}_{n,k+1}| = 0$ for $k+1 > \frac{\alpha n}{6}$), we have $p_k \leq \frac{p(\frac{12}{\alpha})^k}{k!} \forall k$. Since $\sum_{k \geq 0} p_k = 1$, we must have $\sum_{k \geq 0} \frac{p(\frac{12}{\alpha})^k}{k!} \geq 1$ and so $p \geq \left(\sum_{k \geq 0} \frac{(\frac{12}{\alpha})^k}{k!} \right)^{-1} = e^{-\frac{12}{\alpha}}$.

Since $\mathcal{L}_n > \frac{1}{2}|\mathcal{P}(n,m)|$ and $\mathcal{L}_{n,1} \subset \mathcal{P}_c(n,m)$, we have $\frac{|\mathcal{P}_c(n,m)|}{|\mathcal{P}(n,m)|} \geq \frac{|\mathcal{L}_{n,1}|}{2|\mathcal{L}_n|} = \frac{p}{2} \geq \frac{1}{2}e^{-\frac{12}{\alpha}}$. Thus, $\mathbf{P}[P_{n,m} \text{ will be connected}] \geq \frac{1}{2}e^{-\frac{12}{\alpha(b,B)}} > 0 \quad \forall n \geq N(b,B)$.

Clearly, $|\mathcal{P}_c(n,m)| > 1 \quad \forall n$. Thus, for all n we have

$$\mathbf{P}[P_{n,m} \text{ will be connected}] \geq c(b,B) = \min \left\{ \frac{e^{-\frac{12}{\alpha(b,B)}}}{2}, \min_{n < N(b,B)} \frac{1}{|\mathcal{P}(n,m)|} \right\} > 0. \square$$

The proof of Lemma 42 may seem unnecessarily complicated, but this is due to the fact that we only know $\mathbf{P}[f_H(P_{n,m}) > \beta n] \rightarrow 1$ rather than that $\mathbf{P}[f_H(P_{n,m}) > \beta n \mid \kappa(P_{n,m}) = k+1] \rightarrow 1$ (in fact, the second result is trivially false if $k+1 = n$, for example). Thus, if we let $\mathcal{P}(n,m,r)$ denote $\{G \in \mathcal{P}(n,m) : \kappa(G) = r\}$, then although we could have used our construction to obtain a lower bound for $\frac{|\{G \in \mathcal{P}(n,m,k+1) : f_H(G) > \beta n\}|}{|\mathcal{P}(n,m,k)|}$, this would not have given us a lower bound for $\frac{|\mathcal{P}(n,m,k+1)|}{|\mathcal{P}(n,m,k)|}$. Hence, we had to instead aim to obtain a lower bound for $\frac{|\{G \in \mathcal{P}(n,m,k+1) : f_H(G) \text{ is 'large'}\}|}{|\{G \in \mathcal{P}(n,m,k) : f_H(G) \text{ is 'large'}\}|}$, and it is then clear that our construction forces us to define ‘large’ to be something like $\frac{\alpha n}{2} + 3\kappa(G)$, rather than αn , which in turn forced us to use Lemma 41 to make sure that $\frac{|\{G \in \mathcal{P}(n,m) : f_H(G) \text{ is 'large'}\}|}{|\mathcal{P}(n,m)|}$ is bounded away from 0.

We will now see an analogous result to Lemma 42 for when $\frac{m}{n}$ is close to 3. The main difference in the construction is that instead of removing edges from suitable appearances, we shall now remove edges from suitable triangles. Also, we will work with the entire set of disconnected graphs at once, rather than conditioning on the exact number of components.

Lemma 43 *Let $C \in (\frac{41}{14}, 3]$ and let $m = m(n) \in [Cn - o(n), 3n - 6]$. Then*

$$\limsup_{n \rightarrow \infty} \mathbf{P}[P_{n,m} \text{ will not be connected}] \leq \frac{15(3 - C)}{\frac{2}{7} - 12 + 4C}.$$

Proof Let $G \in \mathcal{P}(n, m)$ and let us consider how many triangles in G contain at least one vertex with degree ≤ 6 . We shall call such triangles ‘good’ triangles.

First, note that (assuming $n \geq 3$) G may be extended to a triangulation by inserting $3n - 6 - m \leq (3 - C)n + o(n)$ ‘phantom’ edges. Let d_i denote the number of vertices of degree i in such a triangulation. Then $7 \sum_{i \geq 7} d_i \leq \sum_{i \geq 1} i d_i = 2(3n - 6)$. Thus, $\sum_{i \geq 7} d_i < \frac{6n}{7}$ and so $\sum_{i \leq 6} d_i > \frac{n}{7}$.

For $n > 3$, each of these vertices of small degree will be in at least three faces of the triangulation, all of which will be good triangles. This counts each good triangle at most three times (once for each vertex), so our triangulation must have at least $3 \cdot \frac{n}{7} \cdot \frac{1}{3} = \frac{n}{7}$ good triangles that are *faces*. Each of our phantom edges is in exactly two faces of the triangulation, so our original graph G must contain at least $\frac{n}{7} - 2(3 - C)n + o(n)$ of our good triangles (note that these triangles will still be ‘good’, since the degrees of the vertices will be at most what they were in the triangulation).

We will now consider how many cut-edges a graph in $\mathcal{P}(n, m)$ may have. If we delete all c cut-edges, then the remaining graph will consist of b , say, blocks, each of which is either 2-edge-connected or is an isolated vertex. Note that the graph formed by condensing each block to a single node and re-inserting the cut-edges must be acyclic, so $c \leq b - 1$. Label the blocks $1, 2, \dots, b$ and let n_i denote the number of vertices in block i . Then the number of edges in block i is at most $3n_i - 6$ if $n_i \geq 3$ and is $0 = 3n_i - 3$ otherwise (since $n_i < 3$ implies that $n_i = 1$). Thus, $m \leq \sum_{i=1}^b (3n_i - 3) + c = 3n - 3b + c < 3n - 2c$, and so $c < \frac{3n - m}{2} < \frac{(3 - C)n}{2} + o(n)$.

We now come to the main part of the proof. Let \mathcal{G}_n denote the set of graphs in $\mathcal{P}(n, m)$ that are not connected, and choose a graph $G \in \mathcal{G}_n$. Choose a good triangle in G (at least $\frac{n}{7} - 2(3 - C)n + o(n)$ choices) and delete an edge that is

opposite a vertex with degree ≤ 6 . Then insert an edge between two vertices in different components (we have a , say, choices for this edge).

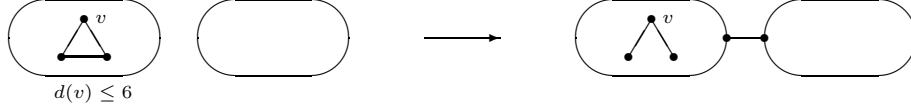

Figure 17: Constructing our new graph.

As mentioned in the previous proof, the number of possible edges between disjoint sets X and Y is $|X||Y|$ and if $|X| \leq |Y|$ then $|X||Y| > (|X| - 1)(|Y| + 1)$, so it follows that the number of choices for the edge to insert is minimized when we have one isolated vertex and one component of $n - 1$ vertices. Thus, $a \geq n - 1$ and so we have created at least $|\mathcal{G}_n| \left(\frac{n}{7} - 2(3 - C)n + o(n) \right) (n - 1)$ graphs in $\mathcal{P}(n, m)$.

Given one of our created graphs, there are at most $\frac{(3-C)n}{2} + o(n)$ possibilities for which edge was inserted, since it must be a cut-edge. There are then at most $\binom{6}{2} n$ possibilities for where the deleted edge was originally, since it must have been between two neighbours of a vertex with degree ≤ 6 (we have at most n possibilities for this vertex and then at most $\binom{6}{2}$ possibilities for its neighbours). Hence, we have built each graph at most $\frac{15(3-C)n^2}{2} + o(n^2)$ times.

Thus, $|\mathcal{P}(n, m)| \geq \frac{(\frac{1}{7} - 2(3-C))n^2 + o(n^2)}{\frac{15(3-C)n^2}{2} + o(n^2)} |\mathcal{G}_n|$ and so

$$\begin{aligned} \frac{|\mathcal{G}_n|}{|\mathcal{P}(n, m)|} &\leq \frac{\frac{15(3-C)n^2}{2} + o(n^2)}{\left(\frac{1}{7} - 2(3-C)\right)n^2 + o(n^2)} \quad \text{since } \frac{1}{7} - 2(3-C) > 0 \text{ for } C > \frac{41}{14} \\ &\rightarrow \frac{15(3-C)}{\frac{2}{7} - 12 + 4C} \quad \text{as } n \rightarrow \infty. \quad \square \end{aligned}$$

We may now combine Lemmas 42 and 43 to obtain our first main result:

Theorem 44 *Let $b > 1$ and let $m = m(n) \in [bn, 3n - 6]$. Then $\exists c(b) > 0$ such that*

$$\mathbf{P}[P_{n,m} \text{ will be connected}] > c \quad \forall n.$$

Proof Clearly, $\exists C < 3$ such that $\frac{15(3-C)}{4-12+4C} < 1$. Thus, by considering separately the values of n for which $m(n) \in [bn, Cn]$ and the values for which $m(n) \in [Cn, 3n - 6]$, the result follows from Lemmas 42 and 43. \square

As a Corollary to Lemma 43, by taking $C = 3$, we also obtain the following result:

Corollary 45 *Let $m = m(n) = 3n - o(n)$. Then*

$$\mathbf{P}[P_{n,m} \text{ will be connected}] \rightarrow 1 \text{ as } n \rightarrow \infty.$$

As mentioned, we shall now take a break from the main themes of Part I to observe that the proofs of this section can be used to obtain bounds on $\kappa(P_{n,m})$. We start by observing what was implicitly shown about $\kappa(P_{n,m})$ in the proof of Lemma 42:

Lemma 46 *Let $m = m(n)$ satisfy $1 < \liminf_{n \rightarrow \infty} \frac{m}{n} \leq \limsup_{n \rightarrow \infty} \frac{m}{n} < 3$. Then there exists a constant K such that*

$$\mathbf{E}[\kappa(P_{n,m})] < K \forall n.$$

Proof Clearly, it suffices to prove that the result holds for all sufficiently large n . We define \mathcal{L}_n as in the proof of Lemma 42 and recall that, by Lemmas 13 and 41, we have $|\mathcal{L}_n| > (1 - e^{-\Omega(n)}) |\mathcal{P}(n, m)|$. Thus,

$$\begin{aligned} \mathbf{E}[\kappa(P_{n,m})] &= \mathbf{P}[P_{n,m} \in \mathcal{L}_n] \cdot \mathbf{E}[\kappa(P_{n,m}) | P_{n,m} \in \mathcal{L}_n] \\ &\quad + \mathbf{P}[P_{n,m} \notin \mathcal{L}_n] \cdot \mathbf{E}[\kappa(P_{n,m}) | P_{n,m} \notin \mathcal{L}_n] \\ &\leq \mathbf{E}[\kappa(P_{n,m}) | P_{n,m} \in \mathcal{L}_n] + e^{-\Omega(n)} n \\ &= \mathbf{E}[\kappa(P_{n,m}) | P_{n,m} \in \mathcal{L}_n] + e^{-\Omega(n)}. \end{aligned}$$

It now only remains to show that $\mathbf{E}[\kappa(P_{n,m})|P_{n,m} \in \mathcal{L}_n]$ is bounded by a constant. But recall we showed in the proof of Lemma 42 that $|\mathcal{L}_{n,k+1}| \leq \frac{12|\mathcal{L}_{n,k}|}{\alpha k} \forall k$, for a suitable constant α . Thus, we have $\mathbf{E}[\kappa(P_{n,m})|P_{n,m} \in \mathcal{L}_n] \leq \mathbf{E}[X]$, where $X \sim \text{Poi}(\frac{12}{\alpha})$. Since $\mathbf{E}[X] = \frac{12}{\alpha}$, we are done. \square

Similarly, we may obtain a result for when $\frac{m}{n}$ is close to 3, by analysing the proof of Lemma 43:

Lemma 47 *Let $C \in (\frac{41}{14}, 3]$ and let $m = m(n) \in [Cn - o(n), 3n - 6]$. Then there exists a constant K such that*

$$\mathbf{E}[\kappa(P_{n,m})] < K \forall n.$$

Proof Again, it suffices to prove that the result holds for all sufficiently large n . Let $\mathcal{G}_{n,k}$ denote the set of graphs in $\mathcal{P}(n, m)$ with exactly k components. We follow the proof of Lemma 43 to construct graphs in $\mathcal{G}_{n,k}$ from graphs in $\mathcal{G}_{n,k+1}$. The details are as before, except that the number of ways to insert an edge between two vertices in different components is now $\binom{k}{2} + k(n-k)$. Thus, we obtain

$$\begin{aligned} \frac{|\mathcal{G}_{n,k+1}|}{|\mathcal{G}_{n,k}|} &\leq \frac{\frac{15(3-C)n^2}{2} + o(n^2)}{(\frac{1}{7} - 2(3-C))kn^2 + o(n^2)} \\ &\rightarrow \frac{15(3-C)}{(\frac{2}{7} - 12 + 4C)k} \quad \text{as } n \rightarrow \infty. \end{aligned}$$

Therefore, for sufficiently large n , we have $\mathbf{E}[\kappa(P_{n,m})] \leq \mathbf{E}[X]$, where $X \sim \text{Poi}(\lambda)$ for any $\lambda > \frac{15(3-C)}{\frac{2}{7} - 12 + 4C}$. But $\mathbf{E}[X] = \lambda$, and so we are done. \square

We may combine Lemmas 46 and 47:

Proposition 48 *Let $m = m(n)$ satisfy $\liminf_{n \rightarrow \infty} \frac{m}{n} > 1$. Then there exists a constant K such that*

$$\mathbf{E}[\kappa(P_{n,m})] < K \forall n.$$

By Markov's inequality, we also obtain the following result, which improves on Lemma 41 (in terms of decreasing the bound on $\kappa(P_{n,m})$) for the case when $\liminf_{n \rightarrow \infty} \frac{m}{n} > 1$:

Corollary 49 *Let $m = m(n)$ satisfy $\liminf_{n \rightarrow \infty} \frac{m}{n} > 1$ and let $g(n) \rightarrow \infty$ as $n \rightarrow \infty$. Then*

$$\mathbf{P}[\kappa(P_{n,m}) < g(n)] \rightarrow 1 \text{ as } n \rightarrow \infty.$$

We shall shortly give a summary of all our results on $\kappa(P_{n,m})$, but first let us obtain one final bound, for when $m < n$ (this will in fact be useful later on, in Section 10):

Proposition 50 *Let $m = m(n) \in [qn, n - 1]$ for some fixed $q \in (0, 1)$ and let the constant c satisfy $c > \ln\left(\frac{2}{q}\right) + e^{-1}$. Then*

$$\mathbf{P}\left[\kappa(P_{n,m}) > \left\lceil \frac{cn}{\ln n} + n - m \right\rceil\right] = e^{-\Omega(n)}.$$

Proof Note that $\mathbf{P}\left[\kappa(P_{n,m}) > \left\lceil \frac{cn}{\ln n} + n - m \right\rceil\right] = \frac{|\{G \in \mathcal{P}(n,m) : \kappa(G) > \left\lceil \frac{cn}{\ln n} + n - m \right\rceil\}|}{|\mathcal{P}(n,m)|}$, by definition. We shall obtain bounds for both parts of this fraction by following the proof of Proposition 12 ([8], 6.6), which deals with the case when $m = n - (\beta + o(1))(n/\ln n)$ for fixed $\beta > 0$.

Let $x = x(n) = n - m$ and let $k = k(n) = \left\lceil \frac{cn}{\ln n} + x \right\rceil$. Then

$$|\{G \in \mathcal{P}(n, m) : \kappa(G) > k\}| \leq |\{G \in \mathcal{P}(n) : \kappa(G) > k\}| \leq \frac{|\mathcal{P}(n)|}{k!},$$

using Proposition 5.

Let $\mathcal{F}(i, j)$ denote the set of forests with i vertices and j edges. Then

$$\begin{aligned} |\mathcal{P}(n, m)| &\geq |\mathcal{F}(n, m)| \\ &\geq |\mathcal{F}(m+1, m)|, \quad \text{since } n \geq m+1 \\ &\quad \text{(consider adding } n - (m+1) \text{ isolated vertices)} \\ &\geq (m+1)^{m-1}, \quad \text{by Cayley's Theorem.} \end{aligned}$$

Thus,

$$\mathbf{P}[\kappa(P_{n,m}) > k] \leq \frac{|\mathcal{P}(n)|}{k!(m+1)^{m-1}}.$$

Note that

$$\begin{aligned} \ln((m+1)^{m-1}) &= (m-1)\ln(m+1) \\ &= m\ln(m+1) + o(n) \\ &= m\ln n + m\ln\left(\frac{m+1}{n}\right) + o(n) \\ &\geq m\ln n + m\ln q + o(n) \\ &\geq m\ln n + n\ln q + o(n), \text{ since } q < 1 \end{aligned} \quad (10)$$

Also, note that

$$\begin{aligned} k \ln k - x \ln n &= (k-x)\ln n + k \ln k - k \ln n \\ &= (k-x)\ln n - n \frac{\ln\left(\frac{n}{k}\right)}{\frac{n}{k}} \\ &\geq (k-x)\ln n - ne^{-1}, \quad \text{since } \frac{\ln y}{y} \leq e^{-1} \forall y \\ &= \frac{cn}{\ln n} \ln n - ne^{-1} + o(n) \text{ by definition of } k \\ &= (c - e^{-1})n + o(n). \end{aligned}$$

Thus, we have

$$\begin{aligned} &\limsup_{n \rightarrow \infty} \frac{|\mathcal{P}(n)|}{k!(m+1)^{m-1}} \\ &\leq \frac{(\gamma_l)^n n!}{\left(\frac{k}{e}\right)^k e^{m\ln n + n\ln q + o(n)}}, \quad \text{by Proposition 1, Stirling's formula and (10)} \\ &= \exp(n \ln \gamma_l + n \ln n - n + k - k \ln k - m \ln n - n \ln q + o(n)), \\ &\quad \text{using Stirling's formula for } n! \\ &= \exp(n \ln \gamma_l - n + k - k \ln k + x \ln n - n \ln q + o(n)), \quad \text{by definition of } x \\ &\leq \exp(n \ln \gamma_l - n + k - (c - e^{-1})n - n \ln q + o(n)), \quad \text{by (11)} \\ &\leq \exp\left(n \left(\ln\left(\frac{\gamma_l}{q}\right) - c + e^{-1} + o(1)\right)\right), \quad \text{since } k \leq n + o(n) \\ &= e^{-\Omega(n)}, \quad \text{since } c > \ln\left(\frac{\gamma_l}{q}\right) + e^{-1}. \quad \square \end{aligned}$$

Summary of Results on the Number of Components

$\exists \lambda > 0$ such that

$$\kappa(P_{n,m}) \geq \begin{cases} n - m & \forall m \quad (\text{trivial observation}) \\ \lambda n^{1/2} \text{ a.a.s.} & \text{if } |m - n| = O(n^{1/2}) \quad (\text{Theorems 38 and 24}) \\ \lambda \frac{n}{d} \text{ a.a.s.} & \text{if } d = m - n > 0 \text{ is such that } d = \Omega(n^{1/2}) \text{ and } O(n) \\ & (\text{Theorems 38 and 25}) \end{cases}$$

and $\exists c$ such that

$$\kappa(P_{n,m}) \leq \begin{cases} n - m + \frac{cn}{\ln n} \text{ a.a.s.} & \text{if } 0 < q \leq \frac{m}{n} < 1 \quad (\text{Proposition 50}) \\ \frac{cn}{\ln n} \text{ a.a.s.} & \text{if } \frac{m}{n} \geq 1 \quad (\text{Lemma 41}) \\ g(n) \text{ a.a.s.} & \text{if } \liminf_{n \rightarrow \infty} \frac{m}{n} > 1 \quad (\text{Corollary 49}) \\ & (\text{where } g \text{ is any function with } g(n) \rightarrow \infty) \end{cases}$$

These results may be represented as below, where ϵ is an arbitrarily small positive constant:

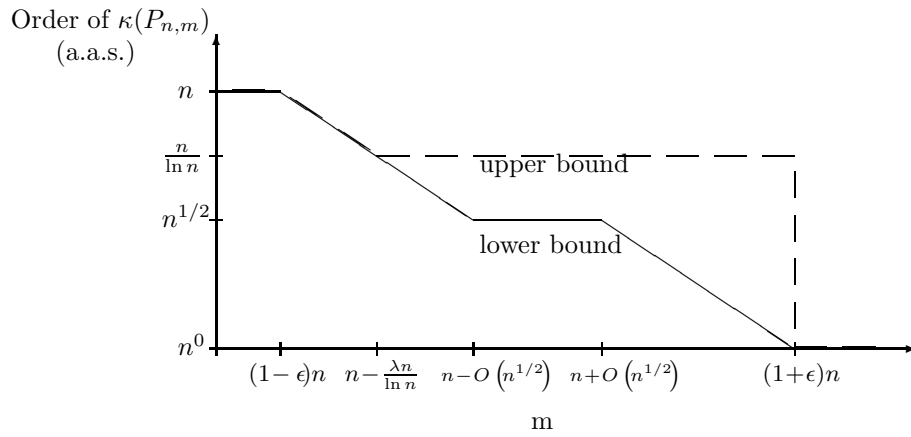

Figure 18: Summary of results on the number of components.

8 Components II: Upper Bounds

We now return to looking at $\mathbf{P}[P_{n,m}$ will have a component isomorphic to $H]$. Note that we already have a full description (in terms of knowing exactly when the probability is or isn't bounded away from 0 or 1) for when H is a tree, by combining the lower bounds of Section 6 with the upper bounds implied by our results on $\mathbf{P}[P_{n,m}$ will be connected]. In this section, we will complete matters by obtaining further upper bounds for when H is not acyclic.

First, we will look at the case when H is 'multicyclic', i.e. when it has more edges than vertices. We have already seen (in Theorems 36 and 44) that the probability of $P_{n,m}$ containing H as a component is bounded away from both 0 and 1 for large n if $\frac{m}{n}$ is bounded below by $b > 1$ and above by $B < 3$, and (from Corollary 45) that the probability converges to 0 if $\frac{m}{n} \rightarrow 3$. We shall now see (in Theorem 51) that the limiting probability is also 0 if $\frac{m}{n} \leq 1 + o(1)$.

We shall then look at the case when H is unicyclic. We have already seen (in Corollary 45) that the probability of $P_{n,m}$ containing H as a component tends to 0 if $\frac{m}{n} \rightarrow 3$, that (in Theorem 37) it is bounded away from 0 for large n if $\frac{m}{n}$ is bounded away from both 0 and 3, and (in Theorem 44) that it is bounded away from 1 if $\frac{m}{n}$ is bounded below by $b > 1$. In this section, we shall complete the picture by seeing (in Lemma 52) that, in fact, the probability is *always* bounded away from 1 for large n .

We shall finish this section (in Theorem 53) with an extension of Lemma 52 in which we will show that, for any fixed k , the probability that $P_{n,m}$ will contain *any* unicyclic or multicyclic components of order $\leq k$ is also always bounded away from 1 for large n .

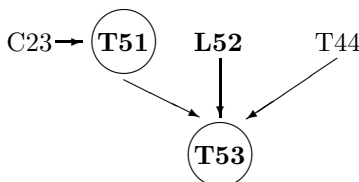

Figure 19: The structure of Section 8.

We start with our aforementioned result for multicyclic components:

Theorem 51 *Let $m \leq (1 + o(1))n$ and let H be a (fixed) multicyclic connected planar graph. Then*

$$\mathbf{P}[P_{n,m} \text{ will have a component isomorphic to } H] \rightarrow 0 \text{ as } n \rightarrow \infty.$$

Proof Let \mathcal{G}_n denote the set of graphs in $\mathcal{P}(n, m)$ with a component isomorphic to H . For each graph $G \in \mathcal{G}_n$, let us delete 2 edges from a component $H' (= H'_G)$ isomorphic to H in such a way that we do not disconnect the component. Let us then insert one edge between a vertex in the remaining component and a vertex elsewhere in the graph. We have $|H|(n - |H|)$ ways to do this, and planarity is maintained. Let us then also insert one other edge into the graph, without violating planarity. We have at least $\text{add}(n, m) = \omega(n)$ choices for where to place this second edge, by Corollary 23. Thus, we can construct $|\mathcal{G}_n| \omega(n^2)$ (not necessarily distinct) graphs in $\mathcal{P}(n, m)$.

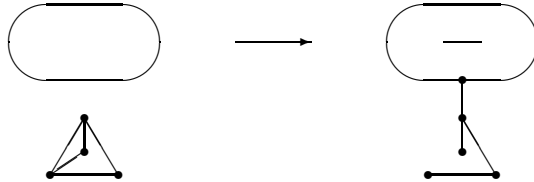

Figure 20: Redistributing edges from our multicyclic component.

Given one of our constructed graphs, there are $m = O(n)$ possibilities for the edge that was inserted last. There are then at most $m - 1 = O(n)$ possibilities for the other edge that was inserted. Since one of the two vertices incident with this edge must belong to $V(H')$, we then have at most two possibilities for $V(H')$ and then at most $\binom{|H'|}{2} = O(1)$ possibilities for $E(H')$. Thus, we have built each graph at most $O(n^2)$ times, and so $\frac{|\mathcal{G}_n|}{|\mathcal{P}(n, m)|} = \frac{O(n^2)}{\omega(n^2)} \rightarrow 0$ as $n \rightarrow \infty$. \square

We shall now look at unicyclic components. The basic argument will be the same as that of Theorem 51, i.e. we will start with \mathcal{G}_n , the set of graphs in $\mathcal{P}(n, m)$ with a component isomorphic to H , and redistribute edges from such components to construct other graphs in $\mathcal{P}(n, m)$. This time we will only be able to delete one edge from each component, and so we will only be able to show $\frac{|\mathcal{G}_n|}{|\mathcal{P}(n, m)|} = O(1)$, rather than $o(1)$. Hence, it will be crucial to keep track of the constants involved in the calculations, so that we can try to show $\limsup_{n \rightarrow \infty} \frac{|\mathcal{G}_n|}{|\mathcal{P}(n, m)|} < 1$. Unfortunately, it turns out that the constants are actually only small enough for certain H , such as when H is a cycle. However, it is simple to relate the probability that a given component is isomorphic to H to the probability that it is a cycle, and so we may deduce that the result actually holds for any unicyclic H .

A further complication is that we will actually prove a stronger version of Lemma 52 than that advertised at the start of this section, involving many unicyclic graphs at once, in preparation for Theorem 53.

Lemma 52 *Let k be a fixed constant. Then, given any $m(n)$,*

$$\limsup_{n \rightarrow \infty} \mathbf{P}[P_{n, m} \text{ will contain any unicyclic components of order } \leq k] < 1.$$

Sketch of Proof Let C_i be used to denote a component that is a cycle of order i and let H_i be used to denote all other unicyclic components of order i .

Step 1: By an induction hypothesis, we may assume that there is a decent proportion of graphs with no unicyclic components of order $< l$.

Step 2: If we have a C_l , we may remove an edge from it and then insert an edge between the remainder of the cycle and the rest of the graph, analogously to the proof of Theorem 51. We find that we may create so many graphs by doing this that the proportion of graphs *without* a C_l (and still with no unicyclic components of order $< l$) must be quite decent.

Step 3: We then show that the proportion of graphs with lots of H_l 's and no C_l 's is small. Thus, using the result of Step 2, there must be a decent proportion of graphs with few H_l 's, no C_l 's and no unicyclic components of order $< l$.

Step 4: We replace the few H_l 's with C_l 's to obtain a decent proportion of graphs with no H_l 's and no unicyclic components of order $< l$.

Step 5: We then repeat the argument of Step 2 to find that the proportion of graphs without a C_l , and still with no H_l 's and no unicyclic components of order $< l$, must be quite decent. Thus, we have a decent proportion of graphs with no unicyclic components of order $\leq l$, and so we are done by induction.

Full Proof For $\mathcal{A}_n \subset \mathcal{P}(n, m)$, we shall use \mathcal{A}_n^c to denote the set of graphs in $\mathcal{P}(n, m)$ that are not in \mathcal{A}_n .

Step 1

We will prove the result by induction on k . It is trivial for $k = 2$. Let us assume that the result is true for $k = l - 1$.

Let \mathcal{L}_n denote the set of graphs in $\mathcal{P}(n, m)$ with no unicyclic component of order $< l$. Then, by our induction hypothesis, $\exists \epsilon(l) > 0$ such that $|\mathcal{L}_n| \geq \epsilon |\mathcal{P}(n, m)|$ for all sufficiently large n .

Step 2

Let \mathcal{G}_n denote the set of graphs in \mathcal{L}_n with a component isomorphic to C_l , the cycle of order l . For each graph $G \in \mathcal{G}_n$, let us delete an edge from a component $C' (= C'_G)$ isomorphic to C_l , leaving a spanning path. We have l choices for this edge. Let us then insert an edge between a vertex in the spanning path and a vertex elsewhere. We have $l(n - l)$ ways to do this, planarity is maintained, and no unicyclic components of order $< l$ will be created, since the only new component will have order $> l$. Thus, we have constructed $|\mathcal{G}_n| l^2 (n - l)$ graphs

in \mathcal{L}_n .

Given one of our constructed graphs, there are at most $n - 1$ possibilities for which is the inserted edge, since it must be a cut-edge. There are then at most 2 possibilities for $V(C')$ (at most one possibility for each endpoint of the edge), and then only one possibility for where the inserted edge was originally. Thus, we have built each graph at most $2(n - 1)$ times.

Therefore, $|\mathcal{G}_n| \leq \frac{2(n-1)}{l^2(n-l)}|\mathcal{L}_n|$. Thus, for any fixed constant $\delta \in (0, 1 - \frac{2}{l^2})$, we have $|\mathcal{G}_n| < (1 - \delta)|\mathcal{L}_n|$ for all sufficiently large n , and so we have $|\mathcal{L}_n \cap \mathcal{G}_n^c| > \delta|\mathcal{L}_n| \geq \delta\epsilon|\mathcal{P}(n, m)|$ for all sufficiently large n .

Step 3

Let $r = r(l) > \frac{4 \binom{l}{2}}{\delta\epsilon(l-1)!}$ and let \mathcal{J}_n denote the set of graphs in $\mathcal{P}(n, m)$ with $> r$ unicyclic components of order l .

Consider the set $\mathcal{J}_n \cap \mathcal{G}_n^c$, i.e. the set of graphs in $\mathcal{P}(n, m)$ with $> r$ unicyclic components of order l , but no components isomorphic to C_l . For each graph $J \in \mathcal{J}_n \cap \mathcal{G}_n^c$, delete a unicyclic component of order l (we have $> r$ choices for this) and replace it with a component isomorphic to C_l (we have $\frac{(l-1)!}{2}$ choices for this). We have constructed at least $|\mathcal{J}_n \cap \mathcal{G}_n^c| \frac{r(l-1)!}{2}$ (not necessarily distinct) graphs in $\mathcal{P}(n, m)$.

Given one of our constructed graphs, there are at most $\binom{l}{2}$ possibilities for what the component isomorphic to C_l was originally, since it must have been a component with l edges. Thus, we have built each graph at most $\binom{l}{2}$ times,

and so $|\mathcal{J}_n \cap \mathcal{G}_n^c| \leq \frac{2 \binom{l}{2} |\mathcal{P}(n, m)|}{r(l-1)!} < \frac{\delta\epsilon}{2} |\mathcal{P}(n, m)|$, since $r > \frac{4 \binom{l}{2}}{\delta\epsilon(l-1)!}$.

Since we also know (from Step 2) that $|\mathcal{L}_n \cap \mathcal{G}_n^c| > \delta\epsilon|\mathcal{P}(n, m)|$ for all sufficiently large n , we must have $|\mathcal{L}_n \cap \mathcal{J}_n^c \cap \mathcal{G}_n^c| > \frac{\delta\epsilon}{2} |\mathcal{P}(n, m)|$. Thus, $|\mathcal{L}_n \cap \mathcal{J}_n^c| > \frac{\delta\epsilon}{2} |\mathcal{P}(n, m)|$ for all sufficiently large n .

Step 4

Let \mathcal{H}_n denote the set of graphs in $\mathcal{P}(n, m)$ with a unicyclic component of order l that is not isomorphic to C_l , and recall that $\mathcal{L}_n \cap \mathcal{J}_n^c$ is the set of graphs in $\mathcal{P}(n, m)$ with no unicyclic component of order $< l$ and with $\leq r$ unicyclic components of order l . For each graph $L \in \mathcal{L}_n \cap \mathcal{J}_n^c$, delete all the unicyclic components of order l and replace them with components isomorphic to C_l . Thus, we have constructed at least $|\mathcal{L}_n \cap \mathcal{J}_n^c|$ (not necessarily distinct) graphs in $\mathcal{L}_n \cap \mathcal{H}_n^c$.

Suppose we are given one of our constructed graphs and suppose it has exactly s components that are isomorphic to C_l (note that $s \leq r$). The ls vertices in these components must all have been in unicyclic components originally, so there are at most $\binom{\binom{ls}{2}}{ls} \leq (ls)^{2ls} \leq (lr)^{2lr}$ possibilities for what the original graph was.

Thus,

$$\begin{aligned} |\mathcal{L}_n \cap \mathcal{H}_n^c| &\geq \frac{|\mathcal{L}_n \cap \mathcal{J}_n^c|}{(lr)^{2lr}} \\ &> \frac{\delta\epsilon|\mathcal{P}(n, m)|}{2(lr)^{2lr}} \text{ for all sufficiently large } n, \text{ by Step 3} \\ &= \lambda|\mathcal{P}(n, m)|, \text{ where } \lambda = \frac{\delta\epsilon}{2(lr)^{2lr}}. \end{aligned}$$

Step 5

By applying the same argument as in Step 2, but to $\mathcal{L}_n \cap \mathcal{H}_n^c$ rather than \mathcal{L}_n , we may obtain $|\mathcal{L}_n \cap \mathcal{H}_n^c \cap \mathcal{G}_n^c| > \delta'|\mathcal{L}_n \cap \mathcal{H}_n^c| \geq \delta'\lambda|\mathcal{P}(n, m)|$, where δ' is a suitable positive constant. But $\mathcal{L}_n \cap \mathcal{H}_n^c \cap \mathcal{G}_n^c$ is the set of graphs in $\mathcal{P}(n, m)$ with no unicyclic components of order $\leq l$. Thus, the induction hypothesis holds for $k = l$, and so we are done. \square

By using Theorems 44 and 51, we may extend Lemma 52 to cover all *non-acyclic* components of order $\leq k$:

Theorem 53 *Let k be a fixed constant. Then, given any $m(n)$,*

$$\limsup_{n \rightarrow \infty} \mathbf{P}[P_{n,m} \text{ will contain any non-acyclic components of order } \leq k] < 1.$$

Proof We shall suppose, hoping for a contradiction, that there exists a function $m(n)$ such that $\limsup_{n \rightarrow \infty} \mathbf{P}[P_{n,m} \text{ will contain any non-acyclic components of order } \leq k] = 1$. Thus, there exists an infinite subsequence n_1, n_2, \dots such that $\mathbf{P}[P_{n_i, m(n_i)} \text{ will contain any non-acyclic components of order } \leq k] \rightarrow 1$ as $i \rightarrow \infty$.

Clearly, by combining Theorem 51 with Lemma 52, we can't have $m(n_i) \leq (1 + o(1))n_i$ as $i \rightarrow \infty$. Thus, $\exists \epsilon > 0$ such that $m(n_i) \geq (1 + \epsilon)n_i$ for arbitrarily many values of i . But then this contradicts Theorem 44, where we showed that the probability of $P_{n,m}$ being connected is bounded away from 0 for such n . \square

9 General Subgraphs & Acyclic Subgraphs

We have now finished looking at when $P_{n,m}$ will contain given components. In the remainder of Part I, we shall instead look at the probability that $P_{n,m}$ will contain a given (not necessarily connected) *subgraph*.

In this section, we will see (in Theorem 61) that the limiting probability is 1 if $\liminf_{n \rightarrow \infty} \frac{m}{n} > 1$. We shall then see (in Theorem 63) that this result can be extended to $\liminf_{n \rightarrow \infty} \frac{m}{n} > 0$ if the subgraph is acyclic.

The proof of Theorem 61 will be in two parts, Lemmas 56 and 60, dealing with the cases when $\frac{m}{n}$ is or isn't, respectively, bounded away from 3.

We will first see (in Lemma 56) that the part of the result dealing with the case when $\limsup_{n \rightarrow \infty} \frac{m}{n} < 3$ may be deduced easily from our knowledge of 'appearances'. We shall then prove (in Lemma 60) the result for when $\frac{m}{n}$ is close to 3 by modifying appearance proofs to deal instead with the useful concept of '6-appearances' (which we will define shortly). This will involve first proving (in Lemmas 58 and 59) some basic properties concerning 6-appearances and triangulations.

By combining Theorem 61 with our knowledge of acyclic components (from Section 6), we shall then achieve (in Theorem 63) our aforementioned extension for acyclic subgraphs.

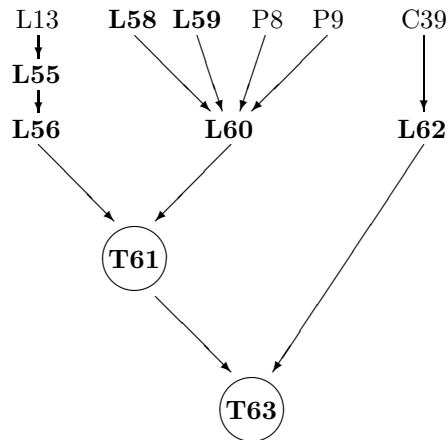

Figure 21: The structure of Section 9.

We start with the case when $\limsup_{n \rightarrow \infty} \frac{m}{n} < 3$, which will involve recalling the concept of ‘appearances’ from Definition 3. As usual, we will actually aim to show a slightly stronger result than that advertised at the beginning of this section, so we shall find it useful to first state vertex-disjoint versions of both Definition 3 and Lemma 13:

Definition 54 *Given a connected planar graph H and another planar graph G , let $f'_H(G)$ denote the maximum size of a set of vertex-disjoint appearances of H in G .*

Lemma 55 *Let H be a fixed connected planar graph on the vertices $\{1, 2, \dots, h\}$, let $b > 1$ and $B < 3$ be given constants, and let $m = m(n) \in [bn, Bn] \forall n$. Then there exist constants $N(H, b, B)$ and $\beta(H, b, B) > 0$ such that*

$$\mathbf{P}[f'_H(P_{n,m}) \leq \beta n] < e^{-\beta n} \forall n \geq N.$$

Proof For given G , let \mathcal{W} be the collection of all sets $W \subset V(G)$ such that H appears at W in G . As noted in [9], each set $W \in \mathcal{W}$ meets at most $|H| - 1$ other sets in \mathcal{W} (since there are at most $|H| - 1$ cut-edges in H and each of these can have at most one ‘orientation’ that provides an appearance of H), and so we must be able to find a collection of at least $\frac{|\mathcal{W}|}{|H|}$ pairwise vertex disjoint sets in \mathcal{W} . Thus, the result follows from Lemma 13 by taking $\beta = \frac{\alpha}{|H|}$. \square

Our aforementioned result now follows fairly easily:

Lemma 56 *Let H be a (fixed) planar graph and let $m = m(n)$ satisfy $1 < \liminf_{n \rightarrow \infty} \frac{m}{n} \leq \limsup_{n \rightarrow \infty} \frac{m}{n} < 3$. Then $\exists \alpha > 0$ and $\exists N$ such that*

$$\mathbf{P}\left[P_{n,m} \text{ will not have a set of } \geq \alpha n \text{ vertex-disjoint induced order-preserving copies of } H\right] < e^{-\alpha n} \forall n \geq N.$$

Proof Let the components of H be H_1, H_2, \dots, H_k and let us choose vertices $\{v_1, v_2, \dots, v_k\} \subset V(H)$ such that $v_i \in V(H_i) \forall i$.

Without loss of generality, we may assume that $V(H) = \{1, 2, \dots, |H|\}$. Let us define H' to be the graph with vertex set $V(H') = \{1, 2, \dots, |H|, |H| + 1\}$ and edge set $E(H') = E(H) \cup \{(v_1, |H| + 1), (v_2, |H| + 1), (v_3, |H| + 1)\}$.

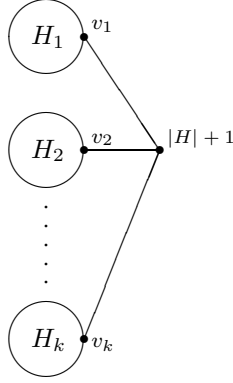

Figure 22: The graph H' .

Then H' is a planar graph containing an induced order-preserving copy of H . Thus, it suffices to prove the result for H' . But this follows from Lemma 55. \square

We shall now start working towards the case when $\frac{m}{n}$ is close to 3. As mentioned, the proof will involve the concept of ‘6-appearances’:

Definition 57 We say that a graph H with vertex set $\{1, 2, \dots, h\}$ **6-appears** at $W \subset V(G)$ if (a) the increasing bijection from $\{1, 2, \dots, h\}$ to W gives an isomorphism between H and the induced subgraph $G[W]$ of G ; and (b) there are exactly six edges in G between W and the rest of G , and these are of the form $E_W = \{r_1v_1, v_1r_2, r_2v_2, v_2r_3, r_3v_3, v_3r_1\}$, where $\{r_1, r_2, r_3\} \subset W$, $\{v_1, v_2, v_3\} \subset V(G) \setminus W$, and $\{v_2, v_3\} \subset \Gamma(v_1)$ (see Figure 23). We shall call $E(G[W]) \cup E_W$ the **total edge set** of the 6-appearance.

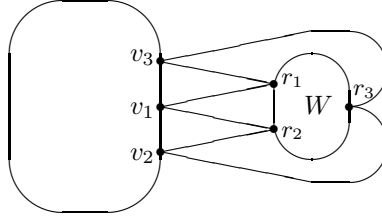

Figure 23: A 6-appearance at W .

The following result about 6-appearances shall be useful:

Lemma 58 *The total edge set of a 6-appearance of a 2-vertex-connected graph of order $|T|$ will intersect (i.e. have an edge in common with) the total edge set of at most $2 \binom{|T|+3}{3}$ other 6-appearances of connected graphs of order $|T|$.*

Proof Suppose we have a 6-appearance of a 2-vertex-connected graph of order $|T|$ at $W \subset V(G)$, as in Figure 23. Note that the vertices $\{v_1, v_2, v_3\}$ form a 3-vertex-cut. Suppose that G also contains another 6-appearance, at W_2 , of a connected graph of order $|T|$ and let $\{w_1, w_2, w_3\}$ denote the 3-vertex-cut in $V(G) \setminus W_2$ that is associated with W_2 .

(a) Suppose $\{u_1, u_2, u_3\} \subset V(G) \setminus W$. If $\{v_1, v_2, v_3\} = \{u_1, u_2, u_3\}$, then either $W_2 = W$ or $W_2 \subset V(G) \setminus (W \cup \{v_1, v_2, v_3\})$, in which case the total edge set of W_2 would not meet the total edge set of W .

If $\{v_1, v_2, v_3\} \neq \{u_1, u_2, u_3\}$, then without loss of generality $v_1 \notin \{u_1, u_2, u_3\}$ and so $W \cup v_1$ will all be in one component of the graph $G \setminus \{u_1, u_2, u_3\}$. Thus, either $(W \cup v_1) \subset W_2$, in which case $|W_2| > |T|$, or $W_2 \subset V(G) \setminus (W \cup \{v_1, v_2, v_3\})$ (since v_2 and v_3 must each either be in the same component of $G \setminus \{u_1, u_2, u_3\}$ as $W \cup v_1$ or must belong to $\{u_1, u_2, u_3\}$, in which case the total edge set of W_2 would not meet the total edge set of W).

(b) Suppose $\{u_1, u_2, u_3\} \subset (W \cup \{v_1, v_2, v_3\})$. Then there are at most $\binom{|T|+3}{3}$ choices for $\{u_1, u_2, u_3\}$. Note that once we have fixed on a particular choice of $\{u_1, u_2, u_3\}$ then there can only be at most 2 choices for W_2 , since if Z_1, Z_2 and Z_3 were all possibilities for W_2 then the graph obtained from G by condensing each of Z_1, Z_2 and Z_3 down to a single point would contain $K_{3,3}$ (since each of these points would be adjacent to each of the u_i 's), and this would contradict planarity. Hence, if $\{u_1, u_2, u_3\} \subset (W \cup \{v_1, v_2, v_3\})$ then we have at most $2 \binom{|T|+3}{3}$ choices for W_2 in total.

(c) If neither (a) nor (b) holds, $\exists u_i \in W$ and $\exists u_j \in V(G) \setminus (W \cup \{v_1, v_2, v_3\})$. By the definition of a 6-appearance, we must have $\{u_2, u_3\} \subset \Gamma(u_1)$. Since u_i and u_j are not adjacent, we must have $u_1 \in \{v_1, v_2, v_3\}$ and $\{u_i, u_j\} = \{u_2, u_3\}$.

Let $C(W \setminus u_i)$ denote the component containing $W \setminus u_i$ after the 3-vertex-cut defined by $\{u_1, u_2, u_3\}$ (this is well-defined, since the 2-vertex-connectivity of W implies that $W \setminus u_i$ is connected). By the definition of a 6-appearance, $\exists x \in W_2$ such that $x \in \Gamma(u_i) \cap \Gamma(u_j)$. Since $u_i \in W$ and $u_j \in V(G) \setminus (W \cup \{v_1, v_2, v_3\})$, we must have $x \in \{v_1, v_2, v_3\}$. But then x is certainly adjacent to a vertex in $W \setminus u_i$, and so $x \in C(W \setminus u_i)$.

Since $x \in W_2$ and $x \in C(W \setminus u_i)$, we must have $C(W \setminus u_i) = W_2$. But $W \setminus u_i$ will still be connected to $\{v_1, v_2, v_3\} \setminus u_1$ in $G \setminus \{u_1, u_2, u_3\}$, so $|C(W \setminus u_i)| \geq |W \setminus u_i| + |\{v_1, v_2, v_3\} \setminus u_1| = |T| + 1 > |W_2|$. \square

Before proceeding with Lemma 60, we also need to note the following useful result:

Lemma 59 *Let H be a (fixed) planar graph. Then there exists a triangulation T with $|T| \geq \max\{|H| + 1, 4\}$ such that T contains an induced order-preserving copy of H .*

Proof Let T_1 be a triangulation with $|T_1| \geq \max\{|H| + 1, 4\}$ such that $L \subset T_1$, where L is an order-preserving copy of H . For each edge $e \in E(T_1) \setminus E(L)$ such that e is between two vertices in $V(L)$, let us subdivide e by inserting a new vertex on it.

Let the new graph (which is not necessarily a triangulation) be called T_2 and note that L is an *induced* subgraph of T_2 . Since each face of T_1 was a triangle, each face of T_2 will be one of the following, where \bullet denotes a new vertex:

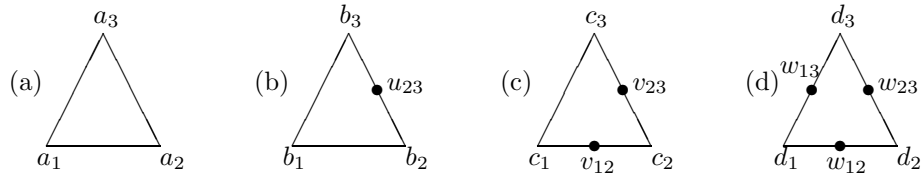

Figure 24: The possibilities for faces of T_2 .

We can create a new *triangulation* $T \supset T_2$ by replacing the faces of type (b), (c) and (d) with (b'), (c') and (d'):

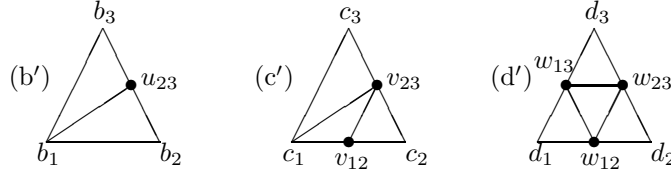

Figure 25: Our new faces.

Note that we haven't inserted the same edge in more than one face. This is because there is only one triangle in T_1 containing both the edge b_2b_3 and the vertex b_1 (and hence only one face, since $|T_1| \geq 4$) and only one triangle (and hence one face) containing both the edges c_2c_3 and c_1c_2 . Hence, the edges b_1u_{23} and $v_{12}v_{23}$ are both inserted in only one face of T_2 , and since all inserted edges are of this form we are okay.

Recall that $T_2 \subset T$ and that L is an *induced* subgraph of T_2 . Note that all edges in $E(T) \setminus E(T_2)$ are incident with at least one new vertex, and so none can be between two vertices in L . Thus, L is an *induced* subgraph of T . \square

We now come to our aforementioned lemma for the case when $\frac{m}{n}$ is close to 3. The proof is based on that of Proposition 10, which is itself based on the proof of Theorem 4.1 in [16].

Lemma 60 *Let H be a (fixed) planar graph. Then $\exists A(H) < 3$ such that if $m = m(n) \in [An, 3n - 6]$ for all large n , then $\exists \alpha > 0$ and $\exists N$ such that*

$$\mathbf{P} \left[\mathcal{P}_{n,m} \text{ won't have a set of } > \alpha n \text{ vertex-disjoint} \right. \\ \left. \text{induced order-preserving copies of } H \right] < e^{-\alpha n} \quad \forall n \geq N. \quad (11)$$

Sketch of Proof We choose a specific α and suppose that (11) is false for $n = k$, where k is suitably large. We let $q = \frac{m(k)}{k}$ and, by using the results of [9], we find that (for a given $\epsilon > 0$)

$$(1 - \epsilon)^n n! (\gamma(q))^n \leq |\mathcal{P}(n, \lfloor qn \rfloor)| \leq (1 + \epsilon)^n n! (\gamma(q))^n \quad \forall n \geq k. \quad (12)$$

Using the assumption that (11) is false for $n = k$, together with the left-hand inequality in (12), it follows that there are many graphs in $\mathcal{P}(k, qk)$ without a set of $> \alpha k$ vertex-disjoint induced order-preserving copies of H .

We attach 6-appearances of T and T' (which both contain induced order-preserving copies of H and have slightly more and slightly less, respectively, than the appropriate ratio of edges to vertices) to these graphs to construct a great many graphs in $\mathcal{P}((1 + \delta)k, \lfloor q(1 + \delta)k \rfloor)$, for some $\delta > 0$.

Lemma 58 is used to show that the original graphs didn't have many 6-appearances of T and T' , and this is used to show that there is not much double-counting of our created graphs. Thus, we obtain a contradiction to the right-hand inequality in (12) for $n = (1 + \delta)k$.

Full Proof By Lemma 59, we know that there exists a triangulation T with $|T| \geq \max\{|H| + 1, 4\}$ such that T contains an induced order-preserving copy of H . Let $\beta = e^2 \gamma_l^{|T|} \left(4 \binom{|T|+3}{3} + 2\right) |T|!$ and let α be a fixed constant in $\left(0, \frac{1}{\beta}\right)$. Thus, we have $\alpha\beta < 1$ and so $\exists \epsilon \in \left(0, \frac{1}{3}\right)$ such that $(\alpha\beta)^\alpha = 1 - 3\epsilon$.

Let $A = \max\left\{\frac{3|T|-1}{|T|}, \frac{11}{4}\right\}$ (this value is chosen for ease with later parts of the proof) and let N_1 be such that $m(n) \in [An, 3n - 6] \forall n \geq N_1$. Since $A > 1$, it follows from Proposition 9 (choosing $a \in (1, A)$) that $\exists N_2$ such that for all $n \geq N_2$ and all $s \in [[An], 3n - 6]$ we have $\left|\left(\frac{|\mathcal{P}(n, s)|}{n!}\right)^{1/n} - \gamma\left(\frac{s}{n}\right)\right| < \frac{\epsilon\epsilon}{2}$. Also, note from the uniform continuity of Proposition 8 that $\exists N_3$ such that $\left|\gamma\left(\frac{\lfloor rn \rfloor}{n}\right) - \gamma(r)\right| < \frac{\epsilon\epsilon}{2} \forall r \in [1, 3] \forall n \geq N_3$.

Suppose (11) doesn't hold for some $k > N = \max\{N_1, N_2, N_3\}$ and let $q = \frac{m(k)}{k}$. Then, by the previous paragraph, we have both $\left|\left(\frac{|\mathcal{P}(n, \lfloor qn \rfloor)|}{n!}\right)^{1/n} - \gamma\left(\frac{\lfloor qn \rfloor}{n}\right)\right| < \frac{\epsilon\epsilon}{2} \forall n \geq k$ and $\left|\gamma\left(\frac{\lfloor qn \rfloor}{n}\right) - \gamma(q)\right| < \frac{\epsilon\epsilon}{2} \forall n \geq k$. We recall from Proposition 8 that $\gamma(q) \geq e$, so putting everything together we must have $\left|\left(\frac{|\mathcal{P}(n, \lfloor qn \rfloor)|}{n!}\right)^{1/n} - \gamma(q)\right| < \epsilon\epsilon \leq \epsilon\gamma(q) \forall n \geq k$. Thus, we have (12).

Let \mathcal{G}_k denote the set of graphs in $\mathcal{P}(k, m(k)) = \mathcal{P}(k, \lfloor qk \rfloor)$ such that $G \in \mathcal{G}_k$ iff G does not have a set of $> \alpha k$ vertex-disjoint induced order-preserving copies of H . Then $|\mathcal{G}_k| \geq e^{-\alpha k} f(k, \lfloor qk \rfloor) \geq e^{-\alpha k} (1 - \epsilon)^k (\gamma(q))^k k!$, using (12) and our assumption that (11) does not hold for k .

Recall that T is a triangulation with $|T| \geq |H| + 1$ such that T contains an induced order-preserving copy of H and let T' be the result of deleting one edge from T that does not interfere with this copy of H (this is possible, since $|T| \geq |H| + 1$). Starting with graphs in \mathcal{G}_k , we shall construct graphs in $\mathcal{P}((1 + \delta)k, \lfloor q(1 + \delta)k \rfloor)$, where $\delta = \frac{\lceil \alpha k \rceil |T|}{k}$, by attaching k_1 6-appearances of T and k_2 6-appearances of T' . In order that our constructed graphs are in $\mathcal{P}((1 + \delta)k, \lfloor q(1 + \delta)k \rfloor)$, we shall need to achieve the correct balance of k_1 and k_2 :

Let us define k_1 to be $\lfloor q(k + \lceil \alpha k \rceil |T|) \rfloor - \lfloor qk \rfloor - \lceil \alpha k \rceil (3|T| - 1)$ and k_2 to be $\lfloor qk \rfloor + \lceil \alpha k \rceil 3|T| - \lfloor q(k + \lceil \alpha k \rceil |T|) \rfloor$. Then k_1 and k_2 are integers such that $k_1 + k_2 = \lceil \alpha k \rceil$.

Recall $q \geq A \geq \frac{3|T|-1}{|T|}$. Thus, $q\lceil \alpha k \rceil |T| \geq (3|T| - 1)\lceil \alpha k \rceil$ and so, since the right-hand-side is an integer, we have $\lfloor q\lceil \alpha k \rceil |T| \rfloor \geq \lceil \alpha k \rceil (3|T| - 1)$. Thus,

$$\begin{aligned} k_1 &\geq \lfloor qk \rfloor + \lfloor q\lceil \alpha k \rceil |T| \rfloor - \lfloor qk \rfloor - \lceil \alpha k \rceil (3|T| - 1) \\ &= \lfloor q\lceil \alpha k \rceil |T| \rfloor - \lceil \alpha k \rceil (3|T| - 1) \\ &\geq 0. \end{aligned}$$

Also, note that

$$\begin{aligned} k_2 &\geq \lfloor qk \rfloor + \lceil \alpha k \rceil 3|T| - \lfloor qk + 3\lceil \alpha k \rceil |T| \rfloor \\ &= \lfloor qk \rfloor + \lceil \alpha k \rceil 3|T| - \lfloor qk \rfloor + 3\lceil \alpha k \rceil |T| \\ &= 0. \end{aligned}$$

Thus, k_1 and k_2 are *positive* integers that sum to $\lceil \alpha k \rceil$.

Finally, note that the total edge set of a 6-appearance of T will have size $3|T|$ and the total edge set of a 6-appearance of T' will have size $3|T| - 1$, and note that

$$\begin{aligned} \lfloor qk \rfloor + k_1 3|T| + k_2 (3|T| - 1) &= \lfloor qk \rfloor + k_1 3|T| + (\lceil \alpha k \rceil - k_1)(3|T| - 1) \\ &= \lfloor qk \rfloor + \lceil \alpha k \rceil (3|T| - 1) + k_1 \\ &= \lfloor q(k + \lceil \alpha k \rceil |T|) \rfloor \\ &= \lfloor q(1 + \delta)k \rfloor. \end{aligned}$$

We shall now construct graphs in $\mathcal{P}((1 + \delta)k, \lfloor q(1 + \delta)k \rfloor)$:

Choose δk special vertices (we have $\binom{(1+\delta)k}{\delta k}$ choices for these) and partition them into $\lceil \alpha k \rceil$ unordered blocks of size $|T|$ (we have $\binom{\delta k}{|T|, \dots, |T|} \frac{1}{\lceil \alpha k \rceil!}$ choices for

this). Divide the blocks into two sets of sizes k_1 and k_2 . On each of the first k_1 blocks, we put a copy of T such that the increasing bijection from $\{1, 2, \dots, |T|\}$ to the block is an isomorphism between T and this copy. We do the same for the set of k_2 blocks, except with T' instead of T .

On the remaining (i.e. non-special) vertices, choose a planar graph L of size $\lfloor qk \rfloor = m$ that does not have a set of $> \alpha k$ vertex-disjoint induced order-preserving copies of H . We have $|\mathcal{G}_k| \geq e^{-\alpha k} (1 - \epsilon)^k (\gamma(q))^k k!$ choices for this. Note that (assuming $k \geq 3$) L may be extended to a triangulation by inserting $3k - 6 - m > (3 - A)k - 6$ ‘phantom’ edges. This triangulation will contain $2k - 4$ triangles that are faces. Each of our phantom edges is in exactly two faces of this triangulation, so when we remove these phantom edges we are left with an embedding of L which contains $\geq 2k - 4 - 2((3 - A)k - 6) \geq k(2A - 4)$ triangles that are faces. We may assume that k is large enough that $k(2A - 4) - \lceil \alpha k \rceil > k$, since $A \geq \frac{11}{4}$ and $\alpha < \frac{1}{\beta} < \frac{1}{2}$.

We may attach our copies of T and T' inside $\lceil \alpha k \rceil$ of these triangles in such a way that we create 6-appearances of T and T' .

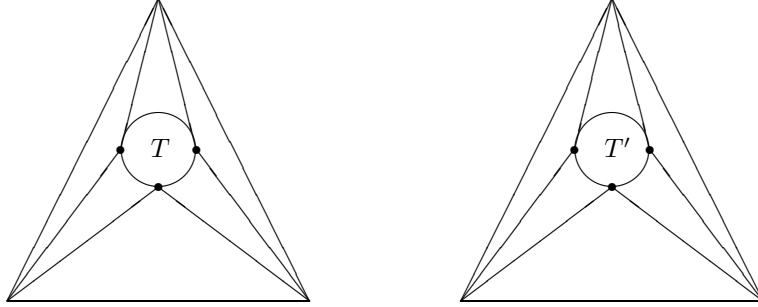

Figure 26: Creating 6-appearances of T and T' inside facial triangles.

We have at least $\binom{k(2A-4)}{\lceil \alpha k \rceil}$ choices for these triangles, and we then have $\lceil \alpha k \rceil!$ choices for which copies of T and T' to attach within which triangles.

Thus, for each choice of special vertices and each choice of L , we may con-

struct at least

$$\begin{aligned}
\binom{\delta k}{|T|, \dots, |T|} \binom{k(2A-4)}{\lceil \alpha k \rceil} &\geq \binom{\delta k}{|T|, \dots, |T|} \frac{(k(2A-4) - \lceil \alpha k \rceil)^{\lceil \alpha k \rceil}}{\lceil \alpha k \rceil!} \\
&\geq \binom{\delta k}{|T|, \dots, |T|} \frac{k^{\lceil \alpha k \rceil}}{\lceil \alpha k \rceil!} \\
&= \frac{(\delta k)! k^{\lceil \alpha k \rceil}}{(|T|!)^{\lceil \alpha k \rceil} \lceil \alpha k \rceil!} \\
&\geq \frac{(\delta k)!}{(|T|!)^{\lceil \alpha k \rceil}} \text{ for } k \text{ large enough that } \lceil \alpha k \rceil! \leq (\alpha k)^{\lceil \alpha k \rceil}
\end{aligned}$$

graphs in $\mathcal{P}((1 + \delta)k, \lfloor q(1 + \delta)k \rfloor)$. Hence, we may construct at least

$$\binom{(1+\delta)k}{\delta k} e^{-\alpha k} (1 - \epsilon)^k (\gamma(q))^k k! \frac{(\delta k)!}{(|T|!)^{\lceil \alpha k \rceil}} \text{ (not necessarily distinct) graphs in } \mathcal{P}((1 + \delta)k, \lfloor q(1 + \delta)k \rfloor) \text{ in total.}$$

We shall now consider the amount of double-counting:

Recall that L did not have a set of $> \alpha k$ vertex-disjoint induced order-preserving copies of H and that T and T' both contain induced order-preserving copies of H . Note that T and T' are both 2-vertex-connected, since $|T| \geq 4$. Thus, by Lemma 58, it must be that L contained at most $\left(2 \binom{|T|+3}{3} + 1\right) \alpha k$ 6-appearances of $|T|$ and T' .

When we deliberately attach a copy of T or T' , the number of ‘accidental’ 6-appearances of T or T' that we create in the graph will be at most $2 \binom{|T|+3}{3}$, again using Lemma 58. Thus, the number of 6-appearances of T or T' will increase by at most $2 \binom{|T|+3}{3} + 1$ each time we attach one of our blocks. Thus, our created graph will have $\leq \left(2 \binom{|T|+3}{3} + 1\right) \alpha k + \left(2 \binom{|T|+3}{3} + 1\right) \lceil \alpha k \rceil \leq \left(4 \binom{|T|+3}{3} + 2\right) \lceil \alpha k \rceil$ 6-appearances of T or T' .

Let $x = 4 \binom{|T|+3}{3} + 2$. Then, given one of our constructed graphs, we have at most $\binom{x \lceil \alpha k \rceil}{\lceil \alpha k \rceil} \leq (xe)^{\lceil \alpha k \rceil}$ choices for which were the special vertices. Once we have identified these, we know what L was. Thus, each graph is constructed at most $(xe)^{\lceil \alpha k \rceil}$ times.

Therefore, we find that the number of distinct graphs that we have created in $\mathcal{P}((1 + \delta)k, \lfloor q(1 + \delta)k \rfloor)$ is at least

$$\begin{aligned}
& \binom{(1+\delta)k}{\delta k} e^{-\alpha k} (1 - \epsilon)^k (\gamma(q))^k k! \frac{(\delta k)!}{(|T|! \alpha)^{\lceil \alpha k \rceil}} (xe)^{-\lceil \alpha k \rceil} \\
& \geq ((1 + \delta)k)! (\gamma(q))^{(1+\delta)k} (1 - \epsilon)^k \left(e^2 (\gamma(q))^{|T|} x |T|! \alpha \right)^{-\lceil \alpha k \rceil} \quad \text{since } \delta k = T \lceil \alpha k \rceil \\
& \geq ((1 + \delta)k)! (\gamma(q))^{(1+\delta)k} (1 - \epsilon)^k (\alpha \beta)^{-\lceil \alpha k \rceil} \\
& \quad \text{by definition of } \beta \text{ (and Proposition 8)} \\
& \geq f((1 + \delta)k) (1 + \epsilon)^{-(1+\delta)k} (1 - \epsilon)^k (1 - 3\epsilon)^{-k} \quad \text{by (12) with } n = (1 + \delta)k \\
& \geq f((1 + \delta)k) \left(\frac{(1 - \epsilon)}{(1 - 3\epsilon)(1 + \epsilon)^2} \right)^k \\
& \quad \text{since we may assume } k \text{ is large enough that } \delta < 1 \\
& > f((1 + \delta)k) \quad \text{since } (1 - 3\epsilon)(1 + \epsilon)^2 = 1 - \epsilon - 5\epsilon^2 - 3\epsilon^3
\end{aligned}$$

which is a contradiction. \square

Combining Lemmas 56 and 60, we obtain our main result:

Theorem 61 *Let H be a (fixed) planar graph and let $\liminf_{n \rightarrow \infty} \frac{m}{n} > 1$. Then $\exists \alpha > 0$ and $\exists N$ such that*

$$\mathbf{P} \left[P_{n,m} \text{ will not have a set of } > \alpha n \text{ vertex-disjoint} \right. \\
\left. \text{induced order-preserving copies of } H \right] < e^{-\alpha n} \quad \forall n \geq N.$$

It follows from Theorem 61 that the probability that $P_{n,m}$ will contain an induced order-preserving copy of any given planar graph H converges to 1 if $\liminf_{n \rightarrow \infty} \frac{m}{n} > 1$. We shall soon see that this can, in fact, be extended to $\liminf_{n \rightarrow \infty} \frac{m}{n} > 0$ if H is acyclic. First, we need to note the following result, which deals with small values of $\frac{m}{n}$:

Lemma 62 *Let H be a (fixed) acyclic graph, let s be a fixed constant, and let $m = m(n)$ satisfy $0 < \liminf_{n \rightarrow \infty} \frac{m}{n} \leq \limsup_{n \rightarrow \infty} \frac{m}{n} \leq (1 + o(1))n$ as $n \rightarrow \infty$. Then*

$$\mathbf{P} \left[P_{n,m} \text{ will have a set of } \geq s \text{ vertex-disjoint} \right. \\ \left. \text{induced order-preserving copies of } H \right] \rightarrow 1 \text{ as } n \rightarrow \infty.$$

Proof Let the components of H be H_1, H_2, \dots, H_k and let us choose vertices $\{v_1, v_2, \dots, v_k\} \subset V(H)$ such that $v_i \in V(H_i) \forall i$.

Without loss of generality, we may assume that $V(H) = \{1, 2, \dots, |H|\}$. Let us define H' be the graph with vertex set $V(H') = \{1, 2, \dots, |H|, |H| + 1\}$ and edge set $E(H') = E(H) \cup \{(v_1, |H| + 1), (v_2, |H| + 1), (v_3, |H| + 1)\}$.

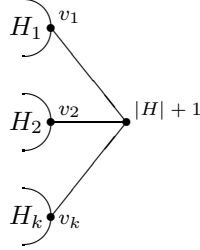

Figure 27: The graph H' .

Then H' is a tree containing an induced order-preserving copy of H . Thus, it suffices to prove the result for H' . But this follows from Corollary 39. \square

Combining Theorem 61 and Lemma 62, we obtain our aforementioned result for acyclic graphs:

Theorem 63 *Let H be a (fixed) acyclic graph, let s be a fixed constant, and let $\liminf_{n \rightarrow \infty} \frac{m}{n} > 0$. Then*

$$\mathbf{P} \left[P_{n,m} \text{ will have a set of } \geq s \text{ vertex-disjoint} \right. \\ \left. \text{induced order-preserving copies of } H \right] \rightarrow 1 \text{ as } n \rightarrow \infty.$$

Proof The proof is analogous to that of Theorem 53.

We shall suppose, hoping for a contradiction, that there exists a function $m(n)$ such that $\mathbf{P}[P_{n,m}$ will have a set of $\geq s$ vertex-disjoint induced order-preserving copies of $H] \not\rightarrow 1$. Thus, $\exists \delta > 0$ and there exists an infinite subsequence n_1, n_2, \dots such that $\mathbf{P}[P_{n_i, m(n_i)}$ will have a set of $\geq s$ vertex-disjoint induced order-preserving copies of $H] \leq 1 - \delta \forall i$.

Clearly, by Lemma 62, we can't have $m(n_i) \leq (1 + o(1))n_i$ as $i \rightarrow \infty$. Thus, $\exists \epsilon > 0$ such that $m(n_i) \geq (1 + \epsilon)n_i$ for arbitrary many values of i . But we then obtain a contradiction to Theorem 61. \square

10 Unicyclic Subgraphs

We continue to look at the probability that $P_{n,m}$ will contain given subgraphs. In Section 9, we saw that for any given planar subgraph the limiting probability is 1 if $\liminf_{n \rightarrow \infty} \frac{m}{n} > 1$, and that for acyclic subgraphs the limiting probability is 1 if $\liminf_{n \rightarrow \infty} \frac{m}{n} > 0$. We shall now start to investigate the limiting probability for non-acyclic subgraphs when $\frac{m}{n} \leq 1 + o(1)$.

In this section, our main focus will be on unicyclic subgraphs. We already know (by combining Theorems 37 and 61) that the associated probability is bounded away from 0 for all large n if $\liminf_{n \rightarrow \infty} \frac{m}{n} > 0$, so it only remains to discover exactly when the probability converges to 1.

Recall that in Section 8 we showed that the probability that $P_{n,m}$ will contain a non-acyclic *component* of order $\leq k$ is always bounded away from 1 for large n , regardless of m . We will now see (in Theorem 64) that, if $\limsup_{n \rightarrow \infty} \frac{m}{n} < 1$, then the probability that $P_{n,m}$ will contain a non-acyclic *subgraph* of order $\leq k$ is also bounded away from 1. We shall then complete matters by seeing (in Lemma 65) that, by contrast to our results with components, if $\frac{m}{n} \rightarrow 1$ then the probability that $P_{n,m}$ will contain any given connected unicyclic subgraph converges to 1. Both proofs will make use of bounds on the number of isolated vertices, which are implicit from Sections 6 and 7.

In Theorem 67, we shall extend Lemma 65 to cover any (not necessarily connected) given subgraph with no multicyclic components.

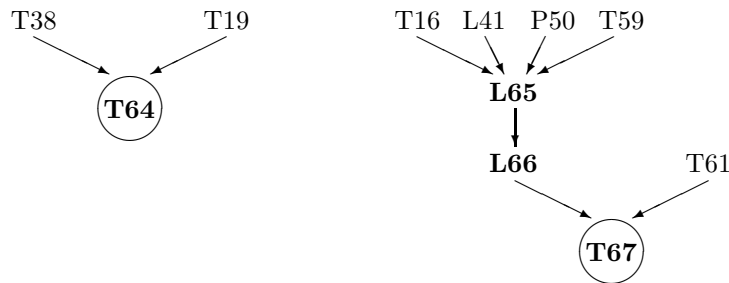

Figure 28: The structure of Section 10.

We shall go straight in with our result for when $\limsup_{n \rightarrow \infty} \frac{m}{n} < 1$:

Theorem 64 *Let k be a fixed constant and let $m = m(n) \leq An$, where $A < 1$.*

Then

$$\limsup_{n \rightarrow \infty} \mathbf{P}[P_{n,m} \text{ will have girth } \leq k] < 1.$$

Sketch of Proof Let C_i be used to denote cycles of order i and let ‘ C_i component’ be used to denote components that are cycles of order i (thus, a C_i component is a type of C_i).

Step 1: By an induction hypothesis, we may assume that there is a decent proportion of graphs with no cycles of order $< l$.

Step 2: If we have a C_l component, we may remove an edge from it and then insert an edge between the remainder of the cycle and the rest of the graph. We find that we may create so many graphs by doing this that the proportion of graphs *without* a C_l component (and still with no cycles of order $< l$) must be quite decent.

Step 3: Using Theorem 38, we find that there must be a decent proportion of graphs with no C_l components, no cycles of order $< l$, and lots of isolated vertices.

Step 4: If we have a C_l and lots of isolated vertices, we may ‘transfer’ the edges of the C_l to the isolated vertices to construct a C_l component. If there were no C_l components originally, then the amount of double-counting is small, and so we can use this idea to show that the proportion of graphs with lots of C_l ’s, lots of isolated vertices and no C_l components is small. Thus, using the result of Step 3, there must be a decent proportion of graphs with few C_l ’s and no cycles of order $< l$.

Step 5: We then destroy the few C_l ’s by deleting the edges from them and inserting edges between components of the graph.

Full Proof As in the sketch of the proof, we shall let C_i be used to denote cycles of order i and C_i component be used to denote components that are cycles of order i (thus, a C_i component is a type of C_i). For $\mathcal{A}_n \subset \mathcal{P}(n, m)$, we shall use \mathcal{A}_n^c to denote the set of graphs in $\mathcal{P}(n, m)$ that are not in \mathcal{A}_n .

Step 1

We will prove the result by induction on k . It is trivial for $k \leq 2$. Let us assume that the result is true for $k = l - 1$.

Let \mathcal{L}_n denote the set of graphs in $\mathcal{P}(n, m)$ without a cycle of order $< l$. Then, by our induction hypothesis, $\exists \epsilon(l) > 0$ such that $|\mathcal{L}_n| \geq \epsilon |\mathcal{P}(n, m)|$ for all sufficiently large n .

Step 2

Let \mathcal{G}_n denote the set of graphs in \mathcal{L}_n with a C_l component. For each graph $G \in \mathcal{G}_n$, let us delete an edge from a C_l component, $C' (= C'_G)$, to leave a spanning path. We have l choices for this edge. Let us then insert an edge between a vertex in the spanning path and a vertex elsewhere.

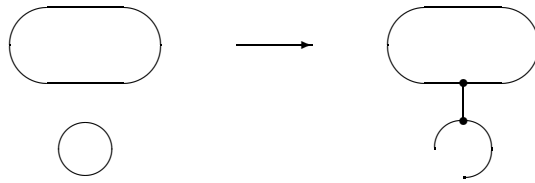

Figure 29: Destroying a C_l component in Step 2.

We have $l(n - l)$ ways to do this, planarity is maintained and no cycles of order $< l$ will be created. Thus, we have constructed $|\mathcal{G}_n| l^2 (n - l)$ graphs in \mathcal{L}_n .

Given one of our constructed graphs, there are at most $n - 1$ possibilities for which is the inserted edge, since it must be a cut-edge. There are then at most 2

possibilities for $V(C')$ (at most one possibility from each endpoint of the edge). There is then only 1 possibility for where the inserted edge was originally. Thus, we have built each graph at most $2(n-1)$ times.

Therefore, $|\mathcal{G}_n| \leq \frac{2(n-1)}{l^2(n-1)}|\mathcal{L}_n|$. Thus, for any fixed constant $\delta \in (0, 1 - \frac{2}{l^2})$, we have $|\mathcal{G}_n| < (1-\delta)|\mathcal{L}_n|$ for all sufficiently large n , and so we have $|\mathcal{L}_n \cap \mathcal{G}_n^c| > \delta|\mathcal{L}_n| \geq \delta\epsilon|\mathcal{P}(n, m)|$ for all sufficiently large n .

Step 3

Let $c \in (0, \frac{1}{2})$ be a fixed constant and suppose $m \in [cn, An] \forall n$. Then, by Theorem 38 (with $|H| = 1$) and Theorem 19, $\exists \beta > 0$ such that

$$\mathbf{P}[P_{n,m} \text{ will have } \geq \beta n \text{ isolated vertices}] \rightarrow 1 \text{ as } n \rightarrow \infty.$$

Clearly, $P_{n,m}$ must also have at least $n - 2cn$ isolated vertices if $m \leq cn$, so by setting $\alpha = \min\{\beta, 1 - 2c\}$ we find that whenever $m \leq An$ we have

$$\mathbf{P}[P_{n,m} \text{ will have } \geq \alpha n \text{ isolated vertices}] \rightarrow 1 \text{ as } n \rightarrow \infty.$$

Let \mathcal{I}_n denote the set of graphs in $\mathcal{P}(n, m)$ with $\geq \alpha n$ isolated vertices. Then, using the result of Step 2, we find that $\exists \epsilon' > 0$ such that $|\mathcal{G}_n^c \cap \mathcal{L}_n \cap \mathcal{I}_n| \geq \epsilon'|\mathcal{P}(n, m)|$ for all sufficiently large n .

Step 4

Let $r = r(l) > \frac{2l!}{\epsilon' \alpha^l}$ and let \mathcal{J}_n denote the set of graphs in $\mathcal{P}(n, m)$ whose maximal number of edge-disjoint C_l 's is $> r$.

Consider the set $\mathcal{J}_n \cap \mathcal{G}_n^c \cap \mathcal{I}_n$, i.e. the set of graphs in $\mathcal{P}(n, m)$ with $\geq \alpha n$ isolated vertices, $> r$ edge-disjoint C_l 's, but no C_l components. For each graph $J \in \mathcal{J}_n \cap \mathcal{G}_n^c \cap \mathcal{I}_n$, delete all l edges from a C_l (we have $> r$ choices for this) and insert them between l isolated vertices (we have $\geq \binom{\alpha n}{l}$ choices for these) to form a C_l component. We can thus construct at least $|\mathcal{J}_n \cap \mathcal{G}_n^c \cap \mathcal{I}_n| r \binom{\alpha n}{l}$ graphs in $\mathcal{P}(n, m)$.

Given one of our constructed graphs, there are at most $l+1$ C_l components, since we have deliberately constructed one and we may have also created at most l when we deleted the edges (since each vertex in the deleted C_l might now be in a C_l component). Thus, there are at most $l+1$ possibilities for which is the deliberately constructed component and hence at most $l+1$ possibilities for which are the inserted edges. There are then at most $\binom{n}{l} \frac{l!}{|\text{Aut}(C_l)|} = \binom{n}{l} \frac{(l-1)!}{2}$ possibilities for where these edges were originally. Thus, we have built each graph at most $(l+1) \binom{n}{l} \frac{(l-1)!}{2} < \frac{(l+1)n^l}{2^l} < n^l$ times and so

$$\begin{aligned} |\mathcal{J}_n \cap \mathcal{G}_n^c \cap \mathcal{I}_n| &< \frac{n^l |\mathcal{P}(n, m)|}{r \binom{\alpha n}{l}} \\ &= (1 + o(1)) \frac{l!}{r \alpha^l} |\mathcal{P}(n, m)| \\ &< \frac{\epsilon'}{2} |\mathcal{P}(n, m)| \text{ for sufficiently large } n, \text{ since } r > \frac{2l!}{\epsilon' \alpha^l}. \end{aligned}$$

Since we also know that $|\mathcal{G}_n^c \cap \mathcal{L}_n \cap \mathcal{I}_n| \geq \epsilon' |\mathcal{P}(n, m)|$ for all sufficiently large n , from Step 3, we must have $|\mathcal{J}_n^c \cap \mathcal{G}_n^c \cap \mathcal{L}_n \cap \mathcal{I}_n| > \frac{\epsilon'}{2} |\mathcal{P}(n, m)|$. Thus, $|\mathcal{J}_n^c \cap \mathcal{L}_n| > \frac{\epsilon'}{2} |\mathcal{P}(n, m)|$ for all sufficiently large n .

Step 5

Recall that $\mathcal{J}_n^c \cap \mathcal{L}_n$ is the set of graphs in $\mathcal{P}(n, m)$ without a copy of a cycle of order $< l$ and with $\leq r$ edge-disjoint C_l 's. For $L \in \mathcal{J}_n^c \cap \mathcal{L}_n$, let $S(L)$ denote a maximal set of edge-disjoint C_l 's (so $|S(L)| \leq r$) and, for $s \leq r$, let $\mathcal{J}_{n,s}$ denote the set of graphs in $\mathcal{P}(n, m)$ with $|S(L)| = s$.

For each graph $L \in \mathcal{J}_{n,s} \cap \mathcal{L}_n$, delete all l edges from a C_l that is in $S(L)$. Note that the graphs will now have $|S| = s - 1$, by maximality of $S(L)$.

Clearly, we may insert an edge between any two vertices in different components without introducing a copy of a cycle. By the proof of Lemma 18, we have at least $(1 + o(1)) \frac{(1-A)(1+A)}{2} n^2$ choices for where to insert an edge between two vertices in different components. Doing this l times, we find that we may construct $\geq (1 + o(1)) \frac{\left(\frac{(1-A)(1+A)}{2}\right)^l n^{2l}}{l!} |\mathcal{J}_{n,s} \cap \mathcal{L}_n|$ graphs in $\mathcal{J}_{n,s-1} \cap \mathcal{L}_n$.

Given one of our created graphs, there are $\leq \binom{m}{l} \leq (An)^l$ possibilities for which edges were inserted and $\leq \binom{n}{l} \frac{l!}{|\text{Aut}(C_l)|} < n^l$ possibilities for where they were originally. Thus, we have built each graph at most $A^l n^{2l}$ times.

$$\text{Thus, } |\mathcal{J}_{n,s-1} \cap \mathcal{L}_n| \geq (1+o(1)) \frac{\left(\frac{(1-A)(1+A)}{2A}\right)^l}{l!} |\mathcal{J}_{n,s} \cap \mathcal{L}_n|.$$

For $s \leq r$, let $\mathcal{J}_{n,\leq s}$ denote the set of graphs in $\mathcal{P}(n, m)$ with $|S| \leq s$. Then, with $z = \frac{\left(\frac{(1-A)(1+A)}{2A}\right)^l}{l!}$, we have $|\mathcal{J}_{n,\leq s-1} \cap \mathcal{L}_n| \geq (1+o(1)) \frac{z}{1+z} |\mathcal{J}_{n,\leq s} \cap \mathcal{L}_n| \forall s \leq r$.

Thus, we may obtain

$$\begin{aligned} |\mathcal{J}_{n,\leq 0} \cap \mathcal{L}_n| &\geq (1+o(1))^r \left(\frac{z}{1+z}\right)^r |\mathcal{J}_{n,\leq r} \cap \mathcal{L}_n| \\ &= (1+o(1)) \left(\frac{z}{1+z}\right)^r |\mathcal{J}_n^c \cap \mathcal{L}_n| \\ &\geq (1+o(1)) \left(\frac{z}{1+z}\right)^r \frac{\epsilon'}{2} |\mathcal{P}(n, m)| \quad \text{from Step 4.} \end{aligned}$$

But $\mathcal{J}_{n,\leq 0} \cap \mathcal{L}_n$ is the set of graphs in $\mathcal{P}(n, m)$ without a cycle of order $\leq l$. Thus, the induction hypothesis is true for $k = l$, and so we are done. \square

We will now start to work towards Theorem 67, where we shall show that the probability that $P_{n,m}$ will contain any given subgraph with no multicyclic components converges to 1 if $\frac{m}{n} \geq 1 - o(1)$. We already know this for when $\frac{m}{n} \geq B > 1$, by Theorem 61, so it will suffice to now look at the case when $\frac{m}{n} \in [(1 - o(1)), B]$. We shall start by proving the result for a connected unicyclic graph, showing that a.a.s. $P_{n,m}$ will contain many vertex-disjoint appearances of any such graph:

Lemma 65 *Let H be a (fixed) connected unicyclic graph, let t be a fixed constant, and let $m = m(n) \in [(1 - o(1))n, Bn]$, where $B < 3$. Then*

$$\mathbf{P}[f'_H(P_{n,m}) \geq t] \rightarrow 1 \text{ as } n \rightarrow \infty.$$

Sketch of Proof By Theorem 16, we may assume that we have lots of pendant edges. We may delete $|H|$ of these edges, and then use them with $|H| - 1$ of the associated (now isolated) vertices to convert another pendant edge into an appearance of H . Note that we are also left with an extra isolated vertex.

By Lemma 41 and Proposition 50, we may assume that there are not very many isolated vertices. Thus, if our original graphs had few appearances of H , then the amount of double-counting will be small, and hence the size of our original set of graphs must have been small.

Full Proof Let \mathcal{G}_n denote the set of graphs in $\mathcal{P}(n, m)$ with $f'_H < t$, and let X denote the event that $f'_H(P_{n, m}) < t$.

Recall, from Theorem 16, $\exists \alpha > 0$ such that

$$\mathbf{P}[P_{n, m} \text{ will have } \geq \alpha n \text{ pendant edges}] \rightarrow 1 \text{ as } n \rightarrow \infty. \quad (13)$$

Let \mathcal{H}_n denote the set of graphs in $\mathcal{P}(n, m)$ with $\geq \alpha n$ pendant edges, and let Y denote the event that $P_{n, m}$ will have $\geq \alpha n$ pendant edges.

Also, note that by Lemma 41 and Proposition 50, $\exists c > 0$ such that

$$\mathbf{P} \left[\kappa(P_{n, m}) > 2 \max \left\{ \frac{cn}{\ln n}, n - m \right\} \right] = e^{-\Omega(n)}. \quad (14)$$

Let $x = x(n) = 2 \max \left\{ \frac{cn}{\ln n}, n - m \right\} = o(n)$, let \mathcal{I}_n denote the number of graphs in $\mathcal{P}(n, m)$ with $\leq x$ components, and let Z denote the event that $\kappa(P_{n, m}) \leq x$.

Note that $\mathbf{P}[X] \leq \mathbf{P}[X \cap Y \cap Z] + \mathbf{P}[\bar{Y}] + \mathbf{P}[\bar{Z}] \rightarrow \mathbf{P}[X \cap Y \cap Z]$ as $n \rightarrow \infty$, by (13) and (14). Thus, it suffices to show that $\mathbf{P}[X \cap Y \cap Z] \rightarrow 0$ as $n \rightarrow \infty$.

Given a graph in $\mathcal{G}_n \cap \mathcal{H}_n \cap \mathcal{I}_n$, let us choose $|H| + 1$ pendant edges (we have at least $\binom{\alpha n}{|H|+1}$ choices for these). We shall use these edges to create an appearance of H .

Out of our chosen $|H| + 1$ pendant edges, let the edge incident with the lowest labelled vertex of degree 1 be called ‘special’, and let this associated

lowest labelled vertex of degree 1 be called the ‘root’. Let us delete our $|H|$ non-special pendant edges to create at least $|H|$ isolated vertices.

We may choose $|H| - 1$ of these newly isolated vertices in such a way that no two were adjacent in the original graph (i.e. we don’t choose two vertices from the same pendant edge, even if that is possible). We may then use these chosen isolated vertices, together with the root, to construct an appearance of H (by inserting $|H|$ edges appropriately).

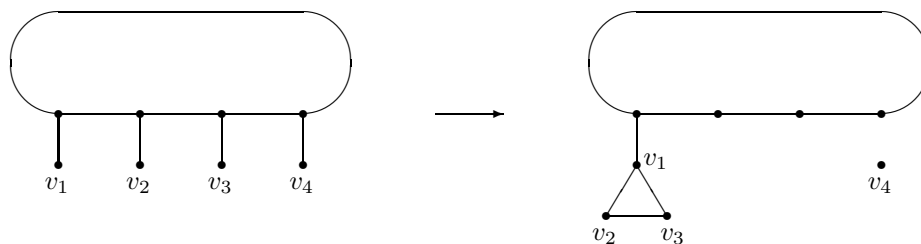

Figure 30: Constructing an appearance of H .

We shall now consider the amount of double-counting:

Suppose that when we deleted one of our pendant edges we ‘accidentally’ created an appearance of H at W . Then the pendant edge must have been incident to a vertex in W . Thus, if we simultaneously accidentally created appearances of H at both W_1 and W_2 , then the pendant edge must have been incident to a vertex in $W_1 \cap W_2$, and so $W_1 \cap W_2 \neq \emptyset$.

As noted in Lemma 55, an appearance of H meets at most $|H| - 1$ other appearances of H (since there are at most $|H| - 1$ cut-edges in H and each of these can have at most one ‘orientation’ that provides an appearance of H). Thus (using the observation of the previous paragraph), we can have created at most $|H|$ appearances of H each time we deleted a pendant edge. By the same argument, our original graph must have satisfied $f_H < t|H|$ and when we deliberately created our appearance of H we can have only increased the number of appearances of H by at most $|H|$. Therefore, in total we find that each of our constructed graphs will contain $< |H|(|H| + t + 1)$ appearances of H .

Thus, given one of our constructed graphs, there are at most $|H|(|H| + t + 1)$ possibilities for which is the constructed appearance of H . We may then recover the original graph by deleting the $|H|$ edges from this appearance, joining the $|H| - 1$ non-root vertices back to the rest of the graph (at most $n^{|H|-1}$ possibilities), and joining the correct isolated vertex back to the rest of the graph (at most in possibilities, where i denotes the number of isolated vertices in the constructed graph).

We know that the number of components in the original graph was at most x , and each time we deleted an edge we can have only increased the number of components by at most 1. Thus, the number of components in our constructed graph is at most $x + |H|$, and so $i \leq x + |H|$.

Thus, we have built each graph at most $|H|(|H| + t + 1)n^{|H|-1}(x + |H|)n$ times.

Therefore,

$$\begin{aligned}
\mathbf{P}[X \cap Y \cap Z] &= \frac{|\mathcal{G}_n \cap \mathcal{H}_n \cap \mathcal{I}_n|}{|\mathcal{P}(n, m)|} \\
&\leq \frac{|H|(|H| + t + 1)n^{|H|}(x + |H|)}{\binom{\alpha n}{|H|+1}} \\
&= \frac{o(n^{|H|+1})}{\Theta(n^{|H|+1})}, \text{ since } x = o(n) \\
&\rightarrow 0 \text{ as } n \rightarrow \infty. \quad \square
\end{aligned}$$

For $m \in [(1 - o(1))n, Bn]$, it follows from Lemma 65 that a.a.s. $P_{n,m}$ will have at least t vertex-disjoint induced order-preserving copies of any connected unicyclic H . We shall now extend this result to cover *any* (not necessarily connected) subgraph without multicyclic components:

Lemma 66 *Let H be a (fixed) graph with $e(H_i) \leq |H_i|$ for all components H_i of H , let s be a fixed constant, and let $m = m(n) \in [(1 - o(1))n, Bn]$, where $B < 3$. Then*

$$\mathbf{P} \left[P_{n,m} \text{ will have a set of } \geq s \text{ vertex-disjoint induced order-preserving copies of } H \right] \rightarrow 1 \text{ as } n \rightarrow \infty.$$

Proof Since the probability of a copy of H being order-preserving is at least $\frac{1}{|H|!}$ and is independent of whether or not another vertex-disjoint copy of H is also order-preserving, it suffices to show

$$\mathbf{P}[P_{n,m} \text{ will have a set of } \geq l \text{ vertex-disjoint induced copies of } H] \rightarrow 1 \text{ as } n \rightarrow \infty$$

for an arbitrary fixed constant l .

For every tree component T of H , let us introduce two new vertices u_T and v_T , and three new edges $u_T v_T$, $u_T w_T$ and $v_T w_T$, where w_T is an arbitrary vertex in $V(T)$. Then the resulting component T' is unicyclic and contains an induced copy of T . Thus, without loss of generality, we may assume that

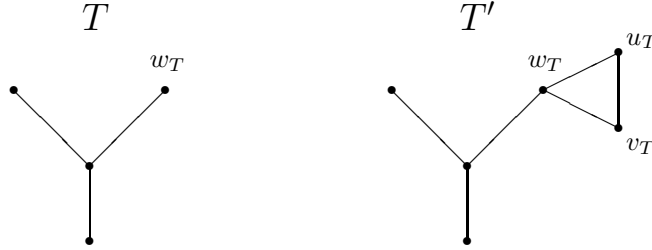

Figure 31: The graphs T and T' .

$e(H_i) = |H_i|$ for all components H_i of H .

Let the components of H be H_1, H_2, \dots, H_k , for some k . By Lemma 65, we have $\mathbf{P} [f'_{H_i}(P_{n,m}) \geq t \forall i] \rightarrow 1$ as $n \rightarrow \infty$, where t may be chosen arbitrarily large. Given a graph $G \in \mathcal{P}(n, m)$ with $f'_{H_i}(G) \geq t \forall i$, let us select l vertex-disjoint appearances of H_1 . Recall that G contains a set of t vertex-disjoint

appearances of H_2 and notice that at most $l|H_1|$ of these can have a vertex in common with one of our selected appearances of H_1 (since the appearances of H_2 are themselves vertex-disjoint) and that at most l can be attached by an edge to one of our selected appearances of H_1 (by definition of an appearance). Hence, if $t - l(|H_1| + 1) \geq l$, then we may select l vertex-disjoint appearances of H_2 in such a way that the graph formed by these appearances and our selected appearances of H_1 will consist of l vertex-disjoint induced copies of the graph with components H_1 and H_2 . Continuing in this manner, we find that G contains a set of l vertex-disjoint induced copies of H , and so we are done. \square

Combining Lemma 66 with Theorem 61, we obtain our main result, which holds for all $m \geq (1 + o(1))n$:

Theorem 67 *Let H be a (fixed) graph with $e(H_i) \leq |H_i|$ for all components H_i of H , let s be a fixed constant, and let $m = m(n) \in [(1 - o(1))n, 3n - 6]$. Then*

$$\mathbf{P} \left[P_{n,m} \text{ will have a set of } \geq s \text{ vertex-disjoint} \right. \\ \left. \text{induced order-preserving copies of } H \right] \rightarrow 1 \text{ as } n \rightarrow \infty.$$

11 Multicyclic Subgraphs

It now only remains to look at the probability that $P_{n,m}$ will contain a given *multicyclic* connected subgraph, i.e. a connected subgraph with more edges than vertices. We already know from our work on appearances (see Lemma 13) that this probability converges to 1 if $\liminf_{n \rightarrow \infty} \frac{m}{n} > 1$. In this section, we will show (in Corollary 69) that the probability converges to 0 if $\limsup_{n \rightarrow \infty} \frac{m}{n} < 1$, and we shall also see some partial results (in Theorems 68 and 70) for the case $\frac{m}{n} \rightarrow 1$.

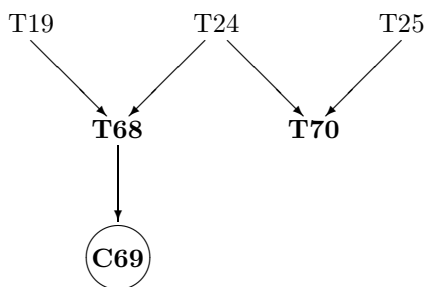

Figure 32: The structure of Section 11.

We start with a result for the case when either $\limsup_{n \rightarrow \infty} \frac{m}{n} < 1$ or $\frac{m}{n}$ converges to 1 slowly from beneath:

Theorem 68 *Let H be a fixed multicyclic connected planar graph and let $d = d(n) = n - m$ be such that $d > 0$ and $d = \omega\left(n^{\frac{|H|}{e(H)}}\right)$. Then*

$$\mathbf{P}[P_{n,m} \text{ will have a copy of } H] \rightarrow 0 \text{ as } n \rightarrow \infty.$$

Proof Let \mathcal{G}_n denote the set of graphs in $\mathcal{P}(n, m)$ with a copy of H . For each graph $G \in \mathcal{G}_n$, let us delete all $e(H)$ edges from a copy of H and then insert these edges back into the graph (see Figure 33). By Theorems 19 and 24, we have $\Omega((dn)^{e(H)})$ ways to do this, maintaining planarity.

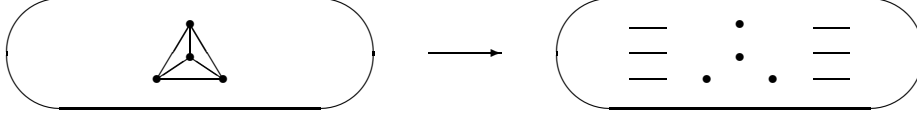

Figure 33: Redistributing the edges of H .

There are then $\binom{n}{|H|} \frac{|H|!}{|\text{Aut}(H)|} = O(n^{|H|})$ possibilities for where the copy of H was originally and $\binom{m}{e(H)} = O(n^{e(H)})$ possibilities for which edges were inserted, so we have built each graph $O(n^{|H|+e(H)})$ times.

Therefore, $\frac{|\mathcal{G}_n|}{|\mathcal{P}(n,m)|} = O\left(\frac{n^{|H|+e(H)}}{(dn)^{e(H)}}\right) = O\left(\frac{n^{|H|}}{d^{e(H)}}\right) \rightarrow 0$, since $d = \omega\left(n^{\frac{|H|}{e(H)}}\right)$. \square

Our main result of this section follows immediately:

Corollary 69 *Let H be a fixed multicyclic connected planar graph and let $m(n)$ be such that $\limsup_{n \rightarrow \infty} \frac{m}{n} < 1$. Then*

$$\mathbf{P}[P_{n,m} \text{ will have a copy of } H] \rightarrow 0 \text{ as } n \rightarrow \infty.$$

By the same proof as Theorem 68, using Theorem 25 instead of Theorem 19, we may also obtain a stronger result for when $e(H) > 2|H|$:

Theorem 70 *Let H be a fixed connected planar graph such that $e(H) > 2|H|$ and let $m = m(n)$ be such that $\max\{0, m - n\} = o\left(n^{1 - \frac{|H|}{e(H)}}\right)$. Then*

$$\mathbf{P}[P_{n,m} \text{ will have a copy of } H] \rightarrow 0 \text{ as } n \rightarrow \infty.$$

Note that Theorem 70 includes the case when $\frac{m}{n}$ converges slowly to 1 from above. In particular, it holds when $m = n$.

We now have a complete account of $\mathbf{P}[P_{n,m} \text{ will have a copy of } H]$, in terms of exactly when it is bounded away from 0 and 1, except for the case when H is multicyclic and $\frac{m}{n} \rightarrow 1$. We shall now finish Part I with a discussion of this remaining question.

Recall that, in Theorems 68 and 70, we showed that the probability that $P_{n,m}$ will contain a copy of any given multicyclic subgraph H converges to 0 even for some $m(n)$ such that $\frac{m}{n} \rightarrow 1$. Our previous result on components and subgraphs have all produced thresholds with neat divisions, so this may suggest that $\mathbf{P}[P_{n,m} \text{ will contain a copy of } H] \rightarrow 0$ whenever $\frac{m}{n} \leq 1 + o(1)$.

The proofs of Theorems 68 and 70 used the work of Section 5, where we defined $\text{add}(n, m)$ to be the *minimum* value of $|\text{add}(G)|$ over all graphs $G \in \mathcal{P}(n, m)$. We already know (from the second half of Section 5) that these results cannot be improved, but of course it might be possible to find some function $a(n, m)$ with $a(n, m) = \omega(\text{add}(n, m))$ such that $|\text{add}(P_{n,m})| \geq a(n, m)$ *a.a.s.*. This could then be used to improve our current multicyclic subgraph results. For example, if we could show that $|\text{add}(P_{n,m})|$ is usually of the order of $\frac{n^2}{\ln n}$ whenever $\frac{m}{n} \leq 1 + o(1)$, then we could probably use the method of the proofs of Theorems 68 and 70 to show that $\mathbf{P}[P_{n,m} \text{ will contain a copy of } H] \rightarrow 0$ whenever $\frac{m}{n} \leq 1 + o(1)$.

Let us now consider for a moment how we might work towards finding such a function $a(n, m)$. Note that if we did show that $|\text{add}(P_{n,m})| \geq a(n, m)$ *a.a.s.*, then we could probably use the proof of Theorem 38 to show that the number of components in $P_{n,m}$ that are isomorphic to any given tree is *a.a.s.* of the order of $\frac{a(n,m)}{n}$. Conversely, we know from the proof of Lemma 18 that $|\text{add}(G)| \geq (\kappa(G) - 1) \left(n - \frac{\kappa(G)}{2} \right)$, so if $\kappa(P_{n,m})$ is *a.a.s.* of the order of $\frac{a(n,m)}{n}$ then we would indeed have $|\text{add}(P_{n,m})| \geq a(n, m)$ *a.a.s.*. Thus, if we are interested in the typical value of $|\text{add}(P_{n,m})|$, then it seems that it would actually

be equivalent for us to investigate the typical value of $\kappa(P_{n,m})$, or indeed the typical number of components in $P_{n,m}$ that are isomorphic to any given tree (such as an isolated vertex).

It is possible, of course, that for some multicyclic connected H , the probability that $P_{n,m}$ will contain a copy of H is bounded away from 0 for some functions $m(n)$ with $\frac{m}{n} \rightarrow 1$. In Lemma 65, we showed that for *unicyclic* connected H we have $\mathbf{P}[P_{n,m}$ will have a copy of $H] \rightarrow 1$ if $\frac{m}{n} \geq 1 - o(1)$. The proof involved turning pendant edges into an appearance of H plus one isolated vertex, and the crucial ingredient was the fact that $\kappa(P_{n,m})$, and hence the number of isolated vertices in $P_{n,m}$, is typically $o(n)$. If we tried to use the same method for a graph H with $e(H) = |H| + 1$, we would be left with two isolated vertices, and hence the proof would only work if $m(n)$ is such that $\kappa(P_{n,m})$ is typically $o(n^{1/2})$. In general, for H such that $e(H) = |H| + r$, the proof would work if $m(n)$ is such that $\kappa(P_{n,m})$ is typically $o\left(n^{\frac{1}{r+1}}\right)$. From page 73, we can see that it is not impossible that $\kappa(P_{n,m})$ is small enough for certain m , and thus we may in fact be able to use this method to show that we sometimes have $\mathbf{P}[P_{n,m}$ will have a copy of $H] \rightarrow 1$ for a connected multicyclic H even when $\frac{m}{n} \rightarrow 1$.

Note that, again, the topic of $\mathbf{P}[P_{n,m}$ will have a copy of $H]$ seems to be linked to that of $\kappa(P_{n,m})$. Thus, to conclude, in order to discover the behaviour of $\mathbf{P}[P_{n,m}$ will have a copy of $H]$ for multicyclic H when $\frac{m}{n}$ is close to 1, it seems that it will be necessary to obtain more precise results on $\kappa(P_{n,m})$, or on the equivalent topics of $\text{add}(P_{n,m})$ or the number of isolated vertices in $P_{n,m}$.

Part II

Random Planar Graphs with Bounds on the Minimum and Maximum Degrees

12 Outline of Part II

In Part I, we saw how the typical properties of a random planar graph, such as being connected or containing given subgraphs/components, change depending on the number of edges or, equivalently, the average degree. In Part II, we shall now instead look at how the minimum and maximum degrees influence these properties.

For functions $d_1(n)$, $d_2(n)$, $D_1(n)$ and $D_2(n)$, we will use $\mathcal{P}(n, d_1, d_2, D_1, D_2)$ to denote the set of all labelled planar graphs on $\{1, 2, \dots, n\}$ with minimum degree between $d_1(n)$ and $d_2(n)$ inclusive and maximum degree between $D_1(n)$ and $D_2(n)$ inclusive. We shall use $P_{n, d_1, d_2, D_1, D_2}$ to denote a graph taken uniformly at random from this class.

Note that the minimum degree of a planar graph must be at most 5. Thus, for example, $P_{n, 1, 5, 3, \log n}$ would denote a random planar graph with minimum degree at least 1 and maximum degree between 3 and $\log n$, while $P_{n, 0, 5, 0, n-1}$ would simply denote a random planar graph (with no bounds on the degrees at all). For $D_2(n) < 3$, we should note that our random *planar* graph $P_{n, d_1, d_2, D_1, D_2}$ is just the same as a *general* random graph with the same degree constraints. Thus, since general random graphs have already been extensively investigated, we shall only bother to concern ourselves here with the case when $D_2(n) \geq 3 \forall n$.

In fact, it will turn out that most of our results for $P_{n, d_1, d_2, D_1, D_2}$ will fol-

low just from consideration of the case when there is no upper bound on the minimum degree and no lower bound on the maximum degree. Thus, for most of Part II we will only look at $P_{n,d_1,5,0,D_2}$ (i.e. a random planar graph with all degrees between $d_1(n)$ and $D_2(n)$), before then extending our results in Section 19 to cover any functions $d_1(n)$, $d_2(n)$, $D_1(n)$ and $D_2(n)$ as long as $\limsup_{n \rightarrow \infty} D_1(n) < \infty$. We shall not attempt to provide a description of what happens when $\limsup_{n \rightarrow \infty} D_1(n) = \infty$, but we will note one partial result for this case in Section 20.

The structure of Part II shall be based on that of [16], where the graph $P_{n,0,5,0,n-1}$ was studied. Hence, we will start in Section 13 by establishing a lower bound for the probability that $P_{n,d_1,5,0,D_2}$ will be connected. In Section 14, we shall use this to show that there exists a non-zero finite ‘growth constant’ for $|\mathcal{P}(n, d_1, 5, 0, D_2)|$, and in Section 15 we will use this second fact to show that (a.a.s.) $P_{n,d_1,5,0,D_2}$ has many appearance-type copies of certain H . In Section 16, we shall then use this last result to deduce a lower bound for the probability that $P_{n,d_1,5,0,D_2}$ will contain a component isomorphic to H , and in Section 17 we will prove that $P_{n,d_1,5,0,D_2}$ has many vertex-disjoint induced copies of most, but not all, H .

During Section 17, we shall come across the topic of determining whether or not a given graph H can *ever* be a subgraph of a 4-regular planar graph. This issue turns out to be quite intricate, and Section 18 (which is joint work with Louigi Addario-Berry) is devoted to giving a polynomial-time algorithm for this problem.

As already noted, in Section 19 we shall then extend our results on $P_{n,d_1,5,0,D_2}$ to also cover any functions $d_2(n)$ and $D_1(n)$ as long as $D_1(n)$ is bounded, before then looking briefly at the case $\limsup_{n \rightarrow \infty} D_1(n) = \infty$ in Section 20. A simplified summary of our main results is given on page 112, although we may sometimes actually prove slightly stronger versions, as with Part I.

Summary of Results

Given functions $d_1(n)$, $d_2(n)$, $D_1(n)$ and $D_2(n)$,

let H_1 be a connected planar graph with $\overline{\lim}d_1(n) \leq \delta(H_1) \leq \Delta(H_1) \leq \underline{\lim}D_2(n)$

and let H_2 be a connected planar graph with $\Delta(H_2) \leq \underline{\lim}D_2(n)$.

Let $\mathbf{P}_c = \mathbf{P}[P_{n,d_1,d_2,D_1,D_2}$ will be connected],

let $\mathbf{P} = \mathbf{P}[P_{n,d_1,d_2,D_1,D_2}$ will have a component isomorphic to $H_1]$

and let $\mathbf{P}_s = \mathbf{P}[P_{n,d_1,d_2,D_1,D_2}$ will have a subgraph isomorphic to $H_2]$.

The following results hold for all choices of $d_1(n)$, $d_2(n)$, $D_1(n)$ and $D_2(n)$, subject to $\overline{\lim}D_1(n) < \infty$ (and $D_2(n) \geq 3$, as always), unless otherwise stated.

$$\text{Connectivity Results} \left\{ \begin{array}{l} d_2(n) = 0 \ \forall n \left\{ \begin{array}{l} \mathbf{Observation: } \mathbf{P}_c = 0 \ \forall n \geq 2. \\ \mathbf{Theorems 72 \& 105: } \underline{\lim} \mathbf{P}_c > 0. \\ \mathbf{Theorems 91 \& 105: } \overline{\lim} \mathbf{P}_c < 1. \end{array} \right. \\ d_2(n) > 0 \ \forall n \end{array} \right.$$

$$\text{Component Results} \left\{ \begin{array}{l} \mathbf{Theorems 91, 105, 108 \& 109: } \underline{\lim} \mathbf{P} > 0. \\ (d_2(n), |H_1|) = (0, 1) \ \forall n \left\{ \begin{array}{l} \mathbf{Observation: } \mathbf{P} = 1 \ \forall n. \\ \mathbf{Thms. 72, 105, 108 \& 110:} \\ \overline{\lim} \mathbf{P} < 1. \end{array} \right. \\ \nexists n : (d_2(n), |H_1|) = (0, 1) \end{array} \right.$$

$$\text{Subgraph Results} \left\{ \begin{array}{l} D_2(n) = \delta(H_2) \ \forall n \left\{ \begin{array}{l} \mathbf{Thms. 98, 105, 108 \& 112: } \underline{\lim} \mathbf{P}_s > 0. \\ \mathbf{Thms. 98, 105, 108 \& 112: } \overline{\lim} \mathbf{P}_s < 1. \end{array} \right. \\ D_2(n) > \delta(H_2) \ \forall n \ \& \left\{ \begin{array}{l} \mathbf{Thms. 97, 105, 108 \& 111:} \\ \mathbf{P}_s \rightarrow 1. \end{array} \right. \\ \nexists n : d_1(n) = D_2(n) = 4 \\ D_2(n) > \delta(H_2) \ \forall n \ \& \left\{ \begin{array}{l} \mathbf{Thms. 97, 105 \& 108:} \\ \mathbf{P}_s \rightarrow 1 \text{ if } \exists \text{ 4-reg. planar } H^* \supset H_2. \\ \mathbf{Observation: } \mathbf{P}_s = 0 \text{ otherwise.} \end{array} \right. \\ d_1(n) = D_2(n) = 4 \ \forall n \end{array} \right.$$

13 Connectivity

We will start by examining the probability that our random graph is connected. Not only is this topic interesting in its own right, but the results given here will also be important ingredients in later sections.

As mentioned in the introduction, until Section 19 we shall restrict ourselves to the case when we have no upper bound on the minimum degree and no lower bound on the maximum degree. Thus, we will be looking at $P_{n,d_1,5,0,D_2}$, which is simply a random planar graph on $\{1, 2, \dots, n\}$ with all degrees between $d_1(n)$ and $D_2(n)$.

Recall that we must have $D_2(n) \geq 3$ for planarity to have any impact. The main result of this section will be to show (in Theorem 72) that, given any function $d_1(n)$ and any function $D_2(n)$ satisfying $D_2(n) \geq 3 \forall n$, we have $\liminf_{n \rightarrow \infty} \mathbf{P}[P_{n,d_1,5,0,D_2} \text{ will be connected}] > 0$. An upper bound for this probability shall be deduced later, in Section 16, from results on components.

The proof of Theorem 72 will copy that of Proposition 5([16], 2.1), but will be slightly more complicated, as the upper bound on the maximum degree means that $\mathcal{P}(n, d_1, 5, 0, D_2)$ is not edge-addable (i.e. the class $\mathcal{P}(n, d_1, 5, 0, D_2)$ is not closed under the operation of inserting an edge between two components). Hence, we shall first prove (in Lemma 71) a very helpful result on short cycles, which will be extremely useful to us throughout Part II.

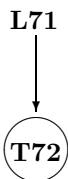

Figure 34: The structure of Section 13.

We shall now proceed with our aforementioned useful lemma:

Lemma 71 *Let $k < \frac{1}{15}$, and let S be a planar graph with at most $k|S|$ vertices of degree ≤ 2 . Then S must contain at least $(\frac{1-15k}{28})|S|$ cycles of size ≤ 6 . In particular, if S has $\leq \frac{|S|}{43}$ vertices of degree ≤ 2 then S must contain $\geq \frac{|S|}{43}$ cycles of size ≤ 6 .*

Proof Fix a planar embedding of S . We shall first show that this embedding must have at least $(\frac{1-15k}{14})|S|$ faces of size ≤ 6 (where, as usual, the ‘size’ of a face denotes the number of edges in the associated facial boundary, with an edge counted twice if it appears twice in the boundary), and we will later deduce the lemma from this fact.

We shall argue by contradiction. Let f_i denote the number of faces of size i and suppose that $\sum_{i \leq 6} f_i < (\frac{1-15k}{14})|S|$. We have

$$\begin{aligned}
2e(S) &= \sum_i i f_i \\
&\geq 7 \sum_{i \geq 7} f_i \\
&> 7 \left(\sum_i f_i - \left(\frac{1-15k}{14} \right) |S| \right), \text{ by our supposition} \\
&= 7 \left(e(S) - |S| + \kappa(S) + 1 - \left(\frac{1-15k}{14} \right) |S| \right), \text{ by Euler's formula} \\
&> 7 \left(e(S) - \left(\frac{15(1-k)}{14} \right) |S| \right).
\end{aligned}$$

Thus, $(\frac{15(1-k)}{2})|S| > 5e(S)$. But $e(S) \geq \frac{3(1-k)|S|}{2}$, since S contains at least $(1-k)|S|$ vertices of degree ≥ 3 , and so $5e(S) \geq (\frac{15(1-k)|S|}{2})$. Thus, we obtain our desired contradiction, and so we must have at least $(\frac{1-15k}{14})|S|$ faces of size ≤ 6 .

Let us now consider these faces of size ≤ 6 . Note that the boundary of a face of size ≤ 6 must contain a cycle of size ≤ 6 as a subgraph unless it is acyclic, in which case it must be the entire graph S . But if S were acyclic, then at least half of the vertices would have degree ≤ 2 (since we would have $e(S) \leq |S| - 1$), and this would contradict the conditions of this lemma. Thus, for each of our faces of size ≤ 6 , the boundary must contain a cycle of size ≤ 6 as a subgraph.

Each edge of S can only be in at most two faces of the embedding, and so each cycle can only be in at most two faces. Thus, S must contain at least $(\frac{1-15k}{28})|S|$ *distinct* cycles of size ≤ 6 . \square

Note that Lemma 71 does not hold for general graphs, since it is known (see, for example, Corollary 11.2.3 of [5]) that there exist graphs that have both arbitrarily large minimum degree and arbitrarily large girth.

We shall now use Lemma 71 to obtain our aforementioned lower bound for the probability that $P_{n,d_1,5,0,D_2}$ will be connected (we shall state the result in a slightly different form to that advertised earlier, for ease with Section 14):

Theorem 72 *There exists a constant $c > 0$ such that, given any constants $r, d_1, D_2 \in \mathbf{N} \cup \{0\}$ with $D_2 \geq 3$ and $\mathcal{P}(r, d_1, 5, 0, D_2) \neq \emptyset$,*

$$\mathbf{P}[P_{r,d_1,5,0,D_2} \text{ will be connected}] > c.$$

Sketch of Proof We shall choose any $r, d_1, D_2 \in \mathbf{N} \cup \{0\}$ with $D_2 \geq 3$ and show that there are many ways to construct a graph in $\mathcal{P}(r, d_1, 5, 0, D_2)$ with $k - 1$ components from a graph in $\mathcal{P}(r, d_1, 5, 0, D_2)$ with k components, by combining two components. Our stated lower bound for the proportion of graphs with exactly one component will then follow by ‘cascading’ this result downwards.

If $D_2 > 6$, we shall see that we may obtain sufficiently many ways to combine components simply by inserting edges between them that don't interfere with this upper bound on the maximum degree.

If $D_2 \leq 6$, we will sometimes also delete an edge from a small cycle in order to maintain $\Delta \leq D_2$. We shall use Lemma 71 to show that we have lots of choices for this small cycle, and then the fact that it is small (combined with the knowledge that $D_2 < 7$) will help us to bound the amount of double-counting.

Full Proof Choose any $r, d_1, D_2 \in \mathbf{N} \cup \{0\}$ with $D_2 \geq 3$. We shall show that there exists a strictly positive constant c , independent of r, d_1 and D_2 , such that $\mathbf{P}[P_{r,d_1,5,0,D_2}$ will be connected] $> c$.

Let $\mathcal{P}^t(r, d_1, 5, 0, D_2)$ denote the set of graphs in $\mathcal{P}(r, d_1, 5, 0, D_2)$ with exactly t components. For $k > 1$, we shall construct graphs in $\mathcal{P}^{k-1}(r, d_1, 5, 0, D_2)$ from graphs in $\mathcal{P}^k(r, d_1, 5, 0, D_2)$.

Let $G \in \mathcal{P}^k(r, d_1, 5, 0, D_2)$ and let us denote the k components of G by S_1, S_2, \dots, S_k , where $|S_i| = n_i \forall i$. Without loss of generality, we may assume that S_1, S_2, \dots, S_k are ordered so that S_i contains $\geq \frac{n_i}{43}$ vertices of degree $< D_2$ iff $i \leq l$, for some fixed $l \in \{0, 1, \dots, k\}$. Note that we must have $l = k$ if $D_2 > 6$, since (by planarity) $e(S_i) < 3n_i$ and so we can only have at most $\frac{6n_i}{7}$ vertices of degree ≥ 7 .

For $1 \leq i < j \leq k$, let us construct a new graph $G_{i,j} \in \mathcal{P}^{k-1}(r, d_1, 5, 0, D_2)$ as follows:

Case (a): if $j \leq l$ (note that this is always the case if $D_2 > 6$)

Insert an edge between a vertex in S_i of degree $< D_2$ (we have at least $\frac{n_i}{43}$ choices for this) and a vertex in S_j of degree $< D_2$ (we have at least $\frac{n_j}{43}$ choices for this).

The constructed graph $G_{i,j}$ (see Figure 35) is planar and has exactly $k - 1$ components. It is also clear that we have $d_1 \leq \delta(G_{i,j}) \leq \Delta(G_{i,j}) \leq D_2$, since we have not deleted any edges from the original graph and have only inserted an

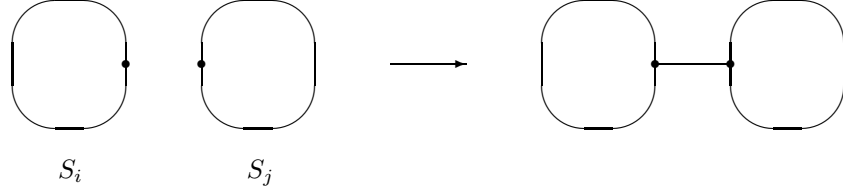

Figure 35: Constructing the graph $G_{i,j}$ in case (a).

edge between two vertices with degree $< D_2$. Thus, $G_{i,j} \in \mathcal{P}^{k-1}(r, d_1, 5, 0, D_2)$.

Case (b): if $j > l$ and $n_i > 1$ (in which case $D_2 \leq 6$)

If $j > l$, then S_j contains $< \frac{n_j}{43}$ vertices of degree $< D_2$. Thus, by Lemma 71, S_j must contain at least $\frac{n_j}{43}$ cycles of size ≤ 6 . Delete an edge uv in one of these cycles (we have at least $\frac{3}{D_2+D_2^2+D_2^3+D_2^4} \frac{n_j}{43} \geq \frac{3}{6+6^2+6^3+6^4} \frac{n_j}{43}$ choices for this edge, since each cycle must contain at least 3 edges and each edge is in at most $(D_2 - 1)^{m-2} < D_2^{m-2}$ cycles of size m), insert an edge between u and a vertex $w \in S_i$ (we have n_i choices for w), delete an edge between w and $x \in \Gamma(w)$ (we have at least one choice for x , since $n_i > 1$), and insert an edge between x and v (planarity is preserved, since we may draw S_j so that the face containing u and v is on the outside, and similarly we may draw S_i so that the face containing w and x is on the outside).

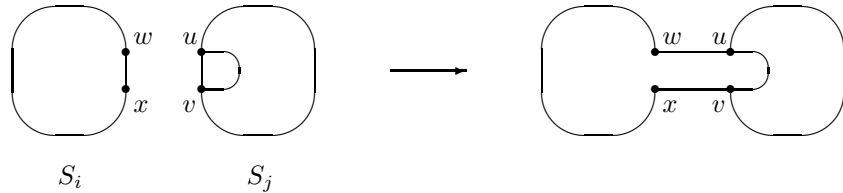

Figure 36: Constructing the graph $G_{i,j}$ in case (b).

Since the deleted edge uv was in a cycle, it was not a cut-edge, and so the vertex set $V(S_j)$ is still connected. The deleted edge wx may have been a cut-

edge in S_i , but since we have also inserted edges from w to $u \in V(S_j)$ and from x to $v \in V(S_j)$ it must be that the vertex set $V(S_i) \cup V(S_j)$ is now connected. Thus, the constructed planar graph $G_{i,j}$ has exactly $k - 1$ components. By construction, the degrees of the vertices have not changed, and so we have $d_1 \leq \delta(G_{i,j}) \leq \Delta(G_{i,j}) \leq D_2$. Thus, $G_{i,j} \in \mathcal{P}^{k-1}(r, d_1, 5, 0, D_2)$.

Case (c): if $j > l$ and $n_i = 1$ (in which case $D_2 \leq 6$)

Delete any edge uv in S_j (we have at least n_j choices for this, since S_j cannot be a forest if $j > l$) and insert edges uw and vw , where w is the unique vertex in S_i .

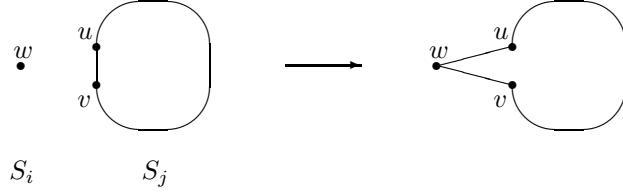

Figure 37: Constructing the graph $G_{i,j}$ in case (c).

The constructed graph $G_{i,j}$ is planar and has exactly $k - 1$ components. The degrees have not changed, except that we now have $\deg(w) = 2$. But since $D_2 \geq 3$, we still have $d_1 \leq \delta(G_{i,j}) \leq \Delta(G_{i,j}) \leq D_2$. Thus, $G_{i,j} \in \mathcal{P}^{k-1}(r, d_1, 5, 0, D_2)$.

Let $z = \frac{3}{43(6+6^2+6^3+6^4)} = \min \left\{ \left(\frac{1}{43} \right)^2, \frac{3}{43(6+6^2+6^3+6^4)} \right\}$. Then in all cases we have at least $zn_i n_j$ choices when constructing the new graph. Thus, from our initial graph G , we have at least $\sum_{i < j} zn_i n_j = z \sum_{i < j} n_i n_j$ ways to construct a graph in $\mathcal{P}^{k-1}(r, d_1, 5, 0, D_2)$. Note that if $x \leq y$ then $xy > (x - 1)(y + 1)$, so $\sum_{i < j} n_i n_j$ is at least what it would be if one component in G had order $r - (k - 1)$ and the other $k - 1$ components were isolated vertices. Thus, $z \sum_{i < j} n_i n_j \geq z \left(\frac{1}{2}(k - 1)(k - 2) + (k - 1)(r - k + 1) \right) = (k - 1) \left(r - \frac{k}{2} \right) z$. Therefore, for $k > 1$, we have at least $(k - 1) \left(r - \frac{k}{2} \right) z |\mathcal{P}^k(r, d_1, 5, 0, D_2)| \geq (k - 1) \frac{r}{2} z |\mathcal{P}^k(r, d_1, 5, 0, D_2)|$ ways to construct a graph in $\mathcal{P}^{k-1}(r, d_1, 5, 0, D_2)$.

Given one of our constructed graphs, there are at most 3 possibilities for how the graph was obtained (case (a), (b) or (c)).

If case (a) was used (which must be so if $D_2 > 6$), then we can re-obtain the original graph simply by deleting the inserted edge, for which there are at most $r - (k - 1) < r$ possibilities, since it must now be a cut-edge. Thus, if case (a) was used, we have $< r$ possibilities for the original graph.

If case (b) was used, then we can re-obtain the original graph by locating the vertices u, v, w and x , deleting the two inserted edges (uw and vx) and re-inserting the two deleted edges (uv and wx). Note that we have at most r possibilities for which vertex is u . We know that u and v were originally on a cycle of size ≤ 6 , and so v is still at distance at most 5 from u . Since the graph has maximum degree at most D_2 , we therefore have at most $D_2^2 + D_2^3 + D_2^4 + D_2^5$ possibilities for v . Once we have located u and v , we then have at most D_2 possibilities for w and at most D_2 possibilities for x , since w and x are now neighbours of u and v , respectively. Thus, if case (b) was used, we have at most $D_2^2(D_2^2 + D_2^3 + D_2^4 + D_2^5)r \leq 36(6^2 + 6^3 + 6^4 + 6^5)r$ possibilities for the original graph.

If case (c) was used, then we can re-obtain the original graph by locating the vertices u, v and w , deleting the two inserted edges (uw and vw) and re-inserting the deleted edge (uv). We have at most r possibilities for which vertex is w , and given w we then know which edges to delete and insert, as v and w are the only vertices adjacent to u . Thus, if case (c) was used, we have $\leq r$ possibilities for the original graph.

Therefore, there are $< r$ possibilities for the original graph if $D_2 > 6$, since case (a) must have been used, and $< r + 36(6^2 + 6^3 + 6^4 + 6^5)r + r = 2r(1 + 18(6^2 + 6^3 + 6^4 + 6^5))$ possibilities for the original graph if $D_2 \leq 6$, since any of case (a), case (b) or case (c) may have been used.

Let $\alpha = \frac{z}{4(1+18(6^2+6^3+6^4+6^5))} = \min \left\{ \frac{z}{2}, \frac{z}{4(1+18(6^2+6^3+6^4+6^5))} \right\}$. Then we have shown that we can construct at least $\alpha(k-1)|\mathcal{P}^k(r, d_1, 5, 0, D_2)|$ *distinct* graphs in $|\mathcal{P}^{k-1}(r, d_1, 5, 0, D_2)|$, and so we find that it must be that we have $|\mathcal{P}^{k-1}(r, d_1, 5, 0, D_2)| \geq \alpha(k-1)|\mathcal{P}^k(r, d_1, 5, 0, D_2)| \forall k > 1$.

Let us define p_k to be $\frac{|\mathcal{P}^{k+1}(r, d_1, 5, 0, D_2)|}{|\mathcal{P}(r, d_1, 5, 0, D_2)|}$ and let $p = p_0 = \frac{|\mathcal{P}^1(r, d_1, 5, 0, D_2)|}{|\mathcal{P}(r, d_1, 5, 0, D_2)|} = \mathbf{P}[P_{r, d_1, 5, 0, D_2}$ will be connected]. From the previous paragraph, we know that $|\mathcal{P}^{k+1}(r, d_1, 5, 0, D_2)| \leq \frac{|\mathcal{P}^k(r, d_1, 5, 0, D_2)|}{\alpha k} \forall k > 0$, and so $p_k \leq \frac{p}{\alpha^k k!} \forall k \geq 0$. We must have $\sum_{k \geq 0} p_k = 1$, so $\sum_{k \geq 0} \frac{p}{\alpha^k k!} \geq 1$ and hence $p \geq \left(\sum_{k \geq 0} \frac{(\frac{1}{\alpha})^k}{k!} \right)^{-1} = e^{-\frac{1}{\alpha}}$. \square

14 Growth Constants

We shall now look at the topic of ‘growth constants’, which will play a vital role in the proofs of Section 15. We already know from Section 3 that there exists a finite growth constant $\gamma_l > 0$ such that $\left(\frac{|\mathcal{P}(n,0,5,0,n-1)|}{n!}\right)^{1/n} \rightarrow \gamma_l$ as $n \rightarrow \infty$. In this section, we shall use our connectivity bound from Theorem 72 to also obtain (in Theorems 75 and 76) growth constants for $\mathcal{P}(n, d_1, 5, 0, D_2)$ for the case when $d_1(n)$ is a constant and $D_2(n)$ is any monotonically non-decreasing function (it will turn out that the result for this restricted case is all that will be required for our later sections).

Clearly, we shall have to treat the case when $d_1(n) = D_2(n) \in \{3, 5\}$ slightly differently, since $\mathcal{P}(n, d_1, 5, 0, D_2)$ will be empty if n is odd. Hence, we will deal first with the more standard case in Theorem 75, and then separately with this special case in Theorem 76. In both of these cases, we shall follow the proof of Theorem 3.3 of [16], which will require us to first state two useful lemmas (Proposition 73 and Corollary 74).

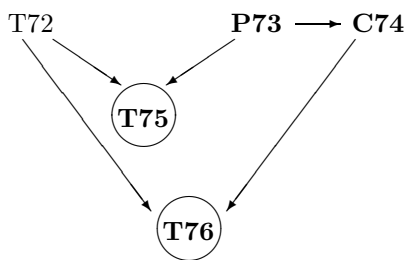

Figure 38: The structure of Section 14.

As mentioned, the following result on supermultiplicative functions shall be very useful:

Proposition 73 (implicit in [19], 11.6) *Let $f : \mathbf{N} \rightarrow \mathbf{R}^+$ be a function such that $f(n) > 0$ for all large n and $f(i + j) \geq f(i) \cdot f(j) \forall i, j \in \mathbf{N}$. Then $(f(n))^{1/n} \rightarrow \sup_n ((f(n))^{1/n})$ as $n \rightarrow \infty$.*

We should also note an even parity version, which will be useful when $d_1(n) = D_2(n) \in \{3, 5\}$:

Corollary 74 *Let $f : \mathbf{N} \rightarrow \mathbf{R}^+$ be a function such that $f(2n) > 0$ for all large n and $f(2(i+j)) \geq f(2i) \cdot f(2j) \forall i, j \in \mathbf{N}$. Then $(f(2n))^{1/2n} \rightarrow \sup_n ((f(2n))^{1/2n})$ as $n \rightarrow \infty$.*

We may now use Proposition 73 to obtain our first growth constant result:

Theorem 75 *Let $d_1 \in \{0, 1, \dots, 5\}$ be a constant and let $D_2(n)$ be a monotonically non-decreasing integer-valued function that for all large n satisfies $D_2(n) \geq \max\{d_1, 3\}$ and $(d_1, D_2(n)) \notin \{(3, 3), (5, 5)\}$. Then there exists a finite constant $\gamma_{d_1, D_2} > 0$ such that*

$$\left(\frac{|\mathcal{P}(n, d_1, 5, 0, D_2)|}{n!} \right)^{\frac{1}{n}} \rightarrow \gamma_{d_1, D_2} \text{ as } n \rightarrow \infty.$$

Proof We shall copy the method of proof of Theorem 3.3 of [16]. Let c be the constant given by Theorem 72 and let $g(n, d_1, D_2) = \frac{c^2 |\mathcal{P}(n, d_1, 5, 0, D_2)|}{2 \cdot n!} \forall n \in \mathbf{N}$. We shall show that $g(n, d_1, D_2)$ satisfies the conditions of Proposition 73, which we shall then use to deduce our result.

To show that $g(n, d_1, D_2) > 0$ for all large n , it suffices to show that $\mathcal{P}(n, d_1, 5, 0, D_2)$ is non-empty for all large n . We shall now see that we only need to prove this for three values of $(d_1, D_2(n))$:

- (i) If $d_1 < 3$, then $\mathcal{P}(n, d_1, 5, 0, D_2) \supset \mathcal{P}(n, 2, 5, 0, 2)$ for all large n , since $D_2(n) \geq 3$ for all large n .
- (ii) If $d_1 \in \{3, 4\}$, then $D_2(n)$ must be at least 4 for all large n (since $(d_1, D_2(n))$ is not allowed to be $(3, 3)$ for large n) and so $\mathcal{P}(n, d_1, 5, 0, D_2) \supset \mathcal{P}(n, 4, 5, 0, 4)$ for all large n .
- (iii) If $d_1 = 5$, then $D_2(n)$ must be at least 6 for all large n (since $(d_1, D_2(n))$ is not allowed to be $(5, 5)$ for large n), and so $\mathcal{P}(n, d_1, 5, 0, D_2) \supset \mathcal{P}(n, 5, 5, 0, 6)$ for all large n .

Thus, it suffices just to show that $\mathcal{P}(n, 2, 5, 0, 2)$, $\mathcal{P}(n, 4, 5, 0, 4)$ and $\mathcal{P}(n, 5, 5, 0, 6)$ are all non-empty for sufficiently large n .

Clearly $\mathcal{P}(n, 2, 5, 0, 2) \supset C_n$, so certainly $|\mathcal{P}(n, 2, 5, 0, 2)| > 0 \forall n \geq 3$. It is shown in [18] that there exist 4-regular planar graphs of order $n \forall n \geq 6$ apart from $n = 7$, so we also have $|\mathcal{P}(n, 4, 5, 0, 4)| > 0 \forall n \geq 8$. For n of the form $25x + 37y$, graphs in $\mathcal{P}(n, 5, 5, 0, 6)$ can be constructed from 5-regular planar graphs as shown in Figure 39, so (since 25 and 37 are co-prime) it follows

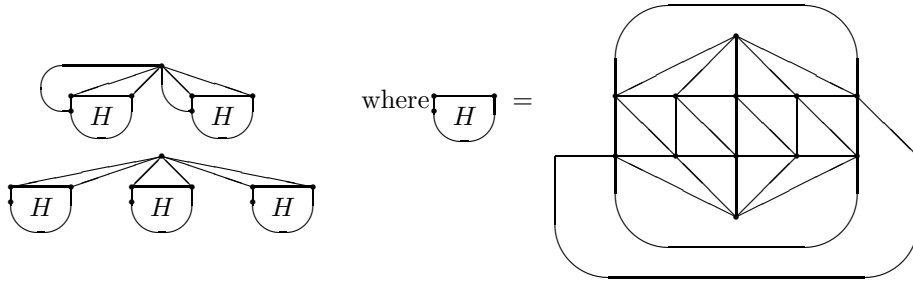

Figure 39: A graph in $\mathcal{P}(n, 5, 5, 0, 6)$.

that we have $|\mathcal{P}(n, 5, 5, 0, 6)| > 0$ for all sufficiently large n too. Hence, we have $g(n, d_1, D_2) > 0$ for all large n for all allowable $(d_1, D_2(n))$.

We shall now show that g satisfies the supermultiplicative condition:

Let $i, j \in \mathbf{N}$ and let us denote by $\mathcal{P}_c(i, d_1, 5, 0, D_2)$ and $\mathcal{P}_c(j, d_1, 5, 0, D_2)$ the set of connected graphs in $\mathcal{P}(i, d_1, 5, 0, D_2)$ and $\mathcal{P}(j, d_1, 5, 0, D_2)$, respec-

tively. Then, by Theorem 72, we know that there exists a constant $c > 0$ such that we have $|\mathcal{P}_c(i, d_1, 5, 0, D_2)| \geq c|\mathcal{P}(i, d_1, 5, 0, D_2)|$ and $|\mathcal{P}_c(j, d_1, 5, 0, D_2)| \geq c|\mathcal{P}(j, d_1, 5, 0, D_2)|$. We may form a graph in $\mathcal{P}(i + j, d_1, 5, 0, D_2)$ by choosing i of the $i + j$ vertices $\left(\binom{i+j}{i} \text{ choices}\right)$, placing a connected planar graph G_1 with $|G_1| = i$ and $d_1 \leq \delta(G_1) \leq \Delta(G_1) \leq D_2(i)$ on the chosen vertices ($|\mathcal{P}_c(i, d_1, 5, 0, D_2)| \geq c|\mathcal{P}(i, d_1, 5, 0, D_2)|$ choices), and then placing a connected planar graph G_2 with $|G_2| = j$ and $d_1 \leq \delta(G_2) \leq \Delta(G_2) \leq D_2(j)$ on the remaining j vertices ($|\mathcal{P}_c(j, d_1, 5, 0, D_2)| \geq c|\mathcal{P}(j, d_1, 5, 0, D_2)|$ choices). If $i = j$, then we need to divide by two to avoid double-counting. Note that the constructed graph will have maximum degree at most $\max\{D_2(i), D_2(j)\}$ and so will indeed be in $\mathcal{P}(i + j, d_1, 5, 0, D_2)$, since D_2 is a monotonically non-decreasing function. Thus,

$$|\mathcal{P}(i + j, d_1, 5, 0, D_2)| \geq \frac{c^2}{2} \binom{i+j}{i} |\mathcal{P}(i, d_1, 5, 0, D_2)| \cdot |\mathcal{P}(j, d_1, 5, 0, D_2)| \quad \forall i, j$$

and, therefore,

$$\begin{aligned} g(i + j, d_1, D_2) &= \frac{c^2 |\mathcal{P}(i + j, d_1, 5, 0, D_2)|}{2(i + j)!} \\ &\geq \frac{c^4 \binom{i+j}{i} |\mathcal{P}(i, d_1, 5, 0, D_2)| |\mathcal{P}(j, d_1, 5, 0, D_2)|}{4(i + j)!} \\ &= \frac{c^2 |\mathcal{P}(i, d_1, 5, 0, D_2)|}{2 \cdot i!} \frac{c^2 |\mathcal{P}(j, d_1, 5, 0, D_2)|}{2 \cdot j!} \\ &= g(i, d_1, D_2) \cdot g(j, d_1, D_2). \end{aligned}$$

Let $\gamma_{d_1, D_2} = \sup_n ((g(n, d_1, D_2))^{1/n})$. By Proposition 73, it now only remains to show that $\gamma_{d_1, D_2} < \infty$. But clearly $\mathcal{P}(n, d_1, 5, 0, D_2) \subset \mathcal{P}(n, 0, 5, 0, n-1)$, so $\gamma_{d_1, D_2} \leq \gamma_l < \infty$. \square

We may obtain an analogous result to Theorem 75 for the case when we have $D_2(n) = d_1 \in \{3, 5\} \forall n$ by using Corollary 74 instead of Proposition 73:

Theorem 76 *Let $D_2 \in \{3, 5\}$ be a fixed constant. Then there is a finite constant $\gamma_{D_2, D_2} > 0$ such that*

$$\left(\frac{|\mathcal{P}(2n, D_2, 5, 0, D_2)|}{(2n)!} \right)^{\frac{1}{2n}} \rightarrow \gamma_{D_2, D_2} \text{ as } n \rightarrow \infty.$$

Proof The method of proof is exactly the same as that of Theorem 75. Thus, it suffices to show that $\mathcal{P}(n, 3, 5, 0, 3)$ and $\mathcal{P}(n, 5, 5, 0, 5)$ are non-empty for sufficiently large even n . But it has already been shown in [18] that there exist 3-regular planar graphs of order n for all even $n \geq 4$ and that there exist 5-regular planar graphs of order n for all even $n \geq 12$ apart from $n = 14$. Thus, we are done. \square

15 Appearances

We shall now look at appearances in $P_{n,d_1,5,0,D_2}$. Recall from Proposition 4 that, for any connected planar graph H , $P_{n,0,5,0,n-1}$ will a.a.s. have at least linearly many appearances of H . In this section, we will prove two similar appearance-type results, Theorems 83 and 88, for $P_{n,d_1,5,0,D_2}$ (these final results will not require the monotonicity/constancy conditions that we imposed in the previous section, but such restrictions will be used in lemmas along the way). In Section 16, we shall then aim to turn some of these appearances into components.

We will produce separate appearance-type results for the cases when we have $d_1(n) < D_2(n) \forall n$ (Theorem 83) and when $d_1(n) = D_2(n) \forall n$ (Theorem 88). This is essentially because for the latter case it will be awkward to convert appearances into components in Section 16 without violating our bound on $d_1(n)$, and so we instead introduce the concept of ‘2-appearances’ (see Definition 84).

We will deal with the $d_1(n) < D_2(n)$ case first, starting with a simple lemma (Lemma 78) concerning the number of intersections of appearances. The main work will then be done in Lemma 80, where we shall copy a proof of [16] (using the growth constants of Section 14) to obtain an appearance result for the case when $d_1(n)$ is a constant and $D_2(n)$ is a monotonically non-decreasing function. We shall then extend this to a more general result in Lemma 81, before finally achieving the full result of Theorem 83.

The $d_1(n) = D_2(n)$ case will follow a similar pattern. First, we shall note two lemmas (Lemmas 85 and Corollary 86) on the number of intersections of 2-appearances, before then using our growth constant results to obtain a weak 2-appearance result (Lemma 87), which we shall then extend to Theorem 88.

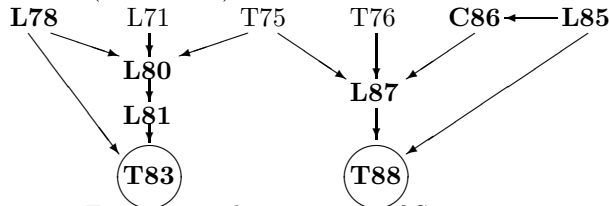

Figure 40: The structure of Section 15.

We start with some definitions that we will find helpful:

Definition 77 Suppose H appears at W in G and let the unique edge in G between W and $V(G) \setminus W$ be $e_W = r_W v_W$, where $r_W \in W$ and $v_W \in V(G) \setminus W$. Let us call e_W the **associated cut-edge** of the appearance, let us call $TV_W := W \cup \{v_W\}$ the **total vertex set** of the appearance and let us call $TE_W := E(G[W]) \cup \{e_W\}$ the **total edge set** of the appearance.

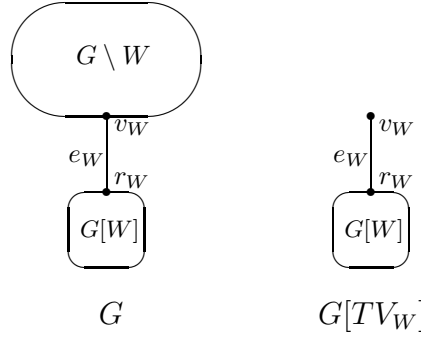

Figure 41: An appearance at W in G and its total vertex/edge set.

It is now easier to state the following useful result, which is given implicitly in the proof of Theorem 4.1 of [16]:

Lemma 78 The total edge set of an appearance of a graph of order $|H|$ will intersect (i.e. have an edge in common with) the total edge set of at most $|H|$ other appearances of graphs of order $|H|$.

Proof Suppose we have an appearance of a graph of order $|H|$ at $W \subset V(G)$. Let the associated cut-edge of the appearance be $e_W = r_W v_W$, where $r_W \in W$ and $v_W \in V(G) \setminus W$. Suppose that G also contains another appearance, at W_2 , of a graph of order $|H|$ and let the associated cut-edge of this appearance be $e_{W_2} = r_{W_2} v_{W_2}$, where $r_{W_2} \in W_2$ and $v_{W_2} \in V(G) \setminus W_2$.

(a) Suppose $e_{W_2} \notin TE_W$. Then $G[TV_W]$ is a connected subgraph in $G \setminus e_{W_2}$. Note that $G[W_2]$ is a component in $G \setminus e_{W_2}$. Thus, either $G[TV_W] \subset G[W_2]$, in which case we would obtain the contradiction $|W| + 1 = |TV_W| \leq |W_2| = |W|$, or $G[TV_W] \subset G \setminus W_2$, in which case the total edge set of W would not meet the total edge set of W_2 .

(b) Suppose $e_{W_2} = e_W$. Then, since $W_2 \neq W$, we must have $r_{W_2} = v_W$ and $v_{W_2} = r_W$, and so W_2 must be the component of $G \setminus e_W$ that contains v_W .

(c) Suppose $e_{W_2} \in E(G[W])$. Since e_{W_2} must be a cut-edge, there are at most $|W| - 1 = |H| - 1$ possibilities for it. Note that the ‘orientation’ of e_{W_2} must be chosen so that $r_W \in W_2$, since otherwise we would have $W_2 \subset W \setminus r_W$ and obtain the contradiction $|W \setminus r_W| \geq |W_2| = |W|$. Hence, since knowing e_{W_2} and its orientation determines W_2 , there can only be at most $|H| - 1$ possibilities for W_2 .

Thus, in total, there are at most $0 + 1 + (|H| - 1) = |H|$ possibilities for W_2 . \square

We shall shortly proceed with an appearance result for the case when we have $d_1(n) < D_2(n) \forall n$. As already mentioned, this will later be used (in Section 16) in proofs concerning the construction of components isomorphic to given H . Hence, with this in mind, we will make one more definition (which will help us later to delete certain edges without breaking our lower bound on the minimum degree):

Definition 79 *Given a connected planar graph H , a function $d_1(n)$, and a planar graph G , let $f_H^{d_1}(G)$ denote the number of appearances of H in G such that the associated cut-edge is between two vertices with $\deg_G > d_1(|G|)$.*

We are now finally ready to look at appearances in $P_{n,d_1,5,0,D_2}$. We shall start by assuming that $d_1(n)$ is constant and $D_2(n)$ is monotonically non-decreasing, as in Section 14, but we will later (in Theorem 81) get rid of these conditions. The statement of the result may seem complicated, but basically it just asserts that for any ‘sensible’ choice of H , there will probably be lots of appearances of H in $P_{n,d_1,5,0,D_2}$ such that the associated cut-edge is between two vertices with degree $> d_1$. Clearly, ‘sensible’ entails that we must have $\delta(H) \geq d_1$, $\Delta(H) \leq D_2(n)$ and $\deg_H(1) + 1 \leq D_2(n)$, and as always we will require that $D_2(n) \geq 3$ (note that it follows from these conditions that we also have $d_1 < D_2(n)$). The proof is based on that of Theorem 4.1 of [16].

Lemma 80 *Let H be a fixed connected planar graph on $\{1, 2, \dots, h\}$. Then $\exists \alpha(h) > 0$ such that, given any constant $d_1 \leq \delta(H)$ and any monotonically non-decreasing integer-valued function $D_2(n)$ satisfying $\liminf_{n \rightarrow \infty} D_2(n) \geq \max\{\Delta(H), \deg_H(1) + 1, 3\}$, we have*

$$\mathbf{P}[f_H^{d_1}(P_{n,d_1,5,0,D_2}) \leq \alpha n] < e^{-\alpha n} \text{ for all sufficiently large } n.$$

Sketch of Proof We choose a specific α and suppose that the result is false for $n = k$, where k is suitably large. Using Theorem 75, it then follows that there are many graphs $G \in \mathcal{P}(k, d_1, 5, 0, D_2)$ with $f_H^{d_1}(G) \leq \alpha k$.

From each such G , we construct graphs in $\mathcal{P}((1 + \delta)k, d_1, 5, 0, D_2)$, for a fixed $\delta > 0$. If G has lots of vertices with degree $< D_2(k)$, then we do this simply by attaching appearances of H to some of these vertices. If G has few vertices with degree $< D_2(k)$, then we attach appearances of H to small cycles in G and also delete appropriate edges. By Lemma 71, we have lots of choices for these small cycles and, since G has few vertices with degree $< D_2(k)$, we may assume that we don’t interfere with any vertices of minimum degree.

The fact that the original graphs satisfied $f_H^{d_1} \leq \alpha k$, together with Lemma 78 and the knowledge that any deleted edges were in small cycles, is then used to show that there is not much double-counting, and so we find that we have

constructed so many graphs in $\mathcal{P}((1 + \delta)k, d_1, 5, 0, D_2)$ that we contradict Theorem 75.

Full Proof Let $p < \frac{1}{7(6^2+6^3+6^4+6^5)}$, let $\beta = \frac{344\epsilon^2(h+7)(6^2+6^3+6^4+6^5)h!(\gamma h)^h}{p}$, and let α be a fixed constant in $(0, \frac{1}{\beta})$. Then we have $\alpha\beta < 1$ and so $\exists \epsilon \in (0, \frac{1}{3})$ such that $(\alpha\beta)^\alpha = 1 - 3\epsilon$.

By Theorem 75, $\exists N$ such that

$$(1 - \epsilon)^n n! (\gamma_{d_1, D_2})^n \leq |\mathcal{P}(n, d_1, 5, 0, D_2)| \leq (1 + \epsilon)^n n! (\gamma_{d_1, D_2})^n \quad \forall n \geq N. \quad (15)$$

Suppose (aiming for a contradiction) that we can find a value $k > N$ such that $\mathbf{P}[f_H^{d_1}(P_{k, d_1, 5, 0, D_2}) \leq \alpha k] \geq e^{-\alpha k}$, and let \mathcal{G} denote the set of graphs in $\mathcal{P}(k, d_1, 5, 0, D_2)$ such that $G \in \mathcal{G}$ iff $f_H^{d_1}(G) \leq \alpha k$. Then we must have $|\mathcal{G}| \geq e^{-\alpha k} |\mathcal{P}(k, d_1, 5, 0, D_2)| \geq e^{-\alpha k} (1 - \epsilon)^k k! (\gamma_{d_1, D_2})^k$.

Let $\delta = \frac{\lceil \alpha k \rceil h}{k}$. We may assume that k is sufficiently large that $\lceil \alpha k \rceil \leq 2\alpha k$. Thus, $\delta \leq 2\alpha h < 1$ (by our definition of α). This fact will be useful later.

We shall construct graphs in $\mathcal{P}((1 + \delta)k, d_1, 5, 0, D_2)$:

Choose δk special vertices (we have $\binom{(1+\delta)k}{\delta k}$ choices for these) and partition them into $\lceil \alpha k \rceil$ unordered blocks of size h (we have $\binom{\delta k}{h, \dots, h} \frac{1}{\lceil \alpha k \rceil!}$ choices for this). On each of the blocks, put a copy of H such that the increasing bijection from $\{1, 2, \dots, h\}$ to the block is an isomorphism between H and this copy. Note that we may assume that k is large enough that $D_2(k) \geq \liminf_{n \rightarrow \infty} D_2(n)$, and so the root, r_B , of a block (i.e. the lowest numbered vertex in it) satisfies $\deg(r_B) < D_2(k)$, by the conditions of the theorem. On the remaining k vertices, we place a planar graph G with $d_1 \leq \delta(G) \leq \Delta(G) \leq D_2(k)$ and $f_H^{d_1}(G) \leq \alpha k$ (we have at least $|\mathcal{G}|$ choices for this).

We shall continue our construction in one of two ways, depending on the number of vertices of degree $D_2(k)$ in G :

Case (a): If G has $\geq \frac{pk}{43}$ vertices of degree $< D_2(k)$ (note that this is certainly the case if $D_2(k) \geq 7$).

For each block B , we choose a *different* non-special vertex $v_B \in V(G)$ with $\deg(v_B) < D_2(k)$ (we have $\geq \binom{pk/43}{\lceil \alpha k \rceil} \lceil \alpha k \rceil!$ choices for this, since certainly $\alpha < \frac{p}{86}$ and we may assume that k is large enough that $\lceil \alpha k \rceil \leq 2\alpha k$), and we insert the edge $r_B v_B$ from the root of the block to this vertex, creating an appearance of H at B (we should note for later use that r_B and v_B will now clearly both have degree $> d_1$). Note that we have not deleted any edges, so

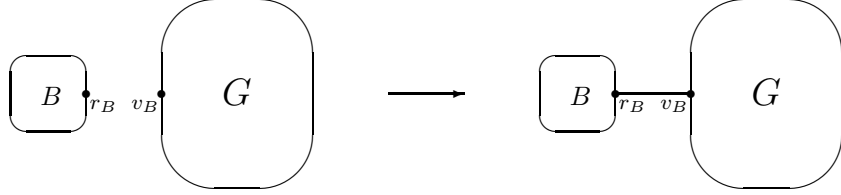

Figure 42: Creating an appearance of H at B in case (a).

we shall still have minimum degree at least d_1 , and we have only inserted edges between vertices of degree $< D_2(k)$, so we still have maximum degree at most $D_2(k)$, which is at most $D_2((1 + \delta)k)$ by monotonicity of D_2 . Thus, our new graph is indeed in $\mathcal{P}((1 + \delta)k, d_1, 5, 0, D_2)$.

Hence, for each graph G with $\geq \frac{pk}{43}$ vertices of degree $< D_2(k)$, we find that we can construct at least $\binom{(1+\delta)k}{\delta k} \binom{\delta k}{h \dots h} \cdot \frac{1}{\lceil \alpha k \rceil!} \cdot \binom{pk/43}{\lceil \alpha k \rceil} \lceil \alpha k \rceil!$ different graphs in $\mathcal{P}((1 + \delta)k, d_1, 5, 0, D_2)$.

Case (b): If G has $< \frac{pk}{43}$ vertices of degree $< D_2(k)$ (in which case $D_2(k) < 7$). Before describing the case (b) continuation of our construction, it shall first be useful to investigate the number of short cycles in G :

If G has $< \frac{pk}{43} < \frac{k}{43}$ vertices of degree $< D_2(k)$, then (by Lemma 71) G contains at least $\frac{k}{43}$ cycles of size at most 6. A vertex can only be in at most $(D_2(k))^2 + (D_2(k))^3 + (D_2(k))^4 + (D_2(k))^5 \leq 6^2 + 6^3 + 6^4 + 6^5$ cycles of size

at most 6, so G must have at most $\frac{pk(6^2+6^3+6^4+6^5)}{43}$ cycles of size at most 6 that contain a vertex of degree $< D_2(k)$. In particular, G must have at least $\frac{(1-(6^2+6^3+6^4+6^5)p)k}{43}$ cycles of size at most 6 that don't contain a vertex of degree d_1 , since $d_1 \leq \delta(H) < \deg_H(1) + 1 \leq D_2(k)$. Since a vertex can only be in at most $6^2 + 6^3 + 6^4 + 6^5$ cycles of size at most 6, each cycle of size at most 6 can only have a vertex in common with at most $6(6^2 + 6^3 + 6^4 + 6^5)$ other cycles of size at most 6. Thus, G must have a set of at least $\frac{\left(\frac{1-(6^2+6^3+6^4+6^5)p}{6(6^2+6^3+6^4+6^5)}\right)k}{43} > \frac{pk}{43}$ *vertex-disjoint* cycles of size at most 6 that don't contain a vertex of degree d_1 (using the fact that $p < \frac{1}{7(6^2+6^3+6^4+6^5)}$). We shall call these cycles 'special'.

Recall that we have $\lceil \alpha k \rceil$ blocks isomorphic to H . For each block B , choose a *different* one of our 'special' cycles (we have $\geq \binom{pk/43}{\lceil \alpha k \rceil} \lceil \alpha k \rceil!$ choices for this), delete an edge $u_B v_B$ in the cycle and insert an edge $r_B v_B$ from the root of the block to a vertex v_B that was incident to the deleted edge, creating an appearance of H at B . Note that the deleted edge was between two vertices of

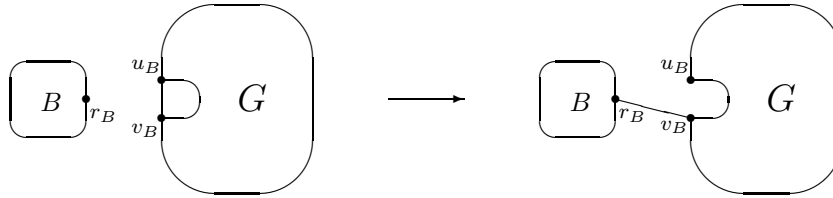

Figure 43: Creating an appearance of H at B in case (b).

degree $> d_1$, so we still have minimum degree at least d_1 (we should also note for later use that v_B will still have degree $> d_1$, and that r_B will now also have degree $> d_1$). Recall that the root of each block has degree $< D_2(k)$, so we still have maximum degree at most $D_2(k)$, which is at most $D_2((1 + \delta)k)$ by monotonicity of D_2 . Thus, our constructed graph is indeed in $\mathcal{P}((1 + \delta)k, d_1, 5, 0, D_2)$.

Thus, for each graph G with $< \frac{pk}{43}$ vertices of degree $< D_2(k)$, we find that we can construct at least $\binom{(1+\delta)k}{\delta k} \binom{\delta k}{h\dots h} \cdot \frac{1}{\lceil \alpha k \rceil!} \cdot \binom{pk/43}{\lceil \alpha k \rceil} \lceil \alpha k \rceil!$ different graphs in $\mathcal{P}((1 + \delta)k, d_1, 5, 0, D_2)$.

We have shown that, regardless of whether case (a) or case (b) is used, for each G we can construct at least

$$\begin{aligned}
& \binom{(1+\delta)k}{\delta k} \binom{\delta k}{h\dots h} \cdot \frac{1}{\lceil \alpha k \rceil!} \cdot \binom{pk/43}{\lceil \alpha k \rceil} \lceil \alpha k \rceil! \\
&= \frac{((1+\delta)k)!}{k!} \frac{1}{(h!)^{\lceil \alpha k \rceil}} \binom{pk/43}{\lceil \alpha k \rceil} \\
&\geq \frac{((1+\delta)k)!}{k!} \frac{1}{(h!)^{\lceil \alpha k \rceil}} \frac{(pk/43 - \lceil \alpha k \rceil + 1)^{\lceil \alpha k \rceil}}{\lceil \alpha k \rceil!} \\
&\geq \frac{((1+\delta)k)!}{k!} \frac{1}{(h!)^{\lceil \alpha k \rceil}} \left(\frac{pk}{86}\right)^{\lceil \alpha k \rceil} \frac{1}{\lceil \alpha k \rceil!} \\
&\quad \left(\text{since } \alpha < \frac{p}{86} \text{ and so } \frac{pk}{43} - \alpha k \geq \frac{pk}{86}\right) \\
&\geq \frac{((1+\delta)k)!}{k!} \left(\frac{pk}{86h! \lceil \alpha k \rceil}\right)^{\lceil \alpha k \rceil} \\
&\geq \frac{((1+\delta)k)!}{k!} \left(\frac{p}{172h! \alpha}\right)^{\lceil \alpha k \rceil} \\
&\quad (\text{since we may assume } k \text{ is large enough that } \lceil \alpha k \rceil \leq 2\alpha k)
\end{aligned}$$

different graphs in $\mathcal{P}((1+\delta)k, d_1, 5, 0, D_2)$. Thus, recalling that we have at least $e^{-\alpha k}(1-\epsilon)^k k! (\gamma_{d_1, D_2})^k$ choices for G , we can in total construct at least $e^{-\alpha k}(1-\epsilon)^k ((1+\delta)k)! (\gamma_{d_1, D_2})^k \left(\frac{p}{172h! \alpha}\right)^{\lceil \alpha k \rceil}$ (not necessarily distinct) graphs in $\mathcal{P}((1+\delta)k, d_1, 5, 0, D_2)$.

We are now at the half way point of our proof, and it remains to investigate the amount of double-counting, i.e. how many times each of our constructed graphs will have been built.

Given one of our constructed graphs, G' , there are at most 2 possibilities for how the graph was obtained (case (a) or case(b)).

If case (a) was used, then we can re-obtain the original graph, G , simply by deleting the $\lceil \alpha k \rceil$ appearances that were deliberately added. Recall that these appearances were constructed in such a way that the associated cut-edges are all between vertices with $\deg_{G'} > d_1$. Thus, in order to bound the amount of double-counting, we only need to investigate $f_H^{d_1}(G')$:

Suppose W is an appearance of H in G' such that the associated cut-edge e_W is between two vertices of degree $> d_1$. We shall consider how many possibilities there are for W :

(i) If we don't have $TE_W \subset E(G)$, then the total edge set of W must intersect the total edge set of one of our deliberately created appearances, and so we have at most $(h+1)\lceil \alpha k \rceil$ possibilities for W (including the possibility that W is one of our deliberately created appearances), by Lemma 78.

If $TE_W \subset E(G)$, then W must have been an appearance of H in G :

(ii) If W was an appearance of H in G such that e_W was already between two vertices of degree $> d_1$, then there are at most $\lceil \alpha k \rceil$ possibilities for W , by definition of \mathcal{G} .

(iii) If W was an appearance of H in G such that e_W was *not* already between two vertices of degree $> d_1$, then the unique vertex $v \in V(G') \setminus W$ incident to the root of W must have had $\deg(v) = d_1$ originally and must have been chosen as v_B by some block B . Hence, we have at most $\lceil \alpha k \rceil$ possibilities for v and thus at most $d_1 \lceil \alpha k \rceil$ possibilities for W .

Thus, if case (a) was used, then $f_H^{d_1}(G') \leq (h+d_1+2)\lceil \alpha k \rceil$, and so we have at most $\binom{(h+d_1+2)\lceil \alpha k \rceil}{\lceil \alpha k \rceil} \leq ((h+d_1+2)e)^{\lceil \alpha k \rceil} \leq ((h+7)e)^{\lceil \alpha k \rceil}$ possibilities for G .

If case (b) was used, we can re-obtain the original graph, G , by deleting the $\lceil \alpha k \rceil$ appearances that were deliberately added and re-inserting the $\lceil \alpha k \rceil$ deleted edges. Note that once we have identified the appearances that were deliberately added, we have at most $((D_2(k))^2 + (D_2(k))^3 + (D_2(k))^4 + (D_2(k))^5)^{\lceil \alpha k \rceil} \leq (6^2 + 6^3 + 6^4 + 6^5)^{\lceil \alpha k \rceil}$ possibilities for the edges that were deleted, since for each

appearance we will automatically know one endpoint, v , of the corresponding deleted edge and we know that the other endpoint, u , will now be at most distance 5 from v , since uv was originally part of a cycle of size ≤ 6 . Hence, as with case (a), it now remains to examine how many possibilities there are for the $\lceil \alpha k \rceil$ appearances that were deliberately added.

Suppose W is an appearance of H in G' such that the associated cut-edge e_W is between two vertices of degree $> d_1$.

(i) If we don't have $TE_W \subset E(G)$, then we have at most $(h + 1)\lceil \alpha k \rceil$ possibilities for W , as with case (a).

(ii) If $TE_W \subset E(G)$ and W was an appearance of H in G , then note that e_W must have already been between two vertices of degree $> d_1$, since it is clear that we have $\deg_{G'} \leq \deg_G$ for all vertices that were in $V(G)$. Hence, there are at most $\lceil \alpha k \rceil$ possibilities for W , by definition of \mathcal{G} .

(iii) If $TE_W \subset E(G)$ and W was *not* an appearance of H in G , then there must have originally been either another edge between W and $V(G) \setminus W$ other than e_W , or another edge between vertices in W . This deleted edge must be of the form $u_B v_B$ for some block B , and so W must contain either u_B or v_B (or both). However, if $v_B \in W$ then $r_B v_B$ would belong to the total edge set of W , which would contradict our assumption that $TE_W \subset E(G)$. Thus, $u_B \in W$ and $v_B \notin W$. Recall that the deleted edge $u_B v_B$ was originally part of a cycle

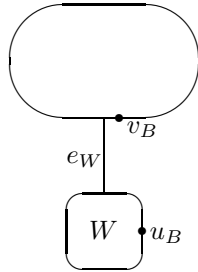

Figure 44: The appearance W in case (iii).

of size ≤ 6 and that no other edges from the same cycle were deleted. Thus,

there is still a $u_B - v_B$ path in G' consisting of the other edges in the cycle. But, since $u_B \in W$, $v_B \notin W$ and e_W is the unique edge between W and $G' \setminus W$, it must be that e_W belongs to this path, i.e. e_W must have been one of the other (at most 5) edges in the cycle. Thus, we have at most $5\lceil\alpha k\rceil$ possibilities for e_W , and hence for W (since e_W must be ‘oriented’ so that $v_B \notin W$).

Thus, if case (b) was used, then $f_H^{d_1}(G') \leq (h+7)\lceil\alpha k\rceil$, and so we have at most $\binom{(h+7)\lceil\alpha k\rceil}{\lceil\alpha k\rceil} (6^2 + 6^3 + 6^4 + 6^5)^{\lceil\alpha k\rceil} \leq ((h+7)(6^2 + 6^3 + 6^4 + 6^5)e)^{\lceil\alpha k\rceil}$ possibilities for G .

We have shown each graph in $\mathcal{P}((1+\delta)k, d_1, 5, 0, D_2)$ is constructed at most $((h+7)e)^{\lceil\alpha k\rceil} + ((h+7)(6^2+6^3+6^4+6^5)e)^{\lceil\alpha k\rceil} \leq 2((h+7)(6^2+6^3+6^4+6^5)e)^{\lceil\alpha k\rceil} \leq y^{\lceil\alpha k\rceil}$ times, where y denotes $2e(h+d_1+2)(6^2+6^3+6^4+6^5)$. Thus, the number of *distinct* graphs that we have constructed in $\mathcal{P}((1+\delta)k, d_1, 5, 0, D_2)$ must be

$$\begin{aligned}
&\geq e^{-\alpha k} (1-\epsilon)^k ((1+\delta)k)! (\gamma_{d_1, D_2})^k \left(\frac{p}{172h! \alpha y} \right)^{\lceil\alpha k\rceil} \\
&\geq e^{-\alpha k} (1-\epsilon)^k ((1+\delta)k)! (\gamma_{d_1, D_2})^{(1+\delta)k} (\gamma_{d_1, D_2})^{-\lceil\alpha k\rceil h} \left(\frac{p}{172h! \alpha y} \right)^{\lceil\alpha k\rceil}, \\
&\quad \text{since } \delta k = \lceil\alpha k\rceil h \\
&\geq (1-\epsilon)^k ((1+\delta)k)! (\gamma_{d_1, D_2})^{(1+\delta)k} \left(\frac{172eh! \alpha y (\gamma_{d_1, D_2})^h}{p} \right)^{-\lceil\alpha k\rceil}, \\
&\quad \text{since } e^{-\alpha k} \geq e^{-\lceil\alpha k\rceil} \\
&\geq (1-\epsilon)^k ((1+\delta)k)! (\gamma_{d_1, D_2})^{(1+\delta)k} (\alpha\beta)^{-\lceil\alpha k\rceil} \\
&\geq (1-\epsilon)^k ((1+\delta)k)! (\gamma_{d_1, D_2})^{(1+\delta)k} (\alpha\beta)^{-\alpha k}, \quad \text{since } \alpha\beta < 1 \\
&= \left(\frac{1-\epsilon}{1-3\epsilon} \right)^k ((1+\delta)k)! (\gamma_{d_1, D_2})^{(1+\delta)k}, \quad \text{since } (\alpha\beta)^\alpha = 1-3\epsilon \\
&\geq \left(\frac{1-\epsilon}{1-3\epsilon} \right)^k \frac{|\mathcal{P}((1+\delta)k, d_1, 5, 0, D_2)|}{(1+\epsilon)^{(1+\delta)k}}, \quad \text{by (15)} \\
&> \left(\frac{1-\epsilon}{(1-3\epsilon)(1+\epsilon)^2} \right)^k |\mathcal{P}((1+\delta)k, d_1, 5, 0, D_2)|, \quad \text{since } \delta < 1 \text{ (page 130)} \\
&> |\mathcal{P}((1+\delta)k, d_1, 5, 0, D_2)|, \quad \text{since } (1-3\epsilon)(1+\epsilon)^2 = 1-\epsilon-5\epsilon^2-3\epsilon^3.
\end{aligned}$$

Hence, we have our desired contradiction. \square

As mentioned, we shall now see that we can actually drop the conditions that $d_1(n)$ is a constant and $D_2(n)$ is monotonically non-decreasing:

Lemma 81 *Let H be a fixed connected planar graph on $\{1, 2, \dots, h\}$. Then $\exists \alpha(h) > 0$ such that, given any integer-valued functions $d_1(n)$ and $D_2(n)$ satisfying $\limsup_{n \rightarrow \infty} d_1(n) \leq \delta(H)$ and $\liminf_{n \rightarrow \infty} D_2(n) \geq \max\{\Delta(H), \deg_H(1) + 1, 3\}$, we have*

$$\mathbf{P}[f_H^{d_1}(P_{n,d_1,5,0,D_2}) \leq \alpha n] < e^{-\alpha n} \text{ for all sufficiently large } n.$$

Proof Suppose we can find a graph H and functions $d_1(n)$ and $D_2(n)$ that satisfy the conditions of this lemma, but not the conclusion, and let $\alpha = \alpha(h)$ be as given by Lemma 80. Then there exist arbitrarily large ‘bad’ n for which $\mathbf{P}[f_H^{d_1}(P_{n,d_1,5,0,D_2}) \leq \alpha n] \geq e^{-\alpha n}$.

Let n_1 be one of these bad n and let us try to find a bad $n_2 > n_1$ with $D_2(n_2) \geq D_2(n_1)$. Let us then try to find a bad $n_3 > n_2$ with $D_2(n_3) \geq D_2(n_2)$, and so on. We will either (a) obtain an infinite sequence $n_1, n_2, n_3 \dots$ with $n_1 < n_2 < n_3 < \dots$ and $D_2(n_1) \leq D_2(n_2) \leq D_2(n_3) \leq \dots$, or (b) we will find a value n_k such that all bad $n > n_k$ have $D_2(n) \leq D_2(n_k)$.

Note that we must have $d_1(n) \in \{0, 1, 2, 3, 4, 5\} \forall n$. Hence, in case (a) there must exist a constant d such that infinitely many of our n_i satisfy $d_1(n_i) = d$ (we shall call these n_i ‘special’). Let the function D_2^* be defined by setting $D_2^*(n) = D_2(n_1) \forall n \leq n_1$ and $D_2^*(n) = D_2(n_j) \forall n \in \{n_{j-1} + 1, n_{j-1} + 2, \dots, n_j\} \forall j > 1$. Then D_2^* is a monotonically non-decreasing integer-valued function satisfying $\liminf_{n \rightarrow \infty} D_2^*(n) \geq \liminf_{n \rightarrow \infty} D_2(n) \geq \max\{\Delta(H), \deg_H(1) + 1, 3\}$. Hence, since $d \leq \limsup_{n \rightarrow \infty} d_1(n) \leq \delta(H)$, by Lemma 80 it must be that we have $\mathbf{P}[f_H^d(P_{n,d,5,0,D_2^*}) \leq \alpha n] < e^{-\alpha n}$ for all sufficiently large n . But recall that our infinitely many ‘special’ n_i satisfy $(d, D_2^*(n_i)) = (d_1(n_i), D_2(n_i))$, and so $\mathbf{P}[f_H^d(P_{n_i,d,5,0,D_2^*}) \leq \alpha n_i] = \mathbf{P}[f_H^{d_1}(P_{n_i,d_1,5,0,D_2}) \leq \alpha n_i] \geq e^{-\alpha n_i}$ for these n_i . Thus, we obtain a contradiction.

In case (b), note that we have $d_1(n_i) \in \{0, 1, 2, 3, 4, 5\} \forall i$ and that we also have $D_2(n_i) \in \{3, 4, \dots, D_2(n_k)\} \forall i \geq k$. Hence, there must exist constants d and D such that infinitely many of our n_i satisfy $(d_1(n_i), D_2(n_i)) = (d, D)$. But by Lemma 80 we have $\mathbf{P}[f_H^d(P_{n,d,5,0,D}) \leq \alpha n] < e^{-\alpha n}$ for all large n , and so we again obtain a contradiction. \square

We will state a stronger version of this last result after one more definition:

Definition 82 *Given a connected planar graph H , a function $d_1(n)$, and a planar graph G , let $\widehat{f}_H^{d_1}(G)$ denote the maximum size of a set of totally edge-disjoint appearances of H in G such that the associated cut-edges are all between vertices with $\deg_G > d_1(|G|)$.*

Finally, we may now obtain our main theorem, which is the following stronger totally edge-disjoint version of Lemma 81:

Theorem 83 *Let H be a fixed connected planar graph on $\{1, 2, \dots, h\}$. Then $\exists \beta(H) > 0$ such that, given any integer-valued functions $d_1(n)$ and $D_2(n)$ satisfying $\limsup_{n \rightarrow \infty} d_1(n) \leq \delta(H)$ and $\liminf_{n \rightarrow \infty} D_2(n) \geq \max\{\Delta(H), \deg_H(1) + 1, 3\}$, we have*

$$\mathbf{P}[\widehat{f}_H^{d_1}(P_{n,d_1,5,0,D_2}) \leq \beta n] < e^{-\beta n} \text{ for all sufficiently large } n.$$

Proof The result follows from Lemmas 78 and 81 by taking $\beta = \frac{\alpha}{h+1}$. \square

We will now look at the case when $d_1(n) = D_2(n) \forall n$. We shall work towards a result similar to Theorem 83, but this time (again, to help us in Section 16) we will find it more convenient to look at the concept of ‘2-appearances’:

Definition 84 Let J be a connected graph on the vertices $\{1, 2, \dots, |J|\}$. Given a graph G , we say that J **2-appears** at $W \subset V(G)$ if (a) the increasing bijection from $\{1, 2, \dots, |J|\}$ to W gives an isomorphism between J and the induced subgraph $G[W]$ of G ; and (b) there are exactly two edges, $e_1 = r_1v_1$ and $e_2 = r_2v_2$, in G between $W \supset \{r_1, r_2\}$ and $V(G) \setminus W \supset \{v_1, v_2\}$, these edges are non-adjacent (i.e. $r_1 \neq r_2$ and $v_1 \neq v_2$), and v_1 and v_2 are also non-adjacent.

Let us call $\{e_1, e_2\}$ the **associated 2-edge-set** of the 2-appearance, let us call $TE_W^2 := E(G[W]) \cup \{e_1, e_2\}$ the **total edge set** of the 2-appearance and let us call $TV_W^2 := W \cup \{v_1, v_2\}$ the **total vertex set** of the 2-appearance.

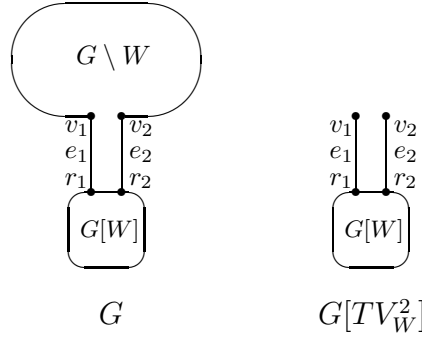

Figure 45: A 2-appearance at W in G and its total vertex/edge set.

We will now prove results, similar to Lemma 78, on the intersections of 2-appearances. Since $d_1(n) = D_2(n) \forall n$, we must have $D_2(n) \leq 5 \forall n$ and so we can, in fact, obtain a bound on the number of intersections of the total *vertex* sets:

Lemma 85 *There exists $\Lambda = \Lambda(|J|)$ such that, given any graph G with $\Delta(G) \leq 5$, the total vertex set of a 2-appearance of a graph J in G will intersect (i.e. have a vertex in common with) the total vertex set of at most Λ other 2-appearances of graphs of order $|J|$.*

Proof Suppose we have a 2-appearance of a graph of order $|J|$ at $W \subset V(G)$, and let $u \in TV_W^2$. We shall show u belongs to the total vertex set of at most $\binom{|J|+2}{|J|} \binom{5+5^2+\dots+5^{|J|+1}}{|J|+1}$ other 2-appearances of graphs of order $|J|$. Thus, since there are $|J|+2$ possibilities for u , TV_W^2 only intersects the total vertex set of at most $(|J|+2) \binom{|J|+2}{|J|} \binom{5+5^2+\dots+5^{|J|+1}}{|J|+1}$ other 2-appearances of graphs of order $|J|$.

Let us proceed with our argument by supposing that u also belongs to the total vertex set of a 2-appearance of a graph of order $|J|$ at W_2 . Since $G[TV_{W_2}^2]$ is connected, all the other $|J| + 1$ vertices in $TV_{W_2}^2$ must be at most distance $|J| + 1$ from u . But, since $\Delta(G) \leq 5$, there are at most $5 + 5^2 + \dots + 5^{|J|+1}$ vertices in $V(G)$ that are at most distance $|J| + 1$ from u . Thus, there are at most $\binom{5+5^2+\dots+5^{|J|+1}}{|J|+1}$ possibilities for $TV_{W_2}^2$. For each of these, there are then at most $\binom{|J|+2}{|J|}$ possibilities for W_2 , and hence in total there are at most $\binom{|J|+2}{|J|} \binom{5+5^2+\dots+5^{|J|+1}}{|J|+1}$ possibilities for W_2 . \square

It shall be useful for Section 16 to note that Lemma 85 immediately implies an analogous result for intersections of total edge sets:

Corollary 86 *There exists $\Lambda = \Lambda(|J|)$ such that, given any graph G with $\Delta(G) \leq 5$, the total edge set of a 2-appearance of a graph J in G will intersect (i.e. have an edge in common with) the total edge set of at most Λ other 2-appearances of graphs of order $|J|$.*

This second result actually holds even without the condition that $\Delta(G)$ is bounded, but the details are rather fiddly.

We are now finally ready to obtain our first result on 2-appearances in $\mathcal{P}_{n,D_2,5,0,D_2}$. As with Lemma 80, we follow the method of Theorem 4.1 of [16]:

Lemma 87 *Let $D_2 \geq 3$ be a fixed constant, let H be an D_2 -regular connected planar graph on $\{1, 2, \dots, h\}$ and let $f \in E(H)$ be a non cut-edge. Then $\exists \alpha > 0$ and $\exists N$ such that*

$$\mathbf{P}[P_{n,D_2,5,0,D_2} \text{ will have } \leq \alpha n \text{ 2-appearances of } H \setminus f] < e^{-\alpha n} \begin{cases} \forall n \geq N \text{ if } D_2 = 4 \\ \text{for all even } n \geq N \text{ if } D_2 \in \{3, 5\}. \end{cases}$$

Sketch of Proof In order to simplify parity matters, we shall just prove the result for $D_2 = 4$, but the $D_2 \in \{3, 5\}$ cases will follow in a completely analogous way.

We choose a specific α and suppose that the result is false for $n = k$, where k is suitably large. Using Theorem 75, it then follows that there are many graphs $G \in \mathcal{P}(k, D_2, 5, 0, D_2)$ with $\leq \alpha k$ 2-appearances of $H \setminus f$.

From each such G , we construct graphs in $\mathcal{P}((1 + \delta)k, D_2, 5, 0, D_2)$, for a fixed $\delta > 0$, by replacing some edges in G with 2-appearances of $H \setminus f$.

The fact that the original graphs had few 2-appearances of $H \setminus f$, together with Corollary 86, is then used to show that there is not much double-counting, and so we find that we have built so many graphs in $\mathcal{P}((1 + \delta)k, D_2, 5, 0, D_2)$ that we contradict Theorem 75.

Full Proof As already mentioned in the sketch proof, we shall just prove the $D_2 = 4$ case in order to avoid parity worries. The $D_2 \in \{3, 5\}$ cases will follow simply by substituting Theorem 76 for every occurrence of Theorem 75.

Let $\Lambda = \Lambda(h)$ be the constant given by Corollary 86, let $\beta = \frac{8h!(\Lambda+2)e^2(\gamma_{D_2,D_2})^h}{D_2}$ and let α be a fixed constant in $(0, \min\{\frac{D_2}{4}, \frac{1}{2h}, \frac{1}{\beta}\})$. Then we have $\alpha\beta < 1$ and so $\exists \epsilon \in (0, \frac{1}{3})$ such that $(\alpha\beta)^\alpha = 1 - 3\epsilon$.

By Theorem 75, $\exists N$ such that

$$(1-\epsilon)^n n! (\gamma_{D_2, D_2})^n \leq |\mathcal{P}(n, D_2, 5, 0, D_2)| \leq (1+\epsilon)^n n! (\gamma_{D_2, D_2})^n \quad \forall n \geq N. \quad (16)$$

Suppose (aiming for a contradiction) that there exists a $k > N$ such that $\mathbf{P}[P_{n, D_2, 5, 0, D_2}$ will have $\leq \alpha k$ 2-appearances of $H \setminus f] \geq e^{-\alpha k}$, and let \mathcal{G} denote the set of graphs in $\mathcal{P}(k, D_2, 5, 0, D_2)$ such that $G \in \mathcal{G}$ iff G has $\leq \alpha k$ 2-appearances of $H \setminus f$. Then we must have $|\mathcal{G}| \geq e^{-\alpha k} |\mathcal{P}(k, D_2, 5, 0, D_2)| \geq e^{-\alpha k} (1-\epsilon)^k k! (\gamma_{D_2, D_2})^k$.

Let $\delta = \frac{\lceil \alpha k \rceil h}{k}$. We may assume that k is sufficiently large that $\lceil \alpha k \rceil \leq 2\alpha k$.

Thus, $\delta \leq 2\alpha h < 1$. This fact will be useful later.

We shall construct graphs in $\mathcal{P}((1+\delta)k, D_2, 5, 0, D_2)$:

Choose δk special vertices (we have $\binom{(1+\delta)k}{\delta k}$ choices for these) and partition them into $\lceil \alpha k \rceil$ unordered blocks of size h (we have $\binom{\delta k}{h, \dots, h} \frac{1}{\lceil \alpha k \rceil!}$ choices for this). On each of the blocks, put a copy of $H \setminus f$ such that the increasing bijection from $\{1, 2, \dots, h\}$ to the block is an isomorphism between $H \setminus f$ and this copy. On the remaining k vertices, place an D_2 -regular planar graph G with at most αk 2-appearances of $H \setminus f$ (we have at least $|\mathcal{G}|$ choices for this).

Let r_B and s_B denote the two vertices in block B with degree $D_2 - 1$. For each of our $\lceil \alpha k \rceil$ blocks, delete a different edge $u_B v_B \in E(G)$ (we have at least $\binom{e(G)}{\lceil \alpha k \rceil} \lceil \alpha k \rceil! = \binom{k D_2 / 2}{\lceil \alpha k \rceil} \lceil \alpha k \rceil!$ choices for this), and insert edges $r_B v_B$ and $s_B u_B$ from the block to the vertices that were incident to the deleted edge (see

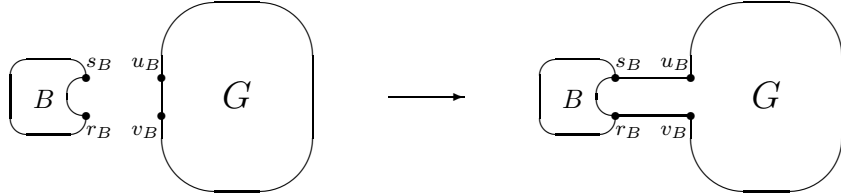

Figure 46: Creating a 2-appearance of $H \setminus f$ at B .

Figure 46). Planarity is maintained, since if H can be drawn with $f = rs$ on

the outside, then clearly $H \setminus f$ can be drawn with r and s on the outside.

Thus, for each graph G we can construct at least

$$\begin{aligned}
& \binom{(1+\delta)k}{\delta k} \binom{\delta k}{h \dots h} \frac{1}{\lceil \alpha k \rceil!} \binom{kD_2/2}{\lceil \alpha k \rceil} \lceil \alpha k \rceil! \\
= & \frac{((1+\delta)k)!}{k!} \frac{1}{(h!)^{\lceil \alpha k \rceil}} \binom{kD_2/2}{\lceil \alpha k \rceil} \\
\geq & \frac{((1+\delta)k)!}{k!} \frac{1}{(h!)^{\lceil \alpha k \rceil}} \frac{(kD_2/2 - \lceil \alpha k \rceil + 1)^{\lceil \alpha k \rceil}}{\lceil \alpha k \rceil!} \\
\geq & \frac{((1+\delta)k)!}{k!} \frac{1}{(h!)^{\lceil \alpha k \rceil}} \left(\frac{kD_2}{4}\right)^{\lceil \alpha k \rceil} \frac{1}{\lceil \alpha k \rceil!} \\
& \left(\text{since } \alpha < \frac{D_2}{4} \text{ and so } kD_2/2 - \alpha k \geq \frac{kD_2}{4} \right) \\
\geq & \frac{((1+\delta)k)!}{k!} \left(\frac{kD_2}{4h! \lceil \alpha k \rceil}\right)^{\lceil \alpha k \rceil} \\
\geq & \frac{((1+\delta)k)!}{k!} \left(\frac{D_2}{8h! \alpha}\right)^{\lceil \alpha k \rceil} \\
& \left(\text{since we may assume } k \text{ is large enough that } \lceil \alpha k \rceil \leq 2\alpha k \right)
\end{aligned}$$

different graphs in $\mathcal{P}((1+\delta)k, D_2, 5, 0, D_2)$.

Therefore, recalling that we have at least $e^{-\alpha k}(1-\epsilon)^k k! (\gamma_{D_2, D_2})^k$ choices for G , we can in total construct at least $e^{-\alpha k}(1-\epsilon)^k ((1+\delta)k)! (\gamma_{D_2, D_2})^k \left(\frac{D_2}{8h! \alpha}\right)^{\lceil \alpha k \rceil}$ (not necessarily distinct) graphs in $\mathcal{P}((1+\delta)k, D_2, 5, 0, D_2)$.

It now remains to investigate the amount of double-counting:

Given one of our constructed graphs, G' , we can re-obtain the original graph, G , by deleting the $\lceil \alpha k \rceil$ 2-appearances that were deliberately added and re-inserting the $\lceil \alpha k \rceil$ deleted edges. Notice that once we have identified the 2-appearances that were deliberately added, we will know where the deleted edges were. Hence, it only remains to examine how many possibilities there are for the $\lceil \alpha k \rceil$ 2-appearances that were deliberately added.

Suppose there is a 2-appearance of $H \setminus f$ at W in G' . Let $\{e_1, e_2\}$ denote the associated 2-edge-cut and let x and y denote the vertices in $V(G') \setminus W$ that are incident to e_1 and e_2 , respectively.

(i) If there was a 2-appearance of $H \setminus f$ at W in G , then there are at most $\lceil \alpha k \rceil$ possibilities for W , by definition of \mathcal{G} .

(ii) If the total vertex set of the 2-appearance at W intersects the total vertex set of one of our deliberately created 2-appearances, then we have at most $(\Lambda + 1)\lceil \alpha k \rceil$ possibilities for W (including the possibility that W is one of our deliberately created 2-appearances), where Λ is the constant given by Corollary 86.

(iii) Suppose (aiming for a contradiction) that neither (i) nor (ii) holds. Then there was *not* a 2-appearance of $H \setminus f$ at W in G , but the total vertex set of the 2-appearance at W in G' does not intersect the total vertex set of any of our deliberately created 2-appearances. Note that we must then have $TE_W^2 \subset E(G)$, since it follows that $TV_W^2 \subset V(G)$ and we know that we have not inserted any edges between vertices of G . Thus, if there was not a 2-appearance of $H \setminus f$ at W in G , then there must have originally been either another edge between W and $V(G) \setminus W$ other than e_1 and e_2 , or another edge between vertices in W , or an edge between x and y . Note that in any of these three cases, the deleted edge must have been incident to at least one vertex that is now in TV_W^2 . But the deleted edge must be of the form $u_B v_B$ for some block B , and both u_B and v_B belong to the total vertex set of one of our deliberately created 2-appearances. Thus, this contradicts our assumption that TV_W^2 does not intersect the total vertex set of any of our deliberately created 2-appearances.

Thus, G' must have at most $(\Lambda + 2)\lceil \alpha k \rceil$ 2-appearances of $H \setminus f$, and so we have at most $\binom{(\Lambda+2)\lceil \alpha k \rceil}{\lceil \alpha k \rceil} \leq ((\Lambda + 2)e)^{\lceil \alpha k \rceil}$ possibilities for G .

We have now shown that each graph in $\mathcal{P}((1 + \delta)k, D_2, 5, 0, D_2)$ may be constructed at most $((\Lambda + 2)e)^{\lceil \alpha k \rceil}$ times. Thus, the number of *distinct* graphs that we have constructed in $\mathcal{P}((1 + \delta)k, D_2, 5, 0, D_2)$ must be at least

$$\begin{aligned}
& e^{-\alpha k} (1-\epsilon)^k ((1+\delta)k)! (\gamma_{D_2, D_2})^k \left(\frac{D_2}{8h! \alpha (\Lambda+2)e} \right)^{\lceil \alpha k \rceil} \\
\geq & e^{-\alpha k} (1-\epsilon)^k ((1+\delta)k)! (\gamma_{D_2, D_2})^{(1+\delta)k} (\gamma_{D_2, D_2})^{-\lceil \alpha k \rceil h} \left(\frac{D_2}{8h! \alpha (\Lambda+2)e} \right)^{\lceil \alpha k \rceil}, \\
& \text{since } \delta k = \lceil \alpha k \rceil h \\
\geq & (1-\epsilon)^k ((1+\delta)k)! (\gamma_{D_2, D_2})^{(1+\delta)k} \left(\frac{8h! \alpha (\Lambda+2)e^2 (\gamma_{D_2, D_2})^h}{D_2} \right)^{-\lceil \alpha k \rceil}, \\
& \text{since } e^{-\alpha k} \geq e^{-\lceil \alpha k \rceil} \\
= & (1-\epsilon)^k ((1+\delta)k)! (\gamma_{D_2, D_2})^{(1+\delta)k} (\alpha\beta)^{-\lceil \alpha k \rceil} \\
\geq & (1-\epsilon)^k ((1+\delta)k)! (\gamma_{D_2, D_2})^{(1+\delta)k} (\alpha\beta)^{-\alpha k}, \quad \text{since } \alpha\beta < 1 \\
= & \left(\frac{1-\epsilon}{1-3\epsilon} \right)^k ((1+\delta)k)! (\gamma_{D_2, D_2})^{(1+\delta)k}, \quad \text{since } (\alpha\beta)^\alpha = 1-3\epsilon \\
\geq & \left(\frac{1-\epsilon}{1-3\epsilon} \right)^k \frac{|\mathcal{P}((1+\delta)k, D_2, 5, 0, D_2)|}{(1+\epsilon)^{(1+\delta)k}}, \quad \text{by (16)} \\
> & \left(\frac{1-\epsilon}{(1-3\epsilon)(1+\epsilon)^2} \right)^k |\mathcal{P}((1+\delta)k, D_2, 5, 0, D_2)|, \quad \text{since } \delta < 1 \text{ (page 142)} \\
> & |\mathcal{P}((1+\delta)k, D_2, 5, 0, D_2)|, \quad \text{since } (1-3\epsilon)(1+\epsilon)^2 = 1-\epsilon-5\epsilon^2-3\epsilon^3.
\end{aligned}$$

Hence, we have our desired contradiction. \square

This time, our main result is a totally *vertex*-disjoint version:

Theorem 88 *Let $D_2 \geq 3$ be a fixed constant, let H be a D_2 -regular connected planar graph on $\{1, 2, \dots, h\}$, and let $f \in E(H)$ be a non cut-edge. Then $\exists \beta$ and $\exists N$ such that*

$$\begin{aligned}
& \mathbf{P} \left[P_{n, D_2, 5, 0, D_2} \text{ will not have a set of } \geq \beta n \text{ totally} \right. \\
& \quad \left. \text{vertex-disjoint 2-appearances of } H \setminus f \right] \\
& < e^{-\beta n} \begin{cases} \forall n \geq N \text{ if } D_2 = 4 \\ \text{for all even } n \geq N \text{ if } D_2 \in \{3, 5\}. \end{cases}
\end{aligned}$$

Proof This follows from Lemmas 85 and 87, by taking $\beta = \frac{\alpha}{\Lambda+1}$. \square

16 Components

We shall now use our appearance-type results from the previous section to investigate the probability of $P_{n,d_1,5,0,D_2}$ having components isomorphic to given H . We already know from Section 13 that (assuming $D_2(n) \geq 3 \forall n$, as always) $\liminf_{n \rightarrow \infty} \mathbf{P}[P_{n,d_1,5,0,D_2} \text{ will be connected}] > 0$, so certainly we must have $\limsup_{n \rightarrow \infty} \mathbf{P}[P_{n,d_1,5,0,D_2} \text{ will have a component isomorphic to } H] < 1 \forall H$. In this section, we will now see (in Theorem 91) that for all feasible H we also have $\liminf_{n \rightarrow \infty} \mathbf{P}[P_{n,d_1,5,0,D_2} \text{ will have a component isomorphic to } H] > 0$.

As we are going to be using Theorems 83 and 88 from Section 15, we will start by dealing with the $d_1(n) < D_2(n)$ and $d_1(n) = D_2(n)$ cases separately (in Lemmas 89 and 90, respectively), but we shall then combine these results in Theorem 91.

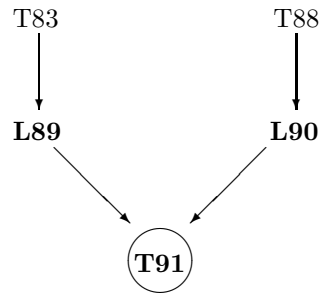

Figure 47: The structure of Section 16.

We will start with the case when $d_1(n) < D_2(n) \forall n$. We shall prove a stronger result than that advertised at the beginning of this section, as we are actually able to deal with several components at once:

Lemma 89 *Let $d_1(n)$ and $D_2(n)$ be any integer-valued functions that for all n satisfy $D_2(n) \geq 3$ and $d_1(n) < D_2(n)$, and let t be a fixed constant. Then, given any connected planar graphs H_1, H_2, \dots, H_k with $\limsup_{n \rightarrow \infty} d_1(n) \leq \delta(H_i) \leq \Delta(H_i) \leq \liminf_{n \rightarrow \infty} D_2(n) \forall i$, we have*

$$\liminf_{n \rightarrow \infty} \mathbf{P} \left[\bigcap_{i \leq k} (P_{n, d_1, 5, 0, D_2} \text{ will have } \geq t \text{ components with order-preserving isomorphisms to } H_i) \right] > 0.$$

Sketch of Proof The proof is by induction on k . To prove the $k = l + 1$ case, we first consider the set of values of n with $\delta(H_{l+1}) < D_2(n)$. Without loss of generality, $V(H_{l+1}) = \{1, 2, \dots, l + 1\}$ and $\deg_{H_{l+1}}(1) < D_2(n)$, and so we can use Theorem 83 to assume that $\widehat{f_{H_{l+1}}^{d_1}}$ is large.

We may then turn some of these appearances into components by deleting the associated cut-edges (although we must take care not to interfere with our components isomorphic to H_1, H_2, \dots, H_l , and also not to delete so many edges from the same vertex that we violate our bound on the minimum degree), and we will see that the amount of double-counting is small unless there were already lots of components with order-preserving isomorphisms to H_{l+1} originally.

We shall then use a symmetry argument to deduce that the result also holds for the set of values of n with $\delta(H_{l+1}) = D_2(n)$, by relating the probability of having a component with an order-preserving isomorphism to H_{l+1} to that of having a component with an order-preserving isomorphism to $H_{l+1} \setminus f$, where f is an arbitrary non cut-edge.

Full Proof Without loss of generality, we may assume that H_1, H_2, \dots, H_k are all distinct and that $e(H_1) \geq e(H_2) \geq \dots \geq e(H_k)$. For brevity, we will say that a component is ‘order-isomorphic’ to H_i to mean that it has an order-preserving isomorphism to H_i . As mentioned in the sketch-proof, we shall prove our result by using induction on k . Since the statement is vacuous for $k = 0$, it suffices to suppose that it holds $\forall k \leq l$ and show that it must then also hold for $k = l + 1$:

Let $\mathcal{N}^<$ denote the set of values of n for which $\delta(H_{l+1}) < D_2(n)$. We shall start by proving that there exists a constant $c_1 > 0$ such that we have $\mathbf{P}\left[\bigcap_{i \leq l+1} (P_{n,d_1,5,0,D_2} \text{ will have } \geq t \text{ components order-isomorphic to } H_i)\right] > c_1$ for all sufficiently large $n \in \mathcal{N}^<$.

Without loss of generality (by symmetry), we may assume that we have $V(H_{l+1}) = \{1, 2, \dots, |H_{l+1}|\}$ and that $\deg_{H_{l+1}}(1) = \delta(H_{l+1})$. Thus, by Theorem 83, we know $\exists \beta > 0$ and $\exists N_1$ such that $\mathbf{P}[\widehat{f_H^{d_1}}(P_{n,d_1,5,0,D_2}) \leq \beta n] < e^{-\beta n}$ for $\{n \in \mathcal{N}^< : n \geq N_1\}$.

Let $\mathcal{A}(n, d_1, D_2)$ denote the set of graphs in $\mathcal{P}(n, d_1, 5, 0, D_2)$ that contain at least t components order-isomorphic to $H_i \forall i \leq l$, and let $\mathcal{B}(n, d_1, D_2)$ denote the set of graphs in $\mathcal{A}(n, d_1, D_2)$ that also contain at least t components order-isomorphic to H_{l+1} . By our induction hypothesis, $\exists \epsilon > 0$ and $\exists N_2$ such that $|\mathcal{A}(n, d_1, D_2)| \geq \epsilon |\mathcal{P}(n, d_1, 5, 0, D_2)| \forall n \geq N_2$.

Suppose there exists a value $n \in \mathcal{N}^<$ with $n \geq \max\{N_1, N_2\}$ such that $|\mathcal{B}(n, d_1, D_2)| < \frac{\epsilon |\mathcal{P}(n, d_1, 5, 0, D_2)|}{2}$ (if not, then we are done). Let $\mathcal{G}(n, d_1, D_2)$ denote the collection of graphs in $\mathcal{A}(n, d_1, D_2) \setminus \mathcal{B}(n, d_1, D_2)$ that contain a set of at least βn totally edge-disjoint appearances of H_{l+1} such that the associated cut-edges are all between vertices of degree $> d_1(n)$. Then

$$\begin{aligned} |\mathcal{G}(n, d_1, D_2)| &\geq \epsilon |\mathcal{P}(n, d_1, D_2)| - \frac{\epsilon |\mathcal{P}(n, d_1, D_2)|}{2} - e^{-\beta n} |\mathcal{P}(n, d_1, 5, 0, D_2)| \\ &> \frac{\epsilon |\mathcal{P}(n, d_1, 5, 0, D_2)|}{4}, \text{ if we assume } n \text{ is sufficiently large.} \end{aligned}$$

Given a graph $G \in \mathcal{G}(n, d_1, D_2)$, we may construct a graph in $\mathcal{B}(n, d_1, D_2)$ as follows:

For each $i \leq l$, we choose t special components order-isomorphic to H_i . Let G' denote the rest of the graph (i.e. away from these tl special components). We know that G contains a set of $\lceil \beta n \rceil$ totally edge-disjoint appearances of H_{l+1} such that the associated cut-edges are all between vertices of degree $> d_1(n)$. At most $z := \frac{t \sum_{i \leq l} e(H_i)}{e(H_{l+1})+1}$ of these can be in our special components, so (for

sufficiently large n) G' must contain a set, S , of at least $\frac{\beta n}{2}$ totally edge-disjoint appearances of H_{l+1} such that the associated cut-edges are all between vertices of degree $> d_1(n)$.

For $v \in V(G')$, let $a(v)$ denote the number of appearances of H_{l+1} in S such that v is the unique vertex that is in the total vertex set of the appearance, but not in the appearance itself. Note that $\deg(v) > d_1(n)$ if $a(v) \geq 1$. Thus, for $a(v) \geq 1$, we have $\deg(v) - d_1(n) \geq \max\{1, a(v) - d_1(n)\} \geq \frac{a(v)}{d_1(n)+1}$. Therefore, $\min\{a(v), \deg(v) - d_1(n)\} \geq \frac{a(v)}{d_1(n)+1} \forall v$.

For each $v \in V(G')$, let us choose from S exactly $\min\{a(v), \deg(v) - d_1(n)\}$ appearances where v is the unique vertex that is in the total vertex set of the appearance, but not in the appearance itself. Let T denote the collection of all these chosen appearances. Then, by the previous paragraph, we have $|T| \geq \sum_{v \in G} \frac{a(v)}{d_1(n)+1} = \frac{|S|}{d_1(n)+1} \geq \frac{\beta n}{2(d_1(n)+1)}$.

We may then complete our construction by choosing t appearances from T (at least $\binom{\frac{\beta n}{2(d_1(n)+1)}}{t}$ choices) and simply deleting the t associated cut-edges (which are all distinct, since the appearances are totally edge-disjoint).

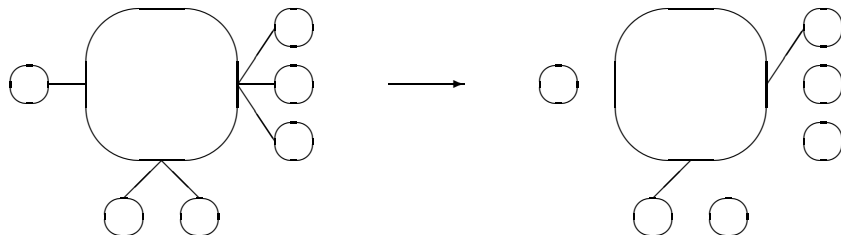

Figure 48: Using appearances to construct components isomorphic to H_{l+1} .

It remains to check that we have not violated our bound on the minimum degree:

Let W_1 and W_2 be two appearances in T and suppose there exists a vertex $u \in W_1 \cap TW_2$. Then we would have $TE_{W_1} \cap TE_{W_2} \neq \emptyset$, which would be a contradiction, since the appearances in S (and hence T) are all totally edge-

disjoint. Thus, there exists no such vertex. Therefore, the degree of a vertex v can only have decreased by at most 1 if it was in an appearance in T (since it can't have been in the total vertex set of any other appearance in T) and can only have decreased by at most $\deg(v) - d_1(n)$ if it was not in an appearance in T (since there are then at most $\deg(v) - d_1(n)$ appearances in T such that v is in the total vertex set of T). Thus, all vertices still have degree $\geq d_1(n)$, and so our graph still has minimum degree at least $d_1(n)$.

Thus, the constructed graphs are indeed in $\mathcal{B}(n, d_1, D_2)$. Therefore, we have at least $\binom{\frac{\beta n}{t}}{2(d_1(n)+1)} |\mathcal{G}(n, d_1, D_2)| \geq \binom{\frac{\beta n}{12}}{t} \frac{\epsilon |\mathcal{P}(n, d_1, 5, 0, D_2)|}{4}$ ways to construct a graph in $\mathcal{B}(n, d_1, D_2)$.

Each time we deleted an edge, we can have created at most 2 components order-isomorphic to H_{l+1} . Recall that each of our original graphs had $< t$ components order-isomorphic to H_{l+1} . Thus, each of our constructed graphs will have at most $3t$ components order-isomorphic to H_{l+1} , and so we will have at most $\binom{3t}{t}$ possibilities for which are our deliberately created components. For each of these deliberately created components, we then have at most n possibilities for which vertex in the rest of the graph was incident to the associated cut-edge. Thus, each graph will have been constructed at most $\binom{3t}{t} n^t$ times in total.

Therefore (under the assumption $|\mathcal{B}(n, d_1, D_2)| < \frac{\epsilon |\mathcal{P}(n, d_1, 5, 0, D_2)|}{2}$), we have shown $|\mathcal{B}(n, d_1, D_2)| \geq \frac{\binom{\frac{\beta n}{12}}{t} \epsilon |\mathcal{P}(n, d_1, 5, 0, D_2)|}{4 \binom{3t}{t} n^t}$. Thus, for a suitable $c_1 > 0$, we have $\mathbf{P}[\bigcap_{i \leq l+1} (P_{n, d_1, 5, 0, D_2}$ will have $\geq t$ components order-isomorphic to $H_i)] > c_1$ for all sufficiently large $n \in \mathcal{N}^<$.

Let $\mathcal{N}^=$ denote the set of values of n for which $\delta(H_{l+1}) = D_2(n)$. We shall now prove $\exists c_2 > 0$ such that, for all sufficiently large $n \in \mathcal{N}^=$, we have $\mathbf{P}[\bigcap_{i \leq l+1} (P_{n, d_1, 5, 0, D_2}$ will have $\geq t$ components order-isomorphic to $H_i)] > c_2$.

If $\mathcal{N}^= \neq \emptyset$, then we must have $\delta(H_{l+1}) \geq 3$, since $D_2(n) \geq 3$. Thus,

there exists a non cut-edge $f \in E(H_{l+1})$. Let $H'_{l+1} = H_{l+1} \setminus f$ and note that $\delta(H'_{l+1}) = D_2(n) - 1 \geq d_1(n) \forall n \in \mathcal{N}^=$. Thus, we may use Theorem 83 with H'_{l+1} and then follow the same proof as with $\mathcal{N}^<$ to find $c_2 > 0$ such that

$$\mathbf{P} \left[\bigcap_{i \leq l} (P_{n,d_1,5,0,D_2} \text{ will have } \geq t \text{ components order-isomorphic to } H_i) \right. \\ \left. \cap (P_{n,d_1,5,0,D_2} \text{ will have } \geq t \text{ components order-isomorphic to } H'_{l+1}) \right] > c_2$$

for all sufficiently large $n \in \mathcal{N}^=$.

Recall that $e(H_i) \geq e(H_2) \geq \dots \geq e(H_{l+1})$. Thus, since $e(H'_{l+1}) = e(H_{l+1}) - 1$, it must be that $H_1, H_2, \dots, H_l, H_{l+1}, H'_{l+1}$ are all *distinct* graphs. Hence, for $n \in \mathcal{N}^=$ and for any x and y , the number of graphs in $\mathcal{P}(n, d_1, 5, 0, D_2)$ that contain at least t components order-isomorphic to $H_i \forall i \leq l$, exactly x components order-isomorphic to H_{l+1} and exactly y components order-isomorphic to H'_{l+1} is clearly exactly the same as the number of graphs in $\mathcal{P}(n, d_1, 5, 0, D_2)$ that contain at least t components order-isomorphic to $H_i \forall i \leq l$, exactly y components order-isomorphic to H_{l+1} and exactly x components order-isomorphic to H'_{l+1} , since swapping the components order-isomorphic to H_{l+1} and the components order-isomorphic to H'_{l+1} gives a bijection between such graphs. Thus, for $n \in \mathcal{N}^=$, the number of graphs in $\mathcal{P}(n, d_1, 5, 0, D_2)$ that contain at least t components order-isomorphic to $H_i \forall i \leq l + 1$ must be exactly the same as the number of graphs in $\mathcal{P}(n, d_1, 5, 0, D_2)$ that contain at least t components order-isomorphic to $H_i \forall i \leq l$ and at least t components order-isomorphic to H'_{l+1} .

Therefore, to conclude, we see that for all sufficiently large $n \in \mathcal{N}^=$ we have $\mathbf{P} \left[\bigcap_{i \leq l+1} (P_{n,d_1,5,0,D_2} \text{ will have } \geq t \text{ components order-isomorphic to } H_i) \right] > c_2$, so $\mathbf{P} \left[\bigcap_{i \leq l+1} (P_{n,d_1,5,0,D_2} \text{ will have } \geq t \text{ components order-isomorphic to } H_i) \right] > \min\{c_1, c_2\}$ for *all* sufficiently large n . \square

We shall now see an analogous result for when $d_1(n) = D_2(n) \forall n$:

Lemma 90 *Let $D_2 \geq 3$ and t both be fixed. Then, given any D_2 -regular connected planar graphs H_1, H_2, \dots, H_k , there exist constants $\epsilon > 0$ and N such that*

$$\mathbf{P} \left[\bigcap_{i \leq k} (P_{n, D_2, 5, 0, D_2} \text{ will have } \geq t \text{ components} \right. \\ \left. \text{with order-preserving isomorphisms to } H_i) \right] \\ > \epsilon \begin{cases} \forall n \geq N \text{ if } D_2 = 4 \\ \text{for all even } n \geq N \text{ if } D_2 \in \{3, 5\}. \end{cases}$$

Sketch of Proof The proof is again by induction on k . To prove the $k = l + 1$ case, we use Theorem 88 to show that we may assume that there are lots of totally vertex-disjoint 2-appearances of $H_{l+1} \setminus f$, for some non cut-edge f , and then use these 2-appearances to create components isomorphic to H_{l+1} . Again, the amount of double-counting is small unless there were already lots of components isomorphic to H_{l+1} in the original graph.

Full Proof To simplify parity matters, we will just consider the $D_2 = 4$ case.

We shall prove the result by induction on k . Since the statement is vacuous for $k = 0$, it suffices to suppose that it holds $\forall k \leq l$ and show that it must then also hold for $k = l + 1$.

Without loss of generality, we may assume that $V(H_{l+1}) = \{1, 2, \dots, |H_{l+1}|\}$. Let $f \in E(H_{l+1})$ be an arbitrary non cut-edge. Then, by Theorem 88, we know that there exists $\beta > 0$ and there exists N_1 such that for all $n \geq N_1$ we have $\mathbf{P}[P_{n, D_2, 5, 0, D_2}$ does not have a set of $\geq \beta n$ totally vertex-disjoint 2-appearances of $H_{l+1} \setminus f] < e^{-\beta n}$.

Let $\mathcal{A}(n, D_2, D_2)$ denote the set of graphs in $\mathcal{P}(n, D_2, 5, 0, D_2)$ that contain at least t components with order-preserving isomorphisms to $H_i \forall i \leq l$, and let $\mathcal{B}(n, D_2, D_2)$ denote the set of graphs in $\mathcal{A}(n, D_2, D_2)$ that also contain at least t components with order-preserving isomorphisms to H_{l+1} . By our induction hypothesis, $\exists \delta > 0$ and N_2 such that $|\mathcal{A}(n, D_2, D_2)| \geq \delta |\mathcal{P}(n, D_2, 5, 0, D_2)| \forall n \geq N_2$.

Suppose $\exists n \geq \max\{N_1, N_2\}$ such that $|\mathcal{B}(n, D_2, D_2)| < \frac{\delta |\mathcal{P}(n, D_2, 5, 0, D_2)|}{2}$ (if

not, then we are done). Let $\mathcal{G}(n, D_2, D_2)$ denote the collection of graphs in $\mathcal{A}(n, D_2, D_2) \setminus \mathcal{B}(n, D_2, D_2)$ that contain a set of at least βn totally vertex-disjoint 2-appearances of $H_{l+1} \setminus f$. Then we have

$$\begin{aligned} |\mathcal{G}(n, D_2, D_2)| &\geq \delta |\mathcal{P}(n, D_2, D_2)| - \frac{\delta |\mathcal{P}(n, D_2, D_2)|}{2} - e^{-\beta n} |\mathcal{P}(n, D_2, 5, 0, D_2)| \\ &> \frac{\delta |\mathcal{P}(n, D_2, 5, 0, D_2)|}{4}, \text{ if we assume } n \text{ is sufficiently large.} \end{aligned}$$

Given a graph $G \in \mathcal{G}(n, D_2, D_2)$, we may construct a graph in $\mathcal{B}(n, D_2, D_2)$ as follows: for each $i \leq l$, we choose t special components with order-preserving isomorphisms to H_i ; from the rest of the graph (i.e. away from these tl special components), we choose t totally vertex-disjoint 2-appearances of $H_{l+1} \setminus f$ and denote these by W_1, W_2, \dots, W_t (we know that G contains a set of at least βn totally vertex-disjoint 2-appearances of H_{l+1} , and at most $z := \frac{t \sum_{i < l} |H_i|}{|H_{l+1}| + 2}$ of these can be in our special components, so the number of choices that we have for our 2-appearances is at least $\binom{\beta n - z}{t} \geq \binom{\frac{\beta n}{2}}{t}$, for all sufficiently large n); for each i we delete the 2 edges of the form $v_1 r_1$ and $v_2 r_2$ for $\{r_1, r_2\} \subset W_i$ and $\{v_1, v_2\} \subset V(G) \setminus W_i$ (these $2t$ edges are all distinct, since the chosen 2-appearances are totally vertex-disjoint); and, finally, for each i we insert the two edges $v_1 v_2$ and $e = r_1 r_2$ (note that v_1 and v_2 were not originally adjacent, by the definition of a 2-appearance, and that r_1 and r_2 were also not originally adjacent, since they must be the two vertices of degree $D_2 - 1$ in $G[W_i]$, by D_2 -regularity of G , and $G[W_i]$ is isomorphic to $H \setminus f$).

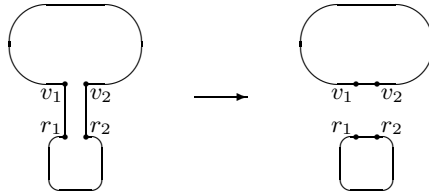

Figure 49: Using 2-appearances to construct components isomorphic to H_{l+1} .

Note that the component, C , containing r_1 and r_2 will now have an order-preserving isomorphism to H , since $C \setminus e$ has an order-preserving isomorphism to $H \setminus f$ and C and H are both D_2 -regular. Thus, our constructed graphs

will now contain at least t components with order-preserving isomorphisms to $H_i \forall i \leq l + 1$. Note also that the degrees of all the vertices will remain unchanged and that planarity is preserved. Thus, the constructed graphs are indeed in $\mathcal{P}(n, D_2, 5, 0, D_2)$. Therefore, we have at least $\binom{\frac{\beta n}{2}}{t} |\mathcal{G}(n, D_2, D_2)| \geq \binom{\frac{\beta n}{2}}{t} \frac{\delta |\mathcal{P}(n, D_2, 5, 0, D_2)|}{4}$ ways to construct a graph in $\mathcal{B}(n, D_2, D_2)$.

Each time we performed the construction of Figure 49, we can have created at most 2 components with order-preserving isomorphisms to H_{l+1} . Recall that each of our original graphs had $< t$ components with order-preserving isomorphisms to H_{l+1} . Thus, each of our constructed graphs will have at most $3t$ components with order-preserving isomorphisms to H_{l+1} , and so we will have at most $\binom{3t}{t}$ possibilities for which are our deliberately created components. We then know which edges were inserted into them and have at most $\binom{3n}{t}$, by planarity, possibilities for the edges that were inserted in the rest of the graph. We then have $t!$ ways to pair up the edges inserted in the deliberately created components with the edges inserted in the rest of the graph, and hence $2^{t!}$ possibilities for where the deleted edges were originally. Thus, each graph will have been constructed at most $\binom{3t}{t} \binom{3n}{t} 2^{t!}$ times.

Therefore (under the assumption that $|\mathcal{B}(n, D_2, D_2)| < \frac{\delta |\mathcal{P}(n, D_2, 5, 0, D_2)|}{2}$), we have shown $|\mathcal{B}(n, D_2, D_2)| \geq \frac{\binom{\frac{\beta n}{2}}{t} \delta |\mathcal{P}(n, D_2, 5, 0, D_2)|}{4 \binom{3t}{t} \binom{3n}{t} 2^{t!}} = \Theta(1) |\mathcal{P}(n, D_2, 5, 0, D_2)|$. \square

We may now combine Lemmas 89 and 90 to obtain our full result:

Theorem 91 *Let $d_1(n)$ and $D_2(n)$ be any integer-valued functions, subject to $D_2(n) \geq 3 \forall n$ and $(d_1(n), D_2(n)) \notin \{(3, 3), (5, 5)\}$ for odd n , and let t be a fixed constant. Then, given any connected planar graphs H_1, H_2, \dots, H_k with $\limsup_{n \rightarrow \infty} d_1(n) \leq \delta(H_i) \leq \Delta(H_i) \leq \liminf_{n \rightarrow \infty} D_2(n) \forall i$, we have*

$$\liminf_{n \rightarrow \infty} \mathbf{P} \left[\bigcap_{i \leq k} (P_{n, d_1, 5, 0, D_2} \text{ will have } \geq t \text{ components with order-preserving isomorphisms to } H_i) \right] > 0.$$

17 Subgraphs

We will now use the results of the previous two sections to investigate the probability of $P_{n,d_1,5,0,D_2}$ having *copies* of given (not necessarily connected) H . As always, we shall assume throughout that $D_2(n) \geq 3 \forall n$.

Clearly, for those values of n for which $D_2(n) < \Delta(H)$, we must have $\mathbf{P}[P_{n,d_1,5,0,D_2}$ will have a copy of $H] = 0$. For sufficiently large n , it turns out that the only other time when we can have this is if $d_1(n) = D_2(n) = 4$ and H happens to be a graph that can *never* be a subgraph of a 4-regular planar graph. We will note a method for determining when this is so in Theorem 95.

Apart from the above exceptions, we shall see that the matter of whether $\mathbf{P}[P_{n,d_1,5,0,D_2}$ will have a copy of $H]$ is bounded away from 0 and/or 1 actually depends only on whether H has any $D_2(n)$ -regular components. For those values of n for which this is the case, it is already clear that the probability must be bounded away from 1 (since we know from Theorem 72 that $\liminf_{n \rightarrow \infty} \mathbf{P}[P_{n,d_1,5,0,D_2}$ will be connected] > 0) and in this section (Theorem 98) we will deduce from Theorem 91 that it is also bounded away from 0. If there aren't arbitrarily large values of n for which H has $D_2(n)$ -regular components, we shall be able to use our appearance-type results of Section 15 to see (in Theorem 97) that $\mathbf{P}[P_{n,d_1,5,0,D_2}$ will have a copy of $H] \rightarrow 1$ (again, with the exception of the cases given in the previous paragraph).

We will start by proceeding towards the last result. As mentioned, the proof will use our appearance-type work, and so we shall first split into $d_1(n) < D_2(n)$ and $d_1(n) = D_2(n)$ cases (in Lemmas 92 and 96, respectively), before then combining these results in Theorem 97. We will then finish with the case when H has $D_2(n)$ -regular components, in Theorem 98.

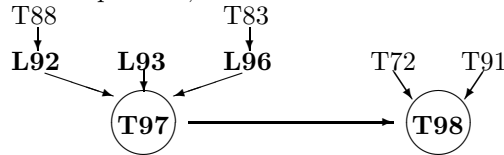

Figure 50: The structure of Section 17.

We start with the case when $d_1(n) = D_2(n) \forall n$:

Lemma 92 *Let H be a fixed planar graph with components H_1, H_2, \dots, H_k , for some k , and let $D_2 \in \{3, 4, 5\}$ be a fixed constant. Suppose no component H_i is D_2 -regular, but that for all i there exists a D_2 -regular planar graph H_i^* that contains a copy of H_i . Then $\exists \beta > 0$ and $\exists N$ such that*

$$\mathbf{P} \left[P_{n, D_2, 5, 0, D_2} \text{ will not have a set of } \beta n \text{ vertex-disjoint} \right. \\ \left. \text{induced order-preserving copies of } H \right] \\ < e^{-\beta n} \begin{cases} \forall n \geq N \text{ if } D_2 = 4 \\ \text{for all even } n \geq N \text{ if } D_2 \in \{3, 5\}. \end{cases}$$

Proof Without loss of generality, we may assume that each H_i^* is connected (because each H_i is connected). Since no H_i is D_2 -regular, it must be that each H_i^* contains an edge $f_i = u_i v_i$ such that $H_i^* \setminus f_i$ also contains a copy of H_i . Without loss of generality, we may assume that f_i is not a cut-edge in H_i^* , since we could replace f_i with a copy of the appropriate graph from Figure 51 and

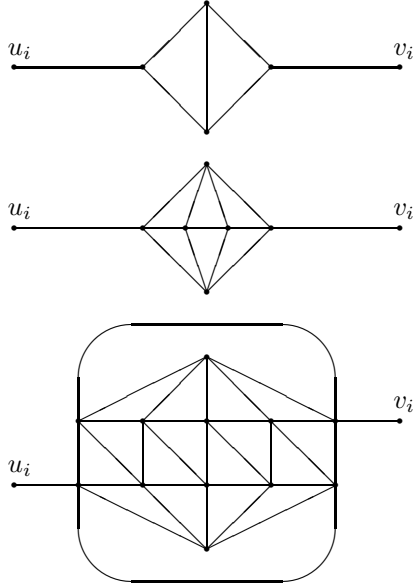

Figure 51: Replacing the edge $f_i = u_i v_i$ (cases $D_2 = 3$, $D_2 = 4$ and $D_2 = 5$).

in this way obtain a D_2 -regular planar graph containing several non cut-edges that don't interfere with our copy of H_i . Thus, we may assume that the graph formed from the $H_i^* \setminus f_i$'s by inserting the edges $u_k v_1$ and $u_i v_{i+1} \forall i \leq k-1$ will be a *connected* D_2 -regular planar graph H^* containing a copy of H .

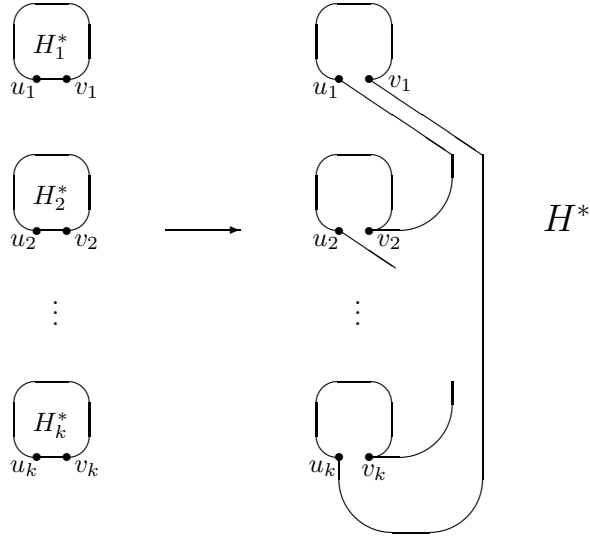

Figure 52: Constructing H^* from the H_i^* 's.

Without loss of generality, we may assume that the copy of H is order-preserving and also that it is induced (by again replacing appropriate edges with a copy of the relevant graph from Figure 51). As before, we may assume that H^* contains a non cut-edge f that doesn't interfere with this copy. The result then follows from Theorem 88. \square

Lemma 92 leaves us with the matter of discovering which graphs can't actually be contained within any D_2 -regular planar graphs. If $D_2 \in \{3, 5\}$, it turns out that there are no such graphs:

Lemma 93 Let $D_2 \in \{3, 5\}$ be a fixed constant and let H be a planar graph with $\Delta(H) \leq D_2$. Then there exists a D_2 -regular planar graph H^* that contains a copy of H .

Proof Let L_3 and L_5 denote the graphs shown in Figures 53 and 54, respectively. Then, for $D_2 \in \{3, 5\}$, L_{D_2} is a planar graph where all vertices have

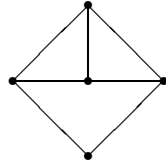

Figure 53: The graph L_3 .

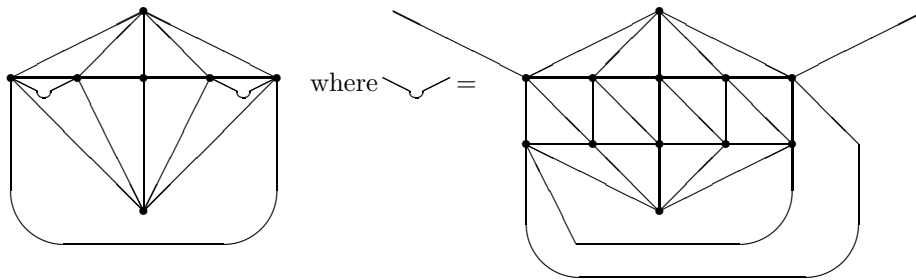

Figure 54: The graph L_5 .

degree D_2 except for exactly one vertex with degree $D_2 - 1$. Thus, H^* can be constructed by taking a copy of H and attaching $D_2 - \deg(v)$ copies of L_{D_2} to

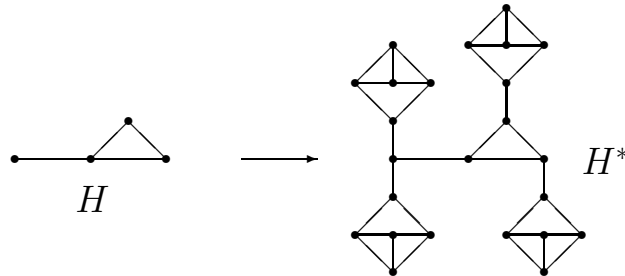

Figure 55: Constructing a 3-regular planar graph $H^* \supset H$.

each vertex $v \in V(H)$ (see Figure 55). \square

If $D_2 = 4$, the following example shows that matters are more interesting:

Example 94 *No 4-regular planar graph contains a copy of the graph K_5 minus an edge.*

Proof The graph $K_5 \setminus \{u, w\}$ is drawn with its *unique* planar embedding (see [20]) in Figure 56.

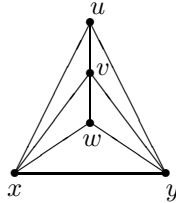

Figure 56: The unique planar embedding of $K_5 \setminus \{u, w\}$.

Consider any planar graph $G \supset K_5 \setminus \{u, w\}$ with $\Delta(G) = 4$. Since we already have $\deg_H(v) = \deg_H(x) = \deg_H(y) = 4$, any new edge with at least one endpoint inside the triangle given by xy must have both endpoints inside. Hence, the sum of degrees inside this triangle must remain odd, and so this region must still contain a vertex of odd degree. Thus, G is not 4-regular. \square

It is, in fact, possible to determine algorithmically whether or not a given graph H can't be contained within any 4-regular planar graphs, since the following result (which is part of a joint paper with Louigi Addario-Berry [1]) shows that it suffices just to check all 4-regular planar *multigraphs* with the same set of vertices as H :

Theorem 95 *Given a simple planar graph H with $\Delta(H) \leq 4$, there exists a 4-regular simple planar graph $G \supset H$ if and only if there exists a 4-regular planar multigraph $G' \supset H$ with $V(G') = V(H)$.*

Proof Suppose there exists a 4-regular simple planar graph G such that $H \subset G$ and let G' be a *minimal* 4-regular planar multigraph with $H \subset G'$, in the sense that $|V(G') \setminus V(H)|$ is as small as possible.

Suppose $|V(G') \setminus V(H)| \neq 0$ (hoping to obtain a contradiction) and let $v \in V(G') \setminus V(H)$. We shall show that we can obtain a 4-regular planar multigraph G^* such that $H \subset G^*$ and $V(G^*) = V(G') \setminus v$, thus obtaining our desired contradiction:

Case (a): If v has two loops to itself, then we may simply take G^* to be $G' \setminus v$.

Case (b): If v has exactly one loop to itself and its other two neighbours are v_1 and v_2 (where we allow the possibility that $v_1 = v_2$), then we may take G^* to be $G' \setminus v + \{(v_1, v_2)\}$.

Case (c): If v has no loops to itself, then fix a plane drawing of G' and let e_1, e_2, e_3 and e_4 be the edges incident to v in *clockwise order* in this drawing. Let v_1, v_2, v_3 and v_4 , respectively, denote the other endpoints of e_1, e_2, e_3 and e_4 (allowing the possibility that $v_i = v_j$ for some i and j). Then we may take G^* to be $G' \setminus v + \{(v_1, v_2), (v_3, v_4)\}$, since this can also be drawn in the plane.

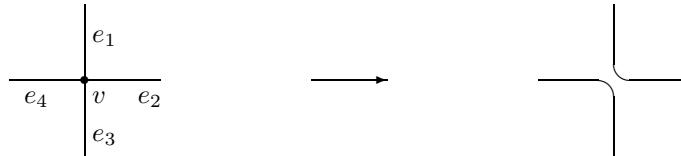

Figure 57: Constructing a smaller 4-regular planar multigraph in case (c).

For the converse direction, suppose there exists a 4-regular planar multigraph G' such that $H \subset G'$. Then simply replace every edge $e = uv$ of

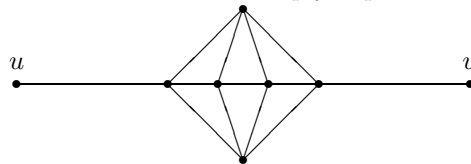

Figure 58: Constructing a 4-regular simple graph from a 4-regular multigraph.

$E(G') \setminus E(H)$ by a copy of the graph shown in Figure 58. The resulting graph G will be a 4-regular simple planar graph with $H \subset G$. \square

For those who are interested, Section 18 shall be devoted to providing a *polynomial-time* algorithm for determining whether or not a given graph H can ever be a subgraph of a 4-regular planar graph.

We shall now return to the main thrust of this section by proving an analogous result to Lemma 92 for the case when $d_1(n) < D_2(n) \forall n$. Note that we still have to specify that no component of H is $D_2(n)$ -regular, but that now the only other condition involving H is that $\Delta(H) \leq \liminf_{n \rightarrow \infty} D_2(n)$:

Lemma 96 *Let H be a planar graph with components H_1, H_2, \dots, H_k for some k . Suppose $d_1(n)$ and $D_2(n)$ are integer-valued functions that for all large n satisfy (a) $d_1(n) < \min\{6, D_2(n)\}$, and (b) $D_2(n) \geq \max\{\Delta(H), \max_i(\delta(H_i) + 1), 3\}$. Then $\exists \beta > 0$ and $\exists N$ such that*

$$\mathbf{P} \left[P_{n, d_1, 5, 0, D_2} \text{ will not have a set of } \beta n \text{ vertex-disjoint} \right. \\ \left. \text{induced order-preserving copies of } H \right] < e^{-\beta n} \quad \forall n \geq N.$$

Proof We shall show that there exists a *connected* planar graph H^* on the vertices $\{1, 2, \dots, |H^*|\}$ that (i) contains an induced order-preserving copy of H , (ii) satisfies $\limsup_{n \rightarrow \infty} d_1(n) \leq \delta(H^*) \leq \Delta(H^*) \leq \liminf_{n \rightarrow \infty} D_2(n)$, and (iii) satisfies $\deg_{H^*}(1) < \liminf_{n \rightarrow \infty} D_2(n)$. We can then use Theorem 83 on H^* .

Without loss of generality, $V(H) = \{k+1, k+2, \dots, |H|+k\}$, where $k = \kappa(H)$. Let $S = \{v_1, v_2, \dots, v_k\} \subset V(H)$ be such that we have $v_i \in V(H_i) \forall i$ and $\deg(v_i) < \liminf_{n \rightarrow \infty} D_2(n) \forall i$, and let us define H' to be the graph with $V(H') = \{1, 2, \dots, |H| + k\}$ and $E(H') = E(H) \cup \bigcup_{i \leq k} (v_i, i) \cup \bigcup_{i \leq k-1} (i, i+1)$ (see Figure 59). Then H' is a *connected* planar graph that (i) contains an induced order-preserving copy of H , (ii) satisfies $\Delta(H') \leq \liminf_{n \rightarrow \infty} D_2(n)$ (since $\deg_{H'}(v_i) = \deg_H(v_i) + 1 \leq \liminf_{n \rightarrow \infty} D_2(n) \forall i$, and all the new vertices

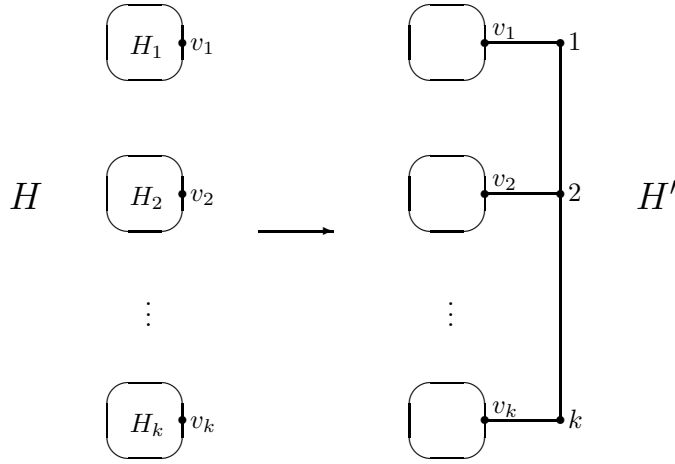

Figure 59: Constructing H' from H .

have degree at most $3 \leq \liminf_{n \rightarrow \infty} D_2(n)$, and (iii) satisfies $\deg_{H'}(1) < 3 \leq \liminf_{n \rightarrow \infty} D_2(n)$. Thus, it remains only to extend H' into a graph H^* that also satisfies $\delta(H^*) \geq \limsup_{n \rightarrow \infty} d_1(n)$.

Let L be a planar connected d -regular graph, where $d = \limsup_{n \rightarrow \infty} d_1(n)$ (it is clear from Section 14 that such a graph must exist). Then H^* can be constructed from H' simply by attaching $d - \deg(v)$ copies of L to each vertex $v \in V(H')$ with $\deg_{H'}(v) < d$ (see Figure 60). Since $d < \liminf_{n \rightarrow \infty} D_2(n)$, we

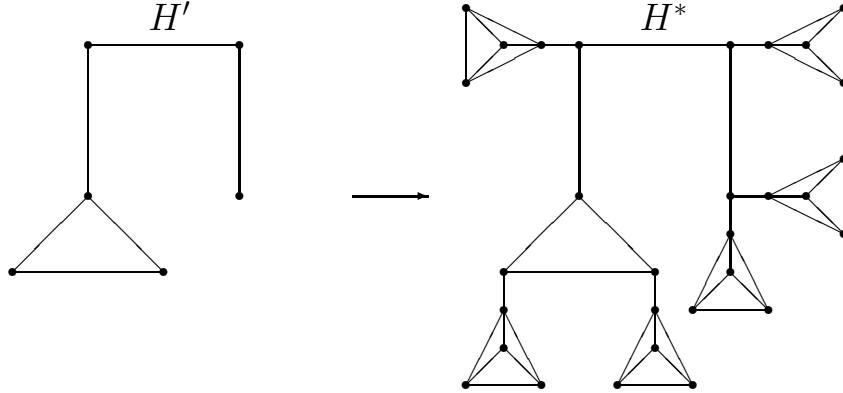

Figure 60: Constructing H^* from H' in the case $\liminf_{n \rightarrow \infty} d_1(n) = 3$.

still have $\Delta(H^*) \leq \liminf_{n \rightarrow \infty} D_2(n)$ (and $\deg_{H^*}(1) = d < \liminf_{n \rightarrow \infty} D_2(n)$). \square

We may now combine Lemmas 92, 93 and 96 to obtain our full result:

Theorem 97 *Let H be a planar graph with components H_1, \dots, H_k , for some k . Suppose $d_1(n)$ and $D_2(n)$ are integer-valued functions that for all large n satisfy (a) $d_1(n) \leq \min\{5, D_2(n)\}$, (b) $D_2(n) \geq \max\{\Delta(H), \max_i(\delta(H_i) + 1), 3\}$, (c) $(d_1(n), D_2(n)) \notin \{(3, 3), (5, 5)\}$ for odd n , and also (d) $(d_1(n), D_2(n)) \neq (4, 4)$ if H happens to be a graph that can never be contained within a 4-regular planar graph. Then $\exists \beta > 0$ and $\exists N$ such that*

$$\mathbf{P}\left[P_{n,d_1,5,0,D_2} \text{ will not have a set of } \beta n \text{ vertex-disjoint induced order-preserving copies of } H\right] < e^{-\beta n} \quad \forall n \geq N.$$

It now only remains to complete matters by dealing with the case when H does have $D_2(n)$ -regular components:

Theorem 98 *Let H be a planar graph with components H_1, H_2, \dots, H_k , for some k , and let $D_2 \geq \max\{\Delta(H), 3\}$ be a fixed constant equal to $\delta(H_i)$ for some i . Suppose $d_1(n)$ is an integer-valued function that for all large n satisfies (a) $d_1(n) \leq \min\{5, D_2\}$, (b) $(d_1(n), D_2) \notin \{(3, 3), (5, 5)\}$ for odd n , and (c) $(d_1(n), D_2) \neq (4, 4)$ if H happens to be a graph that can never be contained within a 4-regular planar graph. Then*

$$\limsup_{n \rightarrow \infty} \mathbf{P}[P_{n,d_1,5,0,D_2} \text{ will have a copy of } H] < 1,$$

but for any given constant t ,

$$\liminf_{n \rightarrow \infty} \mathbf{P}\left[P_{n,d_1,5,0,D_2} \text{ will have a set of } t \text{ vertex-disjoint induced order-preserving copies of } H\right] > 0.$$

Proof The first part follows from Theorem 72, since for $P_{n,d_1,5,0,D_2}$ to have a copy of H it would have to contain *components* isomorphic to the D_2 -regular components of H . To prove the second part, note first that it suffices (by symmetry) to ignore the order-preserving condition. Without loss of generality, we may assume that H_1, H_2, \dots, H_l are the D_2 -regular components, for some l , and that they are all distinct. By Theorem 91, we know that

$$\liminf_{n \rightarrow \infty} \mathbf{P} \left[\bigcap_{i \leq l} (P_{n,d_1,5,0,D_2} \text{ will have } \geq t \text{ components isomorphic to } H_i) \right] > 0,$$

and, by Theorem 97, we know that $\exists \beta > 0$ and $\exists N$ such that

$$\mathbf{P}[P_{n,d_1,5,0,D_2} \text{ won't have a set of } \beta n \text{ vertex-disjoint induced copies of } H'] < e^{-\beta n} \quad \forall n \geq N,$$

where H' is the graph with components $H_{l+1}, H_{l+2}, \dots, H_k$. But clearly in any graph with at least t components to $H_i \forall i \leq l$ and with a set of βn vertex-disjoint induced copies of H' , we can just fix exactly t components isomorphic to $H_i \forall i \leq l$ and then find a set of t vertex-disjoint copies of H' in the rest of the graph (assuming n is sufficiently large). Thus, the result follows. \square

18 Subgraphs of 4-Regular Graphs

(Joint work with Louigi Addario-Berry)

We have now completed our picture of P_{n,d_1,d_2,D_1,D_2} for the specific case when $(d_2(n), D_1(n)) = (5, 0) \forall n$. In Sections 19 and 20, we shall investigate what happens for general functions $d_2(n)$ and $D_1(n)$, but first we shall take a break from the main thrust of Part II to return to the question of whether or not a given graph H can ever be a subgraph of a 4-regular planar graph.

We have already seen (in Theorem 95) that we can determine this matter algorithmically. We shall now present a more efficient algorithm, which has running time $O(|H|^{2.5})$ and can be used to find an explicit 4-regular planar graph $G \supset H$ if such a graph exists (note that this improved algorithm will not be used anywhere in the rest of this thesis — we are interested in it purely for its own sake).

Recall (from Theorem 95) that a given simple planar graph H can be a subgraph of a 4-regular simple planar graph if and only if it can be a subgraph of a 4-regular planar *multigraph*. Clearly, this second interpretation is just a special case of the more general problem of determining whether or not a given planar *multigraph* H is a subgraph of some 4-regular planar multigraph. Hence, we will actually aim to produce an efficient algorithm for the latter problem.

Before we give the details of the algorithm itself, we shall first note (in Lemma 101) that our problem is straightforward for graphs with a special structure. We shall then give the algorithm itself, which will essentially consist of breaking H up into more and more highly connected pieces until we can apply Lemma 101.

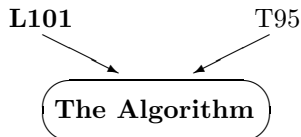

Figure 61: The structure of Section 18.

Before we look at our key lemma, we shall first pause to meet some important definitions. The first concerns the idea of ‘discrepancy functions’:

Definition 99 *Given a planar multigraph H , we say $f_H : V(H) \rightarrow \mathbf{N}$ is a **discrepancy function** on H if (a) $f_H(v) \leq 4 - \deg_H(v) \forall v \in V(H)$ (we call this **the discrepancy inequality**) and (b) $\sum_{v \in V(H)} f_H(v)$ is even (we call this **discrepancy parity**). If it is also the case that $f_H(v) + \deg_H(v)$ is even for all $v \in V(H)$, we call f_H an **even discrepancy function** on H .*

*A plane multigraph G **satisfies** (H, f_H) if $V(G) = V(H)$, $E(G) \supset E(H)$ and $\deg_G(v) = \deg_H(v) + f_H(v) \forall v$. If such a plane multigraph G exists, we say that **f_H can be satisfied on H** , or that **(H, f_H) can be satisfied**.*

Thus, using Theorem 95, it will suffice for us to determine whether or not the discrepancy function f_H defined by setting $f_H(v) = 4 - \deg_H(v) \forall v \in V(H)$ can be satisfied on H . When we break H up into pieces in our algorithm, however, we shall often find it useful to also define discrepancy functions that are not equal to $4 - \deg$.

Our second definition concerns the concept of ‘augmentations’, which will later play a critical role in our algorithm:

Definition 100 *Given a multigraph B , we define the operation of **placing a diamond** on an edge $uv \in E(B)$ to mean that we subdivide the edge with three vertices and then also add two other new vertices so that they are both adjacent to precisely these three vertices. We define the operation of **placing a vertex** on an edge $xy \in E(B)$ to mean that we subdivide the edge with a single vertex.*

*Given multigraphs B and R and a discrepancy function f_R , we say that (R, f_R) is an **augmentation** of B if R can be formed from B by placing vertices and diamonds on some of the edges of B (in such a way that there is at most one vertex or diamond on each original edge) and if $f_R = 4 - \deg_R$ for all vertices in the new diamonds and $f_R \in \{1, 2\}$ for the other new vertices.*

An example of an augmentation is given in Figure 62. When we break H up into pieces in our algorithm, the augmentation of a piece will capture the key information about how it interacted with the rest of H .

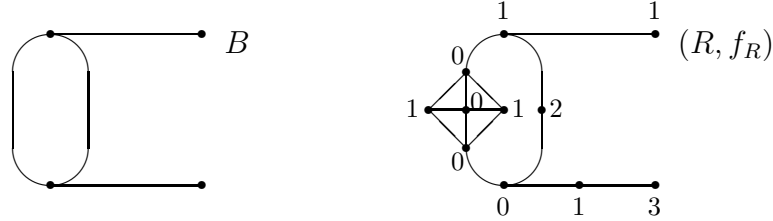

Figure 62: A planar multigraph and an augmentation of it.

We now come to our key lemma, which essentially tells us that it will suffice if we can find an algorithm to reduce our problem to trying to satisfy augmentations of 3-vertex-connected graphs.

Lemma 101 *Let B be a planar multigraph of maximum degree at most 4 that contains no 2-vertex-cuts (so $|B| \leq 3$ or B is 3-vertex-connected), and let (R, f_R) be an augmentation of B . Suppose we know which parts of R correspond to which edges of B . Then $\exists \lambda$ such that we can determine in at most $\lambda|B|^{2.5}$ operations whether or not (R, f_R) can be satisfied.*

Proof Without loss of generality, we may assume that $|B| > 3$ (since if B is bounded then there are only a finite number of possibilities for (R, f_R) , and the satisfiability of these can be determined in finite time). Thus, 3-vertex-connectivity implies that B has no loops. By a result of Whitney [20] on 3-vertex-connected simple graphs, it then follows that B has a unique planar embedding. Thus, R will also have a unique embedding, apart from possibly at places where B has multi-edges.

Note that all vertices in B must have at least 3 distinct neighbours, since B does not contain any 2-vertex-cuts. Hence (since $\deg_B(x) = \deg_R(x) \leq 4 - f_R(x) \forall x \in V(B)$), if vertices u and v have a multi-edge between them in B ,

then it must be only a double-edge and it must be that $f_R(u) = f_R(v) = 0$. We shall now use this information to find a pair $(R', f_{R'})$ such that R' has a unique planar embedding and (R, f_R) can be satisfied if and only if $(R', f_{R'})$ can be.

Let Type A, Type B, Type C and Type D denote the four possible ‘augmented versions’ of an edge, as shown in Figure 63, and recall that R will have a

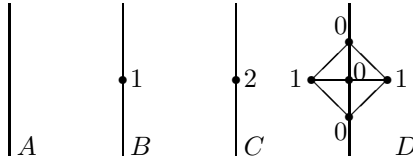

Figure 63: Augmented versions of an edge.

unique embedding apart from at any places where B has a double-edge. If there exist vertices u and v with a Type A-Type D double-edge between them, then it can be seen that it is impossible to satisfy (R, f_R) , since $f(u) = f(v) = 0$ (see Figure 64). If we have no Type A-Type D double-edges, then let R' be formed

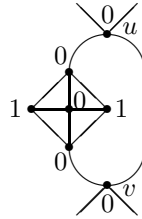

Figure 64: A Type A-Type D double edge.

from R as follows:

- (i) If the augmented versions of a double-edge are Type A and Type B, then delete the Type A part;
- (ii) If A and C, delete C;
- (iii) If B and C, delete C;
- (iv) If B and D, delete D.
- (v) If C and D, delete C.

Let $f_{R'}(v) = f_R(v) \forall v \in V(R')$.

Using the fact that the two ends of any double-edge must have $f_R = 0$, it is easy to see that (R, f_R) can be satisfied if and only if (R', f'_R) can be satisfied. It is also clear that R' will have a unique embedding. Thus, to determine whether or not (R', f'_R) can be satisfied, it suffices to see if we can satisfy (R', f'_R) in this embedding.

We shall now show that we can reduce this latter problem to finding a perfect matching in a suitably defined ‘auxiliary’ graph. We define this auxiliary graph (which will not necessarily be planar) to consist of the vertices of R' with a vertex x appearing $f_R(x)$ times and with edges between two vertices if and only if our embedding has a face containing both of them. If (R', f'_R) can be satisfied in our embedding, say by a graph M , then the edges in M that are not edges of R' form a perfect matching in the auxiliary graph. Conversely, if we can find a perfect matching, then inserting the edges of this matching into our embedding will give us a (not necessarily plane) multigraph satisfying (R', f'_R) , which can then be made into a plane multigraph satisfying (R', f'_R) simply by separating any crossing edges of our matching, as in Figure 65.

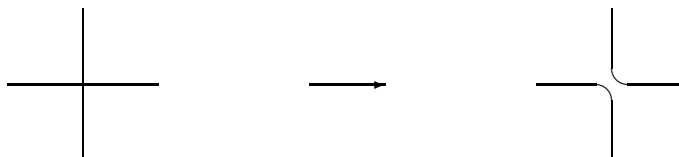

Figure 65: Separating crossing edges of our matching.

R' can be generated from R in $O(|B|^2)$ time, since there are $O(|B|^2)$ pairs of vertices in B to check for double-edges and we know which parts of R correspond to which edges of B . Note that $|R'| = O(|B|)$, so a planar embedding of R' can then be found in $O(|B|)$ time (see [3]) and we can obtain the auxiliary graph in $O(|B|^2)$ (since there are $O(|B|^2)$ possible edges). This auxiliary graph will also have $O(|B|)$ vertices, so we can then determine whether or not it has a perfect matching in $O(|B|^{2.5})$ time (see [6]). \square

Before we come to our algorithm, let us first adopt one final convenient definition:

Definition 102 *We say that a planar multigraph is **4-embeddable** if it is a subgraph of some 4-regular planar multigraph.*

Thus, the aim of this section is to produce an efficient algorithm to determine whether or not a given multigraph H is 4-embeddable.

We now present our algorithm. We shall first provide a short sketch, before then giving the details in full. Afterwards, we will investigate the running time.

Sketch of Algorithm

The algorithm shall consist of four stages, each of which will involve breaking H up into more highly connected pieces, until we can eventually apply Lemma 101 to all of these.

We will start, in Stages 1 and 2, by straightforwardly showing that H is 4-embeddable if and only if all its 2-edge-connected components are.

In Stage 3, we will then break our 2-edge-connected components into 2-vertex-connected blocks, and show that the discrepancy function $f = 4 - \text{deg}$ can be satisfied on our 2-edge-connected components if and only if certain specified discrepancy functions can be satisfied on all the 2-vertex-connected blocks.

Stage 4 is where we will use the notion of augmentations. We shall split our 2-vertex-connected blocks into 3-vertex-connected multigraphs and define augmented versions of each of these. There will be different cases depending on exactly how the 2-vertex-cuts break up the graph, and we will show that the discrepancy functions defined on our 2-vertex-connected blocks can be satisfied if and only if all these augmentations can be satisfied. This can then be determined using Lemma 101.

FULL ALGORITHM

STAGE 1

Clearly, there exists a 4-regular planar multigraph $G \supset H$ if and only if there exist 4-regular planar multigraphs $G_i \supset H_i$ for all components H_i of H (the ‘if’ direction follows by taking G to be the graph whose components are the G_i ’s and the ‘only if’ direction follows by taking $G_i = G \forall i$).

Thus, the first stage of our algorithm will be to split H into its components.

STAGE 2

Let H_1 be a component of H and suppose that H_1 has a cut-edge $e = uv$. Let H_u and H_v denote the components of $H_1 \setminus e$ containing u and v , respectively. Clearly, there exists a 4-regular planar multigraph $G_1 \supset H_1$ only if there exist 4-regular planar multigraphs $G_u \supset H_u$ and $G_v \supset H_v$ (this follows by taking $G_u = G_v = G_1$). We shall now see that the converse is also true:

Suppose there exist 4-regular planar multigraphs $G_u \supset H_u$ and $G_v \supset H_v$. Note that $\deg_{H_u}(u) = \deg_{H_1}(u) - 1 \leq 3$, since $v \notin V(H_u)$, so $\exists w \in V(G_u)$ such that $uw \in E(G_u) \setminus E(H_u)$. Similarly, $\exists x \in V(G_v)$ such that $vx \in E(G_v) \setminus E(H_v)$. Since G_u and G_v are both planar, they can be drawn with the edges uw and vx , respectively, in the outside face. Thus, the graph G_1 formed by deleting these two edges and inserting edges uv and wx will also be planar, as well as being a 4-regular multigraph containing H_1 (see Figure 66).

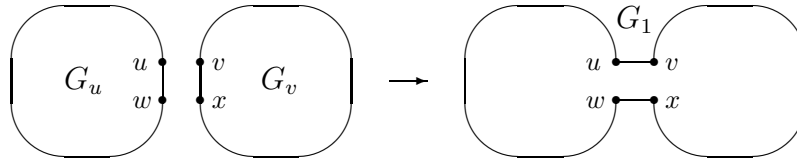

Figure 66: Constructing a 4-regular planar multigraph G_1 from 4-regular planar multigraphs G_u and G_v .

We have shown that H_1 is 4-embeddable if and only if H_u and H_v both are. Thus, by repeated use of this result, we find that H_1 is 4-embeddable if and only if all its 2-edge-connected components are (counting an isolated vertex as 2-edge-connected).

Therefore, the second stage of our algorithm will be to split the components of H into their 2-edge-connected components.

STAGE 3

Let A be one of our 2-edge-connected components. We wish to determine whether or not there exists a 4-regular planar multigraph $G_A \supset A$. By Theorem 95, it suffices to discover whether or not there exists a 4-regular planar multigraph $G' \supset A$ with $V(G') = V(A)$, i.e. to determine whether or not we can satisfy the even discrepancy function on A given by $f_A(v) = 4 - \deg_A(v) \forall v \in V(A)$.

Suppose that A has a cut-vertex v . Since A contains no cut-edges, it must be that $A \setminus v$ consists of exactly two components, A_1 and A_2 , with exactly two edges from v to each of these components. Thus, $\deg_A(v) = 4$ and $f_A(v) = 0$.

Let A_1^* denote the planar multigraph induced by $V(A_1) \cup v$ and let $f_{A_1^*}$ denote the even discrepancy function on A_1^* given by $f_{A_1^*}(x) = f_A(x) \forall x \in V(A_1^*)$ (note $f_{A_1^*}(x) + \deg_{A_1^*}(x) = 4 \forall x \neq v$ and $f_{A_1^*}(v) + \deg_{A_1^*}(v) = 2$, so $f_{A_1^*}$ is indeed an even discrepancy function). Let A_2^* and $f_{A_2^*}$ be defined similarly (see Figure 67).

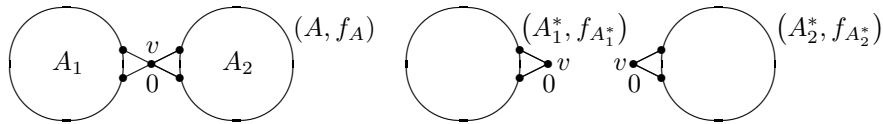

Figure 67: The planar multigraphs A , A_1^* and A_2^* .

Clearly, we can satisfy (A, f_A) if we can satisfy both $(A_1^*, f_{A_1^*})$ and $(A_2^*, f_{A_2^*})$ (since if there exist plane multigraphs G_1^* and G_2^* satisfying $(A_1^*, f_{A_1^*})$ and $(A_2^*, f_{A_2^*})$, respectively, then we may assume that v is in the outside face of both of these, and so we can then ‘glue’ these two drawings together at v to

obtain a plane multigraph that satisfies (A, f_A) . We shall now see that the converse is also true:

Suppose (A, f_A) can be satisfied, i.e. there exists a plane multigraph $G' \supset A$ with $V(G') = V(A)$ and $\deg_{G'}(x) = 4 \forall x$. Let us consider the induced plane drawing of A . Since A_2 is connected, it must lie in a single face of A_1^* . Thus, we may assume that our plane drawing of A is as shown in Figure 67, where without loss of generality we have drawn A_2 in the outside face of A_1^* . Note that the set of edges in $E(G') \setminus E(A)$ between A_1 and A_2 must all lie in a single face of our plane drawing and that there must be an even number of such edges, since f_A is an even discrepancy function and $f_A(v) = 0$. Thus, we may ‘pair up’ these edges, as in Figure 68, to obtain a plane multigraph G^* satisfying (f_A, A) that has *no* edges from A_1 to A_2 . It is then clear that $G_1^* = G^* \setminus A_2$ and $G_2^* = G^* \setminus A_1$ will satisfy $(A_1^*, f_{A_1^*})$ and $(A_2^*, f_{A_2^*})$, respectively.

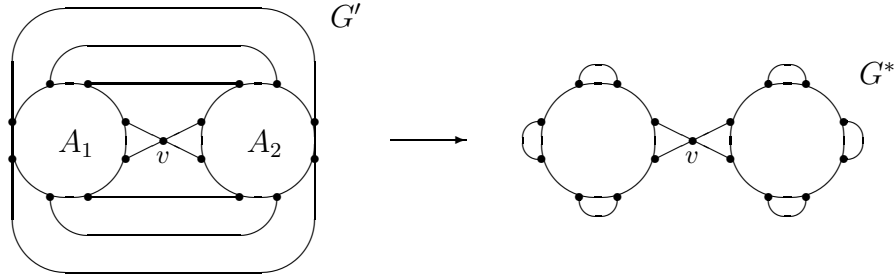

Figure 68: Constructing the graph G^* from G' .

Thus, we have shown that the even discrepancy function f_A can be satisfied on A if and only if the even discrepancy functions $f_{A_1^*}$ and $f_{A_2^*}$ can be satisfied on A_1^* and A_2^* , respectively. By repeatedly using this result, we may obtain a set of discrepancy functions defined on 2-vertex-connected planar multigraphs such that (A, f_A) can be satisfied if and only if all these can be satisfied.

Therefore, the third stage of our algorithm will be to split our 2-edge-connected components into 2-vertex-connected blocks (the decomposition is, in fact, unique), and give each the appropriate discrepancy function.

STAGE 4

Let C be one of our 2-vertex-connected blocks. We wish to determine whether or not (C, f_C) can be satisfied. Analogously to Stages 1-3, we shall split C up into pieces at 2-vertex-cuts. However, unlike with these earlier stages, this time if there exists a graph M satisfying (C, f_C) there may be several different possibilities for how the edges of M could interact with these pieces. To keep track of this, we shall define augmentations of the pieces in such a way that (C, f_C) can be satisfied if and only if these augmentations can all be satisfied.

We will proceed iteratively. At the start of each iteration, we shall have a ‘blue’ graph (which will initially be C) and an augmentation of it (initially (C, f_C)) for which we want to determine satisfiability. We will split our blue graph in two at a 2-vertex-cut by breaking off a 3-vertex-connected piece, and we shall define augmentations of these two pieces (in such a way that the augmentation of the blue graph can be satisfied if and only if the augmentations of the pieces can). Lemma 101 can then be used to determine satisfiability of the augmentation of the 3-vertex-connected piece, while the other piece and its augmentation can be used as the inputs for the next iteration. The iterative loop terminates when the blue graph is itself 3-vertex-connected.

We shall now give the full details:

Initialising

Let us define our initial ‘blue graph’, B , to be C , let us also define our initial ‘red graph’, R , to be C , and let R have discrepancy function $f_R = f_C$. Note that (R, f_R) is an augmentation of B . At the start of each iteration, we will always have a blue planar multigraph with no cut-vertex, and an augmentation of this consisting of a red graph and a discrepancy function.

The Iterative Loop

Check if B has any 2-vertex cuts. If not, then we are done, since we can simply use Lemma 101. Otherwise, let us find a minimal 2-vertex-cut $\{u, v\}$, where we use ‘minimal’ to mean that the component of smallest order in $B \setminus \{u, v\}$ is minimal over all possible 2-vertex-cuts.

We shall now proceed to define several graphs based on the pieces of $B \setminus \{u, v\}$. Let B_1 denote a component of smallest order in $B \setminus \{u, v\}$, let B_1^* denote the graph induced by $V(B_1) \cup \{u, v\}$ and let B_1^\dagger denote the graph obtained from B_1^* by deleting any edges from u to v . Let $B_2 = B \setminus B_1^*$, let $B_2^* = B \setminus B_1$ and let B_2^\dagger denote the graph obtained from B_2^* by deleting any edges from u to v . Let $R_1^*, R_2^*, R_1^\dagger$ and R_2^\dagger , respectively, denote the red versions of $B_1^*, B_2^*, B_1^\dagger$ and B_2^\dagger that follow ‘naturally’ from R , and let $R_1 = R \setminus R_2^*$ and $R_2 = R \setminus R_1^*$.

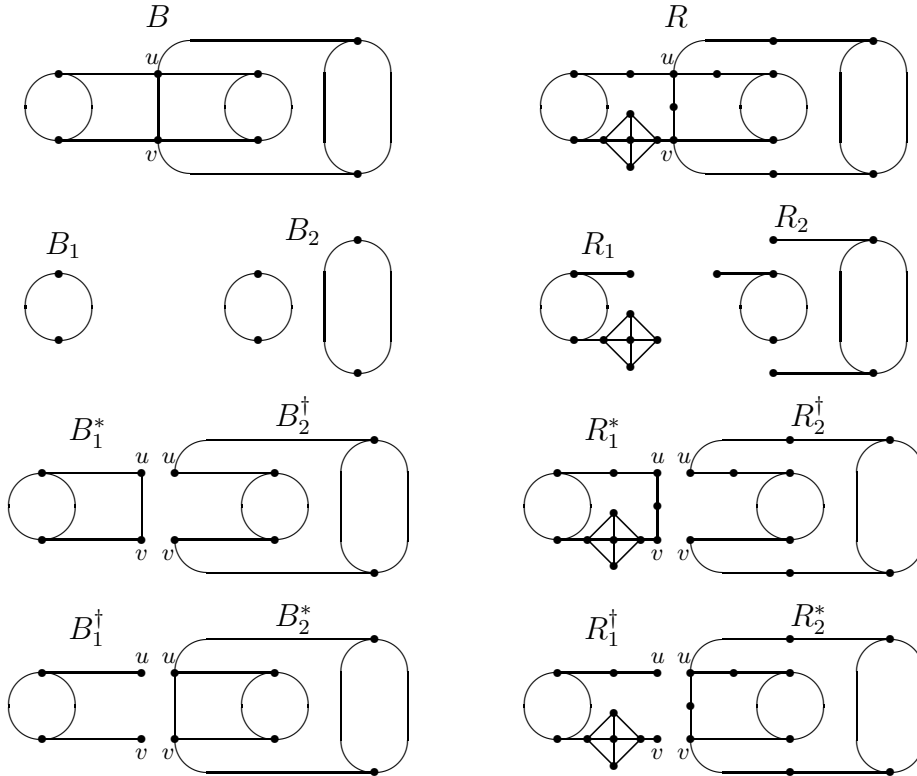

Figure 69: The planar multigraphs defined in the iterative loop of Stage 4.

Let $u1$ denote the statement

$$'f_R(u) = 0 \text{ or there is only one edge in } B \text{ from } u \text{ to } B_1'$$

(note that the latter implies $|B_1| = 1$, by minimality, but that it is not equivalent to this, as we may have multi-edges). It is important to note that the number of edges in B from u or v to B_1 is exactly the same as the number of edges in R from u or v , respectively, to R_1 (and similarly for B_2 and R_2). Thus, it would be equivalent to define $u1$ to denote ' $f_R(u) = 0$ or there is only one edge in R from u to R_1 '. Let $v1$ denote the analogous statement to $u1$ for v , and let $u2$ and $v2$ denote the analogous statements for B_2 . Let $\overline{u1}, \overline{v1}, \overline{u2}$ and $\overline{v2}$ denote the complements of $u1, v1, u2$ and $v2$.

Recall that we wish to split our graph in two at each iteration. Note that if we have $\overline{u2}$, for example, then $f_R(u) \geq 1$ and there are at least two edges in R from u to R_2 , so there may be several possibilities for where a graph satisfying (R, f_R) could have a new $u-R_2$ edge. This could complicate matters, causing an exponential blow-up in the running time, unless we choose to split the graph in such a way that only the edges from u to R_1 are important to the analysis. Thus, our choice of how best to split the graph depends on which of the statements $u1, v1, u2$ and $v2$ are true, and hence our next step is to divide our iterative loop into different cases based on this information.

Case (a): $u1 \wedge v1$

We shall now establish a couple of important facts, before then splitting into two further subcases arising from parity issues.

By definition, B_1 is connected. Thus, R_1 must also be connected, and so has to lie in a single face of R_2^* . Hence, in any planar embedding R must look as in Figure 70, where broken lines represent edges that may or may not exist and where, without loss of generality, we have drawn R_1 in the outside face of R_2^* . Therefore, if a plane multigraph M satisfies (R, f_R) then all edges in

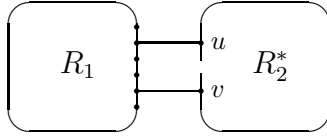

Figure 70: The planar multigraph R .

$E(M) \setminus E(R)$ between $V(R_1)$ and $V(R_2^*)$ must lie within only two faces of the induced embedding of R (since u can have more than one edge to R_1 only if $f(u) = 0$, and similarly for v).

Secondly, since f_R satisfies discrepancy parity, note that $\sum_{x \in V(R_1)} f_R(x)$ and $\sum_{x \in V(R_2^*)} f_R(x)$ must either both be odd or both be even.

Case (a)(i): $\sum_{x \in V(R_1)} f_R(x)$ and $\sum_{x \in V(R_2^*)} f_R(x)$ both odd

Let $B'_1 = B_1^\dagger + uv$ and let $B'_2 = B_2^* + uv$ (so uv will now be a multi-edge in B'_2 if $uv \in E(B)$). We shall now define an augmentation $(R'_1, f_{R'_1})$ of B'_1 and an augmentation $(R'_2, f_{R'_2})$ of B'_2 such that (R, f_R) can be satisfied if and only if $(R'_1, f_{R'_1})$ and $(R'_2, f_{R'_2})$ can both be satisfied (these new augmentations are illustrated in Figure 71).

Let R'_1 be the graph formed from R_1^\dagger by relabelling u and v as u_1 and v_1 , respectively, and introducing a new vertex w_1 with edges to both u_1 and v_1 . Similarly, let R'_2 be the graph formed from R_2^* by relabelling u and v as u_2 and v_2 , respectively, and introducing a new vertex w_2 with edges to both u_2 and v_2 . Let $f_{R'_1}$ be the discrepancy function on R'_1 defined by setting $f_{R'_1}(u_1) = f_{R'_1}(v_1) = 0$, $f_{R'_1}(w_1) = 1$, and $f_{R'_1}(x) = f_R(x) \forall x \in V(R_1)$. Let $f_{R'_2}$ be the discrepancy function on R'_2 defined by setting $f_{R'_2}(u_2) = f_R(u)$, $f_{R'_2}(v_2) = f_R(v)$, $f_{R'_2}(w_2) = 1$, and $f_{R'_2}(x) = f_R(x) \forall x \in V(R_2)$. (Note that

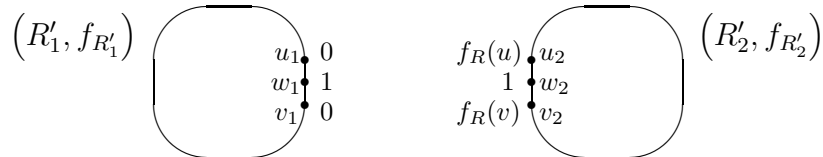

Figure 71: The planar multigraphs R'_1 and R'_2 , and their discrepancy functions.

$f_{R'_1}$ and $f_{R'_2}$ are both valid discrepancy functions, since the discrepancy inequality is clearly satisfied by both and discrepancy parity follows from the fact that $\sum_{x \in V(R'_1)} f_{R'_1}(x) = \sum_{x \in V(R_1)} f_R(x) + 1$, $\sum_{x \in V(R'_2)} f_{R'_2}(x) = \sum_{x \in V(R_2^*)} f_R(x) + 1$ and $\sum_{x \in V(R_1)} f_R(x)$ and $\sum_{x \in V(R_2^*)} f_R(x)$ are both odd).

Claim 103 (R, f_R) can be satisfied if and only if $(R'_1, f_{R'_1})$ and $(R'_2, f_{R'_2})$ can both be satisfied.

Proof Suppose first that there exists a plane multigraph M satisfying (R, f_R) . Since $\sum_{x \in V(R_1)} f_R(x)$ and $\sum_{x \in V(R_2^*)} f_R(x)$ are both odd, there must be an odd number of edges in $E(M) \setminus E(R)$ between $V(R_1)$ and $V(R_2^*)$. As already noted, these edges must all lie within two faces of the embedding of R induced from M . Thus, one of these faces must have an odd number of new edges and the other must have an even number. By pairing edges up, as in the second half of Stage 3, we can hence obtain a planar multigraph satisfying (R, f_R) that has exactly one new edge between $V(R_1)$ and $V(R_2^*)$. It is then easy to see that we can satisfy both $(R'_1, f_{R'_1})$ and $(R'_2, f_{R'_2})$.

Suppose now that $(R'_1, f_{R'_1})$ and $(R'_2, f_{R'_2})$ can both be satisfied, by plane multigraphs $M_{R'_1}$ and $M_{R'_2}$ respectively, and let the edges adjacent to w_1 in $E(M_{R'_1}) \setminus E(R'_1)$ and w_2 in $E(M_{R'_2}) \setminus E(R)$ be denoted by $e_1 = z_1 w_1$ and $e_2 = z_2 w_2$ respectively. We may assume that e_1 is in the outside face of $M_{R'_1}$. Note that the edges $u_1 w_1$ and $v_1 w_1$ must then be in the outside face of $M_{R'_1} \setminus e_1$, since these are the only edges incident to w_1 in $M_{R'_1} \setminus e_1$. Hence, by turning our drawing upside-down if necessary, we may assume that u_1, w_1 and v_1 are in clockwise order around this outer face of $M_{R'_1} \setminus e_1$, and so $M_{R'_1}$ is as shown

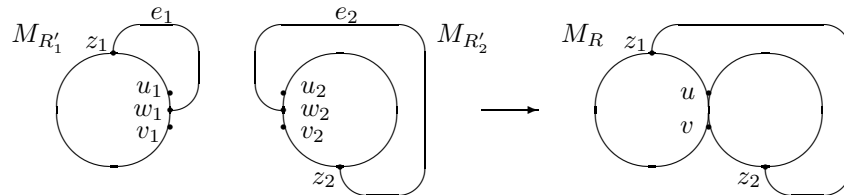

Figure 72: Constructing a planar multigraph M_R satisfying (R, f_R) .

in Figure 72 (where, without loss of generality, we have drawn e_1 so that v_1 is also in the outside face of $M_{R'_1}$). Similarly, we may assume that $M_{R'_2}$ is also as shown in Figure 72. It is then clear that we can delete w_1 and w_2 , ‘glue’ u_1 to u_2 and v_1 to v_2 (i.e. identify u_1 and u_2 and, separately, v_1 and v_2), and insert the edge $z_1 z_2$ to obtain a plane multigraph M_R that will satisfy (R, f_R) (note that it doesn’t matter whether $z_2 \in \{u_2, v_2\}$). \square

Recall that $B'_1 = B_1^\dagger + uv$ and note that B'_1 must not contain any 2-vertex-cuts, by the minimality of B_1 . Thus, by Lemma 101, in $O(|B'_1|^{2.5})$ time we can determine whether or not $(R'_1, f_{R'_1})$ can be satisfied. If it cannot, we terminate the algorithm. If it can, we return to the start of the iterative loop with B'_2 as our new blue graph, R'_2 as our new red graph and $f_{R'_2}$ as our new discrepancy function (note that, as required, B'_2 does not contain a cut-vertex since otherwise this would also be a cut-vertex in B — this property will be required for case (b)).

Case (a)(ii): $\sum_{x \in V(R_1)} f_R(x)$ and $\sum_{x \in V(R_2^*)} f_R(x)$ both even

Again, we let $B'_1 = B_1^\dagger + uv$ and $B'_2 = B_2^* + uv$. This time, we shall define augmentations $(R'_1, f_{R'_1})$ and $(R''_1, f_{R''_1})$ of B'_1 and augmentations $(R'_2, f_{R'_2})$, $(R''_2, f_{R''_2})$ and $(R'''_2, f_{R'''_2})$ of B'_2 (see Figure 73) such that (R, f_R) can be satisfied if and only if:

- (1) $(R'_1, f_{R'_1})$ and $(R'_2, f_{R'_2})$ can both be satisfied, but $(R''_1, f_{R''_1})$ can’t;
- (2) $(R''_1, f_{R''_1})$ and $(R''_2, f_{R''_2})$ can both be satisfied, but $(R'_1, f_{R'_1})$ can’t; or
- (3) $(R'_1, f_{R'_1})$, $(R''_1, f_{R''_1})$ and $(R'''_2, f_{R'''_2})$ can all be satisfied.

Let R'_1 be the graph formed from R_1^\dagger by relabelling u and v as u_1 and v_1 , respectively, and inserting an edge between u_1 and v_1 . Let $f_{R'_1}$ be the discrepancy function on R'_1 defined by setting $f_{R'_1}(u_1) = f_{R'_1}(v_1) = 0$ and $f_{R'_1}(x) = f_R(x)$ otherwise. Let R''_1 be the graph formed from R'_1 by placing a diamond on the

u_1v_1 edge, and let $f_{R'_1}$ be defined by setting $f_{R'_1}(x) = f_{R'_1}(x) \forall x \in V(R'_1)$ and $f_{R'_1}(x) = 4 - \deg_{R'_1}(x) \forall x \notin V(R'_1)$.

Let R'_2 be the graph formed from R'_2 by relabelling u and v as u_2 and v_2 , respectively, and inserting a new edge between u_1 and v_1 (so u_1v_1 will now be a multi-edge if $uv \in E(R)$). Let $f_{R'_2} = f_{R'_2}$. Let R''_2 be the graph formed from R'_2 by placing a diamond on the new u_2v_2 edge, and let $f_{R''_2}$ be defined by setting $f_{R''_2}(x) = f_{R'_2}(x) \forall x \in V(R'_2)$ and $f_{R''_2}(x) = 4 - \deg_{R''_2}(x) \forall x \notin V(R'_2)$. Let R'''_2 be the graph formed from R'_2 by instead subdividing the new u_2v_2 edge with a vertex w , and let $f_{R'''_2}$ be defined by $f_{R'''_2}(w) = 2$ and $f_{R'''_2}(x) = f'_2(x) \forall x \in V(R'_2)$.

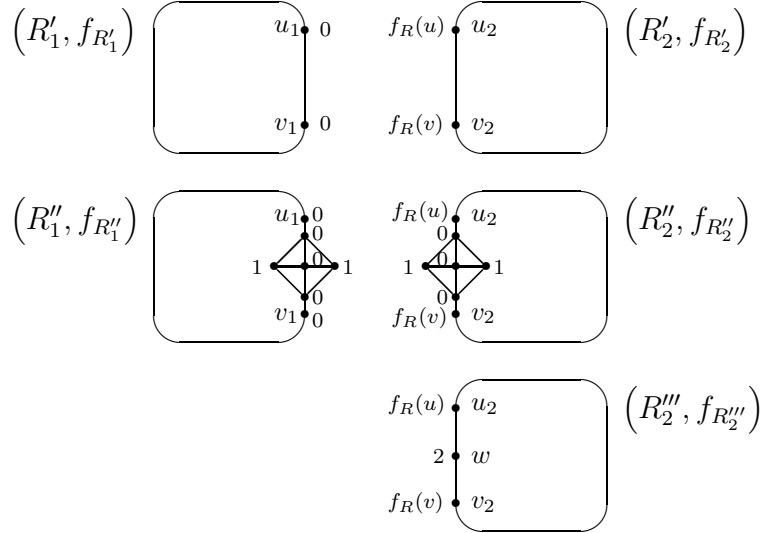

Figure 73: The planar multigraphs R'_1 , R''_1 , R'_2 , R''_2 and R'''_2 , and their discrepancy functions.

Claim 104 (R, f_R) can be satisfied if and only if one of (1),(2) or (3) holds.

Proof The ‘if’ direction follows from a similar ‘gluing’ argument to case (a)(i), since we can again assume that the appropriate parts of our graphs are drawn in the outside face, so we shall now proceed with proving the ‘only if’ direction:

Suppose that a plane multigraph M satisfies (R, f_R) . Since $\sum_{x \in V(R_1)} f_R(x)$ and $\sum_{x \in V(R_2^*)} f_R(x)$ are both even, there must be an even number of edges in $E(M) \setminus E(R)$ between $V(R_1)$ and $V(R_2^*)$. As in case (a)(i), these edges must all lie in two faces, so we must either have an even number in both of these faces or an odd number in both. By the same argument as with (a)(i), we may in fact without loss of generality assume that there are either no new edges in both faces or exactly one in both. In the former, it is clear that we can satisfy both $(R'_1, f_{R'_1})$ and $(R'_2, f_{R'_2})$, and in the latter it is clear that we can satisfy both $(R''_1, f_{R''_1})$ and $(R''_2, f_{R''_2})$. Note that we can satisfy $(R'''_2, f_{R'''_2})$ if we can satisfy $(R'_2, f_{R'_2})$ or $(R''_2, f_{R''_2})$. Thus, we can either satisfy $(R'_1, f_{R'_1}), (R'_2, f_{R'_2})$ and $(R'''_2, f_{R'''_2})$, or $(R''_1, f_{R''_1}), (R''_2, f_{R''_2})$ and $(R'''_2, f_{R'''_2})$. In the first case, either (1) or (3) must hold, and in the second case either (2) or (3) must hold. \square

We have now shown that (R, f_R) can be satisfied if and only if (1),(2) or (3) hold. As in case (a)(i), we can use Lemma 101 to determine in $O(|B_1|^{2.5})$ time whether $(R'_1, f_{R'_1})$ and $(R''_1, f_{R''_1})$ can be satisfied. If neither can be satisfied, we terminate the algorithm. If at least one can be satisfied, then we return to the start of the iterative loop with B'_2 as our new blue graph and either $(R'''_2, f_{R'''_2}), (R'_2, f_{R'_2})$ or $(R''_2, f_{R''_2})$ as our augmentation, according to whether both $(R'_1, f_{R'_1})$ and $(R''_1, f_{R''_1})$, just $(R'_1, f_{R'_1})$, or just $(R''_1, f_{R''_1})$ can be satisfied, respectively.

Case (b): $(\overline{u1} \vee \overline{v1}) \wedge u2 \wedge v2$

We shall again start with some groundwork on the structure of R , analogously to case (a), before splitting into subcases.

Since $\overline{u1} \vee \overline{v1}$ holds, we can't have $f(u) = f(v) = 0$. Thus, since $u2 \wedge v2$ also holds, it must be that either u or v has only one edge to B_2 . Hence, since B contains no cut-vertices, it must be that B_2 is connected. Therefore, R_2 must also be connected and so must lie in a single face of R_1^* . Hence, we may proceed

in a similar way to case (a), but this time we will split into subcases depending on the parity of R_1^* and R_2 , rather than R_1 and R_2^* .

Case (b)(i): $\sum_{x \in V(R_1^*)} f_R(x)$ and $\sum_{x \in V(R_2)} f_R(x)$ both odd

This time, we let $B_1' = B_1^* + uv$ (so uv will be a multi-edge in B_1' if $uv \in E(B)$) and let $B_2' = B_2^\dagger + uv$. We will define augmentations $(R_1', f_{R_1'})$ of B_1' and $(R_2', f_{R_2'})$ of B_2' (see Figure 74) such that (R, f_R) can be satisfied if and only if $(R_1', f_{R_1'})$ and $(R_2', f_{R_2'})$ can both be satisfied.

Let R_1' be the graph formed from R_1^* by relabelling u and v as u_1 and v_1 , respectively, and introducing a new vertex w_1 with edges to both u_1 and v_1 . Similarly, let R_2' be the graph formed from R_2^\dagger by relabelling u and v as u_2 and v_2 , respectively, and introducing a new vertex w_2 with edges to both u_2 and v_2 . Let $f_{R_1'}$ be the discrepancy function on R_1' defined by setting $f_{R_1'}(u_1) = f_R(u)$, $f_{R_1'}(v_1) = f_R(v)$, $f_{R_1'}(w_1) = 1$, and $f_{R_1'}(x) = f_R(x) \forall x \in V(R_1)$. Let $f_{R_2'}$ be the discrepancy function on R_2' defined by setting $f_{R_2'}(u_2) = f_{R_2'}(v_2) = 0$, $f_{R_2'}(w_2) = 1$, and $f_{R_2'}(x) = f_R(x) \forall x \in V(R_2)$.

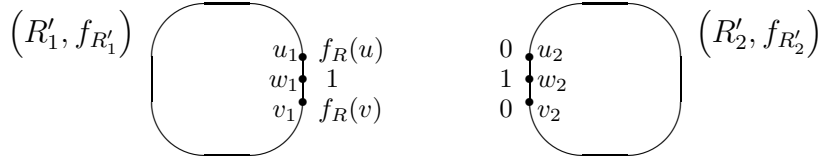

Figure 74: The planar multigraphs R_1' and R_2' , and their discrepancy functions.

The proof that (R, f_R) may be satisfied if and only if both $(R_1', f_{R_1'})$ and $(R_2', f_{R_2'})$ may be satisfied is as with case (a)(i). Again, we can determine in $O(|B_1'|^{2.5})$ time whether or not $(R_1', f_{R_1'})$ can be satisfied, and if so we return to the start of the iterative loop with B_2' as our new blue graph, R_2' as our new red graph and $f_{R_2'}$ as our new discrepancy function. Otherwise, we terminate the algorithm.

Case (b)(ii): $\sum_{x \in V(R_1^*)} f_R(x)$ and $\sum_{x \in V(R_2)} f_R(x)$ both even

Again, we let $B'_1 = B_1^* + uv$ and $B'_2 = B_2^\dagger + uv$. This time, as with case (a)(ii), we shall define augmentations $(R'_1, f_{R'_1})$ and $(R''_1, f_{R''_1})$ of B'_1 and augmentations $(R'_2, f_{R'_2})$, $(R''_2, f_{R''_2})$ and $(R'''_2, f_{R'''_2})$ of B'_2 (see Figure 75) such that (R, f_R) can be satisfied if and only if:

- (1) $(R'_1, f_{R'_1})$ and $(R'_2, f_{R'_2})$ can both be satisfied, but $(R''_1, f_{R''_1})$ can't;
- (2) $(R''_1, f_{R''_1})$ and $(R''_2, f_{R''_2})$ can both be satisfied, but $(R'_1, f_{R'_1})$ can't; or
- (3) $(R'_1, f_{R'_1})$, $(R''_1, f_{R''_1})$ and $(R'''_2, f_{R'''_2})$ can all be satisfied.

Let R'_1 be the graph formed from R_1^* by relabelling u and v as u_1 and v_1 , respectively, and inserting an edge between u_1 and v_1 (so u_1v_1 will now be a multi-edge if $uv \in E(R)$). Let $f_{R'_1}$ be defined by setting $f_{R'_1}(x) = f_R(x) \forall x \in V(R'_1)$. Let R''_1 be the graph formed from R'_1 by placing a diamond on the u_1v_1 edge, and let $f_{R''_1}$ be the function defined by setting $f_{R''_1}(x) = f_{R'_1}(x) \forall x \in V(R'_1)$ and $f_{R''_1}(x) = 4 - \deg_{R''_1}(x) \forall x \notin V(R'_1)$.

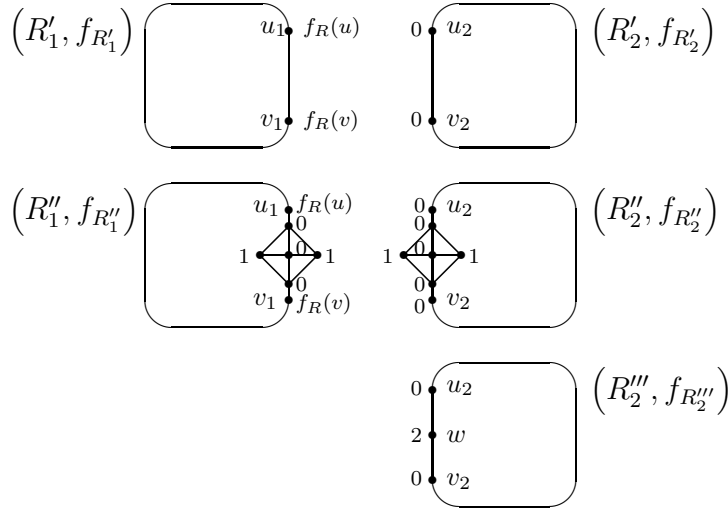

Figure 75: The planar multigraphs R'_1 , R''_1 , R'_2 , R''_2 and R'''_2 , and their discrepancy functions.

Let R'_2 be the graph formed from R_2^\dagger by relabelling u and v as u_2 and v_2 , respectively, and inserting a new edge between u_2 and v_2 . Let $f_{R'_2}$ be the discrepancy function on R'_2 defined by setting $f_{R'_2}(u_2) = f_{R'_2}(v_2) = 0$ and $f_{R'_2}(x) = f_R(x) \forall x \in V(R_2)$. Let R''_2 be the graph formed from R'_2 by placing a diamond on the new u_2v_2 edge, and let $f_{R''_2}$ be defined by setting $f_{R''_2}(x) = f_{R'_2}(x) \forall x \in V(R'_2)$ and $f_{R''_2}(x) = 4 - \deg_{R''_2}(x) \forall x \notin V(R'_2)$. Let R'''_2 be the graph formed from R'_2 by instead subdividing the new u_2v_2 edge with a vertex w , and let f'''_{R_2} be defined by $f'''_{R_2}(w) = 2$ and $f'''_{R_2}(x) = f'_{R_2}(x) \forall x \in V(R'_2)$.

The proof that (R, f_R) can be satisfied if and only if (1),(2) or (3) hold is as with case (a)(ii). Again, we can determine in $O(|B'_1|^{2.5})$ time whether or not $(R'_1, f_{R'_1})$ and $(R''_1, f_{R''_1})$ can be satisfied, and if at least one can then we return to the start of the iterative loop with B'_2 as our new blue graph and either $(R'''_2, f_{R'''_2})$, $(R'_2, f_{R'_2})$ or $(R''_2, f_{R''_2})$ as our augmentation, according to whether both $(R'_1, f_{R'_1})$ and $(R''_1, f_{R''_1})$, just $(R'_1, f_{R'_1})$, or just $(R''_1, f_{R''_1})$ can be satisfied, respectively. If neither $(R'_1, f_{R'_1})$ nor $(R''_1, f_{R''_1})$ can be satisfied, we terminate the algorithm.

Case (c): $(\overline{u1} \vee \overline{v1}) \wedge (\overline{u2} \vee \overline{v2})$

We will now deal with the remaining case, which will follow from a detailed investigation of the properties that are forced upon us if $(\overline{u1} \vee \overline{v1}) \wedge (\overline{u2} \vee \overline{v2})$ holds.

Recall that if we have $\overline{u1}$, then by definition $f_R(u) \geq 1$ and u has at least two edges to R_1 , so u must have only one edge to R_2 , and hence we have $u2$. Similarly, $\overline{v1} \Rightarrow v2, \overline{u2} \Rightarrow u1$ and $\overline{v2} \Rightarrow v1$. Thus, the only possibilities are $u1 \wedge \overline{u2} \wedge \overline{v1} \wedge v2$ and $\overline{u1} \wedge u2 \wedge v1 \wedge \overline{v2}$. By swapping u and v if necessary, we can without loss of generality assume that we have the former.

Note that the only way to obtain $u1 \wedge \overline{u2}$ is to have exactly one edge in B from u to B_1 (or, equivalently, exactly one edge in R from u to R_1), exactly two edges in B from u to B_2 , no edges in B from u to v , and $f_R(u) = 1$. Similarly, we must have exactly one edge in B from v to B_2 , exactly two edges in B from

v to B_1 , and $f_R(v) = 1$. Note also that we must have $|B_1| = 1$, since otherwise the minimality of B_1 would imply that u and v would both have to have at least two edges in B to B_1 , which would in turn imply that we would have to have $u2 \wedge v2$. Thus, B must be as shown in Figure 76.

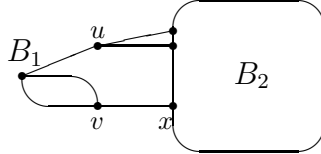

Figure 76: The structure of B in case (c).

If $|B_2| = 1$, then $|R|$ is bounded by a constant and so we can determine the satisfiability of (R, f_R) in $O(1)$ time (simply by checking all graphs with $|R|$ vertices to see if any of these do satisfy (R, f_R)).

If $|B_2| > 1$, then let x denote the neighbour of v in B_2 , let $\widehat{B}_1 = B_1 \cup v$ and let $\widehat{B}_2 = B_2 \setminus x$. Note that ux forms a 2-vertex-cut where u and x both have just one edge to \widehat{B}_1 (see Figure 77). Hence, we can copy case (a) with

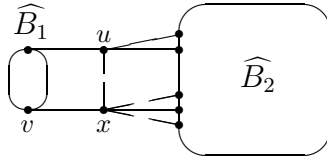

Figure 77: The 2-vertex-cut $\{u, x\}$.

B_1 and B_2 replaced by \widehat{B}_1 and \widehat{B}_2 , respectively, to again obtain graphs B'_1 and B'_2 and appropriate augmentations. It may be that the graph B'_1 will have a 2-vertex-cut, so this time we won't be able to use Lemma 101 to determine the satisfiability of augmentations of it. However, we know that we will have $|B'_1| = 4$, so the number of vertices in any augmentation of B'_1 will be bounded by a constant, and hence we will be able to determine satisfiability of these augmentations in $O(1)$ time.

Running Time

We shall now show that the algorithm takes $O(|H|^{2.5})$ time. It is fairly easy to see that the first three stages can be accomplished within this limit (in fact, they take only $O(|H|^2)$), so we will proceed straight to an examination of Stage 4.

We apply Stage 4 to each of the 2-vertex-connected blocks derived from Stage 3. It is easy to see that the total number of vertices in all these blocks is at most $2|H|$, since each vertex of H will only appear in at most two of these, so it will actually suffice just to deal with the case when H is itself a 2-vertex-connected block, i.e. when we start Stage 4 with only one 2-vertex-connected block, and it has $|H|$ vertices.

During Stage 4, we take a graph B and use it to construct graphs B'_1 and B'_2 , where $|B'_1| + |B'_2| = |B| + 2$ and $|B'_2| < |B|$, before replacing B with B'_2 and iterating. Let $B'_{1,1}, B'_{1,2}, \dots, B'_{1,l}$, for some l , denote the various graphs that take the role of B'_1 during our algorithm. Since $|B'_2| < |B|$, we can only have at most $|H|$ iterations, and so we must have $\sum_i |B'_{1,i}| \leq 3|H|$ (by telescoping, since we always have $|B'_1| + |B'_2| = |B| + 2$). We need to apply the algorithm given by Lemma 101 to at most three augmentations of each $B'_{1,i}$, so the total time taken by all such applications will be at most $3\lambda \sum_i (|B'_{1,i}|^{2.5}) \leq 3\lambda (\sum_i |B'_{1,i}|)^{2.5} = O(|H|^{2.5})$.

At the start of each iteration, we wish to determine whether B has any 2-vertex-cuts and, if so, find a minimal one. Using an algorithm from [13] for decomposing a graph into its so-called ‘triconnected components’, this takes $O(|B|) = O(|H|)$ time. It is fairly clear that all other operations involved in an iteration of Stage 4, aside from applications of Lemma 101, can also be accomplished within $O(|H|)$ time, so (since we recall that there are at most $|H|$ iterations) this all takes $O(|H|^2)$ time in total (in fact, by careful bookkeeping, this could be reduced to $O(|H|)$). Hence, it follows that the whole algorithm takes $O(|H|^{2.5})$ time.

Comments

By keeping track of all the operations, the algorithm can be used to find an explicit 4-regular planar multigraph $G \supset H$ if such a graph exists, also in $O(|H|^{2.5})$ time. If H is simple, then we can also obtain a 4-regular simple planar graph $G' \supset H$ without affecting the order of the overall running time, using the proof of Theorem 95.

19 General Bounds

In Section 17, we completed our picture of P_{n,d_1,d_2,D_1,D_2} for the specific case when $(d_2(n), D_1(n)) = (5, 0) \forall n$. In this section, we shall deduce that the same results actually also hold for general $d_2(n)$ and *bounded* $D_1(n)$, apart from for some trivial differences.

We will start by showing (in Theorem 105) that if $D_1(n) \leq K \forall n$, for some K , and $d_2(n) > 0 \forall n$, then P_{n,d_1,d_2,D_1,D_2} behaves in exactly the same way as $P_{n,d_1,5,0,D_2}$ (in terms of whether or not the probabilities of being connected or of containing given components or subgraphs are bounded away from 0 or 1). This is simply because we may use our appearance results to see that $P_{n,d_1,5,0,D_2}$ will a.a.s. satisfy these more restrictive bounds on the minimum and maximum degrees anyway.

We shall then look at what happens if $D_1(n) \leq K \forall n$ and $d_2 = 0 \forall n$. We will first show (in Theorem 108) that $P_{n,0,0,D_1,D_2}$ behaves in exactly the same way as $P_{n,0,0,0,D_2}$, and then see (in Theorems 109-112) that this latter graph actually has all the standard characteristics too, except that obviously $\mathbf{P}[P_{n,0,0,0,D_2} \text{ will be connected}] = 0$ and $\mathbf{P}[P_{n,0,0,0,D_2} \text{ will have a component isomorphic to } H] = 1$ if $|H| = 1$.

This leaves the case when $D_1(n)$ is unbounded, which we shall look at in Section 20.

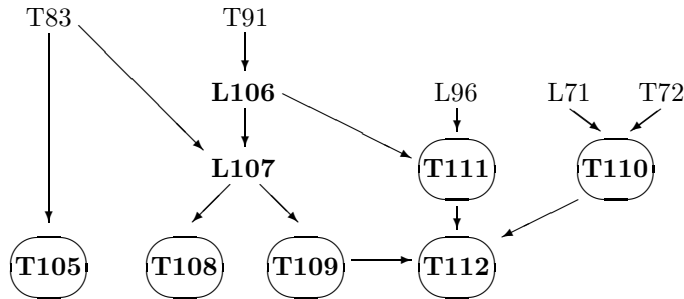

Figure 78: The structure of Section 19.

We start with our aforementioned result for when $d_2(n)$ is strictly positive and $D_1(n)$ is bounded (these form condition (d) in the statement of the theorem, while conditions (a) and (b) are just trivial necessities and (c) is our ever-present condition that $D_2(n) \geq 3$):

Theorem 105 *Let K be fixed and let $d_1(n)$, $d_2(n)$, $D_1(n)$ and $D_2(n)$ be integer-valued functions that for all large n satisfy (a) $d_1(n) \leq \min\{5, d_2(n), D_2(n)\}$ and $D_1(n) \leq D_2(n)$, (b) $(d_1(n), D_2(n)) \notin \{(3, 3), (5, 5)\}$ for odd n , (c) $D_2(n) \geq 3$, and (d) $d_2(n) > 0$ and $D_1(n) \leq K$. Then*

$$\mathbf{P}[P_{n,d_1,5,0,D_2} \in \mathcal{P}(n, d_1, d_2, D_1, D_2)] \rightarrow 1 \text{ as } n \rightarrow \infty.$$

Proof Without loss of generality, $K \geq 5$. Let us split the proof into two different cases for (i) the values of n for which $D_2(n) \geq K$ and (ii) the values of n for which $D_2(n) < K$.

For case (i), it clearly suffices to prove the result for when d_1, d_2 and D_1 are arbitrary *fixed constants* in $\{0, 1, \dots, 5\}$, $\{1, 2, \dots, 5\}$ and $\{0, 1, \dots, K\}$, respectively, satisfying $d_1 \leq d_2$ (if we choose $d_1 \in \{3, 5\}$, then we may ignore any odd values of n for which $D_2(n) = d_1$). But note that Theorem 83, on appearances, then implies $\mathbf{P}[\delta(P_{n,d_1,5,0,D_2}) \leq \max\{d_1, 1\}$ and $\Delta(P_{n,d_1,5,0,D_2}) \geq K] \rightarrow 1$ as $n \rightarrow \infty$, and so the result follows.

For case (ii), the proof is the same except that we also take D_2 to be an arbitrary fixed constant in $\{3, 4, \dots, K-1\}$ satisfying $D_2 \geq \max\{d_1, D_1\}$. This time, Theorem 83 gives $\mathbf{P}[\delta(P_{n,d_1,5,0,D_2}) \leq \max\{d_1, 1\}$ and $\Delta(P_{n,d_1,5,0,D_2}) = D_2] \rightarrow 1$ as $n \rightarrow \infty$, and again the result follows. \square

Hence, it follows that all our results for $P_{n,d_1,5,0,D_2}$ also hold for P_{n,d_1,d_2,D_1,D_2} if $d_2(n) > 0 \forall n$ and $D_1(n) \leq K \forall n$.

In the remainder of this section, we shall deal with the case $P_{n,0,0,0,D_2}$, i.e. a graph with at least one isolated vertex and with maximum degree at most $D_2(n)$. We shall see (in Theorem 108) that for all fixed $K \leq \liminf_{n \rightarrow \infty} D_2(n)$ we have $\Delta(P_{n,0,0,0,D_2}) \geq K$ a.a.s., and so results for $P_{n,0,0,D_1,D_2}$ when $D_1(n) \leq K \forall n$ will just follow automatically from results for $P_{n,0,0,0,D_2}$, which we shall then investigate in Theorems 109–112.

Analogously to Theorem 105, we shall prove Theorem 108 via a result on appearances in $P_{n,0,0,0,D_2}$. In order to obtain this appearance result, we first note the following simple lemma on $\mathbf{P}[P_{n,0,5,0,D_2} \in \mathcal{P}(n, 0, 0, 0, D_2)]$, which will also be useful later on in this section:

Lemma 106 *Let $D_2(n)$ be an integer-valued function satisfying $D_2(n) \geq 3 \forall n$. Then $\liminf_{n \rightarrow \infty} \mathbf{P}[P_{n,0,5,0,D_2} \in \mathcal{P}(n, 0, 0, 0, D_2)] > 0$.*

Proof By Theorem 91 on components, $\liminf_{n \rightarrow \infty} \mathbf{P}[\delta(P_{n,0,5,0,D_2}) = 0] > 0$. Thus, the result follows. \square

Recall from Definition 82 that $\widehat{f}_H^0(G)$ denotes the maximum size of a set of totally edge-disjoint appearances of H in G . It now follows from Lemma 106 that we have the following appearance result for $P_{n,0,0,0,D_2}$:

Lemma 107 *Let H be a fixed connected planar graph on $\{1, 2, \dots, h\}$. Then there exists $\beta(h) > 0$ such that, given any integer-valued function $D_2(n)$ satisfying $\liminf_{n \rightarrow \infty} D_2(n) \geq \max\{\Delta(H), \deg_H(1) + 1, 3\}$, we have*

$$\mathbf{P}[\widehat{f}_H^0(P_{n,0,0,0,D_2}) \leq \beta n] < e^{-\beta n} \text{ for all sufficiently large } n.$$

Proof This follows from Theorem 83 and Lemma 106. \square

As mentioned, an important consequence of this last result is that for any fixed $K \leq \liminf_{n \rightarrow \infty} D_2(n)$, we have $\mathbf{P}[\Delta(P_{n,0,0,0,D_2}) \geq K] \rightarrow 1$ as $n \rightarrow \infty$, so

Theorem 108 *Let K be a fixed constant and let $D_1(n)$ and $D_2(n)$ be integer-valued functions satisfying $D_1(n) \leq K \forall n$ and $D_2(n) \geq 3 \forall n$. Then*

$$\mathbf{P}[P_{n,0,0,0,D_2} \in \mathcal{P}(n, 0, 0, D_1, D_2)] \rightarrow 1 \text{ as } n \rightarrow \infty.$$

Thus, results for $P_{n,0,0,D_1,D_2}$ when $D_1(n) \leq K$ will actually just be the same as for $P_{n,0,0,0,D_2}$. Therefore, to complete our picture of P_{n,d_1,d_2,D_1,D_2} for the case when $D_1(n) \leq K \forall n$, it will suffice just to deal with the case $d_1(n) = d_2(n) = D_1(n) = 0 \forall n$. Clearly, $\mathbf{P}[P_{n,0,0,0,D_2} \text{ will be connected}] = 0$, and so we are only left with looking at the limiting probabilities for $P_{n,0,0,0,D_2}$ having a component isomorphic to H and for $P_{n,0,0,0,D_2}$ having a copy of H , for given H .

A lower bound for $\mathbf{P}[P_{n,0,0,0,D_2} \text{ will have a component isomorphic to } H]$ may in fact be obtained exactly as in Section 16:

Theorem 109 *Let $D_2(n)$ be an integer-valued function satisfying $D_2(n) \geq 3 \forall n$, and let t be a constant. Then, given any connected planar graphs H_1, H_2, \dots, H_k with $\Delta(H_i) \leq \liminf_{n \rightarrow \infty} D_2(n) \forall i$, we have*

$$\liminf_{n \rightarrow \infty} \mathbf{P} \left[\bigcap_{i \leq k} (P_{n,0,0,0,D_2} \text{ will have } \geq t \text{ components with order-preserving isomorphisms to } H_i) \right] > 0.$$

Proof We may use the same proof as for Lemma 89 (by deleting the associated cut-edges of some appearances), with Theorem 83 replaced by Lemma 107. \square

Clearly, $\mathbf{P}[P_{n,0,0,0,D_2}$ will have a component isomorphic to $H] = 1$ if H is an isolated vertex, by definition. However, if H is not an isolated vertex then we are able to bound the probability away from 1 by the following result:

Theorem 110 *There exists a constant $\epsilon > 0$ such that, given any integer-valued function $D_2(n)$ with $D_2(n) \geq 3 \forall n$, we have*

$$\mathbf{P}[P_{n,0,0,0,D_2} \text{ will consist of exactly one isolated vertex plus a connected graph}] > \epsilon \forall n.$$

Proof Clearly, the result holds for $n \leq 2$. Now let us choose any $n \geq 3$ and any $D_2(n)$. We shall find a constant ϵ , independent of these choices of n and $D_2(n)$, satisfying the conditions of the theorem.

Let $\mathcal{I}(n, D_2, k)$ denote the set of all graphs in $\mathcal{P}(n, 0, 0, 0, D_2)$ with exactly k isolated vertices. Note that $|\mathcal{I}(n, D_2, 1)| = n|\mathcal{P}(n-1, 1, 5, 0, D_2)|$ and that $|\mathcal{I}_c(n, D_2, 1)| = n|\mathcal{P}_c(n-1, 1, 5, 0, D_2)|$, where $\mathcal{P}_c(n-1, 1, 5, 0, D_2)$ denotes the set of connected graphs in $\mathcal{P}(n-1, 1, 5, 0, D_2)$ and $\mathcal{I}_c(n, D_2, 1)$ denotes the set of graphs in $\mathcal{I}(n, D_2, 1)$ that are connected apart from the isolated vertex. By Theorem 72, there exists a strictly positive constant c (independent of n and $D_2(n)$) such that $\frac{|\mathcal{P}_c(n-1, 1, 5, 0, D_2)|}{|\mathcal{P}(n-1, 1, 5, 0, D_2)|} > c$. Thus, $|\mathcal{I}_c(n, D_2, 1)| > c|\mathcal{I}(n, D_2, 1)|$, and so it suffices to find a strictly positive constant ϵ' , independent of n and $D_2(n)$, such that $\frac{|\mathcal{I}(n, D_2, 1)|}{|\mathcal{P}(n, 0, 0, 0, D_2)|} > \epsilon'$, i.e. $\mathbf{P}[P_{n,0,0,0,D_2}$ will have exactly one isolated vertex] $> \epsilon'$.

The remainder of the proof will now be a ‘downwards cascade’ argument similar to that of Theorem 72.

Let $k \in \{2, 3, \dots, n-2\}$, let $G \in \mathcal{I}(n, D_2, k)$, and let G^* denote the graph of order $n-k$ obtained by deleting all k isolated vertices from G . Starting from G , we shall create a new graph $G' \in \mathcal{I}(n, D_2, k-1)$ by considering different cases depending on G^* :

Case (a) If G^* has $> \frac{n-k}{43}$ vertices of degree $< D_2(n)$

Starting with G , simply insert an edge between an isolated vertex (we have k choices) and a non-isolated vertex of degree $< D_2(n)$ (we have $> \frac{n-k}{43}$ choices).

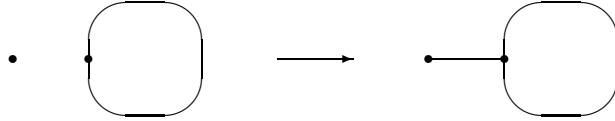

Figure 79: Reducing the number of isolated vertices in case (a).

Case (b) If G^* has $\leq \frac{n-k}{43}$ vertices of degree $< D_2(n)$ (in which case $D_2(n) \leq 6$, since $e(G^*) < 3(n-k)$ and so we can only have at most $\frac{6(n-k)}{7}$ vertices of degree ≥ 7)

By Lemma 71, G must contain at least $\frac{n-k}{43}$ cycles of size ≤ 6 . Delete an edge uv in one of these cycles (we have at least $\frac{3}{D_2(n)+D_2(n)^2+D_2(n)^3+D_2(n)^4} \frac{n-k}{43} \geq \frac{3}{6+6^2+6^3+6^4} \frac{n-k}{43}$ choices for this edge, since each cycle must contain at least 3 edges and each edge is in at most $(D_2(n)-1)^{m-2} < D_2(n)^{m-2}$ cycles of size m), and insert an edge between u and an isolated vertex (we have at least k choices for this).

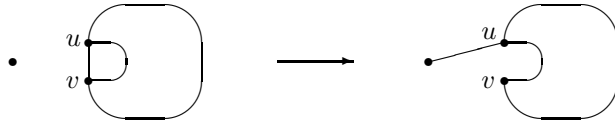

Figure 80: Reducing the number of isolated vertices in case (b).

In both cases, we have at least $\frac{3}{6+6^2+6^3+6^4} \frac{k(n-k)}{43}$ choices when constructing G' from G . Thus, we have at least $\frac{3}{6+6^2+6^3+6^4} \frac{k(n-k)}{43} |\mathcal{I}(n, D_2(n), k)|$ ways to construct a graph in $\mathcal{I}(n, D_2(n), k-1)$.

Given one of our constructed graphs, there are at most 2 possibilities for how the graph was obtained (case (a) or (b)).

If case (a) was used, then we can re-obtain the original graph simply by deleting the inserted edge, for which there are at most $3(n-(k-1))-3 = 3(n-k)$ possibilities (including the case when $n-(k-1) < 3$).

If case (b) was used, then we can re-obtain the original graph by deleting the inserted edge ($\leq 3(n-k)$ possibilities) and re-inserting the deleted edge (at most $D_2(n)^2 + D_2(n)^3 + D_2(n)^4 + D_2(n)^5$ possibilities, once the inserted edge is located, since the deleted edge uv was originally part of a cycle of size ≤ 6 , and so v is still at distance at most 5 from u).

Thus, recalling that $D_2 \leq 6$ if case (b) was used, we find that there are at most $3(n-k) + 3(n-k)(6^2 + 6^3 + 6^4 + 6^5) = 3(1 + 6^2 + 6^3 + 6^4 + 6^5)(n-k)$ possibilities for the original graph in total.

Let $\alpha = \frac{1}{43(6+6^2+6^3+6^4)(1+6^2+6^3+6^4+6^5)}$. Then, for all $k \in \{2, 3, \dots, n-2\}$, we have $|\mathcal{I}(n, D_2, k-1)| \geq \alpha k |\mathcal{I}(n, D_2, k)| \geq \alpha(k-1) |\mathcal{I}(n, D_2, k)|$.

Let $p_k = \frac{|\mathcal{I}(n, D_2, k+1)|}{|\mathcal{P}(n, 0, 0, 0, D_2)|}$ and note that p_0 is the probability that $P_{n, 0, 0, 0, D_2}$ will have exactly one isolated vertex. Since $|\mathcal{I}(n, D_2, k+1)| \leq \frac{|\mathcal{I}(n, D_2, k)|}{\alpha k}$ for all $k \in \{1, 2, \dots, n-3\}$, we have $p_k \leq \frac{p_0}{\alpha^k k!}$ for all $k \in \{0, 1, \dots, n-3\}$. Note that we also have $\sum_{k \geq 0}^{n-3} p_k = 1 - \frac{1}{|\mathcal{P}(n, 0, 0, 0, D_2)|} \geq \frac{7}{8}$ for $n \geq 3$ (since every graph in $\mathcal{P}(n, 0, 0, 0, D_2)$ has at least one isolated vertex and can only have more than $n-2$ if it is the empty graph E_n), so $\sum_{k \geq 0} \frac{p_0}{\alpha^k k!} \geq \frac{7}{8}$ and hence $p_0 \geq \frac{7}{8} \left(\sum_{k \geq 0} \frac{(\frac{1}{\alpha})^k}{k!} \right)^{-1} = \frac{7e^{-\frac{1}{\alpha}}}{8}$. \square

It now only remains to look at $\mathbf{P}[P_{n, 0, 0, 0, D_2}$ will have a copy of $H]$. As in Section 17, the following two results show that the behaviour of this probability (in terms of whether or not it is bounded away from 1) depends only on whether there are arbitrarily many n for which H has a $D_2(n)$ -regular component:

Theorem 111 *Let $D_2(n)$ be an integer-valued function satisfying $D_2(n) \geq 3 \forall n$, and let H be a planar graph with components H_1, H_2, \dots, H_k , for some k . Suppose for all i we have $\Delta(H_i) \leq \liminf_{n \rightarrow \infty} D_2(n)$ and $\delta(H_i) < \liminf_{n \rightarrow \infty} D_2(n)$. Then $\exists \beta > 0$ and $\exists N$ such that*

$$\mathbf{P} \left[P_{n,0,0,0,D_2} \text{ will not have a set of } \beta n \text{ vertex-disjoint} \right. \\ \left. \text{induced order-preserving copies of } H \right] < e^{-\beta n} \forall n \geq N.$$

Proof This follows immediately when Lemma 96 (the analogous result for $P_{n,0,5,0,D_2}$) is combined with Lemma 106. \square

Theorem 112 *Let $D_2 \geq 3$ be a fixed integer, and let H be a planar graph with components H_1, H_2, \dots, H_k , for some k . Suppose for all i we have $\Delta(H_i) \leq D_2$ and that for some i H_i is D_2 -regular. Then*

$$\limsup_{n \rightarrow \infty} \mathbf{P}[P_{n,0,0,0,D_2} \text{ will have a copy of } H] < 1,$$

but for any given constant t ,

$$\liminf_{n \rightarrow \infty} \mathbf{P} \left[P_{n,0,0,0,D_2} \text{ will have a set of } t \text{ vertex-disjoint} \right. \\ \left. \text{induced order-preserving copies of } H \right] > 0.$$

Proof The upper bound follows from Theorem 110 and the lower bound from Theorems 109 and 111, exactly as in Theorem 98. \square

20 $D_1(n) \rightarrow \infty$

We now have a complete picture of P_{n,d_1,d_2,D_1,D_2} for the case when $D_1(n)$ is bounded above by an arbitrary constant (see page 112), i.e. if we are given any functions at all for $d_1(n)$, $d_2(n)$ and $D_2(n)$ and we are given a function $D_1(n)$ with $\limsup_{n \rightarrow \infty} D_1(n) < \infty$, then we can tell how likely it is (in terms of whether the probabilities are bounded away from 0 and/or 1) that P_{n,d_1,d_2,D_1,D_2} will be connected or contain any particular component/subgraph. This leaves the matter of what happens when $\limsup_{n \rightarrow \infty} D_1(n) = \infty$, which we shall now discuss very briefly in this section.

Recall that our picture of P_{n,d_1,d_2,D_1,D_2} for the case when $D_1(n)$ is bounded followed immediately from our results for $P_{n,d_1,d_2,0,D_2}$, since we were able to show that the maximum degree in this latter graph will a.a.s. be larger than any given constant. Hence, if we could obtain a higher bound for $\Delta(P_{n,d_1,d_2,0,D_2})$, then this would automatically enable us to extend our current results. In fact, it has very recently been shown in [17] that (a.a.s.) the standard random planar graph $P_{n,0,5,0,n-1}$ has maximum degree of the order of $\log n$, and it seems likely that such a result should also hold for $P_{n,d_1,d_2,0,D_2}$ in general. Hence, it is probable that the description of P_{n,d_1,d_2,D_1,D_2} given on page 112 will still hold even if $D_1(n)$ is allowed to grow slowly with n .

If we allow $D_1(n)$ to become very large, then of course eventually our picture of P_{n,d_1,d_2,D_1,D_2} will have to change, since (for example) $P_{n,d_1,d_2,n-1,n-1}$ will clearly be connected! We now conclude this thesis with one final nice result to show that this change will a.a.s. have happened by the time $D_1(n) = n - o(n)$:

Theorem 113 *Let $d_1(n)$, $d_2(n)$, $D_1(n)$ and $D_2(n)$ be integer-valued functions that for all large n satisfy (a) $d_1(n) \leq \min\{5, d_2(n), D_2(n)\}$ and $D_1(n) \leq D_2(n)$, and (b) $d_2(n) > 0$ and $D_1(n) = n - o(n)$. Then*

$$\mathbf{P}[P_{n,d_1,d_2,D_1,D_2} \text{ will be connected}] \rightarrow 1 \text{ as } n \rightarrow \infty.$$

Proof Let $d_1(n)$, $d_2(n)$, $D_1(n)$ and $D_2(n)$ be as in the statement of the theorem, and let \mathcal{G}_n denote the set of graphs in $\mathcal{P}(n, d_1, d_2, D_1, D_2)$ that are *not* connected. We shall use \mathcal{G}_n to construct so many graphs in $\mathcal{P}(n, d_1, d_2, D_1, D_2)$ that we must have $\frac{|\mathcal{G}_n|}{|\mathcal{P}(n, d_1, d_2, D_1, D_2)|} \rightarrow 0$ as $n \rightarrow \infty$.

Let G be an arbitrary graph in \mathcal{G}_n , for some n . Since $D_1(n) = n - o(n)$, we may assume that n is large enough that only one component of G contains a vertex with degree $\Delta(G)$. Let us call this component C . Let x be a vertex with $\deg(x) = \delta(C)$, and let us choose a vertex $u \in V(C) \setminus x$ with degree at most $\Delta(G) - 2$. Note that $e(G) \leq 3n - 6$ implies $\sum_{v \in V(G)} \deg(v) \leq 6n - 12$, so we can assume that n is large enough that there only exist at most 6 vertices with degree greater than $\Delta(G) - 2$. Thus, we have at least $|C \setminus x| - 6 = |C| - 1 - 6 \geq D_1(n) - 6$ ways to choose a vertex u .

Before we continue with our argument, let us choose a vertex $w \in G \setminus C$ in one of two ways, depending on whether $|G \setminus C| = 1$ or $|G \setminus C| \geq 2$. If $|G \setminus C| = 1$, then we let w be the unique vertex in $G \setminus C$. If $|G \setminus C| \geq 2$, then let y be a vertex in $G \setminus C$ with $\deg(y) = \delta(G \setminus C)$ and let w be any vertex in $(G \setminus C) \setminus y$.

Let G^* denote the graph formed from G by inserting the edge uw . Note

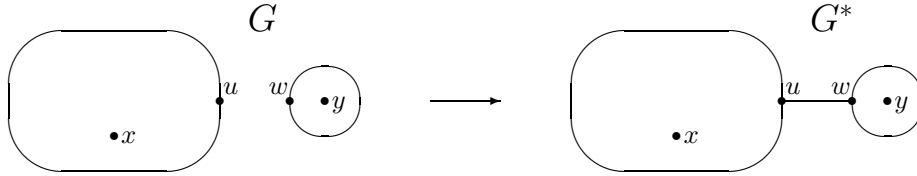

Figure 81: Forming the graph G^* .

that G^* is still planar, since u and w were in separate components, and that we still have $\delta(G^*) \geq d_1(n)$ and $\Delta(G^*) \geq D_1(n)$, since we have not deleted any edges. Note also that we still have $\Delta(G^*) \leq D_2(n)$, since $\deg_{G^*}(w) = o(n)$ and $\deg_{G^*}(u) = \deg_G(u) + 1 \leq \Delta(G) - 1$, and that we still have $\delta(G^*) \leq d_2(n)$, since if $|G \setminus C|$ was 1 then $\deg_{G^*}(w) = 1 \leq d_2(n)$ and if $|G \setminus C|$ was at least 2

then $\deg_{G^*}(y) = \deg_G(y) = \delta_G(G \setminus C)$ and $\deg_{G^*}(x) = \deg_G(x) = \delta_G(C)$ and so $\delta(G^*) = \delta(G) \leq d_2(n)$.

Hence, since we had $|\mathcal{G}_n|$ choices for G and at least $D_1(n) - 6$ choices for u , we have at least $(D_1(n) - 6)|\mathcal{G}_n|$ ways to construct a graph in $\mathcal{P}(n, d_1, d_2, D_1, D_2)$.

Let us now consider how many times a graph $G^* \in \mathcal{P}(n, d_1, d_2, D_1, D_2)$ will be constructed. Clearly, we can re-obtain the original graph G by deleting the edge uw . Since $\deg_{G^*}(u) = \deg_G(u) + 1 \leq \Delta(G) - 1$, w is one of at most $n - D_1(n)$ vertices that is not adjacent to a vertex of degree $\Delta(G)$. Once we have located w , we then have only one possibility for the edge uw , since all paths between w and any vertices of degree $\Delta(G)$ must use this edge.

Thus, we have constructed at least $\frac{(D_1(n)-6)|\mathcal{G}_n|}{(n-D_1(n))}$ *distinct* graphs in the set $\mathcal{P}(n, d_1, d_2, D_1, D_2)$ and, therefore,

$$\begin{aligned} \frac{|\mathcal{G}_n|}{|\mathcal{P}(n, d_1, d_2, D_1, D_2)|} &\leq \frac{(n - D_1(n))}{D_1(n) - 6} \\ &= \frac{o(n)}{n - o(n)} \\ &\rightarrow 0 \text{ as } n \rightarrow \infty. \quad \square \end{aligned}$$

References

- [1] L. Addario-Berry, C. Dowden, *Subgraphs of 4-regular planar graphs*, submitted.
- [2] E.A. Bender, Z. Gao, N.C. Wormald, *The number of 2-connected labelled planar graphs*, *Electronic Journal of Combinatorics* **9** (2002), R43.
- [3] K.S. Booth, G.S. Lueker, *Testing for the consecutive ones property, interval graphs, and graph planarity using PQ-tree algorithms*, *Journal of Computer and System Sciences* **13** (1976), 335-379.
- [4] A. Denise, M. Vasconcellos, D. Welsh, *The random planar graph*, *Congressus Numerantium* **113** (1996), 61-79.
- [5] R. Diestel, *Graph Theory (Third Edition)*, Springer (2006).
- [6] S. Even, O. Kariv, *An $O(n^{2.5})$ algorithm for maximum matching in graphs*, *Proceedings of the 16th Annual IEEE Symposium on Foundations of Computer Science* (1975), 100-112.
- [7] S. Gerke, C. McDiarmid, *On the number of edges in random planar graphs*, *Combinatorics, Probability and Computing* **13** (2004), 165-183.
- [8] S. Gerke, C. McDiarmid, A. Steger, A. Weiß, *Random planar graphs with given average degree*, from *Combinatorics, Complexity and Chance*, Oxford University Press (2007), 83-102.
- [9] S. Gerke, C. McDiarmid, A. Steger, A. Weiß, *Random planar graphs with n nodes and a fixed number of edges*, *Proceedings of the ACM-SIAM Symposium on Discrete Algorithms* (2005), 999-1007.
- [10] S. Gerke, D. Schlatter, A. Steger, A. Taraz, *The random planar graph process*, *Random Structures & Algorithms* **32** (2008), 236-261.

- [11] O. Giménez, M. Noy, *Asymptotic enumeration and limit laws of planar graphs*, manuscript at <http://arxiv.org/abs/math/0501269v2> (July 14 2005 version).
- [12] F. Harary, *Graph Theory*, Addison-Wesley (1969).
- [13] J.E. Hopcroft, R.E. Tarjan, *Dividing a graph into triconnected components*, SIAM Journal on Computing **2** (1973), 135-158.
- [14] S. Janson, T. Luczak, A. Ruciński, *Random Graphs*, Wiley (2000).
- [15] D. Johannsen, *Schranken zu Gleichgewichten bei Einfüge- und Löschooperationen von Kanten in Planaren Graphen*, unpublished.
- [16] C. McDiarmid, A. Steger, D. Welsh, *Random planar graphs*, Journal of Combinatorial Theory Series B **93** (2005), 187-205.
- [17] C. McDiarmid, B. Reed, *On the maximum degree of a random planar graph*, to appear in Journal of Combinatorial Theory Series B.
- [18] L. Szabó, *Regular circle packings*, Colloquia Mathematica Societatis János Bolyai **63** (1994), 465-474.
- [19] J.H. van Lint, R.M. Wilson, *A Course in Combinatorics*, Cambridge University Press (1992).
- [20] H. Whitney, *2-isomorphic graphs*, American Journal of Mathematics **55** (1933), 245-254.