

The Moran model with selection: Fixation probabilities, ancestral lines, and an alternative particle representation

Sandra Kluth, Ellen Baake*

Faculty of Technology, Bielefeld University, Box 100131, 33501 Bielefeld, Germany

Abstract. We reconsider the Moran model in continuous time with population size N , two allelic types, and selection. We introduce a new particle representation, which we call the labelled Moran model, and which has the same distribution of type frequencies as the original Moran model, provided the initial values are chosen appropriately. In the new model, individuals are labelled $1, 2, \dots, N$; neutral resampling events may take place between arbitrary labels, whereas selective events only occur in the direction of increasing labels. With the help of elementary methods only, we not only recover fixation probabilities, but also obtain detailed insight into the number and nature of the selective events that play a role in the fixation process forward in time.

Key words: Moran model with selection, fixation probability, labelled Moran model, defining event, ancestral line.

1 Introduction

In population genetics models for finite populations including selection, many properties are still unknown, in particular when it comes to ancestral processes and genealogies. This is why a classic model, namely the Moran model in continuous time with population size N , two allelic types, and (fertility) selection is still the subject of state-of-the-art research, see e.g. Bah et al. (2012), Mano (2009), Houchmandzadeh and Vallade (2010), or Pokalyuk and Pfaffelhuber (2013). In particular, new insights are currently being obtained by drawing a more fine-grained picture: Rather than looking only at the type frequencies as a function of time, one considers ancestral lines and genealogies of samples

*Corresponding author.

E-mail address: ebaake@techfak.uni-bielefeld.de

Tel.: +49 521 106 4896 (E. Baake)

as in the ancestral selection graph (ASG) (Krone and Neuhauser (1997), Neuhauser and Krone (1997)), or even particle representations that make all individual lines and their interactions explicit (here the main tool is the lookdown construction of Donnelly and Kurtz (1996, 1999)). See Etheridge (2011, Ch. 5) for an excellent overview of the area.

The way that fixation probabilities (that is, the probabilities that the individuals of a given type eventually take over in the population) are dealt with is typical of this development. The classical result is that of Kimura (1962), which is based on type frequencies in the diffusion limit. Short and elegant standard arguments today start from the discrete setting, use a first-step or martingale approach, and arrive at the fixation probability in the form of a (normalised) series expansion in the reproduction rate of the favourable type (cf. Durrett (2008, Thm. 6.1)). An alternative formulation is given by Kluth et al. (2013). Both are easily seen to converge to Kimura's result in the diffusion limit.

Recently, Mano (2009) obtained the fixation probabilities with the help of the ASG, based on methods of duality (again in the diffusion limit); his argument is nicely recapitulated by Pokalyuk and Pfaffelhuber (2013). What is still missing is a derivation within the framework of a full particle representation.

This is done in the present article. To this end, we introduce an alternative particle system, which we call the *labelled Moran model*, and which is particularly well-suited for finite populations under selection. It is reminiscent of the *N-particle look-down process*, but the main new idea is that each of the N individuals is characterised by a different reproductive behaviour, which we indicate by a label. With the help of elementary methods only, we not only recover fixation probabilities, but also obtain detailed insight into the number and nature of the selective events that play a role in the fixation process forward in time.

The paper is organised as follows. We start with a brief survey of the Moran model with selection (Sec. 2). Sec. 3 is a warm-up exercise that characterises fixation probabilities by way of a reflection principle. Sec. 4 introduces the labelled Moran model. With the help of a coupling argument that involves permutations of the reproductive events, we obtain the probability that a particular label becomes fixed. Within this setting, we identify reproduction events that affect the fixation probability of a given label; they are termed *defining events*. The number of defining events that are *selective* turns out as the pivotal quantity characterising the fixation probabilities of the individual labels, and hence the label of the line that will become ancestral to the entire population. In Sec. 5 we pass to the diffusion limit. We continue with a simulation algorithm that generates the label that becomes fixed together with the targets of the selective defining events (Sec. 6). Sec. 7 summarises and discusses the results.

2 The Moran model with selection

We consider a haploid population of fixed size $N \in \mathbb{N}$ in which each individual is characterised by a type $i \in S = \{A, B\}$. If an individual reproduces, its single offspring inherits the parent's type and replaces a randomly chosen individual, maybe its own

parent. This way the replaced individual dies and the population size remains constant.

Individuals of type B reproduce at rate 1, whereas individuals of type A reproduce at rate $1 + s_N$, $s_N \geq 0$. Accordingly, type- A individuals are termed ‘more fit’, type- B individuals are ‘less fit’. In line with a central idea of the ASG, we will decompose reproduction events into *neutral* and *selective* ones. Neutral ones occur at rate 1 and happen to all individuals, whereas selective events occur at rate s_N and are reserved for type- A individuals. (At this stage, these rates are understood as rates per individual.)

The Moran model has a well-known graphical representation as an interacting particle system (cf. Fig. 1). The N vertical lines represent the N individuals and time runs from top to bottom in the figure. Reproduction events are represented by arrows with the reproducing individual at the tail and the offspring at the head.

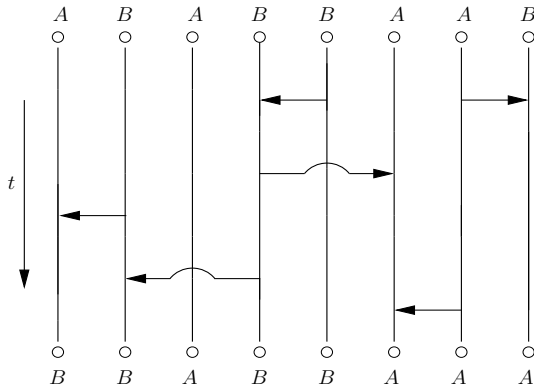

Figure 1: The Moran model. The types ($A =$ more fit, $B =$ less fit) are indicated for the initial population (top) and the final one (bottom).

We now consider the process $(Z_t^N)_{t \geq 0}$ (or simply Z^N), where Z_t^N is the number of individuals of type A at time t . (Note that this is the type frequency representation, which contains less information than the particle (or graphical) representation in Fig. 1.) Z^N is a birth-death process with birth rates λ_i^N and death rates μ_i^N when in state i , where

$$\lambda_i^N = (1 + s_N)i \frac{N - i}{N} \quad \text{and} \quad \mu_i^N = (N - i) \frac{i}{N}. \quad (1)$$

The absorbing states are 0 and N , thus, one of the two types, A or B , will almost surely become fixed in the population in finite time. Let $T_k^N := \min\{t \geq 0 : Z_t^N = k\}$, $0 \leq k \leq N$, be the first hitting time of state k by Z^N . The *fixation probability* of type A given that there are initially k type- A individuals is well known to be (cf. Durrett (2008, Thm. 6.1))

$$h_k^N := \mathbb{P}(T_N^N < T_0^N \mid Z_0^N = k) = \frac{\sum_{j=N-k}^{N-1} (1 + s_N)^j}{\sum_{j=0}^{N-1} (1 + s_N)^j}. \quad (2)$$

An alternative formulation is obtained by Kluth et al. (2013), where fixation probabilities under selection *and* mutation are considered. It is easily verified that, taking

together their Eq. (40), Theorem 2, and Eq. (30) and setting the mutation rate to zero gives the representation

$$h_k^N = \frac{k}{N} + \sum_{n=1}^{N-1} a_n^N \frac{k}{N} \prod_{j=0}^{n-1} \frac{N-k-j}{N-1-j}, \quad (3)$$

where the coefficients a_n^N follow the recursion

$$a_n^N - a_{n+1}^N = s_N \frac{N-n}{n+1} (a_{n-1}^N - a_n^N) \quad (4)$$

for $1 \leq n \leq N-2$, with initial conditions

$$a_0^N = 1 \quad \text{and} \quad a_1^N = a_0^N - N(1 - h_{N-1}^N). \quad (5)$$

Eq. (3) is suggestive: It decomposes the fixation probability into the neutral part (k/N) plus additional terms due to offspring created by selective events. It is the purpose of this paper to make this interpretation more precise, and to arrive at a thorough understanding of Eq. (3). In particular, we aim at a probabilistic understanding of the coefficients a_n^N .

Before doing this it is useful to consider the model in the diffusion limit. To this end, we use the usual rescaling

$$(X_t^N)_{t \geq 0} := \frac{1}{N} (Z_{Nt}^N)_{t \geq 0},$$

and assume that $\lim_{N \rightarrow \infty} N s_N = \sigma$, $0 \leq \sigma < \infty$. As $N \rightarrow \infty$, $(X_t^N)_{t \geq 0}$ converges in distribution to the well known diffusion process $(X_t)_{t \geq 0}$, which is characterised by the drift coefficient $a(x) = \sigma x(1-x)$ and the diffusion coefficient $b(x) = 2x(1-x)$. Hence, the infinitesimal generator \mathcal{A} of the diffusion is defined by

$$\mathcal{A}f(x) = x(1-x) \frac{\partial^2}{\partial x^2} f(x) + \sigma x(1-x) \frac{\partial}{\partial x} f(x), \quad f \in \mathcal{C}^2([0, 1]).$$

Define the first passage time $T_x := \inf\{t \geq 0 : X_t = x\}$, $x \in [0, 1]$, as the first time that X_t equals x . For $\sigma \neq 0$ the fixation probability of type A follows a classical result of Kimura (1962) (see also Ewens (2004, Ch. 5.3)):

$$h(x) := \mathbb{P}(T_1 < T_0 \mid X_0 = x) = \frac{1 - \exp(-\sigma x)}{1 - \exp(-\sigma)}. \quad (6)$$

See also Ewens (2004, Ch. 4, 5) or Karlin and Taylor (1981, Ch. 15) for reviews of the diffusion process describing the Moran model with selection and its probability of fixation.

According to Kluth et al. (2013) and previous results of Fearnhead (2002) and Taylor (2007) (obtained in the context of the common ancestor process in the Moran model with selection and mutation), the equivalent of (3) reads

$$h(x) = x + \sum_{n \geq 1} a_n x(1-x)^n \quad (7)$$

with coefficients $a_n = \lim_{N \rightarrow \infty} a_n^N$, $n \geq 1$. Following (4) and (5), the a_n are characterised by the recursion

$$a_n - a_{n+1} = \frac{\sigma}{n+1}(a_{n-1} - a_n) \quad (8)$$

with initial conditions

$$a_0 = 1 \quad \text{and} \quad a_1 = a_0 - h'(1). \quad (9)$$

3 Reflection principle

Durrett (2008, Ch. 6.1.1) proves equation (2) in two ways, namely, using a first-step approach and a martingale argument, respectively. Both approaches rely on the process $(Z_t^N)_{t \geq 0}$, without reference to an underlying particle representation. As a warm-up exercise, we complement this by an approach based on the particle picture, which we call the *reflection principle*.

Definition 1. *Let a graphical realisation of the Moran model be given, with $Z_0^N = k$, $1 \leq k \leq N - 1$, and fixation of type A . Now interchange the types (i.e., replace all A individuals by B individuals and vice versa), without otherwise changing the graphical realisation. This results in a graphical realisation of the Moran model with $Z_0^N = N - k$ in which type B becomes fixed, and is called the *reflected realisation*.*

Put differently, in the case $Z_0^N = k$, $1 \leq k \leq N - 1$, reflection transforms a realisation in which the (offspring of the) k type- A individuals become fixed (altogether, this happens with probability h_k^N) into a realisation in which the (offspring of the) type- B individuals become fixed (which happens with probability $1 - h_{N-k}^N$), and vice versa. This operation does not change the graphical structure, but the weights of the realisations are different since a different weight is attached to some of the arrows. This is best explained in the example given in Fig. 2: Bold lines represent type- A individuals, thin ones type- B individuals; likewise, arrows emanating from type- A (type- B) individuals are bold (thin). Interchange of types transforms the realisation on the left into the realisation on the right and vice versa, such that the respective other type becomes fixed. Arrows that are marked by 1 respectively $1 + s_N$ appear at rate $1/N$ respectively $(1 + s_N)/N$ (per pair of individuals).

To make the situation tractable, we will work with what we will call the *reduced Moran model*: Starting from the original Moran model, we remove those selective arrows that appear between individuals that are both of type A . Obviously, this does not affect the process Z^N (in particular, it does not change the fixation probabilities), but it changes the graphical representation. That is, in Fig. 2 unmarked arrows appear at rate $1/N$.

Let now Ω^N be the set of graphical realisations of the reduced Moran model for $t \in [0, T]$, where $T := \min\{T_0^N, T_N^N\}$. Let P_k^N be the probability measure on Ω^N , given $Z_0^N = k$, $1 \leq k \leq N - 1$. For a realisation $\omega \in \Omega^N$ with $Z_0^N = k$, $1 \leq k \leq N - 1$, in which A becomes fixed (cf. Fig. 2, left), we define $\bar{\omega} \in \Omega^N$ as the corresponding reflected realisation (cf. Fig. 2, right).

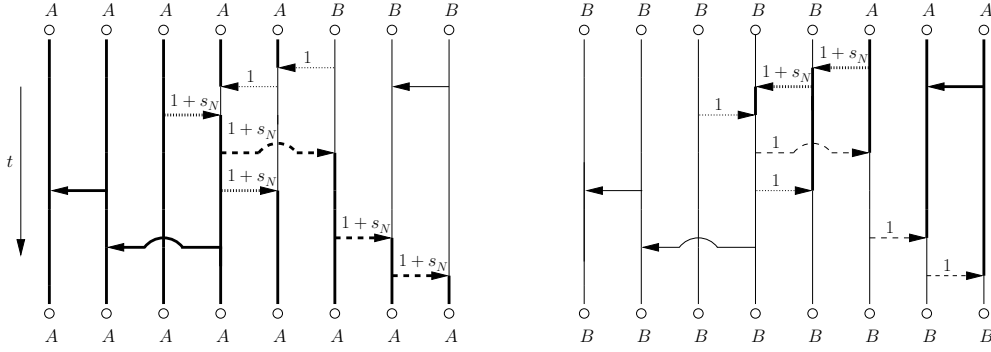

Figure 2: Reflection principle in the (reduced) Moran model: $N = 8$, $k = 5$, realisations ω (left) and $\bar{\omega}$ (right). Altogether $P_3^8(\bar{\omega})d\omega = (1 + s_N)^{-3}(1 + s_N)^2(1 + s_N)^{-2}P_5^8(\omega)d\omega$.

Our strategy will now be to derive the fixation probabilities by comparing the weights of ω and $\bar{\omega}$. To assess the relative weights of $P_k^N(\omega)d\omega$ and $P_{N-k}^N(\bar{\omega})d\omega$, note first that, since A becomes fixed in ω , all $N - k$ type- B individuals have to be replaced by type- A individuals, i.e. by arrows that appear at rate $(1 + s_N)/N$. In $\bar{\omega}$, the corresponding arrows point from type- B to type- A individuals and thus occur only at rate $1/N$. Second, we have to take into account so-called *external descendants* defined as follows:

Definition 2. A descendant of a type- i individual, $i \in S$, that originates by replacing an individual of a different type ($j \neq i$) is termed *external descendant of type i* .

Remark 1. The total number of external descendants of type i is almost surely finite.

Every external descendant of a type- B individual goes back to an arrow that occurs at rate $1/N$. If the type- A individuals go to fixation (as in ω), all external descendants of type B must eventually be replaced by arrows that emanate from type- A individuals and therefore occur at rate $(1 + s_N)/N$. In $\bar{\omega}$ this situation corresponds to external descendants of type A that originate from arrows at rate $(1 + s_N)/N$ and are eventually eliminated by arrows that emanate from type- B individuals. In Fig. 2, the births of external descendants and their replacements are represented by dotted arrows, which always appear in pairs. Dashed arrows represent the elimination of individuals (except external descendants) of the type that eventually gets lost in the population.

Let now $D_B^N(\omega)$ be the number of external descendants of type B in ω . Then $D_B^N(\omega) < \infty$ almost surely and we obtain for the measure of $\bar{\omega}$

$$\begin{aligned} P_{N-k}^N(\bar{\omega})d\omega &= (1 + s_N)^{-(N-k)}(1 + s_N)^{D_B^N(\omega)} \left(\frac{1}{1 + s_N} \right)^{D_B^N(\omega)} P_k^N(\omega)d\omega \\ &= (1 + s_N)^{-(N-k)} P_k^N(\omega)d\omega. \end{aligned}$$

Note that the effects of creating external descendants and their replacement cancel each other, so that the relative weights of $P_{N-k}^N(\bar{\omega})d\omega$ and $P_k^N(\omega)d\omega$ do not depend on ω .

Since reflection provides a one-to-one correspondence between realisations with fixation of type A and of type B , respectively, we obtain the system of equations

$$1 - h_{N-k}^N = (1 + s_N)^{-(N-k)} h_k^N, \quad 1 \leq k \leq N - 1, \quad (10)$$

which is supplemented by $h_0^N = 0$ and $h_N^N = 1$, and which is solved by (2).

4 Labelled Moran model

In this Section we introduce a new particle model, which we call the *labelled Moran model*, and which has the same distribution of type frequencies as the original Moran model with selection of Sec. 2, provided the initial conditions are chosen appropriately. As before, we consider a population of fixed size N in continuous time, but now every individual is assigned a label $i \in \{1, \dots, N\}$ with different reproductive behaviour to be specified below. The initial population contains all N labels so that initially position i in the graphical representation is occupied by label i , $1 \leq i \leq N$. As in the original Moran model, birth events are represented by arrows; they lead to a single offspring, which inherits the parent's label, and replaces an individual as explained below. Again we distinguish between neutral (at rate $1/N$) and selective (at rate s_N/N) events. Neutral arrows appear as before, at rate $1/N$ per ordered pair of lines, irrespective of their labels. But we only allow for selective arrows emanating from a label i and pointing to a label $j > i$ (at rate s_N/N per ordered pair of lines with such labels). Equivalently, we may take together both types of arrows, such that an arrow points from a label i to a label $j \leq i$ at rate $1/N$ and to label $j > i$ at rate $(1 + s_N)/N$. We will make use of both points of view. The idea is to have each label behave as ‘less fit’ towards lower labels and as ‘more fit’ towards higher labels. An example is given in Fig. 3, where neutral arrows are marked by 1 and selective arrows by s_N .

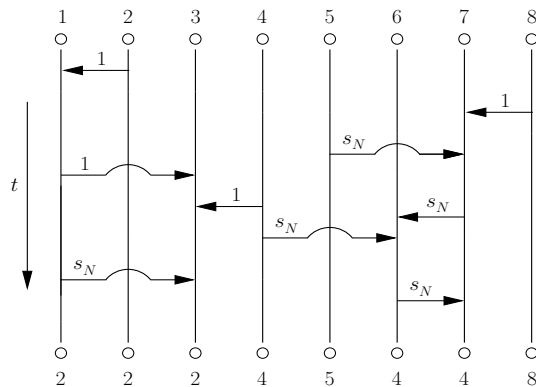

Figure 3: The labelled Moran model. The labels are indicated for the initial population (top) and a later one (bottom).

4.1 Ancestors and fixation probabilities

Since there is no mutation in the labelled Moran model, one of the N labels will eventually take over in the population, i.e. one label will become fixed. We denote this label by I^N and term it the ancestor. Its distribution is given in Thm. 1.

Theorem 1. I^N is distributed according to

$$\eta_i^N := \mathbb{P}(I^N = i) = (1 + s_N)^{N-i} \eta_N^N = h_i^N - h_{i-1}^N, \quad 1 \leq i \leq N, \quad (11)$$

with

$$\eta_N^N := \mathbb{P}(I^N = N) = \frac{1}{\sum_{j=0}^{N-1} (1 + s_N)^j} = 1 - h_{N-1}^N. \quad (12)$$

We will give two proofs of Thm. 1. The first provides an intuitive explanation and is based on the type frequencies. In the second proof, we will use an alternative approach in the spirit of the reflection principle of Sec. 3, which provides more insight into the particle representation. This proof is somewhat more complicated, but it permits us to classify reproduction events into those that have an effect on the fixation probability of a given label and those that do not; this will become important later on. In analogy with Def. 2 we define *external descendants of labels in \mathcal{S}* , $\mathcal{S} \subseteq \{1, \dots, N\}$, as descendants of individuals with labels in \mathcal{S} that originate by replacing an individual of a label in the complement of \mathcal{S} .

First proof of Thm. 1. For a given i , let $\bar{Z}_t^{N,i}$ be the number of individuals with labels in $\{1, \dots, i\}$ at time t . Like Z^N , the process $\bar{Z}^{N,i} = (\bar{Z}_t^{N,i})_{t \geq 0}$ is a birth-death process with rates λ_j^N and μ_j^N of (1). This is because every individual with label in $\{1, \dots, i\}$ sends arrows into the set with labels in $\{i+1, \dots, N\}$ at rate $(1 + s_N)/N$; in the opposite direction, the rate is $1/N$ per pair of individuals; and arrows within the label classes do not matter. Since $\bar{Z}_0^{N,i} = i$, the processes $\bar{Z}^{N,i}$ and Z^N thus have the same law provided $Z_0^N = i$. As a consequence, $\mathbb{P}(I^N \leq i) = \sum_{j=1}^i \eta_j^N = h_i^N$, $1 \leq i \leq N$, which, together with (2), immediately yields the assertions of Thm. 1. \square

Second proof of Thm. 1. This proof aims at a direct calculation of η_i^N , $1 \leq i \leq N-1$, as a function of η_N^N . Let a realisation of the labelled Moran model be given in which label N becomes fixed (this happens with probability η_N^N , still to be calculated). The basic idea now is to move every arrow by way of a cyclic permutation of the arrows' positions, while keeping the initial ordering of the labels. More precisely, in the graphical representation we move every arrow i positions to the right (or, equivalently, $N-i$ positions to the left). That is, we shift an arrow that appears at time t with tail at position k and head at position ℓ , such that it becomes an arrow that emanates from position $(k+i) \bmod N$ and points to position $(\ell+i) \bmod N$, again at time t . We thus obtain what we will call the *permuted realisation of order i* . In this realisation, label i is fixed, as illustrated in Fig. 4 for a labelled Moran model of size $N=8$. Here, the descendants of the label

that becomes fixed are marked bold. Arrows that are marked by 1 respectively $1 + s_N$ appear at rate $1/N$ respectively $(1 + s_N)/N$. A shift of every arrow of $i = 5$ positions to the right transforms the left realisation, in which label $N = 8$ becomes fixed, into the right one (with fixation of label $i = 5$).

Throughout, we keep the original meaning of the labels: Between every ordered pair of lines with labels (i, j) , arrows appear at rate $(1 + s_N)/N$ if $j > i$, and at rate $1/N$ otherwise. Since, in the permuted realisation, we change the *position* of each arrow, it now may affect a different pair of *labels*, which may change the arrow's rate. As a result, the permuted realisation has a different weight than the original one; this will now be used to calculate η_i^N . (Mathematically, the following may be seen as a *coupling argument*.)

So, let Ω^N be the set of realisations of the labelled Moran model for $t \in [0, T]$, where T now is the time at which one of the labels is fixed. Let P^N be the probability measure on Ω^N . For a realisation $\omega_N \in \Omega^N$ in which label N becomes fixed (cf. Fig. 4, left), we define $\omega_i \in \Omega^N$ as the corresponding permuted realisation of order i (cf. Fig. 4, right). We will now calculate η_i^N by assessing the weight of the measure of ω_i relative to that of ω_N . Below we run briefly through the cases to analyse the change of weight on the various types of arrows. To this end, the label sets $\{1, \dots, N - i\}$ and $\{N - i + 1, \dots, N\}$ (left), and $\{1, \dots, i\}$ and $\{i + 1, \dots, N\}$ (right), respectively, are encircled at the top of Fig. 4.

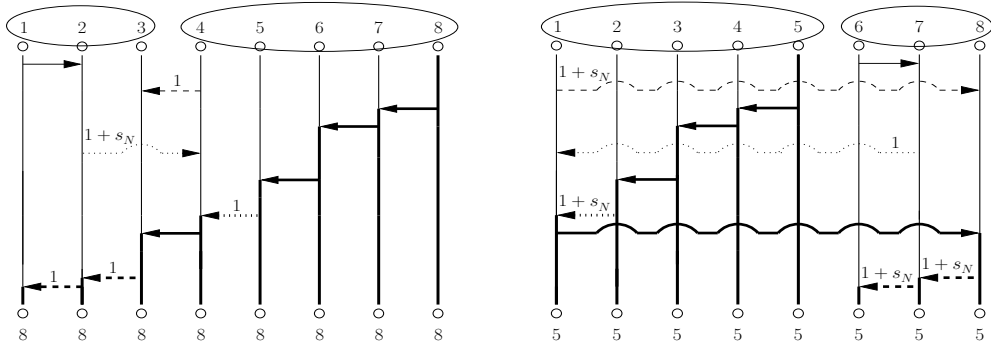

Figure 4: Cyclic permutation in the labelled Moran model: $N = 8$, $i = 5$, realisations ω_8 (left) and ω_5 (right). Altogether $P^8(\omega_5)d\omega_8 = (1 + s_N)^{-1}(1 + s_N)(1 + s_N)^3 P^8(\omega_8)d\omega_8$.

- (a) Arrows in ω_N that point from and to labels within the sets $\{1, \dots, N - i\}$ or $\{N - i + 1, \dots, N\}$, respectively, turn into arrows within the sets $\{i + 1, \dots, N\}$ or $\{1, \dots, i\}$, respectively, under the permutation. Such arrows retain their ‘direction’ (with respect to the labels) and thus appear at identical rates in ω_N and ω_i (cf. solid arrows in Fig. 4).
- (b) Arrows in ω_N that emanate from the set of labels $\{1, \dots, N - i\}$ and point to the set of labels $\{N - i + 1, \dots, N\}$ occur at rate $(1 + s_N)/N$ and create external descendants

of labels in $\{1, \dots, N - i\}$. Since label N becomes fixed, every such external descendant is eventually eliminated by an arrow at rate $1/N$. The corresponding situation in ω_i concerns external descendants of labels in $\{i + 1, \dots, N\}$, which result from neutral arrows and finally are replaced at rate $(1 + s_N)/N$ each. In Fig. 4 there is exactly one external descendant of the labels in $\{1, \dots, N - i\}$ (left) and $\{i + 1, \dots, N\}$ (right), respectively. It originates from the respective first dotted arrow, and is replaced via the second dotted arrow.

- (c) It remains to deal with the replacement of the labels $1, \dots, N - i$ (except for their external descendants) in ω_N . Exactly $N - i$ neutral arrows are responsible for this, they transform into arrows at rate $(1 + s_N)/N$ through the permutation. These are the dashed arrows in Fig. 4.

Let now $D_{\leq i}^N(\omega_N)$ be the number of external descendants of labels in $\{1, \dots, i\}$ in ω_N ($D_{\leq i}^N(\omega_N) < \infty$ almost surely). Then, (a) - (c) yield for the measure of ω_i

$$\begin{aligned} P^N(\omega_i)d\omega_N &= (1 + s_N)^{D_{\leq i}^N(\omega_N)} \left(\frac{1}{1 + s_N} \right)^{D_{\leq i}^N(\omega_N)} (1 + s_N)^{N-i} P^N(\omega_N)d\omega_N \\ &= (1 + s_N)^{N-i} P^N(\omega_N)d\omega_N. \end{aligned}$$

As in the reflection principle, the effects of the external descendants cancel each other and so the relative weights of $P^N(\omega_i)d\omega_N$ and $P^N(\omega_N)d\omega_N$ are independent of the particular choice of ω_N . Since the cyclic permutation yields a one-to-one correspondence between realisations that lead to fixation of label N and label i , respectively, we obtain

$$\eta_i^N = (1 + s_N)^{N-i} \eta_N^N, \quad 1 \leq i \leq N. \quad (13)$$

Finally, the normalisation

$$1 = \sum_{i=1}^N \eta_i^N = \eta_N^N \sum_{i=1}^N (1 + s_N)^{N-i}$$

yields the assertion of Thm. 1. □

4.2 Defining events

We are now ready to investigate the effect of selection in more depth. The second proof of Thm. 1 allows us to identify the reproduction events that affect the distribution of I^N (i.e. that are responsible for the factor $(1 + s_N)^{N-I^N}$ in (11)) with the dashed arrows in Fig. 4 (cf. case (c)), whereas dotted arrows appear pairwise and their effects cancel each other (cf. case (b)). It is natural to term these reproductions *defining events*:

Definition 3. *A defining event is an arrow that emanates from the set of labels $\{1, \dots, I^N\}$ and targets individuals with labels in the set $\{I^N + 1, \dots, N\}$ that are not external descendants of labels in $\{I^N + 1, \dots, N\}$.*

Loosely speaking, a defining event occurs every time the descendants of $\{1, \dots, I^N\}$ ‘advance to the right’. In particular, for every $j \in \{I^N + 1, \dots, N\}$, the first arrow that emanates from a label in $\{1, \dots, I^N\}$ and hits the individual at position j is a defining event. Altogether, there will be $N - I^N$ defining events until fixation. It is important to note that they need not be reproduction events of the ancestral label I^N itself.

See Fig. 5 for an illustration, in which the ancestor I^N is indicated at the top, its descendants are marked bold, and the defining events are represented by dashed arrows. On the left, both defining events are reproduction events of I^N . The arrows that are indicated by $*$ and $**$ are not defining events, since the first one ($*$) concerns only labels within $\{I^N + 1, \dots, N\}$ and the second one ($**$) targets an external descendant of $\{I^N + 1, \dots, N\}$. On the right, only the second defining event is a reproduction event of I^N , whereas the first one is a reproduction event of a label less than I^N .

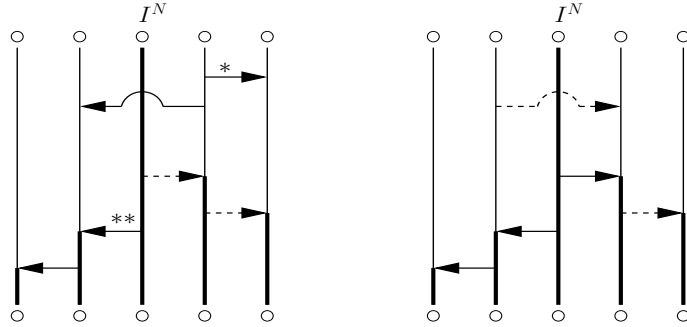

Figure 5: Defining events in the labelled Moran model.

It is clear that all defining events appear at rate $(1 + s_N)/N$. Decomposing these arrows into neutral and selective ones reveals that each defining event is either a selective (probability $s_N/(1 + s_N)$) or a neutral (probability $1/(1 + s_N)$) reproduction event, independently of the other defining events and of I^N . Let V_i^N , $I^N + 1 \leq i \leq N$, be the corresponding family of Bernoulli random variables that indicate whether the respective defining event is selective. Let Y^N denote the *number of selective defining events*, that is,

$$Y^N := \sum_{i=I^N+1}^N V_i^N \quad (14)$$

with the independent and identically distributed (i.i.d.) Bernoulli variables V_i^N just defined. Y^N will turn out as a pivotal quantity for everything to follow. We now characterise its distribution, and the dependence between I^N and Y^N . This will also provide us with an interpretation of the coefficients a_n^N in (3), as well as another representation of the fixation probabilities.

It is clear from (14) that Y^N is distributed according to $\text{Bin}(N - I^N, s_N/(1 + s_N))$, the binomial distribution with parameters $N - I^N$ and $s_N/(1 + s_N)$ in the sense of a two-stage random experiment. That is, given $I^N = i$, Y^N follows $\text{Bin}(N - i, s_N/(1 + s_N))$.

Thus, for $0 \leq n \leq N - i$, we obtain (via (11))

$$\mathbb{P}(Y^N = n, I^N = i) = \binom{N-i}{n} \left(\frac{s_N}{1+s_N} \right)^n \left(\frac{1}{1+s_N} \right)^{N-i-n} \eta_i^N = \binom{N-i}{n} s_N^n \eta_N^N \quad (15)$$

and thus

$$\mathbb{P}(Y^N = n) = \sum_{i=1}^{N-n} \binom{N-i}{n} s_N^n \eta_N^N = \sum_{i=n}^{N-1} \binom{i}{n} s_N^n \eta_N^N = \binom{N}{n+1} s_N^n \eta_N^N, \quad (16)$$

where the last equality is due to the well-known identity

$$\sum_{i=\ell}^k \binom{i}{\ell} = \binom{k+1}{\ell+1}, \quad \ell, k \in \mathbb{N}_0, 0 \leq \ell \leq k. \quad (17)$$

In particular, $\mathbb{P}(Y^N = 0) = N\eta_N^N$. Obviously, $\mathbb{P}(Y^N = n)$, $n \geq 1$, may also be expressed recursively as

$$\mathbb{P}(Y^N = n) = s_N \frac{N-n}{n+1} \mathbb{P}(Y^N = n-1). \quad (18)$$

Furthermore, equations (15) and (16) immediately yield the conditional probability

$$\mathbb{P}(I^N = i \mid Y^N = n) = \frac{\binom{N-i}{n}}{\binom{N}{n+1}}. \quad (19)$$

Compare now (18) with (4) and, for the initial condition, compare (16) with (5) (with the help of (12)). Obviously, the $\mathbb{P}(Y^N = n)$ and the $a_n^N - a_{n+1}^N$, $0 \leq n \leq N - 2$, have the same initial value (at $n = 0$) and follow the same recursion, so they agree. Via normalisation, we further have

$$\mathbb{P}(Y^N = N - 1) = 1 - \sum_{n=0}^{N-2} (a_n^N - a_{n+1}^N) = a_{N-1}^N.$$

We have therefore found a probabilistic meaning for the a_n^N , $0 \leq n \leq N - 1$, namely,

$$a_n^N = \mathbb{P}(Y^N \geq n). \quad (20)$$

This will be crucial in what follows.

Another interesting characterisation is the following:

Proposition 1. *Let $W^N := Y^N + 1$. Then W^N has the distribution of a random variable that follows $\text{Bin}(N, s_N/(1+s_N))$, conditioned to be positive.*

Proof. Let A be a random variable distributed according to $\text{Bin}(N, s_N/(1+s_N))$. Then

$$\mathbb{P}(A > 0) = 1 - \frac{1}{(1+s_N)^N} = \left(1 - \frac{1}{1+s_N}\right) \sum_{i=0}^{N-1} \frac{1}{(1+s_N)^i}$$

by the geometric series. For $n \geq 1$, therefore,

$$\mathbb{P}(A = n \mid A > 0) = \frac{\binom{N}{n} s_N^n (1 + s_N)^{-N}}{\frac{s_N}{1+s_N} \sum_{i=0}^{N-1} (1 + s_N)^{-i}} = \frac{\binom{N}{n} s_N^{n-1}}{\sum_{i=0}^{N-1} (1 + s_N)^i} = \mathbb{P}(Y^N = n - 1),$$

where the last step is due to (16). This proves the claim. \square

Note that label N is obviously not capable of selective reproduction events and its fixation implies the absence of (selective) defining events. Its fixation probability η_N^N coincides with the fixation probability of any label i , $1 \leq i \leq N$, in the absence of any selective defining events: $\mathbb{P}(Y^N = 0, I^N = i) = \eta_N^N$, cf. (15). For this reason, we term η_N^N the *basic fixation probability* of every label i , $1 \leq i \leq N$, and express all relevant quantities in terms of η_N^N . Note that, for $s_N > 0$, η_N^N is different from the *neutral fixation probability*, $\eta_i^N = 1/N$, that applies to every label i , $1 \leq i \leq N$, in the case $s_N = 0$.

Decomposition according to the number of selective defining events yields a further alternative representation of the fixation probability h_i^N (cf. (2)) of the Moran model. Consider

$$\mathbb{P}(I^N \leq i \mid Y^N = n) = \frac{1}{\binom{N}{n+1}} \sum_{j=1}^i \binom{N-j}{n} = \frac{1}{\binom{N}{n+1}} \sum_{j=N-i}^{N-1} \binom{j}{n} = \frac{\binom{N}{n+1} - \binom{N-i}{n+1}}{\binom{N}{n+1}}, \quad (21)$$

where we have used (19) and (17). This leads us to the following series expansion in s_N :

$$\begin{aligned} h_i^N = \mathbb{P}(I^N \leq i) &= \sum_{n=0}^{N-1} \mathbb{P}(I^N \leq i \mid Y^N = n) \mathbb{P}(Y^N = n) \\ &= \sum_{n=0}^{N-1} \left[\binom{N}{n+1} - \binom{N-i}{n+1} \right] s_N^n \eta_N^N. \end{aligned} \quad (22)$$

We will come back to this in the next Section.

5 Y^N in the diffusion limit

In this Section we analyse the number of selective defining events in the diffusion limit (cf. Sec. 2). First of all we recapitulate from (15) and (11) that

$$\mathbb{P}(Y^N = n, I^N \leq i) = \frac{1}{N} \sum_{j=1}^i \binom{N-j}{n} \left(\frac{s_N}{1+s_N} \right)^n \left(\frac{1}{1+s_N} \right)^{N-j-n} N(h_j^N - h_{j-1}^N).$$

For a sequence $(i_N)_{N \in \mathbb{N}}$ with $i_N \in \{1, \dots, N\}$, $\lim_{N \rightarrow \infty} i_N/N = x$, and $x \in [0, 1]$, this yields

$$\lim_{N \rightarrow \infty} \mathbb{P}(Y^N = n, I^N/N \leq i_N/N) = \int_0^x \frac{(\sigma(1-y))^n}{n!} \exp(-\sigma(1-y)) h'(y) dy, \quad (23)$$

where we have used the convergence of the binomial to the Poisson distribution. Thus, the sequence of random variables $(Y^N, I^N/N)_{N \in \mathbb{N}}$ converges in distribution to a pair (Y^∞, I^∞) of random variables with values in $\mathbb{N}_0 \times [0, 1]$ and distribution function (23). Marginalisation with respect to the second variable implies that I^∞ has distribution function h . As a consequence, Y^∞ follows $\text{Poi}(\sigma(1 - I^\infty))$, the Poisson distribution with parameter $\sigma(1 - I^\infty)$.

Since

$$\mathbb{P}(Y^\infty \geq n) = \lim_{N \rightarrow \infty} \mathbb{P}(Y^N \geq n) = \lim_{N \rightarrow \infty} a_n^N = a_n, \quad (24)$$

with coefficients a_n as in (8) and (9), we may conclude that $\mathbb{P}(Y^\infty = n) = a_n - a_{n+1}$ for $n \geq 0$. We thus have found an interpretation of the coefficients a_n in (7). In particular,

$$\begin{aligned} \mathbb{P}(Y^\infty = 0) &= \lim_{N \rightarrow \infty} \mathbb{P}(Y^N = 0) = \lim_{N \rightarrow \infty} N \eta_N^N = \lim_{N \rightarrow \infty} \left[\frac{1}{N} \sum_{j=0}^{N-1} \left(1 + \frac{N s_N}{N} \right)^{\frac{j}{N} N} \right]^{-1} \\ &= \left[\int_0^1 \exp(\sigma p) dp \right]^{-1} = \frac{\sigma}{\exp(\sigma) - 1}, \end{aligned} \quad (25)$$

where we have used (16) and (12). According to (8) we have the recursion

$$\mathbb{P}(Y^\infty = n) = \frac{\sigma}{n+1} \mathbb{P}(Y^\infty = n-1) \quad (26)$$

for $n \geq 1$ and iteratively via (26) and (25)

$$\mathbb{P}(Y^\infty = n) = \frac{\sigma^n}{(n+1)!} \mathbb{P}(Y^\infty = 0) = \frac{\sigma^{n+1}}{(n+1)! (\exp(\sigma) - 1)} \quad (27)$$

for $n \geq 0$. With an argument analogous to that in Prop. 1, one also obtains that $W^\infty := Y^\infty + 1$ has the distribution of a random variable following $\text{Poi}(\sigma)$, conditioned to be positive.

We now aim at expressing h in terms of a decomposition according to the values of Y^∞ (in analogy with (22)). We recapitulate equation (21) to obtain

$$\mathbb{P}(I^\infty \leq x \mid Y^\infty = n) = \lim_{N \rightarrow \infty} \mathbb{P}(I^N \leq i_N \mid Y^N = n) = \lim_{N \rightarrow \infty} 1 - \frac{\binom{N-i_N}{n+1}}{\binom{N}{n+1}} = 1 - (1-x)^{n+1}.$$

Then, the equivalent to (22) is a series expansion in σ :

$$\begin{aligned} h(x) &= \mathbb{P}(I^\infty \leq x) = \sum_{n \geq 0} \mathbb{P}(I^\infty \leq x \mid Y^\infty = n) \mathbb{P}(Y^\infty = n) \\ &= \frac{1}{\exp(\sigma) - 1} \sum_{n \geq 1} \frac{1}{n!} (1 - (1-x)^n) \sigma^n. \end{aligned} \quad (28)$$

Note that this can also be derived directly from (6) by a Taylor expansion around the point $x = 1$.

Finally note that (28) may also be expressed as

$$h(x) = \sum_{n \geq 1} (1 - (1 - x)^n)(a_{n-1} - a_n) = \mathbb{E}(1 - (1 - x)^{W^\infty}). \quad (29)$$

Interestingly, but not unsurprisingly, this coincides with a representation given by Pokalyuk and Pfaffelhuber (2013, Lemma 2.2) in their proof of Kimura’s fixation probability (6). They follow an argument of Mano (2009) that establishes a connection between the ASG at stationarity and the fixation probability. A key here is the insight that the number of lines in the ASG at stationarity has the distribution of a random variable that follows $\text{Poi}(\sigma)$, conditioned to be positive – which coincides with the distribution of W^∞ .

6 The targets of selective defining events and construction of the ancestral line

We have, so far, been concerned with the ancestral label and with the number of selective defining events, but have not investigated the *targets* of these events yet. This will now be done. We begin with another definition.

Definition 4. Let Y^N take the value n . We then denote by J_1^N, \dots, J_n^N , with $J_1^N < \dots < J_n^N$, the (random) positions that are hit by the n selective defining events.

See Fig. 6 for an example, in which $N = 5$, $I^N = 2$, $Y^N = 2$, $J_1^N = 3$ and $J_2^N = 5$. Note that the first selective defining event hits position 3, which is occupied by an individual of label 4 at that time.

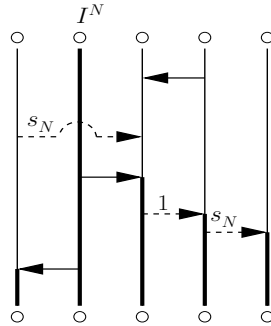

Figure 6: Targets of selective defining events.

In terms of the family V_i^N , $I^N + 1 \leq i \leq N$, of i.i.d. Bernoulli random variables (cf. Sec. 4.2), the $J_1^N, \dots, J_{Y^N}^N$ are characterised as

$$\{J_1^N, \dots, J_{Y^N}^N\} = \{i \in \{I^N + 1, \dots, N\} : V_i^N = 1\}.$$

(For $Y^N = 0$ we have the empty set.) Given that $Y^N = n$, the n -tuple (J_1^N, \dots, J_n^N) is uniformly distributed (without replacement) on the set of positions $\{I^N + 1, \dots, N\}$:

$$\mathbb{P}(J_1^N = j_1, \dots, J_n^N = j_n \mid I^N = i, Y^N = n) = \frac{1}{\binom{N-i}{n}},$$

which implies (via (19))

$$\mathbb{P}(I^N = i, J_1^N = j_1, \dots, J_n^N = j_n \mid Y^N = n) = \frac{1}{\binom{N}{n+1}}. \quad (30)$$

Hence, the $(n+1)$ -tuples $(I^N, J_1^N, \dots, J_n^N)$ are sampled from $\{1, \dots, N\}$ uniformly without replacement. Note that W^N of Prop. 1 is the size of this tuple. Note also that the tuples do not contain any further information about the appearance of arrows in the particle picture. In particular, we do not learn which label ‘sends’ the arrows, nor do we include selective arrows that do not belong to defining events.

It is instructive to formulate a simulation algorithm (or a construction rule) for these tuples.

Algorithm 1. *First draw the number of selective defining events, that is, a realisation n of Y^N (according to (16)). Then simulate $(I^N, J_1^N, \dots, J_n^N)$ in the following way:*

Step 0: *Generate a random number $U^{(0)}$ that is uniformly distributed on $\{1, \dots, N\}$. Define $\mathcal{I}^{(0)} := U^{(0)}$. If $n > 0$ continue with step 1, otherwise stop.*

Step 1: *Generate (independently of $U^{(0)}$) a second random number $U^{(1)}$ that is uniformly distributed on $\{1, \dots, N\} \setminus U^{(0)}$.*

(a) *If $U^{(1)} > \mathcal{I}^{(0)}$, define $\mathcal{I}^{(1)} := \mathcal{I}^{(0)}$, $\mathcal{J}_1^{(1)} := U^{(1)}$.*

(b) *If $U^{(1)} < \mathcal{I}^{(0)}$, define $\mathcal{I}^{(1)} := U^{(1)}$, $\mathcal{J}_1^{(1)} := \mathcal{I}^{(0)}$.*

If $n > 1$ continue with step 2, otherwise stop.

Step k : *Generate (independently of $U^{(0)}, \dots, U^{(k-1)}$) a random number $U^{(k)}$ that is uniformly distributed on $\{1, \dots, N\} \setminus \{U^{(0)}, \dots, U^{(k-1)}\}$.*

(a) *If $U^{(k)} > \mathcal{I}^{(k-1)}$, define $\mathcal{I}^{(k)} := \mathcal{I}^{(k-1)}$ and assign the variables $U^{(k)}, \mathcal{J}_1^{(k-1)}, \dots, \mathcal{J}_{k-1}^{(k-1)}$ to $\mathcal{J}_1^{(k)}, \dots, \mathcal{J}_k^{(k)}$, such that $\mathcal{J}_1^{(k)} < \dots < \mathcal{J}_k^{(k)}$.*

(b) *If $U^{(k)} < \mathcal{I}^{(k-1)}$, define $\mathcal{I}^{(k)} := U^{(k)}$, $\mathcal{J}_1^{(k)} := \mathcal{I}^{(k-1)}$ and $\mathcal{J}_\ell^{(k)} := \mathcal{J}_{\ell-1}^{(k-1)}$ for $2 \leq \ell \leq k$.*

If $n > k$ continue with step $k+1$, otherwise stop.

The simulation algorithm first produces a vector $(U^{(0)}, \dots, U^{(n)})$ uniformly distributed on the set of *unordered* $(n+1)$ -tuples and then turns it into the vector $(\mathcal{I}^{(n)}, \mathcal{J}_1^{(n)}, \dots, \mathcal{J}_n^{(n)})$, which is uniformly distributed on the set of *ordered* $(n+1)$ -tuples. The latter therefore has the same distribution as the vector of random variables $(I^N, J_1^N, \dots, J_n^N)$, given

$Y^N = n$ (cf. (30)). The interesting point now is that we may interpret the algorithm as a procedure for the construction of the ancestral line. It successively adds selective arrows to realisations of the labelled Moran model, such that they coincide with additional selective defining events; obviously, $n + 1$ is the number of steps.

This genealogical interpretation is best explained with the help of the illustrations in Figs. 7 and 8. For each graphical representation the corresponding ancestors ($\mathcal{I}^{(0)}$, $\mathcal{I}^{(1)}$, $\mathcal{I}^{(k-1)}$, and $\mathcal{I}^{(k)}$, respectively) and, if present, the targets of the selective defining events ($\mathcal{J}_1^{(1)}$, $\mathcal{J}_1^{(k-1)}$, \dots , $\mathcal{J}_{k-1}^{(k-1)}$, and $\mathcal{J}_1^{(k)}$, \dots , $\mathcal{J}_k^{(k)}$, respectively) are indicated at the top. Bold lines represent the genealogy of the entire population at the bottom. In step 0 we randomly choose one of the N labels. This represents the label that becomes fixed, i.e. the ancestor, in a particle representation with no selective defining events (cf. Fig. 7, left). (Actually, this coincides with the neutral situation, $s_N = 0$.) In the following steps selective arrows are added one by one, where the point to note is that each of them may or may not move the ancestor ‘to the left’, depending on whether (a) or (b) applies. Lines that have been ancestors in previous steps of the algorithm are represented by dotted lines. For instance, let us consider step k , that is, a realisation with $k - 1$ selective defining events is augmented by a further one. In case (a) (cf. Figs. 7 and 8, middle) we add a selective defining event that does not change the label that becomes fixed (i.e. the ancestor remains the same), and that targets the newly chosen position $U^{(k)}$. In contrast, in case (b) (cf. Figs. 7 and 8, right) the additional selective defining event emanates from position $U^{(k)}$ and hits the ancestor of the previous step (which ceases to be ancestor). The result is a shifting of the ancestor ‘to the left’, i.e. to position $U^{(k)}$. That is, each selective defining event that goes back to case (b) gives rise to a new dotted line in Figs. 7 and 8. To avoid misunderstandings, we would like to emphasise that the details of the genealogies in the pictures are for the purpose of illustration only; the only thing we really construct is the sequence of tuples $(\mathcal{I}^{(n)}, \mathcal{J}_1^{(n)}, \dots, \mathcal{J}_n^{(n)})$.

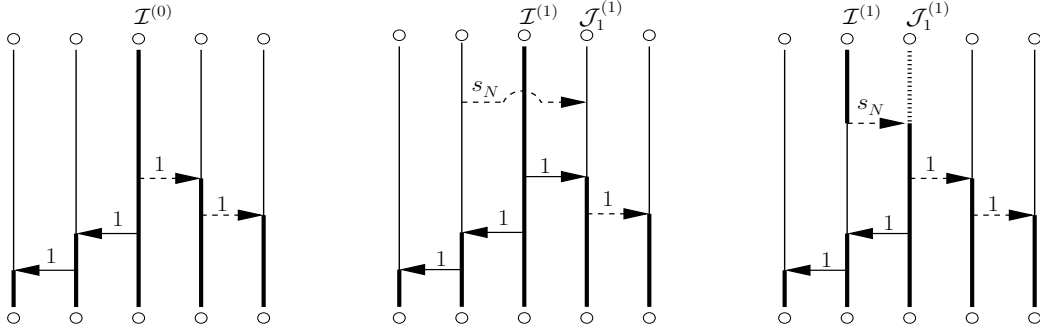

Figure 7: Steps 0 and 1 of Algorithm 1 and corresponding genealogical interpretations. Left: step 0 (no selective defining events), middle: step 1 (a), right: step 1 (b) (each with one selective defining event).

We now have everything at hand to provide a genealogical interpretation for the fixation probabilities h_i^N respectively $h(x)$ (cf. (3) respectively (7)). We have seen that

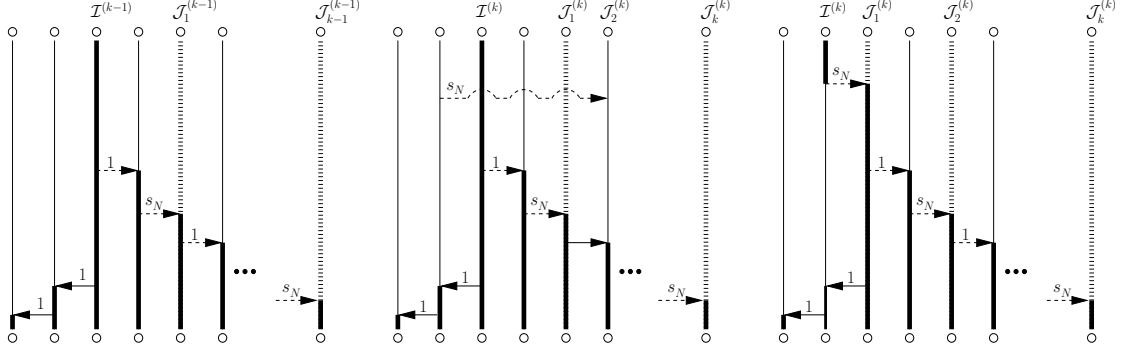

Figure 8: Step k of Algorithm 1 and corresponding genealogical interpretations. Situation after step $k-1$ (left) and its modification according to step k (a) (middle) and step k (b) (right).

the tuples $(\mathcal{I}^{(n)}, \mathcal{J}_1^{(n)}, \dots, \mathcal{J}_n^{(n)})$ are constructed such that

$$\mathbb{P}(\mathcal{I}^{(n)} = i, \mathcal{J}_1^{(n)} = j_1, \dots, \mathcal{J}_n^{(n)} = j_n) = \mathbb{P}(I^N = i, J_1^N = j_1, \dots, J_n^N = j_n \mid Y^N = n)$$

for all $n \geq 0$ and $j_1, \dots, j_n \in \{i+1, \dots, N\}$, and, via marginalisation,

$$\mathbb{P}(\mathcal{I}^{(n)} = i) = \mathbb{P}(I^N = i \mid Y^N = n).$$

We reformulate the decomposition of (22) to obtain

$$\begin{aligned} h_i^N &= \mathbb{P}(I^N \leq i \mid Y^N = 0) \mathbb{P}(Y^N \geq 0) \\ &+ \sum_{n=1}^{N-1} [\mathbb{P}(I^N \leq i \mid Y^N = n) - \mathbb{P}(I^N \leq i \mid Y^N = n-1)] \mathbb{P}(Y^N \geq n) \\ &= \mathbb{P}(\mathcal{I}^{(0)} \leq i) \mathbb{P}(Y^N \geq 0) + \sum_{n=1}^{N-1} [\mathbb{P}(\mathcal{I}^{(n)} \leq i) - \mathbb{P}(\mathcal{I}^{(n-1)} \leq i)] \mathbb{P}(Y^N \geq n) \\ &= \mathbb{P}(\mathcal{I}^{(0)} \leq i) \mathbb{P}(Y^N \geq 0) + \sum_{n=1}^{N-1} \mathbb{P}(\mathcal{I}^{(n)} \leq i, \mathcal{I}^{(n-1)} > i) \mathbb{P}(Y^N \geq n), \end{aligned} \quad (31)$$

where the last equality is due to the fact that the ancestor's label is non-increasing in n . In (31), the fixation probability h_i^N is thus decomposed according to the first step in the algorithm in which the ancestor has a label in $\{1, \dots, i\}$. The probability that this event takes place in step n may, in view of the simulation algorithm, be expressed explicitly as

$$\begin{aligned} \mathbb{P}(\mathcal{I}^{(n)} \leq i, \mathcal{I}^{(n-1)} > i) &= \mathbb{P}(\mathcal{I}^{(n)} \leq i, \mathcal{I}^{(0)}, \mathcal{I}^{(1)}, \dots, \mathcal{I}^{(n-1)} > i) \\ &= \mathbb{P}(U^{(n)} \leq i, U^{(0)}, U^{(1)}, \dots, U^{(n-1)} > i) \\ &= \frac{i}{N} \prod_{j=0}^{n-1} \frac{N-i-j}{N-1-j}. \end{aligned} \quad (32)$$

Together with (31) and (20) this provides us with a term-by-term interpretation of (3).

In particular, (32) implies that

$$\lim_{N \rightarrow \infty} \mathbb{P}(\mathcal{I}^{(n)} \leq i_N, \mathcal{I}^{(n-1)} > i_N) = x(1-x)^n$$

for a sequence $(i_N)_{N \in \mathbb{N}}$ with $i_N \in \{1, \dots, N\}$ and $\lim_{N \rightarrow \infty} i_N/N = x$, $x \in [0, 1]$. Thus, in the diffusion limit, and with $a_n = \lim_{N \rightarrow \infty} \mathbb{P}(Y^N \geq n)$ of (24), (31) turns into

$$h(x) = \lim_{N \rightarrow \infty} h_{i_N}^N = x + \sum_{n \geq 1} x(1-x)^n a_n,$$

which is the representation (7), and which is easily checked to coincide with (28) (as obtained by the direct approach of Sec. 5).

7 Discussion

We have reanalysed the process of fixation in a Moran model with two types and (fertility) selection by means of the labelled Moran model. It is interesting to compare the labelled Moran model with the corresponding lookdown construction: In the lookdown with fertility selection, *neutral* arrows only point in one direction (from lower to higher levels), whereas *selective* arrows may appear between arbitrary levels. In contrast, the labelled Moran model contains *neutral arrows in all directions*, but *selective arrows* only occur from lower to higher labels. Also, the labelled Moran model deliberately dispenses with exchangeability, which is an essential ingredient of the lookdown. It may be possible to transform the labelled Moran model into a lookdown (by way of random permutations), but this remains to be verified.

We certainly do not advertise the labelled Moran model as a general-purpose tool; in particular, due to its arbitrary neutral arrows, it does not allow the construction of a sequence of models with increasing N on the same probability space. However, it turned out to be particularly useful for the purpose considered in this paper; the reason seems to be that the fixation probabilities of its individuals, η_i^N , coincide with the individual terms in (2). Likewise, we obtained a term-by-term interpretation of the fixation probability (3) as a decomposition according to the number of selective defining events, which may successively shift the ancestral line to the left, thus placing more weight on the ‘more fit’ individuals.

Indeed, the incentive for this paper was the intriguing representation (7) of the fixation probabilities, which was first observed by Fearnhead (2002) in the context of (a pruned version of) the ASG, for the diffusion limit of the Moran model with mutation and selection at stationarity, and further investigated by Taylor (2007). Quite remarkably, (7) carries over to the case without mutation (which turns the stationary Markov chain into an absorbing one), with Fearnhead’s a_n reducing to ours (see Kluth et al. (2013) and Sec. 2). The observation that our W^∞ , that is, 1 plus the number of selective defining events in the diffusion limit, has the same distribution as the number of branches in the ASG (see Sec. 5) fits nicely into this context, but still requires some further investigation.

Needless to say, the next challenge will be to extend the results to the case with mutation – this does not seem to be straightforward but is quite possible, given the tools and insights that have become available lately.

Acknowledgments

It is our pleasure to thank Anton Wakolbinger, Ute Lenz, and Alison Etheridge for enlightening discussions. This project received financial support from Deutsche Forschungsgemeinschaft (Priority Programme SPP 1590 ‘Probabilistic Structures in Evolution’, grant no. BA 2469/5-1).

References

- [1] Bah, B., Pardoux, E., Sow, A. B., 2012. A look-down model with selection. In: *Stochastic Analysis and Related Topics: In Honour of Ali Süleyman Üstünel*, Paris, June 2010, (L. Decreasefond, J. Najim eds.), pp. 1-28. Springer, Berlin, Heidelberg.
- [2] Donnelly, P., Kurtz, T. G., 1996. A countable representation of the Fleming-Viot measure-valued diffusion. *Ann. Prob.* 24, 698-742.
- [3] Donnelly, P., Kurtz, T. G., 1999. Particle representations for measure-valued population models. *Ann. Prob.* 27, 166-205.
- [4] Donnelly, P., Kurtz, T. G., 1999. Genealogical processes for Fleming-Viot models with selection and recombination. *Ann. Appl. Prob.* 9, 1091-1148.
- [5] Durrett, R., 2008. *Probability Models for DNA Sequence Evolution*, 2. ed. Springer, New York.
- [6] Etheridge, A., 2011. *Some Mathematical Models from Population Genetics*. Springer, Heidelberg.
- [7] Ewens, W. J., 2004. *Mathematical Population Genetics. I. Theoretical Introduction*, 2. ed. Springer, New York.
- [8] Fearnhead, P., 2002. The common ancestor at a nonneutral locus. *J. Appl. Prob.* 39, 38-54.
- [9] Houchmandzadeh, B., Vallade, M., 2010. Alternative to the diffusion equation in population genetics. *Phys. Rev. E* 82, 051913.
- [10] Karlin, S., Taylor, H. M., 1981. *A Second Course in Stochastic Processes*. Academic Press, San Diego.

- [11] Kimura, M., 1962. On the probability of fixation of mutant genes in a population. *Genetics* 47, 713-719.
- [12] Kluth, S., Hustedt, T., Baake, E., 2013. The common ancestor process revisited. *Bull. Math. Biol.* 75, 2003-2027.
- [13] Krone, S. M., Neuhauser, C., 1997. Ancestral processes with selection. *Theor. Pop. Biol.* 51, 210-237.
- [14] Mano, S., 2009. Duality, ancestral and diffusion processes in models with selection. *Theor. Pop. Biol.* 75, 164-175.
- [15] Neuhauser, C., Krone, S. M., 1997. The genealogy of samples in models with selection. *Genetics* 145, 519-534.
- [16] Pokalyuk, C., Pfaffelhuber, P., 2013. The ancestral selection graph under strong directional selection. *Theor. Pop. Biol.* 87, 25-33.
- [17] Taylor, J. E., 2007. The common ancestor process for a Wright-Fisher diffusion. *Electron. J. Probab.* 12, 808-847.