

THE DOMINATION NUMBER OF GENERALIZED PETERSEN GRAPHS WITH A FAULTY VERTEX

Jun-Lin Guo¹, Kuo-Hua Wu¹, Yue-Li Wang^{*1}, and Ton Kloks^{**2}

¹ Department of Information Management
National Taiwan University of Science and Technology
No. 43, Sec. 4, Keelung Rd., Taipei, 106, Taiwan
ylwang@cs.ntust.edu.tw

² Department of Computer Science
National Tsing Hua University
No. 101, Sec. 2, Kuang Fu Rd., Hsinchu, Taiwan

Abstract. In this paper, we investigate the domination number of generalized Petersen graphs $P(n, 2)$ when there is a faulty vertex. Denote by $\gamma(P(n, 2))$ the domination number of $P(n, 2)$ and $\gamma(P_f(n, 2))$ the domination number of $P(n, 2)$ with a faulty vertex u_f . We show that $\gamma(P_f(n, 2)) = \gamma(P(n, 2)) - 1$ when $n = 5k + 1$ or $5k + 2$ and $\gamma(P_f(n, 2)) = \gamma(P(n, 2))$ for the other cases.

Keywords: Domination; Domination alternation; generalized Petersen Graph.

1 Introduction

A graph G is an ordered pair $(V(G), E(G))$ consisting of a set $V(G)$ of vertices and a set $E(G)$ of edges. When the context is clear, $V(G)$ and $E(G)$ are simply written as V and E , respectively. The *open neighborhood* of vertex $v \in V$ is the set $N(v) = \{u \in V \mid uv \in E\}$. The *closed neighborhood* of vertex $v \in V$ is the set $N[v] = N(v) \cup \{v\}$. For a set S of vertices, $N[S] = \bigcup_{v \in S} N[v]$. A set $S \subseteq V$ is a *dominating set* of G if $N[S] = V$ [3]. The *domination number* of G , denoted by $\gamma(G)$, is the cardinality of a minimum dominating set.

For two natural numbers n and k with $n \geq 3$ and $1 \leq k \leq \lfloor \frac{n-1}{2} \rfloor$, the *generalized Petersen graph* $P(n, k)$ is a graph on $2n$ vertices with $V(P(n, k)) = \{u_i, v_i \mid 1 \leq i \leq n\}$ and $E(P(n, k)) = \{u_i u_{i+1}, u_i v_i, v_i v_{i+k} \mid 1 \leq i \leq n\}$ with subscripts modulo n [4,5,10]. Hereafter, all operations on the subscripts of vertices are taken modulo n unless stated otherwise.

In [2], Behzad, Behzad, and Praeger showed that $\gamma(P(n, 2)) \leq \lceil \frac{3n}{5} \rceil$ for odd $n \geq 3$ and conjectured that $\lceil \frac{3n}{5} \rceil$ is exactly the domination number of $P(n, 2)$. In [6], Ebrahimi, Jahanbakht, and Mahmoodian (independently, Yan, Kang, and Xu [11] and Fu, Yang, and Jiang [8]) affirmed that $\gamma(P(n, 2)) = \lceil \frac{3n}{5} \rceil$ for $n \geq 3$.

* National Science Council of Taiwan Support Grant NSC 100-2221-E-011-067-MY3 and NSC 101-2221-E-011-038-MY3.

** National Science Council of Taiwan Support Grant NSC 99-2218-E-007-016.

In this paper, we are concerned with $\gamma(P_f(n, 2))$ when there is a faulty vertex u_f in $P(n, 2)$, where $\gamma(P_f(n, 2))$ denotes the domination number of $P(n, 2)$ with faulty vertex u_f , i.e., u_f is removed from $P(n, 2)$. Thus a faulty vertex cannot be chosen as a vertex in the dominating set. We shall show that, for $n \geq 3$,

$$\gamma(P_f(n, 2)) = \begin{cases} \gamma(P(n, 2)) - 1 & \text{if } n = 5k + 1 \text{ or } 5k + 2 \\ \gamma(P(n, 2)) & \text{otherwise.} \end{cases}$$

The *alteration domination number* of G , denoted by $\mu(G)$, is the minimum number of points whose removal increases or decreases the domination number of G [1]. The *bondage number* of G , denoted by $b(G)$, is the minimum number of edges whose removal from G results in a graph with larger domination number [7]. It can be regarded as the fault tolerance problem when removing vertices or edges from a graph. Fault tolerance is also an important issue on engineering [9]. This motivates us to study the the domination number of $P(n, 2)$ with a faulty vertex. By our result, we can find that the lower and upper bounds of $\mu(P(n, 2))$ are as follows: $\mu(P(n, 2)) = 1$ if $n = 5k + 1$ or $5k + 2$; otherwise, $\mu(P(n, 2)) \geq 2$. Moreover, we can find that $2 \leq b(P(n, 2)) \leq 3$ if $n = 5k, 5k + 3$ or $5k + 4$.

This paper is organized as follows. In Section 2 we review some preliminaries of dominating sets in generalized Petersen graphs. In Section 3 some properties are introduced when there is a faulty vertex in $P(n, 2)$. Section 4 contains our main results. We conclude in Section 5.

2 Preliminaries

In this paper, we follow the terminology of [6]. However, for clarity, we introduce some of them as follows.

Let $P(n, 2) - u$ denote the resulting graph after u is removed from $P(n, 2)$. In particular, $P(n, 2) - u_f$ is denoted by $P_f(n, 2)$ where u_f , for some $1 \leq f \leq n$, is the faulty vertex in $P(n, 2)$. We also use $S + u$ and $S - u$ to denote adding an element u to a set S and removing an element u from a set S , respectively. In the rest of this paper, S always stands for a domination set of $P_f(n, 2)$. A minimum dominating set of G is called a $\gamma(G)$ -set. When the graph G is clear from the context, $\gamma(G)$ -set is written as γ -set. A *block* of $P(n, 2)$ is an induced subgraph of 5 consecutive pairs of vertices (see Figure 1). Denote by \mathcal{B}_i if a block of $P(n, 2)$ is centered at u_i and v_i . When there is no possible ambiguity, \mathcal{B}_i and $V(\mathcal{B}_i)$ are used interchangeably. The vertices of $\mathcal{B}_i - u_i$ can be partitioned into $R_i = \{v_{i+1}, u_{i+2}, v_{i+2}\}$, $L_i = \{v_{i-1}, u_{i-2}, v_{i-2}\}$, and $M_i = \{u_{i-1}, v_i, u_{i+1}\}$. Let $N^+(R_i) = N[R_i] \setminus \mathcal{B}_i = \{v_{i+3}, u_{i+3}, v_{i+4}\}$, $N^+(L_i) = N[L_i] \setminus \mathcal{B}_i = \{v_{i-3}, u_{i-3}, v_{i-4}\}$, and $\gamma_i(S) = |\mathcal{B}_i \cap S|$. When the context is clear, $\gamma_i(S)$ is written as γ_i . Let $F = \{f - 2, f - 1, f, f + 1, f + 2\}$ which contains the indices in \mathcal{B}_f .

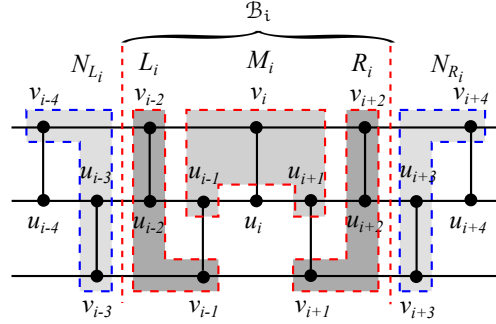

Fig. 1. A block \mathcal{B}_i .

Theorem 1 ([6,8,11]). For $n \geq 3$, $\gamma(P(n, 2)) = \lceil \frac{3n}{5} \rceil$.

Corollary 1. For $n \geq 3$, $\lceil \frac{3n}{5} \rceil - 1 \leq \gamma(P_f(n, 2)) \leq \lceil \frac{3n}{5} \rceil$.

Proof. Let S be a $\gamma(P(n, 2))$ -set. If $u_f \notin S$, then S is also a dominating set of $P_f(n, 2)$ and $\gamma(P_f(n, 2)) \leq \lceil \frac{3n}{5} \rceil$. For the case where $u_f \in S$, since $\gamma(P_f(n, 2)) \leq \lceil \frac{3n}{5} \rceil$, by symmetry, we can relabel the subscripts of the vertices in $P(n, 2)$ but not S such that $u_f \notin S$. Thus, in this case, $\gamma(P_f(n, 2)) \leq \lceil \frac{3n}{5} \rceil$.

To prove that $\lceil \frac{3n}{5} \rceil - 1 \leq \gamma(P_f(n, 2))$, suppose to the contrary that there exists a dominating set S of $P_f(n, 2)$ with $|S| = \lceil \frac{3n}{5} \rceil - 2$. It is clear that $S \cup \{u_f\}$ is also a dominating set of $P(n, 2)$ whose cardinality is $\lceil \frac{3n}{5} \rceil - 1$, a contradiction. This completes the proof. \square

Lemma 1. Let S be a minimum dominating set in $P_f(n, 2)$ and assume that the vertex u_f in the corresponding graph $P(n, 2)$ has at least one neighbor in S . Then $|S| = \lceil \frac{3n}{5} \rceil$.

Proof. Since $N(u_f) \cap S \neq \emptyset$, S is also a dominating set of $P(n, 2)$. This implies that $\gamma(P(n, 2)) \leq |S|$. By Theorem 1, there exists a $\gamma(P(n, 2))$ -set, say T , with $u_f \notin T$. Clearly, T is also a dominating set of $P_f(n, 2)$. Thus $|S| \leq \gamma(P(n, 2))$. This further implies that $|S| = \gamma(P(n, 2))$. By Theorem 1, the lemma follows. \square

3 Some properties when there is a faulty vertex

In this section, we introduce some properties of \mathcal{B}_f in $P(n, 2)$, where u_f is a faulty vertex. By Lemma 1, it remains to consider the case where $N(u_f) \cap S = \emptyset$. Thus, in the rest of this paper, we assume that S is a minimum dominating set under the condition that $N(u_f) \cap S = \emptyset$ unless stated otherwise. Thus, in this case, $M_f \cap S = \emptyset$ which implies $\mathcal{B}_f \cap S \subseteq L_f \cup R_f$. Hereafter, when we say that a vertex x is dominated with respect to S , then x is either in S or x is adjacent to some vertex in S .

Proposition 1. Assume that S is a dominating set of graph G and $S' = S - x + y$, where $x \in S$ and $y \notin S$. If all vertices in $N[x]$ are dominated by S' , then S' is also a dominating set of G with $|S| = |S'|$.

Lemma 2. If there exists $u_i \notin S$ and $u_f \notin M_i$ for some $1 \leq i \leq n$, then $\gamma_i \geq 3$.

Proof. Since $N[M_i] = \mathcal{B}_i$, the vertices in M_i can only be dominated by some vertices in \mathcal{B}_i . Note that any two vertices in M_i have no neighbor in common except u_i . However, $u_i \notin S$ and $u_f \notin M_i$. This results in $|N[M_i] \cap S| \geq 3$. Thus $\gamma_i \geq 3$ and the lemma follows. \square

Lemma 3. Assume that there exists a minimum dominating set S such that $N(u_f) \cap S = \emptyset$. Then there exists a minimum dominating set S such that $N(u_f) \cap S = \emptyset$ and $\gamma_i \geq 2$ for all $1 \leq i \leq n$.

Proof. If $\gamma_i > 1$ for $1 \leq i \leq n$ in S , then we are done. Thus we assume that there exists $\gamma_i = 1$ for some $i \neq f$. By Lemma 2, $u_i \in S$; otherwise, $\gamma_i \geq 2$. We may assume that none of u_{i+2} and u_{i+3} is u_f ; otherwise, reverse \mathcal{B}_i so that L_i and R_i are interchanged. This further implies that all vertices in R_i must be dominated by some vertices in $N^+(R_i)$. Since any two vertices in R_i have no common neighbor in $N^+(R_i)$, all vertices in $N^+(R_i)$ must be in S so that the vertices in R_i can be dominated. By Proposition 1, the set $S' = S - u_{i+3} + u_{i+2}$ is also a minimum dominating set under the condition that $N(u_f) \cap S = \emptyset$ since the vertices in $N[u_{i+3}]$ are still dominated by the vertices in S' . Note that $\gamma_j(S') = \gamma_j(S)$ for $1 \leq j \leq n$ except $j \in \{i, i+5\}$. It is easy to verify that $\gamma_i(S') = 2$ and $\gamma_{i+5}(S') \geq 2$. Moreover, S' has one less elements in $\{j | \gamma_j(S') = 1, 1 \leq j \leq n\}$ than that of S . By applying the above process repeatedly until the set $\{j | \gamma_j(S') = 1, 1 \leq j \leq n\}$ becomes empty, this results in a minimum dominating set with $\gamma_i \geq 2$ for all $1 \leq i \leq n$. This completes the proof. \square

Definition 1. A minimum dominating set S is called a Type I set if $\gamma_i \geq 2$ for $1 \leq i \leq n$. For a Type I set S , the cardinality of the set $\{i | \gamma_i(S) = 2, u_i \notin \mathcal{B}_f\}$ is called its couple number.

Proposition 2. Assume that S is a Type I set. If $\gamma_f = 3$ and $N(u_f) \cap S = \emptyset$, then either $|L_f \cap S| = 1$ or $|R_f \cap S| = 1$.

Proof. Since $\gamma_f = 3$ and $N(u_f) \cap S = \emptyset$, $\gamma_f = |L_f \cap S| + |R_f \cap S| = 3$. To show that either $|L_f \cap S| = 1$ or $|R_f \cap S| = 1$, it is equivalent to showing that $|L_f \cap S| = 0$ or $|R_f \cap S| = 0$ is impossible. Suppose to the contrary that $L_f \cap S = \emptyset$ (or $R_f \cap S = \emptyset$). It can be found that vertex u_{f-1} (or u_{f+1}) is not dominated, a contradiction. \square

By Proposition 2, in the rest of this paper, we only consider the case where $|L_f \cap S| = 1$ and $|R_f \cap S| = 2$ when S is a Type I set with $\gamma_f = 3$. For the case where $|L_f \cap S| = 2$ and $|R_f \cap S| = 1$, we can reverse the generalized Petersen graph so that it yields $|L_f \cap S| = 1$ and $|R_f \cap S| = 2$.

In total, there are nine possible cases for the vertices in $\mathcal{B}_f \cap S$ when $N(u_f) \cap S = \emptyset$, $\gamma_f = 3$, and $|L_f \cap S| = 1$. However, only four of them are feasible (see

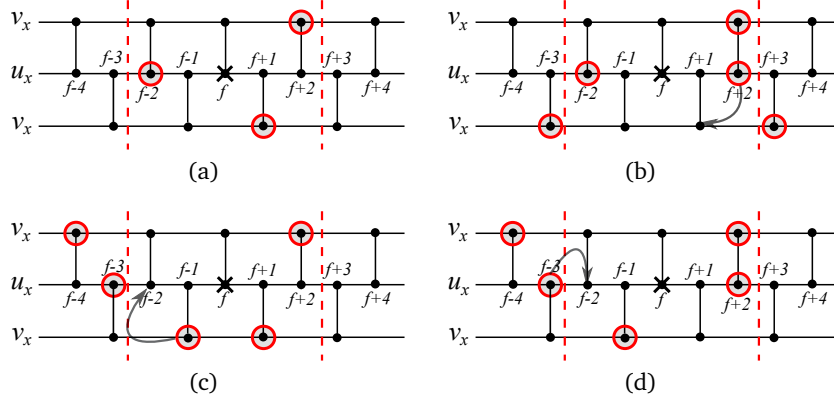

Fig. 2. All feasible $\mathcal{B}_f \cap S$ when $N(u_f) \cap S = \emptyset$, $\gamma_f = 3$, and $|L_f \cap S| = 1$.

Figures 2(a)-(d)). For example, if $|L_f \cap S| = 1$ and $v_{f-2} \in S$, then u_{f-1} is not dominated and it is an infeasible case.

For the case in Figure 2(b), by Proposition 1, $S_1 = S - u_{f+2} + v_{f+1}$ is still a Type I set. Note that the pattern of $S_1 \cap \mathcal{B}_f$ is exactly the case in Figure 2(a). For the case in Figure 2(c), by Proposition 1, $S_2 = S - v_{f-1} + u_{f-2}$ is also a Type I set. Furthermore, the pattern of $S_2 \cap \mathcal{B}_f$ is also exactly the case in Figure 2(a). For the case in Figure 2(d), by Proposition 1, $S_3 = S - u_{f-3} + u_{f-2}$ is also a Type I set while $\gamma_f = 4$. We shall define a Type III set later for this case. Henceforth, if S is a Type I set with $N(u_f) \cap S = \emptyset$ and $\gamma_f = 3$, then we may assume that it is a Type II set which is defined as follows.

Definition 2. A Type I set S with $\gamma_f = 3$ is called a Type II set if $\mathcal{B}_f \cap S = \{u_{f-2}, v_{f+1}, v_{f+2}\}$ (see Figure 2(a)).

Now we consider the case where $N(u_f) \cap S = \emptyset$ and $\gamma_f = 4$. By symmetry, we only need to consider the cases where $|L_f \cap S| = 1$ and $|L_f \cap S| = 2$. There are only seven feasible combinations (see Figures 3(a)-3(g)). Every minimum dominating set S in the cases of Figures 3(e)-3(g) can be transformed to a Type II set. That is, set $S_1 = S - u_{f+2} + u_{f+3}$ in Figure 3(e), set $S_2 = S - v_{f-2} + v_{f-4}$ in Figure 3(f), and set $S_3 = S - v_{f+1} + v_{f+3}$ in Figure 3(g). Note that $N[u_{f+2}]$, $N[v_{f-2}]$, and $N[v_{f+1}]$ are still dominated by the vertices in S_1 , S_2 , and S_3 , respectively. Thus, by Proposition 1, S_1 , S_2 , and S_3 are Type II sets.

Definition 3. A Type I set S with $\gamma_f = 4$ is called a Type III set if $\mathcal{B}_f \cap S$ is equal to one of the following four sets: $\{v_{f-1}, v_{f+1}, u_{f+2}, v_{f+2}\}$, $\{u_{f-2}, v_{f-2}, u_{f+2}, v_{f+2}\}$, $\{v_{f-2}, v_{f-1}, v_{f+1}, v_{f+2}\}$, and $\{u_{f-2}, v_{f-2}, v_{f+1}, u_{f+2}\}$, (see Figures 2(a)-2(d)), or precisely, are called Type III(a)-III(d) sets, respectively.

Henceforth, if S is a Type I set with $\gamma_f = 4$ and $N(u_f) \cap S = \emptyset$, then we may assume that it is a Type III set.

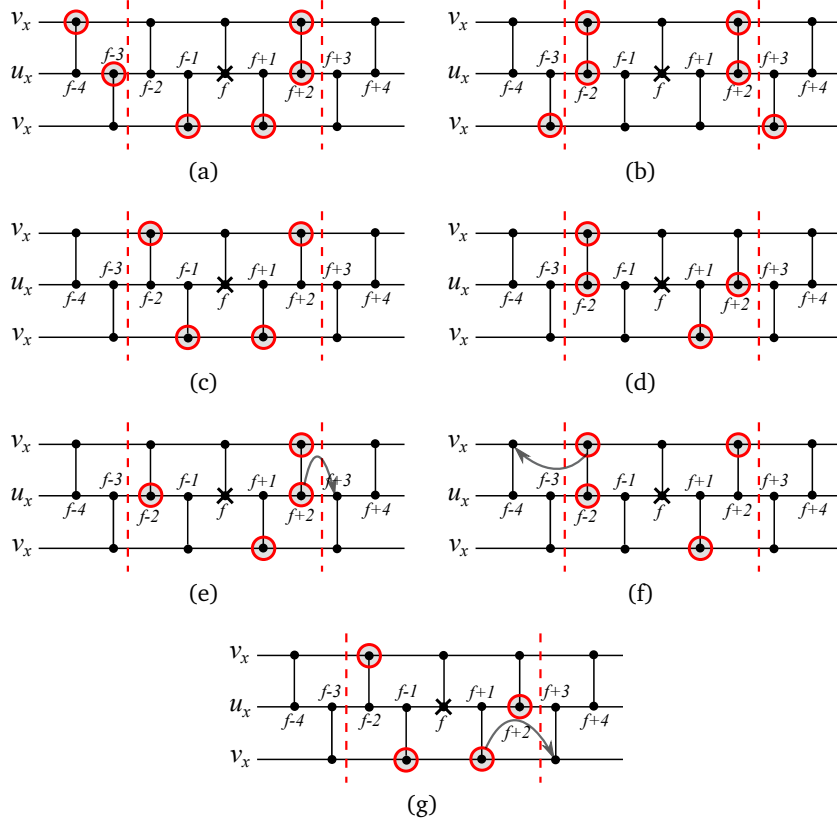

Fig. 3. All feasible $\mathcal{B}_f \cap S$ when $N(u_f) \cap S = \emptyset$ and $\gamma_f = 4$.

Lemma 4. Assume that S is a Type II (or III) set with couple number c . If there exists $\gamma_i = 2$ for $i \notin F$ and $S \cap \{v_{i-1}, v_i, v_{i+1}\} = \emptyset$, then there exists a Type II (or III) set with couple number $c - 1$.

Proof. Clearly, by Lemma 2, $u_i \in S$. Since $S \cap \{v_{i-1}, v_i, v_{i+1}\} = \emptyset$, the other vertex of \mathcal{B}_i in S , say y , must be in $\{u_{i-2}, v_{i-2}, u_{i-1}\} \cup \{u_{i+2}, v_{i+2}, u_{i+1}\}$. We only consider the case where $y \in \{u_{i-2}, v_{i-2}, u_{i-1}\}$ (see Figure 4). The other case is similar. Since $R_i \cap S = \emptyset$, by using a similar argument as in Lemma 3, $N^+(R_i) \subset S$. Clearly, at least one vertex in $\mathcal{B}_{i+5} \setminus N^+(R_i)$ must be in S so that u_{i+5} and u_{i+6} are dominated. This results in $\gamma_{i+5} \geq 4$ no matter whether $i + 5$ or $i + 6$ is equal to f or not. Now let $S' = S - u_{i+3} + u_{i+2}$. It is easy to check that $\gamma_j(S') = \gamma_j(S)$ for $1 \leq j \leq n$ except $j \in \{i, i + 5\}$. However, $\gamma_i(S') = 3$ and $\gamma_{i+5}(S') \geq 3$. Thus the couple number of S' is one less than that of S . This completes the proof. \square

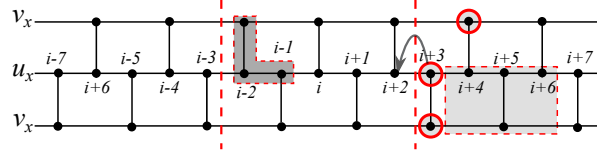

Fig. 4. An illustration for Lemma 4.

Remark 1. Note that if $i = f - 2$ (respectively, $i = f + 2$) in Lemma 4, then $u_f \in R_i$ (respectively, $u_f \in L_i$). This yields $u_{i+2} = u_f$ (respectively, $u_{i-2} = u_f$) which is removed under our assumption. Thus we cannot obtain a Type II (or III) set S' by setting $S' = S - u_{i+3} + u_{i+2}$ (respectively, $S' = S - u_{i-3} + u_{i-2}$). For the case where $i \in \{f - 1, f + 1\}$, u_i even might not be in S since u_f is either u_{i+1} or u_{i-1} which is removed.

Hereafter, we assume that S is with the smallest couple number if S is a Type II or III set.

Definition 4. Let S be a Type II (or III) set with the smallest couple number. A vertex u_i for $i \notin F$ is called a pseudo-couple vertex with respect to S if $S \cap \{v_{i-1}, v_i, v_{i+1}\} = \emptyset$.

Notice that if u_i is a pseudo-couple vertex, then $\gamma_i \geq 3$ when S is a Type II (or III) set with the smallest couple number.

Lemma 5. Assume that S is a Type II or III set with the smallest couple number. If there exists $\gamma_i = 2$ for $i \notin F$, then either $\gamma_{i+2} \geq 4$ or $\gamma_{i-2} \geq 4$.

Proof. Since $\gamma_i = 2$ and S is with the smallest couple number, by Lemma 4, u_i cannot be a pseudo-couple vertex and a vertex $x \in \{v_i, v_{i-1}, v_{i+1}\}$ must be in S . We consider the following three cases.

Case 1. $x = v_i$.

It is clear that v_{i+1} and u_{i+2} must be dominated by v_{i+3} and u_{i+3} , respectively. Similarly, v_{i-1} and u_{i-2} must be dominated by v_{i-3} and u_{i-3} , respectively (see Figure 5(a)). Thus both γ_{i+2} and γ_{i-2} are greater than or equal to 4.

Case 2. $x = v_{i+1}$.

In this case, u_{i+3} and v_{i+4} must be in S so that u_{i+2} and v_{i+2} are dominated. Thus $\gamma_{i+2} \geq 4$ (see Figure 5(b)).

Case 3. $x = v_{i-1}$.

By using a similar argument as in Case 2, the case holds. This completes the proof. \square

Lemma 6. Assume that S is a Type II or III set with the smallest couple number. If there exist $\gamma_i = \gamma_j = 2$ for distinct $i, j \notin F$, then $|i - j| \neq 4$.

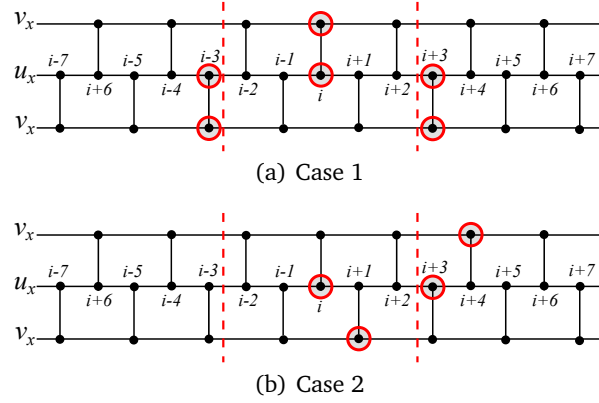

Fig. 5. Illustrations for Lemma 5.

Proof. Suppose to the contrary that $|i - j| = 4$. That is, j is either equal to $i + 4$ or $i - 4$. We only consider the case where $j = i + 4$. The other case is similar. By Lemma 4, u_i cannot be a pseudo-couple vertex and a vertex $x \in \{v_i, v_{i-1}, v_{i+1}\}$ must be in S . Analogous to Lemma 5, we consider the following three cases.

Case 1. $x = v_i$.

We can find that $u_{i+3}, v_{i+3} \in \mathcal{B}_{i+4} \cap S$ (see Figure 5(a)). If u_{i+4} is also in S , then $\gamma_j = \gamma_{i+4} \geq 3$, a contradiction. If u_{i+4} is not in S , then, by Lemma 2, $\gamma_j \geq 3$, a contradiction too.

Case 2. $x = v_{i+1}$.

In this case, $u_{i+3}, v_{i+4} \in \mathcal{B}_{i+4} \cap S$ (see Figure 5(b)). By using a similar argument as in Case 1, we can find that $\gamma_j \geq 3$. Thus this case is also impossible.

Case 3. $x = v_{i-1}$.

In this case, all vertices in $N^+(R_i)$ must be in S . This contradicts that $\gamma_j = 2$. This concludes the proof of this lemma. \square

4 Main results

By Lemma 2, $\gamma_f \geq 3$. In the following, we investigate the cardinalities of minimum dominating sets of $P_f(n, 2)$ under all possible values of γ_f .

By Lemma 5, if there exists $\gamma_i = 2$ for $i \notin F$, then either $\gamma_{i+2} \geq 4$ or $\gamma_{i-2} \geq 4$ must hold. This yields $(\gamma_i + \gamma_{i+2})/2 \geq 3$ or $(\gamma_i + \gamma_{i-2})/2 \geq 3$. By Lemma 6, if $\gamma_i = 2$, then both γ_{i-4} and γ_{i+4} are greater than or equal to 3. This means that no two distinct $\gamma_i = \gamma_j = 2$ use the same γ_k to obtain the average number 3. This ensures that the average number of γ_i is greater than or equal to 3 when $i \notin F$. To prove the lower bound of $|S|$, our main idea is to count the number of $\gamma_i = 2$ for $i \in F$, say x , which cannot gain support from any other γ_j so that their average is greater than or equal to 3. This yields $5|S| = \sum_{i=1}^n \gamma_i \geq 3n - x$.

Lemma 7. *If S is a Type III set with the smallest couple number, then $|S| \geq \lceil \frac{3n}{5} \rceil$.*

Proof. First we consider the case where S is a Type III(a), III(b), or III(c) set. By inspection (see Figure 3), it can be found that $\gamma_i \geq 3$ for $i \in F$ if S is a Type III(a) or III(b) set. For the case where S is a Type III(c) set, one of the elements in $\{v_{f-3}, u_{f-3}, u_{f-4}\}$ (respectively, $\{v_{f+3}, u_{f+3}, u_{f+4}\}$) must be in S so that u_{f-3} (respectively, u_{f+3}) is dominated. Thus $\gamma_i \geq 3$ for $i \in F$ if S is a Type III(c) set. This also implies that, in those three types of dominating sets, if there exists $\gamma_i = 2$ in S , then, by Lemmas 5 and 6, either $(\gamma_i + \gamma_{i+2})/2 \geq 3$ or $(\gamma_i + \gamma_{i-2})/2 \geq 3$ must hold. As a consequence, $\sum_{j=1}^n \gamma_j = 5|S| \geq 3n$. This yields $|S| \geq \lceil \frac{3n}{5} \rceil$.

To complete the proof, it remains to consider the case where S is a Type III(d) set. According to the possible values of γ_{f-2} , we consider the following two cases.

Case 1. $\gamma_{f-2} = 2$.

Since $\gamma_{f-2} = 2$, vertices u_{f-5} and v_{f-5} must be in S so that u_{f-4} and v_{f-3} are dominated (see Figure 6(a)). This further implies that both γ_{f-3} and γ_{f-4} are greater than or equal to 4. Note that if $\gamma_{f-5} = 2$, then u_{f-8} and v_{f-8} must be in S so that u_{f-7} and v_{f-6} are dominated. Accordingly, $\gamma_{f-7} \geq 4$. Thus γ_{f-5} can gain support from γ_{f-7} such that $(\gamma_{f-5} + \gamma_{f-7})/2 \geq 3$. We can find that the minimum values of $\gamma_{f-4}, \gamma_{f-3}, \dots, \gamma_{f+2}$ are 4, 4, 2, 3, 4, 2, and 2, respectively. Thus every $\gamma_i = 2$ in B_f can gain support from a vertex $\gamma_j = 4$. Thus $\sum_{i=1}^n \gamma_i = 5|S| \geq 3n$ which yields $|S| \geq \lceil \frac{3n}{5} \rceil$. Thus this case holds.

Case 2. $\gamma_{f-2} \geq 3$.

If $u_{f-3} \in S$ or $v_{f-3} \in S$, then, after setting $S' = S - u_{f-2} + v_{f-1}$ and $S'' = S' - v_{f+1} + v_{f+3}$, S'' becomes a Type II set which will be considered in Lemma 9. We may assume that $u_{f-3}, v_{f-3} \notin S$ and either u_{f-4} or v_{f-4} is in S (see Figure 6(b)). Note that, in this case, v_{f-5} must be in S so that v_{f-3} is dominated. Thus the minimum values of $\gamma_{f-4}, \gamma_{f-3}, \dots, \gamma_{f+2}$ are 4, 4, 3, 3, 4, 2, and 2, respectively. Clearly, their average is greater than or equal to 3. Note that one of the vertices in $N[u_{f-6}]$ must be in S so that u_{f-6} is dominated. Thus both γ_{f-5} and γ_{f-6} are greater than or equal to 3. This ensures that they will not gain support from γ_{f-4} and γ_{f-3} on computing the average value 3. Hence $\sum_{i=1}^n \gamma_i = 5|S| \geq 3n$ and $|S| \geq \lceil \frac{3n}{5} \rceil$. This completes the proof. \square

Corollary 2. *If S is a minimum dominating set with the smallest couple number under the condition that $N(u_f) \cap S = \emptyset$ and $\gamma_f \geq 4$, then $|S| \geq \lceil \frac{3n}{5} \rceil$.*

Proof. Since the case where S is a Type III set with the smallest couple number is a special case of $\gamma_f \geq 4$, by Lemma 7, this corollary follows. \square

It remains to investigate lower bounds for type II sets. By using a similar classification in [6], we consider the following five classes: $n = 5k, 5k + 1, 5k + 2, 5k + 3$, and $5k + 4$.

Lemma 8. *For $n = 5k$ or $5k + 3$, if S is a Type II set, then $|S| \geq \lceil \frac{3n}{5} \rceil$.*

Proof. Let S be a Type II set with the smallest couple number. By inspection on Figure 2(a), only the elements in $\{\gamma_{f-2}, \gamma_{f-1}, \gamma_{f+1}\}$ are possibly equal to 2 and

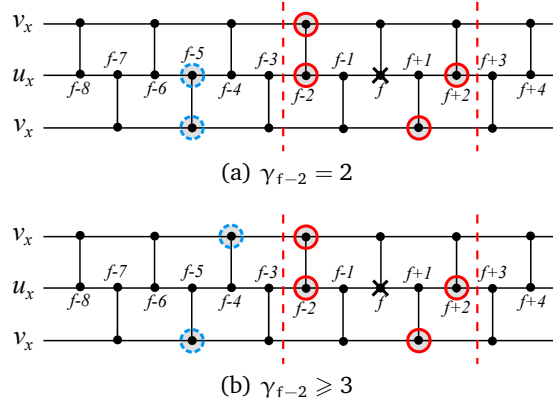

Fig. 6. Illustrations for Lemma 5.

all other $\gamma_i \geq 3$ after gaining support. Note that $\gamma_{f+2} \geq 3$ since $N[u_{f+3}] \cap S \neq \emptyset$. This yields $\sum_{i=1}^n \gamma_i = 5|S| \geq 3n - 3$. For $n = 5k$, $|S| \geq \lceil \frac{3n-3}{5} \rceil = \lceil \frac{15k-3}{5} \rceil = \lceil 3k - \frac{3}{5} \rceil = 3k = \lceil \frac{3n}{5} \rceil$, and $|S| \geq \lceil 3k + \frac{6}{5} \rceil = 3k + 2 = \lceil \frac{3n}{5} \rceil$ for $n = 5k + 3$. This completes the proof. \square

Definition 5. Let S be a dominating set of $P_f(n, 2)$. A block \mathcal{B}_i is called a self-contained block if $\mathcal{B}_i \cap S = \{u_{i-2}, v_i, v_{i+1}\}$ (see Figure 7(a)).

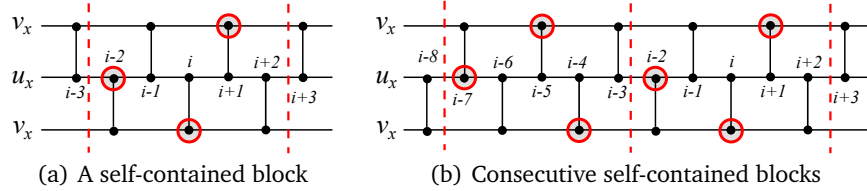

Fig. 7. Self-contained blocks.

Proposition 3. If both \mathcal{B}_i and \mathcal{B}_{i-5} are self-contained blocks, then $\gamma_x = 3$ for $i - 5 \leq x \leq i$.

Proof. By inspection (see Figure 7(b)), the proposition follows. \square

Lemma 9. For $n = 5k + 4$ and $\gamma_f = 3$, if S is a Type II set and any two of γ_{f-2} , γ_{f-1} and γ_{f+1} are greater than 2, then $|S| \geq \lceil \frac{3n}{5} \rceil$.

Proof. Analogous to Lemma 8, only the elements in $\{\gamma_{f-2}, \gamma_{f-1}, \gamma_{f+1}\}$ are possibly equal to 2 and all other $\gamma_j \geq 3$ after gaining support. If any two of $\gamma_{f-2}, \gamma_{f-1}$ and γ_{f+1} are greater than 2, then $\sum_{i=1}^n \gamma_i = 5|S| \geq 3n - 1$. By replacing n by $5k + 4$, this yields $|S| \geq \lceil 3k + \frac{11}{5} \rceil = 3k + 3$. Clearly, $\lceil \frac{3n}{5} \rceil = \lceil 3k + \frac{12}{5} \rceil = 3k + 3$ when $n = 5k + 4$. Thus $|S| \geq \lceil \frac{3n}{5} \rceil$. This completes the proof. \square

Lemma 10. For $n = 5k + 4$, if S is a Type II set, then $|S| \geq \lceil \frac{3n}{5} \rceil$.

Proof. Suppose to the contrary that $|S| < \lceil \frac{3n}{5} \rceil$. We claim that exactly one of the vertices in $\{v_{f-3}, u_{f-3}, v_{f-4}, u_{f-4}\}$ is in S . We argue the claim by contradiction and assume that there are two vertices in $\{v_{f-3}, u_{f-3}, v_{f-4}, u_{f-4}\} \cap S$. In this case, if one of v_{f-3} and u_{f-3} and one of v_{f-4} and u_{f-4} are in S , then $\gamma_{f-1} \geq 3$ and $\gamma_{f-2} \geq 3$. By Lemma 9, $|S| \geq \lceil \frac{3n}{5} \rceil$, a contradiction. If $\{v_{f-3}, u_{f-3}, v_{f-4}, u_{f-4}\} \cap S = \{v_{f-4}, u_{f-4}\}$, then $\{v_{f-5}, v_{f-3}\} \cap S \neq \emptyset$ so that v_{f-3} is dominated. This results in $\gamma_{f-3}, \gamma_{f-4} \geq 4$ and $\gamma_{f-5} \geq 3$. Thus γ_{f-1} can gain support from γ_{f-3} , by Lemma 9, $|S| \geq \lceil \frac{3n}{5} \rceil$, a contradiction. Thus the claim holds and $\gamma_{f-2} = 2$. Accordingly, we have the following four cases to consider.

Case 1. $v_{f-3} \in S$.

In this case, $u_{f-5}, v_{f-6} \in S$ so that u_{f-4} and v_{f-4} are dominated (see Figure 8(a)). This results in $\gamma_{f-1} \geq 3, \gamma_{f-4} \geq 4$ and $\gamma_{f-6} \geq 3$ since $N[v_{f-7}] \cap S \neq \emptyset$. The minimum values of γ_i for $i = f-6, f-5, \dots, f+2$ are 3, 3, 4, 3, 2, 3, 3, 2, and 3, respectively, and γ_{f-2} can gain support from γ_{f-4} . This leads to $\sum_{i=1}^n \gamma_i = 5|S| \geq 3n - 1$. By using a similar argument as in Lemma 9, $|S| \geq \lceil \frac{3n}{5} \rceil$, a contradiction. Thus this case is impossible.

Case 2. $u_{f-3} \in S$.

Since $\gamma_{f-2} = 2$ and $u_{f-3} \in S$, both $u_{f-4}, v_{f-4} \notin S$ (see Figure 8(b)). Furthermore, $v_{f-6} \in S$ so that v_{f-4} is dominated. We claim that either u_{f-5} or v_{f-5} is in S . If both u_{f-5} and v_{f-5} are not in S , then $\gamma_{f-3} = 2$. However, u_{f-3} is a pseudo-couple vertex and, by Lemma 4, S does not have the smallest couple number, a contradiction. Thus this claim holds and $\gamma_{f-3} \geq 3$. Note that $\gamma_{f-6} \geq 3$. The reason is that if $u_{f-6} \in S$, then $\gamma_{f-6} \geq 3$; otherwise, by Lemma 2, $\gamma_{f-6} \geq 3$. The minimum values of γ_i for $i = f-6, f-5, \dots, f+2$ are 3, 3, 4, 3, 2, 3, 3, 2, and 3, respectively. Thus γ_{f-2} can gain support from γ_{f-4} . Thus this case is also impossible.

Case 3. $v_{f-4} \in S$.

In this case, $v_{f-5} \in S$ so that v_{f-3} is dominated (see Figure 8(c)). We claim that $u_{f-5} \notin S$. Suppose to the contrary that $u_{f-5} \in S$. This yields $\gamma_{f-3}, \gamma_{f-4} \geq 4$ and $\gamma_{f-5}, \gamma_{f-6} \geq 3$. This results in the minimum values of γ_i for $i = f-6, f-5, \dots, f+2$ to be 3, 3, 4, 4, 2, 2, 3, 2, and 3, respectively, and γ_{f-2} and γ_{f-1} can gain support from γ_{f-4} and γ_{f-3} , respectively. Hence $|S| \geq \lceil \frac{3n-1}{5} \rceil = \lceil \frac{3n}{5} \rceil$, a contradiction. Thus the claim holds. When $u_{f-5} \notin S$, at least one vertex in $\{u_{f-6}, v_{f-6}, u_{f-7}, v_{f-7}\}$ must be in S so that u_{f-6} is dominated. If two vertices in $\{u_{f-6}, v_{f-6}, u_{f-7}, v_{f-7}\}$ are in S , this results in $\gamma_{f-5}, \gamma_{f-6} \geq 4$ and $\gamma_{f-3}, \gamma_{f-4}, \gamma_{f-7}, \gamma_{f-8} \geq 3$. This further implies that $|S| \geq \lceil \frac{3n-1}{5} \rceil = \lceil \frac{3n}{5} \rceil$, a contradiction. Thus at most one of u_{f-6}, v_{f-6} , and u_{f-7} can be in S . We claim that v_{f-6} cannot be in S either. If $v_{f-6} \in S$, then $u_{f-8} \in S$ to ensure that u_{f-7} is

dominated. Moreover, $\gamma_{f-8} \geq 3$ no matter whether u_{f-8} is a pseudo-couple vertex or not. This results in the minimum values of γ_i for $i = f-6, f-5, \dots, f+2$ to be 4, 3, 4, 3, 2, 2, 3, 2, and 3, respectively. Hence $|S| \geq \lceil \frac{3n-1}{5} \rceil = \lceil \frac{3n}{5} \rceil$, a contradiction. Thus the claim holds and only one of u_{f-6} and u_{f-7} can be in S . If u_{f-6} is in S , then, after replacing u_{f-6} by u_{f-7} , all vertices in $N[u_{f-6}]$ are also dominated. Thus we only consider the case where $u_{f-7} \in S$. Note that, in this case, $\mathcal{B}_{f-5} \cap S$ is exactly a self-contained block. By repeating the above procedure on \mathcal{B}_{f-5x} for $2 \leq x \leq k$, the only possible result is that all \mathcal{B}_{f-5x} are also self-contained blocks and $\{v_{5k+2}, v_{5k+3}\} \subset S$ (see Figure 8(d)). By Proposition 3, we have $\gamma_{f-x} = 3$ for $3 \leq x \leq 5k-2$. Finally, we can find that at least one vertex in $\{u_{5k+4}, v_{5k+4}, u_{5k+3}\}$ must be in S so that u_{5k+4} is dominated. This results in $\gamma_x = 4$ for $x = 5k+2, 5k+3, 5k+4$. Thus $\gamma_{f-2}, \gamma_{f-1}$ and γ_{f+1} can gain support from those vertices. This yields $\sum_{i=1}^n \gamma_i = 5|S| \geq 3n = \lceil \frac{3n}{5} \rceil$, a contradiction.

Case 4. $u_{f-4} \in S$.

In this case, v_{f-5} and v_{f-6} are in S so that v_{f-3} and v_{f-4} are dominated. Since $S' = S - u_{f-4} + v_{f-4}$ is still a Type II set with the smallest couple number which is already considered in Case 3. Therefore, this case is also impossible. This concludes the proof of the lemma. \square

Lemma 11. For $n = 5k+1$ and $n = 5k+2$, if S is a Type II set, then $|S| \leq \lceil \frac{3n}{5} \rceil - 1$.

Proof. By using a similar argument as in Case 3 of Lemma 10, we can construct a dominating set S' of $P(n, 2)$ when $n = 5k + 1$ (see Figure 9(a)). Note that all $\gamma_i(S') = 3$ for $1 \leq i \leq n$ except $\gamma_{f-2}(S') = \gamma_{f-1}(S') = \gamma_{f+1}(S') = 2$. Thus $\sum_{i=1}^n \gamma_i(S') = 5|S'| = 3n - 3 = 15k$ and $|S'| = 3k$. However, $\lceil \frac{3n}{5} \rceil = 3k + 1$. This yields $|S'| = \lceil \frac{3n}{5} \rceil - 1$ and $|S| \leq \lceil \frac{3n}{5} \rceil - 1$.

Similarly, when $n = 5k + 2$, let $S'' = S' \cup \{v_{5k+2}\}$ (see Figure 9(b)). It can be verified easily that S'' is a dominating set of $P(n, 2) - u_f$. Note that all $\gamma_i(S'') = 3$ for $1 \leq i \leq n$ except $\gamma_{f-2}(S'') = \gamma_{f-1}(S'') = 2$. Thus $5|S''| = 3n - 2 = 15k + 4$ and $|S''| = 3k + 1$. However, $\gamma(P(n, 2)) = \lceil \frac{3n}{5} \rceil = 3k + 2$. This yields $|S''| = \lceil \frac{3n}{5} \rceil - 1$ and $|S| \leq \lceil \frac{3n}{5} \rceil - 1$. This completes the proof. \square

We summarize our results as the following theorem.

Theorem 2. Assume that u_f is a faulty vertex in $P(n, 2)$. Then for $n \geq 3$

$$\gamma(P_f(n, 2)) = \begin{cases} \gamma(P(n, 2)) - 1 & \text{if } n = 5k + 1 \text{ or } 5k + 2 \\ \gamma(P(n, 2)) & \text{otherwise.} \end{cases}$$

Proof. By Corollaries 1 and 2 and Lemmas 7 and 8, $\gamma(P_f(n, 2)) = \gamma(P(n, 2))$ when $n = 5k$ and $5k + 3$. By Corollaries 1 and 2 and Lemmas 7 and 10, $\gamma(P_f(n, 2)) = \gamma(P(n, 2))$ when $5k + 4$. By Corollaries 1 and 2 and Lemmas 7 and 11, $\lceil \frac{3n}{5} \rceil - 1$ when $n = 5k + 1$ or $5k + 2$. This completes the proof. \square

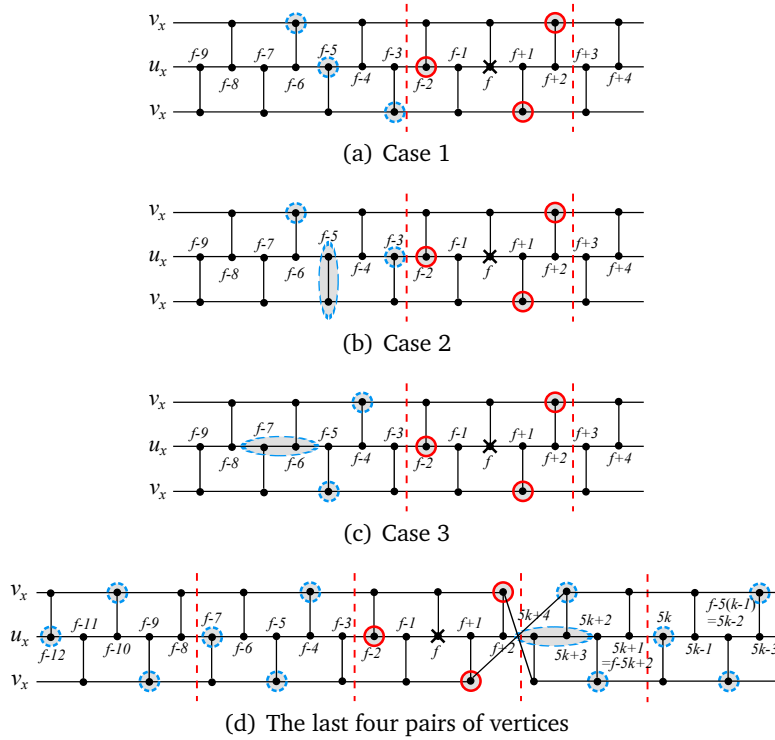

Fig. 8. Illustrations for Lemma 10.

5 Concluding remarks

In this paper, we show that $\gamma(P_f(n, 2)) = \gamma(P(n, 2)) - 1$ if $n = 5k + 1$ or $5k + 2$; otherwise, $\gamma(P_f(n, 2)) = \gamma(P(n, 2))$. Our results can be applied to the alteration domination number of $P(n, 2)$. By Theorem 2, we can find the lower and upper bounds for $\mu(P(n, 2))$ as follows: $\mu(P(n, 2)) = 1$ if $n = 5k + 1$ or $5k + 2$; otherwise, $\mu(P(n, 2)) \geq 2$. As a further study, it is interesting to find out the exact value of $\mu(P(n, 2))$. On the bondage problem in $P(n, 2)$, it is clear that the domination number is still $\lceil \frac{3n}{5} \rceil$ after removing any edge from $P(n, 2)$. By Theorem 2, we can find that $2 \leq b(P(n, 2)) \leq 3$ if $n = 5k, 5k + 3$ or $5k + 4$. It is also interesting to find out the exact value of $b(P(n, 2))$.

References

1. D. Bauer, F. Harary, J. Nieminen, C.L. Suffel, Domination alteration sets in graphs, *Discrete Mathematics* 47 (1983) 153–161.

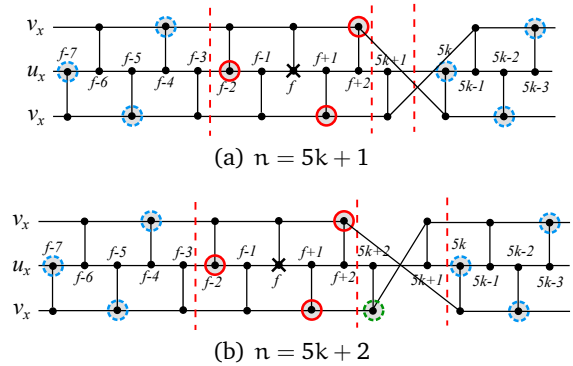

Fig. 9. The dominating sets in $P_f(n, 2)$ when $n = 5k + 1$ and $5k + 2$.

2. A. Behzad, M. Behzad, and C.E. Praeger, On the domination number of the generalized Petersen graphs, *Discrete Mathematics* 308 (2008) 603–610.
3. C. Berge, *The Theory of Graphs and Its Applications* Methuen & Co., John Wiley & Sons.
4. N.L. Biggs, *Algebraic Graph Theory*, 2nd ed. Cambridge, England: Cambridge University Press, 1993.
5. H.S.M. Coxeter, Self-dual configurations and regular graphs, *Bulletin of the American Mathematical Society* 56 (1950) 413–455.
6. B.J. Ebrahimi, N. Jahanbakht, and E.S. Mahmoodian, Vertex domination of generalized Petersen graphs, *Discrete Mathematics* 309 (2009) 4355–4361.
7. J.F. Fink, M.S. Jacobson, L.F. Kinch, and J. Roberts, The bondage number of a graph, *Discrete Mathematics* 86 (1990) 47–57.
8. X.L. Fu, Y.S. Yang, and B.Q. Jiang, On the domination number of generalized Petersen graphs $P(n, 2)$, *Discrete Mathematics* 309 (2009) 2445–2451.
9. R. Randell, P. Lee, and P.C. Treleaven, Reliability issues in computing system design, *ACM Computing Surveys (CSUR)* 10 (1978) 123–165.
10. M.E. Watkins, A theorem on Tait colorings with an application to the generalized Petersen graphs, *Journal of Combinatorial Theory* 6 (1969) 152–164.
11. H. Yan, L.Y. Kang, G.J. Xu, The exact domination number of the generalized Petersen graphs, *Discrete Mathematics* 309 (2009) 2596–2607.