

# Injective hulls of odd cycles

Ruedi Suter

*Department of Mathematics*

*ETH Zurich*

*Raemistrasse 101, 8092 Zurich, Switzerland*

e-mail: `suter@math.ethz.ch`

## Abstract

The injective hulls of odd cycles are described explicitly.

## 1 Introduction

Let  $\lambda = (\lambda_1, \lambda_2, \dots, \lambda_m)$  and  $\mu = (\mu_1, \mu_2, \dots, \mu_n)$  be integer partitions, that is, weakly decreasing finite sequences of positive integers. Their distance  $d(\lambda, \mu)$  is the distance that is induced from the Hasse diagram of Young's lattice when all edges have length one. In other words,  $d(\lambda, \mu)$  is the number of boxes in the Young diagrams of  $\lambda$  and  $\mu$  that belong to  $\lambda$  but not to  $\mu$  or vice versa. Hence

$$d(\lambda, \mu) = \sum_{l=1}^m \lambda_l + \sum_{l=1}^n \mu_l - 2 \sum_{l=1}^{\min\{m,n\}} \min\{\lambda_l, \mu_l\} = |\lambda| + |\mu| - 2|\lambda \cap \mu|$$

where absolute signs denote the size of a partition, and  $\lambda \cap \mu$  is the partition whose Young diagram is, with an evident meaning, the intersection of the Young diagrams of  $\lambda$  and  $\mu$ .

For  $N \geq 1$  let  $\mathbb{Y}_N$  be the set of those integer partitions that have maximal hook length ( $\lambda_1 + m - 1$  for  $\lambda \neq ()$  as above; the empty partition has maximal hook length zero) strictly smaller than  $N$ . The  $N$  rectangular partitions  $R_j = (j^{N-j})$  for  $j = 0, \dots, N-1$ , where  $(0^N)$  is synonymous with the empty partition  $()$ , belong to  $\mathbb{Y}_N$ . The  $N-1$  partitions  $R_1, \dots, R_{N-1}$  are the maximal elements in  $\mathbb{Y}_N$  (for  $N \geq 2$ ), and the empty partition  $R_0$  is of course the least element. The cardinality of  $\mathbb{Y}_N$  is  $2^{N-1}$ .

We consider the  $N$ -point metric space  $X_N = \{R_0, \dots, R_{N-1}\}$ . The distances are

$$d(R_i, R_j) = |j - i|(N - |j - i|). \quad (1.1)$$

It is convenient to have  $R_N = ()$  as an alternative notation for the empty partition  $R_0$ , so that the formula (1.1) for the distances between  $R_i$  and  $R_j$  holds for  $i, j \in \{0, \dots, N\}$ . The symmetric matrix  $(d(R_i, R_j))_{i,j=0,\dots,N-1}$  is circulant. In fact, much more is true. There is

a cyclic action of order  $N$  on  $\mathbb{Y}_N$  by isometries. The cyclic action  $\tau : \mathbb{Y}_N \rightarrow \mathbb{Y}_N$  is given by the formula

$$\lambda = (\lambda_1, \dots, \lambda_m) \xrightarrow{\tau} \tau(\lambda) = (N - m - 1, \lambda_1 - 1, \dots, \lambda_m - 1) |_{\text{remove trailing zeros}}$$

(for the empty partition put  $m = 0$ ,  $\lambda_1 = 1$ ). In particular, we get  $\tau(R_{j+1}) = R_j$  for  $j = 0, \dots, N - 1$ . It is straightforward to check that  $\tau$  preserves distances. For  $\lambda$  and  $\mu$  as above with  $n \leq m$  we compute

$$\begin{aligned} d(\tau(\lambda), \tau(\mu)) &= |\tau(\lambda)| + |\tau(\mu)| - 2|\tau(\lambda) \cap \tau(\mu)| \\ &= N - m - 1 + |\lambda| - m + N - n - 1 + |\mu| - n \\ &\quad - 2\left(N - m - 1 + \sum_{l=1}^n \min\{\lambda_l - 1, \mu_l - 1\}\right) \\ &= |\lambda| + |\mu| - 2 \sum_{l=1}^n \min\{\lambda_l, \mu_l\} = d(\lambda, \mu). \end{aligned}$$

The injective hull  $E(X_N)$  of the metric space  $X_N$  was described in [S3]. The 1-skeleton of  $E(X_N)$  can be identified with the Hasse graph of the subposet of Young's lattice that is induced from the vertex set  $\mathbb{Y}_N$ . In particular, this yielded a new geometric interpretation of the cyclic symmetries described above. The original combinatorial approach is in [S1], and another geometric description is mentioned in [S2].

$E(X_N)$  is an example of a most complicated injective hull of an  $N$ -point metric space in the sense that it realizes the maximal possible number of  $v$ -faces that such an injective hull can have. On the other hand, it is very special in that it exhibits an  $N$ -fold cyclic symmetry (more precisely, the symmetry group is a dihedral group of order  $2N$ , at least if  $N \geq 3$ ).

## 2 $N$ -cycle metric spaces

For  $N \geq 4$  the  $N$ -point metric space  $X_N = \{R_0, \dots, R_{N-1}\}$  is not a cycle because  $d(R_0, R_2) = 2(N - 2) < 2(N - 1) = d(R_0, R_1) + d(R_1, R_2)$ . But an  $N$ -cycle metric space can be realized as a subspace of  $\mathbb{Y}_N$ . For this let  $k = \lfloor \frac{N}{2} \rfloor$  and consider the orbit of the staircase partition  $\alpha_0 := (k - 1, \cdot, \cdot, 1) \in \mathbb{Y}_N$ , namely  $C_N := \{\tau^j(\alpha_0) \mid j = 0, \dots, N - 1\}$ .

For  $N = 2k$  even

$$\alpha_j := \tau^j(\alpha_0) = \begin{cases} (k - 1, \cdot, \cdot, 1) & \text{for } j = 0 \text{ (and } j = N) \\ (k, \cdot, \cdot, k - j + 1, k - j - 1, \cdot, \cdot, 1) & \text{for } j = 1, \dots, k - 2 \\ (k, \cdot, \cdot, 2) & \text{for } j = k - 1 \\ (k, \cdot, \cdot, 1) & \text{for } j = k \\ (k - 1, \cdot, \cdot, N - j, N - j, \cdot, \cdot, 1) & \text{for } j = k + 1, \dots, N - 1 \end{cases}$$

where the partition  $\alpha_j$  has  $k - 1$  parts for  $j = 0, \dots, k - 1$  and  $k$  parts for  $j = k, \dots, N - 1$ . Notice that  $d(\alpha_i, \alpha_j) = \min\{|j - i|, N - |j - i|\}$  (it suffices to verify that  $d(\alpha_0, \alpha_1) = 1$  and  $d(\alpha_0, \alpha_k) = k$ ).

For  $N = 2k + 1$  odd

$$\alpha_j := \tau^j(\alpha_0) = \begin{cases} (k-1, \dot{\lambda}, 1) & \text{for } j = 0 \text{ (and } j = N) \\ (k+1, \dot{\lambda}, k-j+2, k-j-1, \dot{\lambda}, 1) & \text{for } j = 1, \dots, k-2 \\ (k+1, \dot{\lambda}, 3) & \text{for } j = k-1 \\ (k+1, \dot{\lambda}, 2) & \text{for } j = k \\ (k, k, \dot{\lambda}, 1) & \text{for } j = k+1 \\ (k-1, \dot{\lambda}, N-j, N-j, N-j, \dot{\lambda}, 1) & \text{for } j = k+2, \dots, N-1 \end{cases}$$

where the partition  $\alpha_j$  has  $k-1$  parts for  $j = 0, \dots, k-1$  and  $\alpha_k$  has  $k$  parts and  $\alpha_j$  has  $k+1$  parts for  $j = k+1, \dots, N-1$ . Observe that  $d(\alpha_i, \alpha_j) = 2 \min\{|j-i|, N-|j-i|\}$  (it suffices to verify that  $d(\alpha_0, \alpha_1) = 2$  (if  $k > 0$ ) and  $d(\alpha_0, \alpha_k) = 2k$ ).

In other words, for  $N$  of either parity

$$d(\alpha_i, \alpha_j) = \min\{|j-i|, N-|j-i|\} \cdot d(\alpha_0, \alpha_1) \quad (2.1)$$

and the formula is also valid when  $i = N$  or  $j = N$  (with  $\alpha_N = \alpha_0$ ). This means that the metric space  $C_N$  is an  $N$ -cycle. Since  $C_N$  embeds isometrically into  $E(X_N)$ , the smallest injective subspace of  $E(X_N)$  that contains the image of  $C_N$  can be taken as a model for the injective hull of  $C_N$ .

For  $N$  even the injective hull of  $C_N$  can be seen as the central  $\frac{N}{2}$ -dimensional cube that was mentioned in the conclusions-and-outlook section in [S3]. The fact that the injective hull of a  $2k$ -cycle is just a  $k$ -cube is the content of Section 9 in [GM]. For  $N$  odd the situation is somewhat more involved.

### 3 Discrete Möbius strips and integer partitions

We need to recall some notations from [S3]. The discrete Möbius strip  $\mathfrak{X}_N$  has  $\frac{1}{2}N(N+1)$  sites  $(i, j)$  for  $0 \leq i \leq j \leq N$ , where  $(i, N) = (0, i) \in \mathfrak{X}_N$  for  $i = 0, \dots, N$ . The following picture (for  $N = 9$ ) illustrates the setup. We have  $O = (0, 0)$ ,  $O' = (0, N)$ ,  $O'' = (N, N)$  and  $O = O' = O''$  as sites in  $\mathfrak{X}_N$ ;  $P = (0, 2)$ ,  $P' = (2, N)$ ;  $Q = (0, 3)$ ,  $Q' = (3, N)$ ;  $R = (0, N-1)$ ,  $R' = (N-1, N)$ ; and  $P = P'$ ,  $Q = Q'$ ,  $R = R'$  as sites in the Möbius strip. For each partition  $\lambda \in \mathbb{Y}_N$  we get the corresponding outer rim  $\mathcal{L}_\lambda \subseteq \mathfrak{X}_N$ , which is a homotopically nontrivial loop consisting of  $N$  sites in the Möbius strip. In the picture we have  $\lambda = (5, 5, 2, 1) = (5^2 2 1)$ , whose Young diagram, displayed in the Russian convention, appears below the outer rim  $\mathcal{L}_\lambda$ .

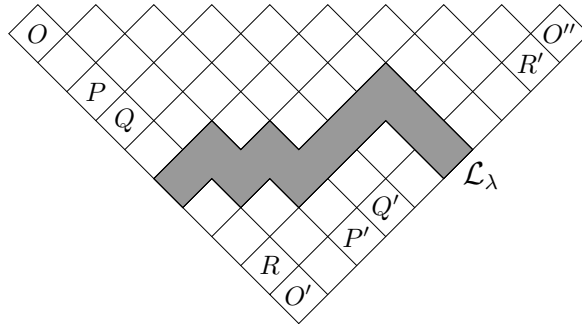

The empty partition has as its outer rim  $\mathcal{L}_0 = \{(0, 0), \dots, (0, N), \dots, (N, N)\}$ , where all its  $2N + 1$  positions in the triangular shape are listed, but  $\mathcal{L}_0$  has only  $N$  sites in the

Möbius strip. The mapping  $\lambda \mapsto \mathcal{L}_\lambda$  is a bijection between  $\mathbb{Y}_N$  and the set of homotopically nontrivial loops of length  $N$  in the Möbius strip  $\mathfrak{X}_N$ . The transported action  $\tau$  comes from translating the loops in the Möbius strip, for instance in the example above observe the outer rims of the partitions  $(6, 3, 2) \xrightarrow{\tau} (5, 5, 2, 1) \xrightarrow{\tau} (4, 4, 4, 1)$ .

For  $N = 2k + 1$  odd we consider the discrete Möbius strip  $\mathfrak{X}_N^\circ \subseteq \mathfrak{X}_N$  that is defined by

$$\mathfrak{X}_N^\circ := \{(i, j) \in \mathfrak{X}_N \mid d(\alpha_i, \alpha_j) \geq 2(k - 1)\}.$$

Its  $2N$  sites are

$$(0, k - 1), (1, k), \dots, (k + 1, N - 1), (0, k + 2), (1, k + 3), \dots, (k - 2, N - 1), \\ (0, k), (1, k + 1), \dots, (k, N - 1), (0, k + 1), (1, k + 2), \dots, (k - 1, N - 1).$$

**Example** For  $N = 9$  the sites in  $\mathfrak{X}_N$  that are crossed  $\times$  in the picture lie outside  $\mathfrak{X}_N^\circ$ . The positions in the triangular shape are

$$A = (0, k - 1) \quad B = (0, k) \quad C = (0, k + 1) \quad D = (0, k + 2) \\ A' = (k - 1, N) \quad B' = (k, N) \quad C' = (k + 1, N) \quad D' = (k + 2, N)$$

and  $A = A'$ ,  $B = B'$ ,  $C = C'$ , and  $D = D'$  as sites in  $\mathfrak{X}_N^\circ$ .

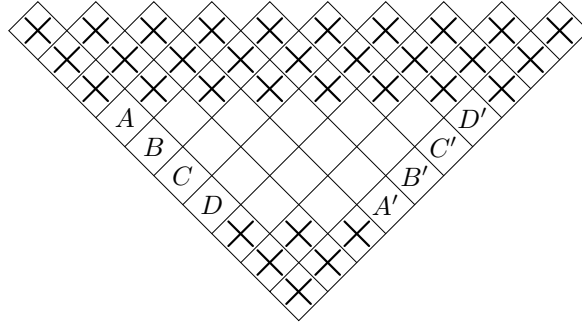

**Definition 3.1** Let

$$\mathbb{Y}_N^\circ := \{\lambda \in \mathbb{Y}_N \mid \mathcal{L}_\lambda \subseteq \mathfrak{X}_N^\circ\}$$

be the set of those partitions with maximal hook length  $< N$  whose outer rim is contained in  $\mathfrak{X}_N^\circ$ . Note that  $\alpha_0 \in \mathbb{Y}_N^\circ$ . The cyclic action  $\tau$  restricts to  $\tau : \mathbb{Y}_N^\circ \rightarrow \mathbb{Y}_N^\circ$ .

For  $(i, j) \in \mathfrak{X}_N^\circ$  we have according to (1.1) and (2.1)

$$d(R_i, R_j) = \begin{cases} k^2 + k & \text{if } d(\alpha_i, \alpha_j) = 2k, \\ k^2 + k - 2 & \text{if } d(\alpha_i, \alpha_j) = 2k - 2, \end{cases}$$

or in other words

$$d(R_i, R_j) = d(\alpha_i, \alpha_j) + k^2 - k \quad \text{for } (i, j) \in \mathfrak{X}_N^\circ. \quad (3.1)$$

## 4 Injective hulls

The injective hulls of the  $N$ -point metric spaces  $X_N$  and  $C_N$  can be realized as the polyhedral complexes  $E(X_N)$  and  $E(C_N)$  defined as follows:

$$\Delta(X_N) = \{f \in \mathbb{R}^{X_N} \mid \forall R_i, R_j \in X_N : f(R_i) + f(R_j) \geq d(R_i, R_j)\} \\ E(X_N) = \{f \in \Delta(X_N) \mid \forall R_i \in X_N \exists R_j \in X_N : f(R_i) + f(R_j) = d(R_i, R_j)\} \quad (4.1)$$

and

$$\begin{aligned}\Delta(C_N) &= \{g \in \mathbb{R}^{C_N} \mid \forall \alpha_i, \alpha_j \in C_N : g(\alpha_i) + g(\alpha_j) \geq d(\alpha_i, \alpha_j)\} \\ \mathbb{E}(C_N) &= \{g \in \Delta(C_N) \mid \forall \alpha_i \in C_N \exists \alpha_j \in C_N : g(\alpha_i) + g(\alpha_j) = d(\alpha_i, \alpha_j)\}.\end{aligned}\quad (4.2)$$

We use the bijection  $\iota : C_N \rightarrow X_N, \alpha_j \mapsto R_j$  to map  $\mathbb{R}^{X_N} \ni f \mapsto f \circ \iota \in \mathbb{R}^{C_N}$ .

The injective hull  $\mathbb{E}(X_N)$  was studied in [S3]. Its vertices are parametrized by the partitions in  $\mathbb{Y}_N$ :

$$\begin{aligned}\lambda \in \mathbb{Y}_N &\rightsquigarrow \mathcal{L}_\lambda \subseteq \mathfrak{X}_N && \text{its outer rim} \\ &\rightsquigarrow f_\lambda \in \mathbb{E}(X_N) && \text{the solution of } f(R_{i_l}) + f(R_{j_l}) = d(R_{i_l}, R_{j_l}) \text{ (} l = 0, \dots, N-1 \text{)} \\ &&& \text{where } \mathcal{L}_\lambda = \{(i_l, j_l) \mid l = 0, \dots, N-1\}, \\ &&& \text{explicitly: } f_\lambda(R_j) = |\tau^j(\lambda)|.\end{aligned}\quad (4.3)$$

If  $\lambda \in \mathbb{Y}_N$  has  $s$  inner corners and  $\lambda_\downarrow$  denotes the partition that is got from  $\lambda$  by removing all its inner corners, then the convex hull of the  $2^s$  vertices  $f_\nu$  where  $\nu \in [\lambda_\downarrow, \lambda]$  is a subset of  $\mathbb{E}(X_N)$ . Thus there are  $\binom{s}{v}$   $v$ -faces with ‘‘top vertex’’  $f_\lambda$ .

Let again  $N = 2k+1$ . The constant function  $o \in \mathbb{R}^{C_N}$  is defined as  $o(\alpha_j) = \frac{1}{2}(k^2 - k) = f_{\alpha_0}(R_0)$  ( $j = 0, \dots, N-1$ ). Using (3.1), we obtain for  $\lambda \in \mathbb{Y}_N^\circ$  by taking  $f_\lambda \in \mathbb{E}(X_N)$  and comparing (4.1) with (4.2)

$$g_\lambda := f_\lambda \circ \iota - o \in \mathbb{E}(C_N).\quad (4.4)$$

In the same way, for  $f \in \mathbb{E}(X_N)$  in a  $v$ -face with vertices  $f_\nu$  with all  $\nu \in \mathbb{Y}_N^\circ$ , we have  $g := f \circ \iota - o \in \mathbb{E}(C_N)$ .

Let  $\mathbb{E}(X_N)^\circ$  be the subcomplex of  $\mathbb{E}(X_N)$  induced from the vertex set  $f_\lambda$  for  $\lambda \in \mathbb{Y}_N^\circ$ . Then  $\mathbb{E}(X_N)^\circ$  can be identified via the translation  $f \mapsto f \circ \iota - o$  with a subset of  $\mathbb{E}(C_N)$ . It turns out that the image of  $\mathbb{E}(X_N)^\circ$  is actually the whole of  $\mathbb{E}(C_N)$ . To prove this, we use a 1-Lipschitz retraction  $\mathbb{E}(X_N) \rightarrow \mathbb{E}(X_N)^\circ$ .

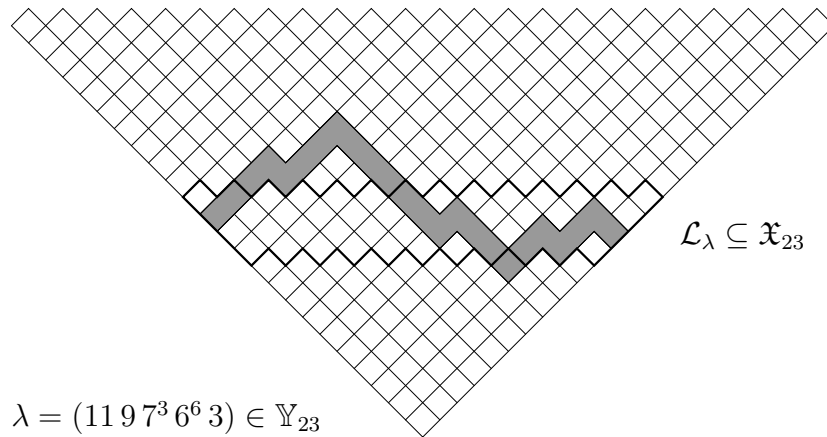

$$\lambda^\circ = (11\ 9\ 8\ 7^2\ 6^2\ 5\ 4\ 3\ 2\ 1) \in \mathbb{Y}_{23}^\circ$$

Let  $\lambda \in \mathbb{Y}_N$  with outer rim  $\mathcal{L}_\lambda$ . We obtain a well-defined outer rim  $\mathcal{L}_{\lambda^\circ} \subseteq \mathfrak{X}_N^\circ$  by starting with the loop  $\mathcal{L}_\lambda$  and successively folding sites where the loop turns and that are not in  $\mathfrak{X}_N^\circ$  closer towards  $\mathfrak{X}_N^\circ$ . The picture for the example above illustrates the result (after twelve foldings in the upper part and one folding in the lower part of the triangular shape).

Step by step the folding procedure works as follows (and by the way, in the proof of Proposition 4.1 below we make the order of steps even more detailed and fold two loops simultaneously). We assume that  $0 \leq i < j \leq N - 1$ . If  $(i + 1, j) \notin \mathfrak{X}_N^\circ$  belongs to the upper part (i. e.  $j - i - 1 \leq k - 2$ ), then the site  $(i, j + 1)$  is closer to  $\mathfrak{X}_N^\circ$  than  $(i + 1, j)$ . Similarly, if  $(i, j + 1) \notin \mathfrak{X}_N^\circ$  belongs to the lower part (i. e.  $j + 1 - i \geq k + 3$ ), then the site  $(i + 1, j)$  is closer to  $\mathfrak{X}_N^\circ$  than  $(i, j + 1)$ .

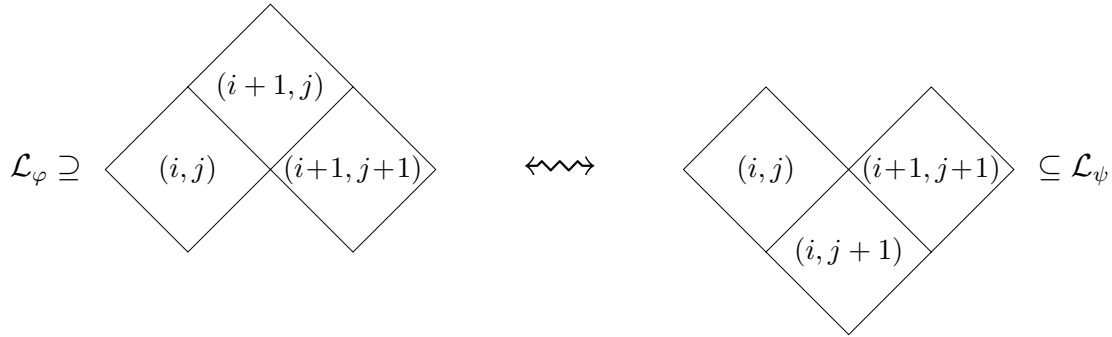

Note also that in order to be able to finally fold everything to  $\mathfrak{X}_N^\circ$ , we must keep in mind that  $(0, j) = (j, N)$  as sites in  $\mathfrak{X}_N$  (or alternatively we could use the universal covering of the Möbius strip, with the additional benefit that we could neglect the spurious distinction between the upper and lower parts; however, let us stick to the representation of the sites of  $\mathfrak{X}_N$  in the triangular shape with corners  $(0, 0)$ ,  $(0, N)$ , and  $(N, N)$ ). Clearly, this gives a well-defined idempotent mapping  $\mathbb{Y}_N \ni \lambda \mapsto \lambda^\circ \in \mathbb{Y}_N^\circ \subseteq \mathbb{Y}_N$ . Because the cyclic action is given by translation in the Möbius strip, it is evident that the idempotent mapping  $\lambda \mapsto \lambda^\circ$  commutes with the cyclic action:  $(\tau(\lambda))^\circ = \tau(\lambda^\circ)$ .

**Proposition 4.1** For  $\lambda, \mu \in \mathbb{Y}_N$  we have  $d(\lambda^\circ, \mu^\circ) \leq d(\lambda, \mu)$ .

*Proof.* We construct two sequences  $\lambda = \lambda^{(0)}, \dots, \lambda^{(l)} = \lambda^\circ$  and  $\mu = \mu^{(0)}, \dots, \mu^{(l)} = \mu^\circ$  that satisfy  $d(\lambda^{(j+1)}, \mu^{(j+1)}) \leq d(\lambda^{(j)}, \mu^{(j)})$  for  $j = 0, \dots, l - 1$ . To achieve this, we scan through  $\mathfrak{X}_N - \mathfrak{X}_N^\circ$  line by line from the periphery of  $\mathfrak{X}_N$  inwards, namely going through the site positions  $(1, 1), \dots, (N - 1, N - 1)$  in the upper part, then  $(0, N)$  in the lower part, next  $(1, 2), \dots, (N - 2, N - 1)$  in the upper part, then  $(0, N - 1), (1, N)$  in the lower part, and so on, finally  $(1, k - 1), \dots, (k + 2, N - 1)$  in the upper part and  $(0, k + 3), \dots, (k - 2, N)$  in the lower part of the triangular shape (again, as an alternative, one could look at the universal covering). Suppose our scanning stays at site position  $L$  and we are at step  $j$ . If  $L \in \mathcal{L}_{\lambda^{(j)}} \cup \mathcal{L}_{\mu^{(j)}}$ , then move to step  $j + 1$  as follows:

- if  $L \in \mathcal{L}_{\lambda^{(j)}}$  then put  $\mathcal{L}_{\lambda^{(j+1)}} := (\mathcal{L}_{\lambda^{(j)}} - \{L\}) \cup \{L'\}$  where  $L' = L \mp (1, -1)$  with “ $-$ ” for  $L$  in the upper part (so that  $\lambda^{(j+1)}$  is got from  $\lambda^{(j)}$  by removing the inner corner at  $L'$ ), and “ $+$ ” for  $L$  in the lower part (so that  $\lambda^{(j+1)}$  is got from  $\lambda^{(j)}$  by adding the outer corner at  $L$ ); otherwise (that is, if  $L \notin \mathcal{L}_{\lambda^{(j)}}$ ) let  $\lambda^{(j+1)} := \lambda^{(j)}$ ;

- if  $L \in \mathcal{L}_{\mu^{(j)}}$  then put  $\mathcal{L}_{\mu^{(j+1)}} := (\mathcal{L}_{\mu^{(j)}} - \{L\}) \cup \{L'\}$  where  $L' = L \mp (1, -1)$  with “ $-$ ” for  $L$  in the upper part (so that  $\mu^{(j+1)}$  is got from  $\mu^{(j)}$  by removing the inner corner at  $L'$ ), and “ $+$ ” for  $L$  in the lower part (so that  $\mu^{(j+1)}$  is got from  $\mu^{(j)}$  by adding the outer corner at  $L$ ); otherwise (that is, if  $L \notin \mathcal{L}_{\mu^{(j)}}$ ) let  $\mu^{(j+1)} := \mu^{(j)}$ .

If  $L'$  was an inner corner (respectively  $L$  was an outer corner) for both  $\lambda^{(j)}$  and  $\mu^{(j)}$ , then  $d(\lambda^{(j+1)}, \mu^{(j+1)}) = d(\lambda^{(j)}, \mu^{(j)})$ . Otherwise,  $d(\lambda^{(j+1)}, \mu^{(j+1)}) = d(\lambda^{(j)}, \mu^{(j)}) - 1$ .

If  $L \notin \mathcal{L}_{\lambda^{(j)}} \cup \mathcal{L}_{\mu^{(j)}}$ , scan the next site till there is no next site to scan, in which case the procedure ends with  $l = j$ .  $\square$

We get a 1-Lipschitz retraction  $r : E(X_N) \rightarrow E(X_N)^\circ$  that is defined on the vertices by  $r(f_\lambda) = f_{\lambda^\circ}$  and extended in the obvious way to convex combinations corresponding to higher-dimensional faces. Namely, such a  $v$ -face is the convex hull of the  $2^v$  vertices  $f_\nu$  for  $\nu \in [\lambda_V, \lambda]$  where  $\lambda \in \mathbb{Y}_N$ ,  $V$  with  $|V| = v$  is a subset of the set of inner corners of  $\lambda$ , and  $\lambda_V$  is the partition that is got from  $\lambda$  after removing the inner corners in  $V$ . Let  $V^\circ \subseteq V$  be the subset of those inner corners that are still inner corners of  $\lambda^\circ$  and whose removal from  $\lambda^\circ$  still gives a partition  $\lambda_{V^\circ}^\circ \in \mathbb{Y}_N^\circ$  ( $V^\circ = V \cap \{\circ\text{-inner corners of } \lambda^\circ\}$  in the sense of Definition 5.1). The image is the  $|V^\circ|$ -face which is the convex hull of the  $2^{|V^\circ|}$  vertices  $f_\nu$  for  $\nu \in [\lambda_{V^\circ}^\circ, \lambda^\circ]$ . Loosely speaking, the original  $v$ -cube in  $E(X_N)$  is collapsed along the  $(V - V^\circ)$ -directions, and the resulting  $|V^\circ|$ -cube is then moved to  $E(X_N)^\circ$ .

Let  $h : A \rightarrow E(X_N)^\circ$  be any 1-Lipschitz mapping from a subspace  $A$  of any metric space  $Y$ . Composing with the inclusion  $E(X_N)^\circ \hookrightarrow E(X_N)$  gives us a 1-Lipschitz mapping  $\text{incl} \circ h : A \rightarrow E(X_N)$ . It extends to a 1-Lipschitz mapping  $\overline{\text{incl} \circ h} : Y \rightarrow E(X_N)$  because  $E(X_N)$  is an injective metric space. Finally,  $r \circ \overline{\text{incl} \circ h} : Y \rightarrow E(X_N)^\circ$  extends  $h$  as a 1-Lipschitz mapping. In other words,  $E(X_N)^\circ$  is an injective metric space. Thus

$$E(C_N) = \{f \circ \iota - o \mid f \in E(X_N)^\circ\}.$$

One may wonder what one gets from the following process:

$$\begin{aligned} \lambda \in \mathbb{Y}_N &\rightsquigarrow \mathcal{L}_\lambda \subseteq \mathfrak{X}_N && \text{its outer rim} \\ &\rightsquigarrow g_\lambda \in \mathbb{R}^{C_N} && \text{the solution of } g(\alpha_{i_l}) + g(\alpha_{j_l}) = d(\alpha_{i_l}, \alpha_{j_l}) \text{ (} l = 0, \dots, N-1 \text{)} \\ &&& \text{where } \mathcal{L}_\lambda = \{(i_l, j_l) \mid l = 0, \dots, N-1\}. \end{aligned}$$

Recall that the linear system is regular, as was already implicitly used in (4.3). If  $\lambda \in \mathbb{Y}_N^\circ$ , the functions  $g_\lambda \in E(C_N)$  were described in (4.4).

Suppose the outer rims  $\mathcal{L}_\varphi$  and  $\mathcal{L}_\psi$  are as before, with  $\mathcal{L}_\varphi \ni (i+1, j) \notin \mathfrak{X}_N^\circ$  and  $j - i - 1 \leq k - 2$ . Then

$$\begin{aligned} d(\alpha_i, \alpha_j) &= d(\alpha_{i+1}, \alpha_{j+1}) = d(\alpha_{i+1}, \alpha_j) + 2 \\ d(\alpha_i, \alpha_{j+1}) &= d(\alpha_{i+1}, \alpha_j) + 4 \end{aligned}$$

so that

$$d(\alpha_i, \alpha_j) + d(\alpha_{i+1}, \alpha_{j+1}) = d(\alpha_{i+1}, \alpha_j) + d(\alpha_i, \alpha_{j+1})$$

and it follows that under the condition that

$$\begin{aligned} g(\alpha_i) + g(\alpha_j) &= d(\alpha_i, \alpha_j) \\ g(\alpha_{i+1}) + g(\alpha_{j+1}) &= d(\alpha_{i+1}, \alpha_{j+1}) \end{aligned}$$

the two equations

$$\begin{aligned} g(\alpha_{i+1}) + g(\alpha_j) &= d(\alpha_{i+1}, \alpha_j) \\ g(\alpha_i) + g(\alpha_{j+1}) &= d(\alpha_i, \alpha_{j+1}) \end{aligned}$$

are equivalent. Hence  $g_\varphi = g_\psi$ . Analogously for  $(i, j+1) \notin \mathfrak{X}_N^\circ$  with  $j+1-i \geq k+3$  it follows that  $g_\psi = g_\varphi$ . Hence for  $\lambda \in \mathbb{Y}_N$  we get  $g_\lambda = g_{\lambda^\circ} \in \mathbf{E}(C_N)$ .

As a summary, we have the following theorem.

**Theorem 4.2** *Let  $N = 2k + 1$  be an odd positive integer. The injective hull  $\mathbf{E}(C_N)$  of an  $N$ -cycle  $C_N = \{\alpha_0, \dots, \alpha_{N-1}\}$  with metric  $d(\alpha_i, \alpha_j) = 2 \min\{|j-i|, N-|j-i|\}$  has the following realization: The vertices of  $\mathbf{E}(C_N)$  are parametrized by the partitions in  $\mathbb{Y}_N^\circ$ :*

$$\begin{aligned} \lambda \in \mathbb{Y}_N^\circ &\rightsquigarrow \mathcal{L}_\lambda \subseteq \mathfrak{X}_N^\circ \quad \text{its outer rim } \mathcal{L}_\lambda = \{(i_l, j_l) \mid l = 0, \dots, N-1\} \\ &\rightsquigarrow g_\lambda \in \mathbb{R}^{C_N} \quad \text{the solution of } g(\alpha_{i_l}) + g(\alpha_{j_l}) = d(\alpha_{i_l}, \alpha_{j_l}) \text{ for } l = 0, \dots, N-1, \\ &\quad \text{explicitly: } g_\lambda(\alpha_j) = |\tau^j(\lambda)| - \frac{1}{2}k(k-1). \end{aligned}$$

The  $v$ -faces of  $\mathbf{E}(C_N)$  are the convex hulls of the  $2^v$  vertices  $g_\nu$  where  $\nu \in [\lambda', \lambda]$  with  $\lambda, \lambda' \in \mathbb{Y}_N^\circ$  and  $\lambda'$  is got by removing  $v$  inner corners from  $\lambda$ .

**Remark 4.3** From the explicit description of  $\mathbf{E}(C_N)$  in the theorem above we get

$$\lambda \in \mathbb{Y}_N^\circ \implies |\tau^j(\lambda)| \geq \frac{1}{2}k(k-1) \quad \text{for } j = 0, \dots, N-1; \text{ and recall } N = 2k+1.$$

But these inequalities do not characterize the partitions in  $\mathbb{Y}_N^\circ$  among those in  $\mathbb{Y}_N$ , e. g.

for $N = 7$ with $\lambda = (3) \notin \mathbb{Y}_7^\circ$	for $N = 9$ with $\lambda = (4, 3) \notin \mathbb{Y}_9^\circ$
$\begin{array}{c cccccc} j & 0 & 1 & 2 & 3 & 4 & 5 & 6 \\ \hline  \tau^j(3)  - 3 & 0 & 4 & 6 & 6 & 6 & 4 & 0 \end{array}$	$\begin{array}{c cccccccc} j & 0 & 1 & 2 & 3 & 4 & 5 & 6 & 7 & 8 \\ \hline  \tau^j(4, 3)  - 6 & 1 & 5 & 7 & 7 & 7 & 7 & 5 & 1 & 1 \end{array}$

Here is another thought: For  $\lambda \in \mathbb{Y}_N$  let

$$\|\lambda\|_1 := \sum_{j=0}^{N-1} |\tau^j(\lambda)|.$$

The fixed point  $(k, \dots, 1)$  attains the minimum  $\min\{\|\lambda\|_1 \mid \lambda \in \mathbb{Y}_N\} = \frac{1}{8}(N^3 - N)$ , and the least element  $\alpha_0 = (k-1, \dots, 1) \in \mathbb{Y}_N^\circ$  has  $\|\alpha_0\|_1 = \frac{1}{8}(N^3 + 3N - 4)$ . But  $\|\lambda\|_1 \leq \|\alpha_0\|_1$  does not characterize the partitions in  $\mathbb{Y}_N^\circ$ , e. g.

$$\begin{aligned} \text{for } N = 11: & \|(5, 4, 3)\|_1 = 170 = \|\alpha_0\|_1, \text{ but } (5, 4, 3) \notin \mathbb{Y}_{11}^\circ, \\ \text{for } N = 13: & \|(6, 5, 4, 3)\|_1 = 278 < 279 = \|\alpha_0\|_1, \text{ but } (6, 5, 4, 3) \notin \mathbb{Y}_{13}^\circ. \end{aligned}$$

## 5 Census of faces in $\mathbf{E}(C_N)$

We have to count the homotopically nontrivial loops of length  $N$  in the Möbius strip  $\mathfrak{X}_N^\circ$ . Moreover, for each such loop  $\mathcal{L}_\lambda$  we need to keep records on the number of  $\circ$ -inner corners of  $\lambda$ , defined as follows.



**Definition 5.1** An inner corner of  $\lambda \in \mathbb{Y}_N^\circ$  is called  $\circ$ -inner if its removal from the Young diagram of  $\lambda$  results in the Young diagram of a partition in  $\mathbb{Y}_N^\circ$ .

Rather than trying to extract results from the literature on lattice paths, we give a self-contained approach by doing an induction on  $k$  in  $N = 2k + 1$ , beginning with the base case  $k = 1$ . We construct a  $3 \times 3$  matrix  $Z_k$  whose entries count certain admissible paths in a strip according to their number of  $\circ$ -inner corners (in an evident sense). A summand  $t^s$  stands for a path with  $s$   $\circ$ -inner corners. The first row stands for the paths passing via  $(k - 1, N - 1)$  and  $(k - 1, N)$ , the second row for those passing via  $(k, N - 1)$  and  $(k, N)$ , and the third row for those passing via  $(k + 1, N - 1)$  and  $(k + 1, N)$ . These three cases exhaust all possibilities and are mutually disjoint. Similarly, the first column stands for the paths passing via  $(0, k)$  and  $(1, k)$ , the second column for those passing via  $(0, k + 1)$  and  $(1, k + 1)$ , and the third column for those passing via  $(0, k + 2)$  and  $(1, k + 2)$ . The matrix for the base case is  $Z_1 = Z$ .

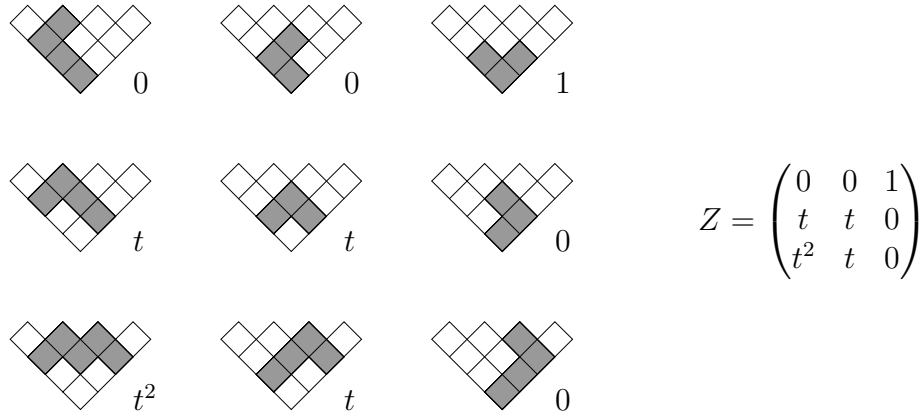

The matrix  $S$  incorporates the induction from  $k$  to  $k + 1$ . The first row stands for the paths passing via  $(k, N)$  and  $(k, N + 1)$ , the second row for those passing via  $(k + 1, N)$  and  $(k + 1, N + 1)$ , and the third row for those passing via  $(k + 2, N)$  and  $(k + 2, N + 1)$ . Similarly, the first column stands for the paths passing via  $(k - 1, N - 1)$  and  $(k - 1, N)$ , the second column for those passing via  $(k, N - 1)$  and  $(k, N)$ , and the third column for those passing via  $(k + 1, N - 1)$  and  $(k + 1, N)$ . (Note that to get the site positions in  $\mathfrak{X}_{N+2}^\circ \subseteq \mathfrak{X}_{N+2}$ , we have to shift by  $(0, 1)$ .)

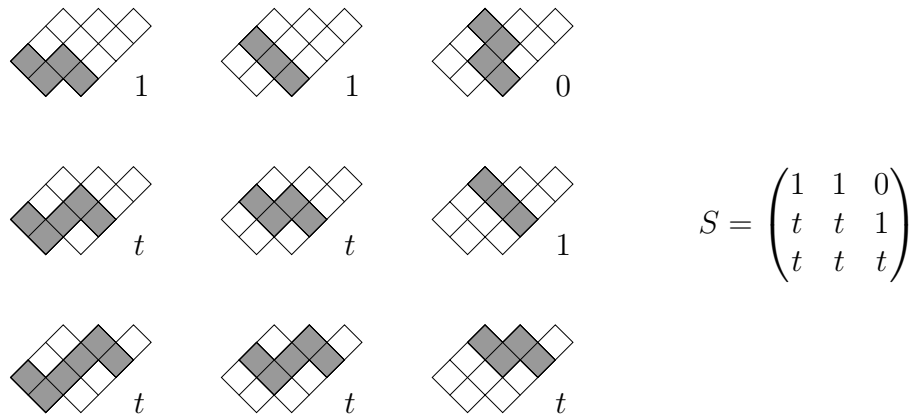

So  $Z_k = S^{k-1}Z$ . Only the paths that pass via  $(0, k)$  and  $(1, k)$  and  $(k + 1, N - 1)$  (and  $(k + 1, N)$ ) cannot be completed to an admissible loop in the Möbius strip  $\mathfrak{X}_N^\circ$ . The

enumerator for all admissible loops is therefore the sum of all matrix entries of  $Z_k$  except the entry in the third row and first column. In other words, with

$$A = \begin{pmatrix} 1 & 1 & 0 \\ 1 & 1 & 1 \\ 1 & 1 & 1 \end{pmatrix}$$

we obtain

$$\sum_{\lambda \in \mathbb{Y}_N^{\circ}} t^{\#(\text{o-inner corners of } \lambda)} = \text{tr}(AZ_k) = \text{tr}(AS^{k-1}Z) = \text{tr}(S^{k-1}ZA). \quad (5.1)$$

**Lemma 5.2** *For  $n \geq 1$  the matrix powers of  $S$  are*

$$S^n = a_n S + b_n (S^2 - (1+t)S)$$

where

$$a_n = \sum_{j=0}^{n-1} \binom{2(n-1)-j}{j} t^j \quad \text{and} \quad b_n = \sum_{j=0}^{n-2} \binom{2(n-1)-j-1}{j} t^j.$$

*Proof.* We do an induction on  $n$ . The formula is true for  $n = 1$ . For  $n \geq 1$  we compute using  $S^3 = (1+2t)S^2 - t^2S$

$$\begin{aligned} S^{n+1} &= S(a_n S + b_n (S^2 - (1+t)S)) = a_n S^2 + b_n ((1+2t)S^2 - t^2S - (1+t)S^2) \\ &= ((1+t)a_n + tb_n)S + (a_n + tb_n)(S^2 - (1+t)S) \end{aligned}$$

and hence we must show that

$$a_{n+1} = (1+t)a_n + tb_n \quad \text{and} \quad b_{n+1} = a_n + tb_n. \quad (5.2)$$

The constant coefficients of the four expressions in (5.2) are 1, and for the coefficient of  $t^{j+1}$  we have

$$\begin{aligned} [t^{j+1}](a_n + tb_n) &= \binom{2(n-1)-(j+1)}{j+1} + \binom{2(n-1)-j-1}{j} \\ &= \binom{2n-(j+1)-1}{j+1} = [t^{j+1}]b_{n+1} \end{aligned} \quad (5.3)$$

and using (5.3) we continue

$$\begin{aligned} [t^{j+1}]((1+t)a_n + tb_n) &= [t^{j+1}](b_{n+1} + ta_n) \\ &= \binom{2n-(j+1)-1}{j+1} + \binom{2(n-1)-j}{j} \\ &= \binom{2n-(j+1)}{j+1} = [t^{j+1}]a_{n+1} \end{aligned}$$

and hence (5.2) is verified.  $\square$

We continue with the computation in (5.1) using  $ZA = S^2 - tS$  and Lemma 5.2.

$$\begin{aligned}
\sum_{\lambda \in \mathbb{Y}_N^0} t^{\#(\text{o-inner corners of } \lambda)} &= \text{tr}(S^{k-1}ZA) = \text{tr}(S^{k+1} - tS^k) \\
&= \text{tr}(a_{k+1}S + b_{k+1}(S^2 - (1+t)S) - ta_kS - tb_k(S^2 - (1+t)S)) \\
&= (a_{k+1} - ta_k) \text{tr}(S) + (b_{k+1} - tb_k) \text{tr}(S^2 - (1+t)S) \\
&= (a_{k+1} - ta_k)(1 + 2t) + (b_{k+1} - tb_k)t \\
&= (1+t)(a_{k+1} - ta_k) + t(b_{k+1} - tb_k) + t(a_{k+1} - ta_k)
\end{aligned} \tag{5.4}$$

and according to (5.2) this can be written as

$$= a_{k+2} - t^2 a_k =: U.$$

The coefficients of  $t^s$  are  $[t^0]U = 1$ ,  $[t^1]U = 2k + 1$  and for  $s \geq 2$

$$\begin{aligned}
[t^s]U &= \binom{2(k+1) - s}{s} - \binom{2(k-1) - (s-2)}{s-2} \stackrel{(*)}{=} \binom{2k-s}{s-1} + \binom{2k+1-s}{s} \\
&= \left( \frac{s}{2k+1-s} + 1 \right) \binom{2k+1-s}{s} = \frac{2k+1}{2k+1-s} \binom{2k+1-s}{s}
\end{aligned} \tag{5.5}$$

where (\*) is quickly seen from Pascal's triangle, symbolically

$$\left\{ \begin{array}{ccc} - & \cdot & \\ & \cdot & \cdot \\ & & + \end{array} \right\} = \left\{ \begin{array}{ccc} - & \cdot & \\ + & + & \\ & & \cdot \end{array} \right\} = \left\{ \begin{array}{ccc} \cdot & + & \\ & \cdot & + \\ & & \cdot \end{array} \right\}$$

and since (5.5) is also the correct expression for  $s = 0$  and  $s = 1$ , we have

$$\sum_{\lambda \in \mathbb{Y}_N^0} t^{\#(\text{o-inner corners of } \lambda)} = \sum_{s=0}^{(N-1)/2} \frac{N}{N-s} \binom{N-s}{s} t^s. \tag{5.6}$$

As an alternative, we compute

$$(\mathbf{1} - qS)^{-1} = \frac{1}{1 - (1+2t)q + t^2q^2} \begin{pmatrix} 1 - 2tq - (t-t^2)q^2 & q - tq^2 & q^2 \\ tq + (t-t^2)q^2 & 1 - (1+t)q + tq^2 & q - q^2 \\ tq & tq & 1 - (1+t)q \end{pmatrix}$$

from which we get the generating series

$$\sum_{k=0}^{\infty} \text{tr}(S^k) q^k = \frac{3 - (2+4t)q + t^2q^2}{1 - (1+2t)q + t^2q^2} = 3 + \frac{(1+2t)q - 2t^2q^2}{1 - (1+2t)q + t^2q^2} = 3 + (1+2t)q + \dots$$

and hence

$$\begin{aligned}
1 + \sum_{k=1}^{\infty} \text{tr}(S^{k+1} - tS^k) q^k &= 1 + \left( \frac{(1+2t) - 2t^2q}{1 - (1+2t)q + t^2q^2} - (1+2t) \right) - t \frac{(1+2t)q - 2t^2q^2}{1 - (1+2t)q + t^2q^2} \\
&= \frac{1+tq}{1 - (1+2t)q + t^2q^2}
\end{aligned}$$

$$\begin{aligned}
&= \frac{\frac{1 + \sqrt{1 + 4t}}{2}}{1 - \left(\frac{1 + \sqrt{1 + 4t}}{2}\right)^2 q} + \frac{\frac{1 - \sqrt{1 + 4t}}{2}}{1 - \left(\frac{1 - \sqrt{1 + 4t}}{2}\right)^2 q} \\
&= \sum_{k=0}^{\infty} \left( \left(\frac{1 + \sqrt{1 + 4t}}{2}\right)^{2k+1} + \left(\frac{1 - \sqrt{1 + 4t}}{2}\right)^{2k+1} \right) q^k. \quad (5.7)
\end{aligned}$$

From (5.4) and the generating series (5.7) we have (at least for  $N \geq 3$ )

$$\sum_{\lambda \in \mathbb{Y}_N^{\circ}} t^{\#(\circ\text{-inner corners of } \lambda)} = \left(\frac{1 + \sqrt{1 + 4t}}{2}\right)^N + \left(\frac{1 - \sqrt{1 + 4t}}{2}\right)^N. \quad (5.8)$$

**Theorem 5.3** *Let  $N = 2k + 1$  be an odd positive integer. The injective hull  $E(C_N)$  of an  $N$ -cycle satisfies*

$$\sum_{v \geq 0} \#(v\text{-faces in } E(C_N)) t^v = \left(\frac{1 + \sqrt{5 + 4t}}{2}\right)^N + \left(\frac{1 - \sqrt{5 + 4t}}{2}\right)^N \quad (5.9)$$

$$= \sum_{s=0}^{(N-1)/2} \frac{N}{N-s} \binom{N-s}{s} (1+t)^s \quad (5.10)$$

and it follows that

$$\#(v\text{-faces in } E(C_N)) = \frac{1}{2^{N-2v-1}} \sum_{s=v}^{(N-1)/2} \binom{N}{2s} \binom{s}{v} 5^{s-v} \quad (5.11)$$

$$= \sum_{s=v}^{(N-1)/2} \frac{N}{N-s} \binom{N-s}{s} \binom{s}{v}. \quad (5.12)$$

*Proof.*  $E(C_1)$  consists of a single point, in accordance with the statement of the theorem. Let us suppose that  $k \geq 1$ . Recall that each  $\lambda \in \mathbb{Y}_N^{\circ}$  with  $s$   $\circ$ -inner corners gives rise to  $\binom{s}{v}$   $v$ -faces with “top vertex”  $g_\lambda \in E(C_N)$ . Hence

$$\sum_{v \geq 0} \#(v\text{-faces in } E(C_N)) t^v = \sum_{\lambda \in \mathbb{Y}_N^{\circ}} (1+t)^{\#(\circ\text{-inner corners of } \lambda)}$$

and (5.9) follows from (5.8), whereas (5.10) follows from (5.6). We expand the right hand side of (5.9)

$$\left(\frac{1 + \sqrt{5 + 4t}}{2}\right)^N + \left(\frac{1 - \sqrt{5 + 4t}}{2}\right)^N = \frac{1}{2^{N-1}} \sum_{s=0}^{(N-1)/2} \binom{N}{2s} \sum_{v=0}^s \binom{s}{v} 5^{s-v} (4t)^v$$

from which we have (5.11). Finally, (5.12) follows directly from (5.10).  $\square$

**Remark 5.4** The number of vertices in  $E(C_N)$ , still for  $N$  odd, is the  $N$ th Lucas number  $L_N = \varphi^N + (1 - \varphi)^N$ , where  $\varphi = \frac{1}{2}(1 + \sqrt{5})$  is the golden ratio, which follows by putting  $t = 0$  in (5.9). Since the cyclic group of order  $N$  permutes the vertices of  $E(C_N)$  with exactly one fixed point, one has the congruence  $L_p \equiv 1 \pmod{p}$  for each odd prime number  $p$ , a result that is also evident by using either of the expressions (5.11) and (5.12) specialized to  $v = 0$  for the odd-indexed Lucas numbers.

The total number of (nonempty) faces in  $E(C_N)$  is  $2^N - 1$ , which follows by putting  $t = 1$  in (5.9). Another special value to insert in (5.9) is  $t = -1$ . The Euler characteristic of  $E(C_N)$  is 1, as it must be because injective hulls are contractible.

**Remark 5.5** Let us briefly give the analogous computations for  $N = 2k$  even. The discrete Möbius strip is  $\mathfrak{X}_N^\circ := \{(i, j) \in \mathfrak{X}_N \mid d(\alpha_i, \alpha_j) \geq k - 1\}$  and has  $\frac{3}{2}N$  sites. Let  $\mathbb{Y}_N^\circ$  be defined as in Definition 3.1. The matrices that are used for the census are

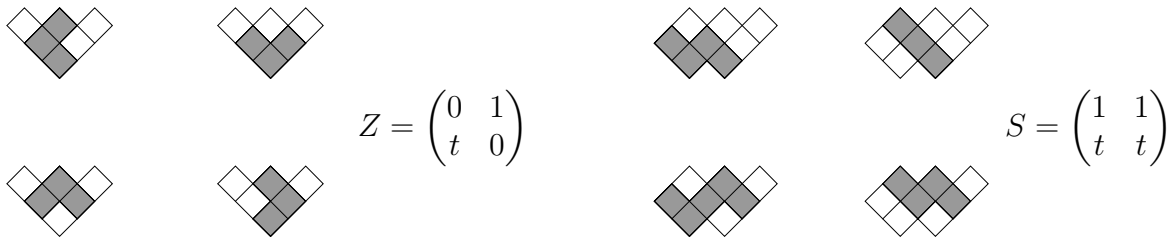

$$Z = \begin{pmatrix} 0 & 1 \\ t & 0 \end{pmatrix} \quad S = \begin{pmatrix} 1 & 1 \\ t & t \end{pmatrix}$$

and  $A$  is the  $2 \times 2$  matrix with all entries 1. Then

$$\sum_{\lambda \in \mathbb{Y}_N^\circ} t^{\#\text{(o-inner corners of } \lambda)} = \text{tr}(AS^{k-1}Z) = \text{tr}(S^{k-1}ZA) = \text{tr}(S^k) = (1 + t)^k$$

and hence

$$\sum_{v \geq 0} \#(v\text{-faces in } E(C_{2k})) t^v = (2 + t)^k$$

as was clear before because  $E(C_{2k})$  is a  $k$ -dimensional cube.

## 6 Pictures and additional material

For  $N = 2k + 1 \geq 5$  we have  $\alpha := \alpha_0 = (k - 1, \dots, 1) \in \mathbb{Y}_N^\circ$ , which is the least element. Let  $\beta = (k, \dots, 2) \in \mathbb{Y}_N^\circ$ . All the  $2^{k-1}$  partitions in the interval  $[\alpha, \beta]$  have length  $k - 1$ . For such a partition  $\lambda$  let  $(\lambda 1)$  denote the partition with one additional part 1. In particular,  $(\beta 1) = (k, \dots, 1) \in \mathbb{Y}_N^\circ$  is fixed by the cyclic action  $\tau$ . We have the evident decomposition

$$[\alpha, (\beta 1)] = [\alpha, \beta] \cup \{(\lambda 1) \mid \lambda \in [\alpha, \beta]\} = [\alpha, \beta] \cup [(\alpha 1), (\beta 1)].$$

The convex hull of the vertices  $g_\nu$  for  $\nu \in [\alpha, (\beta 1)]$  is one of the  $N$  faces of  $E(C_N)$  of maximal dimension. The 1-skeleton of this  $k$ -cube is drawn in red in the following pictures for  $N = 5, 7, 9, 11$ . The part for  $\lambda \in [\alpha, \beta]$  is drawn with somewhat thicker edges.

For  $\lambda = (k - 1 + \delta_1, \dots, 1 + \delta_{k-1}) \in [\alpha, \beta]$  (i. e. with  $\delta_j \in \{0, 1\}$ ), which we also write as  $\lambda = \alpha + (\delta_1, \dots, \delta_{k-1})$ , we get

$$\tau(\lambda 1) = \begin{cases} (k, k - 2 + \delta_1, \dots, 1 + \delta_{k-2}) & \text{if } \delta_{k-1} = 0, \\ (k, k - 2 + \delta_1, \dots, 1 + \delta_{k-2}, 1) & \text{if } \delta_{k-1} = 1. \end{cases}$$

and rewrite it as

$$\tau(\alpha \dot{+} (\delta_1, \dots, \delta_{k-1}) 1) = \begin{cases} \alpha \dot{+} (1, \delta_1, \dots, \delta_{k-2}) & \text{if } \delta_{k-1} = 0, \\ (\alpha \dot{+} (1, \delta_1, \dots, \delta_{k-2}) 1) & \text{if } \delta_{k-1} = 1. \end{cases}$$

Hence for each partition  $(\lambda 1)$  with  $\lambda \in [\alpha, \beta)$  there is an exponent  $l \geq 0$  such that  $\tau^j(\lambda 1) = (\lambda_j 1)$  with  $\lambda_j \in [\alpha, \beta)$  for  $j = 0, \dots, l$  and  $\tau^{l+1}(\lambda 1) = \lambda_{l+1} \in [\alpha, \beta]$ . In fact, for  $\lambda = \alpha \dot{+} (\delta_1, \dots, \delta_{k-1})$  the corresponding exponent is  $l = \min\{j \mid \delta_{k-1-j} = 0\}$ . So every vertex of  $E(C_N)$  that belongs to at least one of the  $N$   $k$ -cubes is either the fixed point  $g_{(\beta 1)}$  or belongs to the orbit of one of the points  $g_\lambda$  for  $\lambda \in [\alpha, \beta]$ .

For  $\lambda = \alpha \dot{+} (\delta_1, \dots, \delta_{k-1}) \in [\alpha, \beta]$  we have  $(1, k), (2, k+1), \dots, (k+1, N-1) \notin \mathcal{L}_\lambda$  and  $(0, k+2) \in \mathcal{L}_\lambda$ . The following picture illustrates the situation for  $N = 9$ . We see three copies of a fundamental domain in the universal covering.

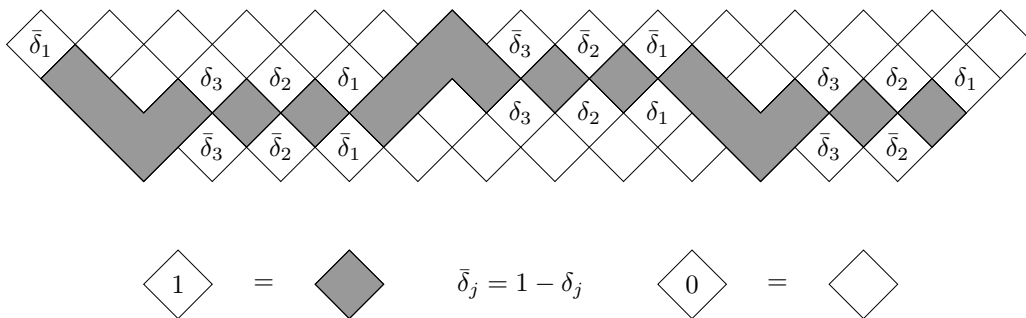

The cyclic action  $\tau$  is given by translating the outer rim in the Möbius strip. Suppose now that we have an equality  $\lambda = \tau^j(\mu)$  with  $j \in \{0, \dots, N-1\}$  and  $\lambda, \mu \in [\alpha, \beta]$ . From the considerations above it is clear that such an equality can only hold if  $j = 0$  and  $\lambda = \mu$ . Thus the subcomplex induced from the faces of maximal dimension has  $1 + (2k+1) \cdot 2^{k-1}$  vertices. For  $k = 2$  and  $k = 3$  there are no further vertices in  $E(C_{2k+1})$ .

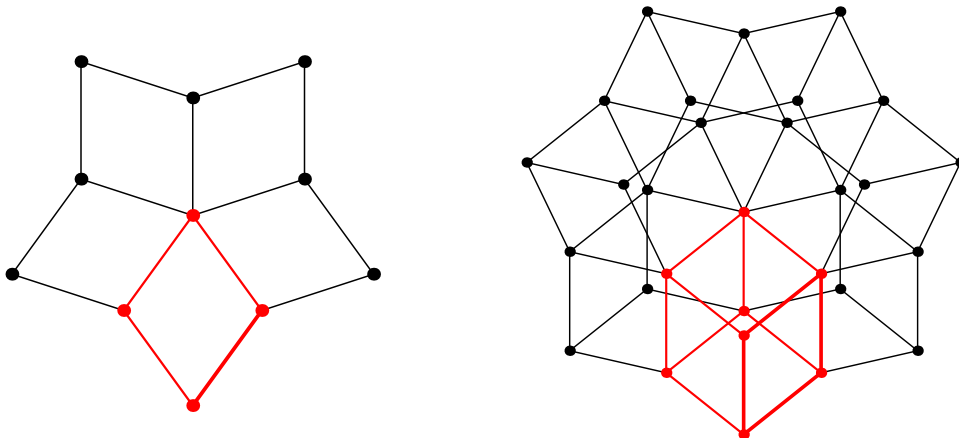

But the ratio  $(1 + (2k+1) \cdot 2^{k-1}) / L_{2k+1}$  (recall from Remark 5.4 that the total number of vertices in  $E(C_{2k+1})$  is  $L_{2k+1}$ ) tends to zero as  $k$  tends to infinity. The three additional vertices in  $E(C_9)$ , that do not belong to a tesseract, form an orbit under the cyclic action and were already mentioned in [S3, page 19]. The corresponding partitions are  $(3^3)$ ,  $(5 2^3)$ , and  $(4^2 1^3)$ . The three vertices belong to three cubes with the fixed-point vertex  $g_{(4321)}$  as the opposite vertex in each of these three cubes. The following diagram shows the three relevant subposets in  $\mathbb{Y}_9^\circ$ .

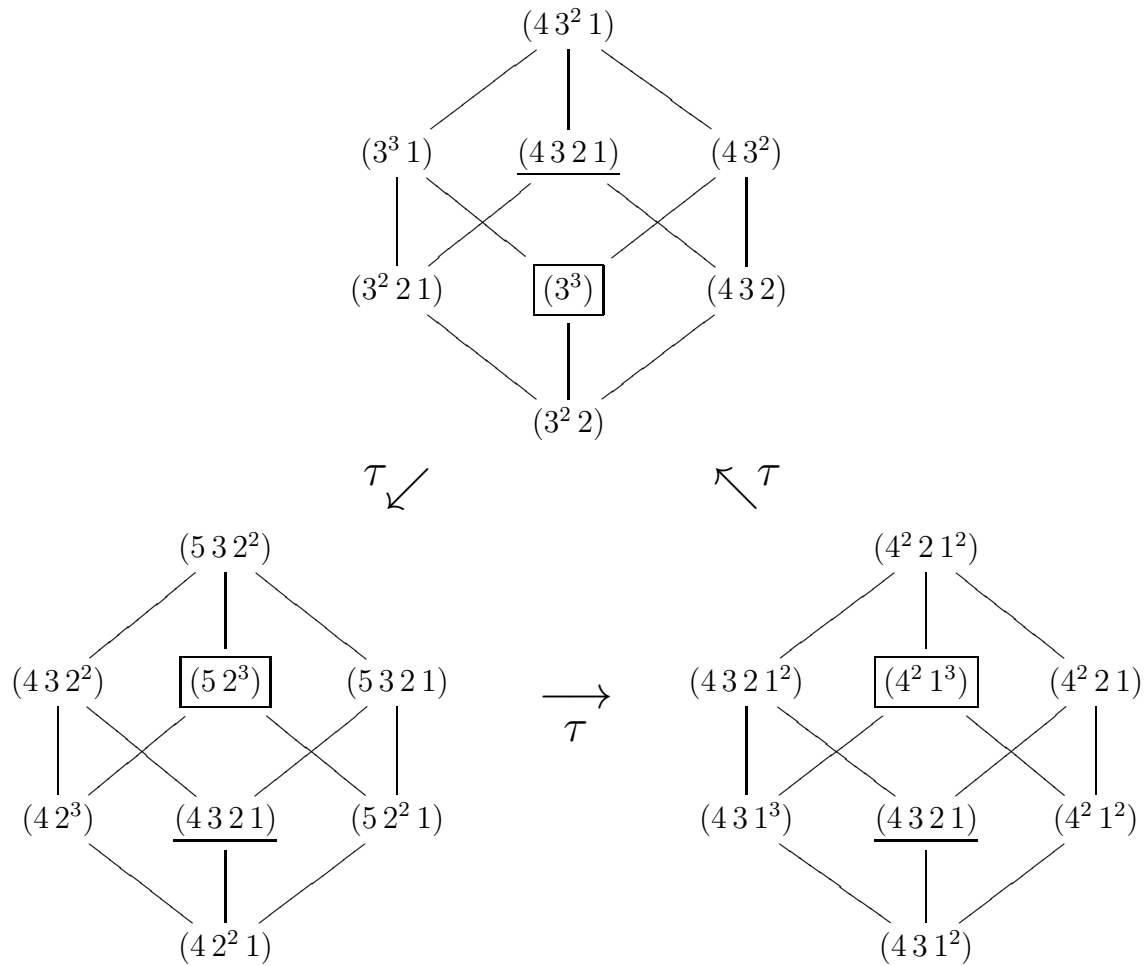

The three additional vertices and their incident edges are drawn in blue in the next picture, and the positions are slightly distorted to get a faithful picture of the combinatorial structure.

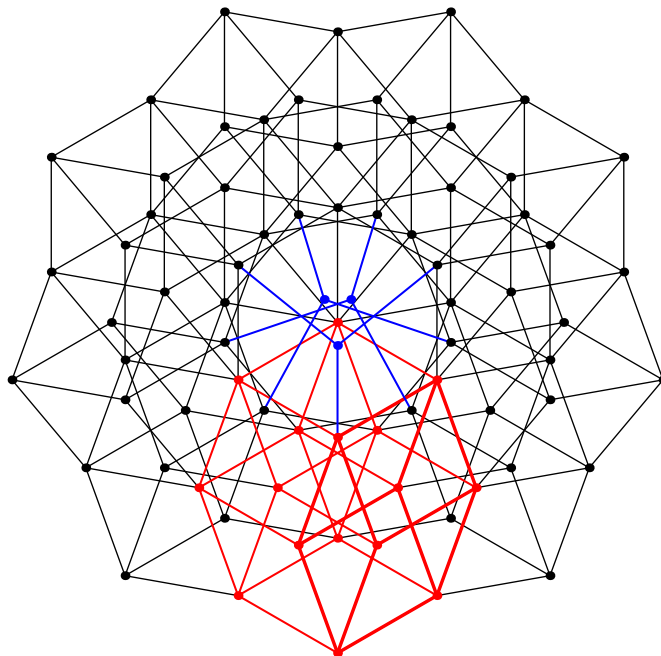

The next picture displays the 1-skeleton of  $E(C_{11})$ .

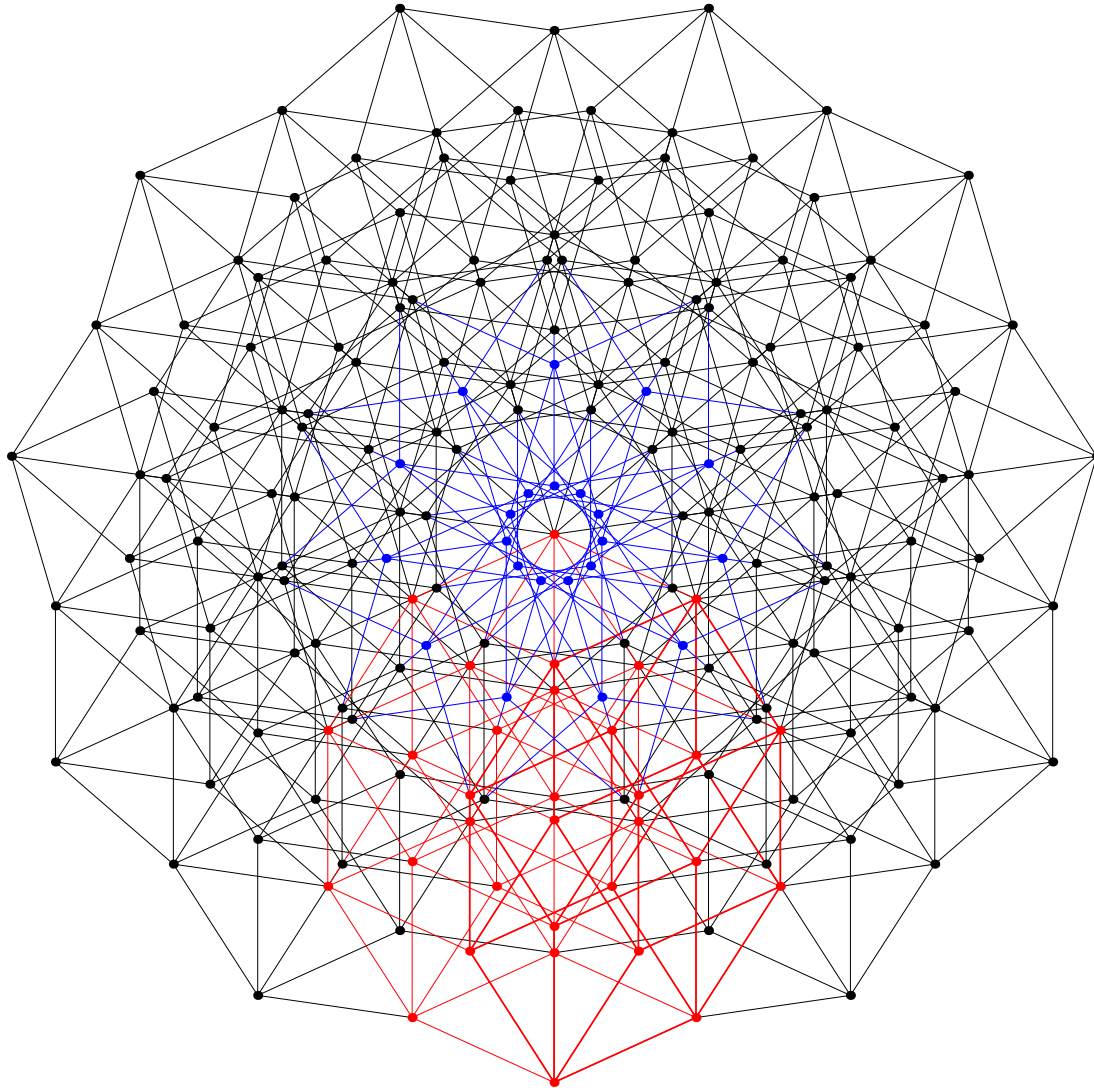

There are 177 vertices that are incident with at least one of the eleven 5-cubes. The 22 additional vertices and their incident edges are drawn in blue.

It should not come as a surprise that the fibre cardinalities of the mapping  $\mathbb{Y}_N \rightarrow \mathbb{Y}_N^\circ$ ,  $\lambda \mapsto \lambda^\circ$  are products of Catalan numbers  $C_n = \frac{1}{n+1} \binom{2n}{n}$  (a misunderstanding with the notation  $C_N$  for the  $N$ -cycle can be excluded from the context).

**Example** For  $N = 11$  the fibre cardinalities are 1, 2, 4, 5, 14, 42, as illustrated in the following pictures. A factor  $C_n$  stands for  $n$  consecutive sites in  $\mathcal{L}_\lambda$  touching the boundary of  $\mathfrak{X}_N^\circ$ .

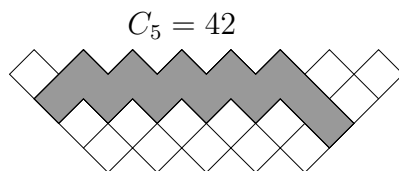

$$\lambda = (5, 5, 4, 3, 2, 1)$$

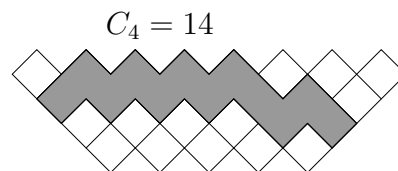

$$\lambda = (5, 4, 4, 3, 2, 1)$$



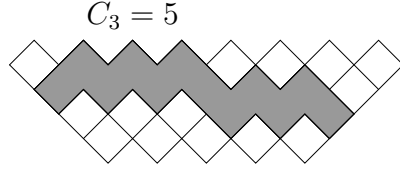

$$\lambda = (5, 4, 3, 3, 2, 1)$$

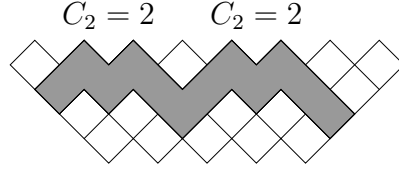

$$\lambda = (5, 5, 4, 2, 2, 1)$$

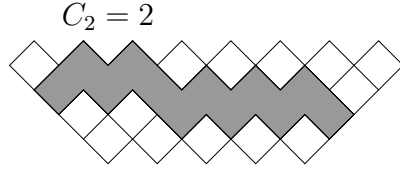

$$\lambda = (5, 4, 3, 2, 2, 1)$$

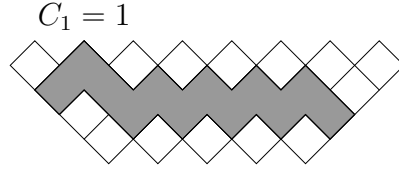

$$\lambda = (5, 4, 3, 2, 1, 1)$$

One could also take into account the exact number of the factors  $C_0 = 1$  and  $C_1 = 1$ . The following products (meticulously listed in cyclic order) give such a finer report for  $N = 11$ , where each of the nineteen products corresponds to a  $\tau$ -orbit in  $\mathbb{Y}_{11}^\circ$  (in particular,  $C_0^{11}$  corresponds to the fixed point).

$$\begin{aligned} 1 &= C_0^{11} = C_1 \cdot C_0^{10} = C_1 \cdot C_0 \cdot C_1 \cdot C_0^8 = C_1 \cdot C_0^2 \cdot C_1 \cdot C_0^7 = C_1 \cdot C_0^3 \cdot C_1 \cdot C_0^6 \\ &= C_1 \cdot C_0 \cdot C_1 \cdot C_0 \cdot C_1 \cdot C_0^6 = C_1 \cdot C_0^2 \cdot C_1 \cdot C_0^3 \cdot C_1 \cdot C_0^3 \\ 2 &= C_2 \cdot C_0^9 = C_2 \cdot C_0 \cdot C_1 \cdot C_0^7 = C_2 \cdot C_0^7 \cdot C_1 \cdot C_0 \\ &= C_2 \cdot C_0^2 \cdot C_1 \cdot C_0^6 = C_2 \cdot C_0^6 \cdot C_1 \cdot C_0^2 = C_2 \cdot C_0^2 \cdot C_1 \cdot C_0^3 \cdot C_1 \cdot C_0^2 \\ 4 &= C_2 \cdot C_0 \cdot C_2 \cdot C_0^6 \\ 5 &= C_3 \cdot C_0^8 = C_3 \cdot C_0 \cdot C_1 \cdot C_0^6 = C_3 \cdot C_0^6 \cdot C_1 \cdot C_0 \\ 14 &= C_4 \cdot C_0^7 \\ 42 &= C_5 \cdot C_0^6 \end{aligned}$$

In particular, one might want to look at the subset with fibre cardinality one

$$\mathbb{Y}_N^{\circ\circ} := \{\lambda \in \mathbb{Y}_N^\circ \mid \mathbb{Y}_N \ni \mu \text{ with } \mu^\circ = \lambda \implies \mu = \lambda\}.$$

The cardinality of  $\mathbb{Y}_N^{\circ\circ}$  can be computed as a trace analogous to what was done for  $\mathbb{Y}_N^\circ$ . The result for  $N = 2k + 1$  is

$$\begin{aligned} |\mathbb{Y}_N^{\circ\circ}| &= \text{tr} \left( \begin{pmatrix} 0 & 1 & 0 \\ 1 & 1 & 1 \\ 1 & 1 & 0 \end{pmatrix} \begin{pmatrix} 0 & 1 & 0 \\ 1 & 1 & 1 \\ 1 & 1 & 0 \end{pmatrix}^{k-1} \begin{pmatrix} 0 & 0 & 1 \\ 1 & 1 & 0 \\ 0 & 1 & 0 \end{pmatrix} \right) = [q^k] \frac{1 + 3q}{1 - q(1 + q)^2} \\ &= [q^k] (1 + 4q + 6q^2 + 15q^3 + 31q^4 + 67q^5 + 144q^6 + 309q^7 + 664q^8 + 1426q^9 + \dots). \end{aligned}$$

The analogous sets for  $2N$  are

$$\mathbb{Y}_{2N}^{\circ\circ} = \begin{cases} \{(N-1, N-1, N-3, N-3, \dots, 2, 2), \\ (N, N-2, N-2, N-4, N-4, \dots, 1, 1)\} & \text{if } N \text{ is odd,} \\ \emptyset & \text{if } N \text{ is even.} \end{cases}$$

The two partitions in  $\mathbb{Y}_{2N}^{\circ\circ}$  for  $N$  odd are interchanged by the cyclic action  $\tau$ . One can then look at embeddings  $E(C_N) \subseteq E(C_{2N})$  such that the fixed point of  $E(C_N)$  is mapped to the vertex corresponding to either one of those  $\tau^2$ -fixed points in  $\mathbb{Y}_{2N}^{\circ\circ}$ .

**Example**  $N = 5$

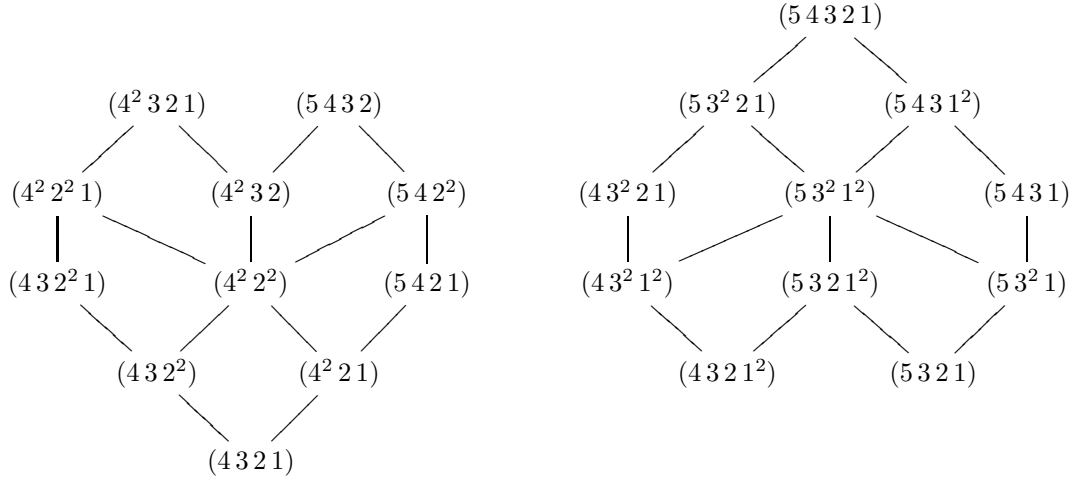

The relevant parts of the Hasse diagram are displayed. On the left hand side the poset structure of  $\mathbb{Y}_5^\circ$  is realized as a subposet in the Boolean lattice  $\mathbb{Y}_{10}^\circ$ , and on the right we have the reversed poset structure as the image under  $\tau^5$ . The remaining  $2^5 - 2 \cdot 11 = 10$  elements of  $\mathbb{Y}_{10}^\circ$  constitute the  $\tau$ -orbit of  $(5 4 2^2 1)$ .

In general, for  $N = 2k + 1$  odd we have the embedding  $\mathbb{Y}_N^\circ \rightarrow \mathbb{Y}_{2N}^\circ$  as illustrated in the following diagram for  $N = 7$ .

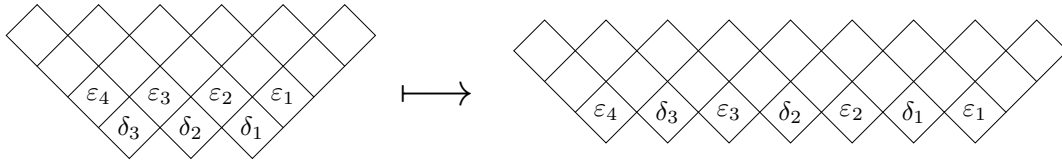

$\varepsilon_1, \delta_1, \dots, \varepsilon_k, \delta_k, \varepsilon_{k+1} \in \{0, 1\}$  with the condition  $\delta_i = 0$  only if  $\varepsilon_i = \varepsilon_{i+1} = 0$  ( $i = 1, \dots, k$ ), furthermore  $\varepsilon_1 + \varepsilon_{k+1} \leq 1$  (this last inequality holds because otherwise the restriction regarding the maximal hook length would be violated; but in a more uniform manner, it is simply the condition  $\delta_{k+1} = 0$  only if  $\varepsilon_{k+1} = \varepsilon_{k+2} = 0$  with  $\delta_{k+1} = 1 - \varepsilon_1$  and  $\varepsilon_{k+2} = 1 - \delta_1$ , and in fact, look at the universal covering of the Möbius strip to make the whole periodicity manifest). Let  $\alpha_0 = (k - 1, \dots, 1) \in \mathbb{Y}_N^\circ$  and  $\alpha_0^{(2)} = (2k, \dots, 1) \in \mathbb{Y}_{2N}^\circ$  be the least elements. The embedding can be written as

$$\begin{aligned} \mathbb{Y}_N^\circ \ni \lambda &= (\alpha_0 \dot{+} (\delta_1 + \varepsilon_1, \dots, \delta_{k-1} + \varepsilon_{k-1}) \delta_k + \varepsilon_k \varepsilon_{k+1}) \Big|_{\text{remove trailing zeros}} \\ &\longmapsto \lambda^{(2)} := (\alpha_0^{(2)} \dot{+} (\varepsilon_1, \delta_1, \dots, \varepsilon_k, \delta_k) \varepsilon_{k+1}) \Big|_{\text{remove trailing zeros}} \in \mathbb{Y}_{2N}^\circ. \end{aligned}$$

If we write  $\tau_N$  and  $\tau_{2N}$  for the cyclic actions, then  $(\tau_N(\lambda))^{(2)} = (\tau_{2N})^2(\lambda^{(2)})$ . In terms of the  $\delta$ - and  $\varepsilon$ -parameters the cyclic actions are given by

$$\begin{aligned} (\delta_1, \dots, \delta_k) &\xrightarrow{\tau_N} (1 - \varepsilon_{k+1}, \delta_1, \dots, \delta_{k-1}) \\ (\varepsilon_1, \dots, \varepsilon_{k+1}) &\xrightarrow{\tau_N} (1 - \delta_k, \varepsilon_1, \dots, \varepsilon_k) \end{aligned}$$

respectively

$$(\varepsilon_1, \delta_1, \dots, \varepsilon_k, \delta_k, \varepsilon_{k+1}) \xrightarrow{\tau_{2N}} (1 - \varepsilon_{k+1}, \varepsilon_1, \delta_1, \dots, \varepsilon_k, \delta_k).$$

One might want to look at the following continuous version

$$\mathbb{Y}_{2\infty+1}^\circ := \left\{ (\delta, \varepsilon) : (0, 1) \times [0, 1] \longrightarrow \{0, 1\} \mid \begin{array}{l} \forall r \in (0, 1) : \delta(r) = 0 \implies \varepsilon(r) = 0 \\ \varepsilon(0) = 1 \implies \varepsilon(1) = 0 \end{array} \right\}$$

or with  $\delta, \varepsilon : \mathbb{R} \rightarrow \{0, 1\}$  defined via  $\delta(1+r) = 1 - \varepsilon(r)$  and  $\varepsilon(1+r) = 1 - \delta(r)$ .

Homotopically nontrivial loops of length  $N$  in the Möbius strip  $\mathfrak{X}_N$  parametrize the partitions in  $\mathbb{Y}_N$ , those loops that lie in  $\mathfrak{X}_N^\circ$  characterize the subset  $\mathbb{Y}_N^\circ$ . More generally, one can consider those partitions in  $\mathbb{Y}_N$  whose outer rims lie in

$$\mathfrak{X}_N^{(m)} := \{(i, j) \in \mathfrak{X}_N \mid k - m \leq j - i \leq N - k + m\}$$

where  $k := \lfloor \frac{N}{2} \rfloor$ . In particular,  $\mathfrak{X}_N^{(1)} = \mathfrak{X}_N^\circ$  and  $\mathfrak{X}_N^{(k)} = \mathfrak{X}_N$ . So

$$\mathbb{Y}_N^{(m)} := \{\lambda \in \mathbb{Y}_N \mid \mathcal{L}_\lambda \subseteq \mathfrak{X}_N^{(m)}\}.$$

To count the admissible loops in the Möbius strip, let us use a rectangular shape instead of the triangular shape that we employed before.

$N = 2k + 1$  odd

$|\mathbb{Y}_{2k+1}^{(m)}| = \text{tr}(S_m^{2k+1})$ . In particular for  $m = 1$  we have the well-known expression of the  $N$ th Lucas number from Remark 5.4 as a sum of two Fibonacci numbers:

$$L_N = |\mathbb{Y}_N^\circ| = \text{tr} \left( \begin{pmatrix} 0 & 1 \\ 1 & 1 \end{pmatrix}^N \right) = \text{tr} \begin{pmatrix} F_{N-1} & F_N \\ F_N & F_{N+1} \end{pmatrix} = F_{N-1} + F_{N+1}.$$

$N = 2k$  even

$|\mathbb{Y}_{2k}^{(m)}| = \text{tr}(J_m T_m^k)$  where  $J_m$  is the  $(m+1) \times (m+1)$  matrix with 1 on the antidiagonal and 0 elsewhere.

## Acknowledgement

It is a pleasure to thank Urs Lang for bringing to my attention that the injective hulls of odd cycles are not well-understood.

## References

- [GM] O. Goodman, V. Moulton, On the tight span of an antipodal graph, *Discrete Math.* **218** (2000) 73–96.  
doi:10.1016/S0012-365X(99)00337-4
- [S1] R. Suter, Young’s lattice and dihedral symmetries, *Eur. J. Comb.* **23** (2002) 233–238.  
doi:10.1006/eujc.2001.0541
- [S2] R. Suter, Abelian ideals in a Borel subalgebra of a complex simple Lie algebra, *Invent. Math.* **156** (2004) 175–221.  
doi:10.1007/s00222-003-0337-0
- [S3] R. Suter, Young’s lattice and dihedral symmetries revisited: Möbius strips and metric geometry, preprint (2012).  
arXiv:1212.4463 [math.CO]