

Ahlfors circle maps: historical ramblings

Alexandre Gabard

October 30, 2018

Nihil est in infinito quod non prius fuerit in finito.
André Bloch 1926 [105], [106].

ABSTRACT. This is a prejudiced survey on the Ahlfors (extremal) function and the weaker *circle maps* (Garabedian-Schiffer’s translation of “Kreisabbildung”), i.e. those (branched) maps effecting the conformal representation upon the disc of a *compact bordered Riemann surface*. The theory in question has some well-known intersection with real algebraic geometry, especially Klein’s orthosymmetric curves via the paradigm of *total reality*. This leads to a gallery of pictures quite pleasant to visit of which we have attempted to trace the simplest representatives. This drifted us toward some electrodynamic motions along real circuits of dividing curves perhaps reminiscent of Kepler’s planetary motions along ellipses. The ultimate origin of circle maps is of course to be traced back to Riemann’s Thesis 1851 as well as his 1857 Nachlass. Apart from an abrupt claim by Teichmüller 1941 that everything is to be found in Klein (what we failed to assess on printed evidence), the pivotal contribution belongs to Ahlfors 1950 supplying an existence-proof of circle maps, as well as an analysis of an allied function-theoretic extremal problem. Works by Yamada 1978–2001, Gouma 1998 and Coppens 2011 suggest sharper degree controls than available in Ahlfors’ era. Accordingly, our partisan belief is that much remains to be clarified regarding the foundation and optimal control of Ahlfors circle maps. The game of sharp estimation may look narrow-minded “Abschätzungsmathematik” alike, yet the philosophical outcome is as usual to contemplate how conformal and algebraic geometry are fighting together for the soul of Riemann surfaces.

Contents

1	Introduction	4
1.1	Trying to wet some appetite out of the blue	7
1.2	Applications	12
1.3	Bibliographic and keywords chart	14
1.4	Mathematical questions	14
1.5	Some vague answers	19
1.6	Some historical quiz	27
2	The province of Felix Klein	27
2.1	Felice Ronga and Felix Klein’s influence	27
2.2	Digression about Hilbert’s 16th problem (Klein 1922, Rohlin 1974, Kharlamov-Viro ca. 1975, Marin 1979, Gross-Harris 1981)	31
2.3	A long unnoticed tunnel between Klein and Ahlfors (Alling-Greenleaf 1969, Geyer-Martens 1977)	32
2.4	Motivation (better upper bounds exist)	32
2.5	Full coverings versus Ahlfors’ extremals	33
2.6	Sorting out applications: finite vs. infinite/compact vs. open	35
3	Biased recollections of the writer	36
3.1	Klein’s viewpoint: real curves as symmetric Riemann surfaces (as yet another instance of the Galois-Riemann Verschmelzung)	36
3.2	Criterion for Klein’s orthosymmetry=Type I, in Russian (Klein 1876–82; Rohlin 1978, Fiedler 1978 vs. Alling-Greenleaf 1969, Geyer-Martens 1977)	39

arXiv:1211.3680v1 [math.HO] 15 Nov 2012

4	Dirichlet's principle (Überzeugungskraft vs. mathematical comedy)	41
4.1	Chronology (Green 1828, Gauss 1839, Dirichlet ca. 1840, Thomson 1847, Kirchhoff 1850, Riemann 1851–57, Weierstrass 1870, etc.)	42
4.2	Early suspicions about the Dirichlet principle (Weierstraß 1859/70, Schwarz 1869, Prym 1871, Hadamard 1906)	43
5	Philosophical remarks	44
5.1	Flexibility of 2D-conformal maps	44
5.2	Free-hand pictures of some Riemann-Ahlfors maps	45
5.3	Hard problems and the hyperelliptic claustrophobia	46
5.4	Topological methods	47
5.5	Bordered Riemann surfaces and real algebraic curves	48
5.6	Lebesgue versus Riemann	48
6	Prehistory of Ahlfors	50
6.1	Tracing back the early history (Riemann 1857, Schwarz, Schottky 1875–77, H. Weber 1876, Bieberbach 1925, Grunsky 1937–50, Wirtinger 1941)	51
6.2	Schottky 1875–77	52
6.3	Klein's comments about Riemann-Schottky	54
6.4	A historical puzzle: why Klein missed the Ahlfors circle mapping?	56
6.5	Rückkehrschnitttheorem (Klein 1881–82)	57
6.6	Grunsky's bibliographical notes (Grunsky 1978)	57
6.7	Italian school: Cecioni 1908, Stella Li Chiavi 1932, Matildi 1948, Andreotti 1950	58
7	Is there any precursor to Ahlfors 1950?	59
7.1	What about Teichmüller?	59
7.2	Detective work: Browsing Klein through the claim of Teichmüller	59
7.3	More is less: Teichmüller again (1939)	61
7.4	Courant 1937, 1939, 1950	61
7.5	Douglas 1931–36–39	65
7.6	Cecioni and his students, esp. Matildi 1948, and Andreotti 1950	66
7.7	A global picture (the kaleidoscope)	66
8	Digression on Bieberbach and Bergman	67
8.1	The Bergman kernel	67
8.2	Minimizing the integral vs. maximizing the derivative (suction vs. injection), i.e. Bieberbach 1914-Bergman 1921/22 vs. Fejér-Riesz 1922, etc.	69
8.3	Bergman kernel on Riemann surfaces	70
8.4	β and α problems	71
8.5	Least area problem vs. least momentum	75
8.6	A digression about Nehari's paper of 1955	76
9	Ahlfors' extremal problem	77
9.1	Ahlfors extremal problem (Grunsky 1940–42, Ahlfors 1947–50)	77
9.2	Semi-fictional reconstruction of Ahlfors' background (Fejér-Riesz 1922, Carathéodory 1928, Ostrowski 1929)	78
9.3	Extremal problems and pure function-theoretic proofs of the RMT (Koebe, Carathéodory, Bieberbach)	79
9.4	Interlude: Das Werk Paul Koebe	80
9.5	Koebe and its relation to Klein or Ahlfors	84
9.6	Ahlfors' background (Bergman 1941, Schiffer 1946, Schottky differentials)	84
9.7	The allied infinitesimal form of the extremal problem	86
9.8	Higher extremal problems=HEP \approx High energy physics, alias Pick-Nevanlinna interpolation	86
10	Ahlfors' proof	87
10.1	Soft part of Ahlfors 1950: circle maps with $\leq r + 2p = g + 1$ sheets	87
10.2	Ahlfors hard extremal problem	88

11 Other accounts of Ahlfors' extremal problem	89
11.1 Garabedian 1949, 1950	89
11.2 Nehari 1950, Tietz 1955, Köditz-Timann 1975	89
11.3 Heins 1950	90
11.4 Kuramochi 1952	91
11.5 Read 1958, Royden 1962 (via Hahn-Banach)	91
12 Existence of (inextremal) circle maps	92
12.1 Ahlfors 1948/50, Garabedian 1949	92
12.2 Mizumoto 1960	93
12.3 Gabard 2004–2006	93
13 Related results	93
13.1 Parallel slit mappings (Schottky 1877, Cecioni 1908, Hilbert 1909) . .	94
13.2 Kreisnormierungsprinzip (Riemann 1857, Schottky 1877, Koebe 1906- 08-10-20-22, Denneberg 1932, Grötzsch 1935, Meschkowski 1951–52, Strebel 1951–53, Bers 1961, Sibner 1965–68, Morrey 1966, Haas 1984, He-Schramm 1993)	95
13.3 Röding 1977 (still not read)	96
13.4 Behavior of the Ahlfors function in domains of infinite connectivity . .	96
14 The quest of best-possible bounds	96
14.1 Distribution of Ahlfors' degrees (Yamada 1978–2001, Gouma 1998) . .	96
14.2 Separating gonality (Coppens 2011)	97
14.3 Naive question: Ahlfors degree vs. the gonality	98
14.4 Other sources (Černe-Forstnerič 2002)	98
15 Applications of the Ahlfors mapping	98
15.1 Gleichgewicht der Electricität (Riemann 1857)	99
15.2 Painlevé's problem (Painlevé 1888, Ahlfors 1947, . . . , Tolsa 2003) . . .	100
15.3 Type problem (Kusunoki 1952)	101
15.4 Carathéodory metric (Carathéodory 1926, Grunsky 1940, etc.)	102
15.5 Corona (Carleson 1962, Alling 1964, Stout 1964, Hara-Nakai 1985) . .	102
15.6 Quadrature domains (Aharonov-Shapiro 1976, Sakai 1982, Gustaffson 1983, Bell 2004, Yakubovich 2006)	102
15.7 Steklov eigenvalues (Fraser-Schoen 2010, Girouard-Polterovich 2012) .	103
15.8 Other (Dirichlet-Neumann) eigenvalues (Gabard 2011)	103
16 Virtual applications of the Ahlfors map	103
16.1 Filling area conjecture (Loewner 1949, Pu 1952, Gromov 1983)	103
16.2 Open Riemann surfaces embed in \mathbb{C}^2 (Narasimhan, Gromov, Slovenian school, etc.)	103
16.3 Pick-Nevanlinna interpolation	104
17 Starting from zero knowledge	104
17.1 The Harnack-maximal case (Enriques-Chisini 1915, Bieberbach 1925, Wirtinger 1941, Huisman 2001)	104
17.2 Gabard's argument: circle maps of $\deg \leq r + p$	105
17.3 Assigning zeroes and the gonality sequence	106
17.4 A conjecture about fullness	111
17.5 Potential counterexamples to Gabard 2006 ($\gamma \leq r + p$)	114
17.6 Brill-Noether-type (extrinsic) approach to Ahlfors via total reality . .	116
17.7 Extrinsic significance of Ahlfors theorem	118
17.8 The gonality spectrum	121
17.9 More lowbrow counterexamples to $\gamma \leq r + p$	122
18 Some crazy ideas about gravitation and unification of forces	123
18.1 From gravitation to electrodynamics	123
18.2 Total reality in the Harnack maximal case	134
18.3 A baby pseudo-counterexample in degree 4	144
18.4 Low-degree circle maps in all topological types by Harnack-maximal reduction	145
18.5 Experimental evidence for Coppens' gonality	146
18.6 Minimal sheet number of a genus g curve as a cover of the line	150
18.7 Heuristic moduli count to justify Ahlfors or Gabard (Huisman 2001) .	153

18.8 Other application of the irrigation method (Riemann 1857, Brill-Noether 1874, Klein, etc.)	155
18.9 Another application: Complex manifolds homeomorphic to tori	156
18.10 Invisible real curves (Witt 1934, Geyer 1964, Martens 1978)	156
18.11 The three mapping theorems (Riemann 1857, Ahlfors 1950, Witt 1934)	157
18.12 The gonality profile, moduli strata and the Ahlfors space	159
19 Existence of Ahlfors maps via the Green's function (and the allied Dirichlet principle)	163
19.1 Digression on Dirichlet (optional)	165
19.2 From Green to Riemann	167
19.3 The Green's function	167
19.4 Quasi-negativity of Green	169
19.5 Killing the periods	170
19.6 Extra difficulties in the surface case	170
19.7 The Green's function of a compact bordered Riemann surface=CBRS	172
19.8 Schwarz's alternating method to construct the Green's function of a compact bordered surface (Nevanlinna's account)	173
19.9 From Green to Gromov? (directly bypassing Riemann and Löwner) . .	176
19.10 Schoenflies via Green?	177
19.11 Green, Schoenflies, Bergman and Lu Qi-Keng	177
19.12 Arithmetics vs. Geometry (Belyi-Grothendieck vs. Ahlfors)	178
20 Ahlfors' proof	179
20.1 The core of Ahlfors' argument	181
20.2 Geometric interpretation as dipoles	184
20.3 Trying to recover Ahlfors from the Red's function	186
20.4 Strip mappings (Nehari, Kuramochi)	191
21 Hurwitz type proof of Ahlfors maps?	191
22 Synoptic tabulations	192
22.1 Nomenclature project	193
22.2 Dissidence from Ahlfors	194
22.3 Acknowledgements	196
23 Bibliographic comments	196

1 Introduction

Preliminary Warning. [13.11.12]—Despite its exorbitant size, the actual mathematical content of the present text is very limited. It focuses primarily on the Ahlfors map. Neither does our work has the pretence of being the logical sum of all knowledge accumulated in the past, nor to give an accurate picture of real developments taking shape contemporaneously. Our intention was rather more to delineate a reasonably clear-cut perception of the early branches of the theory as to understand objectively the basic truths making Ahlfors theorem possible. Failing systematically, our pretence converted to that of throwing enough obscurantism over the whole theory as to motivate others to shed fresh lights over the edifice. Even the primary contribution to the field (that of Ahlfors 1950 [17]) has not yet been fully assimilated by the writer (compare optionally Section 20 for our fragmentary comprehension). We strongly encourage mathematicians having a complete mental picture of Ahlfors proof to publish yet another account helping to clarify the original one. We hope during the next months (or years) to be gradually able to improve the overall organization of this text, in case our understanding of classical results sharpens. All of our ramblings starts essentially in the big-bang of Riemann's thesis. It looks almost a triviality alike to expect that subsequent developments of the theory will involve a deeper interpenetration between the conformal and algebro-geometric viewpoints. One oft encounters in the field problems requiring serious combinatorial skills or geometric intuition. For instance how does the moduli space of bordered surfaces stratifies along gonality; Section 18.12 guesses some scenarios

via primitive methods. Riemann surfaces or the allied projective realizations offer an ornithological paradise requiring patience and observational skills from the investigator. This is especially stringent when the complexes are traded against the real number field, and inside this universe of $3g - 3$ real dimensions one encounters with probability $1/3$ the so-called real orthosymmetric curves of Felix Klein (1876–1882) subsumed to the paradigm of *total reality*. This little third is actually all what our topic of the Ahlfors map is about. Last but not least, experimental studies point to a large armada of potential counter-examples menacing the improved bound $r + p$ announced in Gabard 2006 [255]. It seems safe to declare as an open problem to either corroborate this bound (via other more analytic or algebraic treatments) or to disprove it.

This is a prejudiced survey on the Ahlfors (extremal) function and (improvising terminology) the weaker *circle maps*, effecting the conformal representation upon the disc of an arbitrary differential-geometric membrane, alias *compact bordered Riemann surface*. Our jargon, borrowed from Garabedian-Schiffer 1950 [279], translates essentially the term *Kreisabbildung* used e.g., by Koebe 1915 [464] and Bieberbach 1914 [92].

Exciting works by Yamada 1978–2001 [894], [897], Gouma 1998 [297] and Coppens 2011 [183] suggest that fewer sheets than required in Ahlfors’ era is expectable, for a clever placement of the basepoint(s) required to pose the extremal problem. E.g., is Coppens’ (absolute) gonality of a membrane always sustained by an Ahlfors function? We also started tabulating a list of known applications in the hope of guessing future ones. Some applications (e.g. Fraser-Schoen’s recent one to Steklov eigenvalues [249]) do not require the full punch of Ahlfors’ extremals, raising the hope that the improved control $r + p$ on the degree of circle maps (predicted in Gabard’s Thesis 2004/06 [255] for surfaces of genus p with r contours) could imply some ‘automatic’ upgrades (e.g. in the corona problem with bounds, as studied by Hara-Nakai 1985 [333]).

As to the foundation of the Ahlfors mapping theory itself, the issue that the naive qualitative approach (used in Gabard 2004/06 [255]) affords a bound, $r + p$, quantitatively stronger than Ahlfors’ original $r + 2p$ is somewhat surprising. It results a certain psychological tension between topological and analytical methods, which hopefully is just a superficial and temporary state of affairs destined to disappear after renewed examination of Ahlfors’ argument. The latter seems indeed to leave some free manoeuvring room, in its ultimate convex geometry portion (cf. Section 20 for some strategy).

It is our partisan belief that much remains to be clarified both historically and logically in the theory of the Ahlfors map. Albeit sembling a retrograde attitude, it is probably not since Ahlfors bound $r + 2p$ certainly fails sharpness, at least for low values of the invariants (r, p) . (Consider for instance the topological type of Klein’s Gürtelkurve; i.e. $(r, p) = (2, 1)$ where a projective realization (of the Schottky double) as a plane quartic with 2 nested ovals prompts existence of a total map of degree 3 via projection from the inner oval. This beats by one unit Ahlfors’ bound $r + 2p = 4$.) Apart from an abrupt claim by Teichmüller 1941 [826], that everything (safe bounds) is to be found in Klein (what the writer was unable to certify from printed evidence), it is fair to admit that the bulk of the theory crystallized right after World War II. Several workers like Ahlfors 1948/50 [17], Matildi 1945/48 [536], Andreotti 1950 [45], Heins 1950 [358] (perhaps even Courant 1939/40 [191], not to mention Grunsky 1937–40–41–42 [315], one of the most brilliant protagonist albeit his work looks confined to the genus 0 case) offered quite overlapping conclusions. It seems fair however to give full credit to Ahlfors for having first expressed the story in the most clear-cut fashion. Quite shamefully, I confess that Ahlfors argument still escapes me slightly. A non-negligible amount of literature is devoted to reproving Ahlfors’ theorem: Heins 1950/75/85 [358] [361] [363], Garabedian 1950 [277], Kuramochi 1952 [487], Read 1958 [676] (student of Ahlfors), Mizumoto 1960 [564] (topological methods), Royden 1962 [716] (Hahn-Banach like Read), Forelli 1979 [246] (extreme points and Poisson integral), Jenkins-Suita

1979 [393] (Pick-Nevalinna viewpoint), just to name those authors addressing the positive genus case ($p > 0$).

Another promising route is Meis' work 1960 [541] validating Riemann's (semi)intuition of the $[(g + 3)/2]$ gonality of closed genus g surfaces via some Teichmüller-theoretic background. It is likely that Meis's approach is transmutable to the bordered setting, reassessing thereby Ahlfors' result (probably even with the sharp bound $r + p$ in case the latter is reliable). To put it briefly, it seems that the Grötzsch-Teichmüller mode-of-thinking (of the *möglichst konform* mapping) has not yet fully penetrated the paradigm of the Ahlfors circle map, more generally that of branched coverings, except of course in Meis's memoir (alas notoriously difficult to access). Dually, it also seems desirable to reprove the Riemann-Meis bound via topological methods (e.g. that used in Gabard 2006 [255], which perhaps is nothing else than Riemann's parallelogram method). Poincaré's "Analysis Situs" (1895) invented "homology" (modulo the Riemann-Betti=Brioschi [sic!] heritage) with precisely function theory (Abelian functions) as one of the key motivation (beside celestial mechanics and the like). This jointly with the subsequent work of Brouwer gives the basic theoretical background required for implementing such topological methods.

User guide.—This draft is a preliminary version, so avoid printing it for environmental reasons. A list of hopefully clear-cut questions is given in Section 1.4. This is intended to challenge investigators. Several synoptic diagrams scattered as figures through the text should permit a quick optical scan of the whole content. More specifically, those includes:

- an *exhaustive* list (Fig. 3) of *all* articles supplying a proof of Ahlfors theorem (existence of circle maps),
- a list of keywords (Fig. 4) tabulating concepts traditionally related to the Ahlfors map,
- a comprehensive map (Fig. 60) of authors involved in the theory (at least those cited in the bibliography).

This essay, as already said, contains no original insights, instead a series of attempts to contemplate the theory from different angles. A commented bibliography (of ca. 900 entries) tries to brush a panorama of trends related to the Ahlfors map. This includes topics like Riemann surfaces, algebraic curves, conformal mapping, potential theory, Green's functions, Bieberbach's least-area map interpretation of the Riemann map, Bergman and Szegő kernels, minimal surfaces, spectral theory, analytic capacity, removable singularities, corona problem, operator theory, Gromov's filling conjecture, etc.). We have not attempted to reach any overwhelming mathematical density, but rather tried to dilute through historico-philosophical anecdotes.

There is some interplay between Ahlfors maps and total reality of Klein's orthosymmetric curves which gives rise to the gallery of pictures mentioned in the abstract. For a tourist view, browse the string of figures starting from Fig. 21 up to Fig. 34. For "do-it-yourself" purposes, it is probably more valuable to describe the general recipe used to manufacture such pictures. Take any configuration of simple objects like lines and conics, and smooth it in an orientation-preserving sense to get a dividing curve (one is free to keep certain nodes unsmoothed). (Rohlin's eminent student Thomas Fiedler (1981 [235]) ensures for us that the smoothed curve is dividing, alias orthosymmetric in the sense of Klein.) According to Ahlfors theorem there must be a totally real pencil of auxiliary curves cutting only real points on the given curve (plus maybe some imaginary conjugate basepoints). Geometric intuition usually tells us where to locate such a total pencil, roughly by assigning basepoints among the *deepest* ovals (in the sense of D. Hilbert's 16th Problem). Albeit this is just a Plato cavern style extrinsic manifestation of Ahlfors theorem the possibility of finding always such a total pencil reveals strikingly (in our opinion) some of the depth of Ahlfors theorem. (Incidentally it is not to be excluded that a deep understanding of extrinsic algebraic geometry (say à la Brill-Noether) could reprove the full Ahlfors theorem from within the Plato cavern.) In philosophical terms, *real orthosymmetric curves behave on the reals as if they were complex*

varieties: all intersections prompted by Bézout are visible over the reals. This phenomenon is what we (and others, e.g. Geyer-Martens 1977 [290]) call the paradigm of *total reality*. It seems evident that a global study of such pencils bears some close connection with Poincaré index theory, foliations à la Poincaré-Kneser-Ehresmann-Reeb, etc., and that both experimentally and theoretically much remains to be explored along the way. In particular we failed to make such totally real pictures for an M -quintic (Section 18.2). This could be a challenging problem of computer visualization.

As to our speculation about a mechanical interpretation of the Klein-Ahlfors theory of real orthosymmetric curves (and the allied totally real maps) in terms of gravitational systems, see Section 18. This posits a broad extension of Kepler’s planetary motions around ellipses. Of course if such a grandiose connection between Klein-Ahlfors and Kepler-Newton-Coulomb-Poincaré is not verifiable, this may just be interpreted as a metaphoric language describing the dynamics of totally real morphisms prompted by Ahlfors theorem. In fact rather than mere gravitation, it is really a “*dynamique de l’électron*” which seems to be involved; for a toy example on the Gürtelkurve compare Fig. 23.

1.1 Trying to wet some appetite out of the blue

A long time ago (ICM 1908 Rome), Poincaré argued that in mathematics we need a strong principle of economy of thoughts by conceptualizing such notion as ‘uniform convergence’ as if the sole naming of the concept would spare us repeating long intricate arguments. On the other hand, Felix Klein, asserted boldly “die Franzosen unhistorisch wie Sie sind” (exercise recover the source) and liked the motto “Zurück zur Natur, sie bleibt die größte Lehrmeisterin”. Beside all those psychological tips of the masters of geometrization, we can safely agree with both of them that science requires—as a matter of conciliating the principle of economy with that of historical continuity (of course not so structurally incompatible as neo-expressionism seems to assess) —a certain amount of respectfulness about wisdoms accumulated during the past. This explains our ca. 900 references (albeit the explosion was mainly caused by my lack of internet connection occasioning a manual references chasing).

In these notes we propose a (poorly guided) tour of some geometric function theory (GFT). The field is an old fashioned one, lying quite dormant with its old mysteries and legends (e.g., Koebe’s Kreisnormierungsprinzip, the exact determination of the Bloch constant in quasi-stagnation since Ahlfors-Grunsky 1937 [15], etc.). Function-theory seems a volcano alike awaiting anxiously the next explosive eruption, whose pyroclastic rejections turned out to act (in the past at least) as a powerful fertilizer over neighbouring areas (like Riemannian and algebraic geometry, spectral theory, etc.). Actually Koebe had a more picturesque description, when proclaiming (in September 1921, Jena, Jahresversammlung der DMV¹): “Es gibt viele Gebiete in der Mathematik, wo man sich durch Entdecken neuer Ergebnisse verdient machen kann. Es sind meistens lange und steile Gebirgshänge für meckernde Ziegen. Die Funktionentheorie ist aber mit einem saftigen Marschland zu vergleichen, besonders geeignet für dickes Rindvieh!”

The field itself (GFT) seems to be a strange cocktail of qualitative-flexible versus quantitative tricks, or as Gauss puts it *geometria situs* versus *geometria magnitudinis*. If topological methods look a priori quite foreign to the discipline, it was probably Riemann who first revealed:

- the reactivity of the underlying topological substratum (anticipated maybe by Abel 1826 [2], who first introduced the *genus* (under a different name and the transcendant disguise of differentials of the first kind). [The word *Geschlecht* is first coined in Clebsch 1865 [177, p. 43]; and the allied *Geschlechtsverkehr*² must

¹Source=H. Cremer, Erinnerungen an Paul Koebe, Jahresber. DMV, 1968, p.160. (Mitteilung von Heinrich Behnke).

²For more historical details on the theory of quasiconformal mappings compare Ahlfors 1984 [26] or Lehto 1998 [501]. [02.10.12] Alas we were not as yet able to show any deep

have originated about the same period]

- the amazing plasticity (inherited from potential theoretic considerations) of 2D-conformal mappings, leaving out moduli spaces of finite dimensionality after conformal evaporation of all metrical incarnation of a given surface. [Gromov wrote in 1999 [306]: *Shall we ever reach spaces beyond Riemann’s imagination?*]

Our text will soon be biased toward a single obsession, the so-called *Ahlfors function*, which is one (among several other possible) generalisation of the *Riemann mapping theorem* (RMT) to configurations of higher topological structure than the disc. Such configurations (compact bordered surfaces) are topologically determined by the number r of boundary contours and the genus p (number of handles) (see Fig. 1a), as is well-known since the days of Möbius 1860/63 [565] and Jordan 1866 [401] (and of course very implicit in all of Riemann’s work).

simply-connected	multiply-connected (schlichtartig)			<p>Fig. 1 a) compact bordered Riemann surface p genus (here 2) r many boundary contours (here $r=4$) Ahlfors 1950 degree $r+2p$ Gabard 2004-06 degree $r+p$</p>	
	circular domain (kreisförmig) Riemann 1857-76	Schottky 1875-77 Bieberbach 1925 Grunsky 1937-41	Grunsky 1940-42-50 Ahlfors 1947		
<i>Method</i>	Dirichlet principle, potential theory and algebraic functions	Dirichlet principle, potential theory and algebraic functions	Extremal problem (maximizing the modulus of the derivative at some point)	elementary vs. extremal Euler-Lagrange, etc.	
<i>Inspiration</i>	out of the blue (electrical equilibrium)	Dissertation (Berlin 1875) under Weierstrass (yet not inspired by Riemann’s Nachlass)	Koebe-Carathéodory-Fejér-Riesz-Ostrowski elementary proof of RMT via normal families	Schottky differentials Cartan’s differential forms, Stokes, etc.	Schwarz, Bergman, Schiffer, Garabedian Heins 1950-75-85 Kuramochi 1952 Read 1958 Royden 1962 Forcellì 1979
<i>Subsequent works</i>	Schwarz 1870 Weierstrass 1866/70 Hilbert 1900 Perron 1923	Edited by Heinrich Weber 1876 Courant 1939 Wirtinger 1942 A. Mori 1952 Tsuji 1955	S. Ya. Havinson, Fisher, Bell, etc.	Mizumoto 1960	Klein 1876-82 dividing=orthosymmetric real algebraic curve Coppens 2011 sharpness of the bound $r+p$
<i>Applications</i>	Gleichgewicht der Electricität (sketchy and cryptical)		Painlevé’s problem, analytic capacity, etc.	Kusunoki 1952 (type problem) Alling 1964 (Corona) Hara-Nakai 1985 (corona with bounds) Fraser-Schoen 2011 Steklov eigenvalues, plus other or higher eigenvalues (Gabard, Girouard-Polterovich)	

Figure 1: Schematic evolution of some mapping theorems: from Riemann to Ahlfors transiting via Schottky-Bieberbach-Grunsky

The possibility of mapping any bordered surfaces to the disc conformally was pioneered by such towering figures as:

- Riemann 1857/76 [689] (manuscript not published during his lifetime), in which circular domains (hence $p = 0$) of finite connectivity are mapped upon the disc. This fragment was edited by H. Weber and appeared in print only in 1876 in the first edition of Riemann’s Werke. The date of 1857 follows some oral tradition (Schwarz-Schottky), compare Bieberbach 1925 (Quote 6.1 below), but conflicts slightly with Summer 1858 as estimated by Klein (cf. Quote 6.7). [11.08.12] To pinpoint more about the exact date, should we recall that Riemann himself reports in the introduction of “Theorie der Abel’schen Functionen” 1857 [687, p.116] his involvement with the topic of conformal mapping of multi-connected “surfaces” (Flächen) right after his thesis (Fall 1851–Begin 1852), but was then sidetracked to another subject (*ward aber dann durch einen andern Gegenstand von dieser Untersuchung abgezogen*).

- Schottky 1875–77 [763] (=Dissertation under Weierstrass, Berlin, 1875), where a similar mapping is obtained for general real analytic contours. At first sight, it is natural to speculate that Schottky knew about Riemann’s Nachlass, but Schottky himself describes his trajectory as independent of Riemann’s work

connection between the theory of Ahlfors circle maps and that of quasiconformal maps, yet it is not unlikely that such a connection is worth studying, more in Section 1.4.

(cf. Quote 6.3). Apparently, it was Weierstrass' special pupil, namely H. A. Schwarz who made Schottky aware of this connection, as reported in Bieberbach 1925 [97])—compare Quote 6.1. Albeit independent of Riemann's, Schottky's work was likewise physically motivated (as emphasized by Klein 1923 [443, p. 579]=Quote 6.7 below, or via Schottky's own recollection (1882) (Quote 6.3)).

- Bieberbach 1925 [97], found some elementary arguments (or just modernization) of the same Riemann–Schottky result, while emphasizing the trivial fact that the degree bound is optimum (apparently Schottky gave no bound),

- Grunsky 1937–41 [315, 316], 1940–42–49 [317, 318, 320], who in a first series of papers rederived Bieberbach's result and then switched to an extremal interpretation of the mapping problem. This terrible quantitative/competitive weapon (with historical precedents to be soon discussed) culminated, finally, in:

- Ahlfors 1947 [16], but it remained until Ahlfors 1950 [17], to prove a generalization capable of including positive genera ($p > 0$), superseding thereby quite dramatically the planarity (Schlichtartigkeit) where all previous efforts were perpetuated. (We shall attempt to ponder this absolute originality of Ahlfors, by comparing with others writers (e.g., Courant), but only with limited success due to my moderate competence with minimal surfaces and Plateau.)

For an overall picture of the roots plus some ramifications of Ahlfors, the reader may glance at the following map showing some of the links we are going to explore in this survey. We have opted for a Riemann surface style depiction of this histogram so as to give a quick-view of the varied *troncs vivaces* (in A. Denjoy's prose when alluding to history of mathematics). Such trunks or handles are attached whenever some philosophical dependence (citation) is detected. Alas, it resulted a prolific accumulation of links creating a somewhat chaotical picture. For sharper pictures of the “Riemann galaxy”, we recommend Neuenschwander 1981 [598], Gray 1994 [300] and Remmert 1998 [680].

Caveat.—The own contribution of the writer (Gabard 2006 [255]) predicting an improved control $r + p$ upon Ahlfors' degree $r + 2p$ is enormously exaggerated, especially if it turns out to be false. Other distortions only reflects the writer's poor understanding of this tentacular topic. For a more extensive compilation of authors involved in the theory, cf. Fig. 60. If you are not cited on it, please send me an e-mail.

As already said, our central hero will be Ahlfors, especially his paper of 1950 [17]. In retrospect, it is not quite impossible that Riemann himself (or disciples like Schwarz, Klein, Koebe, Hilbert, Grötzsch, Teichmüller, etc., or also Bieberbach, Grunsky, Wirtinger, Courant, and not forgetting in Italy, Cecioni, Matildi 1945/48 [536], Andreotti 1950 [45]) could have succeeded in proving such a version. Such speculations look not purely science-fictional especially in view of Ahlfors' elementary argument in [17, pp. 124–126], which involves primarily only classical tricks (no deep extremal problem), like annihilating all the periods to ensure single-valuedness of the conjugate potential, and basic potential functions arising from the Green-Gauss-Dirichlet era. All these tricks are standard since Riemann's days (cf. e.g. Riemann 1857 [687, p. 122], “*so bestimmen daß die Periodicitätsmoduln sämtlich 0 werden.*”). Remember also, despite sembling dubious historical revisionism, that Teichmüller 1941 [826](=Quote 7.1) seems to have possessed a clear-cut conception of the result at least without precise bound, while ascribing the assertion even to Klein.

However it took ca. 91 years—say from Riemann's 1857/58 Nachlass up to the 1948 Harvard lecture held on the topic by Ahlfors, cf. Nehari's Quote 11.3 of 1950—until somebody puts it on the paper and it turned out to be no less an authority than Lars Valerian Ahlfors.

It is true that Ahlfors moved in considerably deeper waters by solving as well a certain *extremal problem*. This extremal viewpoint is more punchy, yet arguably the corresponding extremals (so-called Ahlfors functions) are only circle maps of a special character. We gain in punch but loose in flexibility. The extremal functions do not substitute (nor are substituted) by circle maps. Deciding which viewpoint is more useful is another question, probably premature to answer except for guessing a complementary nature depending on the problem at hand. Incidentally in Ahlfors paper, existence of circle maps is required

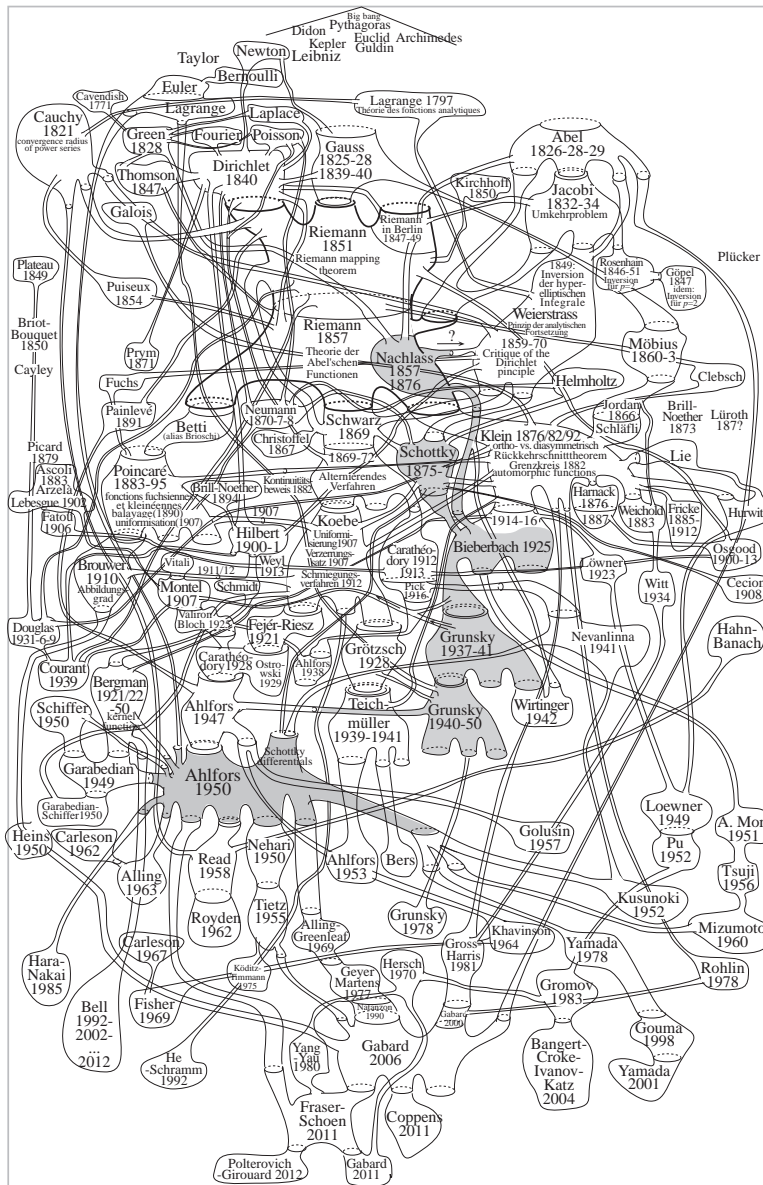

Figure 2: A free-style depiction of the Ahlfors-map theory as a Riemann surface

as a preliminary step toward posing (non-nihilistically) the extremal problem. Ahlfors' extremal problem stemmed surely not out of the blue, but patterned along a tradition, whose first steps should probably be located in the following works. (We acknowledge guidance by Remmert's book 1991 [679, p. 160–2, p. 170–2], to which we refer for sharper historical details.)

- Koebe's elementary proof 1907, 1909, 1912 [460], 1915 [464] of the (RMT); (*Quadratwurzeloperationen*, *Schmiegunungsverfahren*, etc.)
- Carathéodory 1912 [138]: similar iterative methods and convergence of his sequence via Montel's theorem. This revitalized Koebe's interest (cf. again Remmert's description [679, p. 160, p. 172]); in Carathéodory 1914 [141] full details of the method were given in the Schwarz-Festschrift;
- Fejér and F. Riesz 1922 obtain the Riemann mapping via an extremal problem for the derivative (published in Radó 1922/23 [666]). Montel's normal families are also used, plus a tedious derivative computation eradicated in:
- Carathéodory 1928 [144] and Ostrowski 1929 [626], where (independently) ultimate simplifications are provided.

Carathéodory (1928), wrote about these developments:

Quote 1.1 (Carathéodory 1928 [144, p. 300]) Nachdem die Unzulänglichkeit des ursprünglichen *Riemannschen* Beweises erkannt worden war, bildeten für viele Jahr-

zehnte die wunderschönen, aber sehr umständlichen Beweismethoden, die *H. A. Schwarz* entwickelt hatte, den einzigen Zugang zu diesem Satze. Seit etwa zwanzig Jahren sind dann in schneller Folge eine große Reihe von neuen kürzeren und besseren Beweisen [von ihm selbst und von Koebe (Remmert's addition); in the original Lindelöf 1916 is also quoted] vorgeschlagen worden; es war aber den ungarischen Mathematikern *L. Fejér* und *F. Riesz* vorbehalten, auf den Grundgedanken von *Riemann* zurückzukehren und die Lösung des Problems der konformen Abbildung wieder mit der Lösung eines Variationsproblems zu verbinden. Sie wählten aber nicht ein Variationsproblems, das, wie das *Dirichletsche* Prinzip, außerordentlich schwer zu behandeln ist, sondern ein solches, von dem die Existenz einer Lösung feststeht. Auf diese Weise entstand ein Beweis, der nur wenige Zeilen lang ist, und der auch sofort in allen neueren Lehrbüchern aufgenommen worden ist. [Footnote 2: Siehe *L. Bieberbach*, Lehrbuch der Funktionentheorie, Bd. 2 S. 5.] Mein Zweck ist nun zu zeigen, daß man durch eine geringe Modifikation in der Wahl des Variationsproblems den *Fejér-Rieszchen* Beweis noch wesentlich vereinfachen kann.

Let us quote thrice Ahlfors in this connection (the second of which occurred while celebrating the centennial of Riemann's Thesis, 1851):

Quote 1.2 (Ahlfors 1961 [23, p. 3]) In complex function theory, as in many other branches of analysis, one the most powerful classical methods has been to formulate, solve, and analyze extremal problems. This remains the most valuable tool even today, and constitutes a direct link with the classical tradition.

Quote 1.3 (Ahlfors 1953 [19, p. 500]) Very important progress has also been made in the use of variational methods. I have frequently mentioned extremal problems in conformal mapping, and I believe their importance cannot be overestimated. It is evident that extremal mappings must be the cornerstone in any theory that tries to classify conformal mappings according to invariant properties.

Quote 1.4 (Ahlfors 1958 [21, p. 3]) Es ist mir zugefallen, eine Übersicht über die Extremalprobleme in der Funktionentheorie zu geben. Seit der Formulierung des Dirichletschen Prinzips ist es klar gewesen, dass die Cauchy-Riemannschen Gleichungen nichts anderes sind als die Eulerschen Gleichungen eines Variationsproblems, und in diesem Sinne ist alle Funktionentheorie mit Extremaleigenschaften verbunden. Aber es ist nicht immer von vornherein klar, wie diese Probleme gestellt werden sollen, damit sie in wesentlicher Weise die tiefen Eigenschaften der analytischen Funktionen abspiegeln. Es gibt natürlich unzählige Maximaleigenschaften, etwa in der konformen Abbildung, die ganz nahe an der Oberfläche liegen. Von da aus soll man zu schwierigeren Problemen aufsteigen. Das geschieht nicht etwa so, dass man ein beliebiges, wenn auch verlockendes, Extremalproblem ins Auge fasst und es zu lösen versucht. Im Gegenteil, die Entwicklung ist so vor sich gegangen, dass man die Aufgaben stellt, die man lösen kann. Dadurch ist ein reiches Erfahrungsmaterial entstanden, und die Aufgabe des heutigen Funktionentheoretikers besteht darin, dieses Material zu klassifizieren und dadurch weiter zu entwickeln.

[... , and on page 7, of the same philosophical paper]

Carathéodory sagte einmal, dass er immer wieder zur Funktionentheorie zurückkehrt, weil man gerade dort die verschiedensten und verblüffendsten Methoden verwenden kann. Das ist sicher wahr, und eben deshalb ist die Funktionentheorie kein eng spezialisierter Zweig der Mathematik. Im Gegenteil, die Funktionentheorie scheint fast wie ein Miniaturbild der gesamten Mathematik, denn es gibt kaum eine Methode in der Geometrie, der Algebra und der Topologie, die nicht früher oder später in der Funktionentheorie wichtige Anwendung findet. [...]

Such wisdoms cultivating the extremal philosophy—in particular as a growing mode for conformal mappings—presumably capture the deepest telluric part of the mushroom, out of which everything derives effortlessly. Alas, our survey is far from this ideal conception. In fact, we would be quite challenged if we were demanded to list a single application of Ahlfors' extremal property, except of course in the planar case where one can easily mention all the activities centering around Painlevé's problem.

1.2 Applications

The writer’s interest in the topic was recently revived by the article of Fraser-Schoen 2011 [249], where the Ahlfors function received a clear-cut interaction with spectral theory (Steklov eigenvalue) with a view toward minimal surfaces.

At a more remote period in the early 1950’s, when classification theory of open Riemann surfaces was a hot topic (especially in the Finnish and Japanese schools), Kusunoki 1952 [488] proposed an application to the type problem, in the analytic sense of Nevanlinna’s Nullrand (null boundary). A (somewhat misleading but frequently used) synonym is *parabolic type* (not to be confused with the geometric sense of uniformization theory). This (analytic) sense of parabolicity is the one related to the transience of the Brownian motion (Kakutani, etc.)

In view of the extremal role played by the (round) hemisphere as a vibrating membranes (compare Hersch 1970 [372], and less relevantly Gabard 2011 [256]), the author speculatively expected—yet failed dramatically to establish (Summer 2011)—the following:

Conjecture 1.5 (Gabard, April 2011, ca. 300 pages of sterile hand-written notes, unpublished) *There is a mysterious connection between the Ahlfors function and the (still open) filling area conjecture (FAC) of Gromov 1983 [305], whose genus zero case follows from the thesis of Pu 1952, under Loewner 1949. More precisely, the filling area conjecture is true for all genus $p \geq 0$, and the proof will employ an Ahlfors map, at least as one of the ingredients [others being Schwarz’s inequality, and group theoretical tricks à la Hurwitz–Haar–Loewner like in the $p = 0$ case]. The basic link is of course that conformal maps supply isothermic coordinates, yielding a way to compute areas via the infinitesimal calculus (of Newton–Leibniz, etc.).*

The best available result on FAC is still the hyperelliptic case handled by Bangert–Croke–Ivanov–Katz 2004 [58], implying the full conjecture for $p = 1$ (as in this case the double is of genus $g = 2$, hence automatically hyperelliptic).

The above “Ahlfors \Rightarrow Gromov” conjecture flashed my attention, after completing the note (Gabard 2011 [256]) in view of the striking analogy between the isoperimetric role of the hemisphere both acoustically (spectral theory, like in Hersch 1970 [372]) and in the geometric sense of the Löwner–Pu–Gromov isosystolic (\approx filling) problem. Of course this analogy is already explicit in Gromov 1983 [305], where Hersch 1970 (*loc. cit.*) is cited. (Incidentally, Gromov’s account also let play to Jenkins, Ahlfors’ student and Grötzsch’s admirator, a predominant logical role via the notion of “extremal length”.) After more immature thinking (August 2012), it seems safer to formulate a relaxed version of the conjecture where the impulse does not necessarily come from the Ahlfors map but from some more ancestral source like the Green’s function (or the allied Gauss–Riemann isothermic coordinates). Also the (Lorenz-)Weyl’s asymptotic law enabling to “hear” the area of a drum from high vibratory modes could be involved as well in FAC. When Marcel Berger describes Gromov’s systolic exploits (1983 *loc. cit.*), he insinuates (surely with right) of them as lying at a much higher level of sophistication than 2D-conformal geometry (à la Gauss–Riemann, etc.). This acts as an optimism killer against anything like the above conjecture. Of course the above conjecture or its relaxed variant “Conformal \approx Isothermic \Rightarrow Gromov” is far from prophetic, only the expectation that the traditional methods (conformal theory and uniformization) which worked for low-genus cases will extend soon or later to $p \geq 2$. Yet, who knows? Remember that even Marcel Berger, once validated (or at least quoted) an erroneous proof (ca. 1998) of the 2D-case of the filling conjecture in question. Compare his brilliant “Panoramic view”, or rather his likewise excellent survey in JDMV.

Of course, probably no better guide than Ahlfors himself for listing applications of his method would have been desired. Alas it seems that the latter was suddenly sidetracked in the stratosphere of Teichmüller theory in the early

1950's, leaving the Ahlfors function theory in some standby "in absentia". An exception is the later paper Ahlfors 1958 [21], where Ahlfors discusses again extremal problems, though in a more philosophical way. Also the work of his student Read 1958 [676] is described, which supplies another existence-proof of circle maps via a more abstract viewpoint (Hahn-Banach) inspired by other work like Macintyre-Rogosinski 1950 [521], Rogosinski-Shapiro 1953 [704], Rudin, etc. This Teichmüller shift in Ahlfors activities seems to coincide with the 100 years celebration of Riemann's thesis (in 1951), where L. Bers comes up with his list of urgent questions about Riemann surfaces. As a partial consolation, Grunsky worked out a brilliant book (1978 [322]) where much of the historical continuity is supplied.

Quoting some first-hand sources.— We shall have to reproduce several quotations from primary sources as an attempt to observe the mutual influences among the variety of viewpoints. It resulted some inflation in size, but hopefully excusable as the information of some relevance to our topic is otherwise dispatched through a vast amount of literature. Those are given in the self-explanatory format **Quote (Author, year)**.

Broad-lines organization of the sequel.—We shall essentially touch the following aspects (all in reference to the Ahlfors mapping):

- (1) Origins, background: prehistory of Ahlfors (Section 6); potential precursors (Section 7);
- (2) How the writer came across this topic? (via Klein); cf. Sections 2 and 3;
- (3) Potential theory vs. extremal problems (both from the same variational soup);
- (4) Applications (Section 15): equilibrium of electricity Riemann 1857, Painlevé's problem, type problem, Carathéodory metric, corona problem, quadrature domains, spectral theory (Steklov or Dirichlet-Neumann);
- (5) Open problems fictionally related to the Ahlfors function (Section 16);
- (6) (Partial) assimilation of Ahlfors or other works (logical reconstruction); via Green in Section 19 and via Ahlfors in Section 20;
- (7) Sharpening Ahlfors work (for circle maps not necessarily subjected to the extremal problem).

Roughly speaking our text splits as follows. A first half is devoted to historical aspects, while a second half (initiated by Section 17 titled "Starting from zero knowledge") is more "logical", or rather liberal and futurist. This second part tries to explore what sort of mathematics lies beyond Ahlfors theorem. Of course it is hard going beyond Ahlfors without having digested his own work, and consequently much energy is spent to the original account. His result affords considerable information, especially the realizability of all gonality lying above Ahlfors bound $r + 2p$. (The *gonality* γ is the least degree of a circle map tolerated by the given bordered surface.) Classically, some penetrations beyond Ahlfors occurred by Garabedian, Heins, Royden, etc., and more recently in the spectacular progresses made by Yamada, Gouma on the extremal function. In the dual direction (of circle maps), Coppens work on the gonality is likewise penetrating deep beyond the line fixed by Ahlfors, and raises several questions of primary importance. This includes that of describing how the moduli space of bordered surfaces (with fixed topological type (r, p)) stratifies along gonality. Calculating dimensions of the varied strata is a first step toward quantifying by how much and how frequently one can expect to improve Ahlfors bound. We obtain so the *gonality profile*, that is, the function assigning to each gonality γ (in the Coppens range $r \leq \gamma \leq r + p$, or outside it in case Gabard is wrong) the dimension of the moduli strata with prescribed gonality $\leq \gamma$ (Section 18.12). Describing this gonality profile appears to me a challenging (but hopefully reasonably accessible) problem. Another "futurist" problem is the one of describing the list of all degrees of circle maps tolerated by a given surface. This we call the *gonality sequence*. It is full above Ahlfors bound $r + 2p$, but what can be said below? These are perhaps two typical kind of problems hinting a what sort of games we may encounter "beyond Ahlfors".

1.3 Bibliographic and keywords chart

The following chart (Fig. 3) focuses on the tabulation of several articles where an existence-proof of Ahlfors circle maps is given. Such items are marked by black circular symbols with eventual decorations. Applications are marked by triangular symbols. All entries of the picture (e.g. “Ahlfors 1950”) can unambiguously be located in the bibliography at the end of the paper. One counts essentially ca. 13 papers addressing the existential question of circle maps.

Those includes: Ahlfors 1950 [17], Garabedian 1950 [277], Heins 1950 [358], 1975 [361], 1985 [363] and in the same spirit Forelli 1979 [246]. Another trend is Nehari 1950 [591] and Tietz 1955 [830] (alas those works are a bit confusing, Tietz criticizes Nehari and is in turn attacked subsequently in Köditz-Timmann 1975 [470]). The latter work (KT1975) actually offers an alternative derivation without bound control. In Japan we have Kuramochi 1952 [487] and Mizumoto 1960 [564]. (One should probably add several works of Kusunoki from the early 1950’s, but those are often confusing with subsequent errata, etc.) Another mouvance is the usage of Hahn-Banach in the papers Read 1958 [676] and Royden 1962 [716]. Finally there is a work by the writer, Gabard 2006 [255], which even prove a better control upon the degree of circle maps. Of course this work should still be better understood and its result should be either disproved or consolidated by alternative techniques.

To this obvious list one can add some more telluric flows or possible fore-runners:

- Teichmüller’s claim (1941 [826]) that everything is already in Klein.
- Courant’s work starting say with Courant 1939 [191] where a Plateau style approach à la Douglas is asserted to reproduce the Bieberbach-Grunsky “schlichtartig” case of Ahlfors.
- Italian workers: Matildi 1945/48 [536] and Andreotti 1950 [45].

Picture of Keywords.—Let us now put Ahlfors 1950 [17] at the center of the universe, while trying to describe the portion of the cosmos visible from this perspective. Picturing in the non-Euclidean crystal, we obtain something like the following picture of keywords (Fig. 4): nebulosity of sidereal dusts gravitating in the immediate neighborhood of the Ahlfors map/function nebula.

1.4 Mathematical questions

In this section we collect questions raised by our text.

- **Klein \Rightarrow Ahlfors?** [reported 04.11.12] Is it possible to reprove existence of Ahlfors circle maps via Klein Rückkehrstheorem (RST)? This paradigm RST may be thought of as a positive genus case of the Kreisnormierung (of Koebe, but implicit in the Latin version of Schottky’s thesis, cf. Klein’s Quote 6.7). Furthermore recall that Riemann (1857 [689]) was able to produce circle maps for domains bounded by circles, and therefore by analogy it seems plausible that Klein’s RST implies (modulo some work à la Riemann) the Ahlfors circle map. Of course Klein himself may not have been able to prove rigorously his RST, but the result was completed via some Brouwer-Koebe techniques ca. 1911/12 [441]. (For slightly more details about this strategy, cf. Section 6.5.)
- **Witt or Geyer \Rightarrow Ahlfors?** Can we reprove the theorem of Ahlfors via a purely algebraic method (say Abel, or Riemann-Roch) as Witt 1934 [892], Geyer 1964/67 [289] or Martens 1978 [526] succeeded to do for the Witt mapping (of 1934)? For more on this, cf. Section 18.10.
- **Plateau \Rightarrow Ahlfors?** Can we reprove the theorem of Ahlfors via the method based on the Plateau problem (as Courant 1939 [191] did for the Riemann-Schottky-Bieberbach-Grunsky theorem, i.e. the schlichtartig case $p = 0$ of Ahlfors). (See Sections 7.4 and 7.5 for historical precedents (i.e., Douglas 1931 [209]), and precise references about contemporary workers attacking related questions (Jost, Hildebrandt, von der Mosel). A closely related historical question is whether the works of Courant does not already contain (more-or-less explicitly) an existence-proof of Ahlfors circle maps.

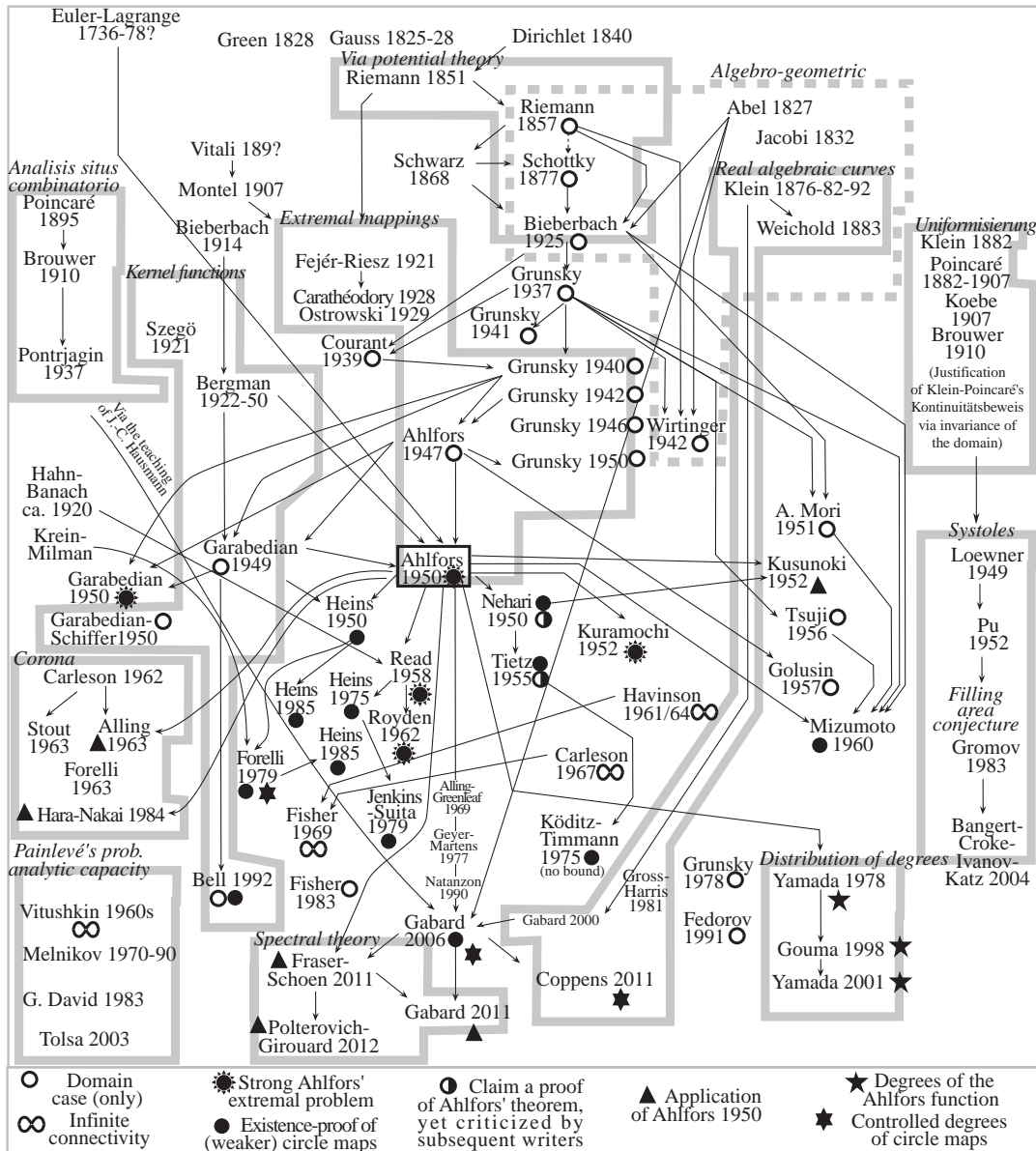

Figure 3: Synoptic chart of articles giving an existence proof of the Ahlfors map (in various forms). Full black-colored circles are those including the positive genus case ($p > 0$).

• **Bergman \Rightarrow Ahlfors?** Idem via the method of the Bergman kernel function. This seems implicit in the literature (say especially by Bell, e.g. Bell 2002 [69], the great specialist of the technique), but to the writer's knowledge no pedestrian account is available to the mathematical public (in the positive genus case). Compare Section 8.1 for some links to the literature. Of course behind Bergman 1922 [75] one finds Bieberbach's characterization (1914 [92]) of the Riemann map via an extremal problem involving least area. This problems should be in some duality with Ahlfors extremal problem, more about this soon.

• **Behnke-Stein \Rightarrow Ahlfors?** [reported 05.11.12] The article (of Köditz-Timmann 1975 [470, Satz 3, p. 159]) seems to contain a qualitative version of Ahlfors' theorem based upon an "Approximationsatzes von Behnke u. Stein", yet without any bound on the degree. Can one improve the argument to get a quantitative control? As to Behnke-Stein 1947/48/49 [62] (the famous paper going back to 1943), it contains the result that any open Riemann surface (arbitrary connectivity and genus) admits a non-constant analytic function. Is it possible conversely to deduce this theorem from Ahlfors theorem by exhaustion while pasting together various circle maps defined over a system of expanding

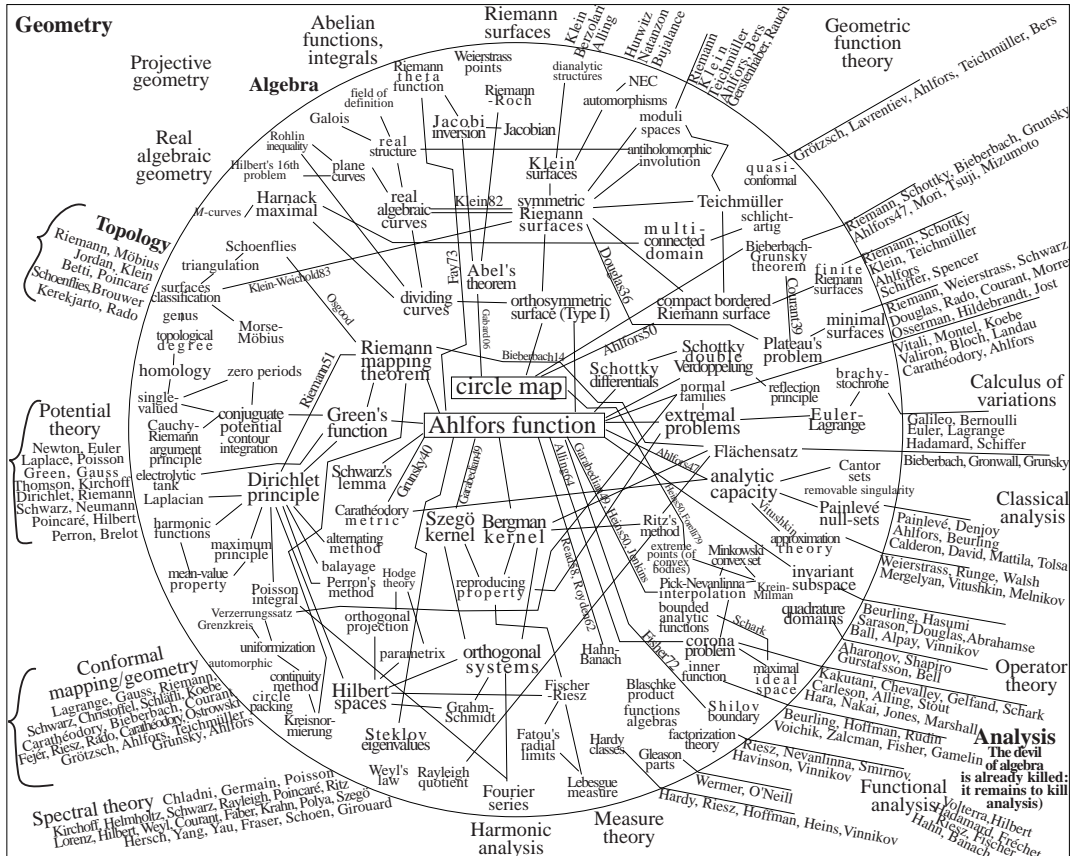

Figure 4: Some of the keywords gravitating around the Ahlfors function

compact subregions?

- **Other techniques?** Koebe's iteration, circle packings (cf. Rodin-Sullivan 1987 [703]), Ricci flow, etc. Virtually any technique involved in the proof of the RMT (=Riemann mapping theorem) or the allied uniformization is susceptible to reprove the Ahlfors circle map.

- **Does Ahlfors implies Ahlfors?** [02.09.12] This repetition is intentional and intended to emphasize that the writer was not able to digest Ahlfors argument in full details (compare Sections 19 and 20). If one remembers the proof of Koebe's Kreisnormierung (say as implemented in Grunsky 1978 [322] or Golusin 1952/57 [296]), then upon making abstraction of Koebe's proof by iterative methods, it may be noticed that ultimately the proof depends on a topological principle (namely Brouwer's invariance of domain). In comparison Ahlfors' proof of a circle map (1950 [17]) makes no use of any topological principle, reducing rather to considerations of convex geometry (cf. Ahlfors 1950 [17]). Should one deduce that the Ahlfors function lies somewhat less deep than Koebe's Kreisnormierung? If not then maybe Ahlfors' argument lacks a global topological character, and perhaps its validity needs to be reevaluated. (Of course this is only a very superficial objection arising from my own frustration in not being able to catch the substance of Ahlfors text.)

- **Does Brill-Noether (+ Harnack's trick) implies Ahlfors?** [26.10.12] Upon using projective models of Riemann surfaces, especially birational models in the plane, it is common practice to understand the geometry on a curve via auxiliary pencils living on the ambient plane. Of particular importance are the so-called adjoint series passing through the singularities of the model which have the distinctive feature of cutting economical series of points on the curve. Such pencils are thus involved in the description of low-degree pencils living on the (abstract) smooth curve, hence morphisms to the line. Adapting this methodology to orthosymmetric curves one can evidently hope to reprove Ahlfors theorem, provided one is able to ensure total reality of the corresponding

morphism. Details look quite formidable to implement. If such a proof exists it will probably be a happy hour for its discoverer. For more vague ideas about this strategy, see Section 17.6.

- **Does Ahlfors implies Gabard?** [09.09.12] Upon using Ahlfors' original argument in [17] for the existence of a circle map of degree $r + 2p$, it seems evident that one could append to Ahlfors argument a sharper geometric lemma which could produce a better control than Ahlfors'. Ideally one would like to recover Gabard's bound $r + p$. For some evidence of why this should be possible compare Section 20.3.

- **Gabard true? If, yes analytifiable?** [June 2012] Is the bound $r + p$ predicted by the writer on the degree of a circle map true? And if yes is it accessible to more conventional analytical methods? Remember that the derivation in Gabard use some topological methods combined with the classical Abel theorem.

- **Gonality profile.** [June 2012] Can we compute the dimension of the moduli spaces of membranes having fixed gonality $\gamma \leq r + p$. (The *gonality* is the least degree of a circle map from the given bordered surface.) The similar question in the case of complex curves is well-known and easily predicted by a simple Riemann-Hurwitz count (but established rigorously much later). Slightly more on this in Section 18.12.

- **Ahlfors extremals as economic as Gabard?** [March 2012] Can the degree of the Ahlfors extremal function be made as economical as $r + p$, the circle map degree predicted by the writer, for a suitable location of the two points required to pose the extremal problem (resp. of a single point when considering the derivative maximizing variant of the problem)?

- **Ahlfors extremals as super-economic as Coppens?** [March 2012] Same question for the sharper (*separating*) *gonality* introduced by Coppens 2011 [183], that is, the minimum sheet-number required to concretize the bordered Riemann surface as a (holomorphic) branched cover of the disc.

- **Topology \Rightarrow Riemann-Meis complex gonality?** [21.06.12] Can the topological method (irrigation) used in Gabard 2006 [255] be adapted to prove that any complex curve of genus g is $\leq [(g + 3)/2]$ -gonal, meaning that there is always a morphism to \mathbb{P}^1 of degree \leq than the specified bound. (Perhaps this is already answered in the lectures of Gunning 1972 [326], who uses Mattuck's topological description of the symmetric powers of the curve).

Conversely, there is a dual problem:

- **Grötzsch-Teichmüller-Meis \Rightarrow Ahlfors-Gabard separating gonality?** [16 June 2012] According to secondary sources (e.g. Kleiman-Laksov 1974 [429]), Meis's proof (1960 [541]) of the complex gonality $\leq [(g + 3)/2]$ of genus- g curves, is eminently Teichmüller-theoretic. By analogy, it should therefore be possible to prove the $(r + p)$ -gonality of membranes (cf. Gabard 2006 [255]) by using the same (Teichmüller-style) method as Meis. This would incidentally give an "analytic" proof (or if you prefer, a "geometria magnitudinis" proof of Gabard 2006 [255]). Notice the fighting interplay between topology and analysis (or geometry) since Teichmüller amounts essentially to the "möglichst konform" map of Grötzsch.)

- [05 June 2012] Ozawa 1950 [629] presents a genuine extension of the Schwarz lemma to multiply-connected domain. Can we do the same job for a membrane of positive genus?

- **Ahlfors \Rightarrow Gromov?** [Mai 2011] Does Ahlfors (or perhaps the non-orientable variant of Witt 1934 [892]) implies Gromov's filling area conjecture? Any solution to this puzzling problem is rewarded by 50 Euros by Mikhail Katz (cf. his home web-page). Perhaps, some other ingredients than Ahlfors are required. We (already) loosely suggested, Weyl's asymptotic law (acoustic proof) or perhaps a sort of duality between "Ahlfors" extremal problem and that of Bieberbach 1914 [92] (more widely known for its connection to Bergman). Added [02.09.12], maybe it is enough to consider the isothermic coordinate generated by a single Green's function (or a dipole avatar) instead of an Ahlfors function.

- **Gromov non orientable** (Easier?) [June 2011] Is the Gromov filling

conjecture also true (and meaningful) for non-orientable membranes? Can it be generalized to several contours (desideratum J. Huisman 2011, oral e-mail communication).

We may also drift to related problems like KNP (Kreisnormierungsprinzip). This asserts that any domain (or planar Riemann surface) is conformally diffeomorphic to a domain bounded by circles (we suppose finite connectivity for simplicity).

- **Extremal problem \Rightarrow KNP?** Inspired by the paper Schiffer-Hawley 1962 [756], where (Koebe's) Kreisnormierung (in finite connectivity) is derived from a minimum problem of the Dirichlet type, one may wonder if a suitable variant of Ahlfors extremal function may not be used to reprove the Kreisnormierung. More about this is Section 13.2 (related to works by Grötzsch, and others.).

- **Bieberbach's (least area) minimum problem.** Bieberbach 1914 [92] considers in a simply-connected domain B the problem of minimizing the integral $\iint_B |f(z)|^2 d\omega$ amongst analytic functions $f: B \rightarrow \mathbb{C}$ normed by $f'(t) = 1$ at some fixed point $t \in B$ of the domain. He shows that the minimum gives the Riemann map. (It is well-known that this problem constitutes the origin of the Bergman kernel theory, cf. besides Bergman's original paper of 1922 [75], e.g. Behnke's BAMS review of Bergman's 1950 book [84].) The naive question is what sort of maps are obtained when this problem is formulated on a multiply connected domain? Do we obtain a circle map? And if yes, does this β -function coincides with the Ahlfors map? Can the problem be extended to Riemann surfaces? More on this is discussed in Section 8. Of course this is closely allied to the Bergman kernel, and was treated by several authors, cf. e.g. Garabedian-Schiffer 1950 [279]. However as far as the writer browsed the literature, the qualitative feature of this β -map appear to have not been explicitly described. In fact it seems that ultimately the answer is a bit disappointing in the sense that the least-area map may lack single-valuedness. This is well-explained in papers by Maschler (1956–59, e.g. [530]), and was probably known earlier by Bergman, Schiffer, etc.

- **Heins's proof?** [28.06.12] Heins 1950 [358] seems to suggest another proof of the existence of a circle map à la Ahlfors, by using some theory of Martin and concepts from convex geometry (minimal harmonic functions and extreme points of convex bodies). Unfortunately, he does not keep a quantitative control upon the degree of the map so obtained. However, on p. 571 Heins introduces the number m (of loops generating the fundamental group), which is easily estimated as $2p + (r - 1)$ for a surface of genus p with r contours. [E.g., imagining contours as punctures, the first perforation liberates a free group of rank $2p$ (twice the genus), and each additional perforation creates a new generator.] Since this must be augmented by one (cf. Heins' lemma on p. 568, i.e. essentially the issue that each point of a convex body in Euclidean m -space is expressible as a barycentric sum of $m + 1$ extreme points of the body spanning an m -simplex) it seems probable that Heins's proof reproduce the bound $r + 2p$ of Ahlfors. More about this in Section 11.3. (Actually, Heins' convex geometry argument looks quite akin to the one used "subconsciously" by Ahlfors 1950 [17].)

- [22.10.12] **The gonality sequence.** An emerging question of some interest is that of calculating for a given bordered surface F (of type say (r, p)) the list of all integers arising as degrees of a circle map defined on the given surface. We call this invariant the *gonality sequence* of F . As a noteworthy issue Ahlfors upper bound $r + 2p$ is always effectively realized, in sharp contrast to Gabard's one $r + p$ which can fail to be. For some messy and premature thoughts on this problem cf. Section 17.3. Of course the problem looks a bit insignificant combinatorics, yet studying it properly seems to require both experimental contemplation of concrete Riemann surfaces and sharp theoretical analysis of the existence-proofs available presently. Asking fine quantitative questions should aid clarifying the qualitative existence theorems.

- [03.11.12] **Generalized Keplerian motions via Klein-Ahlfors?** It is well known that the motion of a single planet around a star describes an or-

bit which is a certain algebraic curve, namely an ellipse (other conics do occur for cold comets escaping at infinity without periodicity). To visualize Ahlfors circle maps on real plane algebraic curve of dividing type (Klein's orthosymmetry), one can contemplate totally real pencil of curves sweeping out the given curve along totally real collections of points. The prototypical example is the Gürtelkurve (quartic with two nested ovals) swept out by a pencil of lines whose center of perspective is located inside the deepest oval. All such lines cut the quartic in 4 *real* points (cf. Fig. 23). This paradigm of total reality is the exact algebro-geometric pendant of Ahlfors theorem, and suggests looking at real dividing curves as orbits of planetary systems with dynamics governed by a total pencil. For instance the Gürtelkurve could occur as the orbit of a system of 4 electrons gravitating around a proton with electric repulsive forces explaining the special shape of the Gürtelkurve (cf. again Fig. 23 below). In Section 18.1 we explore the (overambitious?) idea positing that the real locus of any real orthosymmetric curve (in the Euclid plane or space) arises as the orbital structure of an electro-dynamical system obeying Newton-Coulomb law's of attraction/repulsion via a dynamics controlled by an Ahlfors circle map (incarnated by a totally real pencil). This gives quite an exciting interpretation affording plenty of periodic motions to the n body problem. This idea probably requires to be better analyzed. Even if physically irrelevant, one can (by Ahlfors) trace for any orthosymmetric real curve (in the plane) a totally real pencil generating usually quite intriguing figures, especially when members of the pencil are varied through the full color spectrum to create some rainbow effect. Depictions of such totally real rainbows are given in Section 18.1, but we failed drastically to make serious pictures for Harnack maximal curves. This represents perhaps a certain challenge for computer graphics?

1.5 Some vague answers

This section tried to report question which looks exciting, and to which I tried some premature answer. It requires to be polished drastically and reorganized seriously. Hence it is probably safer to skip, but maybe readers fluent with techniques like Ahlfors extremals, Teichmüller extremal quasi-conformal maps, Plateau's problem, etc. may find useful to clarify our vague ideas.

- **Quantum fluctuations of Ahlfors' degree** [20.09.12] The following problem is somewhat ill-posed, yet it is just an attempt to excite the imagination. Suppose given a compact bordered Riemann surface F with $r \geq 1$ contours and of genus $p \geq 0$. For each interior point $a \in \text{int}(F)$ there is a uniquely defined analytic Ahlfors function f_a solving the extremal problem of making the derivative $f'(a)$ as large as it can be, while keeping this magnitude positive real and the range inside the unit disc. This extremal function is uniquely defined and independent of the local uniformizer used to compute the derivative. It is known by Ahlfors 1950 that each f_a is a circle map of degree somewhere in the range from r to $r + 2p$, that is a (surjective) branched cover of the disc. According to Coppens 2011 [183] the generic bordered surface has gonality $r + p$ so that one can considerably squeeze the Ahlfors range to the interval $r + p$ to $r + 2p$. One would like to understand in geometric term (if possible?) what phenomena is responsible of the fluctuation of the Ahlfors degree. Of course, if $p = 0$ there is no fluctuation just because of the Ahlfors squeezing: i.e. $\deg f_a$ is constant when the center of expansion a is dragged throughout the surface. However if $p > 0$, it is likely that some jump must occur albeit I know no argument. Gabard 2006 only showed that there is a circle map of degree $\leq r + p$, but a priori there is no reason forcing such low degree maps to be realized as Ahlfors maps. Following Coppens we may define the gonality γ of F as the least degree of a circle map on F . By Gabard (2006 [255]) $\gamma \leq r + p$ (and trivially $r \leq \gamma$). Coppens tell us that all intermediate values of γ are realized (modulo the trivial exception that when $r = 1$ and $p > 0$, $\gamma = 1$ cannot be realized). This gonality invariant infers a sharpened variability for the Ahlfors degrees, namely $r \leq \gamma \leq \deg f_a \leq r + 2p$, where $\gamma \leq r + p$. A priori all intermediate values could be visited (between γ

and $r + 2p$). However this scenario is incompatible with the case of hyperelliptic membranes studied in Yamada and Gouma, where the effective Ahlfors degrees are either maximal $r + 2p$ or minimal (i.e. 2). Those examples still indicate that despite a sparse repartition the degree distribution is in some sense extremal, occupying the maximum space at disposition. Is this a general behavior? This is the maximum oscillation (Schwankung) conjecture (MOC). If true, then Coppens gonality would always be sustained by an Ahlfors map and also Ahlfors upper bound $r + 2p$ would be sharp for any surface, whatsoever its differential-geometric granularity. MOC displays the most naive scenario for the fluctuation of Ahlfors degree, and it would be a little miracle if it is correct. If not, then what can be said? A very naive idea would be that there is a sort of conservation law like in the Gauss-Bonnet theorem: whatsoever you bend the surface the Curvatura integra keeps constant. (Of course this holds for a closed surface but not for a bordered one, unless the geodesic curvature of the boundaries is controlled, e.g. by making it null.) The vague idea would be that if we think of the Ahlfors degree $\deg f_a$ as a sort of discrete curvature $\delta(a)$ assigned to the point a then maybe $\int_F \delta(a) d\omega$ keeps a constant value (independent of the conformal structure). If so then at least in the cases where there is a hyperelliptic model (i.e. $r = 1$ or 2) one could conclude that the Ahlfors degree are somehow balanced. Yet recalling Yamada-Gouma's investigations it seems that that the maximum degree $r + 2p$ occurs very sporadically for the center a located on the finitely many Weierstrass points of the membrane, hence high values have little weight. So in the hyperelliptic case (with few contours $r = 1$ or 2) the Ahlfors degree are constantly very low 2 with exceptional jump taking place on a finite set of points. Maybe this suggests a low energy scenario valid in general: given any (finite) bordered surface F the Ahlfors degree is always equal to the gonality safe for some jump occurring on a finite set of points. Of course this must be perhaps be refined suitably by saying that there is a stratification (decomposition) in pieces, where the lowest degree (i.e. the gonality) is always non empty and containing the contours, and then as we penetrate more deeply inside the surface the degree may increase (eventually always reaching the extremum value $r + 2p$?).

- **Quasiconformal doodlings** [02.10.12] As is well known, Teichmüller 1939 [825] exploited the flexibilities of quasiconformal maps to put Riemann's intuition of the moduli of conformal classes of differential-geometric surfaces (Riemannian surfaces) on a sound footing. The idea is both soft and flexible, yet with the devil of capitalism (geometria magnitudinis) cached just behind for one counts the distortion effected upon infinitesimal circles into ellipses. Using Grötzsch idea of the möglicht konform map relating two configurations produces an extremal map relating both configurations, and this least distortion gives the Teichmüller metric (a first step to endow the moduli "set" of a genuine space structure). Maybe this methodology is also fruitful in the theory of the (Ahlfors) circle maps. The first desideratum is to show existence of circle maps, and then the game refines in finding best possible bounds (over the degree of such maps).

The framework is as follows (aping again Grötzsch-Teichmüller): given a finite bordered surface (and maybe also a mapping degree $d \geq r$) we look at all quasiconformal map (not necessarily schlicht), i.e. (full) branched cover of the disc (with the same topological feature as circle maps of taking the boundary to the boundary and the interior to the interior). Following Grötzsch's idea we may look at the "möglicht konform" map, i.e. the most conformal quasiconformal map in the family (hoping eventually to find a beloved conformal one). Measuring distortion (largest eccentricity of the ellipses images of infinitesimal circles) one gets a numerical invariant $\varepsilon(F, d) \geq 0$, namely the infimum of the dilation among the class of all (differentiable) maps from the bordered surface F to the disc. This invariant $\varepsilon(F, d)$ vanishes precisely when F admits a (conformal) circle-map of degree d . Hence it vanishes if $d \geq r + 2p$ by Ahlfors 1950 [17, p.124–126], and even as soon as $d \geq r + p$ if one believes in Gabard 2006 [255], where as usual p is the genus and r the number of contours of F .

However we rather interested to use the Grötzsch-Teichmüller theory to re-derive an independent existence-proof. Of course in contrast with the classical setting of Teichmüller’s approach to the moduli problem, where one considers exclusively schlicht(=injective) maps, we tolerate now multivalent mappings, but this should not be an insurmountable obstacle.

Our intuition is that it is not just a matter of measuring that is required, but one must somehow explore the pretzel underlying the surface to get an existence proof. Yet the flexible-quantitative viewpoint of measuring eccentricity probably gives an interesting numerical invariant which is now not a metric (Teichmüller metric), but rather a (potential) function on the moduli space. In fact we assign to a given (bordered) surface F a series of number $\varepsilon(F, d)$ for $r \leq d \leq r+p$ (larger values of d give 0 by Gabard 2006 [255]), which is probably decreasing (after eventually modifying the original problem by permitting all maps of degree $\leq d$ instead of those having degree exactly d). So we get attached to F a series of dilations $\varepsilon(F, r) \geq \varepsilon(F, r) \geq \dots \geq \varepsilon(F, r+p) = 0$. Of course the sequence can crash to zero before the $r+p$ bound and indeed do so as soon as Coppens gonality γ is reached (that is, the least degree of a circle map for the fixed F). [Of course in the exact degree d variant of the problem one can imagine more romantic behaviors with oscillation down to zero and then becoming positive again (touch-and-go phenomenology).] Those p invariants would refine Coppens gonality in a continuous fashion, yet fails to be “moduli” since there are $3g-3$ of them (Riemann-Klein) where g is the genus of the double (that is $2p+(r-1)$), hence giving a total of $3g-3 = 3(2p+(r-1)) - 3 = 6p+3r-3$ free parameters which exceeds of course our p parameters.

But coming back to the basic existence problem, one can get started by observing that any topological type of membrane admits a circle map. One trick is to use symmetric membranes (cf. Chambéry section 18.4 below). This amounts to imagine a membrane in 3-space symmetric under rotation by 180 degree so that the quotient as genus zero (cf. Fig. 49 below). Once the handles are killed one is reduced to the simple (planar) case of Ahlfors due to Bieberbach-Grunsky (and largely anticipated by Riemann, Schottky (no bound by Schottky?), and Enriques-Chisini (via Riemann-Roch and a continuity argument, cf. e.g. Gabard 2006 [255, Sec. 4])). The degree of the resulting map is easily computed (and of degree essentially equal to $(r/2) \cdot 2 = r$ the minimum possible value, for the rotation identifies pairs of contours and gyrate all handles over themselves, cf. again Fig. 49, below). Thinking in the moduli space M we have shown that the set C of all circle-mappable surfaces is non empty, and using the connectedness (of M) it would suffice to show that C is clopen (closed and open). Checking openness, certainly requires enlarging the mapping degree to larger values. Now given an arbitrary bordered surface F we can quasiconformally map it to our symmetric model S and then compose with the circle-map. The dilatation is then controlled in term of the Teichmüller distance from F to S , giving an upper bound over the eccentricity invariant ε (for the appropriate degree). Of course this is still miles away from reproving even Ahlfors but maybe the idea is worth pursuing.

In fact what is truly interesting is that we get for each d a numerical function ε_d (defined as $\varepsilon_d(F) := \varepsilon(F, d)$) on the moduli space $M_{p,r}$ of membrane of genus p with r contours, that vanishes precisely when F has gonality $\leq d$. Of course this sequence of functions is monotone decreasing when the index increases, and $\varepsilon_d \equiv 0$ is identically zero (for $d \geq r+p$). According to Coppens result each of these functions (let us call them the Teichmüller potentials) vanishes somewhere. It is then perhaps interesting to look at the gradient flow φ_d (w.r.t. Teichmüller metric) of these functions ε_d affording a dynamical system (=flow) in which each bordered surface evolves in time to a sort of best possible surfaces for the prescribed gonality. (Morally each surface tries to improve its gonality along the trajectory of steepest descent.) If the global dynamics is simplest (say each trajectory finishes its life on a surface of gonality d) it is therefore reasonable to expect that the whole Teichmüller space is retracted by deformation to a sort of spine consisting of surfaces having the prescribed gonality d . Maybe

one can deduce that the global topology of this spine is that of a cell (like the full Teichmüller space). Further it seems probable that the flows preserve the stratification by the gonality of $M_{p,r}$ since if F has gonality say d then its future F_t has lower gonality. [The situation looks analog to some works of René Thom (isotopy lemma, vector fields preserving a stratification, and “fonction tapissante” as it arise in the Thom-Mather problem of the stability of polynomial mappings??)]

[03.10.12] Of course the above can be adapted to the case of closed (non-bordered) surfaces of genus say g , by replacing the target disc by the (Riemann) sphere. Likewise we define Teichmüller potentials ε_d , measuring the dilatation of the “möglichst konform” map of a fixed degree d from the surface F to S^2 , and ideally one can imagine that the theory is able to reprove the famous (Riemann-Brill-Noether) bound $[(g+3)/2]$ first proved by Meis 1960 [541]. Hence all what we are trying to do is surely already well-known (alas I was never able to find a copy of Meis’ work, which is Teichmüller-theoretic according to other sources). Hence if Meis theory is just a sort of Teichmüller theory for branched covers of the sphere, with the ultimate miracle that Teichmüller not only affords a solution to Riemann’s moduli problem but also to the gonality question. A priori Meis’ theory should adapt to the bordered setting and arguably lead to another proof of the Ahlfors map, and optimistically with the sharp bound predicted in Gabard 2006 [255]. Sharpness of the bound is due to Coppens 2011 [183]. Recall that, Teichmüller himself was close to this (bordered) topic in the article Teichmüller 1941 [826], yet the details (as well as exact bounds) are probably missing.

• **Ahlfors inflation/injection and generalized Ahlfors maps taking values outside the disc (alias, circle)** [09.10.12] The theory of the Ahlfors function is primarily based upon the paradigm of maximizing the derivative (its modulus) within the family of maps with range confined to a (compact) container namely the unit disc. So it is primarily an inflation/injection (or pressurization) procedure (by opposition to the dual deflation/suction approach of Bieberbach-Bergman amounting to minimize the area among maps normed by $f'(z_0) = 1$). Ahlfors 1950 [17] showed that if the source object is any compact bordered Riemann surface and the target the unit disc then the Ahlfors (inflating) map turns out to be a circle map, i.e. a full covering of the unit circle taking boundary to boundary. This behavior is not surprising since maximizing the distortion (scaling factor) at a given basepoint forces the whole surface to be maximally stretched over the target, like an elastic skin pushed to its ultimate limit (in the Hollywoodian context of aesthetical surgery). The existence of Ahlfors maps relies on a Montel normal family argument, in substance inherited from the compactness of the disc. This suggests replacing the target disc by any compact bordered Riemann surface. We formulate then the following extremal problem:

Given two finite bordered Riemann surfaces F and G and a given point $a \in F$ and $b \in G$, we look inside the family of all analytic maps $f: F \rightarrow G$ taking a to b at the map maximizing the modulus of the derivative $f'(a)$ computed w.r.t. local parameters introduced at a and b .

By analogy with the Ahlfors et alii theory, we expect that the extremal function exist (compactness of the receptacle G), is unique (this is either less evident or false for in the classical case $G = \Delta$ the argument relied heavily on the Schwarz lemma for the disc, so that our only hope in favor of uniqueness is that what actually counts is the universal covering). Arguably, even if lacking uniqueness extremals could still be interesting. Finally it is reasonable to expect that extremals are not oversensitive to the choice of local uniformizers. So we can speak of the map $f_{a,b}$ of extremum dilatation at a, b . Finally we are interested about knowing if the extremals are total maps in the sense of taking boundary to the boundary, as do the classical Ahlfors map in the circle/disc-valued case. Before proceeding to examples let us perhaps observe that in the special case where F is given as a subsurface of G and both points $a = b$ coincide, then the (complex) tangent space are readily identified so that $f'(a)$ has an intrinsic

meaning as scaling factor of this complex line. Another special case of interest is when G is a plane subregion, in which case the tangent bundle is trivialized so that one can consider a relaxed form of the problem without the constraint $f(a) = b$, in which no point b is given but the sole extremalization of $f'(a)$ will actually dictate where a has to be mapped.

Albeit all we are saying looks a bit messy and unnatural (?), it should be noted that the whole game can be drastically simplified by just looking at avatars of circle maps, that is given two finite Riemann surfaces F and G when does there exist a total map (taking boundary to boundary) from the first to the second. (Of course this question is quite standard yet probably hard to answer precisely, cf. Landau-Osserman 1960 [493], and Bedford 1984 [60].) As we shall soon explain a vague answer is readily supplied by “algebraic geometry”, namely when the target G is not the disc, and if F has general moduli then in general there is not a single total map from F to G . The moral is that circle maps enjoy a certain privilege due to their unconditional existence (by Ahlfors 1950 precisely).

A basic obstruction arises from the Riemann-Hurwitz formula. Indeed given $f: F \rightarrow G$ a total map, it has no ramification along the boundary and is a full covering surface (cf. e.g. Landau-Osserman 1960 [493, p.266, Lemma 3.1]). Denoting by $d \geq 1$ the degree of the map, we have $\chi(F) = d\chi(G) - b$, where $b \geq 0$ counts the branch points. When $d = 1$, there is no branching and the topological types must agree. Another constraint says roughly that a total map can only simplify the topology, precisely $\chi(F) = d\chi(G) - b \leq d\chi(G) \leq \chi(G)$, when $\chi(G) \leq 0$.

Lemma 1.6 *If G is not the disc then the existence of a bordered map $f: F \rightarrow G$ implies that the Euler characteristic satisfies $\chi(F) \leq \chi(G)$. (Of course the conclusion persists when G is the disc for it maximizes the Euler characteristic among bordered surfaces.)*

Another simple constraint comes from the fact that a total map $f: F \rightarrow G$ induces a covering of the boundary $\partial f: \partial F \rightarrow \partial G$. Hence if G has r' contours then F has at most $d \cdot r'$ contours, i.e. $r \leq d \cdot r'$ where r is the number of contour of F . On the other hand as ∂f is onto, the surjection induced by ∂f on the π_0 (=the arc-wise connected component functor from TOP to SET) implies that $r \geq r'$.

Then there is a little zoology of cases to study.

(Z1) Let us first suppose that the *source* is just the disc, then who is the (“Ahlfors”) extremal map? So we assume $F = \Delta$ and G any bordered surface marked at $a = 0, b \in G$ respectively. By uniformization (Koebe-Poincaré 1907) we know that the universal cover of the interior of any finite bordered surface is the disc. Now the extremal map $f_{a,b}: \Delta \rightarrow G$ (maximizing the distortion) may be lifted to the universal cover as say $F: \Delta \rightarrow \Delta$. Now by the Schwarz-Pick principle of hyperbolic contraction for analytic maps, the latter map contracts the hyperbolic metric implying the universal projection to effect a greater dilatation than the presumed extremal $f_{a,b}$. It follows that F must be the identity (up to rotation) and the extremal function get identified to the universal cover. (Actually, works by Carathéodory and Grunsky actually manage to prove uniformization via the (Ahlfors) extremal problem, whereas we assumed it.)

(Z2) Now consider the situation were both source and target have complicated topology. For instance the source is any bordered surface and the target an annulus. One may expect to get analogues of circle maps, i.e. *total maps* taking boundary to boundary (sometimes known as proper maps). (Such maps are called *boundary preserving* in Jenkins-Suita 1988 [394], cf. also Landau-Osserman 1960 [493, p.265] who speak of maps “which takes the boundary into the boundary”, while ascribing to Radó 1922 [665] the basic result that such maps are full coverings taking each value of the image surface a constant number of times). Unfortunately, there is severe obstructions to boundary preservation of such (generalized) Ahlfors maps. One way to argue is via algebraic geometry and the Jacobians. It is indeed classic that a generic closed Riemann surface

tolerates only nonconstant maps to the sphere (ruling out the trivial identity map or automorphisms available incidentally only for surfaces with specialized moduli). Assuming the Ahlfors map of F to an annulus to be total, its symmetric extension to the Schottky-Klein double is a map from a closed surface to the torus, which for general moduli cannot exist at all! Of course all this requires better proofs, but is fairly well-known and classical (cf. e.g. Griffiths-Harris 1980 [304], who argue as follows (p.236–237): “A general curve C of genus $g \geq 2$ cannot be expressed as a multiple cover of any curve C' of genus $g' \geq 1$. This is readily seen from a count of parameters: the curve C' will depend on $3g' - 3$ parameters, and the m -sheeted covering $C \rightarrow C'$ depends on b parameters, where $[\chi(C) = m\chi(C') - b]$, that is]

$$b = 2g - 2 - m(2g' - 2)$$

is the number of branch points of the cover. Thus if $m \geq 2$, C will depend on

$$b + (3g' - 3) = b + \frac{3}{2}(2g' - 2) = 2g - 2 - \underbrace{\left(m - \frac{3}{2}\right)}_{\geq 1/2} \underbrace{(2g' - 2)}_{\geq 0} \leq 2g - 2 < 3g - 3$$

parameters, and so cannot be general.” (Another argument is given in the exercises of Arbarello-Cornalba-Griffiths-Harris 1985 [48, p.367, Ex. C-6], which of course we were not able to solve!)

(Z3) Finally one can imagine a bordered surface embedded in a slightly larger one (say of the same topological type). Then the inclusion map is permissible in the extremal problem, so the extremal map will have distortion ≥ 1 at some base point, and naively should expand the small surface into the larger one. However by the argument of (Z2) in general it is unlikely that the extremal will be total, and also a priori it not even clear that a true expansion can occur (try to lift the map to the universal cover a get maybe a conflict with the Schwarz-Pick principle of contraction??) But of course this looks dubious for when the subsurface is a disc expansion is possible.

• **Cyclotomic Riemann surfaces** [09.10.12] (but similar examples in Chambéry Talk ca. 20 December 2004) At this stage we can do perhaps the following sort of experiment. As is well-known (Riemann-Prym-Klein 1882 [434]) a Riemann surface structure can also be defined in the most simplest way to visualize, namely as differential-geometric surface in 3-space with metric (hence conformal structure) inherited by the Pythagorean/Euclidean line element. Consider a hemisphere in Euclidean 3-space surmounted by m handles cyclotomically distributed as on Fig. 5, joining themselves above the north pole.

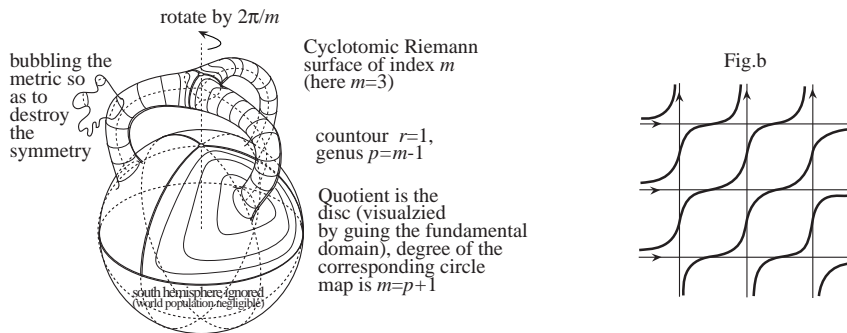

Figure 5: A cyclotomic Riemann surface

Ignoring the south hemisphere, we obtain so a bordered surface F with one contour ($r = 1$) and of genus $p = m - 1$. (Notice here the standard psychological aberration that the genus is one less than the “handles”, for the first handle is not yet coupled to another one to create a real handle!) On rotating by angle $\frac{2\pi}{m}$ the configuration F upon itself we obtain a map from F to the disc (hence a circle map), because the fundamental domain of the rotation is glued over itself to give a disc. The circle map so obtained has degree $m = p + 1$. This

matches with the general bound $r + p$ predicted in Gabard 2006 [255]. Let us now assume that a bubbling, i.e. an Euclid-Riemannian deformation of the metric takes place at one of the handle (yet not on the remaining ones) then the rotational symmetry is killed and it becomes much nontrivial that a circle map of same degree is still persistent. This experiment seems to damage the truth of Gabard 2006 [255] (but hopefully is not?) A naive parade would be to use the (Riemann-Schwarz) uniqueness of the conformal structure on the closed 2-cell to resorb the cancerigenic bubbling. Yet this looks cavalier (for we are not living in the soft smooth C^∞ category) and this would not settle the case of less localized cancerigenic degenerations not supported over a disc, but along a subregion having itself moduli. Then one cannot repair easily the deformation by a simple surgical lifting. At this stage we see that the result of Gabard 2006 [255], if true at all, looks quite formidable for it should resist all those plastic deformations within the flexibility of conformal maps.

It could be interesting (by adapting Yamada-Gouma) to study the degree of the Ahlfors map of such cyclotomic Riemann surfaces, especially when the basepoint is situated on the 3 fixed points of the rotation.

• **Special triangulations** [10.10.12] Given a circle map of a bordered surface F , one can post-compose it with the map taking conformally the disc to an equilateral triangle (in the Euclid plane \mathbb{C}). (Recall that this can be done for any three point prescribed along the boundary). Upon subdividing the triangle in a mesh of equilateral triangles, and lifting via the conformal map we generate certain triangulations of F which are almost equilateral. In fact if the mesh size is chosen so that all ramification points lye in the interior of the tiny triangles then the inverse image of such ramified triangles will be small hexagons. Try to study the differential geometry and specialize to Gromov's Filling conjecture, or try to find a link with Belyi-Grothendieck (a Riemann surface is defined of $\overline{\mathbb{Q}}$ iff it admits an equilateral triangulation).

Another special triangulation of the disc is the hyperbolic tessellation depicted on the front cover of Grunsky's Collected papers (by equilateral triangles with angles $\pi/6$). [This tessellation is supposed via the Ahlfors-Grunsky conjecture (1937 [15]) to play an extremal role in the Bloch schlicht radius of maps $\Delta \rightarrow \mathbb{C}$ for it dominates the densest circle packing of the Euclidean plane.] Try to understand if it is useful (or aesthetical) to lift this tessellation to the bordered surface via a circle map.

• **Plateau heuristics \Rightarrow Ahlfors maps?** [17.10.12] Soap film experiments of the Belgian physicist have a certain existential convincing power, albeit the rigorous mathematical existence proof (Douglas/Radó ca. 1930/31) required circa 30 years more delay than the allied Dirichlet principle (Hilbert 1900) itself interpretable at the equilibrium temperature distribution in a heat-conducting plate with assigned boundary values. Now Douglas 1931 [209] observed that the Riemann mapping theorem (RMT) may be derived by specializing Plateau's problem to the case where the contour degenerate to the plane, and Courant pushed the remark further so as to include the Riemann-Bieberbach-Grunsky theorem (=planar case of the Ahlfors map). On the other hand Douglas 1936 [210] envisaged the so-called Plateau-Douglas problem (PDP, or just PP) for membranes of higher topological structure. It should thus follow (either logically or intuitively) a physico-chemical existence proof of the Ahlfors map.

Let F a finite bordered Riemann surface of genus p with $r \geq 1$ contours, and suppose also given a fixed circle in the plane interpreted as the prescribed wire frame of PP. More generally one can imagine a collection of r contours to be given, and we look at the special case where all these coincide with the unit circle. Now cultivating the right intuition about PP it should be possible to deduce the existence of Ahlfors maps perhaps even with the degree control $r + p$ of Gabard. In fact it should even be possible to study wide extensions where not all frames are coincident with the unit circle. Can one take any frame prescription (e.g. disjoint round circles)? For instance take two unit circles with centers lying distance ten apart ($|z| = 1$ and $|z - 10| = 1$). Suppose the membrane to have the topological type of an annulus ($r = 2$ and $p = 0$).

Then the minimal surface is something like a flat catenoid, where the inside of each circle is covered once and a certain tube connecting both circles is covered twice by the map. Yet notice that the apparent contour (where the map is folded) of such a film violates the local behavior of holomorphic maps. As we just saw the folding obstruction makes unlikely to span contours consisting of disjoint maximal circles. (Circles being ordered by inclusion of their interior in the plane.) In contrast a nested configuration of circles should cause no trouble to holomorphy. Thus it should be possible to render Ahlfors intuitively obvious via soap film experiments. Of course this was essentially done in Courant's book (1950 [195]), yet the exact juncture with Ahlfors result probably deserves some extra working. Of course the real challenge would be to investigate if Plateau-style approaches are susceptible to vindicate the degree bound $r + p$ advanced by Gabard 2006 [255].

Another idea is to imagine a Plateau problem with "wind" blowing through 3-space in some prescribed way (along a given vector field). For instance a soap film spanning a planar disc at rest could deform under a perpendicular wind into say a hemispherical membrane. Try to connect this with Gromov's filling conjecture, yet unlikely due to the embedded nature of Plateau. Another more plausible connection would be with Gottschalk's conjecture on flows in 3-space (no vector fields in 3-space having only dense trajectories). This is probably one of the most alienating open problem in the qualitative theory of dynamical systems.

- **(Ahlfors) circle maps of minimal degree** [19.10.12] Given a finite bordered Riemann surface F of genus p with r contours, there is always (by Ahlfors) a circle map. The set of (positive) integers being well-ordered there is a circle map of minimal degree. Call perhaps such maps *minimal circle maps*. We may ask to which extent such a map is unique and if not can we describe the "moduli space" of such maps. Of course in the most trivial case where $p = 0$ and $r = 1$ (topologically a disc) the Riemann map is essentially unique ignoring automorphisms of the disc. Likewise uniqueness holds for surfaces with hyperelliptic double provided the latter is not Harnack-maximal. Such hyperelliptic membranes have $r = 1$ or $r = 2$ and the hyperelliptic involution induces a totally real morphism of degree 2. Our uniqueness assertion follows of course from the uniqueness for complex curves of the hyperelliptic involution when $g \geq 2$ and thus holds in our context provided $p \geq 1$ (recall that $g = (r - 1) + 2p$). When $p = 0$ and $r = 2$ uniqueness fails, for then the double has genus one and may be concretized as a smooth plane cubic with two circuits: one being a genuine "oval" bounding a disc in $\mathbb{P}^2(\mathbb{R})$, the other being termed a pseudo-line. Projecting from any point located on the oval gives a totally real morphism of degree 2, and correspondingly a circle map when restricted to the semi-Riemann surface. Another example is the Gürtelkurve, i.e. any smooth quartic with two nested ovals. Then the minimal degree of a circle map (for the half of the curve) is 3 (argue with the complex gonality of smooth plane curves), and such maps arise by projecting the curve from a real point located on the innermost oval of the nest. Hence there ∞^1 circle maps of minimum degree, those being parameterized by a circle S^1 . Of course the problem does not depend only on the topology: the half of the Gürtelkurve belongs to the topological type $r = 2$ and $p = 1$, which contains also hyperelliptic representatives, those being circle mappable in a unique fashion via a map of degree 2.

When F is planar ($p = 0$) then the double is Harnack-maximal and either the argument of Enriques-Chisini or that of Bieberbach-Grunsky shows that any divisor with one point on each oval moves in a linear system which is totally real (cf. e.g. Gabard 2006 [255]). So we have now essentially a torus of dimension r (r =number of contours) of circle maps of minimum degree. A details description is not so evident for such a divisor D moves in a linear system of dimension $\dim |D| \geq \deg D - g$ (Riemann's inequality, a direct consequence of Abel), where $g = r - 1$ is the genus of the double. Thus $\dim |D| \geq r - (r - 1) = 1$ so that D does not necessarily determines unambiguously a totally real pencil. Despite this difficulty it seems reasonable to assert that the set of circle maps

for a planar membrane is a torus perhaps of dimension only $r - 1$ for one has to unite divisors lying in the same pencil. Extrapolating such examples, we may wonder about structural properties of the set of (minimal) circle maps. Is it always compact? Always a manifold? Perhaps even always a torus. Is it always connected? Of course there are various way to formulate the question and there probably basic experiments giving quick answers to the naive connectedness assumption. Another question is to understand how the global degree d of the circle map splits (partitioned) into the bordered degrees of the restriction to each contours. For instance in the case of the Gürtelkurve, albeit both ovals are perfectly equivalent from the viewpoint of analysis situs, it seems that on the Riemann surface the one corresponding to the inner oval can be mapped with degree 1 whereas the other is less “economic” requiring a wrapping of degree 2. Of course it would be nice to understand this in some intrinsic fashion? But how? (Perhaps via the uniformizing hyperbolic metric and the length of the corresponding ovals???)

Let us try a naive approach to the connectedness problem (by actually trying to corrupt it). Consider in the “abstract quadric surface” $\mathbb{P}^1 \times \mathbb{P}^1$ a configuration of bidegree say $(3, 3)$. We have chosen both degrees equal so that both projections have the same degree. Imagine 3 lines in each ruling and smooth out the corresponding line arrangement to create a smooth curve $C_{3,3}$ (cf. Fig. 5b). Actually we have performed sense-preserving smoothings (cf. again the figure) so that the resulting curve is dividing (Fiedler type argument [235]). Contemplating the figure we count $r = 3$ “ovals”. Both projections on the factors are totally real morphisms of degree 3 (the minimum possible degree in view of the trivial lower bound $\deg f \geq r$). However it seems unlikely that one can continuously deform one map into the other (while keeping its degree minimum). Hence this may give some evidence that the space of minimal circle maps (for the corresponding bordered surface, namely the half of the orthosymmetric Riemann surface underlying our dividing curve $C_{3,3}$) is not connected. However our argument is quite sloppy, having equally well applied to bidegree $(2, 2)$ in which case the corresponding curve is Harnack-maximal [recall that $g = (a - 1)(b - 1)$ for bidegree (a, b)], hence subsumed to the connectivity principle. Of course it is probable that some basic complex algebraic geometry (gonality of complex curves) suffices to complete the above argument. Is it true that a smooth curve of bidegree (n, n) is n -gonal in only two fashions (provided $n \geq 3$) via the natural projections? Of course the assertion is false for $n = 2$, for then $g = 1$ and a smooth plane cubic model creates ∞^1 pencils of degree 2. For another plane example seeming to violate the connectivity principle of minimal maps see Fig. 50(code 313).

1.6 Some historical quiz

- Does Klein really anticipate Ahlfors as may be suggested in Teichmüller 1941? (Compare Section 7.1.)
 - Does Courant’s paper of 1939 [191] (and the somewhat earlier announcement of 1938 [190], plus the later book treatment of 1950 [195]) presage (modulo a suitable interpretation) any anticipation over the circle map result of Ahlfors 1950 [17]? (For more, compare Section 7.4.)

2 The province of Felix Klein

2.1 Felice Ronga and Felix Klein’s influence

In fact the writer himself came across (a weak version of) the Ahlfors function topic from a somewhat different angle, namely via Klein’s theory of *real algebraic curves* (spanning over the period 1876–92). For Klein this was probably just a baby case of his paradigm of the Galois-Riemann Verschmelzung (Erlanger Program 1873, friendship with Sophus Lie, Ikosaheder and its relation to quintic in one variable, etc.). Yet, real curves surely deserved special (Kleinian) attention

as it provided a panoramic view (through the algebro-geometric crystal) of the just emerging topological classification of surfaces (Möbius 1863 [565], Jordan 1866 [401], etc.). This offered also a bordered (even possibly non-orientable) avatars of Riemann surfaces, as shown in the somewhat grandiloquent title chosen by Klein “*Über eine neue Art der Riemannschen Flächen*” (=title of 1874 [430], 1876 [432]). Those works of Klein were probably not extremely influential (and still today represent only a marginal subbranch of the giant tree planted by Riemann).

Klein himself lamented at several places his work not having found the quick impact he expected from. In 1892 [442, p. 171] (ten years after his systematic theory presented in 1882 [434]), he writes: “*Inzwischen hat noch niemand, so viel ich weiß, die hier gegebene Fragestellung seither aufgegriffen, [...]*”. About the same period in his lectures of 1891/92 [440, p. 132], he wrote: “*Was ich bislang von diesen Theoremen publicirt habe (so die Einteilung der symmetrischen Flächen in meiner Schrift von 1881), hat nur wenig Anklang gefunden. Ich meine aber, daß das nicht am Gegenstande der Untersuchung liegt, der mir viel mehr das größte Interesse zu verdienen scheint, sondern an der knappen Form, mit der ich meine Resultate darstellte.*”

Of course this impact was first limited to his direct circle of students, where we count Harnack 1876 [334], Weichold 1883 [873] and Hurwitz 1883 [383] (also a student of Weierstrass). Klein was also very proud that his results on real moduli supplied a natural answer to questions addressed (but not solved) at the end of Riemann thesis. Klein insists twice on this issue in 1882 [434]=[443, p. 572, §24] and in his subsequent lectures 1891/92 [439, p. 154], where he writes: “*Mit dieser Abzählung ist implicite die entsprechende Frage für berandete Flächen beantwortet, was darum ein gewisses Interesse hat, weil diese Frage von Riemann in seiner Dissertation aufgeworfen, aber nicht zu Ende discutirt wird. Riemann denkt natürlich nur an berandete einfache Flächen (nicht an Doppelflächen; dem deren Existenz wurde erst zehn Jahre später von Moebius bemerkt und wohl erst in meiner Schrift für funktionentheoretische Zwecke herangezogen).*”

From the very beginning 1876 [432]=[442, §7, p. 154], Klein noticed that real curves are subjected to the dichotomy of being dividing or not, where the former case amounts to a separation of the complex locus through its real part (consisting of *ovals*, a jargon immediately suggesting Hilbert’s 16th problem, yet used much earlier, e.g. by Zeuthen 1874 [909]). Zeuthen’s work seems to have much inspired Klein’s investigation on real curves, starting circa 1876, just two years later (cf., e.g. Klein 1892 [442, p. 171]: “*Ich hatte 1876 den Ausgangspunkt unmittelbar von den Kurven genommen. Das war bei $p = 3$ möglich, wo ich zahlreiche geometrische Vorarbeiten, insbesondere diejenigen des Herrn Zeuthen [...] (1874), benutzen konnte.*”)

Perhaps, the more tenacious followers of Klein’s viewpoint came somewhat later and the real demographic explosion of the subject took place much later, say perhaps in the 1970’s. Here is a little chronology:

- del Pezzo 1892 [637], where Klein’s trick of assigning the unique real point of an imaginary tangents is taken as the starting point of a study of curves of low genus.
- Berzolari 1906 [87], who in an encyclopedia article surveyed in few pages Klein’s achievements and virtually coined the term “Klein surfaces” (Kleinsche Flächen) as a way to designate possibly non-orientable and eventually bordered avatar of Riemann surfaces. To say the least, this terminology was dormant during several decades until Alling-Greenleaf managed in 1969 [38] a resurrection of Berzolari’s coinage, and since then the nomenclature gained in popularity.
- Koebe 1907 [449] who studied uniformization of real algebraic curves taking advantage of Klein’s distinction orthosymmetric vs. diasymmetric.
- Severi 1921 [780, p. 230–6], who devotes some few pages of his book to Klein’s theory of real curves, [Note: there Severi writes down the same formula as one used by Courant in his approach to conformal circle maps, ascribing it to Cauchy].
- Comessatti 1924-25 [181] in Italy (full of admiration for Klein), who pushed

the philosophy up to include a study of real abelian varieties, rational varieties, etc. (For this ramification we refer to the remarkable survey by Ciliberto-Pedrini 1996 [175].)

- several works of Cecioni in the late 1920's ([162], [163], [164]), and his students (Li Chiavi 1932 [508]) makes direct allusion to Klein's works.

- In France, the work of Klein found a little echo in some passages of the book by Appell-Goursat whose second tome (1930) was apparently mostly written by Fatou. There, Klein's orthosymmetry occurs at several places [46, p. 326–332 and p. 513–521].

- Witt 1934 [892], where a general existence theorem for *invisible* real algebraic curves (those with empty real locus like, e.g. $x^2+y^2 = -1$) was established. This will be discussed later (Section 18.10), and is somehow quite akin to the Ahlfors function. Witt's work makes explicit mention of Klein, and was subsequently elaborated by Geyer 1964/67 [289], who arranged a purely algebraic interpretation of Weichold's work. His pupil G. Martens, managed (1978 [526]) to determine the lowest possible degree of the Witt mapping;

- (Jesse) Douglas 1936–39 makes a systematic use of Klein's symmetric surfaces in his study of Plateau's problem for configuration of higher topological structure. (We shall have to come back to this in Section 7.5.)

- A marked influence of Klein upon Teichmüller 1939 [825], 1941 [826]. We shall try to explore this connection in greater detail later (Section 7.1).

Then different events occurred at a rather rapid pace with several schools penetrating into Klein's reality paradigm through different angles:

- Ahlfors 1950 [17], who never quotes Klein. Probably via Lindelöf–Nevanlinna's teaching one is more inclined toward the hard analysis à la Schwarz, than the innocent looking geometry à la Klein. Of course Ahlfors quotes instead Schottky, as typified by the terminology Schottky differential, etc. used in Ahlfors 1950 (*loc. cit.*). It may then appear as a little surprise that Ahlfors's result affords a purely algebraic (in term of real function fields) characterization of Klein's orthosymmetric curves. However to my knowledge, this connection—as trivial as it is—was never emphasized in print until much later, namely in Alling-Greenleaf 1969 [38].

- Schiffer-Spencer's book 1954 [753] (outgrowing from Princeton lectures held during the academic year 1949–50) where the book is started by recalling how Klein assimilated the full Riemannian concept after a 1874 discussion with Prym revealing him the ultimate secret of Riemann's function theory developed over arbitrarily curved surfaces not necessarily spread over the plane. The original source reads as follows (Klein 1882 [434]): “Ich weiß nicht, ob ich je zu einer in sich abgeschlossenen Gesamtaufassung gekommen wäre, hätte mir nich Herr Prym vor längeren Jahren (1874) bei gelegentlicher Unterredung eine Mitteilung gemacht, die immer wesentlicher für mich geworden ist, je länger ich über den Gegenstand nachgedacht habe. Er erzählte mir, daß die Riemannschen Flächen ursprünglich durchaus nicht notwendig mehrblättrige Flächen über der Ebene sind, daß man viel mehr auf beliebig gegebenen krummen Flächen ganz ebenso komplexe Funktionen des Ortes studieren kann, wie auf den Flächen über der Ebene.”

From circa 1970 upwards, the study of so-called Klein surfaces (jargon of Berzolari [87]) *per se* enjoyed a rather exponential rate of growth as if the simple naming of them was a stimulus for a big expansion of the topic. After two decades an impressive body of knowledge has been accumulated (cf. e.g. the rich bibliography compiled in Natanzon's survey 1990 [585]). Those developments can be roughly ranged into 3 main axes:

- *Foundational aspects.*—Alling-Greenleaf 1971 [39], and also in Romania with the numerous contribution of Andreian Cazacu (1986–88 [42], [43]) about the structure of morphism between them (interior influence of Stoilow).

- *Symmetry, automorphisms and NEC(=non-Euclidean crystallography).*—This is especially active in the Spanish school but started somewhat earlier with Singerman 1971–88 (5 items), May 1975–88 (9 items), Bujalance 1981–89 (29 items) Costa, etc.

- *Moduli spaces of Klein surfaces*. This starts of course in Klein 1882 [434], to reach a certain climax in Teichmüller 1939 [825] and the Ahlfors-Bers school, Earle 1971, Seppälä 1978–89 (6 items on Teichmüller and real moduli), Silhol 1982–89 (Abelian varieties and Comessatti), Costa, Huisman 1998+, etc.

All those works contributed to feel virtually as comfortable with real curves as with their complex grand sisters. We just mention one result of Seppälä 1990 (revisited by Buser-Seppälä-Silhol 1995 [130] and Costa-Izquierdo 2002 [184]) to the effect that the moduli space of real curves is connected. (This sounds almost like a provocation to anybody familiar with the bio-diversity of topological types of symmetric surfaces listed by Klein). Of course the trick, here, is that those authors regard this moduli space projected down in that of complex curves (by forgetting the real involution). In other words we may deform the structure until new anti-conformal symmetries appears and switch from one to the other. Hence the subject is sometimes hard to grasp (due to varying jargon) and more seriously is full of real mysteries allied to the real difficulty of the subject.

- *Geometry of real curves*. Here much of the impulse—very much in Klein’s tradition—came through the paper of Gross-Harris 1981 [308]. In this or related direction, we may cite authors like Natanzon, Ballico, Coppens, G. Martens, Huisman, Monnier, etc. This area proved very active since the 2000’s up to quite recently and a remarkable variety of difficult question are addressed giving the field arguably some maturity soon comparable to the complex hegemony.

Of course, another line of thought is the interest aroused by Hilbert’s 16th problem (on the mutual disposition of circuits of real algebraic varieties esp. curves) especially among the early German, Italian and then mostly the Russian annexion of the subject. This captured and probably contributed to mask Klein’s more intrinsic viewpoint for a while. This axis includes the following workers (precise references listed in Gudkov 1974 [323]):

- Hilbert 1891–1900–09, Rohn 1886–1911–11–13; (it is interesting to note that Hilbert’s first 1891 paper on the subject is quite synchronized with Klein’s lectures of 1891/92, which conjecturally may have stimulated Hilbert’s interest, yet not a single allusion to Klein in this paper, and recall also that Hilbert was still in Königsberg at that time).

- Brusotti 1910–13–14–14–15–16–16–16–16–17–21–28–38/39–40–44/45–46–50/51–52–55–55 (characterized by “*la piccola variazione*”, i.e. the method of small perturbation permitting to construct real algebraic curves with controlled topology. The writer is indebted to Felice Ronga for this method, which of course as some historical antecedents older than Brusotti. In Klein 1873, footnote 2 in [442, p.11] the principle is traced at least back to Plücker 1839. However Brusotti 1921 [121] may have been the first—modulo its reliance over work of Severi—to notice that the Riemann-Roch theorem admits as extrinsic translation the possibility of smoothing independently the nodes of a plane curve. The main issue (as transmitted by Felice) is that the nodes a plane curve with nodal singularities impose independent conditions on curves of the same degree. Hence when the curve is being imagined as a point in the (projective) space of all curves, it sits on the discriminant hypersurface (parameterizing all singular curves) and nearby our nodal curve we see several transverse smooth branches crossing transversally. (In French or Italian, there are better synonyms like “*falde analytiche*” or “*nappe*”.) The net effect of transversality is that one can leave at will certain strata, while staying on others. This implies the independency of smoothing crossings, and thereby a rigorous foundation to the small perturbation method. (The resulting graphical flexibility of algebraic curves is a pleasant way to create Riemann surfaces, and we shall exploit it later in this text as a way to explore degrees of Ahlfors circle maps.)

- Comessatti (more in the spirit of Klein) 1924–25–27/28–31–32–33, etc.
- Petrovskii 1938–49 ([636]), etc. many joint with Oleinik (real algebraic (hyper)surfaces and Betti numbers).
- Gudkov 1954–54–62–62–62–65–66–69–69–73 (those works include in particular the spectacular discovery of a sextic whose oval configuration was expected to be impossible by Hilbert).

- Arnold 1971–73.
- Rohlin 1972–72–73.
- Finally the long awaited (?) reunification of forces (call it maybe the Klein-Hilbert Verschmelzung) came in the work of Rohlin (himself apparently inspired by Arnold). Surprisingly, Rohlin took notice of Klein’s work quite late, ca. 1978 (compare Rohlin 1978 [706]).
- Then real algebraic geometry exploded through the work of Kharlamov, Viro, Fiedler, Nikulin 1979, Orevkov, Finashin, etc. and in the west Risler, Marin, and many others gave a new golden age to a discipline reaching a certain popularity.

Sometimes the real theory seems only to adapt over \mathbb{R} whatever has been achieved over \mathbb{C} , yielding usually a kaleidoscopic fragmentation of truths into a real zoology. Thus for instance the Castelnuovo-Enriques classification of (algebraic) surfaces can be pushed through reality: K3 (Nikulin-Kharlamov), Abelian surfaces (Comessatti-Silhol), elliptic surfaces, etc. The topic is then strongly allied to deep methods in differential topology, Galois cohomology, symplectic geometry, Gromov-Witten, enumerative problems, tropical geometry, etc. The present number of active workers is so impressive and the recent connections so amazing (Okounkov, etc.) that we prefer to stop here our impressionist touristic overview of real algebraic geometry.

2.2 Digression about Hilbert’s 16th problem (Klein 1922, Rohlin 1974, Kharlamov-Viro ca. 1975, Marin 1979, Gross-Harris 1981)

The connection between Klein’s theory (especially the ortho- and diasymmetric dichotomy) with Hilbert’s 16th problem (plane curves in the projective plane \mathbb{P}^2) were profoundly investigated by the Russian school in the early 1970’s especially Arnold, Rohlin, Viro, Kharlamov, etc. Klein himself always dreamed of such a relationship, without really being able to formulate its precise shape. Here is a quote which Klein added (ca. 1922) to his Werke (cf. [442, p. 155, footnote]):

Quote 2.1 (Klein 1922) Es hat mir immer vorgeschwebt, dass man durch Fortsetzung der Betrachtungen des Textes Genaueres über die Gestalten der reellen ebenen Kurven beliebigen Grades erfahren könne, nicht nur, was die Zahl ihrer Züge, sondern auch, was deren gegenseitige Lage angeht. Ich gebe diese Hoffnung auch noch nicht auf, aber ich muss leider sagen, dass die Realitätstheoreme über Kurven beliebigen Geschlechtes (welche ich aus der allgemeinen Theorie der Riemannschen Flächen, speziell der “symmetrischen” Riemannschen Flächen ableite) hierfür nicht ausreichen, sondern nur erst einen Rahmen für die zu untersuchenden Möglichkeiten abgeben. In der Tat sind ja die doppelpunktslosen ebenen Kurven n -ten Grades für $n > 4$ keineswegs die allgemeinen Repräsentanten ihres Geschlechtes, sondern wie man leicht nachrechnet, durch $(n-2)(n-4)$ Bedingungen partikularisiert. Da man über die Natur dieser Bedingungen zunächst wenig weiss, kann man noch nicht von vornherein sagen, dass alle die Arten reeller Kurven, die man gemäss meinen späteren Untersuchungen für $p = \frac{n-1 \cdot n-2}{2}$ findet, bereits im Gebiete besagter ebener Kurven n -ter Ordnung vertreten sein müßten, auch nicht, daß ihnen immer nur *eine* Art ebener Kurven entspräche. K.

It took several decades until the experimentally obvious conjecture (possibly anticipated by Klein, though he left no trace in print) that dividing curves in the plane have at least as many ovals as the half value of its degree found place in a paper of Gross-Harris 1981 [308, p. 177, Note]. In fact, in a paper by Alexis Marin 1979/81 [524] this is stated as a corollary of a Rohlin formula (1978 [706]), involving intersection of homology classes deduced from the halves of the dividing curve capped off by the interiors of ovals in $\mathbb{P}^2(\mathbb{R})$. In the case of M -curves (=the Russian synonym of Harnack maximal coined by Petrowskii 1938 [636]), this technique occurred earlier in Rohlin 1974/75 [705]. Moral: the tool missing to Klein was intersection theory of homology classes developed by Poincaré, Lefschetz, etc. In the little note Gabard 2000 [253] it is verified that this Rohlin-Marin obstruction ($r \geq \frac{m}{2}$) is the only one, settling thereby

completely the Klein-Gross-Harris question. This (simple) fact was known to Rohlin’s students Kharlamov and Viro which were familiar with this result as early as the middle 1970’s (as they both kindly informed me by e-mail). Of course the crucial ideas are due to Rohlin.

2.3 A long unnoticed tunnel between Klein and Ahlfors (Alling-Greenleaf 1969, Geyer-Martens 1977)

More importantly, for our present purpose is to keep the abstract viewpoint of Klein (by opposition to the embedded Hilbert’s 16th problem), and to make the following observation.

Theorem 2.2 (Klein?, Teichmüller 1941?, Ahlfors 1948/50, Matildi 1945/48?, Andreotti 1950?, who else?) *Dividing curves are precisely those admitting a real morphism (i.e., defined over the ground field \mathbb{R}) to the projective line \mathbb{P}^1 such that all fibers over real points consist entirely of real points.*

The non-trivial implication of this fact follows precisely from Ahlfors 1950 [17] (but is made very explicit only in Alling-Greenleaf 1969 [38], see also Geyer-Martens 1977 [290]). To my actual knowledge there is no record in print of this fact prior to Ahlfors’ intervention, modulo the cryptical allusion in Teichmüller 1941 [826] that the result was implicit in Klein’s works. Another related works are those of Matildi 1948 [536] and Andreotti 1950 [45]. As we shall recall later Ahlfors’ result was exposed at Harward as early as 1948 (cf. Nehari 1950 [591] reproduced here as Quote 11.3).

It is however picturesque to notice that an analog result stating that a real curve without real points maps through a real morphism upon the empty curve $x^2 + y^2 = -1$ (or projectively $x_0^2 + x_1^2 + x_2^2 = 0$) was established as long ago as Witt 1934 [892]. Perhaps both problems are of comparable difficulty, and the method employed by Witt—namely Abelian integrals—turns out to be likewise relevant to the Ahlfors context (i.e. dividing curves). Hence in our opinion, there were no technological obstruction to Ahlfors result being discovered much earlier, say by Witt in the 1930’s, or by Bieberbach in 1925 [97], or by Klein in the 1876–80’s, or even by Riemann in the late 1850’s (especially in view of his *Parallelogramm methode/Figuren*, cf. e.g., Haupt 1920 [340]), and ultimately why not by Abel himself? (Of course all these peoples were probably involved with more urgent tasks, like some *flüchtigen Versuche* about the Riemann hypothesis, or regarding Klein the *Grenzkreistheorem* (in his health taking contest with Poincaré), which later became known as the uniformization theorem. The list of competent workers coming also very close to the paradigm ultimately discovered by Ahlfors could easily be elongated: especially Schwarz, Hurwitz (esp. in 1891 [384]), Koebe, Courant (esp. in 1939 [191], 1940 [192] or 1950 [195]).

As to the interesting result of Witt 1934 (on invisible real curves), we will try to discuss it later in more details (Section 18.10).

2.4 Motivation (better upper bounds exist)

Even though Ahlfors’ result is approaching 65 years (a venerable age for retirement) the basic result looks still grandiose, and mysterious enough if one wonders about the exact distribution of Ahlfors’ degrees (as suggested in Yamada-Gouma’s penetrating study (1978–1998–2001), discussed in Section 14.1).

The writer published a paper in 2006 [255] where a circle map with fewer sheets (viz. $\leq r + p$) than that proposed by Ahlfors (namely $\leq r + 2p$) is exhibited. This quantitative improvement is the motivation for much of this survey, and will hopefully excuses the bewildering variety of topics addressed. An obvious game is to renegotiate known application of the Ahlfors’ mapping involving a controlled degree in the hope to upgrade the bound. As tactically simple as it may look, we were not very successful in this game as it often already requires analytical skills beyond the competence of the writer. Yet we

shall mostly content to list some articles where some upgrade could be expected (e.g., Hara-Nakai’s quantitative version of the corona with bounds [333] looks to be a challenging place to test). Of course for this *bound upgrading procedure* to work it requires that the application in question does not use the full strength of the Ahlfors function, but only its qualitative property of being a circle map. A concrete instance where this was accomplished is Fraser-Schoen’s paper 2011 [249].

Alternatively we can dream of certain high powered applications requiring the full extremal power of the Ahlfors mapping. In this case it is known a priori (Yamada-Gouma) that we cannot lower the degree of the Ahlfors function, except possibly for very particular choices of base-points.

So the main philosophical issue is roughly the following point:

Is the Ahlfors extremal property truly required in applications, or just the arcane residue of those attempt to rescue the Dirichlet principle via extremal methods. Put differently, is the extremal problem just an artefact of the proof or something really worth exploiting in practice?

2.5 Full coverings versus Ahlfors’ extremals

To avoid any confusion, one must from the scratch relativize strongly the importance of the recent contribution on the $r + p$ bound (Gabard 2006 [255]) for several reasons.

First the result is quite recent and probably not sufficiently verified as yet. In later sections when looking at explicit curves from the experimental viewpoint it seems that there is a large armada of potential counterexamples flying at high altitudes (flying fortresses).

Next, Ahlfors’ upper bound $r + 2p$ is known to be sharp within the realm of the extremal problem it solves. Indeed, Yamada 1978 [894] has a rather simple argument showing that the Ahlfors function centered at the Weierstrass points of a hyperelliptic membrane has degree precisely $r + 2p$ (and not less). Maybe it is an open question whether a similar sharpness holds for all membranes.

Hence, one must keep in mind a subtle distinction between Ahlfors’ deep extremal problem (involving hard analysis via the paradigm of extremality) and the writer’s soft version ([255]) which leads to a sharper bound but is based only upon (soft) topological methods, i.e. the Brouwerian degree and the allied criterion of surjectivity. To put it briefly, we must distinguish Ahlfors’ extremal function from the mere *circle map*, defined as follows (nomenclature borrowed from Garabedian-Schiffer 1950 [279, p. 182]):

Definition 2.3 *A circle map is an analytic function from a compact bordered Riemann surface to the disc, expressing the former as a (generally branched) cover of the disc, say $f: W \rightarrow D = \{|z| \leq 1\}$. Each interior points maps to an interior points of the disc (otherwise there is a problem as infinitesimally the mapping is a power map $z \mapsto z^n$, $n \geq 1$). Thus, the restricted covering $\partial W \rightarrow \partial D = S^1$ is unramified, whereupon it follows that $r \leq \deg(f)$ (i.e. the number of contours is a trivial lower bound for the degree of a circle map).*

Varied synonyms (or closely allied designations) are used throughout the literature (here is a little sampling with citation of the relevant sources):

- n fach bedeckende Fläche (Riemann 1857–Weber 1876 [689, p. 473]);
- Schottky 1877 no clear cut terminology, and re-reading it (25.06.12) in details I realize that the statement about existence of circle maps is in fact not really proved (thus much of the written is somewhat biased), note that Bieberbach somewhat wrongly ascribe the result as well to Schottky, but that remains to be elucidated... In contrast, Grunsky never (?) credits Schottky, but rather Bieberbach 1925 [97].
- mehrfach bedeckte Kreisscheibe, n -blättrige Kreisscheibe (Bieberbach 1925 [97, p. 6])
- mehrblättrige Kreise, n -blättrige Kreisscheibe (Grunsky 1937 [315, p. 40])
- cerchio multiplo (Matildi 1948 [536, p. 82], a student of Cecioni)

- full covering surface of the unit circle (Ahlfors 1950 [17, p. 124, p. 132])
- $(2g+m)$ -sheeted unbounded covering surface of the unit disc (Encyclopedic Dictionary of Mathematics 1968/87 [223, p. 1367])
- unbounded finitely sheeted covering surfaces of the unit disc (Nakai 1983 [579, p. 164])
 - Schottky functions (Garabedian-Schiffer 1949 [275, p. 214], Kühnau 1967 [484, p. 96], and earlier (yet without this appellation) in several works of Picard, e.g. Picard 1913 [644] and Cecioni, e.g. Cecioni 1935 [164])
 - p -times covered unit-circle (Bergman 1950 [84, p. 87, line 5])
 - n -times covered circle, multiply-covered circle (Nehari 1950 [591, p. 256, resp. p. 267], Stanton 1971 [797, p. 289 and 293] Aharonov-Shapiro 1976 [11, p. 60])
 - Ahlfors mapping (Nehari 1950 [591, p. 256, p. 267], Stanton 1971 [797, p. 289 and 293])
 - Ahlfors function (Aharonov-Shapiro 1976 [11, p. 60])
 - Ahlfors map (Alling 1966 [36, p. 345–6], Stout 1967 [804, p. 274], and then in many papers by Bell)
 - Ahlfors type function (Yakubovich 2006 [893, p. 31]).
 - Einheitsfunktionen (Carathéodory 1950 [148, vol. II, p. 12]), translated as:
 - *unitary* function in Heins 1965 [359, p. 130], a jargon also used by Fay 1973 [232, p. 108, 111, etc.].
 - unimodular function (Douglas-Rudin 1969 [213], Fisher 1969 [237], Gamelin 1973 [266], Lund 1974 [519])
 - many-sheeted disc (Mori 1951 [570])
 - multi-sheeted circle (Havinson 1953 [342])
 - finitely sheeted disks (Hara-Nakai 1985 [333])
 - Vollkreisabbildung (Meschkowski 1951 [548, p. 121]),
 - (volle) n -blättrige (Einheits)Kreisscheibe (Golusin 1957 [296, p. 240, 412]),
 - interior mappings (Stoilow, Beurling),
 - inner functions (Beurling 1949, Hoffman 1962 [381] (esp. p. 74, where Beurling is credited of the coinage), Rudin 1969 [723], Stout 1972 [805, p. 343]). This concept usually refers to analytic functions with modulus a.e. equal to one along the boundary, but some writers corrupted this sense to mean a circle map, cf. Stout 1966/67 [803] which is followed by Fedorov 1990/91 [233, p. 271].
 - boundary preserving maps (Jenkins-Suita 1984 [394]); maps taking the boundary into the boundary (Landau-Osserman 1960 [493]).
 - complete covering surfaces (cf. Ahlfors-Sario 1960 [22, p. 41–42, § 21A]), i.e. one such that any point in the range has a neighborhood whose inverse image consists only of compact components; complete Klein coverings (Andreian Cazacu 2002 [44]) (a direct extension of the former concept shown to be equivalent in the case of finite coverings to the next conception of Stoilow).
 - total Riemann coverings (Stoilow 1938 [800]), i.e. one such that any sequence tending to the boundary has an image tending to the boundary.
 - unlimited covering surfaces (Nakai 1988 [581], EDM=Japanese encyclopedia 1968/87 [223], Minda 1979 [555])
 - proper (holomorphic) maps (onto the unit disc) (e.g., Bedford 1984 [60, p. 159], Bell 1999 [68, p. 329], Černe-Flores 2007 [168], Fraser-Schoen 2011 [249]).
 - distinguished map (Jurcescu 1961 [413])
 - Myrberg surface over the unit disc (Stanton 1975 [798, p. 559, § 2] uses this terminology for a Riemann surface W admitting an analytic function $z: W \rightarrow \Delta$ realizing W as an n -sheeted, branched, full covering surface of the unit disc Δ). As no ramification appears along the boundary, explains the naming:
 - Randschlicht mapping (Köditz-Timann 1975 [470]).

In fact the writer came across this concept through real algebraic geometry where I used (2006 [255]) the term *saturated*, whereas Coppens 2011 [183] proposes the term *separating* morphism.

We shall attempt to reserve the designation *Ahlfors maps/functions* for those solving the extremal problem formulated in Ahlfors 1950 [17]. The latter are known (since Ahlfors 1950 [17]) to be circle maps, but the converse is wrong.

Indeed, circle maps may have arbitrarily large degrees (post-compose with a power map $z \mapsto z^n$ for some large integer n), whereas Ahlfors maps have degrees $\leq r + 2p$ (in view of the deep result in Ahlfors 1950 [17]).

Are circle maps of degree compatible with Ahlfors' bound always realizable via an Ahlfors map? The answer seems to be in the negative, at least if attention is restricted to infinitesimal Ahlfors maps. This follows from Gouma's restriction (1998 [297]) in the hyperelliptic case. Indeed consider a 2-gonal membrane, then post-composing with $z \mapsto z^n$ we get circle maps of degrees ranging through all multiples $2n$, whereas only 2 and $r + 2p$ are realized as degrees of Ahlfors maps, by a result of Gouma 1998 [297]. Note that Gouma restricts to punctual Ahlfors maps and our claim is only firmly established in this context.

A somewhat deeper question is whether any (or at least one) circle map of smallest degree arises via an Ahlfors map. We were not able to settle this question, but in a tour de force Yamada 2001 [897] proved this in the hyperelliptic case. It would be interesting to know if the Ahlfors map is flexible enough to capture a circle map of the lowest possible degree (alias the gonality). Let us optimistically pose the conjecture, amounting to say that we can essentially take out the best of the two worlds:

Conjecture 2.4 *Any (or at least one) conformal mapping realizing the gonality arise as an Ahlfors extremal function $f_{a,b}$ (perhaps for coalescing two points yielding then the Ahlfors map f_a maximizing the modulus of the derivative).*

Recent work by Marc Coppens 2011 [183] supplies a sharp understanding of the gonality γ as spreading through all permissible values $r \leq \gamma \leq r + p$ when the membrane is varied through its moduli space.

Paraphrased differently the conjecture wonders if a suitable Ahlfors map always realizes the gonality. As yet we lack evidence, but the vague feeling that Ahlfors' method is the best possible (being distilled by the paradigm of extremality) inclines one to believe that its economy should be God given. In contradistinction, it may be argued that Ahlfors maps depends on so few parameters (essentially one or two points on the surface), that they are perhaps not flexible enough to explore the full room of all circle maps. Such simple minded question exemplifies that the old subject of the Ahlfors' map still deserves better understanding. A fine understanding of the Ahlfors map would truly be worth studying if we had some clear-cut application in mind (taking full advantage of the extremal property of the map). In practice, one is often content with the weaker notion of circle maps, but in the long run it is likely that more demanding applications requires the full punch of the Ahlfors map.

2.6 Sorting out applications: finite vs. infinite/compact vs. open

As to applications (of the Ahlfors map), there are several ramifications, which—at the risk of oversimplification—may be ranked in two headings (*in finito* vs. *in infinito*). By this we have in mind essentially the sharp opposition between compact and non-compact Riemann surfaces. The later were intensively approached by several schools (mostly Finnish, Japanese and US), but the theory is certainly less complete than for compact surfaces, which from our viewpoint already represent a serious challenge. Furthermore it is evident that there is essentially one and only one road leading from the finite to the infinite namely the exhaustion process affording a cytoplasmic expansion of a compact bordered Riemann surface in some ambient open surface. Now let us enumerate such applications.

(A) **Lifting truth from the disc via conformal transplantation.** A reliable philosophy is roughly that a result known to hold good in the disc is lifted via the Ahlfors map to configurations of higher topological type. This is the strategy used by Alling 1964 [34] to transplant the corona of Carleson 1962 [154] to Riemann surfaces. (The corona theorem amounts to say that the

Riemann surface is dense in the maximal ideal space of its algebra of bounded analytic functions.)

In spectral theory this method (systematically utilized by Polyá-Szegő) is known as “*conformal transplantation*”. Subsequent elaborations arose through the work of Hersch 1970 [372] and Yang-Yau 1980 [898] (where branched covering are admitted, thereby diversifying widely the topology).

Recently Fraser-Schoen 2011 [249] applied the Ahlfors mapping to spectral theory (Steklov eigenvalues). (This inspired a note of the writer [256] extending Hersch 1970’s study of Dirichlet and Neumann eigenvalues on spherical membranes to arbitrary (compact) bordered surfaces.) Another spectacular work is due to Girouard-Polterovich 2012 [291] where Fraser-Schoen’s work is extended to higher eigenvalues.

(B) **Exhaustion and infinite avatars.** Another philosophy (Nevanlinna, Ahlfors, etc.) is to exploit the fact that (infinite, i.e. open Riemann surface) may be exhausted by compact subregions (reminding somehow the finitistic slogan of André Bloch, “*Nihil est in infinito...*”) offering thereby a wide range of application of compact bordered Riemann surfaces to the more mysterious realm of open Riemann surfaces. This ramifies quickly to the so-called classification theory of Riemann surface (Nevanlinna 1941 [610], Ahlfors 46, Sario 46–49, Parreau 1951 [634], Royden 1952 [714], etc.) much completed by the Japanese school (Tôki 1951, A. Mori, Kuramochi, Kuroda, etc.). Several books attempt to give a coherent account of this big classification theory, e.g. Ahlfors-Sario 1960 [22], Sario-Nakai 1970 [740], where the guiding principle (due to Sario 1946) is to classify surfaces according to the force of their ideal boundary.

In another infinite direction, S. Ya. Havinson 1961/64 [345] was the first (with Carleson 1967 [155]) to extend the theory of the Ahlfors function to domains of infinite connectivity, and was followed by S. Fisher 1969 [238], which propose some simplifications.

The Slovenian school of complex geometry (Černe, Forstnerič, Globevnik, etc.) are also employing the Ahlfors function, often in connection with the open problem (Narasimhan, Bell, Gromov, etc.) of deciding if any open Riemann surface embeds properly in \mathbb{C}^2 . In Forstnerič-Wold 2009 [247] reduced the full problem to a finitary question as to whether each compact bordered Riemann surface embeds holomorphically in the plane \mathbb{C}^2 . (Maybe this is achievable by a suitable of Ahlfors functions, or more sophisticated variant thereof like (?) in the broader Pick-Nevanlinna context). As suggested by those authors, it is maybe enough to embed one representant in each topological type (this is possible, compare Černe-Forstnerič 2002 [166, Theorem 1.1]) and try to use a continuity argument through the Teichmüller (moduli) space.

3 Biased recollections of the writer

3.1 Klein’s viewpoint: real curves as symmetric Riemann surfaces (as yet another instance of the Galois-Riemann Verschmelzung)

If the writer is allowed to recollect his own memories about his involvement with this circles of ideas, it started as follows. Maybe a natural point of departure is the (basic) algebraic geometry of curves. While reading Shafarevich’s Basic algebraic geometry (ca. 1998) one encounters some nice drawings of the real locus of a plane cubic into its complex locus materialized by a torus (as we know since time immemorial: Euler?, Abel?, Jacobi, Riemann, etc.). A torus of revolution reflected across a plane cutting the torus along two circles yields a plausible visualization of the embedding of $C(\mathbb{R})$ into $C(\mathbb{C})$ (even with the symmetry induced by the complex conjugation).

Of course there are also real cubic curves whose real loci possess only one component. How to visualize the corresponding embedding? Lee Rudolph quickly helped us by just realizing that the Galois action (complex conjugation)

acts over the torus $S^1 \times S^1$ just by exchanging the two factors $(x, y) \mapsto (y, x)$ fixing thereby the diagonal (circle) $\{(x, x)\} \approx S^1$.

More generally how to picture out the topology of a real curve? The first observation is that the complex locus $C(\mathbb{C})$ is acted upon by complex conjugation σ relative to some ambient projective space $\mathbb{P}^n(\mathbb{C})$ (where after all the concrete curve is embedded). Therefore to each real curve C is assigned a *symmetric surface* $(C(\mathbb{C}), \sigma) = (X, \sigma)$ consisting of a pretzel X together with an orientation reversing involution $\sigma: X \rightarrow X$. (For aesthetical reasons all of our algebraic curves are projective and non-singular, prompting thereby compactness of the allied Riemann surfaces.) With the invaluable assistance of (overqualified scholars) Claude Weber and Michel Kervaire, I learned how to classify such objects, according to the invariants (g, r, a) where g is the genus of X , r the number of “ovals” (fixed under σ), and a is the invariant counting mod 2 the number of components of $X - \text{Fix}(\sigma)$. In other words $a = 0$ corresponds to the separating (or dividing) case where $\text{Fix}(\sigma)$ disconnects X , whereas $a = 1$ means that the fixed locus does not induce a morcellation of the surface.

I soon realized thanks to the paper Gross-Harris 1981 [308], that all this material was a well-known game for Felix Klein, who was essentially the first to classify symmetric surfaces taking advantage of the just established classification of compact bordered surfaces (Möbius 1863 [565], Jordan 1866 [401], etc.). The key trick is of course the yoga assigning to (X, σ) its quotient $X/\sigma =: Y$ by the involution, and moving upward again via the orientation covering supplied by local orientations. If the point lies on the boundary then there is no duplication of the point by local orientations (alias “indicatrix” in older literature).

Theorem 3.1 (Klein 1876 [432]=[442, p. 154], explicit in Klein 1882 [434], Weichold 1883 [873]) *There is one-to-one correspondence between symmetric surfaces and compact bordered surfaces. Moreover the correspondence extends to the realm of conformal geometry, i.e. Riemann surfaces or Klein surfaces, if you prefer.*

Remark 3.2 Modernized treatments of this Klein correspondence—say compatible with Weyl–Radó’s (1913/1925) abstract conception of the Riemann surface—are plenty, compare, e.g. Teichmüller 1939 [825, p. 99–101, Die Verdoppelung, §92, 93]=[827], Schiffer–Spencer 1954 [753, p. 29–30, §2.2], Alling–Greenleaf 1971 [39].

Via this dictionary, it is plain that the dividing case corresponds precisely to the orientable case. [As a matter of terminology, Klein used (since Wintersemester 1881/82) the jargon *orthosymmetrisch* versus *diasymmetrisch* corresponding to the dividing respectively non-dividing case. For instance Weichold 1883 [873, p. 322] writes:

Quote 3.3 (Weichold 1883) Was ferner die symmetrischen Riemann’schen Flächen anbelangt, deren Betrachtung die Grundlage der folgenden Untersuchung bildet, so sind auch diese schon mehrfach behandelt worden, wenn auch zum Theil unter ganz anderen Gesichtspunkten. Es hat sich nämlich Herr Professor Klein in den Bänden VII und X der Mathem. Annalen in den Aufsätzen mit dem Titel: “Über eine neue Art von Riemann’schen Flächen” mit diesen Flächen eingehender beschäftigt und daselbst auch schon die Hauptunterscheidung derselben in orthosymmetrische und diasymmetrische Flächen aufgestellt. Diese Bezeichnung findet sich allerdings noch in keiner Publication angewendet; sie wurde zuerst in einem in Wintersemester 1881/82 von Herrn Professor Klein abgehaltenen Seminar eingeführt, in welchem derselbe auch die weiter unten erwähnte weitergehende Classification mittheilte und bei welchem auch der Verfasser die unmittelbare Anregung für die vorliegende Arbeit empfing.

Perhaps it is worth tracking down further Klein’s motivation for this “savant” terminology; for this we supply the following extract:

Quote 3.4 (Klein 1923 [443, p. 624]) Die Benennungen “diasymmetrisch” und “orthosymmetrisch” für die beiden Klassen symmetrischer Flächen wurden später von mir gerade wegen der im Text berührten Verhältnisse eingeführt; siehe Bd. 2 dieser Ausgabe, S. 172. Vgl. auch Fußnote ⁵⁸⁾ auf S. 565/566 im vorliegenden Bande. K.

So this brings us at other places, the first cross-reference leads us to the following quote (whereas Fußnote ⁵⁸) is merely a text written by Vermeil, not really worth reproducing here):

Quote 3.5 (Klein 1892 [438]=[442, p. 172]) Reelle algebraische Kurven ergeben *symmetrische* Riemannsche Flächen und können umgekehrt allgemein gültig von letzteren aus definiert werden, das ist der hier fundamentale Satz, den ich in §21 meiner Schrift entwickelte. Ich bezeichne dabei eine Riemannsche Fläche als *symmetrisch*, wenn sie durch eine konforme Abbildung zweiter Art von der Periode 2 in sich übergeführt wird (i.e. durch eine konforme Abbildung, welche die Winkel umlegt). Die *symmetrischen* Riemannschen Flächen eines gegebenen p zerfallen, wie ich ebendort angab und Herr Weichold a. a. O. eingehender ausgeführt hat, nach der Zahl und Art ihrer “Symmetrielinien” in $\lfloor \frac{3p+4}{2} \rfloor$ Arten. Wir haben erstlich $\lfloor \frac{p+2}{2} \rfloor$ Arten *orthosymmetrischer* Flächen bez. mit $p+1, p-1, p-3, \dots$ Symmetrielinien; das sind solche *symmetrische* Flächen, welche längs ihrer Symmetrielinien zerschnitten, in zwei (zueinander *symmetrische*) Hälften zerfallen; — das einfachste (zu $p=0$ gehörige) Beispiel ist eine Kugel, welche durch “*orthogonale*” Projektion auf sich selbst bezogen ist —. Wir haben ferner $(p+1)$ Arten *diasymmetrischer* Flächen bzw. mit $p, p-1, \dots, 1, 0$ Symmetrielinien; das sind Flächen, die längs ihrer Symmetrielinien zerschnitten gleichwohl noch ein zusammenhängendes Ganzes vorstellen; — man vergleiche bei $p=0$, die durch eine “*diametrale*” Projektion auf sich selbst bezogene Kugel. —

Hence to summarize this explanation of Klein, the fundamental dichotomy seems to be motivated by the basic case of genus 0 (the sphere), which may be acted upon in two fashions by a sense-reversing involution (orthogonal vs. diametral). This basic motivation is even more emphasized in Klein’s lectures, worth reproducing (despite its very elementary character):

Quote 3.6 (Klein 1891/92 [440, p. 138–9]) Wir beginnen damit, anzugeben, auf wieviel verschiedene Weisen eine Kugel mit sich selbst *symmetrisch* sein kann (d.h. durch eine Σ von der Periode 2 in sich selbst übergehen kann). Das ist offenbar auf 2 wesentlich verschiedene Arten möglich: das eine Mal bezieht man die Kugel auf sich selbst durch eine *Centralprojektion*, deren Centrum außerhalb liegt:

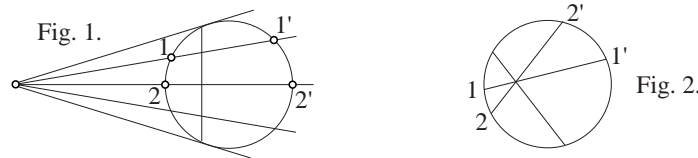

($1, 1'; 2, 2'; \dots$ sind entsprechende Punkte), das zweite mal durch eine *Centralprojektion*, deren Centrum sich innererhalb der Kugel befindet.

Im ersten Falle giebt es auf der Kugel eine sogenannte Symmetrielinie, deren Punkte bei der Umformung sämtlich festbleiben, das ist der Schnitt der Kugel mit der Polarebene des Projectionscentrums; im 2^{ten} Falle giebt es eine solche Symmetrielinie nicht. Wir haben damit dasjenige Unterscheidungsmerkmal, nach welchem wir sogleich die *symmetrischen* Flächen einteilen: nach der Zahl und Art der Symmetrielinien. Erwähnen wir da gleich die Terminologie, welche ich anlässlich der Figuren 1 und 2 in Vorschlag gebracht habe. Figur 1 kann insbesondere so gezeichnet werden, daß das Projectionscentrum unendlich weit liegt. Die Polarebene wird dann eine Diametralebene und die zugehörige Centralprojektion eine orthogonale Projektion. Ich sage dementsprechend überhaupt von der Figur 1, die Kugel sei bei der selben orthosymmetrisch auf sich selbst bezogen. Die bei Figur 2 vorliegende Beziehung aber nenne ich diasymmetrisch, insofern bei ihr das Projectionscentrum, insbesondere in den Mittelpunkt der Kugel rücken kann, worauf je zwei diametrale Punkte der Kugel zusammengeordnet erscheinen. Diese Benennungen “*orthosymmetrisch*” u. “*diasymmetrisch*” übertrage ich dann demnächst in noch zu erklärender Weise auf die Flächen eines beliebigen p .

Ahlfors result precisely affords a deeper function-theoretical propagation of this Kleinian paradigm: orthosymmetric surfaces are precisely those mapping in totally real way to the orthosymmetric sphere!

The Russian school (Gudkov, Rohlin, Kharlamov, Viro, etc.) uses the (less imaginative) nomenclature Type I versus Type II, whose labelling is pure convention vintage; yet still a heritage from Klein’s initial nomenclature of 1876 [432]=[442, p.154] reproduced in the following:

Quote 3.7 (Klein 1876) Andererseits ergibt sich für die Kurven, deren Zügelzahl $C > 0$, $C < p + 1$ eine bemerkenswerte Einteilung in zwei Arten.

Die Kurven der ersten Art haben die Eigenschaft, daß ihre Riemannsche Fläche, längs der C Züge zerschnitten, zerfällt: bei den Kurven der zweiten Art findet ein solches Zerfallen nicht statt.

Rohlin 1978 [706, p. 90] refers explicitly to Klein as follows:

Quote 3.8 (Rohlin 1978) Following Klein (see [4], p.154), we say that α belongs to type I if A splits $\mathbb{C}A$ and to type II if A does not split $\mathbb{C}A$. For example, M -curves obviously belong to type I.

It is worth recalling that Rohlin made a surprisingly late discovery of Klein’s work as shown by the following extract:

Quote 3.9 (Rohlin 1978 [706, p. 85]) As I learned recently, more than a hundred years ago, the problem of this article occupied Klein, who succeeded in coping with curves of degree $m \leq 4$ (see [4], p.155). I do not know whether there are publications that extend Klein’s investigations.

It is concomitant to speculate that the infamous *Klein bottle* (= *Kleinsche Fläche* which traversed the Atlantic as a “Flasche”) probably originated during Klein’s study of real curves. It just amounts to have a real curve of genus one without real points, whose complex locus will be a torus (of revolution) acted upon by a diametral involution $(x, y, z) \mapsto (-x, -y, -z)$.

3.2 Criterion for Klein’s orthosymmetry=Type I, in Russian (Klein 1876–82; Rohlin 1978, Fiedler 1978 vs. Alling-Greenleaf 1969, Geyer-Martens 1977)

Klein’s dichotomy for symmetric surfaces prompts for criterion detecting the dividing character of a real curve.

The writer knows of essentially two methods: the first being genetic and the other qualifiable of synthetic. Despite their simplicity those criteria were overlooked by Klein, who relied upon more complicated arguments (cf. the following optional remark).

Remark 3.10 Besides, there are several other original methods due to Klein. One involves the dual curve, and more specifically a representation assigning to each imaginary point of the curve the real line passing through it and its conjugate. When the points becomes real the limiting position of this secant becomes the tangent. In this way Klein manages to visualize the complex locus of a plane curve living in the 4D-space $\mathbb{P}^2(\mathbb{C})$ onto a the 2D real projective plane as a multiple cover, and to guess the type of the curve. Beautiful pictures are to be found in vol. II of his *Ges. math. Abhandl.* [442]). Another brilliant argument of Klein involves a degeneration to the hyperelliptic case.

Genetic method. This is essentially a *surgery* (if we may borrow the jargon of Thom, Milnor, etc.), and applies primarily to curves obtained by small perturbation of two curves whose type is known. Maybe it is best explained on a specific example. Consider the *Gürtelkurve* as a small deformation of two conics having two nested ovals. (*Gürtel* means “belt”, a nomenclature coined by Klein in 1876 [431]=[442, p.111], presumably as a translation of the term “*quartique annulaire*” used by Zeuthen in 1874 [909, p. 417+Tafel I., Fig. 1].) Each conic corresponds to an equatorial sphere, and each smoothing amounts attaching a handle. During the process one can keep track of the two real braids to make a global drawing of the surface (compare right part of Figure 6).

Some contemplation of the drawing shows that when all smoothings are dictated by orientations then the resulting curve is dividing. Thus the Gürtelkurve is dividing. Indeed in this case all handles contains twisted braids and thus when travelling in the imaginary locus, say starting from position A in the north (top) hemisphere of the left sphere and moving to the right sphere via an handle we reach position B in the south hemisphere of the right sphere. Coming back to the left sphere, the twisting forces a return to the north hemisphere. We are thus never able to visit the south hemisphere of the left sphere.

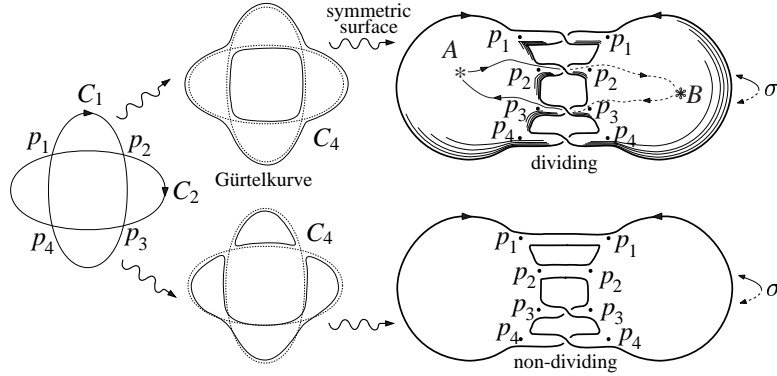

Figure 6: Dividing character of the Gürtelkurve via surgery

Synthetic method. Another way to see the dividing character of the Gürtelkurve involves looking at the pencil of lines through a point lying deepest inside the two nested ovals (Figure 7). Since each real line of this pencil cuts the quartic C_4 along a totally real collection of points, this induces a map between the imaginary loci $C_4(\mathbb{C}) - C_4(\mathbb{R}) \rightarrow \mathbb{P}^1(\mathbb{C}) - \mathbb{P}^1(\mathbb{R})$. It follows that C_4 is dividing since \mathbb{P}^1 is. (Just use the fact that the continuous image of a connected set is connected.)

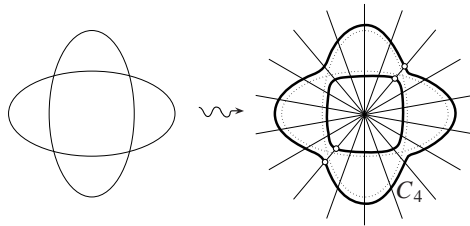

Figure 7: Gürtelkurve is dividing via a totally real morphism to the line.

More generally, this argument gives the following criterion (which quite curiously seems to have escaped Felix Klein's attention, cf. e.g. his lectures notes 1891–92 [440, p. 168–69], where in our opinion Klein draws the orthosymmetric character of the Gürtelkurve from more complicated arguments than those just given):

Lemma 3.11 *If a real curve permits a morphism to the line whose fibers over real points are exclusively real, then the curve is dividing.*

Conversely, one may wonder if any dividing curve is expressible as such a totally real cover of the line. I clearly remember having asked this question at several experts (ca. 1999), yet without receiving clear-cut answers, and so decided to embark on a self-study of this question. Being a slow and superficial worker, I needed circa 2 years of work until getting an answer, which turned to be positive:

Proposition 3.12 (Gabard 2001, first published in 2004) *Any dividing real curve admits a totally real morphism to the line. Moreover the degree of such a morphism can always be chosen $\leq g + 1$, where g is the genus of the curve.*

Having completed this work, I started some detective work, and via papers of Geyer-Martens 1977 [290] and Alling-Greenleaf 1969 [38] (probably located via the bibliography of a survey by Natanzon 1990 [585]) realized that L. V. Ahlfors already proved this result in 1950 (and even exposed his results at Harvard in 1948 as reported in Nehari 1950 [591]). This was a great deception, or rather more my first contact with the (glamorous) L. V. Ahlfors.

Very anecdotic details: However as Ahlfors' result was not fairly well-known (among the real algebraic geometry community) I received a nice invitation to expose this re-discovery in a RAAG-conference at Rennes in 2001. It was a great pleasure to meet for the first time great specialists like Johannes Huisman, Natanzon, Finashin, Viro, etc. My original proof involved an argument with incompressible fluids and Abel's theorem to prove (3.12). Some one week after the talk (or maybe even during the week of that conference yet preceding my talk), I confusedly realized that my argument was probably vicious, and re-worked it completely to find a topological parade, amounting to the paragraphs 5,6 of Gabard 2006 [255]. This argument looked more tangible and I was again invited to Rennes in 2001–2002 (by J. Huisman) to present it at a specialized seminar. At this stage I started to believe that one could improve the bound $g + 1$ into $\frac{r+g+1}{2}$, which is the mean value of the number of ovals r and the so-called *Harnack bound* $r \leq g + 1$. (In the abstract setting is truly a remark of Klein directly reducible to Riemann's definition of the genus as the maximal number of retro-sections practicable on the pretzel without disconnecting, compare Klein 1876 [432, §7].) I needed some weeks (or months?) to establish this sharper version which gave a relative progress over Ahlfors.

Theorem 3.13 (Gabard 2002, published 2004, 2006 [255]) *Any dividing real curve admits a totally real morphism to the line \mathbb{P}^1 of degree $\leq \frac{r+g+1}{2}$, where g is the genus of the curve and r the number of "ovals" (=reellen Züge).*

Using the Schottky(-Klein) double of a compact bordered Riemann surface (whose genus is visually seen to be $g = (r - 1) + 2p$) this can be translated as

Theorem 3.14 *Any compact bordered Riemann surface with r contours of genus p is conformally representable as full covering of the disc of degree $\leq r + p$.*

4 Dirichlet's principle (Überzeugungskraft vs. mathematical comedy)

This section (with parenthetical title derived from jokes by Hilbert 1905 [376] and Monna 1975 [566] resp.) recalls the early vicissitudes of a principle supported by strong physical evidence (as early as Green 1828 [302] in print), which Riemann placed as the grounding for the edification of the theory of conformal mappings (and the allied Abelian integrals). This section can be skipped without any further ado, but it fixes the context out of which emerged (simpler?) variational problems more suited to pure function-theoretical purposes. However, Dirichlet's principle (after Hilbert's resurrection) pursued his life (especially in the fingers of Courant) and merged again to our main topic of the Ahlfors mapping (at least in the schlichtartig situation handled by Riemann-Schottky-Bieberbach-Grunsky). Of course, this "Dirichlet" line of thought is very active today, e.g., by Hildebrandt and his collaborators. In short, Dirichlet's principle flourished above any expectation by Riemann, was "killed" by Weierstrass, but resurrected by Hilbert, yet re-marginalized by extremal methods (Fejér-Riesz, Carathéodory, Ostrowski, Grunsky, up to Ahlfors) and re-flourished by Douglas and Courant as a (reliable) instrument for the existence of conformal mappings.

4.1 Chronology (Green 1828, Gauss 1839, Dirichlet ca. 1840, Thomson 1847, Kirchhoff 1850, Riemann 1851–57, Weierstrass 1870, etc.)

Apart from a early contribution of Gauss 1825 [286] about local isothermic parameters (conformal mappings in the small), the “global” theory of such mappings emerged from Riemann’s thesis 1851 [686] and his subsequent work 1857 [687] on abelian functions. A landmark is the *Riemann mapping theorem* (RMT) (cf. Riemann 1851 [686], and Riemann 1857 [687]), derived from the so-called *Dirichlet principle*. This was apparently formulated by Dirichlet as long ago as the early 1840’s (lectures in Berlin, attended by Riemann in 1847/49). (The Göttingen 1856/57 version of those were published by Grube in 1876 as [208].) Independent formulations (or utilizations) of this principle are due to Gauss 1839 [287], Thomson 1847 [828] (popularizing the long neglected work of Green 1828 [302]) and Kirchhoff 1850 [426]. It is known that Riemann knew all those works (when exactly in another question) from a manuscript estimated 1855/60 reproduced below (source=Neuenschwander 1981 [598, p.225]). Riemann does not cite Thomson and Kirchhoff in 1857 [687].

Quote 4.1 (Riemann 1855/60) Mit dem Namen des Dirichlet’schen Princip’s habe ich eine Methode bezeichnet, um nachzuweisen, daß eine Function durch eine partielle Differentialgleichung und geeignete lineare Grenzbedingungen völlig bestimmt ist, d. h. daß die Aufgabe, eine Function diesen Bedingungen gemäß zu bestimmen, eine Lösung und zwar nur eine einzige Lösung zuläßt. Es ist diese Methode von William Thomson in seiner Note Sur une équation aux différences (Liouville. T. 12. p. 493.) und von Kirchhoff in seiner Abhandlung über die Schwingungen einer elastischen Scheibe angewandt worden, nachdem Gauß schon vorher eine Aufgabe, welche als ein specieller Fall dieser Aufgabe betrachtet werden kann, ähnlich behandelt hatte (Allgemeine Lehrsätze. Art. 29–34.) Ich habe diese Methode nach Dirichlet benannt, da ich von Hrn Professor Dirichlet erfahren hatte, daß er sich dieser Methode schon (seit dem Anfang der vierziger Jahre (wenn ich nicht irre) [Bl. 66r]) in seinen Vorlesungen bedient habe.

There is also a letter of Riemann dated 30. Sept. 1852 (cf. Neuenschwander 1981 [597]), where it is reported that Dirichlet supplied some references to Riemann. Here is the relevant extract, out of which we may speculate that Riemann learned the ref. to Thomson and Kirchhoff at this occasion (through Dirichlet).

Quote 4.2 (Riemann 1852, 30. Sept.) Am Freitag Morgen, um in meinem Berichte fortzufahren, suchte Dirichlet mich in meinem Zimmer auf. Ich hatte ihn bei meiner Arbeit um Rath gefragt und er gab mir nun die dazu nöthigen Notizen so vollständig, daß mir dadurch die Sache sehr erleichtert ist. Ich hätte nach manchen Dingen auf der Bibliothek sonst lange suchen können. D.[irichlet] war überhaupt äußerst nett theilte mir mit, womit er sich in den letzten Jahren beschäftigt hatte, ging meine Dissertation mit mir durch; und so hoffe ich, daß er mich auch später nicht vergessen und mir seine Theilnahme schenken wird.

As we know the principle was disrupted by the (non-fatal) Weierstrass’ critique 1870 [874], but resuscitated by Hilbert in 1900-1 [374] [375] [376], after partial results by Neumann 1870, 1878 [601], and 1884 [602] Schwarz 1869/70 [769], 1870 [772], 1872 [773] (*alternierendes Verfahren*) and Poincaré for fairly general boundary contours.

Dirichlet’s principle (as Riemann christened it in 1857 [688]) amounts to solve the first boundary value problem for the Laplacian $\Delta u = 0$ by minimizing the Dirichlet integral

$$\iint \left\{ \left(\frac{\partial u}{\partial x} \right)^2 + \left(\frac{\partial u}{\partial y} \right)^2 \right\} dx dy.$$

As a such the paradigm of *extremality* entered the arena of geometric function theory since its earliest day, and governed much of the subsequent developments.

Other noteworthy hot spots in this realm are:

- *The Bieberbach conjecture* (1916 [96]) $|a_n| \leq n$ on the coefficients of schlicht (=univalent=injective) functions from the disc $\Delta = \{|z| < 1\}$ to the (finite) plane \mathbb{C} with Koebe's function $k(z) = \frac{z}{(1-z)^2} = z + 2z^2 + 3z^3 + \dots$ as unique extremals among those satisfying the normalization $f(0) = 0, f'(0) = 1$. Completely solved by de Branges 1984.

- Grötzsch-Teichmüller extremal quasi-conformal mappings (1928–1939 [825]), i.e. the search of the “möglichst konform” mapping relating two configurations. This gave a sound footing to Riemann's liberal study of the moduli spaces (1857 [687]), and paved the way to the modern theory of deformation of complex structures (Kodaira-Spencer).

4.2 Early suspicions about the Dirichlet principle (Weierstraß 1859/70, Schwarz 1869, Prym 1871, Hadamard 1906)

Weierstrass seems to have been the first to express doubts about the Dirichlet principle, pivotal to Riemann's theory. Weierstrass lectured on his critic in 1870, and this appeared in print as late as 1894 in his *Werke*. However it is known that a meeting between Riemann and Weierstrass took place in Berlin, 1859, where this issue was discussed. Klein reports upon Riemann's reaction at several places:

Quote 4.3 (Klein 1926 [444, p. 264]) Er [Riemann] erkannte die Berechtigung und Richtigkeit der Weierstraßschen Kritik zwar voll an; sagte aber, wie mir Weierstraß bei Gelegenheit erzählte: “er habe das Dirichletsche Prinzip nur als ein bequemes Hilfsmittel herangeholt, das gerade zur Hand war—seine Existenztheoreme seien trotzdem richtig.” Weierstraß hat sich dieser Meinung wohl angeschlossen. Er veranlaßte nämlich seinen Schüler H. A. Schwarz, sich eingehend mit den Riemannschen Existenzsätzen zu befassen und andere Beweise dafür zu suchen, was durchaus gelang.

Quote 4.4 (Klein 1923 [443, p. 492, footnote 8]) Ich erinnere mich, daß Weierstrass mir bei Gelegenheit erzählte, Riemann habe auf die Gewinnung seiner Existenzsätze durch das “Dirichletsche Prinzip” keinerlei entscheidenden Wert gelegt. Daher habe ihm auch seine (Weierstrass') Kritik des “Dirichletschen Prinzips” keinen besonderen Eindruck gemacht. Jedenfalls ergab sich die Aufgabe, die Existenzsätze auf andere Art zu beweisen. Diese dürfte dann Weierstrass seinem Spezienschüler Schwarz übertragen haben, bei dem er die erforderliche Verbindung geometrisch-anschaulichen Denkens mit der Fähigkeit, analytische Konvergenzbeweise zu führen, bemerkt hatte.

A more detailed chronology is roughly as follows (cf. Elstrodt-Ullrich 1999 [222, p. 285–6]):

- In the late 1850s Weierstrass notices some gap in the Dirichlet principle (DP), and presents his objection to Riemann in 1859, who is not tremendously affected claiming that his existence theorems keep however their truths.

- Thieme 1862, who met Riemann and requested from him some elucidations about his theory of Abelian functions, and the conversation turned to the foundation of the Dirichlet's principle. This is materialized by a letter of Thieme to Dedekind of 1878 (reproduced in Elstrodt-Ullrich 1999 [222, p. 270–1], or as Quote 4.6 below)

- Kronecker 1864, in a discussion with Casorati, also exposes some criticism of the (DP). This is materialized by notes taken by Casorati, and published by Neuenschwander 1978

- Schwarz 1869 [768, p. 120] expresses for the first time in print doubts about (DP) (compare Quote 4.5 below).

- Heine February 1870 [355, p. 360] also puts in print the reserves expressed by Weierstrass and Kronecker, specifically their objections to the assumption that a minimum must exist.

- Weierstrass July 1870 [874] presents a variational problem where the minimum is not attained. This note, however, appeared in print only in 1895 in the second volume of Weierstrass's *Werke* [874].

- Prym 1871 [664, p.361–4] gives the first (published) counterexample to the (DP) (as formulated, e.g. in Grube’s text 1876 [208] based upon Dirichlet’s lectures). Prym gives a continuous function on the boundary of the unit disc such that the Dirichlet integral for the associated harmonic solution to the Dirichlet problem is infinite. However Prym expressly emphasizes that Riemann never stated such a naive version of DP corrupted by Prym’s example. In fact Prym’s example seems rather to attack a vacillating attempt by Weber 1871 [872] to rescue the Dirichlet principle.

Quote 4.5 (Schwarz 1869 [768, p.120]) Dass es stets möglich ist, die einfach zusammenhängende Fläche, welche von einer aus Stücken analytischer Curven bestehenden einfachen Linie begrenzt ist, auf die Fläche eines Kreises zusammenhangend und in den kleinsten Theilen ähnlich abzubilden, hat *Riemann* mit Zuhülfenahme des sogenannten *Dirichletschen* Principes zu beweisen gesucht.

Da gegen die Zulässigkeit dieses Principes bei einem Existenzbeweise hinsichtlich der Strenge gegründete Einwendungen geltend gemacht worden sind, war es wünschenswerth, ein Beweisverfahren zu besitzen, gegen welches die bezüglich des *Dirichletschen* Principes geltend gemachten Bedenken nicht erhoben werden konnten.

Quote 4.6 (Thieme 1878 :letter to Dedekind) Vielleicht werden Sie sich meiner noch erinnern, als ich mich im Sommer 1862 in Göttingen aufhielt um bei Riemann Aufklärung über seine Theorie der Abel’schen Funct. zu erbitten. Ich traf Sie damals in der Krone, wo wir beide abgestiegen waren, und das Gespräch kam auf die, meiner damaligen Meinung nach (was seitdem vielseitig anerkannt), nicht ganz stichhaltige Begründung des Dirichlet’schen Principes, welches in der Riemann’sche Theorie fundamental ist.

5 Philosophical remarks

5.1 Flexibility of 2D-conformal maps

Maybe one way to enlarge slightly the discussion at the philosophical level is to observe some unifying plasticity in conformal maps. The underlying principle is roughly as follows:

Principle 5.1 (Conformal Plasticity (CP)) *If there is no topological obstruction to a mapping problem, then a conformal mapping exist.*

This idea is very close to Koebe’s allgemeines Uniformisierungsprinzip in Koebe 1908 [452], which is stated as follow *Jedes Problem der im Sinne der Analysis situs eine Lösung hat kann auch funktionstheoretisch verwirklicht werden.*

Of course this is not quite true in view of say Riemann’s moduli for closed (or non closed) Riemann surfaces. However seminal instances where it works are the (RMT), the uniformization theorem (UNI) [any simply-connected Riemann surface is biholomorphic to the sphere, the plane or the disc], and the more general Koebe schlicht theorem to the effect that a schlichtartig Riemann surface is schlicht. Here the topological condition of “Schlichtartigkeit” (i.e. any Jordan curve divides) implies the stronger conformal embeddability in the Riemann sphere.

Theorem 5.2 (Koebe 1908 [452], 1910 [458]) *Any dichotomic³ (=schlichtartig) Riemann surface (i.e. one divided by any Jordan curve) embeds conformally in the Riemann sphere.*

Since simply-connected implies dichotomic this implies the (UNI) via (RMT).

An even stronger assertion is Bochner 1928 that any Riemann surface of finite connectivity embeds in a closed Riemann surface.

Ahlfors’ result about circle maps likewise illustrates the above principle (CP), especially if we interpret it in Klein’s theory of symmetric surfaces (compare Lemma 3.11).

³This nomenclature is used by Hajek, compare some arXiv preprints of the author joint with Gauld.

5.2 Free-hand pictures of some Riemann-Ahlfors maps

It would be nice if some general methodology for picturing such mappings could be developed. Let us try a naive look for domains (Riemann surface are harder but not hopeless).

Maybe first a comment by Poritsky 1949–52 [655, p. 21]:

Quote 5.3 (Poritsky 1949) From the above it is clear that analytical methods, at least as developed thus far, have only limited power in solving the complicated field problems arising in electric machines. Electrical engineers have resorted extensively to the use of “flux plotting” or *free-hand drawing* of the flux lines and equipotentials. As is well known, these curves, when drawn for constant equal increments $\Delta\varphi = \Delta\psi$, form a curvilinear set of *small squares*. A certain aptitude, somewhat between mechanical drawing ability and artistic drawing, is required for successful flux plotting, and with practice people possessing such aptitude can learn to draw flux plots for a great variety of cases with relative ease.

The picture below (Fig. 8) is supposed to depict the pullback of the radial-concentric bi-foliation of the disc via a conformal representation of this 4-ply connected circle domain by a Riemann map to the disc. (Usually the term “Riemann map” is reserved for the simply connected case, but recall that Riemann was the first to prove the existence of such maps, cf. Riemann 1857/76 Nachlass [689]). Physically one may try to interpret it at the galvanic current generated by 4 batteries (electric charge) situated on a conducting plate. Whenever the potential generated by two charge enter in conflicts some saddle type singularity is generated (those can be counted via an Euler characteristic argument à la Riemann-Hurwitz). In the present case there is 6 saddles. In general $\chi D = d\chi(\Delta) - \deg(R)$, and $\chi D = 2 - r$ (holed sphere) and the degree d is $d = r$, hence there is $\deg(R) = 2r - 2$ ramification points. (This was of course well-known to Riemann, compare his Nachlass, or Quote 15.1). Dashed lines are equipotentials.

This sort of picture as mystical as it is (the reader confesses to have had some trouble to generate it without grasping completely the possible physico-chemical interpretation) gives the impression of grasping slightly Riemann’s title to his Nachlass (Gleichgewicht der Electricität), i.e. equilibrium potential of electricity. Our figure is pure free-hand drawing without much scientific understanding. Thus it would be nice if the computer can do better pictures, maybe via the Bergman kernel (an eminently computable object, compare e.g. Bell papers). In particular albeit it looks physically obvious, it is not clear if the charge may be placed arbitrarily. (For instance it is not clear why the corresponding divisor should be linearly equivalent to its conjugate, compare Lemme 5.2 in Gabard 2006 [255].)

[Some related references: Henrici Computational conformal map, Gaier, Konstruktive methoden in Konformen Abbildungen, etc... Or maybe Crowdy via the Klein’s prime]

Extracting some global understanding in the non-schlicht case of such isothermic coordinates may be of some relevance to Gromov’s filling conjecture.

Further for less contours we may do similar pictures, and we then obtain the following figures (Fig. 9). The fact that the boundary contours are circles is not crucial (but convenient for simple depiction). First we draw the electrical forces in the case of an annulus. Then we made two pictures for triply-connected with symmetrically disposed battery (electrical charge). Geometrically those are supposed to be the pull-back of the origin under the Riemann-Ahlfors map. Finally we would like to make a similar picture in the case where the charge distribution is not symmetric. Then the picturing becomes very difficult. Already in the symmetric cases it is hard to be convinced that what we are doing is really serious. There is a sort of subconscious algorithm to make such pictures: (1) first draw the thick black lines where the particles enter in collision, (2) draw at angle $\pi/4$ the dual saddle at those collision point, and then the filling by thin lines is essentially a matter of artistic feeling. Of course it is not always easy to arrange such that all lines meet perpendicularly, but experience gives

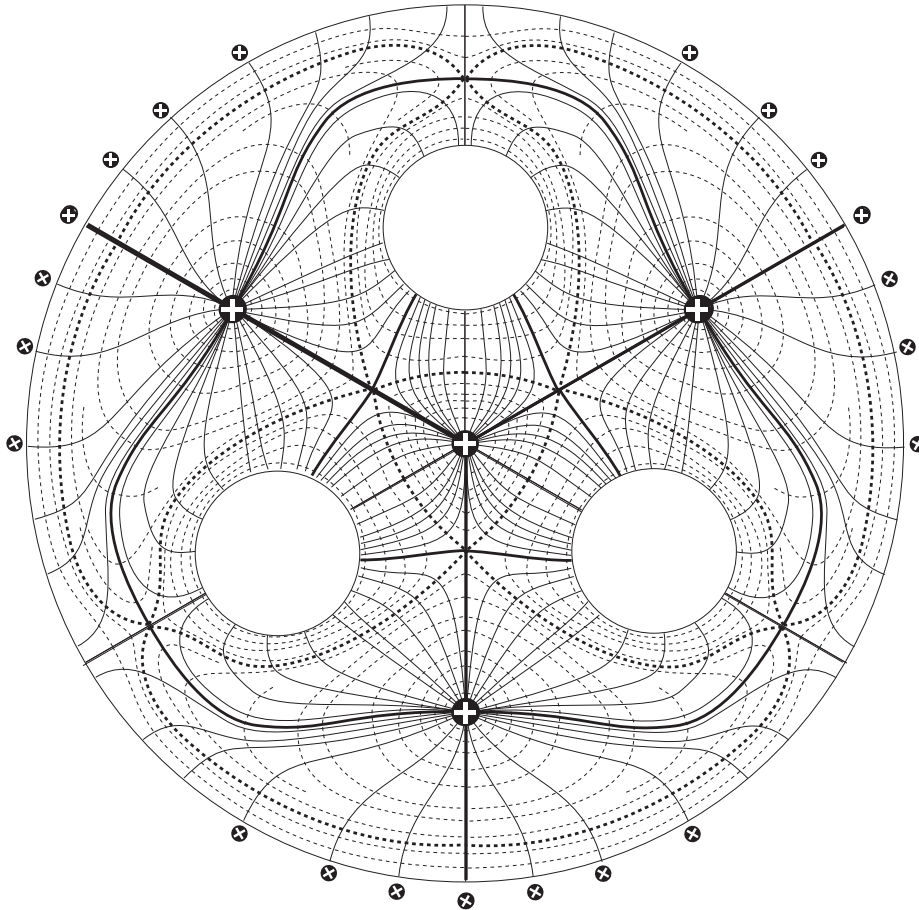

Figure 8: Attempting to plot a Riemann map by free-hand drawing

some sort of algorithm to do this. Of course it is quite convenient to do such pictures on a computer rather than on the paper, as one can adjust trajectories by successive approximations. As we used a software Adobe Illustrator; with Bézier curves, thus the mathematical faithfulness of all this picture is highly questionable, but we hope that the picture are still of some qualitative value to help visualize such mappings, and to feel some sort of physical interpretation. One guess is that it amounts to have some positive electric charge at the marked point plus perhaps a distribution of such charges on the border. Then each positive particle is rejected by the charge and the border. Thus the particle move faster when there is much free-room in the plate. Alternatively one may have a biological interpretation where the source are bacteroides and the black line show the progression of the growing population which is faster in those direction where there is much vital room (imagine herbivores). Then the saddle amounts to junctions between various ethnical population, and at time one the full universe is explored. In this interpretation the proliferation of species can be slowed down either by proximity to the border (limitation of resources), or by vicinity of a competing population.

5.3 Hard problems and the hyperelliptic claustrophobia

Another unifying theme when it comes to hard problems regarding Riemann surfaces is the following constat:

Several problems are fully settled in the hyperelliptic case, but horribly complicated otherwise.

This is a paradigm well known since time immemorial. Probably one of the first problem were it came acute was Jacobi's inversion problem occupying Jacobi, then Göpel and Rosenhain (hyperelliptic case) and only Weierstrass and above all Riemann 1857 [687] could handle the general case. (Weierstrass never

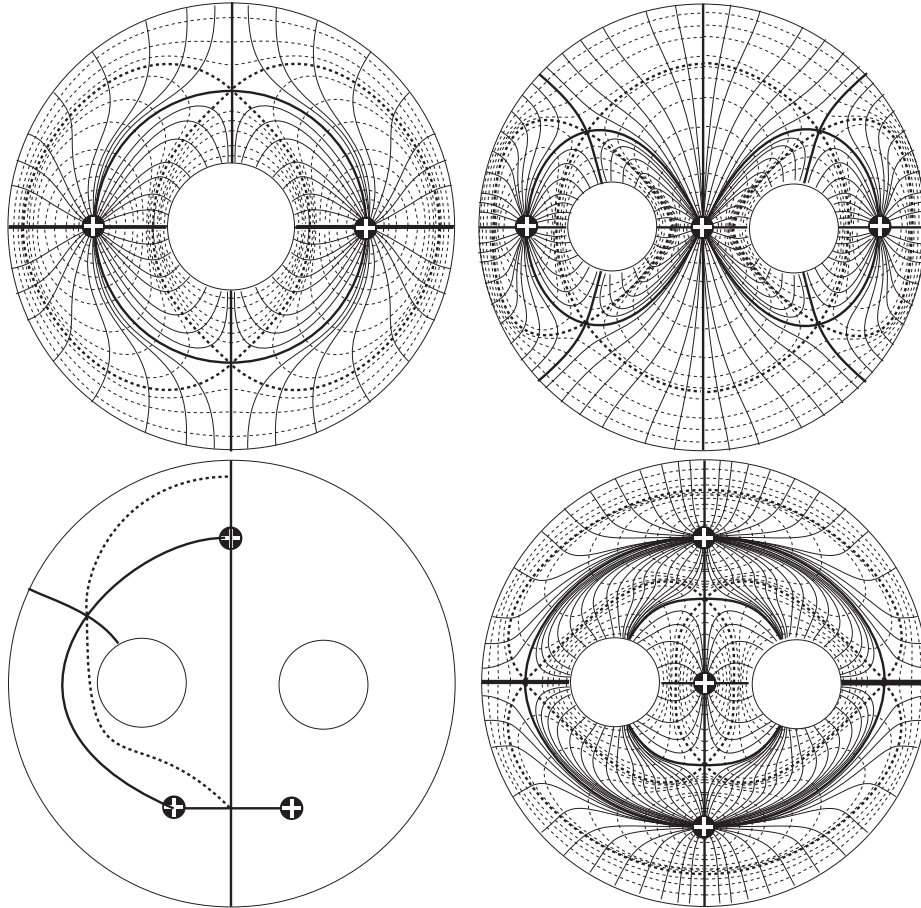

Figure 9: Another Riemann map by free-hand plotting

managed to put in print his own approach probably due to the extreme difficulty to follow an arithmetized path.) Another place is Klein's trick of degenerescence to the hyperelliptic configurations (cf. Klein 1892 [438]).

In some more contemporary problems we already addressed briefly this hyperelliptic barrier also delineate the current frontier of knowledge regarding:

- (1) The Gromov filling area conjecture (compare the work by Bangert et al. [58] where the conjecture is established in the hyperelliptic case, hence in particular for membranes of genus $p = 1$).
- (2) The Forstnerič-Wold conjecture [247] that compact bordered Riemann surface embeds in \mathbb{C}^2 (this is also known in the hyperelliptic case).
- (3) The exact determination of Ahlfors degrees à la Yamada-Gouma (this is also settled in the hyperelliptic case, but not much seems to be known beyond those configurations).

5.4 Topological methods

We started our Introduction by claiming that topological methods have some relevance to the field of function theory, Riemann surfaces, and the allied fields.

The experience of the writer in this realm is rather modest and essentially reduces to his lucky stroke in Gabard 2006 [255], about lowering the degree of a circle map upon the prediction made by Ahlfors for his extremal function.

Such topological methods are quite common in function theory (Riemann, Klein, Poincaré, Brouwer, Koebe, etc.) albeit occupying a marginal place in comparison to potential theoretic consideration or the allied quantitative extremum problems. Let us list some contributions using qualitative topological methods in the realm of classical function theory:

- (1) The most famous (and probably important) example is the continuity method of Klein-Poincaré related to the uniformization problem. (Prior to this

we may detect earlier trace of the continuity method, as one learns by reading Koebe 1912 [459], in the work of Schwarz-Christoffel and Schläfli.)

(2) The intuitions of Klein-Poincaré were put on a firm footing by Brouwer 1912 [119], [118], using invariance of domain which he was the first able to prove via combinatorial topology.

(3) Closer to our main topic, we cite Garabedian 1949 [276] who also relies heavily on combinatorial topology to select appropriately certain auxiliary parameters.

(4) Mizumoto 1960 [564], who reproves the existence of (Ahlfors-type) circle map of degree $r + 2p$ (i.e. like Ahlfors bound).

(5) Gabard 2006 [255], where the degree is lowered to $r + p$ (also via topological methods).

Roughly, the philosophy is that Riemann surfaces are volatile objects when fluctuating through their moduli spaces, so that practically nothing is observable outside the inherent topological substratum which turns out to behave rather stably say w.r.t. the Abel-Jacobi mapping. At least this is philosophical substance of the proof in Gabard 2006 [255].

5.5 Bordered Riemann surfaces and real algebraic curves

It may seem at first that bordered surfaces are a bit borderline deserving less respectableness than the temple of closed Riemann surfaces. Likewise real algebraic geometry always appears like a provincial subdiscipline of pure complex algebraic geometry of the best stock.

Perhaps, less is true. The rehabilitation of reality within algebraic geometry is in good portion, especially regarding the connection with bordered (possibly) non-orientable surfaces, the credit of Felix Klein (especially in 1882 [434]). Moreover, independently of the algebro-geometric analytic correspondence (à la Riemann, etc.) there is another simple reason for which bordered (Riemann) surfaces took gradually more-and-more importance during the 20th century, especially under the fingers of the Finnish and Japanese schools. This pivotal role of compact bordered objects results indeed merely from their intervention as building elements of general open surfaces. The latter being always exhaustible through such compact elements as follows easily from Radó's triangulability theorem of 1925 [670]. Once again this illustrates basically the philosophy "Nihil est in infinito...".

Remind also that the device of exhaustion by finite (=compact) surface is somewhat older than those schools. It may have first occurred in Poincaré 1883 [649] (where analytic curves or open Riemann surfaces are first taken seriously and subsumed to the uniformization paradigm) and then Koebe 1907 [450] in same context. To caricature a bit Koebe's proof, it amounts to use the RMT for compact discs (in a version cooked by Schwarz) and expand in the large. The exhaustion device is again used in Nevanlinna 1941 [610], where via exhaustions one constructs the corresponding so-called harmonic measure solving the Dirichlet problem for boundary values 0 and 1 on the initial resp. expanding contours of the exhaustion F_n , yielding the "Nullrand" dichotomy according to whether the ω_n flatten to 0 or converge to a positive function. Ahlfors 1950 [17] also uses (or planned to use) a similar technique for other problem. This was enough to launch the big classification programme of open Riemann surfaces.

5.6 Lebesgue versus Riemann

[11.10.12] This paragraph is free-style philosophical lucubration coming to me right after reading the fantastic paper Forelli 1978 [246]. From a narrow minded viewpoint (the writer having zero measure theoretic knowledge) it seems that modernism, especially along the "capitalistic" line of thought involving measure theory, albeit initially quite concomitant with the (older complex) function theory, ultimately may have drifted a vast body of the vital fluid in a somewhat arid valley. (For a somewhat related diagnostic cf. Morse-Heins 1947 [572].)

Let us be more specific. Circa 1898 the way was paved toward measure theory starting from function theoretic preoccupations (not to mention the earlier “Cantorism” starting from Fourier series). We have of course in mind E. Borel 1898 [111], and then the stream along Lebesgue 1902 [498], Fatou 1906 [231], the old brother F. Riesz 1907 (Fischer-Riesz effecting an Hilbert-Lebesgue unification, etc.). All those grandiose efforts/achievements may have polluted the pureness of (Riemann’s) geometric conceptions by charging the theory with complicated pathological paradigms not truly inherent to its geometric substance (at least in its finitistic aspects, which are not completely elucidated yet, e.g. Gromov’s filling conjecture). Of course the antagonism we are speaking about goes back to older generations, e.g. already acute in the Hermite vs. Jordan opposition, who were resp. anti- and pro-Lebesgue⁴).

This tension is also felt when it comes to prove existence of circle maps, where say proofs like Ahlfors’ 1950 [564], Mizumoto’s 1960 [564], and many others (maybe even Gabard’s 2006 [255]) proceeds along essentially classical lines, often emphasizing the soft topological category (very implicit by Riemann-Klein-Poincaré-Brouwer) instead of measure theory (again Borel-Lebesgue-Fatou-Riesz). Of course initially topology also arose from capitalism over the real line, namely the notion of metric (distance function). Yet ultimately the theory (be it axiomatically Bolzano-Cantor-Hilbert-Fréchet-Riesz-Hausdorff-Weyl or through educated intuition Riemann-Klein-Poincaré-Brouwer-Thurston) reached some higher romantic stratosphere producing some lovely science essentially the most remote from capitalistic preoccupation we were able to produce. Alas or fortunately, Grisha Perelman (and precursors Thurston/Yau-Hamilton) showed us that the likewise pleasant Riemannian geometry (albeit slightly more quantitative) turned to have some important topological impact (typically over Poincaré’s conjecture).

In a survey article by Lebesgue (ca. 1927, easy to locate), a rather primitive mercantile metaphor is appealed upon to argue that his theory of integration supersedes Riemann’s. Lebesgue argues that when a huge amount of money (delivered as a chaotic mixture of pieces and bills) requires enumeration, his theory amounts to count things properly by first enumerating what has highest value and then paying attention to the more negligible money pieces. This procedure is tantamount to subdividing rather the range of the function as do Lebesgue instead of its domain as did Cauchy or Riemann. The bulk of the US production (Rudin, Gamelin, Forelli and many others) in the 1950-1970’s is much influenced by measure flavored analysis, and the art-form continues to prosper with deep paradigms allied to Painlevé’s problem (fully solved in Tolsa 2003 [834]).

In contrast, some older workers, e.g. Koebe (cf. Gray’s 1994 paper [300]) as well as Lindelöf (cf. Ahlfors’ 1984 [26]) (and probably more recent ones) were never full partisans of Lebesgue’s integral. Of course the latter theory added a mass of grandiose contributions, yet in some finitary problems like the one at hand (Ahlfors circle maps) its significance can probably be marginalized, or completely eliminated. So measure theory exists, but does it really capture the quintessence of the problematic we are interested in, which is more likely to be first of a *qualitative* nature (coarse existence theory). Arguably, the next evolution step is the *quantitative* phase (e.g. Ahlfors extremal problem, which is essentially solved modulo fluctuating incertitudes about degree variations of such maps). Finally any theory should culminate in the *algorithmic* era, that is claustrophobic (computer ripe) era. Remind that Riemann precisely disliked Jacobi’s approach, finding it too algorithmic and not conceptual enough (according to some forgotten source, try maybe Klein’s history [444]: “Jacobi war ihm zu algorithmisch.” [quoted by memory]). At such a stage it is safer to let computers do the work, but of course it remains to find the algorithms. Will

⁴There is a letter from Jordan to Lebesgue saying roughly: “Persévérez dans vos recherches mathématiques, vous allez y éprouver beaucoup de plaisirs, mais il va vous falloir apprendre à y goûter seul, car en général les géomètres ne se lisent même pas entre eux-mêmes.” (quoted by pure memory, hence highly unreliable).

the machine not quickly be more fluent in this game as well? (Compare the little green men survey by David Ruelle in Bull. Amer. Math. Soc. ca. 1986, who tabulated on the imminence of machines cracking theorems with more ease than we are able to do. Hopefully so, since the goal of any science (indeed any living being) is to reach immortality.)

So if measure theory and general open (=non-compact) Riemann surfaces inclines much to Lebesgue (and the like), it seems evident that still much work must be clarified at the more basic (combinatorial) geometric level of simpler objects, e.g. super classical algebraic geometry should be cultivated again to penetrate more deeply in a variety of problems still unsolved.

6 Prehistory of Ahlfors

This section attempts a fairly exhaustive tabulation of works antedating Ahlfors 1950 [17], bearing more-or-less direct connection to it. In some critical cases, some of those may also be considered as (vague?) anticipations of the Ahlfors mapping by other “pretenders”. In chronological order, we shall discuss contributions of Riemann 1857–58–76, Schottky 1875–77, Klein ca. 1876–82–92, Koebe ca. 1907, Bieberbach 1925, Grunsky 1937–41–49, Courant 1937–39–50, Teichmüller 1941.

Our history is not intended to be a smoothly readable account inclining to passive somnolence, but rather one inviting to further active searches to clarify several puzzling aspects, where in our opinion historical continuity is violently lacking. Historical turbulences arise mostly from several links hard to track down due to poor cross-referencing (especially in the case of Teichmüller 1941 [826], who seems to credit Klein for a sort of qualitative version of the Ahlfors circle map, yet without bound upon the degree). In contrast, the first steps, i.e. the affiliation Riemann-Schottky-Bieberbach-Grunsky is well documented (but confined to planar surfaces, hence inferior to Ahlfors’ work). Courant’s contribution is more in the trend Dirichlet-Riemann-Plateau-Hilbert, but ultimately a bit sketchy when it comes to compare with Ahlfors.

Regarding Koebe, he was quite influenced by Klein’s orthosymmetry (which bears a direct connection to Ahlfors’ conformal circle map via the algebro-geometric viewpoint), but was more involved with uniformization (in particular of real curves) and the *Kreisnormierungsprinzip* (rooted back in Schottky, if not Riemann). Koebe’s work concentrates more upon conformal diffeomorphisms than branched covers. Perhaps an exception concerns his later works ca. 1910 influenced by Hilbert, where he comes to investigate more closely non-schlichtartig surfaces. However in the overall we could not find (as yet) in the torrential series of Koebe’s papers a clear-cut anticipation of Ahlfors’ result. (Relevant works of Koebe will in fact rather be surveyed in the next section.)

To summarize we have located essentially 3 potential forerunners of the Ahlfors circle map:

(1) Klein, through a citation (or rather allusion) of Teichmüller in 1941 (supplied without precise reference!) and to which we were not able to supply sound footing (despite long searches through Klein’s collected papers, plus his harder-to-find Göttingen lectures in 1891–92 [439], [440]). In case no trace is to be found in Klein’s work, it is conceivable that Teichmüller distorted somehow his memory about Klein, in which case Teichmüller should be regarded as the genuine forerunner. It may be imagined that a micro-tunnel (=logical wormhole) links Klein to Ahlfors, and this may have existed in Teichmüller’s brain (but as far as I know no proofs are to be found in print).

(2) Courant who makes a vague claim that the result of Riemann-Schottky-Bieberbach-Grunsky extend to configurations of higher genus. If Courant’s claim is correct, it would be of extreme interest to present the details, especially if it is possible to write down the bound arising from Courant’s argument (inspired from Plateau’s problem).

(3) Matildi 1945/48 [536] and Andreotti 1950 [45].

6.1 Tracing back the early history (Riemann 1857, Schwarz, Schottky 1875–77, H. Weber 1876, Bieberbach 1925, Grunsky 1937–50, Wirtinger 1941)

From Grunsky’s papers (1937 [315], 1941 [316], both cited in Ahlfors 1950’s paper) one can trace down the early history of Ahlfors theorem back to the very origin (i.e. Riemann) as follows. Grunsky was Bieberbach’s student. The latter proved a version of this theorem (yet without the extremal interpretation) for planar (schlichtartig membrane, i.e. $p = 0$) in Bieberbach 1925 [97]. In this paper, one detects an early influence of Schottky’s Dissertation (Berlin 1875, under Weierstrass) published 1877 [763], as well as a Nachlass of Riemann estimated of 1857 (which was published in his Werke ca. 1876). Riemann apparently only handles the case of a *Kreisbereich* (circular domain), yet it seems that Heinrich Weber—who edited this Riemann’s Nachlass—may have considerably amputated the original manuscript. (Of course it would be a first class Leistung if some specialist of Riemann’s work would undertake the difficult project of producing a more all-inclusive account.) Let us reproduce the introduction of Bieberbach 1925 [97]:

Quote 6.1 (Bieberbach 1925) Es handelt sich in dieser Arbeit um die Abbildung eines mehrfach zusammenhängenden schlichten Bereiches auf eine mehrfach bedeckte Kreisscheibe. Insbesondere stelle ich mir die Aufgabe, zu beweisen, daß ein n -fach zusammenhängender Bereich stets auf eine n -blättrige Kreisscheibe abgebildet werden kann. Die erste im Druck erschienene Arbeit, die sich mit diesen Fragen beschäftigt, ist die Dissertation von Schottky (Berlin 1875), die im 83. Bande des Crelleschen Journal abgedruckt ist. Die Frage nach der kleinstmöglichen Blätterzahl ist dort nicht behandelt, aber die Analogie und die Beziehung zur Theorie der algebraischen Funktionen und ihrer Integrale liegt den Betrachtungen zugrunde, und auch die Beziehung zur Theorie der linearen Differentialgleichungen 2. Ordnung kommt zum Vorschein. Wie mir Herr Schottky erzählte, machte bald darauf H. A. Schwarz darauf aufmerksam, daß sich Riemann im Sommer 1857 bereits mit der eingangs erwähnten Frage beschäftigte. In der von H. Weber bearbeiteten Darstellung dieses Teils des Riemannschen Nachlasses findet sich freilich keine volle Erledigung der Frage. Ich finde, daß auch nicht alle Gedanken des Riemannschen Manuskriptes zur Verwendung kamen. (Vrgl. Riemanns Werke 2. Auflage S. 440–444) Riemann knüpft bei seinen Überlegungen an die Theorie der linearen Differentialgleichungen an. Die Theorie der algebraischen Funktionen wird nach der Weberschen Darstellung zur Lösung des Abbildungsproblems nicht herangezogen. Dagegen scheinen mir die Riemannschen Notizen zu lehren, daß Riemann auch einen über die Theorie der Abelschen Integralen führenden Weg unabhängig von dem bei Weber dargestellten erwogen hat. Welcher von beiden Wegen der frühere ist, vermag ich nicht zu entscheiden.

Hence the tension between Abelian integrals and potential theory seems to have always been surrounded by a little ring of mysteriousness, even in the passage of Bieberbach 1925’s article just quoted. Furthermore, after Grunsky completed in 1941 his series of papers on the question, it looked desirable to Wirtinger to publish 1942 [891] his own interpretation of Riemann’s Nachlass which he probably knew since ca. 1899 during his duties as publisher of the second edition of Riemann’s Werke.

Quote 6.2 (Wirtinger 1942) Die Abhandlung des Hrn. Helmut Grunsky, welche in diesen Berichten, Jahrgang 1941, Nr. 11, unter dem Titel “Über die konforme Abbildung mehrfach zusammenhängender Bereiche auf mehrblättrige Kreise II” erschienen ist, bringt mir Überlegungen wieder gegenwärtig, welche unmittelbar an die klassische Dissertation von F. Schottky (Berlin 1875) anschließen, welche noch vor dem Bekanntwerden des Riemannschen Fragmentes über das Gleichgewicht der Elektrizität auf Zylindern von kreisförmigem Querschnitt (1876) erschienen ist. Zusammen mit dem dort entwickelten Symmetrieprinzip reicht die Theorie der algebraischen Funktionen vollkommen aus, um zu beweisen, daß ein von $p+1$ Randkurven, welche völlig getrennt verlaufen und von denen keine sich auf einen Punkt reduziert, begrenzter Bereich sich konform auf die $p+1$ -fach überdeckte Halbebene der Variablen $z = x + iy, y \geq 0$ abbilden läßt, wobei noch auf jeder Linie der dem Punkte $z = \infty$ entsprechende beliebig vorgegeben werden kann.

In the above quote, Bieberbach also mentions that H. A. Schwarz was well acquainted with this Riemann's Nachlass. In this connection, it can be reminded that the whole trend connected to the so-called *Schwarz lemma* involving Schwarz 1869–70 [769, p. 109], Carathéodory 1907 [134], 1912 [138] (where the coinage “Schwarz lemma” is first used), Pick 1916, Ahlfors 1938, with some intermediate steps due to E. Schmidt ca. 1906 (as acknowledged in Carathéodory 1907 [134]) is well known to have been another inspiring source for Ahlfors' extremal problem.

To be even more mystical, Carathéodory mentions—in his 1936 laudation to Ahlfors' reception Fields medaille (ICM 1936)—a certain “*Ölfleckmethode*” of Schwarz, which seems to be related to all this. This intriguing terminology, probably refers to the common “*Ölfleck*” experiment consists of taking any “oil” region in a water recipient while exciting it slightly or even strongly with a thin instrument, yet preferably without causing a rupture of its connectedness. Observationally, one can then contemplate with which determination and structural stability the possibly highly distorted “*Ölfleck*” restores to the round circle-shape even if there are thin necks in the initial position. This seems to be one of the most beautiful way to visualize the Riemann mapping theorem in nature. Mathematically this *Ölfleck* experiment bears perhaps more analogy to the normal curvature flow (Huisken, etc.), than the levels of the Riemann mapping function. One can wonder if there is an identity between the curvature flow and RMT.

6.2 Schottky 1875–77

All sources indicates that Schottky discovered the circle map of a multiply-connected domain independently of Riemann's Nachlass. Compare the next 3 quotes of Schottky (6.3) and Klein (6.6), (6.7). In 1882, during the hot Klein-Poincaré “competition” on automorphic functions vs. Fuchsian functions, Schottky's thesis came again to the forefront, with Klein asking its writer for some precision about its genesis. Besides, Schottky rectified some (historically) inaccurate statement made by Klein. It resulted a letter published 1882 in Math. Annalen [764], which we reproduce in part:

Quote 6.3 (Schottky 1882 [764]) Dass übrigens Riemann bereits die mit dieser Figur in Zusammenhang stehenden Functionen und ihre Differentialgleichungen entdeckt hat, wird durch die Stelle pag. 413–416 seiner gesammelten Werke bewiesen. [★Footnote: Gleichgewicht der Electricität auf Cylindern mit kreisförmigem Querschnitt und parallelen Axen.—Herr Weber fügt als Herausgeber diesem Aufsätze die Bemerkung zu: “Von dieser und den folgenden Abhandlungen [des Riemann'schen Nachlasses] liegen ausgeführte Manuscripte von Riemann nicht vor. Sie sind aus Blättern zusammengestellt, welche ausser wenigen Andeutungen nur Formeln enthalten.” ★] Indess möchte ich betonen, dass meine Dissertation ein Jahr vor der Publication von Riemann's Nachlass erschienen ist. Auch erfuhr ich von Letzterem erst, als meine Arbeit bereits in ihrer zweiten Fassung zum Druck übergehen war. Aber ich bin glücklich, mit Ihnen die Priorität der Entdeckung Riemann's constatiren zu können.

...

Sie haben in freundlicher Weise den Wunsch geäußert, Genaueres über die Prämissen meiner damaligen Arbeit zu erfahren. Die Anregung zum selbständigen Eindringen in die Potentialtheorie verdanke ich Herrn Helmholtz. Das in der Arbeit behandelte Problem, der ursprünglichen Auffassung nach der Potentialtheorie gehörig, und wesentliche Anschauungen meiner Arbeit sind aus mathematisch-physikalischen Autoren geschöpft. Ich nenne neben den Vorlesungen und Schriften von Herrn Helmholtz insbesondere ein mir gütig von Herrn O. E. Meyer geliehenes Heft noch nicht publicirter Vorlesungen von Herrn F. Neumann, dann ferner ein Buch über Elektrostatik von Herrn Kötteritzsch, etc. Die Durchführung der so gewonnenen Ideen wurde mir sodann wesentlich erleichtert durch Herrn Weierstrass' Vorlesungen über Abel'sche Functionen, sowie besonders durch die von Herrn Schwarz publicirten Untersuchungen über das Abbildungsproblem einfach zusammenhängender Flächen. Mit Rücksicht auf die letzteren wurde auf den Rath meines hochverehrten Lehrers, Herrn Weierstrass, der ursprünglich überreichte Entwurf der Arbeit so abgeändert, dass sich dieselbe in beiden veröffentlichten Fassungen an die Untersuchungen von Herrn Schwarz anschliesst.

This work of Schottky enjoyed an early and great recognition among colleagues, and still today is frequently cited. The reasons of this success are multiple, but I cannot resist to quote first Le Vavasseeur 1902 [497] [since in Geneva there is a prominent artist bearing a similar name], himself quoting Picard:

Quote 6.4 (Le Vavasseeur 1902) Dans le Tome II de son *Traité d'Analyse*, page 285, M. Émile Picard écrit: “Deux aires planes A et A_1 , limitées chacune par un même nombre de contours, ne peuvent pas, en général, être représentées d'une manière conforme l'une sur l'autre. L'étude approfondie de ce problème a été faite par M. Schottky dans un beau et important Mémoire.”

Plus loin même Tome, page 497, en note, M. Émile Picard écrit encore: “Nous avons déjà eu l'occasion de citer le beau travail de M. Schottky; c'est un Mémoire fondamental à plus d'un titre.”

The enthusiasm for Schottky's work diffused from France to Italy, cf. especially Cecioni 1908 [160], who may be credited for the first rigorous proof of the parallel slit map. The reason of Schottky's popularity is the quite amazing novelty of his work in prolongation of Riemann's ideas—but so in retrospect only for Schottky was not directly influenced by Riemann. The methods range from potential-theoretic to algebraic functions, flourishing into an breathtaking variety of results. Beside the circle map for multiply-connected domains, it contains both what later will be known as the Kreisnormierungsprinzip (KNP), plus the parallel-slit mappings (PSM). —*Warning*. In fact I am not sure that it contains KNP, but could easily have on the basis of a naive parameter count. Also it is never clear if material was amputated from the first 1875 edition of Schottky's thesis. According to Klein's quote (6.7), it seems however that the first Latin edition (1875) of Schottky's thesis contained the statement of the Kreisnormierung, yet “*nur auf Grund einer Konstantenzählung*”. — At any rate, it contains (explicitly or in embryo) virtually all of the varied canonical conformal maps which will be re-studied by Koebe during the period 1904–1930, trying even to extend the results to infinite connectivity. As is notorious, this ramifies to deep waters still not completely elucidated today, cf. He-Schramm 1993 [353], which is still the best result reached so far on the Kreisnormierung problem. Schottky's thesis also contains the idea of symmetric reproduction of such a domain, where Klein identifies one of the first instance of automorphic functions. The name “Schottky uniformization” is still of widespread usage today (e.g. Bers, Maskit, etc.). The influence of Schottky's work is also apparent in the jargon “Schottky differentials” widely used in several of Ahlfors' papers, especially Ahlfors 1950 [17]. (From the algebro-geometric viewpoint this probably just amounts to a real differential.) Last but not least, the Schwarz principle of symmetry (1869 [768]) [which afterwards Klein liked to identify in Riemann's Nachlaß [689] already, as testimonies the many brackets added in his collected papers, e.g. Klein 1923 [443, p. 631, line 3]] enables one to form the so-called *Schottky double*. All this appears first in this single work of Schottky.

The admiration for Schottky's thesis propagated long through the ages, e.g.:

Quote 6.5 (Garabedian-Schiffer 1949 [275, p. 187, p. 214]) An understanding of all identities between domain functions may be obtained by sustained application of Schottky's theory of multiply-connected domains [15](=1877). Schottky proved that there is a close relation between the mapping theory of these domains and the theory of closed Riemann surfaces; the identities among domain functions have their complete analogue in the theory of Abelian integrals and might be proved by means of the latter.

...

Schottky functions and related classes. Schottky [15](=1877) was the first to consider the family \mathfrak{R} of all functions which are single-valued and meromorphic in D [a multiply-connected domain] and have real boundary values on C [the full contour of D]. He developed an interesting theory of conformal mapping of multiply-connected domains from the properties of this family and established by means of it the relation

of this theory with the theory of closed Riemann surfaces. It is evident that functions $f(z) \in \mathfrak{R}$ are very useful in the method of contour integration.

Schottky's thesis originated in the ambiguous context of physical intuition vs. Weierstraßian rigor. It is notorious that the ultimate redaction was a hard gestation process subjected to incessant revisions demanded by Weierstraß. As we know (from Schottky himself (6.3), plus the next two quotes by Klein) the first impulse was physically motivated (Helmholtz, F. Neumann, the father of C. Neumann, etc.), and then only lectures of Weierstraß and papers of Schwarz came to influence the mathematical treatment. For Klein this excessive Weierstrassization is regarded from a sceptical angle (cf. again the next two quotes).

It is still delicate question to wonder about the rigor reached in Schottky, despite its ultimate foundation over technology of Schwarz as a substitute to the Dirichlet principle. To ponder its ultimate rigor, it suffices to say that all of Schottky's results were subsequently revisited, by the following workers:

- Koebe for KNP in a (torrential) series of paper spread from 1906 to 1922.
- Cecioni 1908 [160] for the PSM (=parallel-slit mapping); the latter even mark (discretely) the superiority of his proof by emphasizing that Schottky's argument relies on a parameter count, whereas he proposes to prove PSM "*di-rettamente*" (cf. *loc. cit.* p.1). This technical "gap" was of course known to Klein, cf. the next Quote 6.7. Also in Salvemini 1930 [732, p.3] (a student of Cecioni) the critic is made more explicit: "*Questo risultato [=PSM] era stato enunciato dallo Schottky in base ad un computo di parametri, computo che non è poi esauriente.*"
- Bieberbach 1925 [97] for the circle mapping problem.

None of those writers attacks frontally the standards of rigor in Schottky (as based upon the complicated but solid foundations laid by Schwarz). Still, the technical complications was seen as a need to find simpler derivations of the geometrical results. After sufficiently time elapsed, the subsequent generation tends to ascribe the (rigorous) proof of Schottky's result to this second wave of workers. E.g., Grunsky 1978 [322] ascribes Schottky's circle maps to Bieberbach 1925 [97] (cf. Quote 6.8), and Bieberbach 1968 [102] credits Koebe for the proof of KNP (in finite connectivity). All these redistributions are done without specific objections upon the original arguments Schottky's. This is a usual loose process relegating methodologies just due to their cumbersomeness, as a sufficient reason for lack of rigor.

In contrast, even more contemporary workers still credits Schottky for the first proof of the Kreisnormierung result (cf. e.g., Schiffer-Hawley 1962 [756, p.183]). So it is a subtle socio-cultural game to pinpoint precisely about which writer furnished the first acceptable proof.

6.3 Klein's comments about Riemann-Schottky

In the third volume of his collected papers Klein makes several comments about Riemann and Schottky thesis. He insists first on the physical motivations of Schottky, which were progressively "censured" under Weierstrass' influence.

Quote 6.6 (Klein 1923 [443, p.573]) Ich greife gern noch einmal auf die wiederholt genannte Arbeit Schottkys in Crelle Journal, Bd. 83 (1877) zurück, zumal ich weiter unten (S. 578/579) ohnehin ausführlicher auf sie zurückkommen muß. Die große Ähnlichkeit der auf einen besonderen Fall bezüglichen Schottkyschen Untersuchungen mit den allgemeinen meiner Schrift war mir von vornherein aufgefallen. Ich schrieb also damals an Herrn Schottky und fragte ihn nach der Entstehung seiner Ideen. Hierauf antwortete her mir in einem Briefe von Mai 1882 (der in Bd. 20 der Math. Annalen abgedruckt wurde), daß er in der Tat ursprünglich auch von der Betrachtung der Strömungen einer inkompressiblen Flüssigkeit ausgegangen sei und diesen physikalischen Ausgangspunkt nur auf Rat von Weierstrass bei der Drucklegung durch die Bezugnahme auf Schwarz' Untersuchungen über konforme Abbildung ersetzt habe.

Then Klein recollects some more details in the following passage. This contains an anecdotic conflict (with Bieberbach 1925 [97]=Quote 6.1) about the

estimated date of Riemann's Nachlass. More interestingly, Klein expresses the view that Schottky's theorem (to the effect that a multiply-connected domain is conformal to a circle domain) may be seen as the planar case of Klein's *Rückkehrschnitttheorem*, which in turn seems to be one of the weapon that Klein used in his early strategy toward uniformization (an approach not successfully completed until Brouwer-Koebe ca. 1911 [441]).

Quote 6.7 (Klein 1923 [443, p. 578–579]) Übrigens hat Riemann ja auch die andere Art automorpher Funktionen, die entstehen, indem man an einen von Vollkreisen begrenzten Bereich der Ebene an diesen Kreisen fortgesetzt symmetrisch reproduziert (Siehe das von H. Weber bearbeitete Fragment XXV in der ersten (1876 erschienenen) bzw. XXVI in der zweiten (1892 erschienenen) Auflage der Ges. math. Werke von Riemann.) Die Prüfung der Originalblätter hat ergeben, daß Webers Mitteilungen den Vorbereitungen zu einer im Sommer 1858 gehaltenen Vorlesung entnommen sind. Und zwar geht Riemann dabei zunächst von der Aufgabe aus, für ein von mehreren Kugeln gebildetes Konduktorsystem das Gleichgewicht elektrostatischer Ladungen zu bestimmen. Hierfür war die Benutzung des Symmetrieprinzips in den Arbeiten von W. Thompson vorgebildet, die als Briefe an Liouville in dessen Journal von 1845 an erschienen. Also auch hier sind die mathematischen Entwicklungen aus physikalischen Anregungen erwachsen.

Auf dieselben Funktionen ist dann unabhängig in seiner Berliner Dissertation 1875 Herr Schottky gekommen. Von seinem physikalischen Ausgangspunkte ist schon oben auf S. 573, die Rede gewesen. Im übrigen sind die Schicksale der Schottkyschen Arbeit, wie sie sich nach persönlicher Mitteilung des Verfassers ergeben, so merkwürdig, daß ich gern die Gelegenheit ergreife, sie hier mitzuteilen. Es erfolgten nach einander drei verschiedene Redaktionen:

- a) Eine lateinische Fassung, die nicht publiziert ist, sondern nur der Philosophischen Fakultät in Berlin vorgelegen hat,
- b) Eine deutsche Bearbeitung, welche 1875 in Berlin als Dissertation gedruckt wurde,
- c) Die umgearbeitete Darstellung in Crelles Journal, Bd. 83 (1877).

Bei Niederschrift von a) hat der Verfasser noch keine Fühlung mit Weierstrass gehabt, dafür aber ganz seiner freien Ideenbildung folgen können. Aus dem Gutachten, daß Weierstrass über a) seinerzeit für die Fakultät abgegeben hat und von dem ich durch die Freundlichkeit von Herrn Schottky eine Abschrift vor Augen habe, scheint mit Gewißheit hervorzugehen, daß Schottky hier, freilich nur auf Grund einer Konstantenzählung, das "Rückkehrschnitttheorem" für den besonderen, von ihm betrachteten Fall ausgesprochen hat, d. h. die Möglichkeit, einen von $p+1$ regulären Randkurven begrenzten ebenen Bereich auf einen von $p+1$ Vollkreisen begrenzten Bereich konform abzubilden (also das Rückkehrschnitttheorem für den obersten orthosymmetrischen Fall, wie ich mich ausdrücke).

Die Redaktion b) ist dann durch eine erste Fühlungnahme mit Weierstrass bedingt. Bei der umfassenden Beherrschung ausgedehnter Teile der Mathematik und seiner stark ausgeprägten Persönlichkeit, die sich zu bestimmten Beweisgängen durchgearbeitet hatte, übte Weierstrass auf jüngere Forscher je nachdem einen außerordentlich fördernden, oder auch, wo ihm die Gedankengänge fremdartig waren, einen hemmenden Einfluß. [...]. Schottky scheint ähnliche Erfahrungen gemacht zu haben, so daß er in b) sich bloß auf die Konstantenzählung beschränkt, ohne ihre Tragweite für das Fundamentaltheorem anzudeuten [...]. Die physikalische Ideenbildung aber, von der doch der Autor ausgegangen war, wird gänzlich ausgeschaltet und durch Zitate auf die das Existenzproblem der konformen Abbildungen betreffenden Arbeiten von Schwarz ersetzt.

In c) endlich ist auch noch besagte Konstantenzählung weggeblieben. [[[Fußnote: Dagegen hat Schottky in c) (S. 330 daselbst), wiederum auf Grund bloßer Konstantenzählung, den Satz ausgesprochen, daß sich jedes ebene, von $p+1$ Randkurven begrenzte, Gebiet umkehrbar eindeutig konform auf die Vollebene mit Ausnahme von $p+1$ geradlinigen, zur x -Achse parallelen Strecken abbilden läßt. Bereiche der letzteren Art spielen in der modernen Literatur unter dem Namen *Schlitzbereiche* bekanntlich eine wichtige Rolle.]]] Statt dessen finden sich wertvolle, vorher nicht publizierte, Angaben über die verschiedenen Normalformen, die Weierstrass bei den Gebilden $p > 2$ unterschied; [...]

Incidentally this *Rückkehrschnitttheorem*, may have some connection with the Ahlfors function albeit probably no direct link is evident, there is still some striking analogy developed in the next section.

6.4 A historical puzzle: why Klein missed the Ahlfors circle mapping?

[27.04.12] After reading quite closely the above comments of Klein, plus having a vague idea of the content of Schottky's Dissertation one is really puzzled to wonder how close Klein was ca. 1882 to anticipate by circa 70 years the circle map of Ahlfors (1948–1950). Here is our reasoning.

First, Schottky's thesis contains two striking results:

- the *circle map* (CM) of a (compact) multiply-connected domain to the disc, and beside
- what later came to be known (in Koebe's era, cf. e.g., Koebe 1922 [468]) the *Kreisnormierungsprinzip* (KNP) to the effect that any such domain is conformally equivalent to a circular domain. (Recall from Klein's quote (6.7) that this occurs only in the original Latin version of Schottky's thesis.)

Both results are natural extensions of RMT (=Riemann mapping theorem) either by allowing branched coverings or just by using faithful conformal diffeomorphisms (but then of course the target depends upon moduli).

Now loosely speaking one may consider both results (CM and KNP) as lying at the same order of difficulty (at least both are to be found in Schottky's thesis, and in cryptical form already in Riemann's Nachlass).

Next, Klein points out (cf. right above Quote 6.7) that he was able in 1881–82 to prove an extension of (KNP) to positive genus $p > 0$, which he calls (apparently with Fricke's assistance—cf. Klein 1923 [443, p.623, footnote 4]) the *Rückkehrschnitttheorem* (RST). Klein was very proud of this result (cf. especially Klein 1923 [443, p.584], where this discovery is dated from September 1881 (Borkum)), comparing it (as a psychological experience) to Poincaré's discovery of his general *fonctions fuchsiennes*.

Thus, there is an obvious commutative diagram (Fig. 10), and whatsoever the actual meaning of Klein's (RST) should be, there is only a single natural candidate to fill in the diagram at the (triple) question-marks, namely the Ahlfors circle map. This accentuate once more why Klein may have been a serious candidate to anticipate the Ahlfors circle map, at least without extremal interpretation.

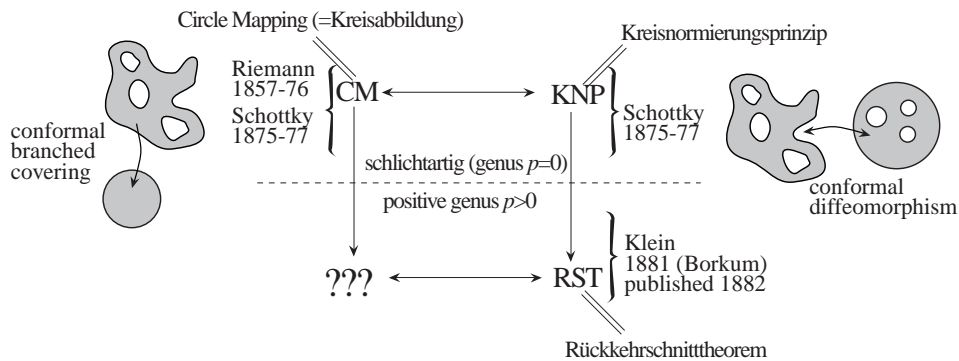

Figure 10: How Klein could miss the Ahlfors map?

Furthermore, in view of say Gabard 2006 [255], the Ahlfors mapping amounts essentially to Jacobi's inversion problem in the real case, and here again this was one of Klein's major preoccupation (cf. e.g., Weichold's thesis 1883 [873], Hurwitz's work 1883 [383], plus other sources, e.g. Klein 1892 [438]).

Of course, it would be an excellent idea to try getting acquainted with Klein's techniques so has to inspect if they can lead to another elementary existence-proof of the Ahlfors circle mapping function. Again it should be recalled that even if Klein himself was never able to complete his programme some helping hand from Brouwer-Koebe ultimately vindicated all of Klein's intuitions.

6.5 Rückkehrstheorem (Klein 1881–82)

Klein found this theorem in 1881, and published it 1882 in [435]. From the start the paper confesses to use some irregular methods.

What does Klein in this paper? First he takes a closed Riemann surface of genus $p > 1$ (w.l.o.g) and traces on it p disjoint Rückkehrschnitten (retrosections) and asserts that the cutted Riemann surface may be mapped to a $2p$ -ply connected domain on the sphere, whose corresponding boundaries A'_i, A''_i are related by a linear substitution. He then uses these p substitutions to reproduce the conformal mapping ad infinitum (a trick appearing already in Riemann's Nachlass 1857 [689]). He notes that the construction depends on the right number of free constants $3p$ compatible with Riemann's moduli $3p - 3$, thus yielding a sound evidence for some sort of uniformization. Of course it is not yet the standard uniformization as the reproduced domain filling more and more the sphere still avoids an infinite set (a Cantor set). In fact this construction gives an unramified infinite cover of the given closed Riemann surface by a subregion of the sphere (which is however not simply-connected).

Then he applies a similar method to the case of symmetric Riemann surfaces by using a symmetric system of retrosections while showing that the above construction may be done equivariantly. For instance in the simpler to visualize dividing case the above dissection process leads to a similar symmetric domain, symmetric with respect to the orthogonal symmetry of the sphere (whence the name *orthosymmetric*). In the non-dividing case the structural symmetry is rather the diametral one (antipodal map), whence the name *diasymmetric*.

Logically it seems that Klein's method depends on Schottky's inasmuch as first doing the retrosections one is reduced to the schlichtartig case which turns out to be schlicht. (This result was extended by Koebe in 1908 [452] to schlichtartig surfaces of infinite connectivity: schlichtartig implies schlicht!)

Clearly something remains to be understood on this RST, and my above guess that it is sufficiently strong to imply Ahlfors theorem is a quite disputable Ansatz. At any rate Klein seems to have had a clear-cut conception of how his dichotomy ortho- vs. diasymmetric is reflected into the Riemann sphere with its two real structures (equatorial symmetry vs. antipody). However the issue that dividing curves are precisely those mapping to the equatorial sphere in a totally real fashion may have escaped his attention and does not seem to be logically reducible to his RST. Yet since RST is supposed to be the positive genus case of KNP (cf. Klein's quote (6.7)) it may be expected that one first establishes KNP and from here one deduces a circle map, much like Riemann was able to do for the zero genus case in his Nachlass [689]. This suggests yet another strategy to approach Ahlfors theorem.

[04.11.12] A more naive idea could be to start from a bordered surface of type (r, p) , and make p retrosections to get it planar (but with $r + 2p$ contours). Then there is on the dissected surface a circle map of degree $r + 2p$. Of course the map is a priori not assuming the same values on both ridges of the retrosections and even if we can arrange this, we would like those points to get mapped in the interior and not the boundary of the circle.

6.6 Grunsky's bibliographical notes (Grunsky 1978)

Let us now reproduce Grunsky's historical comments (in his monumental book 1978 [322, p.198]) about circle maps. (Brackets are ours additions. We added author's names in front of the bracket-references to improve readability, plus page numbers, and finally inserted the symbol ★ when disagreeing with Grunsky's cross-references.)

Quote 6.8 (Grunsky 1978) Theorem 4.1.1. goes back to Riemann 1857/58/76 [689], who gave some hints for the proof if [the domain] D is bounded by circles. The first proof is due to Bieberbach 1925 [97], who used the Schottky-double and deep results in the theory of algebraic functions. Elementary proofs were given by Grunsky 1937 [315], 1941 [316]; for 4.1.3. [a sort of auxiliary lemma in linear algebra] see

Furtwängler 1936, Bourgin 1939. Related proofs in Akira Mori 1951 [570], Komatu 1953 [471] (containing generalizations), Tsuji 1956 [840]; cf. Golusin 1952/57 [296], Tsuji 1959 [841]. A proof based on the method for Plateau’s problem: Courant 1937 [189] [★ in Gabard’s opinion this paper does not reprove the circle mapping, but rather the mapping to a Kreisbereich, due to Schottky–Koebe, cf. p. 709 and p. 717, of *loc. cit.*], generalized in Courant 1939 [191]; cf. Courant 1950 [195] [especially p. 183–187]. Another proof, using, like Bieberbach 1925 [97], the Schottky double in Wirtinger 1942 [891]; cf. also Rodin-Sario 1968 [701] [where ???]. Triply connected domains: Limaye 1973 [514]. Representation of the mapping function (Ahlfors function, see 4.3.) by an orthonormal system in Meschkowski 1952 [551], by the Bergman kernel in Nehari 1950 [591]. Proofs using extremal properties in papers quoted in 4.3. and 6. [More about this below (Quote 6.9).] An extension to certain domains of infinite connectivity in Röding 1975 [708]. A more general type of image domain for doubly connected domains in Bieberbach 1957 [100].

Some generalizations, based on ideas used in the aforementioned papers, mainly concerning Riemann surfaces in Nehari 1950 [591], Tietz 1955 [830] (cf. Köditz-Timmann [470]), Mizumoto 1960 [564], Timmann 1969 (Diss., Hannover) [833], Röding 1972 (Diss., Würzburg) [707], Röding 1977 [710]. Cf. Ahlfors-Sario 1960 [22] [★ where?], Carathéodory 1950 [148] [★ where?], Sario-Oikawa 1969 [739] [★ where?].

Comments (Gabard, Mai 2012): Alas, regarding the three last books no pagination is supplied by Grunsky, and as far as I browsed through them, I failed to locate any place where Ahlfors’ circle mapping is established anew.

Now we reproduce Grunsky 1978 [322, p. 199]:

Quote 6.9 (Grunsky 1978) Theorem 4.3.1., a generalization of Schwarz’ lemma to multiply connected domains, is a special case of a more general theorem (individual bounds on each boundary component, prescribed zeros) proved by Grunsky in 1942 [318] (save for uniqueness, see Grunsky 1950 [320]). Cf. Hervé 1951 [373]. Another proof of 4.3.1. was given by Ahlfors in 1947 [16], completed in Ahlfors 1950 [17] (cf. Golusin 1952/57 [296]) and the extremal function is called the “Ahlfors function”, a term frequently used in the broader sense of any function mapping [the domain] D [in a] $(1, n)$ onto U [the unit disc]; the result was carried on to characterization of the additional zeros of the extremal function. The method used by Ahlfors, Euler-Lagrange multipliers (also pointed out in Grunsky 1946 [319] and applied in Grunsky 1940 [317]) is likewise a basis for our §6. – For further proofs of our theorem see Nehari 1951 [593] and Nehari 1952 [594, pp. 378 ff.], and some of the papers quoted for theorem 4.6.4. – Ahlfors function in a ring domain Kubo 1952 [480]. – Applications of the Ahlfors function in Alencyn 1956 [27], 1961 [28], (cf. Mitjuk 1965 [559]).

6.7 Italian school: Cecioni 1908, Stella Li Chiavi 1932, Matildi 1948, Andreotti 1950

Of course in the overall Grunsky’s comments and references are essentially sharp (especially a deep knowledge of Russian/Ukrainian works). Maybe only some contribution of the Italian school are ignored.

For instance the simple continuity argument in the Harnack maximal case based upon Riemann-Roch (without Roch) gives a simple proof in this case (compare e.g., Huisman 2001 [382] or Gabard 2006 [255]). This simple argument goes back to Enriques-Chisini seminal book 1915/18 [225], and may have been implicit in Riemann’s original manuscript (not published), compare Bieberbach’s quote (6.1).

Further, closely allied work is to be found in works of Cecioni 1908 [160], and his students: Salvemini 1930 [732], Stella Li Chiavi 1932 [508], etc. (Incidentally some of those references are listed in Ahlfors-Sario 1960 [22].)

Those works certainly deserves closer studying, but they do not seem to establish Ahlfors circle map. One notable exception is the article Matildi 1945/48 [536] (discovered by the writer as late as 13.07.12), where existence of Ahlfors circle maps for the case of surfaces with a single contour seems to be established. (This Italian work again was known to Ahlfors (or Sario?) at least as late as 1960, being quoted in Ahlfors-Sario 1960 [22].) Of course it would be interesting to see if Matildi’s method adapts to the more general setting of several

contours, and also try to make (more) explicit the degree bound obtained by him. Andreotti 1950 [45] seems to go precisely in this sense while including the case of several contours (yet the Italian of the writer is declining sufficiently fast so as to have failed to understand properly what Andreotti really achieves).

7 Is there any precursor to Ahlfors 1950?

7.1 What about Teichmüller?

One can wonder about the content of Teichmüller's Werke. Does it overlap with the Ahlfors function? While reading the long memoir of Teichmüller 1939 [825] it transpires to anybody familiar with Klein's work how strong the latter's influence is; in particular Teichmüller gives a thorough account of the (now) so-called *Klein surfaces* (and their moduli). Of course such results were anticipated by Klein (at least at the heuristic level). Hence, it seems quite natural to wonder if Teichmüller anticipated the existence of Ahlfors function (for orientable membranes). Here is a report of those portions of Teichmüller's works which looks closest to this goal, but it should still be debated how much of the Ahlfors circle maps was anticipated by Teichmüller.

The most relevant passage in Teichmüller's writings seems to be the following extract of Teichmüller 1941 [826] (reedited in [827, p. 554–5]):

Quote 7.1 (Teichmüller 1941) Wir beschäftigen uns nur mit **orientierten endlichen Riemannschen Mannigfaltigkeiten**. Diese können als Gebiete auf geschlossenen orientierten Riemannschen Flächen erklärt werden, die von endlich vielen geschlossenen, stückweise analytischen Kurven begrenzt werden. Sie sind entweder geschlossen, also selbst geschlossene orientierte Riemannsche Flächen, die man sich endlichvielblättrig über eine z -Kugel ausgebreitet vorstellen darf, oder berandet. Im letzteren Falle, kann man sie nach Klein durch konforme Abbildung auf folgende Normalform bringen: ein endlichvielblättriges Flächenstück über der oberen z -Halbebene mit endlich vielen Windungspunkten, das durch Spiegelung an der reellen Achse eine symmetrische geschlossene Riemannsche Fläche ergibt; [...]

(So läßt sich z. B. jedes Ringgebiet, d. h. jede schlichtartige endliche Riemannsche Mannigfaltigkeit mit zwei Randkurven, konform auf eine zweiblättrige Überlagerung der oberen Halbebene mit zwei Verzweigungspunkte abbilden.)

Unfortunately, no precise cross-reference to Klein is given and one needs to browse Klein's works (with the option of some Göttingen Lectures Note 1891/92 [439], [440] not reproduced in Klein's collected papers). This absence of precise location is quite annoying. A charitable excuse is the World War II context in which the paper was written: "*Weil mir nur eine beschränkte Urlaubzeit zur Verfügung steht, kann ich vieles nicht begründen, sondern nur behaupten.*" (compare *loc. cit.* [827, p. 554] 2nd parag.)

7.2 Detective work: Browsing Klein through the claim of Teichmüller

Regarding Teichmüller's cryptical allusion to Klein (as discussed in the previous section) we have the following candidates in Klein's works (none of which at the present stage of our historical search truly corroborates Teichmüller's crediting):

- (1) Klein 1882 [434, p. 75]=[443, p. 567] where one reads:

Quote 7.2 (Klein 1882) *Man hat also eine komplexe Funktion des Ortes, welche in symmetrisch gelegenen Punkten gleiche reelle, aber entgegengesetzt gleich imaginäre Werte aufweist.*

This looks quite close to the desired assignment, yet in reality only corresponds to the existence of a real morphism on any real curve; equivalently the existence for any (closed) symmetric Riemann surface of an equivariant holomorphic map to the sphere acted upon by the (usual) complex conjugation fixing

an equator. Hence, in our opinion, this passage of Klein cannot be regarded as a genuine forerunner of the Ahlfors circle mapping.

(2) Another place where Klein comes quite close to Teichmüller’s assertion occurs in the same 1882 booklet “*Über Riemanns Theorie ...*”, where Klein computes the moduli of real algebraic curves—equivalently symmetric Riemann surfaces (cf. [443, p. 568–9]):

Quote 7.3 (Klein 1882) Indem wir uns jetzt zu den *symmetrischen* Flächen wenden, haben wir noch eine kleine Zwischenbetrachtung zu machen. Zunächst ist ersichtlich, daß zwei solche Flächen nur dann “symmetrisch” aufeinander bezogen werden können, wenn sie neben dem gleichen p dieselbe Zahl π der Übergangskurven [=real “ovals”] darbieten und überdies beide entweder der ersten Art oder der zweiten Art angehören. [This is the dichotomy ortho- vs diasymmetric.] Im übrigen wiederhole man speziell für die symmetrischen Flächen die Abzählungen des §13 betreffs der Zahl der in eindeutigen Funktionen enthaltenen Konstanten unter der Bedingung, daß nur solche Funktionen in Betracht gezogen werden, welche an symmetrischen Stellen konjugiert imaginäre Werte aufweisen. Hiermit kombiniere man sodann nach dem Muster des §19 die Zahl solcher über der Z -Ebene konstauerbarer mehrblättrigen Flächen, welche in bezug auf die Achse der reellen Zahlen symmetrisch sind. [...] Die Sache ist dann so einfach, daß ich sie nicht speziell durchzuführen brauche. Der Unterschied ist nur, daß die in Betracht kommenden, früher unbeschränkten Konstanten nunmehr gezwungen sind, entweder *einzel*n reell oder *paarweise konjugiert komplex* zu sein. Infolgedessen reduzieren sich alle Willkürlichkeiten auf die Hälfte. Wir mögen folgendermaßen sagen:

Zur Abbildbarkeit zweier symmetrischer Flächen $p > 1$ aufeinander ist neben der Übereinstimmung in den Attributen das Bestehen von $(3p - 3)$ Gleichungen zwischen den reellen Konstanten der Fläche erforderlich.

If this passage sounds a bit sketchy to the reader, we may refer to Klein’s subsequent lecture notes of 1892 [440, p. 151–4], where full details are given.

The basic idea of this (Riemann-style) moduli count is to represent a given curve of genus g as an m -sheeted cover of the line. If m is large enough (so as to avoid exceptional cases of Riemann-Roch’s theorem), a group g_m of m points will move in a linear system of dimension $m - g$. To specify a map to \mathbb{P}^1 we may send the divisor $g_m =: D$ to 0, say, and another D' (linearly equivalent to the former) to ∞ , leaving the possibility of a scaling factor. Thus the function depends on $2m - g + 1$ constants. On the other hand by Riemann-Hurwitz such maps have $2m + 2g - 2$ branch points. Hence considering the totality of such covers modulo those yielding the same curve leaves $2m + 2g - 2 - (2m - g + 1) = 3g - 3$ essential constants. (cf. also Griffiths-Harris 1978 [303, p. 256]).

Klein adapts this counting argument to the real case (again for full details we recommend [440, p. 151–4]). Doing so we may hope that he anticipates the Ahlfors mapping when the construction is particularized to the orthosymmetric case.

Since a totally real morphism lacks real ramification, we must prescribe imaginary conjugate branch points. However this necessary condition is not sufficient as shown by a quartic smoothing a visible conic plus an invisible one like $x^2 + y^2 = -1$. In this case the projection from the interior of the oval yields a real map without real ramification, but not totally real.

We see no obvious link from Klein’s equivariant branched covers to the stronger assertion that fibres over real points consists only of real points, and consequently one of the orthosymmetric halves maps conformally to the upper half-plane (as Teichmüller credits to Klein).

Of course it is not impossible that a suitable complement to Klein’s method yields something like an Ahlfors mapping. By a continuity argument in Gabard 2006 [255, Lemme 5.2], it would be enough to chose $g_m =: D$ as an *unilateral* divisor, i.e. one whose support is entirely contained in one half of the curve. Then we would be finished if the symmetric divisor D^σ is linearly equivalent to D . But this condition is far from automatic and involves probably some lucky choice in the position of the initial divisor D .

Alternatively, one may try to specify the ramification and work out the Lüroth-Clebsch sort of argument to construct explicitly the finitely many conformal type of Riemann surfaces lying above the prescribed ramification. But the writer failed to draw any serious conclusion.

7.3 More is less: Teichmüller again (1939)

For those not overwhelmed by German prose, the following passage also bears some resemblances to the Ahlfors function:

Quote 7.4 (Teichmüller 1939 [825, p.103]) Falls \mathfrak{M} eine orientierte und berandete Mannigfaltigkeit ist, braucht man f nur auf \mathfrak{M} zu kennen, um f auf \mathfrak{F} berechnen zu können. [The latter is of course the doubled surface.] f muß dann auf den Randkurven von \mathfrak{M} , die ja zu sich selbst punktweise konjugiert sind, reelle Werte haben. Umgekehrt ist eine Funktion der Fläche, die in unendlich vielen Randpunkten von \mathfrak{M} reell ist, eine Funktion von \mathfrak{M} , denn sie stimmt mit der konjugierten in unendlich vielen Punkten überein und ist darum gleich ihrer konjugierten Funktion. Ja, wir können die Funktionen f von \mathfrak{M} sogar ganz auf \mathfrak{M} charakterisieren:

Die Funktionen der orientierten berandeten endlichen Riemannschen Mannigfaltigkeit \mathfrak{M} sind genau die Funktionen f , die in \mathfrak{M} bis auf Pole regulär analytisch sind und die am Rande von \mathfrak{M} reell werden. D. h. die Punkte, wo die Funktion Werte eines abgeschlossenen Kreises der oberen oder der unteren Halbebene annimmt, sollen eine kompakte Menge im Innern von \mathfrak{M} bilden. In der Tat lassen sich diese Funktionen durch Spiegelung zu Funktionen von \mathfrak{F} machen, insbesondere sind sie auf den Randkurven von \mathfrak{M} stetig.

In this passage we note that just adding the single word “nur” in the third line of the 2nd parag. to read “die nur am Rande von \mathfrak{M} reell werden” would essentially lead to an anticipation of Ahlfors 1950.

However taken literally this assertion of Teichmüller is weaker than Ahlfors’ and indeed the previous Quote 7.1 is perhaps just a logical distortion (through hasty writing!) of the above more precise (but logically weaker) formulation. Under this hypothesis then we agree perfectly with Teichmüller 1941 (cf. again Quote 7.1) that this reality behaviour of functions was known to Klein.

The crucial distinction is between functions real on the boundary and those which are real only on the boundary. Now a priori a real function may be real on an interior point of the membrane, in which case the range (of the function) will not be contained in one of the half-plane, but overlap with both of them. In contrast a stronger reality behaviour arises when fibres of real points excludes imaginary conjugate points, in which case the range is contained in one of the half-plane, which is the context of Ahlfors’ circle mapping.

7.4 Courant 1937, 1939, 1950

In the paper Courant 1939 [191], one detects another approach to the existence of circle maps via the methods of Plateau’s problem (at least so is claimed by Grunsky 1978, cf. Quote 6.8). We cite some portion of Courant’s introduction:

Quote 7.5 (Courant 1939) The theory of Plateau’s and Douglas’ problem furnishes powerful tools for obtaining theorems on conformal mapping. Douglas emphasized (1931) that Riemann’s mapping theorem is a consequence of his solution of Plateau’s problem; then he treated doubly connected domains and in a recent paper (1939) multiply connected domains. With a different method I gave in a paper on Plateau’s problem (1937) a proof of the theorem that every k -fold connected domain can be mapped conformally on a plane domain bounded by k circles. The same method can be applied to the proof of the parallel-slit theorem and, as will be shown in the thesis of Bella Manel, to mapping theorems for various other types of plane normal domains. It is the purpose of the present paper first to give a simplification of the method by utilizing an integral introduced by Riemann in his doctoral thesis, and secondly, to prove a mapping theorem of a different character referring to normal domains which are Riemann surfaces with several sheets.

[...]

For the case $p = 0$, the theorem was stated by Riemann, according to oral tradition. [See Bieberbach 1925, where a proof is indicated; and Grunsky 1937, where another proof is given.]

It should still be elucidated if this work by Courant (officially overlapping with Bieberbach–Grunsky) may also be connected to the Ahlfors circle mapping. This is still not completely clear to the writer.

The topic is addressed again in Courant’s book of 1950, e.g., as follows:

Quote 7.6 (Courant 1950 [195, p.183, Thm 5.3]) *Theorem 5.3: Every plane* [footnote 12: As said before, in view of the general result of Chapter II the assumption that G is a plane domain is not an essential restriction.] *k -fold connected domain G having no isolated boundary points can be mapped conformally onto a Riemann surface B consisting of k identical disks, e.g. interiors of unit circles, connected by branch points* [footnote 13: The conformality of the mapping is of course interrupted at the branch points.] *of total multiplicity $2k - 2$. [. . .]*

This somewhat loose footnote 12 of Courant may advance him as a forerunner of the Ahlfors circle map. Courant does not specify the degree derived by his method, but reading him literally one recovers (quite strikingly!) Ahlfors’ bound $r + 2p$ (compare the following numerology):

Numerology 7.7 The connectivity k of a membrane of genus p with r contours is equal to $r + 2p$ (each handle contributes 2 units to the connectivity). [Alternatively, we may interpret the connectivity k as $b_1 + 1$, where b_1 is the first Betti number. The Euler characteristic is $\chi = 2 - 2p - r$, but also expressible as $\chi = 1 - b_1$ (since $b_2 = 0$). Back to the connectivity, we find $k = b_1 + 1 = (1 - \chi) + 1 = 2 - \chi = 2 - (2 - 2p - r) = 2p + r$, as desired.]

Adopting Courant’s branching multiplicity $b := 2k - 2$, we compute the corresponding degree d . By Riemann–Hurwitz $\chi = d \cdot \chi(D^2) - b$, hence $d = \chi + b = (2 - 2p - r) + (2k - 2) = 2k - 2p - r = 2(r + 2p) - 2p - r = r + 2p$. *q.e.d.*

This is pure numerology, without much control of the underlying geometry. More insight is suggested by Courant’s subsequent statement in *loc. cit.* [195, p.183–4, Thm 5.3], which we reproduce:

Quote 7.8 (Courant 1950) Moreover, an arbitrarily fixed point F_ν on each boundary circle β_ν can be made to correspond to a fixed boundary point P_ν on the boundary continuum γ_ν of G , and the position of one simple branch point in B may be prescribed. The class \mathfrak{N} of these domains depends on $3k - 6$ real parameters: the $2k - 3$ freely variable branch points represent $4k - 6$ coordinates, while fixing the points F_ν reduces the number of parameters by k .

Extending this reasoning to (non-planar) membranes, we derive again Ahlfors’ bound, as follows:

Numerology 7.9 We assume the membrane $F_{p,r}$ (of genus p with r contours) conformally mapped as a d -sheeted cover of the disc D^2 with b branch points. As usual the Riemann–Hurwitz relation reads $\chi = d \cdot \chi(D^2) - b$. From the b branch-points, one of them can be normalized to a definite position (through a conformal automorphism of the disc). Now the fibre over a boundary point of the disc gives d points on ∂F . Those d boundary points can be thought as having a prescribed image. Thus the mapping itself is fully determined by $2(b - 1) - d$ real constants.

On the other hand, we know since Klein 1882 (cf. our Quote 7.3) that $F_{p,r}$ has $3g - 3$ real moduli where g is the genus of the double $2F$, i.e. $g = 2p + (r - 1)$. Positing the Ansatz that the family of d -sheeted covering surfaces has enough free-parameters to fill the full moduli space leads to the inequation $2(b - 1) - d \geq 3g - 3$. But $b = d - \chi$ and $2\chi = \chi(2F) = 2 - 2g$. Hence $2(d - \chi - 1) - d = d + (2g - 2) - 2 \geq 3g - 3$, i.e. $d \geq g + 1$, which is Ahlfors’ bound $r + 2p$.

Of course, this happy numerology (noticed by the writer as the [20.05.12]) is no substitute to a serious proof of the Ahlfors circle map. However Courant formulates a variational problem à la Plateau-Douglas (or Dirichlet-Riemann-Hilbert) affording existence of a circle map (presumably with the same bound as predicted by Ahlfors as prompted by our heuristic count). Unfortunately, in Courant's book the presentation is not directly adapted to the case of general membranes of positive genus ($p > 0$), making the reading somewhat hard to digest. Hopefully someone will manage in the future to present a self-contained account based upon Courant's method. (This project involves some hard analysis and will be deferred to a subsequent technical section. ABORTED: I had not the time/force to adapt Courant's text to the higher context suggested by his footnote.) Of course in view of Carathéodory's philosophy (cf. Quote 1.1) one may wonder which of Courant's vs. Ahlfors approach enjoys methodological superiority? Further remind that Ahlfors (1950 [17, p. 125–6]) has also an elementary argument for the circle mapping involving no extremal problem.

Another puzzling feature of the above numerology is that it gives the impression that any $r + 2p$ points prescribed on the contours may be mapped to a fixed point of the circle. Whether this really deserves to be investigated.

Trying to read Courant's book 1950 [195] with the focus of the Ahlfors circle map is not an easy task (in our opinion). We may then hope that reading the original 1939 article [191] is easier due to its more restricted content. Let us write down its main statement:

Quote 7.10 (Courant 1939 [191, p. 814]) We consider a Riemann surface on a u, v -plane consisting of the interior of k unit circles which are connected in branch points of total multiplicity $2k - 2$; to this surface we affix $p \geq 0$ full planes with two branch points each. Thus we define a class of domains B with the boundary b on the plane of $w = u + iv$.

Now our theorem is: Each k -fold connected domain G in the x, y -plane with the boundary curves g_1, g_2, \dots, g_k [...] can be mapped conformally on a domain B of our class for any fixed p .

In this mapping the branch points on the full planes and one more branch point may be arbitrarily prescribed and, moreover, on each boundary circle b_ν of B a fixed point may be made to correspond to a fixed point of g_ν .

Personally, I find this statement hard-to-read for several reasons, I shall list subsequently. Moreover it is not clear if suitably interpreted, it really implies the Ahlfors circle mapping.

How to interpret this statement of Courant? Here are some critics probably due to the writer's incompetence (rigid brain)! On the one hand, we have B , which moves in a class of domains. Perhaps those are Riemann surfaces? For instance the operation of affixing p full planes may give a surface of genus p , at least this is what is suggested by a latter publication of Courant 1940 [192], whose relevant portion we quote again for definiteness:

Quote 7.11 (Courant 1940 [192, p. 67]) On the basis of the previous results, the proof of the characteristic relation $\varphi(w) = 0$ for the solution of the variational problem becomes very simple, if the underlying class of domains B is chosen not as a domain in the plane but as a Riemann surface all of whose boundary lines are unit circles. This class is defined as follows:

We consider for the case of genus zero a k -fold connected domain B formed by the discs of k unit circles which are connected in branch points of the total multiplicity $2k - 2$. For higher genus p , we obtain domains B by affixing to the k -fold circular disc p full planes each in 4 branch points [footnote 2: Each such full plane represents a "handle" and increases the genus by 1.].

Well, but then the domain B of Quote 7.10 would have genus p . Then how is it possible for him to get mapped conformally (in a one-to-one fashion?) to the domain G , which seems to be planar since its connectivity is equal to the number of boundaries! Perhaps G should be assumed to be $(k + 2p)$ -fold connected (or put more briefly G should have genus p and k contours)?

If so then Courant gives a (conformal) one-to-one(?) map (=diffeomorphism) $G \rightarrow B$ onto a “normal” domain B . To make a link with Ahlfors, it would be desirable to know if B maps to the disc even after the affixing of the p full planes. (Incidentally, this operation is somewhat poorly defined, but perhaps better exposed in other publications, cf. e.g., Courant’s book 1950 [195, p. 80 and ff.] or Courant 1949/52 [196].)

Hence the crucial point would be to know if B is a many-sheeted cover of the disc, and if yes: how many sheets are required? Very naively $k + p$ could suffice, in which case Courant would not only compete with Ahlfors 1950 [17], but also with Gabard 2006 . . . (NB: This $(k + p)$ -sheeted-ness occurs again in Courant 1940 [192, p. 78], and it would be of interest to decide if this constitutes an anticipation of Gabard 2006.)

If we push our misunderstanding of Courant to its ultimate limit, we may have the impression that what he do, is an attempt to mix the parallel-slit mapping he learned from Hilbert 1909 [377], with the Riemann-Schottky-Bieberbach-Grunsky theorem, but that the resulting surgery/transplantation does not lead to any really viable creature.

Of course, probably much of our misunderstanding is caused not merely from the difficult mathematics but also from a shift in language (plus perhaps some inaccuracies due to the torrential number of publications?), yet we may still hope that either an appropriate reading (or reorganization) of Courant’s thoughts may lead to an anticipation of the Ahlfors circle map. Hence, we encourage strongly any reader able to take the defense of Courant to publish an account in this direction.

Finally, we cite another papers of Courant about conformal maps, which could be of some relevance:

- Courant 1937 [189], especially p. 682, footnote 7, where we read: “*If we assume the possibility of a conformal mapping on the unit circle for all surfaces admitted to competition [. . .]*”. This could have some connection with Ahlfors circle maps, but probably does not. Later on, this article contains some conformal mapping theorems, which are only announced without proof. Perhaps, those could be of some relevance. Especially Fig. 11, p. 722, seems to be close to Klein’s Rückkehrschnitt-Theorem, and could eventually leads to a proof of Ahlfors? This paper also relates the ideas of J. Douglas about minimal surfaces (especially his extended version of the Plateau problem for surfaces of higher topological structures, where Douglas uses systematically Klein’s symmetric surfaces). One may therefore wonder if Ahlfors’ circle maps may somehow find application in this grandiose theory of minimal surfaces à la Plateau-Douglas-Radó-Courant, etc. As far as the writer knows no direct connection is presently available in print, despite the probable vicinity of both topics.

- Courant 1938 [190], especially p. 522 “*Every plane k -fold connected domain can be mapped conformally to a k -fold unit circle*”. Hence the result we are mostly interested in occur here already in 1938. In contrast to the 1939 version [191], here neither Riemann, nor Bieberbach 1925 [97] or Grunsky 1937 [315] are cited. Did Courant rediscovered the result independently?

- Finally we quote, Courant 1919 [187], where (under some influence of Hilbert 1909, and Koebe 1909) conformal mappings to “normal domains” are discussed for non-schlichtartig surfaces (of finite genus). This is also re-discussed in Courant’s book of 1950 [195].

Last but not least, it is perhaps relevant to remind that some doubts were expressed by Tromba 1983 [837] about the validity of Courant’s argumentation regarding higher genus cases of the Plateau-Douglas problem (compare also Jost 1985 [402]). It is not clear to the writer if Tromba’s objections compromise seriously the validity of Courant’s assertions (regarding higher genus conformal maps re-derived via the method of Plateau). This could be a another obstacle toward completing a Courant-style approach to the Ahlfors map.

7.5 Douglas 1931–36–39

Having discussed (very coarsely) Courant, it would be unfair to neglect J. Douglas. His resolution of Plateau’s problem interacts strongly with conformal mapping, with the distinctive attitude (partially successful) of not getting subordinated to the latter. As already pointed out (in Courant’s Quote 7.5), Douglas re-derived the (RMT) as the 2D-case of Plateau (cf. Douglas 1931 [209, p. 268]). Subsequently, Douglas extended his Plateau solution to configurations of higher topological structure (cf. Douglas 1936 [210], 1939 [211], 1939 [212]). Thus, it is nearly natural to ask if Douglas (himself, or at least his methods) may anticipate/recover the Ahlfors circle map? Ironically, Douglas’ work relied on Koebe’s, and interestingly took a systematic advantage of (Klein’s) symmetric Riemann surfaces (e.g., orthosymmetry). Without entering the details of all those exciting connections, we just refer to the cited original works, plus the account of Gray-Micallef 2008 [301], of which we quote some extracts:

Quote 7.12 (Gray-Micallef 2008 [301, p. 298, §4.3; p. 299, §4.5]) An unexpected bonus of Douglas’s method is a proof of the Riemann-Carathéodory-Osgood Theorem, which follows simply by taking $n = 2$. [...] Douglas was rightly proud that his solution not only did not require any theorems from conformal mapping but that some such theorems could, in fact, be proved using his method.

However, Douglas did have to use Koebe’s theorem in order to establish that his solution had least area among discs spanning Γ . He had hoped to fix this blemish, but he never succeeded. That had to wait for contributions from Morrey [1948] and, more recently, from Hildebrandt and von der Mosel [1999]. [...]

Even before working out all the details for the disc case, Douglas was considering the Plateau problem for surfaces of higher connectivity and higher genus. [...] As early as 26 October 1929, Douglas announced that his methods could be extended to surfaces of arbitrary genus, orientable or not, with arbitrarily many boundary curves in a space of any dimension. He may well have had a programme at this early stage, but it is doubtful that he had complete proofs. Even when he did publish details in [3](=1939=[211]), the arguments are so cumbersome as to be unconvincing. One should remember that Teichmüller theory was still being worked out at that time and that the description of a Riemann surface as a branched cover of the sphere is not ideally suited for the calculation of the dependence of the A -functional on the conformal moduli of the surface. Courant’s treatment in [7](=1940 [192]) was more transparent but still awkward. The proper context in which to study minimal surfaces of higher connectivity and higher genus had to wait until the works of Sacks-Uhlenbeck [19](=1981), Schoen-Yau [20](=1979), Jost [11](=1985) and Tombi-Tromba [21](=1988). [...]

Finally, we mention the recent work of Hildebrandt-von der Mosel 2009 [379], plus the survey Hildebrandt 2011 [380]. Here we learn, that Morrey 1966 [571] was the first to re-prove Koebe’s KNP (=Kreisnormierungsprinzip) via Plateau, modulo a gap fixed by Jost 1985 [402]. The ultimate exposition of 2009 (of loc. cit. [379]) is intended to be “*possibly simpler and more direct*” (loc. cit., 2009, p. 137) and “*are complete analogs of the approach of Douglas and Courant*” (loc. cit., 2011, p. 77).

As an agenda curiosity, it seems that the “Plateau-ization” of conformal mapping theorems occur along some diabolic chronological regularity. Indeed from Riemann 1851 [686] to Douglas 1931 [209], gives an elapsing period of 80 years. For circle maps, we have from Riemann 1858 to Courant 1939(–1) also 8 decades, and from Koebe 1904 (announcement of KNP, in his Thesis talk, yet without convergence proof until 1907-08) to Jost 1984 gives the same interval of time. Thus Ahlfors 1950 [17] can safely wait up to 2030, before getting reproved (via the method of Plateau)?

Again, from our focused viewpoint, the critical question is whether within the problem of Plateau (à la Douglas–Radó–Courant, etc.) germinates an alternative proof of the Ahlfors mapping. As far as we know, the paper closest to this goal his Courant 1939 [191]. Yet, we cannot readily claim that it includes the result of Ahlfors 1950.

7.6 Cecioni and his students, esp. Matildi 1948, and Andreotti 1950

Among several interesting works of Cecioni and his students (cf. Section 6.7) we point out especially the article by Matildi 1948 [536] (discovered by the writer as late as [13.07.12]). In it the existence of an (Ahlfors-type) circle map in the special case of surfaces with a single contour seems to be established via classical potential theoretic tricks, plus at the end some algebraic geometry. This work was known to Ahlfors (or Sario?) at least as late as 1960, being quoted in Ahlfors-Sario 1960 [22]. It would be interesting to see if Matildi's method adapts to an arbitrary number of contours, and also try to make (more!) explicit the degree bound obtained by him. In that case Matildi should be considered as a serious forerunner of Ahlfors 1950 [17], at least at the qualitative level (no extremal problem). Perhaps, il professore Cecioni himself has—and may have—several works (some of which we could not consult as yet) coming quite close to the circle mapping thematic à la Ahlfors.

The idea that Matildi's argument should extend easily to the case of several contours looks an accessible exercise. Andreotti 1950 [45] seems to go precisely in this sense.

7.7 A global picture (the kaleidoscope)

The place occupied by RMT (Riemann mapping theorem) is quite pivotal in conformal mapping with an organical explosion of results around it, like:

- KNP=Kreismapierungsprinzip (implicit in Riemann 1857/8, Schottky 1875 (Latin version of his thesis, cf. Klein's Quote 6.7), in full by Koebe 1905-10-20).
- RS=Riemann-Schottky mapping of a multiply-connected domain to the disc.
- AM=the Ahlfors mapping (of a compact bordered surface to the disc).
- GKN=generalized Kreismapierung (of a compact bordered surface to a circular domain inside a closed Riemann surface of constant curvature having the same genus p): apart from some anticipation for $p = 1$ Strebel 1987 [810] and Jost (unpublished), the full result is due to Haas 1984 [329] (existence), and Maskit 1989 [534] (uniqueness). For an approach via circle packings, compare also He 1990 [352] and He-Schramm 1993 [353].

On the other hand there is a large panoply of methods including:

- algebraic functions (Abel 1826, Jacobi 1832, Riemann 1857, etc.),
- potentials (Dirichlet ca. 1840, Green 1828, Gauss 1839, Thomson 1848, etc.),
- iterative methods (Koebe, Carathéodory 1905–12),
- extremal problems (Fejér-Riesz 1922, Cathéodory 1928, Ostrowski 1929, etc.),
- orthogonal systems (Bergman kernel 1922, Szegő 1921)
- Plateau-Douglas functionals (Plateau 1849, Douglas 1930, Courant 1939 via Dirichlet resurrected),
- circle packings (originally in Koebe 1936, rediscovered by Andreev and Thurston 1985 with convergence proof by Rodin-Sullivan 1986),
- Ricci flow (Hamilton 1988 [332], which specialized to 2D enables one to recover the uniformization theorem); idem via Liouville's equation (desideratum Schwarz, followed by Picard 1890–93, Poincaré 1899, Bieberbach 1916 [94], etc., cf. Mazzeo-Taylor 2002 [539] for a modern account), and also e.g., Zhang *et al.* 2012 [910], where a mixed Ricci flow/Koebe's iteration is advocated.

Blending all these results with all those methods accessing them, we get the kaleidoscope depicted below (Fig. 11) attempting to classify a body of results in a (more-or-less) systematic fashion. Black arrows stress out methods effective in solving a certain mapping problem, whose extremity points to the source (listed in our bibliography). Starting around RMT, arrows are propagated by translation to other locations (e.g., RS, or KNP). Arrows turn to white colored, if the corresponding method has not yet been applied to solve the relevant mapping problem. Of course several methods (like the balayage of Poincaré 1907, or some of Koebe's method may be slightly outdated having few living practitioners). In contrast, Koebe's iteration method is still quite popular due

apparently to its computational efficiency (see e.g., Zhang et al. 2012 [910]), and presumably theoretically fruitful as well (*loc. cit.* where it is used in conjunction with the Ricci flow).

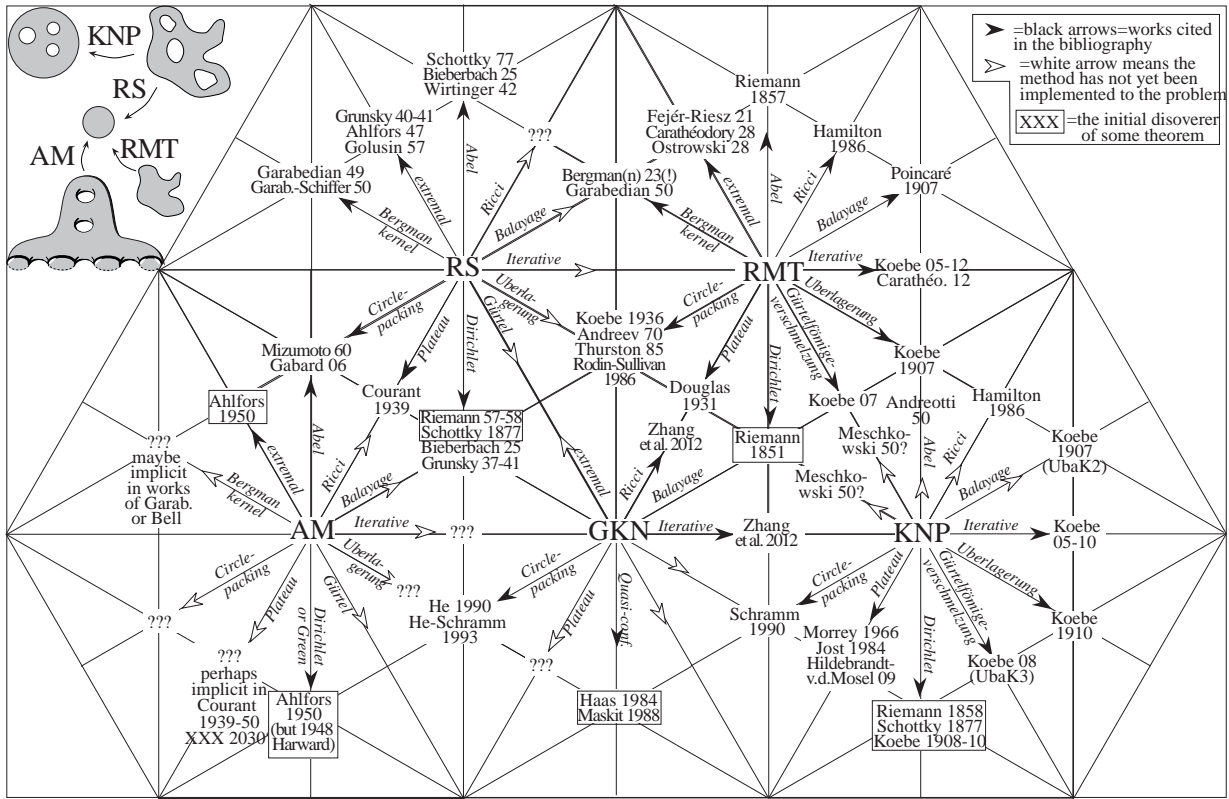

Figure 11: The kaleidoscope: several mapping theorems and some methods used to prove them

Of course the picture is hard to make completely reliable, yet it may aid feeling the power (or popularity) of some methods (e.g. the extremal problem method seems to apply quite universally, except presently to GKN). On the other hand some recent methods like circle packings looks very powerful, and may not have as yet explored their full range of applicability (e.g. regarding AM). As discussed in the previous section, we do not know if the Plateau method could crack the AM. Another powerful method is that of the Bergman kernel, which probably also lead to a derivation of the AM. When reading the paper of the period (1948–1950, Bergman, Schiffer, Garabedian, etc.) this seems to be almost folklore, as well as in some paper of Bell (e.g. 2002 [69]). Yet, the writer while spending some time at reading precisely what is put on the paper, he has rather the feeling that the positive genus case is never handled in full details. (As a general lamentation, it is an easy challenge to cite about 20 papers where results proved in the planar case are followed by the cryptical allusion that the proof works through without the planarity proviso.)

8 Digression on Bieberbach and Bergman

8.1 The Bergman kernel

Among the variety of methods mentioned in the previous section, one especially popular is the Bergman kernel function. This emerges as early as 1921/22 in Bergman's Thesis [75] (published 1922 in Math. Annalen). The point of departure is an area extremal problem going back to Bieberbach 1914 [92]. Interestingly, Bergman 1922 (*loc. cit.* [75, p.245]) confesses that he was not able to reprove the RMT with this method:

Quote 8.1 (Bergman 1922) In dem betrachteten Spezialfall (Minimalabbildung durch analytische Funktion) ist die erhaltene Minimalfunktion die Kreisabbildungsfunktion. Wie oben gezeigt, kann man die Existenz der ersteren unabhängig von dem Hauptsatz der Funktionentheorie beweisen; es besteht somit die Möglichkeit, den Hauptsatz auf diesem Wege von neuem zu beweisen, was mir aber bis jetzt nicht gelungen ist.

A similar lamentation is expressed by Bochner 1922 [107, p. 184]:

Quote 8.2 (Bochner 1922) Aus der Möglichkeit der Kreisuniformisierung eines einfach zusammenhängenden Bereiches folgt aber, wie Bieberbach bemerkt hat (l. c.), daß die Minimalabbildung mit eben der Kreisabbildung identisch ist, indes ist es mir nicht gelungen, aus der Minimalabbildung der Kreisuniformisierung aufs neue herzuleiten.

In a similar vein, some 3 decades later one among the prominent aficionados of the method wrote (source=Math.-Reviews for Lehto's Thesis 1949 [500])

Quote 8.3 (Nehari 1950) Despite its great intrinsic elegance and its adaptability for numerical computations, the theory of complex orthonormal functions (centering about the concept of the Bergman kernel function) had the drawback of being a mere representation theory; the fundamental existence theorems had to be borrowed from other fields. In §4 the author fills this gap in one important instance by giving an existence proof for the parallel-slit mappings (in the case of simply-connected domains this is identical with the Riemann mapping theorem [provided the slit is extended to ∞]) within the framework of the orthonormal function theory.

So somewhere in between 1922–1949 some technological turning point must have occurred amplifying dramatically the power of the Bergman kernel method. When and how did this occurred exactly? Probably through the Bergman–Schiffer collaboration in the 40's, plus some fresh blood like Garabedian or Lehto. In several subsequent publications of Garabedian and Schiffer, it is emphasized that parallel-slit mappings are easier than circle maps (cf. Quotes 11.1 and 11.2). However the Ahlfors circle map is still accessible to the (Bergman/Szegő orthogonal system) method as shown in Garabedian-Schiffer 1950 [279], where however only the planar case is handled in detail. Vague allusions states that the method extends to Riemann surfaces.

Inspecting back the Bergman method itself, it is not hard to understand why it is most readily implementable in the planar case. It seems indeed to require a sort global ambient coordinate system. Let us look at the beautiful original paper Bergman 1922 [75, p. 240]. Here the key idea is a characterization of the Riemann function $w: B \rightarrow \Delta$ (of a [simply-connected] domain B to the disc) as the one whose range $w(B)$ has smallest possible area amongst all functions $f: B \rightarrow \mathbb{C}$ under the constraint $f'(0) = 1$ [and $f(0) = 0$ after a harmless translation such that $0 \in B$]. The area swept out by f is calculated by the integral

$$\int \int_B f'(z) \overline{f'(z)} d\omega,$$

where $d\omega$ is the surface element in the B -plane, and the integrand $|f'(z)|^2$ measures the distortion ratio at z . Following Bieberbach 1914 (who in turn seems inspired by Ritz), Bergman plugs in place of $f(z)$ a polynomial (recall the finitistic motto of Bloch “*Nihil est infinito . . .*”):

$$w_n(z) = a_0 + a_1 z + \cdots + a_n z^n,$$

whose coefficient are determined so as to minimize the above integral under the constraint $w'_n(0) = 1$. There is always a unique such polynomial, which is computed by usual methods (finite extremum-problem). The limiting function $\lim_{n \rightarrow \infty} w_n$ gives—again Bieberbach is cited—the required mapping. The method is so simple and elegant that it is hard to grasp why it fails to reprove the RMT (which Bergman and others calls the *Hauptsatz der Theorie der*

konformen Abbildung (*loc. cit.* p.240)). The reason is however a quite simple vicious circle, namely that the above (Bieberbach) “areal” characterization of the Riemann function logically depends upon RMT. Hence the minimum function (of Bergman) is eminently computable, but the resulting power series may not have a priori the required geometrical property of univalence and the right disc-range. (I guessed this follows from Bieberbach 1914 [92], hence the real problem is univalence. However on [13.06.12], after reading Bergman 1947 [82, p. 32], the opposite looks true: namely univalence is easy but the disc-range issue is not. There are mentioned two contributions, one by Bergman 1932 and also Schiffer 1938 [744] where the desideratum (of reproving RMT) is established for starlike domains. So almost as importantly, this source (of 1947) points out that Bergman’s dream of 1922 (new proof of RMT via the area extremum problem) was not borne out until 1947, and therefore seems really to be credited to the newer generation like Garabedian and Lehto.

Generally speaking, extremum problems are often solvable (even uniquely solvable), but it is another piece of careful analysis to control precisely the geometric behavior of solutions, e.g. in the hope to re-crack RMT. Of course, the problem was ultimately solved, cf. e.g., Garabedian 1950 [277] or the already mentioned thesis of Lehto, which are the first completed Bergman-style approaches to RMT.

Now, the point for re-exposing the hearth of the method is to emphasize the role of polynomials generated by z^n as a preferred system of global functions on the domain B out of which an ideal object is processed through an extremum procedure handled *in finito*. How can one adapt this on a Riemann surface where no such global parameters are supplied a priori? This is a little puzzle to the writer [06.06.12], but specialists (Bergman, Garabedian, Bell, etc.) often claim that the method adapts to this broader context with minor changes. Compare, e.g., the following sources:

- Bergman 1950 [84, p.24, Remark] justifies in this book extensibility to Riemann surfaces by referring to results of Sario 1949–50.

- Garabedian 1950 [277, p.361], where one reads “*For the sake of a simple presentation of results we have merely stated the theorem for the case of schlicht domains of finite connectivity. However the theorem is true with only one change if D is a Riemann surface [. . .]. The reader will easily verify that the proof which we shall give of the theorem carries over with minor changes to the more general situation.*” If not pure bluff, it is sad that Garabedian did not write down the details at that time. If we believe in the unity of mathematics especially the algebro-geometric and analytic Riemann surfaces at the compact level, then the existence question of circle maps is drastically more trivial in the “schlicht” and even “schlichtartig” case, compare e.g., the argument in Gabard 2006 [255], which in substance is the one of Bieberbach 1925, Wirtinger 1942 [891], but perhaps slightly streamlined by the mere usage of algebro-geometric language.

8.2 Minimizing the integral vs. maximizing the derivative (suction vs. injection), i.e. Bieberbach 1914-Bergman 1921/22 vs. Fejér-Riesz 1922, etc.

Trying to avoid the vicissitudes of life concomitant with the Dirichlet principle, the early 1920’s imagined two methods of attack to the RMT via extremum problems. Given $B \ni a$ a simply connected domain in the complex plane \mathbb{C} , which is not the plane and therefore can easily be assumed to be bounded via a suitable transformation, RMT amounts to find a conformal map to the disc. The following (animalistic) acronyms are derived by contracting the contributors’ names:

- (BIBER)=(Bieberbach 1914 [92] and Bergman[n] 1922 [75]). [Biber=German for “beaver” (=“castor” in French).]

★ *Amongst analytic functions $f: B \rightarrow \mathbb{C}$ normalized by $f(a) = 0$ and $f'(a) = 1$ minimize the integral $\int \int_B |f'(z)|^2 d\omega$, where $d\omega$ is the surface element of the*

Euclidean metric.

- (FROG)=(Fejér-Riesz 1922, Carathéodory 1928 [144]↔Ostrowski 1929 [626], and Grunsky 1940 [317], Ahlfors 1947 [16] in the multiply-connected context)
- ★ *Amongst analytic functions $f: B \rightarrow \Delta$ (= unit disc) normalized by $f(a) = 0$ maximize the modulus $|f'(a)|$.*

As remembered in the previous section, the problem BIBER was not prompt in supplying an (autonomous) proof of RMT, but ultimately succeeded in the late 1940's (Garabedian's or Lehto's thesis). Further this succeeded perhaps only under the additional proviso that the domain has a smooth boundary (Jordan curve).

In contrast FROG met earlier success (cf. e.g., Ostrowski 1928/29 [626] and Carathéodory 1928 [144]) streamlining a previous work of Fejér-Riesz 1922.

For extensions to the multiply-connected setting, or even Riemann surfaces, we have the following contributions:

- FROG leads to the works of Grunsky 1940–42 [317, 318] (schlicht domains of finite connectivity) and Ahlfors 1950 [17] (non-planar compact bordered Riemann surfaces), where the derivative $f'(a)$ is computed w.r.t. any local chart. In fact Ahlfors rather consider a variant of the problem where given two points a, b the modulus of $f(b)$ has to be maximized among functions such that $f(a) = 0$.

- BIBER is somewhat harder to formulate on a Riemann surface F (taking the role of the domain B) as the magnitudes involved in the problem require something more than the Riemann surface structure. A Riemannian metric would make the problem meaningful, but which metric to choose? Of course there is the canonical conformal metric given by uniformization (say of the double of the membrane F). Of course we deviate slightly from a self-contained proof of RMT or Ahlfors (=AMT), but this is maybe not a dramatic concession.

Thus, even in its basic formulation, some ideas are required to set a perfect analogue of the problem BIBER for a (bordered) surface. If this can be done, it is likely (or desirable) that the extremal function (whose existence and uniqueness is derived by Hilbert's spaces arguments) is a circle map, i.e. effects a conformal representation over the disc. (This is a priori not the unit disc, but renormalize so.) In the simply-connected case, both extremals of BIBER and FROG (denoted β and α respectively) yield the one and the same object, namely the Riemann mapping $B \rightarrow \Delta$ (again after a harmless renormalization of β by a scaling factor, cf. Bergman 1950 [84, p. 24] for its exact value in terms of the Bergman kernel). Hence, it is plausible that the general extremals for the surface F also coincide (namely with the Ahlfors function). So this would be a sort of conformal identity, perhaps of some practical significance.

Of course, the primary interest would be to reobtain (via BIBER) a novel proof of Ahlfors 1950 [17]. (This game may be already implicit in several works, as those of Bergman and Garabedian itemized in the previous section, but no pedestrian redaction is available in our opinion.) Yet, the real novelty would be the resulting “binocular view” of the one and same object (i.e., the Ahlfors extremal) through two different angles, yielding a sharper perception of it. Perhaps, this gives sharper differential-geometric insights about the Ahlfors map of a membrane, and incidentally may have some implications toward Gromov's FAC(=filling area conjecture). It is the writer's naive conviction that this problem FAC should succumb just under the powerful methods of 2D-conformal geometry.

8.3 Bergman kernel on Riemann surfaces

[13.06.12] Consulting other sources (e.g. Weill 1962 [875]), it seems that the theory of the Bergman kernel can be developed over any Riemann surface. The idea is to use the Hilbert space structure on the space of analytic differentials. A complete exposition is e.g., Ahlfors-Sario 1960 [22, p. 302]. Whether or not this leads to another proof of Ahlfors circle maps is another question.

[15.06.12] Other references for the Bergman kernel on Riemann surfaces include Nagura 1951 [578], and Nehari 1950 [591] where the Ahlfors function is expressed in terms of the Bergman kernel.

[25.06.12] In fact the key observation is probably that the integral involved in the minimum problem BIBER (of the previous section) is conformally invariant. Thus it may be hoped that this problem leads to a completely *ab ovo* independent treatment of the Ahlfors mapping, treated from a Hilbert space [of “areally” (*aérolaire*) square-integrable holomorphic functions] viewpoint. This would be indeed just be the culmination of the original device of Bieberbach 1914 [92].

So having in mind the possibility of extending the BIBER minimum area problem of the previous section to compact bordered Riemann surfaces (which looks reasonable in view of the conformal invariance of this area functional) we would like to reprove the existence of a circle map (à la Ahlfors 1950 [17]).

Relevant literature on this problem (but from our naive viewpoint not completely satisfactory) include in chronological order:

- Bieberbach 1914 [92] (simply connected schlicht case)
- Bergman 1950 [84, p. 24], where the fact that the range of the minimizing function is a circle is considered as well-known (with reference to Bieberbach’s Lehrbuch (1945 edition) [98]). Later in Bergman’s book [84, p. 87] the circle map $B \rightarrow \Delta$ is recovered through the function $F(z, \zeta) = \frac{\tilde{K}(z, \zeta)}{L(z, \zeta)}$ defined on p. 86, but it is not clear if this function solve the Bieberbach “areal” minimum problem. (Perhaps the connection is easy to do.)
- Garabedian-Schiffer 1950 [279, p. 166–7] where the BIBER problem is again formulated (but somehow only with the purpose of showing the existence of the reproducing kernel function, in the optic of re-deriving the PSM (parallel-slit maps)). In particular one may wonder if it possible to show by a direct analysis if the minimum function is a circle map. Of course such circle maps are reobtained later in the paper (p. 182) however through a somewhat different procedure.
- Nehari’s book 1952 [594] where the BIBER minimum problem appears on p. 362 (case of multiply-connected domain only) and its relation to the Bergman kernel is made explicit in the subsequent pages (esp. p. 368-9). However I do not think that the issue about the circle mapping property of the minimum function of BIBER is handled. Later in the book (p. 378) the Ahlfors extremal function is treated, yet a priori there is no clear-cut identity between the Bieberbach and Ahlfors extremal function. (Of course incidentally this book borrow a lot of ideas from other writers without referring to them, thus it is an easy task to observe overlap with the previous literature, especially with the two just cited previous entries (i.e. Bergman 1950 and Garabedian-Schiffer 1950).

8.4 β and α problems

[27.06.12] As we already discussed, in Section 7.8, there are essentially two problems BIBER and FROG amounting respectively to minimize an integral and to maximize a derivative. We may rebaptize them respectively the β -problem (for Bieberbach-Bergman) and the α -problem for Ahlfors (albeit this should truly be Fejér-Riesz 1922, for historical sharpness).

For simplicity we restrict to the case of domain (albeit the ultimate dream is to concoct didactic expositions even for Riemann surfaces).

Regarding the β -problem (of minimizing the areal integral) it has a direct Hilbert space interpretation (recall the affiliation (Dirichlet)-Hilbert-(Schmidt)-Ritz-Bieberbach-Bergman) of finding the vector of minimal length upon the hyperplane defined by the prescription $f'(t) = 0$ (where t is the fixed point previously denoted a). Such a minimization traduces into an orthogonality to this hyperplane, translating into the so-called *reproducing property* and permitting to identify the β -extremal with the Bergman kernel (function). For a detailed execution, cf. e.g. Garabedian-Schiffer 1950 [279, p. 166–7] (henceforth abridged GS50).

Likewise the α -problem received ultimately a similar treatment through Garabedian's thesis 1949 [276] (redone in the just cited Garabedian-Schiffer article), but the treatment is somewhat more involved appealing to the Szegő kernel instead, characterized via an orthogonalization taking place along the boundary of the domain. Hence in substance the idea of length rather than area. It follows in particular an explicit formula for the derivative of the Ahlfors function $|f'(t)| = 2\pi k(t, t)$ in term of the Szegő kernel. (Garabedian's work is such a tour de force that it was represented in virtually all major texts of that period, e.g. Bergman 1950 [84] and Nehari 1952 [591], plus also the paper GS50.)

Can we understand better the connection between both extremal problems. Our naive question is whether the β -map is a circle map. Remember that Bieberbach 1914 [92] has an argument in the case where the domain is simply-connected (via his first Flächensatz saying that a map from the disc with normalized derivative expands the area of the disc unless it is the identity). Combining this with the Riemann mapping, Bieberbach argues that the β -map must be disc-ranged, for otherwise we could deflate the area by post-composing with the Riemann map, hence violating the minimum property.

Alas, it seems that this argument is hard (impossible?) to extend to the multiply-connected case. Thus it is puzzling to wonder if the β -map is a circle map.

If it is the case, then we could inject the β -solution into the Ahlfors problem and compare them. In view of the explicit formula of Garabedian we can even try a direct comparison of the respective derivatives at t and hope to find an equality in which case by uniqueness we would have $\beta = \alpha$ (modulo scaling), i.e. a perfect coincidence between Bieberbach and Ahlfors function.

Of course, ideally everything could be done geometrically from the extremal problem, without entering into the hard analysis. Recall that each problem has its allied reproducing kernel, who serves to express its solution. In particular we may hope to derive the circle mapping property of the β -function from the property of its allied (Bergman) kernel (cf. GS50, p.167). And if not, we may hope to connect the β to the α -map through a somewhat accidental identity between their allied kernels functions. As far as the writer knows this is not explicitly made, and perhaps wrong.

Finally, let us emphasize a naive duality between α and β . The first amount to a pressurization (inflation) with a limited container, whereas β is a minimum (deflation) within a free vacuum leading ineluctably to a big-crunch to a point (constant map) if there would not be the initial explosion sustained by the derivative normalization. Hence it is of course not surprising that the Ahlfors map is a circle-map but the similar issue for the Bieberbach least area map would be something like an isoperimetric miracle.

Finally, we learned from Gaier's 1978 survey [260, p.34–35, §C] the following piece of information. Gaier's article contains a proof of a striking fact due to Grötzsch 1931 [see also Gaier 1977 [259], where the precise ref. is identified as Grötzsch 1931 [313]] that a map (non-unique!) minimizing the area integral $\int \int |f'(z)|^2 d\omega$ (à la Bieberbach 1914 [92]–Bergman[n] 1922 [75], but extended to the multiply-connected setting) under the schlichtness proviso (and the normalization $f(a) = 0, f'(a) = 1$) maps the domain upon a *circular slit disc* (with concentric circular slits centered at the origin). According to Gaier, Grötzsch's paper contains no details outside the indication of using his *Flächenstreifenmethode* (striptease method). Gaier's proof is based upon a Carleman isoperimetric property of rings relating the modulus to the area enclosed by the inner contour, plus Bieberbach 1914 [92] (first area theorem) to the effect that a schlicht normalized map from the disc inflates the area, unless it is the identity. A natural (naive?) question of the writer [13.07.12] is what happens if we relax schlichtness of the map? Do we recover an Ahlfors circle map??

As a historical curiosity, Gaier 1977 [259] remarks that the above least area problem for schlicht functions was reposed as a research problem as late as 1976 in the Durham meeting by Aharonov (compare for the exact ref. the Math. Re-

view by Burbea of Gaier 1977 [259]). It is apparently Kühnau (Grötzsch's eminent student) who pointed out that the problem was first handled by Grötzsch in the ref. just cited (Grötzsch 1931 [313]). It should be remembered that several treatments existed in print (prior to Ahlfors's question), e.g. the one in Sario-Oikawa's book of 1969 [739] (see pages as in MR of Gaier 1977 [259]), which is inspired from Reich-Warschawski 1960 [677]. All these treatments are quite involved, and Gaier 1977 [259] claims to simplify them.

A paper related to Gaier's and to this circle of ideas (i.e. Bieberbach's area minimization) (yet, alas not exactly furnishing our naive desideratum) is Alenicyn 1981/82 [32]: this gives the exact reference to the relevant work of Carleman 1918 [150] as well as to that of Vo Dang Thao 1976 [856] (the latter being however slightly criticized for mistakenly assuming the schlichtness of some function).

Philosophically such Bieberbach-type area minimization problem amounts to a deflation as opposed to the inflation of 'Ahlfors'-type problem maximizing the derivative. According to popular wisdom, both viewpoints could coincide since a semi-empty bottle is the same as as a half-filled one. (This reminds the story of Ahlfors' whiskey bottle used as a defense-weapon against an aggressor.)

[17.07.12] We may also switch completely the extremal problem by looking at an Ahlfors (for short α -type) extremal (inflationist) problem of maximizing the derivative among schlicht functions. Given D a multiply-connected domain and a marked point $a \in D$ (interior) find among all schlicht functions $f: D \rightarrow \mathbb{C}$ bounded-by-one $|f| \leq 1$ the one maximizing the modulus of the derivative $f'(a)$. It is reasonable to guess that "the" (unique?) extremal map will take D upon the full circle with circular slits (schlichtness being only fulfilled on the interior). It seems that this behavior is the one described in Meschkowski 1953 [552] (basing his analysis upon a distortion result of Rengel 1932 [681]), and see also the treatment by Reich-Warschawski 1960 [677]. Added 27.07.12: Compare also Nehari 1953 [595, p.264–5], where another treatment of this problem is given, and credits is given to Grötzsch 1928 [311] and Grunsky 1932 [314].

[**Optional digression:** Asking schlichtness up to the boundary, we get maybe the Kreisnormierung of Koebe? This would be interesting since as pointed out in one of Meschkowski's paper cited in the bibliography (locate where exactly!?, but anecdotic because cf. also Schiffer-Hawley 1962 [756], Hejhal 1974 [368], etc.) there was in the 1950's no clear-cut extremal problem leading to the Kreisnormierung (even in the realm of finite connectivity). Maybe the situation changed slightly after several works of Schiffer (and collaborators) where some Fredholm eigenvalues came into the dance (compare several refs. cited below in the period 1959–1963).]

At this stage combining the analysis of Gaier 1978 [260] for the β -problem and that of Meschkowski/Reich-Warschawski for the α -problem (refs. as in the penultimate paragraph) we contemplate a perfect duality between the behavior of the extremal *schlicht* functions (at least qualitatively since both mappings carry the domain upon the same canonical region of a circular slit disc). Maybe one can even identify both functions (after harmless scaling). Those works raise some hope that the schlicht-relaxed β -problem (area minimization à la Bieberbach) produces again the Ahlfors map (or at least enjoy the same property of being a circle map). As far as the writer knows [20.07.12], there is no such published account corroborating this intuition. This would be highly desirable to complete the symmetry of the picture below (Fig. 12) summarizing our desideratum.

[22.07.12] On reading Alenicyn [31, p.202] [32], where one is referred for the least area problem back to Nehari's book of 1952 [594], especially pp.340 (one can safely add p.341) and p.362]. There, pp.340–341 are perhaps not so relevant as it is merely a set of exercises. What is truly relevant is page 362, where the least area problem is posed and partially analyzed. In fact, this least area problem is handled earlier (with somewhat sharper information) in Garabedian-Schiffer 1949 [275, p.201] where the solution is represented as $M(z, a) M'(a, a)^{-1} =: M^*(z, a)$, where $M(z, a) = [A(z, a) - B(z, a)]/2$ is a

combination of A, B the two canonical parallel slit maps of the domain B upon horizontal (resp. vertical) slit domains taking a to ∞ as a simple pole with residue $+1$ (compare *loc. cit.* p. 200).

[26.07.12] In fact this solution is already announced in Grunsky's thesis 1932 [314, p.140]! As to the geometry of this map M^* , Garabedian-Schiffer (*loc. cit.* p.201) add the fact that it is at most n -valent (n being the number of contours of the domain, equivalently, its connectivity). (This information is not to be found in Nehari 1952 [594].) Alas, Garabedian-Schiffer (1949 *loc. cit.*) never seem to assert that the least-area map $M^*(z, a)$ is a circle map. On p.217, they show that any unitary function E (=unit-circle map) may be expressed as a linear combination of the least-area maps $M(z, n_\nu)$ centered at the N zeros n_ν ('Nullstellen') of E (assumed to be simple), compare Eq. (131) and (131'). Finally, on p.219 it is observed that the area of any such E , mapping the domain D upon the unit-circle covered N times, is exactly $N \cdot \pi$ (since area as to be counted with multiplicities). Of course, if our conjecture about the circle-mapping nature of least-area maps (there is one for each center a) is correct, then we could sharpen Garabedian-Schiffer's assertion about the "at most n -valency" into an exact n -valency of those maps.

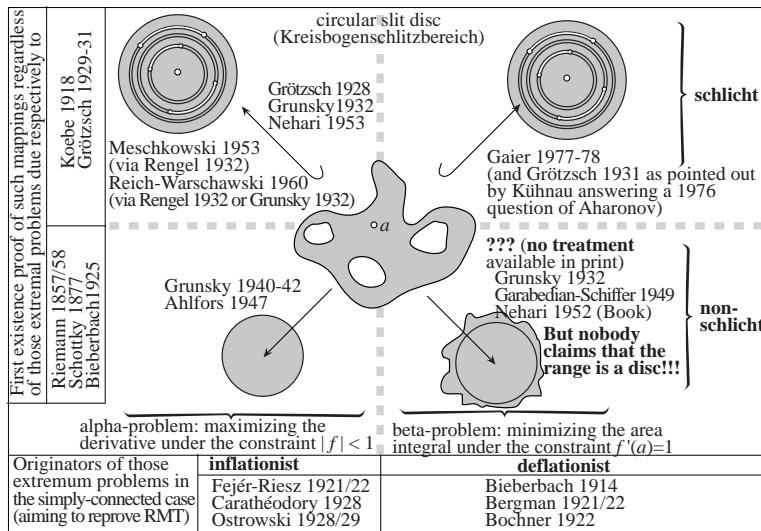

Figure 12: Two prominent types of extremal problems: on the left maximizing the derivative $|f'(a)|$ (inflationist) and on the right minimizing the integral $\iint_D |f'(z)|^2 d\omega$ (deflationist). On the top-part schlichtness of the mapping is imposed, whereas on the bottom part no-schlichtness is imposed allowing all analytic functions in the competition. It is tempting to conjecture [extrapolating the symmetry of the top-part] (and perhaps already known) that the minimum β -function is a circle map. (Works cited to be found in the bibliography)

[27.07.12] It could be the case, that our conjecture about the circle mapping nature of the least area map is settled in Lehto's thesis 1949 [500] (see especially p. 41).

[29.07.12] However on consulting M. Maschler 1959 [532] (esp. p.173) it seems to be asserted that the range of the least area maps are unknown for domains of connectivity higher than 2.

[26.07.12] To our grand surprise(?), we notice that the least area problem is handled in full generality (i.e., for compact bordered Riemann surface) in Schiffer-Spencer 1954 [753, p.135]. However again (as in Garabedian-Schiffer 1949 [275]) it is not shown that the resulting extremal function is a circle map.

At this stage we see that there is a wide variety of extremal problems, and as a rough rule we may split the most common of them into the α and β -type (for Ahlfors and Bieberbach resp.) Each problem is hard to analyze precisely but there is a large body of wisdoms accumulated about them by the masters (Koebe, Carathéodory, Bieberbach, Grötzsch, Grunsky, Ahlfors, Schiffer,

Garabedian, Golusin, etc.) Optionally by a nebulous bottle principle there may be a certain duality (even possibly an identity) between α - and β -solutions. At least so is the case in the simplest simply-connected setting according to Bieberbach 1914 [92], and apparently in the multi-connected setting we have at least coincidence of the range when considering the restricted schlicht problems. We may also speculate that a careful analysis of a suitable extremal problem may lead to a solution of the Gromov filling area conjecture.

Finally we mention that a related extremal problem is treated in Schiffer 1938 [745], namely that of minimizing the maximum modulus in the family of schlicht functions $f: B \rightarrow \mathbb{C}$ normalized by $f(a) = 0$ and $f'(a) = 1$. The (or rather any) extremal is shown to map (conformally) the Bereich B upon a circular slit disc.

8.5 Least area problem vs. least momentum

[03.08.12] The menagerie of extremal problems leading to the Riemann mapping can still be further enlarged. Each extremal problem exploits the ordered structure of the real line on using a certain real-valued functional. One may incidentally get some feeling of regression about this massive usage of real numbers in complex geometry problems, but this is common and respectable since Dirichlet's principle. Regarding the problem of circle maps *per se* it is not perfectly clear what is the *ideally suited* extremal problem (if any beside that of maximizing the derivative)? What is somehow missing is an extremal principle selecting the best extremal problem! The competitive nature of such extremal problems fascinated generations but requires strong classification aptitudes in view of the difficulty of each problem and the diversity of them.

First the *least area problem* consists in minimizing the area of the range of an analytic function counted by multiplicity. This is measured by the functional $A[f] = \int \int |f'|^2 d\omega$ (which seems much allied to the Dirichlet integral). (To extend the problem to Riemann surfaces one just needs to take notice of the conformal invariance of this integral upon conformal change of metrics.) To avoid the minimizers collapsing to the (uninteresting) constant functions, one imposes the side condition $f'(t) = 1$ at some inner point t of the domain B . The least area map (which exists uniquely by Hilbert space theory) effects when B is simply-connected nothing but than the Riemann mapping (due to Bieberbach 1914 [92]). This viewpoint was widely pursued especially by Bergman, yielding in particular the concept of Minimalbereich. See for instance Bergman 1922 [75], Bergman 1929 [77] where the concept seems to emerge, yet no precise definition. As noted in Maschler's papers e.g. 1959 [532] it seems that the nature of those minimal-domains was not completely elucidated in the late 1950's. However, Maschler—extending a result of Schiffer 1938 [744]—observes that such minimal domains satisfy the mean property. Therefore on applying the result of Davis (as quoted in Aharonov-Shapiro [11]) characterizing the circle as the unique domain with a one-point quadrature identity (i.e. such that the mean value property holds for all harmonic functions) one may hope to infer our desideratum that the least area map has a range which is a disc.

Another problem is that of the “least momentum” where one minimizes instead the integral $\int \int_B |f(z)|^2 d\omega$ (notice the suppression of the derivative) and again to avoid the trivial solution $f = 0$ we impose $f'(t) = 1$ at some point $t \in B$ of the domain. Another possible normalization is to ask $f(t) = 1$, like in Fuchs 1945 [252]. Here again it seems reasonable to expect circularity of the range of the minimum mapping. The intuition being that the inertia-momentum of a rotating body gets minimized for a circular body (granting some atomical resistance avoiding a complete gravitational collapse of matter).

[07.08.12] Of course all those problems are super-classical, yet we still find it hard to delineate the relevant clear-cut result among the super-massive literature. Our naive intuition would be that such least-area (or momentum) map are closely allied to circle maps. However it is not sure that this is the pure truth for non-simply connected domains (and a fortiori for bordered surfaces). As we

already said the relevant sources includes for the area problem:

- Grunsky 1932 [314, p. 140], alas no details, some more details in Garabedian-Schiffer 1949 [275] (but no assertion of circularity) only the Grunsky formula for the expression of the least-area map as combination of the two slit-maps.
- for the least momentum see many works of Bergman starting from his thesis 1922 [75].

Perhaps it should be observed that the least momentum problem is perhaps somewhat less easily extensible to Riemann surfaces in view of the lack of conformal invariance of its functional.

Finally, we can mention Walsh's 1935 survey (Mémorial [865]) where all such problems are united under a generalized form where more points z_1, \dots, z_n are prescribed in the domain joint with some prescribed values $\gamma_1, \dots, \gamma_n$ and one is required to find the map minimizing the functional under the interpolating condition $f(z_i) = \gamma_i$. Alas, in Walsh's survey attention is confined to the simply connected case and the multi-connected variants where at that time not systematically understood.

8.6 A digression about Nehari's paper of 1955

In Nehari 1955 [596], the author presents a nice application of Bieberbach's 1925 [97] existence theorem of a circle map for an n -ply connected domain upon the disc of degree n . Precisely Nehari deduces a bound on the number of linearly independent solutions to a certain extremal problem (akin to those treated by Szegő 1921 [818]). It seems plausible that this Nehari argument is sufficiently universal to extend directly to the more general setting of compact bordered Riemann surfaces (membranes for short) upon invoking Ahlfors 1950 [17] instead of Bieberbach 1925 [97]. As the argument uses only the circle mapping nature of the Ahlfors map, we may even appeal to Gabard 2006 [255] to obtain a sharper bound. In reality what is truly relevant is the absolute invariant of the (separating) gonality à la Coppens 2011 [183]. Let us try to explore this connection, albeit some details require to be better worked out in order to really understand this technique of Nehari.

We try first to go quickly to the hearth of Nehari's ideas. The starting point is the following extremal problem formulated for D a compact domain bounded by n analytic curves (for simplicity) forming its complete boundary contour C . Further in the interior of D a set C_1 consisting of a finite number of rectifiable Jordan arc and/or curves is given. [Warning: in his paper [596, p. 29] Nehari writes " C_1 will stand for a subset of C ", which in our opinion is just a misprint! C should be D ! Of course, our domain D differs from Nehari's as ours includes the contours.] Let also $L^2 = L^2(D)$ be the (Hilbert) space of analytic functions on D with finite integral $\int_C |f(z)|^2 ds < \infty$ where ds is the (Euclidean) length element.

Problem (P). Find the functions $f \in L^2$ minimizing the norm $\int_C |f(z)|^2 ds$ under the constraint $\int_{C_1} |f(z)|^2 ds = 1$.

This problem suggests looking at the functional

$$J(f) = \frac{\int_C |f(z)|^2 ds}{\int_{C_1} |f(z)|^2 ds}$$

whose minimizers are (up to scaling) the solution of problem (P).

Next Nehari sets up a certain integral equation whose eigenspace attached to the lowest eigenvalue parametrize the extremals of (P). We skip the details, but the key issue is just the linearity of the set of solutions to Problem (P). With this at hand, we may plunge directly to the core of Nehari's argument, namely the:

Proposition 8.4 (Nehari 1955 [596, p. 36]) *Assuming (as above) the domain D of connectivity n (=number of contours), problem (P) admits at most n linearly independent solutions.*

Proof. Nehari’s argument splits in 4 short steps:

Step 1 (Bieberbach 1925) According to the latter ([97]) there is a circle map $f: D \rightarrow \bar{\Delta} = \{|z| \leq 1\}$ of degree n . This means that $|f(z)| = 1$ exactly on the contours (i.e. $f^{-1}(\partial\bar{\Delta} = S^1) = C$) and upon changing the origin to an unramified place we may assume that f has exactly n zeroes, say z_1, \dots, z_n .

Step 2 (Nehari’s trick in linear algebra) Assume by contradiction that (P) has $n + 1$ linearly independent solutions f_i ($i = 1, \dots, n + 1$). We consider the linear map

$$\mathbb{C}^{n+1} \rightarrow L^2 \rightarrow \mathbb{C}^n,$$

where the first arrow maps $(A_1, \dots, A_{n+1}) \mapsto \sum_{i=1}^{n+1} A_i f_i$ and the second is the evaluation $\varphi \mapsto (\varphi(z_1), \dots, \varphi(z_n))$ at the zeroes of the (Bieberbach) function f . For dimensionality reasons, there is a non-zero vector (A_i) in the kernel which creates the function $f_0 := \sum_{i=1}^{n+1} A_i f_i$ vanishing at all z_i , yet without being identically 0 (the f_i being linearly independent).

Step 3 (Nehari factorizes) The function g defined by $g \cdot f = f_0$ is regular in D (since writing $g = f_0/f$ we see that the zeroes of f are cancelled out by those of f_0 which by construction englobe those of f). Now using the property of the circle map f we find the following strict inequality

$$J(f_0) = \frac{\int_C |f_0(z)|^2 ds}{\int_{C_1} |f_0(z)|^2 ds} = \frac{\int_C |g(z)|^2 \overbrace{|f(z)|^2}^{=1} ds}{\int_{C_1} |g(z)|^2 \underbrace{|f(z)|^2}_{<1} ds} > \frac{\int_C |g(z)|^2 ds}{\int_{C_1} |g(z)|^2 ds} = J(g).$$

(Moreover reading backwards the numerators we see that the norm of g equals that of f_0 so that $g \in L^2$.) The just obtained inequation $J(g) < J(f_0)$ shows that f_0 fails to solve (P).

Step 4 (Using the linear structure) However the f_i ($i = 1, \dots, n + 1$) solve (P), hence by virtue of the linear structure of the extremals to (P) [which Nehari derives from an interpretation as the eigenspace attached to the lowest eigenvalue, but which perhaps may be derived more directly] it follows that f_0 solves also (P) [after scaling appropriately], violating the conclusion of Step 3. ■

Albeit our presentation is not completely polished (and Nehari’s maybe not perfectly organized for the beginner), we see that the basic trick looks sufficiently universal, as to extend to the following context.

Instead of the finitely-connected domain D , we consider F a compact bordered orientable Riemannian surface of genus p and with r contours. Now ds denotes the induced length element attached to the (Riemannian) metric. As above, we specify a subset C_1 of the interior of F consisting of a finite “drawing” of Jordan arcs and curves (perhaps they do not even need to be pairwise disjoint). Then we set up the extremal problem (P) in this context, and the above proof seems to work mutatis mutandis, except for trading Bieberbach 1925 [97] by Ahlfors 1950 [17] or Gabard 2006 [255]. Precisely, we may consider a circle map $f: F \rightarrow \bar{\Delta}$ of least possible degree, say γ . By Gabard 2006 [255] we know that $\gamma \leq r + p$. So we arrive at the following statement:

Proposition 8.5 *Let F be a membrane of genus p with r contours. Assume that F has the gonality γ , i.e. the least degree of a circle map to the disc. (We know $\gamma \leq r + p$) Then the extremal problem (P) admits at most γ linearly independent solutions. (And γ admits the upper-bound $r + p$).*

9 Ahlfors’ extremal problem

9.1 Ahlfors extremal problem (Grunsky 1940–42, Ahlfors 1947–50)

Ahlfors’ method involves solving the following extremal problem:

Theorem 9.1 (Ahlfors 1950 [17]) *Given any compact bordered Riemann surface (membrane for short) and two interior points a, b , find among all (analytic) functions bounded-by-one taking a to 0 the one maximizing the modulus $|f(b)|$.*

Such a function exists (normal families argument à la Vitali-Montel) and is unique up to a rotation (=multiplication by an unimodular complex number $\omega = e^{i\theta}$). Hence it is unambiguously defined by the points a, b if $f(b)$ is required to be real, and we denote $f_{a,b}$ the corresponding function.

Furthermore Ahlfors' extremal function $f_{a,b}$ concretizes the given surface as a full-covering of the disc Δ , of degree

$$r \leq \deg f_{a,b} \leq r + 2p, \quad (1)$$

where r is the number of contours and p the genus (of the given membrane).

It is nowadays quite customary—following (another) Russian school (Golusin, S. Ya. Havinson, etc.)—to call the extremal an *Ahlfors function*, albeit even Ahlfors seems to have been rather embarrassed by this probably unearned distinction (cf. his comments in Collected Papers [25, p. 438]). The same idea occurred somewhat earlier in works of Grunsky 1940–42 [317], [318], yet the latter confined attention to plane domains (as did Ahlfors 1947 [16]). Being close colleagues—as materialized by their joint note (Ahlfors-Grunsky 1937 [15]) about the best conjectural value for the *Bloch constant* (still open up to present days)—it is puzzling that both were not very aware of overlapping study (admittedly imputable to the difficult World War II context).

9.2 Semi-fictional reconstruction of Ahlfors' background (Fejér-Riesz 1922, Carathéodory 1928, Ostrowski 1929)

Where does Ahlfors' extremal problem comes from? This is surely a non-trivial question yet let us attempt to give some elements of answers. The narrative is made more plausible by looking a bit around while trying to keep track of the historical continuity. We shall thus use several indirect sources, especially Remmert.

As already mentioned in the introduction, the Dirichlet principle suffered ill-foundation during a long period of about 40 years (1860-1900). This was beneficial to Schwarz-Christoffel who developed some constructive methods for the RMT for polygons. Another trend involves directly rescuing the Dirichlet principle via the “alternierendes Verfahren” of Schwarz and the parallel work of C. Neumann. This influenced Picard's *méthodes des approximations successives*, as well as Poincaré's balayage.

Then came Hilbert's breakthrough. Yet, alternative methods circumventing the intricacies of potential theory seemed worth attention. As reported in Remmert 1991 [679], one can ascribe to Fejér-Riesz ca. 1921 (published by Radó 1923 [668]) the first purely complex variables (potential theoretic free) proof of the RMT by using the extremal problem of making the modulus of the derivative as large as it can be. Several technical simplifications were then obtained by Carathéodory 1928 [144] and Ostrowski 1929 [626] (independently). This leads in principle to the most elementary proof of the RMT. Extending this idea to multiply-connected domains (say first of finite connectivity) leads directly to the extremal problem considered by Grunsky 1940–42 [317], [318], and Ahlfors 1947 [16], and Ahlfors 1950 [17] when extended to Riemann surfaces.

In fact prior to Fejér-Riesz, it is fair to refer to Koebe's (and Carathéodory's) elementary proofs of the RMT, also via an extremal problem or at least iterative methods (compare e.g. Garabedian-Schiffer 1950 [279]).

As a matter of digression, it can be recalled that this extremal viewpoint leads as well to a proof of the uniformization theorem (without potential theory). Compare Carathéodory 1950 [149], plus several papers by Grunsky (easily located in his collected papers).

9.3 Extremal problems and pure function-theoretic proofs of the RMT (Koebe, Carathéodory, Bieberbach)

The previous section is a bit caricatural and the real history is marvellously detailed in Gray 1994 [300]. Let us summarize the chronology of this period, in the center of which there is probably one of the main inspiring force toward the Ahlfors extremal function (namely the *Schwarz lemma* as Carathéodory christened it in 1912).

- Painlevé 1891 [632]: boundary behavior of the Riemann mapping for a contour having an everywhere continuously varying tangent.
- Harnack 1887 [335] provides a satisfactory proof for solving a suitable version of Dirichlet's principle, and states what has become known as *Harnack's theorem* on monotone limits of harmonic functions.
- Osgood 1900 [621] applies Harnack's theorem to draw the existence of a Green's function for any simply-connected plane domain thereby resolving the Riemann mapping theorem (RMT). This dependence is eliminated in Koebe 1908 and Carathéodory 1912 (cf. items below), where Schwarz's lemma is substituted.
- Poincaré 1907 [653] (and independently Koebe 1907, cf. below) proves uniformization (rigorously). For this Poincaré combines his *méthode de balayage* (of 1890 [650]) and simplifies it using Harnack's theorem. From the Green's function he deduces the conformal map of a Riemann surface (à la Weierstrass) to the disc, and uses earlier works of Osgood.
- Koebe 1907 also proves uniformization (UNI). In Koebe 1907c [451] he compares his method to Poincaré's. Like Poincaré he had relied on Schwarz's method, but unlike him made a much more modest use of Harnack's theorem. Koebe also insists upon his avoiding of the use of modular functions.
- Koebe 1908 [452] supplies another proof (of UNI) avoiding completely Harnack's theorem. [Subsequently Koebe interacted widely with Fricke's attempt to modernize the original *continuity method* of Klein-Poincaré, and showed how this could be rigorized overlapping thereby with simultaneous work by Brouwer. This interaction with Brouwer seems to have ended quite contentiously.]
- Koebe 1909 [455], 1910 [458] proof of his *Verzerrungssatz* (distortion theorem). From it he derives, the first elementary proof of the (RMT) appealing to a long list series of name going back via Arzelà and Montel 1907 [567] to Ascoli 1883.
- Carathéodory 1912 [138, p.109] notes that *Schwarz's lemma* (which he was the first to call by this name, and which he locates in Schwarz's Ges. Abh., vol. 2, p.109) can act as a substitute to Harnack's theorem (upon which Osgood 1900 relied heavily). [Interrupting the present narrative this will have to play a major role in Ahlfors' extremal problem.] Using the Schwarz's lemma and Montel's theorem, Carathéodory obtains the Riemann mapping using an exhaustion of the domain G by subdomains (G_n) each mapped via f_n to the disc and studied under which condition on G_n the f_n converges to a function f giving the Riemann mapping (again without potential theory).
- Carathéodory 1913a [139] proves Osgood's conjecture, that the Riemann map extends to a homeomorphism of the boundary iff the boundary is a Jordan curve. In Carathéodory's opinion this achievement is mostly a byproduct of Lebesgue's far-reaching theory of integration (1902 [498]), and the consequences drawn from it by Fatou 1906 [231]. This reliance upon Lebesgue-Fatou was soon disputed by Koebe 1913 (cf. item below).
- Carathéodory 1913b [140] discusses the boundary behavior when the boundary curve is not a Jordan curve. This paper is oft regarded as inaugurating the concept of *prime ends* (although earlier origins are in the work of Osgood, and related ideas in Study-Blaschke 1912 [806]).
- Koebe 1913 [462] disputes the need for Lebesgue's theory in Carathéodory's treatment, showing how to generalize a theorem of Schwarz to the same effect. A similar result is claimed independently by Osgood-Taylor 1913 [623].
- Bieberbach 1913 [91] wrote a short paper disputing the (in his opinion) ex-

cessive Carathéodory's reliance on Schwarz's lemma, proposing to use only Montel's theorem. The next year Bieberbach 1914 [92] invokes another extremum principle (area minimization of the range of the mapping suitably normalized) to simplify Carathéodory's work. This freed the theory from any reliance upon Montel's theorem (but uses instead ideas of Ritz).

- Back to Koebe, in 1912 [460] could not resist after the stimulus aroused by Carathéodory's work to go back to some old idea of his own (*Quadratwurzeloperationen*) to create his *Schmiegunungsverfahren* (squeezing methods) for solving the Riemann mapping by the iterated taking of square roots. This presentation was entirely elementary.

- Carathéodory 1914 [141] incorporated all these criticisms in his paper for the Schwarz Festschrift, which was to remain his final account until the newer methods of Perron were introduced. [Here we may have also mentioned the argument of Fejér-Riesz 1921.]

- Bieberbach 1915 in his pocket book *Götschen* [93, p.95] also proposes to deal entirely within pure function theory, while rejecting the potential theoretic approach (despite Hilbert's work). This actually presents a version of Koebe's *Schmiegunungsverfahren* and concludes to the Riemann mapping theorem via Koebe's *Verzerrungssatz* (seen as a preferred alternative over Schwarz's lemma).

9.4 Interlude: Das Werk Paul Koebes

In this section we digress slightly from our main path to look closer at the monumental works of Koebe. It is useful to be guided by Bieberbach's overview of Koebe's work in 1968 [102]. The main point of overlap of Koebe with our main theme (Ahlfors) lies in the Riemann-Schottky mapping (albeit for Koebe the mapping to a *Kreisbereich* is given full attention neglecting thereby the circle mapping). Of course, the other main aspect of Koebe's life is the uniformization theorem of (Klein-Poincaré-Schwarz).

Again some chronology:

- Riemann 1857–58 [689] and Schottky 1877 [763] (maybe only in the 1875 Latin version?) proved that any n -ply connected domain maps conformally to a *Kreisbereich* (circular domain). [Bieberbach and indeed Koebe 1910 [456] ascribe this to Riemann, albeit we are not sure to be in total agreement with this assertion.]

- In Bieberbach's opinion the above Riemann-Schottky *Kreisbereich*-mapping is first rigorously proved by Koebe in a series of four papers written in 1906, 1907, 1910, 1920 (which we attempt to summarize in more details):

- (1) Koebe 1906 [447]: this starts with a rigidity result for two *Kreisbereiche* as being conformal to each other only through linear transformations. The proof uses potential theory (and the Cauchy integral). It follows that $(\varrho + 1)$ -ply-connected *Kreisbereiche* depend upon $3\varrho - 3$ essential constants when $\varrho \geq 2$, the same quantity as predicted by Schottky for general multiply-connected domains of the same connectivity. This yields some evidence for the possibility of mapping those to a *Kreisbereich*. Actually Koebe (p.150) reminds that the *Kreisbereich* mapping is (essentially) solved by Schottky and by Poincaré (referring loosely to the first volumes of *Acta*). [In the next paper Koebe adopts a more critical position, and does not take this as granted.] Next, he claims the result extends to *schlichtartig* surfaces. His argument amounts to fill the Riemann surface by discs, to get a closed surface of genus 0, and appeal to Schwarz 1870 [772] to map this to a sphere. Next, Koebe proposes to relax the *schlichtartig* character to formulate a similar result for positive genus. Again one fills the surface by discs to gain a closed surface of genus p . This can be mapped as a ramified cover of the sphere of degree $p + 1$ (as well-known since Riemann, but for Koebe being Schwarz's pupil Riemann is taboo and an ad hoc [somewhat sketchy] argument is supplied). At any rate the result is that any compact bordered Riemann surface of genus p is conformally embeddable in a closed Riemann surface of genus p , hence representable as a $(p + 1)$ -sheeted

cover of the sphere. [Note: although this result concerns like Ahlfors 1950 [17] compact bordered surfaces, it seems that this Koebe mapping lies not so deep as the image of the contours of the map are poorly controlled, in particular they do not coincide.]

(2) Koebe 1907 [449]: this starts by quoting again his rigidity result of the previous paper. Then more critically Koebe notices that the mapping of a planar $(\varrho+1)$ -ply connected domain upon a Kreisbereich of the same connectivity is not so easily established (making abstraction of the (simultaneously discovered) Klein-Poincaré *Kontinuitätsmethode* (or *méthode de continuité*), which was not yet reliable in 1907). [This came only later through the work of Brouwer and Koebe ca. 1911 [441], and Koebe 1912 [459]] The rigidity result affords an essentially unique solution of the mapping problem. Then Koebe proceeds to show that a Kreisbereich mapping exists for triply-connected domain ($\varrho = 2$), and generally if the domain is symmetric under complex conjugation provided the real axis cuts all contours. For the triply connected domains, he takes the Schottky double, which is conformally mapped to a closed Riemann surface of genus 2 (via massive quotation to Schwarz, Ges. Abh. II, S. 133–143, S. 144–171, S. 175–210). As any curve of genus 2 this is hyperelliptic (canonical mapping via holomorphic 1-form). As to the more general case, the problem involves cutting the domain along the real axis, yielding a simply-connected region. This is mapped conformally to the upper half-plane, and symmetrically reproduced. Then Green's function is constructed via Harnack's theorem (quotation to Harnack 1887 [335], Poincaré 1883 [649], Osgood 1900 [621] and Johansson 1905).

(3) Koebe 1910 [456]: the paper starts again with the objective to solve the *Problem der konformen Abbildung eines $(p+1)$ -fach zusammenhängenden Bereiches auf einen von $p+1$ Vollkreisen begrenzten Bereich* (which he proposes to call *Kreisbereich* for short). Koebe recalls that the problem was first addressed by Schottky 1877 in his *Doktordissertation*, and earlier in Riemann's Nachlass. He reminds from his first work [item (1)] that *je zwei Kreisbereiche aufeinander nur durch lineare Funktionen konform abgebildet werden können*. Then he repeats the two special cases he was able to solve previously, and now proposes to tackle the general case via two different methods (of his own): *Überlagerungsfläche* and *iterierendes Verfahren* [cf. items (A) and (B) below]. He proudly emphasizes that both methods have a larger applicability than to the present Kreisbereich problem, since their combination, allowed him to settle the whole series of classical mapping problems of Klein and Poincaré (1881–84) in their pioneer work on automorphic functions, and the allied uniformization. Hilbert's 22th Problem (1900) is mentioned for reposing the uniformization question especially in connection to Poincaré 1883's paper [649]. Schwarz is again (justly) regarded as the father of the method *der Überlagerungsfläche*, which plays a key role in the newer developments in the automorphic theory, as exemplified through the work of Poincaré 1907 [653] himself and Hilbert 1909 [377]. After these general remarks Koebe proceeds to prove the general Kreisbereich mapping. [As warned in Bieberbach's report, the present paper of Koebe does not contain full details, yet some lovely geometric ideas worth sketching. Complete details appear in the last contribution item (4), but then it is easy to get lost in the technicalities.]

(A) Koebe assumes the contours of the domain B to be analytic curves. Then via some abstract *Spiegelungsprozesses* (ascribed to Schwarz) he constructs via symmetric reproduction of B a schlichtartig Riemann surface $B^{(\infty)}$. (One must imagine B glued with replicas thought of as the back-side of the domain.) Then he can apply his *allgemeines Abbildungsprinzip* to the effect that schlichtartig implies schlicht (first established in Koebe 1908 [452], with subsequent approaches by Hilbert 1909 [377] and in Courant's thesis 1910/12 [185]). The new schlicht domain $B^{(\infty)}$ is tessellated by replicas of the conformal copy B' of B . Hence B' admits a complete infinite system of symmetric reproduction. This is enough (for Koebe) to characterize a Kreisbereich. (Here we may agree with Bieberbach's diagnostic that Koebe's exposition is sketchy, but details were supplied later in Koebe 1920 [467].)

(B) Then he exposes the promised *iterierendes Verfahren*. This is a beautiful idea based upon successive applications of the (RMT) to make circular a specific contour and then reflecting by a *Spiegelung* (inversion by reciprocal radius) the domain across this circularized contour. Koebe draws nice pictures (like below Fig. 13) suggesting the fact that this iteration scheme produces domains with *sukzessive Steigerung der Spiegelungsfähigkeit des Bereichs* whereupon it is made plausible that when repeated ad infinitum the resulting domain has an infinite aptitude of symmetric reproduction, hence must be a Kreisbereich. The convergence proof uses his *Verzerrungssatz*.

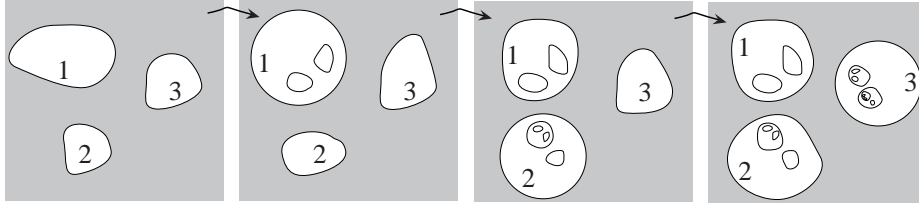

Figure 13: Koebe's *iterierendes Verfahren*: successive circularization of the contours of a multiply-connected domain via the Riemann mapping and a magical convergence to a Kreisbereich (first established by Koebe on the basis of his *Verzerrungssatz* in 1908 [452])

(4) Koebe 1920 [467], where full details are supplied.

- In parallel, Koebe concentrates his efforts on the uniformization problem starting with Koebe 1907 [449] devoted to the uniformization of real algebraic curves, yet the real technological breakthrough occurs in the next paper.

- Koebe 1907 [450] discovers a first version of his *Verzerrungssatz* (VZS), which turns out to be relevant both to the Riemann-Schottky Kreisbereich-mapping and to uniformization. As forerunners of the (VZS) Bieberbach mentions the works of Landau, Schottky related to Picard's theorem (1879 [641]). This Koebe's paper also contains (what later came to be known) as the *Viertelsatz* to the effect that the range of any schlicht function on the unit disc normalized by $f(0) = 0$ and $|f'(0)| = 1$ contains a disc of some universal positive radius ϱ . The sharp value $\varrho = 1/4$ is conjectured, but only established by Bieberbach 1915 [93]. Armed with this *Verzerrungssatz* (yet without the precise bound) Koebe manages to prove uniformization. This represents a generalization of the RMT to simply-connected Riemann surfaces. Bieberbach recalls that according to oral tradition the trick of the universal covering surface is due to H. A. Schwarz (ca. 11. April 1882, as carefully reported in Klein's Werke [443, p. 584]).

- Simultaneously and independently Poincaré 1907 [653] also proves the uniformization theorem via his *méthode de balayage*.

- Koebe 1907 [451] inspects Poincaré's proof and proposes a variant using Harnack's theorem (in potential theory) circumventing thereby the *Viertelsatz*, as well as Poincaré's *balayage*.

- The new ingredient (*Verzerrungssatz* of Koebe) turned out to act usefully in other uniformization problems envisioned by Klein (e.g., the *Rückkehrschnitttheorem*, etc.) In Koebe's formulation this resulted to the conformal mapping of a schlichtartig Riemann surface to a schlicht domain of the Riemann sphere. This result appears in Koebe 1908 [452]. Its proof uses beside the *Verzerrungssatz* a general convergence theorem (à la Montel-Vitali), which Koebe discovered independently [according to Bieberbach].

- Koebe 1909 [455] gives a sharper version of the *Verzerrungssatz* and applications to Klein's general uniformization problem (via groups of linear transformations).

- Hilbert 1909 [377], using a variant of the Dirichlet principle, gives another method for the schlicht mapping of a schlichtartig surface (to the sphere), via a so-called parallel-slit mapping [extending the Schottky-Cecioni result to infinite

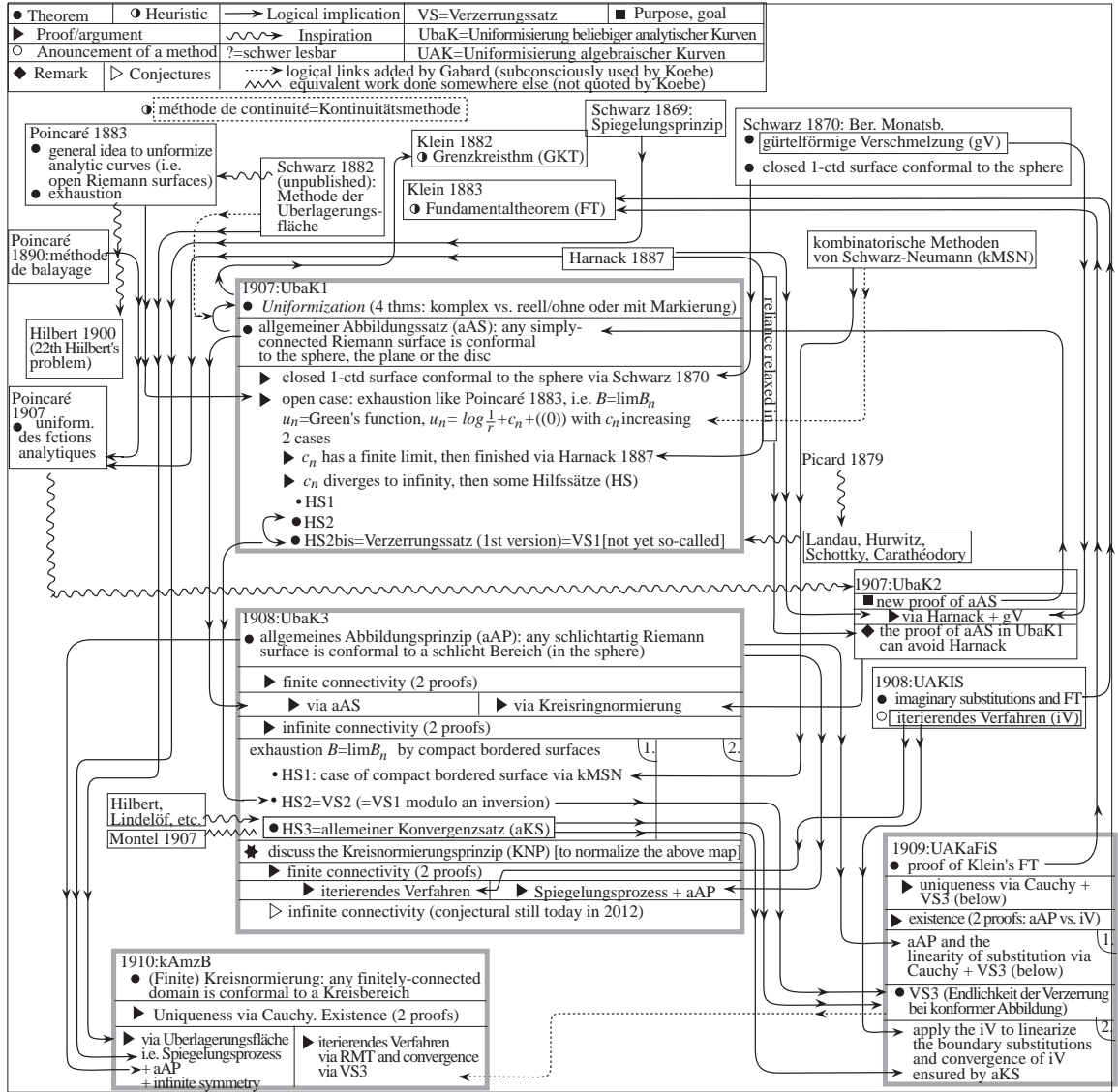

Figure 14: Logical dependance between Koebe's early theorems

connectivity].

- In response Koebe 1909 [454], 1910 [457] and independently Courant 1910/12 [185] proves anew the above Hilbert's Ansatz about parallel-slit mappings.

- Already Schottky 1877 [763] tried [in Bieberbach's opinion] to prove the [Riemannian] theorem that every n -ply connected planar domain conformal-maps bijectively to a parallel Schlitzbereich. Hilbert's new method proves this for arbitrary schlichtartig Riemann surfaces. Koebe in the aforementioned two works, sharpens Hilbert's theorem by noticing that the range of the mapping fill the full plane save a set of measure zero. At this occasion Koebe also formulates his *Kreisnormierungsprinzip* (still open today) [despite the spectacular progress by He-Schramm 1993 [353]]

- Bieberbach emphasizes that the *iterierendes Verfahren* may really have first emerged through the Kreisbereich mapping problem. [This conflicts slightly with Koebe's claim that he employed it earlier for uniformization.] At any rate Bieberbach writes "*Solche iterierenden Verfahren entwickelt Koebe über Jahrzehnte hin immer weiter, bis alle Uniformisierungsprobleme algebraischer Gebilde dem iterierenden Verfahren zugänglich werden.*"

- The proof of the (RMT) via repeated *Quadratwurzelabbildungen* itself constitutes an iterative method, which Koebe calls the *Schmiegunungsverfahren*.

Credit for this discovery shared with Carathéodory.

• A rigorous foundation to the *Kontinuitätsmethode* of Klein-Poincaré is paid by Koebe much attention in a torrential series of paper starting in 1912 [459], 1912 [461], 1914 [463], etc. Those works overlaps (and then may supplement) the works of Brouwer on the invariance of domain (and dimension), and its application to Riemann surfaces. The resulting priority question is very intricate. Even Klein in 1923 [443, p. 734] writes: *Die entscheidende Wendung trat aber erst 1911/12 durch das Einsetzen der Untersuchungen von Brouwer und Koebe ein. (Ich halte um so mehr an der alphabetischen Reihenfolge fest, als die gegenseitige Beziehung der beiden Forscher nicht ganz geklärt ist.)* Soon afterwards Klein also cites footnote 2) in Brouwer 1919 [120], where Brouwer seems to revendicate some priority over Koebe, while reporting some falsification of his own (Gött. Nachr.) article via a citation to Koebe added after proof-reading.

9.5 Koebe and its relation to Klein or Ahlfors

In the overall Koebe's monumental work is quite intricate with deep influences by methods of Schwarz (ca. 1870), results of Schottky (1875/77), visions of Klein and Poincaré (early 80's), supplemented by methods of his own. The following chart (Fig. 15) gives an Überblick maybe helping navigation through Koebe's works and the logical links between his results.

From our Ahlfors' biased viewpoint several points are worth noticing:

(1) Koebe frequently refers to Klein's orthosymmetry for real algebraic curves. In view of the close connection between orthosymmetry and the Ahlfors circle mapping, it is tempting to wonder if Koebe was ever close to discover the Ahlfors circle mapping. Of course Koebe's focus seems to have been more attracted by the uniformization problem (in particular for real algebraic curves), cf. Koebe 1907 [449]. However Klein's orthosymmetry appears in many subsequent papers (e.g., [466, p. 29, p. 35]), and would not bet that one day someone discovers in Koebe an anticipation of the Ahlfors map (as it occurred say with the circles packing of Andreev–Thurston). If not directly, it could be the case that the implication is indirect via the Rückkehrschnitttheorem of Klein (cf. Section 6.5).

(2) Koebe also notices (at several places) (e.g., 1907 UbaK1 [450, p. 199]) that the orthosymmetry concept for real algebraic curves extend to analytic real curves. One can then wonder if there is likewise a function theoretical characterization of orthosymmetry in terms of (totally real) mapping to the sphere. This would amount to say that any bordered surface is expressible as a total cover of the disc (taking boundary to boundary). Of course this might be a bit cavalier, but perhaps deserves to be analyzed more carefully.

9.6 Ahlfors' background (Bergman 1941, Schiffer 1946, Schottky differentials)

Let us quote the introduction of Ahlfors 1950 [17]:

Quote 9.2 (Ahlfors 1950) In the handling of the extremal problems we are in close contact with the methods of Bergman [1941]=[80] and Schiffer [1946]=[748], which they have developed for plane regions. A convenient tool for applying these methods to regions on Riemann surfaces is found in the class of Schottky differentials, and it was the recognition that Bergman's kernel-functions are in fact Schottky differentials that led us to undertake this study.

The second part of the paper (§§ 4–5) deals with an extremal problem that we have previously solved for plane regions. There are great simplification over my original proof for which I am partly indebted to my student P. Garabedian. An interesting point is that the extremal functions are again defined by means of Schottky differentials.

As a complement, we may reproduce a passage of Ahlfors' comments in his collected papers [25, p. 438]:

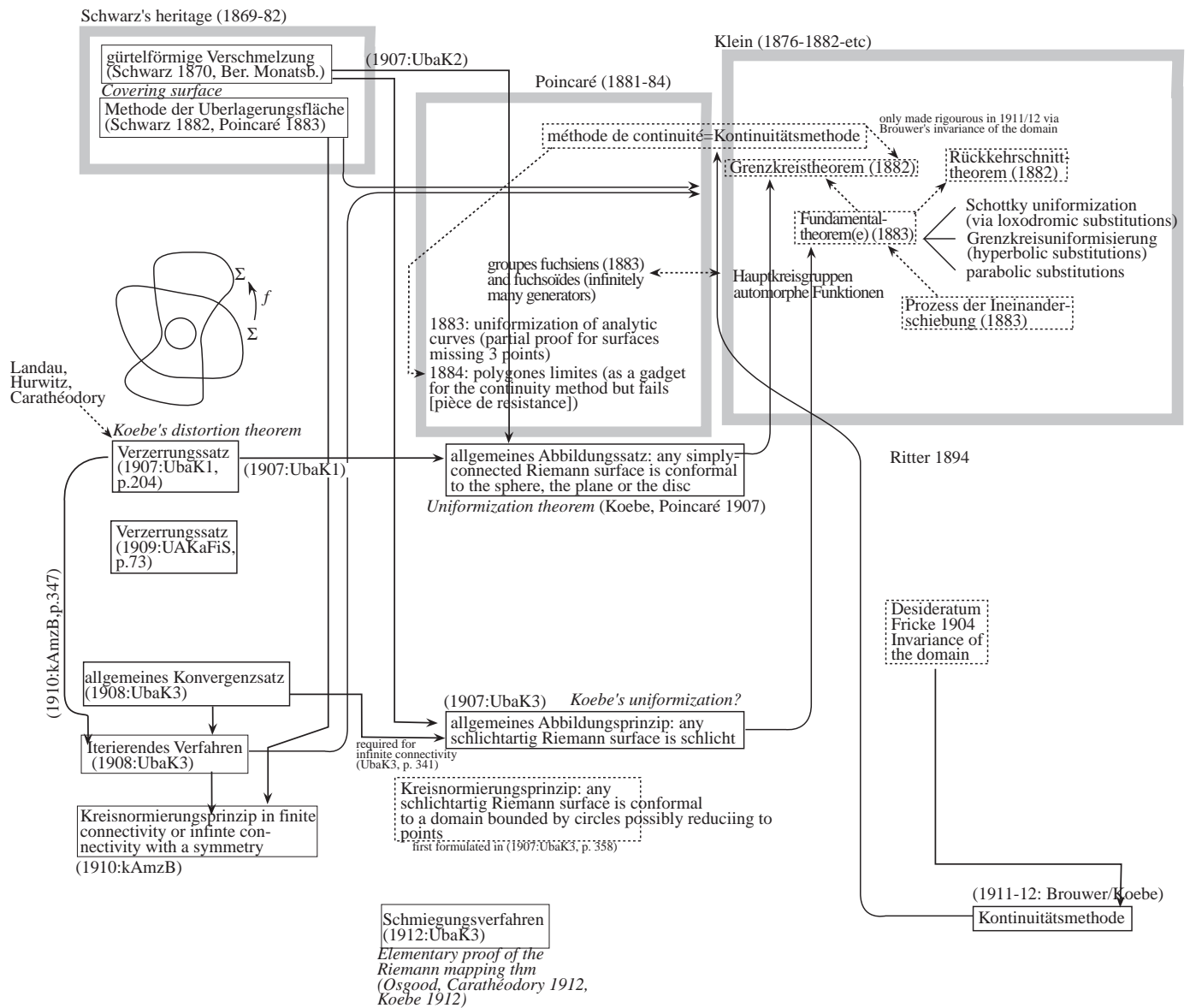

Figure 15: Logical dependance between Koebe's early theorems

Quote 9.3 (Ahlfors 1982) The purpose of [36](=Ahlfors 1950 [17]) was to study open Riemann surfaces by solving extremal problems on compact subregions and passing to the limit as the subregions expand. The paper emphasizes the use of harmonic and analytic differentials in the language of differential forms. It is closely related to [35](=Ahlfors-Beurling, 1950), but differs in two respects: (1) It deals with Riemann surfaces rather than plane regions and (2) the differentials play a greater role than the functions.

I regard [36] as one of my major papers. It was partly inspired by R. Nevanlinna, who together with P. J. Myrberg had initiated the classification theory of open Riemann surfaces, and partly by M. Schiffer (1943) and S. Bergman (1950), with whose work I had become acquainted shortly after the war. The paper also paved the way for my book on Riemann surfaces with L. Sario [1960], but it is probably more readable because of its more restricted contents.

I would also like to acknowledge that when writing this paper I made important use of an observation of P. Garabedian to the effect that the relevant extremal problems occur in pairs connected by a sort of duality. This is of course a classical phenomenon, but in the present connections it was sometimes not obvious how to formulate the dual problem.

9.7 The allied infinitesimal form of the extremal problem

The input required to pose Ahlfors' extremal problem, is a membrane with two interior marked points, denoted a, b . When the point b converges to the point a (becoming infinitely close to it), we may think of a unique point of multiplicity two. This limiting process mutates the extremum problem into:

Problem 9.4 *Let a be a single point in the membrane W . Among the functions f analytic on W with $|f| \leq 1$ on W it is required to find the one which makes the modulus of the derivative $f'(a)$ to a maximum. Here the derivative is computed w.r.t. a holomorphic chart, hence the value of the maximum has no intrinsic meaning, but the extremal function has. The extremal function exist and is unique (up to a rotation) and denoted by $f_{a,a} = f_a$.*

It seems to be folklore that such functions are also circle maps subjected to the same Ahlfors bound $\deg f_a \leq r + 2p$. Presumably a continuity argument reduces to the case of (bipolar) functions $f_{a,b}$, or maybe adapt the whole argument in Ahlfors 1950 [17]. At any rate, the result is taken for granted in Yamada 1978 [894], Gouma 1998 [297]. This can maybe deduced as a special case of Jenkins-Suita 1979 [393].

9.8 Higher extremal problems=HEP \approx High energy physics, alias Pick-Nevanlinna interpolation

What happens if we take more than two points? For instance three points a, b, c ? Should we then maximize the area of the simplex spanned by the image points? If yes for which metric on the disc (Euclid vs. hyperbolic)? How does the problem reformulate when the 3 points coalesce at the subatomic level into a point affected by a multiplicity 3. Does the problem amount then to maximize the modulus of the first two derivatives.

Maybe this brings us in the realm of Pick-Nevanlinna interpolation, a theory initially developed in the disc. Compare e.g. Garabedian 1949 [276], Heins 1950 [358], Jenkins-Suita 1979 [393].

Perhaps for any (effective) divisor $D = d_1p_1 + \dots + d_n p_n$ interior to the membrane there is an extremal problem denoted $EP(D)$. Then how much of Ahlfors' theory extends: existence, uniqueness and qualitative circle mapping nature of the function, and estimates over the degree of the extremals. In the classic theory where $\deg(D) = 2$ we have $\deg f_{a,b} = r + 2p$. Maybe in general denoting by f_D the extremal function allied to the divisor D we find $\deg f_D \leq r + \deg(D)p$. Compare Jenkins-Suita 1979 [393] for more serious answers. If we could find a divisor of degree one then this would recover Gabard's bound $r+p$. Maybe not a divisor is required but an ordered collections of points, as in Ahlfors' original problem where a seems to have a preferred role over b , getting mapped to zero.

Such higher extremal problems depending upon a higher number of free parameters are probably more flexible in the sense that if the original $\deg(D) = 2$ case of Ahlfors fails to realize the gonality, then maybe higher versions succeed. Perhaps there is even a universal quantum limit of such problem EP_∞ for a divisor of infinite degree, leading thereby to a branched (yet Randschlicht) version of the Bieberbach coefficient problem. This is to mean a version of the Ahlfors map where all derivatives are simultaneously maximized as a large convey? One can speculate about the existence of such an universal extremal problem whose solution would be a branched avatar (non schlicht) of the Koebe extremal function (involved in the Bieberbach-de Branges theorem). This would be for the given bordered surface the best circle mapping and arguably it ought to realize the gonality. [05.11.12] In the classic Bieberbach problem involving the disc the coefficients of schlicht power series are estimated by $|a_n| \leq n$. If we replace the disc by a finite bordered surface F we could expect that all maps $F \rightarrow \Delta \rightarrow \mathbb{C}$ factorizing as a circle map (of minimal degree) followed by a schlicht map also admit universal estimates upon the coefficients w.r.t. to a

chart. Perhaps the upper bounds sequence involved in Bieberbach-de Branges (regularly spaced integers n) has to be replaced by certain spectral eigenvalues of F conceived as a vibrating membranes. So the problem is the following. Given a bordered surface F marked interiorly at some point a . We look at all analytic maps $F \rightarrow \mathbb{C}$ with $f(a) = 0$ and $f'(a) = 1$ w.r.t. some chart. We develop f in power series and expect some universal estimates on the coefficients at least when f factorizes as a circle map of minimal degree followed by a schlicht map. The dream would be that there is a unique extremal function maximizing simultaneously all coefficients and this would be essentially the best possible Ahlfors map post-composed with the Koebe function.

Of course it may happen that all this generality is not necessary in case the basic Ahlfors maps $f_{a,b}$ is already the most ergonomic object (in the sense of realizing the gonality).

A more orthodox way to formulate higher versions of Ahlfors' extremal problem involves the theory of Pick-Nevalinna interpolation. Cf. for instance Jenkins-Suita 1979 [393]. The original theory being formulated in the disc Δ , one may hope to lift things via an Ahlfors map but this probably leads nowhere. Genuine avatars of Ahlfors extremal problem are formulated by prescribing Taylor section (jets) at a given collection of points. Compare again Jenkins-Suita 1979 [393], building upon a paper of Heins 1975 [361]. In this extended context all features of the Ahlfors map persists: existence of an extremal (via normal families), uniqueness of the solution (Heins 1975), finite sheeted covering of the disc, and upper bound over the mapping degree. Again a crucial question is whether such problems always achieve the gonality.

10 Ahlfors' proof

[January 2012] This section is a superficial glimpse into Ahlfors' original resolution of his extremal problem emphasizing that Ahlfors requires first the qualitative existence of a circle map. A more detailed analysis will be attempted later (Section 20).

10.1 Soft part of Ahlfors 1950: circle maps with $\leq r + 2p = g + 1$ sheets

When writing the paper Gabard 2006 [255] (and a fortiori in my Thesis 2004 [254]), I was very ignorant about the depth of Ahlfors' paper (and the massive literature around it). To be honest I am still today quite ignorant having only a very fragmentary understanding of Ahlfors arguments. I take this opportunity, to rectify the arrogant claim (in *loc. cit.* [255]) to the effect that a simplified proof of Ahlfors' theorem is proposed. Of course, my paper only recovers the weaker assertion about existence of circle maps (in contradistinction to the deeper extremal problem analyzed by Ahlfors).

Furthermore even in the weaker circle map context, I only realized recently [January 2012] that a much shorter portion of Ahlfors' paper achieves this goal (cf. Ahlfors 1950 [17, p.124–126]), even with the $r + 2p = g + 1$ bound on the degree. We reproduce the relevant extracts (p.124 and then p.126):

Quote 10.1 (Ahlfors 1950) [p.124] It must first be proved that the class of functions with $F(a) = 0$ and $|F| = 1$ on C [=the boundary contours] is not empty. In other words, we must show that \overline{W} can be mapped onto a full covering surface of the unit circle.

[p.126] The function [...] maps \overline{W} onto a covering surface of the unit circle[=disk], and a standard argument[=just number conservation] shows that every point is covered exactly $P + 1$ times. [P is the genus of the double in Ahlfors' notation]

Thus, we have the following historical:

Conjecture 10.2 *As early as Spring 1948, Ahlfors had a proof of the existence of a circle map of degree $\leq r + 2p$.*

This conjecture is supported by the remarks made in Nehari 1950 [591] (cf. our Quote 11.3). In contrast, the issue that the same upper bound $r + 2p$ holds true for Ahlfors extremals may have required Garabedian formulation of the dual extremal problem for differentials. This is somehow in line with Jenkins-Suita 1979 [393]), who speaks of the *Garabedian bound* following a coinage of Heins 1975 [361] apparently.

At any rate, it seems first crucial to understand the easy part of Ahlfors' argument (existence of a circle map of degree $\leq r + 2p$). Even here we failed as yet.

Anecdote (skip!) Ahlfors' argument bears some vague resemblance with the argument exposed by myself in the RAAG-conference of 2001. Here the game was that (in view of Riemann (without Roch)) any group of $g + 1$ points on the curve moves. The orthosymmetric curve in question is of course the Schottky double of the given bordered surface. If such points are chosen on the real locus we are forced in the non-Harnack maximal case to select two points on the same oval (pigeon hole principle). All the subtlety is to ensure that those points will circulate along the complex orientation (as the border of one half) without doing collision expelling them in the imaginary locus, and thereby violating total reality. Using Abel's theorem plus some incompressible fluid argument I tried to argue that this is always possible for a clever choice of (totally real) divisor. However the argument was slightly vicious, and it would require me too hard work to repair it.) If I have enough energy I should try to write down this argument, while trying to analyze it properly.

In Ahlfors' paper (1950 [17]), one starts with a circle map of degree $\leq r + 2p$, and by a miraculous intervention of Garabedian the same bound turns out to be valid for an Ahlfors extremals. Let us refer to this vague principle as the Ahlfors-Garabedian divination (AGD). (Vagueness only alludes to my own poor understanding of their methods.)

Now in view of Gabard 2006 [255], as well as the deeper investigation of Coppens 2011 [183], we know that circle maps of lower degrees $\leq r + p$ exist. Thus, granting the AGD-divination, we may expect to find Ahlfors extremals of the same degree. Of course this amounts to take the best from two different worlds, and is extremely far from a serious argument.

Hence a thorough study of Ahlfors 1950 [17] perhaps suitably adapted (and augmented by other tricks) could lead to a confirmation of the naive Conjecture 2.4. Of course this is pure speculation, and arguably the shift could be a study circle maps per se without getting obnubilated by Ahlfors extremal problem.

10.2 Ahlfors hard extremal problem

We have nothing to add for the moment, suffices to say that Lagrange multipliers play a crucial role (as in earlier work of Grunsky). Yet it would be nice to summarize the idea (and the logical structure):

(1) **Existence of extremals.** Ahlfors first needs the existence of a circle map so as to have a non-empty set of competing functions (giving some ground under the foots to get started). Of course a function bounded by one would have been sufficient to get started, but Ahlfors achieves much more. Of course the normal families argument alone cannot supplant this preliminary study.

In papers subsequent to Ahlfors's, namely Read 1958 [676] and Royden 1962 [716] existence is derived via more abstract functional-analysis (Hahn-Banach). More on this in Section 11.5.

Other treatments Heins 1950 [358] appeals to Martin's theory and elementary convexity consideration, which expressed in more highbrow setting essentially amounts to Krein-Milman existence of extreme points in convex bodies (cf. esp. Forelli 1979 [246] and the discussion in Heins 1985 [363]).

(2) **Uniqueness of the extremal.** Looks easy (essentially like when defining something by a universal property in category theory). Universal properties of category theory are essentially akin to extremal problems in geometry. This is not completely true for some natural extremum problems admits several so-

lutions). In the case at hand uniqueness is essentially a version of Schwarz’s lemma.

11 Other accounts of Ahlfors’ extremal problem

Ahlfors’ paper of 1950 [17] aroused quick interest among the conformal mappers community (Nehari 1950, Heins 1950, Garabedian 1949–50, Schiffer, etc.). Numerous papers seem to reprove Ahlfors’s theorem along (better?) routes (e.g., Read 1958, slightly optimized in Royden 1962). The latter article seems to be among the most popular revision of Ahlfors 1950 [17], with identical results but possible simplifications in the proof. The present section tries to review those (second generation) contributions while providing link to subsequent critics (e.g., Nehari 1950 is criticized by Tietz 1955, who in turn is attacked by Köditz-Timmann 1975).

11.1 Garabedian 1949, 1950

Garabedian qualifies himself as a hard-worker, who could absorb simultaneously the influence of three giants: Ahlfors, Bergman and Schiffer. As a result, he seems to have exerted a notable influence over the final shape of Ahlfors 1950 [17], and is even apparently able to reprove the full result of Ahlfors 1950 [17] in the paper Garabedian 1950 [277, p. 361]. (A little Riemann-Hurwitz computation is required to convince that Garabedian reobtains exactly the same degree $r + 2p$ as Ahlfors.) The proof deploys a rich mixture of techniques (Teichmüller, Grunsky, Ahlfors, plus the variational method of Schiffer).

Another point worth noticing is the following issue oft emphasized by Garabedian [279, p. 182]:

Quote 11.1 (Garabedian-Schiffer 1950) Thus our procedure leads to the existence of the circle mapping $F(z)$ which is associated with Schwarz’s lemma. It is to be noted that the existence of this function lies somewhat deeper than the existence of the slit mappings $\varphi(w)$ and $\psi(w)$ in multiply-connected domains, and therefore it is not too surprising that the present section is more difficult than the preceding ones. Of course, for $n = 1$, $F(z)$ is just the function found in the elementary Koebe proof of the Riemann mapping theorem.

Garabedian alone repeats a similar comment in Garabedian 1949 [280, p. 207]:

Quote 11.2 (Garabedian 1949) The conformal mappings which we obtain here are closely related to the generalization of Schwarz’s lemma to multiply connected domains in sharp form [1, 7] [=resp. Ahlfors 1947 [16], and Garabedian 1949, Duke Math. J.], and their existence lies somewhat deeper than that of the more standard canonical maps in a multiply connected region.

11.2 Nehari 1950, Tietz 1955, Köditz-Timann 1975

Regarding the first two mentioned papers (Nehari 1950 [591], Tietz 1955 [830]), I suggested in Gabard 2006 [255, p. 946], that those papers may have conjectured the improved upper bound $r+p$ for the degree of a circle map. (When discovering the $r+p$ bound ca. 2001/02 I was not influenced by those papers (which I located only later in 2005 while polishing the ultimate shape of Gabard 2006 [255].)

Nehari 1950 [591] does not seem to give a new proof of circle maps (Ahlfors’ theorem), but inspired by it proposes to describe canonical slit maps (incidentally those for which Garabedian seems to have a lesser esteem). Nehari also shows how to express the Ahlfors function in terms of Bergman kernel function. Nehari’s paper shows that Ahlfors was in possession of the degree $r + 2p$ as early as Spring 1948, at least for a circle map. It is a delicate question if the same bound for extremal maps requires Garabedian’s remark about the dual extremal problem. Heins’s paper 1975 [361] using the term “Garabedian’s bound” may suggest a positive answer. The reader is not well placed to guess the answer,

but remember that the (published) proof in Ahlfors 1950 [17] requires (and acknowledges) Garabedian's dual problem. Let us quote the crucial extract of Nehari:

Quote 11.3 (Nehari 1950) It was recently shown by Ahlfors [1](=L. Ahlfors, Material presented in a colloquium lecture at Harvard University in Spring 1948.) that the well known canonical conformal mapping of a schlicht domain of connectivity n onto an n -times covered circle [5,7] (=Bieberbach 1925, Grunsky 1937–41) can be generalized, in the case of an open Riemann surface, in the following manner: an open Riemann surface of genus g which is bounded by n closed curves can be mapped conformally onto a multiply-covered circle, the number of coverings not exceeding $n + 2g$.

Soon afterwards, Tietz 1955 [830, p. 49] criticizes (slightly) some of Nehari's asserted results:

Quote 11.4 (Tietz 1955) Bei der Herleitung seiner Schlitztheoreme kommt Herr Nehari ebenfalls auf diese Frage; sein Beweis für die genannte Vermutung ist jedoch unhaltbar.

Nimmt man jedoch diese Neharische Behauptung als richtig an, so hieße das, daß R aus $p + r$, und damit R^2 aus $2p + r = G + 1$ Blättern bestünde; ...

This seems to be a forerunner of the bound $r + p$ (by commutativity of addition!), at the conjectural level at least. [Parenthetically, I do not understand Tietz's claim about the sheet number of the double R^2 . I believe that the degree keeps the same value $p + r$, as one has to double the map not just the space.] Finally, Tietz concludes his paper [830, p. 49] as follows:

Die selben Überlegungen, die zu unserem Abbildungssatz führten, ermöglichen auch einen neuen Existenzbeweis für die Ahlforsche Normalform, wiederum jedoch ohne eine Schranke für die Anzahl der benötigten Blätter zu ergeben.

So Tietz does not seem to be able reprove a result as strong as the one of Ahlfors 1950. In fact, the situation looks even worse, since even Tietz's weak version is questioned in the paper by Köditz-Tillmann 1975 [470, p.157], as shown in the following extract (parenthetical reference are ours addition):

Derartige randschlichte Abbildungen wurden von Tietz in [4] (=Tietz, 1957, Faber-Theorie ...) benötigt, um die Faber-Theorie auf nicht kompakte Riemannsche Flächen zu übertragen. Sein in [3] (=Tietz, 1955=[830]) angegebener Beweis der Existenz solcher Funktionen ist jedoch lückenhaft. [...]

The extract is followed by a specific objection (not reproduced here). The article (of Köditz-Timmann 1975 [470, Satz 3, p. 159]) seems however to contain a proof of Ahlfors' theorem based upon an "Approximationsatzes von Behnke u. Stein", yet without any bound on the degree.

A propos Behnke-Stein 1947/48/49 [62] (the famous paper going back to 1943), it contains the result that any open Riemann surface (arbitrary connectivity and genus) admits a non-constant analytic function.

Question 11.5 *Can one deduce this theorem of Behnke-Stein via the Ahlfors function, by taking an exhaustion an agglomerating in some way Ahlfors extremals (or weaker circle maps)?*

In this connection let us remember the paper by Nishino 1982 [614], where Ahlfors is applied to prove existence of (non-constant) analytic functions on certain complex surfaces (four real dimensions). Since this Nishino paper employs Ahlfors bound $r + 2p$, it would be nice to understand it thoroughly to see if some better constant leads to some sharpened result.

11.3 Heins 1950

Heins being one of the most prolific and pleasant-to-read writer of the U.S. school (student of Walsh), it is not surprising to find several first classes contributions regarding our special Ahlfors map topic. Specifically, the paper Heins 1950

[358] reproves Ahlfors' result in presumably its full strength (this even without quoting Ahlfors 1950 [17] but the closely allied work Garabedian 1949 [276]). Remember that Ahlfors' result was exposed at the Harvard seminar in Spring 1948 (cf. Nehari's quote 11.3), and must have widely circulated since then. Taking a closer look to Heins' paper, it is at first sight not completely evident that a bound on the degree derives from his method but is quite likely to do since his quantity m (number of generators of the fundamental group, cf. p. 571) is easily recognized to be $2p + (r - 1)$, where p is the genus and r the number of contours. Thus one certainly recovers exactly Ahlfors's result with its bound. In some sense, Heins's paper goes even deeper than Ahlfors by treating Pick-Nevalinna interpolation.

Several subsequent works in Heins' spirit (overlapping with Ahlfors theorem) are worth mentioning: Heins 1975 [361], Forelli 1979 [246] and Heins 1985 [363].

11.4 Kuramochi 1952

The paper Kuramochi 1952 [487] also seems to recover Ahlfors bound for circle maps using the extremal problem. This is maybe the sort of technical paper with too much notation and not enough notation? It seems to be inspired by Ahlfors 1950 [17] and by a 1951 paper by Nehari (confined to the planar case). Nehari offers a positive review (in MathReviews):

Quote 11.6 (Nehari 1953) Generalizing a method developed by the reviewer for the case of plane domains [Amer. J. Math. 73 (1951), 78–106], the author discusses extremal problems for bounded analytic functions on open Riemann surfaces of positive genus. The procedure is illustrated by a detailed treatment of the case corresponding to the classical Schwarz lemma which had previously been discussed, by different methods, by L. V. Ahlfors [1950]. A complete characterization of the extremal function is obtained and Ahlfors' positive differential is constructed.

11.5 Read 1958, Royden 1962 (via Hahn-Banach)

We start with:

- Royden 1962 [716], where existence of a solution to Ahlfors' extremal problems is achieved via a conjunction of Hahn-Banach and Riesz's representation theorem (circumventing thereby both Euler-Lagrange and normal families). Exploiting the duality pointed out by Garabedian (pair of extremal problems with a dualizing Schottky differential, i.e. one extending to the double), the control on the degree is achieved by the usual index formula $\deg(\vartheta) = 2g - 2$ (Poincaré 1881–85, but already in Riemann in the holomorphic case at hand). Ahlfors' upper bound $\deg f_{a,b} \leq r + 2p$ follows. Royden's paper is therefore quite remarkable for supplying alternative arguments. It seems to have been inspired mostly by:

- Read 1958 (two papers [675], [676]). Read is also a student of Ahlfors (as one may learn in Ahlfors 1958 [21]) and already relies on Hahn-Banach to prove existence of an Ahlfors function (but, as Royden observes, does not take care of making the argument with the Schottky differential so as to bound the degree). The technique employed (by Read) to prove extremals is to relate the dual extremal problems (à la Garabedian-Ahlfors, 1949–1950) to conjugate extremum problems of the Lebesgue classes L_p and L_q , where $p^{-1} + q^{-1} = 1$, where one maximizes an L_p -norm versus vs. minimizing an L_q -norm. Such problems classically reduce to Hahn-Banach. For this reduction of Garabedian-Ahlfors to Hahn-Banach, Read employs a converse to Cauchy's theorem (itself an application of Stokes) due to Rudin 1955 [721] in the planar case. Methods of Rogosinski-Shapiro 1953 are another ingredient to the proof.

To summarize, the Read-Royden approach via Hahn-Banach (functional analysis, coinage of Hadamard) effects a little drift from the traditional Euler-Lagrange variational approach (used in Grunsky 1940-46, Ahlfors 1947, 1950). As conceptually brilliant as it is, the new method does not lead to an improved result. The reason is very simple that Ahlfors' bound is sharp within

the extremal it solves, as already mentioned in the Introduction (contribution of Yamada 1978 [894]).

The game naturally splits in existence of extremals (either via Montel’s normal families or via Hahn-Banach) and then to analyze its geometric properties. Ahlfors’ 1950 treatment (apparently influenced by Garabedian’s dual extremal problem) supplies the trick to bound the degree via a Schottky differential, and Royden’s argument looks in this second geometric step virtually identical to Ahlfors’ original.

Remember yet the puzzling fact that Ahlfors’ original proof (presented in Spring 1948 at Harvard as reported in Nehari 1950 [591, p. 258, footnote], and perhaps nearly similar with pages 124–126 of the published paper 1950 [17]) manages without Garabedian’s influence to supply existence of a circle map of degree bounded by $r + 2p$.

12 Existence of (inextremal) circle maps

This section focuses on existence of circle maps on membranes (=finite bordered Riemann surfaces) without appeal to the extremal problem. In fact those are logically required (at least in Ahlfors’ account but not in Royden’s 1962 [716]) as a qualitative preparation to the analysis of the quantitative problem.

12.1 Ahlfors 1948/50, Garabedian 1949

[09.06.12] We mean the papers Ahlfors 1950 [17] and Garabedian 1949 [276]. (The additional 1948 date is intended to reflect the fact that Ahlfors lectured on this material somewhat earlier, as shown by Nehari’s Quote 11.3.) Those writers address the deeper extremal problem $\max |f'(a)|$ amongst functions bounded-by-one $|f| \leq 1$, however it seems that they are well-acquainted with topological methods (e.g., Garabedian 1949 [276] cites Alexandroff-Hopf’s classical 1935 treatise “*Topologie*”). One may wonder if such a qualitative topological inspection is not a logical prerequisite to their treatments of the quantitative extremal problem.

Prior to posing any extremal problem, it is vital to know that the set of permissible competing functions is non-empty. (Otherwise we live in a nihilist universe without any existence theorem.) Perhaps the following trivial remarks are worth doing. For domains bounded by r Jordan curves, we have clearly some function bounded-by-one (take the identity map suitably scaled to shrink the domain inside the unit-disc). For a general compact bordered surface, it is less obvious that such functions exist at all. Of course one can take the Schottky double to apply Riemann’s existence theorem (of a morphism to \mathbb{P}^1) and look at the image of the (compact) half. However the latter can still cover the full Riemann sphere, which is annoying for our purpose. [05.11.12] Using Klein’s work one can certainly find an equivariant map from the double to the sphere acted upon by orthosymmetry (standard complex conjugation), yet it may still be the case that the full sphere is covered by the half of the double. [As a simple example we may take a conic C_2 with real points and project it from a real point p outside of the unique oval. The corresponding map $C_2 \rightarrow \mathbb{P}^1$ is equivariant and surjective when restricted to one half of the complex locus of the conic C_2 . Indeed given a point of \mathbb{P}^1 is tantamount to give a line L through the center of perspective p . This line L cuts C_2 in two points (except for the two real tangents). If L is a real line cutting the real locus $C_2(\mathbb{R})$ we can take as antecedent a point on the border of the half Riemann surface. If L does not cut $C_2(\mathbb{R})$ its intersection with C_2 is a conjugate pairs of points one of them lying in the fixed half of C_2 . Finally if L is an imaginary line then its intersection with C_2 consists of two points distributed in both halves of C_2 . Indeed L can by continuity be degenerated to a real line L_0 missing the real locus of C_2 (recall that the pencil of line is just an equatorial sphere with equator corresponding to real lines) and since during the process no points of $L \cap C_2$ became real it follows

that both L and L_0 have the same distributional pattern when intersected with the conic.]

Hence in general some preparatory qualitative “topological” investigation is required to see that the extremal problem is non-vacuously posed. Remember that Ahlfors directly attacks the existence of a circle map, where it may have been sufficient to prove existence of a function bounded-by-one. His argument is in part topological inasmuch as it involves annihilating the periods of the conjugate differential of a suitable harmonic function, but also contains a great deal of non-trivial analysis, plus basic principle of convex geometry. We shall try later to penetrate in more details in Ahlfors proof.

Regarding Garabedian 1949 [276], topological considerations also plays a vital role in conjunction with Abelian integrals, etc. We refer the reader to the original paper. In retrospect, it may just be too sad that this brilliant work was not directly written in the broader context of Riemann surfaces.

12.2 Mizumoto 1960

This is the paper Mizumoto 1960 [564] (which I discovered only in March 2012), yet it looks quite original making use of a topological argument involving (Brouwer’s) topological degree of a continuous mapping. So it spiritually close to Gabard 2006 [255]. However Mizumoto [564, p. 63, Thm 1, with N defined on p. 58] only recovers the old bound of Ahlfors $r + 2p$.

12.3 Gabard 2004–2006

The proof published in the writer’s Thesis 2004 [254] is essentially the same as the one in 2006 [255] (modulo slight modifications suggested by the referee, presumably J. Huisman). In fact J. Huisman already on the 2004 version supplied some corrections about naive little mistakes that I made (esp. a wrong statement of Abel’s theorem forgetting to ask both divisors to be of the same degree). Of course it is to be hoped that the new bound $\leq r + p$ will stay correct in the long run. In case the result is true, it would be desirable if alternative more conventional analytic methods are able to reprove this bound $r + p$. Recent results of Coppens 2011 [183] show the bound $r + p$ to be best-possible, at least for generic curves in the moduli space. Coppens’ work actually supplies a much sharper understanding of all intermediate gonality (compare Section 14.2 for more).

There is a little historical inaccuracy in Gabard 2006 [255]. When writing the paper, I did not realized properly that Ahlfors has also a quite elementary proof of the existence of circle maps of degree $r + 2p$. Alas, I still do not completely understand Ahlfors’ proof yet it is clear-cut that its elementary part does not use the extremal problem! Accordingly, the sentence in Gabard 2006, p. 946 reading as follows is quite inaccurate: “[...] *un résultat équivalent fut démontré par L. V. Ahlfors en 1950, qui déduit d’un problème d’extrémalisation la possibilité de représenter toute surface de Riemann à bord compacte comme revêtement holomorphe (ramifié) du disque.*”

13 Related results

Some closely allied problems involves *Parallelschlitzabbildung* (parallel-slit mappings), the relationship with the Bergman kernel, etc. Although a bit outside our main theme of the Ahlfors map, the methods employed are quite similar and therefore a thorough knowledge of those proximate mappings problem can only reinforce the general understanding.

13.1 Parallel slit mappings (Schottky 1877, Cecioni 1908, Hilbert 1909)

Those mappings (abridged PSM) involves several tentacles using varied technologies tabulated as follows:

- (Classical) Schottky 1877 [763], Cecioni 1908 [160] (via methods of Schwarz, and Picard). Classically Schottky's argument is criticized for depending only upon a constant count not fully sufficient to establish the mapping existence (this critic appears e.g., in Cecioni *loc. cit.*) It is likely that subsequent rigorous continuity methods as developed by Brouwer upon topological ground can easily supplement Schottky's heuristic argument (browse through Koebe's works, etc.)
- (Dirichlet resurrected) Hilbert 1909 [377], Koebe 1910 [457], Courant 1910/12 [185] (those writers extend the PSM to domains of infinite connectivity)
- (Extremal problem à la FROG Fejér-Riesz-Radó-(Carathéodory)-Ostrowski-[Grunsky]) de Possel 1931 [658], 1932 [660], Grötzsch, Rengel 1932/33 [681], 1934 [682],
- (Bergman kernel) Nehari 1949 [588], Lehto 1949 [500], Meschkowski 1951 [548], etc.

A philosophical curiosity is that PSM is somewhat easier (according to specialists, cf. e.g. Garabedian's Quote 11.1 and Hejhal 1974 [368]) to handle than the Kreisnormierung (KNP) (cf. next section), and this already in finite connectivity (cf. e.g. the very subtle approach to KNP imagined in Schiffer-Hawley 1962 [756]). One may wonder about this sharp discrepancy of difficulty, since it is easily conceivable that for such canonical regions (bounded by elementary curves of the most elementary stock) one could easily pass from one normal-form to the other through explicit maps (at least in finite connectivity). [Of course I do not claim that this is an easy game for me, but I suspect so for people like Schwarz-Christoffel or Schläfli it could be accessible. Of course there is maybe a difficulty in choosing the "accessory parameters" but this should be pulverizable through modern topological arguments à la Brouwer?] Another striking asymmetry of the theory is that PSM hold true in infinite connectivity (since Hilbert 1909 [377] and the subsequent work of Koebe 1910 [457]), whereas KNP is still wide open in infinite connectivity. (A very naive guess would be to deduce KNP_{∞} from PSM_{∞} through a continuity method for infinite dimensional manifolds. Maybe this suggests perhaps using Leray-Schauder theory as an infinite dimensional avatar of the Brouwer degree? Of course, this is just pure speculation.

Regarding PSM, interesting remarks on the literature are given in Burckel 1979 [128, p. 357–8], namely:

- the result in infinite connectivity is due to Hilbert, Koebe, Grötzsch, Rengel, de Possel (as we just said also),
- excellent book expositions are credited to Bieberbach 1937/67 [101], Golusin 1952/57 [296] and Nehari [594],
- de Possel's proof in 1931 [658] (and the allied work by Rengel and Grötzsch) via an extremum problem is recognized as reminiscent of Fejér-Riesz's proof of RMT. However at one point of the proof RMT is invoked. Later de Possel 1939 [662] found a (short) constructive way around this (see also Garabedian 1976 [281]).
- for an approach to PSM, and the other canonical regions (radial or circular slits), via the Dirichlet principle see Ahlfors 1966 [24].

13.2 Kreisnormierungsprinzip (Riemann 1857, Schottky 1877, Koebe 1906-08-10-20-22, Denneberg 1932, Grötzsch 1935, Meschkowski 1951–52, Strebel 1951–53, Bers 1961, Sibner 1965–68, Morrey 1966, Haas 1984, He-Schramm 1993)

This (cavalier?) principle (abridged KNP) starts with the fact that a multiply-connected domain of finite connectivity can be conformally mapped to a circular domain. This was already implicit in Riemann’s Nachlass 1857/58/76 [689] (according to Bieberbach 1968 [102, p.148–9] who apparently saw a copy of Riemann’s original manuscript, cf. our Quote 6.1 reproducing Bieberbach 1925). The statement resurfaced more explicitly in Schottky’s thesis 1875/77 [763] (at least in the Latin 1875 version). The latter’s argument depends however again only upon a naive parameter count of moduli. Indeed, a circular domain with r contours depends upon $3r$ free parameters to describe the centers and radii of those r circles, and removing the 6 (real) parameters involved in the automorphism group of the (Riemann) sphere, we get $3r - 6$ essential constants. Thinking about the (Schottky) double of the domain, whose genus is $g = r - 1$, this number agrees with Riemann’s count of $3g - 3$ moduli (where here of course we restrict attention to “real” moduli). This suggests that circular domains are sufficiently flexible to conformally represent any domain. It is likely that such naive counting argument turns into rigorous proof by appealing to some topological principles (like Brouwer’s invariance of the domain) to vindicate the so-called continuity method. This sort of game occupy several of Koebe’s papers, who probably arranged this already. Cf. also Grunsky 1978 [322] for an implementation in 12 pages (p.114–126).

Koebe devoted several papers to the question in 1906 [447], 1907 [448], 1910 [456] (Überlagerungsfläche and iteration method), 1920 [467].

As early as 1908 [452], Koebe advanced conjecturally the validity of this principle for domains of infinite connectivity: an issue still undecided today (2012), but corroborated in He-Schramm 1993 [353] in the case of countably many boundary components (via the method of circle packings). Most of the contributions (listed in our subtitle) are carefully referenced in He-Schramm’s paper just cited.

Other proofs of the basic (finitistic) KNP result are obtained by:

- Courant 1950 [195] (via a Plateau-style approach) [Micro-Warning: Hildebrandt-von der Mosel 2009 [379] and also Hildebrandt 2011 [380] credit rather Morrey 1966 [571] for the first rigorous proof, modulo yet another gap filled by Jost 1985 [402]].

- Schiffer and Hawley in several papers: Schiffer 1959 [755] (via the Fredholm determinant) and Schiffer-Hawley 1962 [756] (via an extremal problem of the Dirichlet type).

Incidentally, it is common folklore that the Kreisnormierung, like the uniformization and even the Ahlfors circle map belong to a somewhat deeper class of problem than the parallel-slit mapping which succumb quickly to elementary techniques of potential theory. (Compare Garabedian-Schiffer’s Quotes 11.1 and 11.2, and also Hejhal 1974 [368, p.19] who makes similar remarks, for instance “*We remark that the Koebe [circular] mapping is similar to the universal covering map, in that neither an explicit formula nor an explicit differential equation is known for it.*”)

So in view of such higher stock problems, it is challenging to ask whether KNP(finite) could not be handled via an extremal problem à la Ahlfors (or to be more accurate historically in the spirit of FROG=Fejér-Riesz-(Carathéodory)-Ostrowski-Grunsky).

[★ Warning the sequel looks natural yet erroneous, cf. the next paragraph for a rectification ♡] Maybe the relevant extremal problem (under educated guess) would be to maximize the modulus of the derivative at a fixed point a of the domain amongst functions bounded-by-one (in modulus) while imposing the extra schlichtness to the mappings (otherwise we just get Ahlfors many-sheeted

discs). The basic philosophy being that this maximum pressurization imposed at the point a imposes a surjectivity of the mapping while filling most of the container in which the function is constricted by the condition $|f| \leq 1$. Speculating further one may dream that this “Ahlfors-schlicht” extremum problem cracks the fully general KNP in infinite connectivity (KNP(∞)). However, it suffices to remind that several complications are reported for the usual Ahlfors function in infinite connectivity (existence easy and uniqueness due to Havinson 1961/64 [345], Carleson 1960/67 [155], see also Fisher 1969 [238]) by subsequent investigators like Rödning 1977 [709], Minda 1981 [556], Yamada 1983–92 [895] [896], where the Ahlfors extremal function ceases to be a circle map and start to omit values). It is therefore quite overoptimistic to hope “Ahlfors-type”(=FROG) strategy toward the prestigious KNP(∞).

[05.11.12] ♡ *Correction.*—The beginning of the previous paragraph is of course erroneous since we know that the analog of the Ahlfors map under the schlichtness proviso takes a multi-connected domain not on a Kreisbereich but on a circular slit disc. This result is due to Grötzsch 1928 [311], Grunsky 1932 [314], Nehari 1953 [595, p.264–5] (another proof while crediting the just two cited work by Grötzsch and Grunsky), Meschkowski 1953 [552] and finally Reich-Warschawski 1960 [677]. (Those references were already listed in Section 8.4.) It may yet be observed that such circular-slit-disc ranged maps are not schlicht up to the boundary included, and one can still speculate that a suitable extremal problem akin to Ahlfors gives KNP (in finite connectivity at least).

13.3 Rödning 1977 (still not read)

The paper Rödning 1977 [710] is perhaps quite dangerous (for Gabard 2006 [255]), yet I could not procure a copy as yet.

13.4 Behavior of the Ahlfors function in domains of infinite connectivity

There is a series of work studying the behavior of the Ahlfors function for domain of infinite connectivity. Traditionally those works looks more confined to the domain case.

The basic existence and uniqueness result are addressed by Havinson 1961/64 [345], Carleson [155] with simplifications in Fisher 1969 [238]. In contrast to the finite case, the image of the Ahlfors function does not need to fill the full unit circle (=disc). We just list some main contributions:

Rödning 1977 [709] (2 points are omitted), Minda 1981 [556] (fairly general discrete subset of omitted values), Yamada 1983 (omission of a fairly general set of logarithmic capacity zero), Yamada 1992 [896] (characterization of omitted point-sets of the Ahlfors function in the case of Denjoy domain).

14 The quest of best-possible bounds

The writers’s own contribution $r + p$ seems to be (at first glance) a dramatic improvement upon Ahlfors’ upper bound $r + 2p$ (at least so sounded the diagnostic of the generous Zentralblatt reviewer of my article, namely Bujalance). However in the long run it may occur that Ahlfors’ method is always as good for a suitable choice of points a, b .

14.1 Distribution of Ahlfors’ degrees (Yamada 1978–2001, Gouma 1998)

The papers by Yamada 1978 [894], 2001 [897] and Gouma 1998 [297] address the delicate question about the precise values realizable as degrees of Ahlfors functions.

Ahlfors’ pinching $r \leq \deg(f_{a,b}) \leq r + 2p$ collapses for planar surfaces ($p = 0$) to an equality, and the question is trivially settled in this case.

Yamada and Gouma rather considers the infinitesimal form of the problem where just a single point a is prescribed in the interior. They obtain spectacular complete results for those membranes having a hyperelliptic double (*hyperelliptic membranes*), yet without being planar ($p = 0$) in which case we are in the trivial range already discussed.

Theorem 14.1 *Given a hyperelliptic membrane, the following assertions holds true:*

- (1) (Yamada 1978) *The ponctual Ahlfors function f_a has degree $g + 1$ at the fixed points of the hyperelliptic involution (so-called Weierstrass points).*
- (2) (Gouma 1998) *The degree of f_a can only assume values 2 or $g + 1$.*
- (3) (Yamada 2001) *The case of degree 2 is always realized at suitable points.*

[05.11.12] Gouma’s result shows a large discrepancy between degrees taken by Ahlfors maps and those of more general circle maps. Of course the latter are much more flexible and one specimen exists in degree 2 (just by quotienting by the hyperelliptic involution) and thus circle maps exist in all even degrees (post-compose with a power map $z \mapsto z^k$).

Those works promise a grandiose links between Ahlfors and the classic tradition of Weierstrass points, which probably also governs the degree of Ahlfors maps for more general non-hyperelliptic surfaces.

14.2 Separating gonality (Coppens 2011)

In another direction of dramatic depth, Marc Coppens 2011 [183] is able to show that he bound claimed by Gabard 2006 [255] is sharp. In fact Coppens establishes the even more spectacular result that all intermediate values of the gonality are realized. To be more specific, we need the following definition:

Definition 14.2 *The gonality (denoted γ) of a membrane (i.e. a compact bordered Riemann surface) is the least degree of a full (or total) covering map to the disc.*

[05.11.12] A full (or total) covering map can be defined just as non-constant analytic map taking boundary to boundary. Then it makes good sense to Schottky-double the map and classic theory ensures the branched cover nature of the map, in particular its surjectivity. The jargon total is borrowed from Stoilow 1938 [800] and quite compatible with “total reality” which is the algebro-geometric pendant of Ahlfors circle maps.

It is easy to show that a total map has no ramification along the boundary. (Possible argument: Else it behaves locally like $z \mapsto z^2$ near a boundary uniformizer, but then the half-space is wrapped to a full domain expanding outside the permissible range of the map.)

In particular such a total map induces a usual (unramified) cover of the circle $\partial W \rightarrow \partial D = S^1$, whereupon it follows the trivial lower bound $r \leq \gamma$, where r is the number of boundary contours of the membrane W . On the other hand Gabard’s main result in [255] asserts the upper bound $\gamma \leq r + p$, where p is the genus of W . Coppens’s striking result states:

Theorem 14.3 (Coppens 2011) *Practically, all intermediate values of the gonality compatible with the pinching $r \leq \gamma \leq r + p$ are realized as the gonality of a suitable membrane of topological type (r, p) . More accurately, there is a single trivial exception when $r = 1$ and $p > 0$, in which case the value $\gamma = 1$ must be excluded.*

Taking $\gamma = r + p$ supplies the sharpness of Gabard’s upper bound. On the other hand, it can be noticed that Coppens’ theorem yields a considerable compression over Ahlfors’ squeezing:

$$r \leq \deg(f_{a,b}) \leq r + 2p$$

into

$$r \leq \gamma \leq \deg(f_{a,b}) \leq r + 2p.$$

This is a noteworthy contribution to Yamada-Gouma's general question about the distribution of Ahlfors degrees (discussed in the previous section). Of course the most stringent restriction occurs when the gonality γ attains its extremum value $\gamma = r + p$, occurring for generic membrane in the moduli space $\mathcal{M}_{r,p}$ (parameterizing isomorphism classes of such Riemann surfaces).

Of course the moduli space stratifies through the gonalities. Imitating Riemann's original count in our context it must be easy (?) to compute dimensions of the varied strata. A deeper combinatorial investigation of this moduli space (with its stratified structure) would be desirable to complement the theory of Ahlfors circle maps.

[05.11.12] *Warning*—Presently we are not aware of any total-bordered avatar of the simple Riemann-type counting argument, which is so efficient for closed surfaces (predicting correctly the gonality $\lfloor (g+3)/2 \rfloor$ as well as the dimensions of moduli strata of lower gonalities). It may be suspected that this discrepancy is due to the boundary behavior of total maps which causes certain difficulties. Of course the difficulty is of a somewhat similar nature as the intricacies arising when doing real instead of complex algebraic geometry. Yet the problem is certainly not insurmountable.

14.3 Naive question: Ahlfors degree vs. the gonality

We may summarize information mentioned so far in the string of estimates:

$$r \leq \gamma \leq \begin{cases} \leq \deg f_{a,b} \\ \leq r + p \end{cases} \leq r + 2p \quad (2)$$

An obvious question is whether inequality $\gamma \leq \deg f_{a,b}$ is best-possible. In other words

Question 14.4 *Is Ahlfors extremal problem flexible enough so that for any membrane the Ahlfors map $f_{a,b}$ centered at suitable points a, b has degree $\deg f_{a,b}$ realizing the gonality γ .*

Yamada's deep result (2001 [897]) gives a positive answer in the case of hyperelliptic membranes (those which are 2-gonal $\gamma = 2$).

14.4 Other sources (Černe-Forstnerič 2002)

In Černe-Forstnerič 2002 [166, p. 686], one reads the following assertion:

Quote 14.5 (Černe-Forstnerič 2002) It is proved in Ahlfors 1950 [17, pp. 124–126] that on every bordered Riemann surface of genus p with r boundary components there is an inner function with multiplicity $2p + r$ (although the so-called Ahlfors functions may have smaller multiplicity).

On page 684, Rudin 1969 [723] is quoted. Also on page 693 we find an interesting stability of inner functions of degrees $\geq r + 2p - 1$.

15 Applications of the Ahlfors mapping

This section lists some the known applications of the Ahlfors function including the allied circle maps. Those applications split in those where the extremal property of the Ahlfors function is really used and those where only conformality and the essentially topological property of being a circle map is relevant.

15.1 Gleichgewicht der Electricität (Riemann 1857)

This is the very origin of all our story. Alas the physical applications Riemann's had in mind were apparently only partially reproduced in H. Weber's reconstruction of the original manuscript. Can someone imagine what Riemann had exactly in mind (eventually on the basis of the original manuscript, which must still be dormant somewhere in Göttingen)?

Here are some well-known remarks concerning this posthumous fragment (compare the "original" (as edited by H. Weber) reproduced in part below) as well as the remarks in Bieberbach 1925 [97, p. 9, §7]).

Quite interestingly Riemann starts with the first boundary value problem for plane domains, and actually uses the conformal circle map to solve it (whereas the reverse engineering may look more natural in view of his Dirichlet principle philosophy). Strikingly, Riemann anticipates both the Schwarz symmetry/reflection principle (1869 [768, p. 106]) as well as the Schottky double (1875–77 [763]). Typical to Riemann, an equality sign is virtually put between potential theory and algebraic functions, the Green theorem is used and Abelian integrals (of the third species) and their periods (Periodicitätsmoduln) are used. [05.11.12] Recall also that Bieberbach 1968 [102] asserts that Riemann's work also contains a trace of the Kreisnormierung. Besides, Bieberbach in 1925 (cf. Quote 6.1) gives full credit to Riemann for the proof of circle maps in the planar case (both via potential theory and algebraic functions) emphasizing that Weber's account is not completely faithful of the original manuscript. In contrast when based only on the published account of Weber, reviews of Riemann's work tend to be more minimalist. E.g., Grunsky 1978 [322, p. 198] writes: "*Theorem 4.1.1. [i.e. full covers of the disc for multi-connected domains] goes back to Riemann, [423], who gave some hints for the proof when D is bounded by circles. The first proof is due to Bieberbach [88](=1925), who used the Schottky-double and deep results in the theory of algebraic functions. Elementary proofs were given by Grunsky [195](=1937–41); [...]*"

Quote 15.1 (Riemann 1857/58-1876)

GLEICHGEWICHT DER ELECTRICITÄT AUF CYLINDERN MIT KREISFÖRMIGEM
QUERSCHNITT UND PARALLELEN AXEN.
CONFORME ABBILDUNG VON DURCH KREISE BEGRENZTEN FIGUREN.

[Footnote (Weber): Von dieser und den folgenden Abhandlungen liegen ausgeführte Manuscripte von Riemann nicht vor. Sie sind aus Blättern zusammengestellt, welche ausser wenigen Andeutungen nur Formeln enthalten.

Der zweite Theil der Ueberschrift bezeichnet wohl besser die allgemeine Bedeutung des Fragmentes, als die in der ersten Auflage allein genannte specielle Anwendung. W.]

Das Problem, die Vertheilung der statischen Electricität oder der Temperatur im stationären Zustand in unendlichen cylindrischen Leitern mit parallelen Erzeugenden zu bestimmen, vorausgesetzt, dass im ersteren Fall die vertheilenden Kräfte, im letzteren die Temperaturen der Oberflächen constant sind längs geraden Linien, die zu den Erzeugenden parallel sind, ist gelöst, so bald eine Lösung der folgenden mathematischen Aufgabe gefunden ist:

In einer ebenen, zusammenhängenden, einfach ausgebreiteten, aber von beliebigen Curven begrenzten Fläche S eine Function u der rechtwinkligen Coordinaten x, y so zu bestimmen, dass sie im Innern der Fläche S der Differentialgleichung genügt:

$$\frac{\partial^2 u}{\partial x^2} + \frac{\partial^2 u}{\partial y^2} = 0$$

und an den Grenzen beliebige vorgeschriebene Werthe annimmt. [So this is 'just' the first boundary value problem, alias Dirichlet principle.]

Diese Aufgabe lässt sich zunächst auf eine einfachere zurückführen:

Man bestimme eine Function $\zeta = \xi + \eta i$ des complexen Arguments $z = x + iy$, welche an sämtlichen Grenzcurven von S nur reell ist, in je einem Punkt einer jeden dieser Grenzcurven unendlich von der ersten Ordnung wird, übrigens aber in der ganzen Fläche S endlich und stetig bleibt. Es lässt sich von dieser Function leicht zeigen,

dass sie jeden beliebigen reellen Werth auf jeder der Grenzcurven ein und nur einmal annimmt, und dass sie im Innern der Fläche S jeden complexen Werth mit positiv imaginärem Theil n mal annimmt, wenn n die Anzahl der Grenzcurven von S ist, vorausgesetzt, dass bei einem positiven Umgang um eine der Grenzcurven ζ von $-\infty$ bis $+\infty$ geht. Durch diese Function erhält man auf der obern Hälfte der Ebene, welche die complexe Variable ζ repräsentirt, eine n fach ausgebreitete Fläche T , welche ein conformes Abbild der Fläche S liefert, und welche durch die Linien begrenzt ist, die in den n Blättern mit der reellen Axe zusammenfallen. Da die Fläche S und T gleich⁵ vielfach zusammenhängend sein müssen, nämlich n -fach, so hat T in seinem Innern $2n - 2$ einfache Verzweigungspunkte (vgl. Theorie der Abelschen Functionen, Art. 7, S. 113) und unsere Aufgabe ist zurückgeführt auf die folgende:

Eine wie T verzweigte Function des complexen Arguments ζ zu finden, deren reeller Theil u im Innern von T stetig ist und an den n Begrenzungslinien beliebige vorgeschriebene Werthe hat.

Kennt man nun eine wie T verzweigte Function $\tilde{\omega} = h + ig$ von ζ , welche in einem beliebigen Punkt ε im Innern von T logarithmisch unendlich ist, deren imaginärer Theil ig ausser in ε in T stetig ist und an der Grenze von T verschwindet, so hat man nach dem Greenschen Satze (Grundlagen für eine allgemeine Theorie der Functionen einer veränderlichen complexen Grösse Art. 10. S. 18 f.):

$$u_\varepsilon = -\frac{1}{2\pi} \int u \frac{\partial g}{\partial \eta} d\xi,$$

wo die Integration über die n Begrenzungslinien von T erstreckt ist.

Die Function g aber lässt sich auf folgende Art bestimmen. Man setze die Fläche T über die ganze Ebene ζ fort, indem man auf der unteren Hälfte (wo ζ einen negativ imaginären Theil besitzt) das Spiegelbild der oberen Hälfte hinzufügt. Dadurch erhält man eine die ganze Ebene ζ n fach bedeckende Fläche, welche $4n - 4$ einfache Verzweigungspunkte besitzt und welche sonach zu einer Klasse algebraischer Functionen gehört, für welche die Zahl $p = n - 1$ ist. (Theorie der Abel'schen Functionen Art. 7 und 12, S. 113, 119.)

Die Function ig ist nun der imaginäre Theil eines Integrals dritter Gattung, dessen Unstetigkeitspunkte in dem Punkt ε und in dem dazu conjugirten ε' liegen, und dessen Periodicitätsmoduln sämmtlich reell sind. Eine solche Function ist bis auf eine additive Constante völlig bestimmt und unsere Aufgabe ist somit gelöst, sobald es gelungen ist, die Function ζ von z zu finden.

Wir werden diese letztere Aufgabe unter der Voraussetzung weiter behandeln, dass die Begrenzung von S aus n Kreisen gebildet ist. Es können dabei entweder sämmtliche Kreise ausser einander liegen, so dass sich die Fläche S ins Unendliche erstreckt, oder es kann ein Kreis alle übrigen einschliessen, wobei S endlich bleibt. Der eine Fall kann durch Abbildung mittelst reciproker Radien leicht auf den andern zurückgeführt werden.

Ist die Function ζ von z in S bestimmt, so lässt sich dieselbe über die Begrenzung von S stetig fortsetzen, dadurch dass man zu jedem Punkt von S in Bezug auf jeden der Grenzkreise den harmonischen Pol nimmt und in diesem der Function ζ den conjugirt imaginären Werth ertheilt. Dadurch wird das Gebiet S für die Function ζ erweitert, seine Begrenzung besteht aber wieder aus Kreisen, mit denen man ebenso verfahren kann, und diese Operation lässt sich ins Unendliche fortsetzen, wodurch das Gebiet der Function ζ mehr und mehr über die ganze z -Ebene ausgedehnt wird.

[...]

This last paragraph is the one where Klein identifies (by Riemann) early examples of “automorphic functions” (compare Quote 6.7).

15.2 Painlevé’s problem (Painlevé 1888, Ahlfors 1947, . . . , Tolsa 2003)

This connection is first explored in Ahlfors 1947 [16]. The point of departure is Painlevé 1888 [631] concerned with generalizations of Riemann’s removable singularity theorem. When does all bounded analytic functions defined in the vicinity of a compactum extends across the compactum? Riemann’s theorem settles the removability of singletons.

⁵Gabard micro-comment: Here the last edition of Riemann’s Werke contains a little misprint F instead of the obvious T , not present e.g., in the French translation of Riemann by Laugel, Paris 1898.

A necessary and sufficient condition for removability is the vanishing of a certain numerical invariant directly attached to the Ahlfors function, the so-called *analytic capacity*. This is nothing but the maximum possible distortion $|f'(\infty)|$ measured at infinity among all analytic functions defined on the complement of the compactum and bounded-by-one there. This characterization (due to Ahlfors 1947 [16]) is not regarded as a satisfactory solution to Painlevé problem requiring a purely geometric (quasi-optical) recognition procedure of removable sets. If the compact set lies on a rectifiable curve of the plane, removability is tantamount to zero length (Denjoy’s conjecture 1909 [205], initially a theorem which turned out to be “gapped”, but confirmed via Calderón 1977 [131] in Marshall [525]). In the general case, Vitushkin proposed a characterization via “invisible sets”, those sets having orthogonal projections of zero Lebesgue measure along almost all directions. Verdera 2004 [845] explains brilliantly a metaphor with ghost objects virtually impossible to photography. Alas, Vitushkin’s expectation turned out to be not entirely correct cf. Jones-Murai 1988 [400] for a counterexample, yet it gives already an approximate idea of the whole problem. For instance, the prototypical example is the *one-quarter Cantor set*: a unit-square subdivided in $4 \times 4 = 16$ congruent subsquares whose only 4 extreme “corner-squares” are kept, with this operation iterated ad infinitum. The resulting Cantor set turns out to be removable (Garnett 1970 [283]), but has positive (Hausdorff) length since its projection on the line of slope 1/4 fills a whole interval. Here the 1/4-slope photography of the set is Lebesgue massive (hence “visible”), yet most other projections give sets of zero measures, in accordance with the removability of the set. Of course Garnett argues otherwise using in particular the classic analytic theory of Ahlfors-Garabedian.

The Painlevé problem involved many intense investigations (Painlevé, Denjoy, Urysohn, Besicovitch, Ahlfors 1947, Ahlfors-Burling 1950, Vitushkin, Garnett, Melnikov, Calderón, G. David, and many others up to its ultimate solution in Tolsa 2003 [834], blending a vast array of technologies (Melnikov’s Menger curvature, stopping processes à la Carleson already involved in the corona, etc.)

As a naive question how much of this theory extends to Riemann surfaces, using say Ahlfors 1950 [17] instead of Ahlfors 1947 [16]. [06.11.12] Of course it may be argued that most compactums of interest are phagocyttable in a chart or a schlichtartig region hence planar via Koebe’s theorem. However it may seem that non planar compactums exist as well on Riemann surfaces? What is the simplest example if any? Of course I certainly miss(ed) something trivial. A naive example is to take the 1/4-Cantor set and project it down to the torus $\mathbb{R}^2/\mathbb{Z}^2$, but of course the latter set may be planarized again!

15.3 Type problem (Kusunoki 1952)

In a 1952 paper [488], Kusunoki found a clever application of the Ahlfors function to the type of open Riemann surfaces. Beware that the type of open Riemann surfaces is here understood in the analytic sense due the Finnish school (Myrberg 1933, Nevanlinna 1941 [610]) of having a Nullrand.

More precisely, Nevanlinna 1941 (*loc. cit.*) introduced a notion of surfaces with *null-boundary* (Nullrand). This amounts to exhaust the open Riemann surface by compact subregions F_n , while solving via Dirichlet (rescued by Schwarz, Hilbert, etc.) the boundary problem ω_n equal 0 on $\Gamma_0 = \partial F_0$ and equal to 1 on $\Gamma_n = \partial F_n$. As the subregions F_n expand to infinity, two scenarios are possible:

- either the ω_n converges to 0, or
- the sequence ω_n converges to a positive harmonic function, ω .

Definition 15.2 *In the first case, the open Riemann surface F is said to have null-boundary, and in the second case to have positive boundary.*

Null-boundary is equivalent to having no Green’s function, or a recurrent Brownian motion. More relevant to Kusunoki’s work is Nevanlinna’s equivalent formulation in terms of the convergence to 0 of the Dirichlet integral $d_n = D[\omega_n]$.

Now, Kusunoki proves the following estimate (yielding a null-boundary criterion in case the right hand-side explodes to infinity):

Lemma 15.3 (Kusunoki, 1952)

$$\frac{1}{2\pi\lambda_n} \log \frac{1}{\bar{r}_n} \leq \frac{1}{d_n},$$

where $\lambda_n \leq r_n + 2p_n$ is the degree of an Ahlfors function $f_n: F_n \rightarrow D$ and \bar{r}_n the maximum value of f_n achieved on the Anfangsbereich F_0 of the exhaustion.

As far as the writer can appreciate Kusunoki's argument, it does not seem to use in any fundamental way the extremal property of the Ahlfors function. Thus perhaps any circle map (of possibly lower degree, e.g. $\leq r_n + p_n$ via Gabard 2006 [255]) accomplishes the job as well. This option is also corroborated by the fact that Kusunoki also appeal to Bieberbach 1925 [97] where no extremal property is put in the forefront. Accordingly there is some hope to derive a sharper Kusunoki's estimate. Of course the magnitudes r_n will change during the process so the real bonus is hard to quantify.

15.4 Carathéodory metric (Carathéodory 1926, Grunsky 1940, etc.)

Cf. for instance Grunsky 1940 [317, p. 232, §3], Burbea 1977 [123].

15.5 Corona (Carleson 1962, Alling 1964, Stout 1964, Hara-Nakai 1985)

In Alling's paper (1964 [34]) the explicit degree bound $r + 2p$ of the Ahlfors function is *not* employed. In fact an "innocent" circle map (of finite degree and not necessarily solving the Ahlfors extremal problem) suffices to transplant the truth of Carleson' corona theorem from the disc to any finite bordered Riemann surface. Hence assuming that Ahlfors circle map theorem is really involved to prove, or speculating that a very apocalyptic earthquake destroys simultaneously all the ca. 13 proofs presently available, it is still the case that Alling/Stout extension of the corona persists all such crashes. In fact recall that Köditz-Timmann 1975 [470] prove existence of a circle map (via a Behnke-Stein approximation theorem) without any control on the degree of the map. This weak version of Ahlfors would be enough to complete Alling's proof.

In sharp contrast, the paper Hara-Nakai 1985 [333] exploits fully Ahlfors bound $r+2p$ for the finer *corona problem with bound*. Hence the obvious problem is whether one can produce better corona bounds using circle maps of lowered degrees (e.g. those in Gabard 2006 [255]). What probably plagues the game is that even in the disc case sharp estimation of the best corona constant is still an open difficult matter. Cf. e.g. Treil 2002 [836], where the best upper estimate of Uchiyama 1980 (Preprint) is supplemented by a lower bound improving one of Tolokonnikov 1981.

Literature includes:

- For the disc: Carleson 1962 [154], Hörmander, Gamelin 1980 [272] (Wolff's proof), Garnett's book 1981 [285], etc.
- For bordered surfaces: Alling 1964 [34], Hara-Nakai 1985 [333], Oh 2008 [616].

15.6 Quadrature domains (Aharonov-Shapiro 1976, Sakai 1982, Gustaffson 1983, Bell 2004, Yakubovich 2006)

This is another discipline bearing deep connections with the Ahlfors function. For instance Aharonov-Shapiro 1976 [11] prove that Ahlfors maps associated to quadrature domains are algebraic. Combining this and works by Gustafsson 1983 [327], Bell 2005 [71] arrives at the striking conclusion: "It is proved

that quadrature domains are ubiquitous in a very strong sense in the realm of smoothly bounded multiply connected domains in the plane. In fact they are so dense that one might as well assume that any given smooth domain one is dealing with is a quadrature domain, and this allows access to a host of strong conditions on the classical kernel functions associated to the domain.”

Compare also Yakubovich 2006 [893], and the reference therein.

15.7 Steklov eigenvalues (Fraser-Schoen 2010, Girouard-Polterovich 2012)

Compare the paper by Fraser-Schoen 2010–11 [249] where for the first time the Ahlfors map is applied to spectral theory. Of course the basic trick of conformal transplantation is akin to the closed case (Yang-Yau 1980 [898]), yet in the bordered case it seems that the Ahlfors map respect precisely what should when it comes to take care of the Neumann boundary condition. In this respect the Fraser-Schoen contribution looks extremely original.

Building upon a paper of Payne-Polya-Schiffer, Girouard-Polterovich 2012 [291] where able to extend the estimates to higher eigenvalues.

15.8 Other (Dirichlet-Neumann) eigenvalues (Gabard 2011)

Inspired by Fraser-Schoen exciting paper, I also tried the game with the modest arXiv note Gabard 2011 [256], where the second inequality of Hersch 1970 [372] is adapted to configurations of higher topological structure. Note that the other two remaining inequalities of Hersch are probably likewise extensible (involving the quadrant and octant of a sphere).

16 Virtual applications of the Ahlfors map

Those are only dreamed applications of Ahlfors maps, i.e. topics bearing only vague analogy to our main focus.

16.1 Filling area conjecture (Loewner 1949, Pu 1952, Gromov 1983)

This was already discussed in the Introduction. We wonder whether the FAC is also meaningful (and true) for non-orientable membranes. Imagine a hemisphere surmounted by a microscopic cross-cap (over a “glass-of-wine shaped” protuberance at the north pole).

Another option is to generalize Gromov’s problem to membranes filling several contours (as suggested by J. Huisman ca. Sept. 2011). Arguably, a disjoint union of hemispheres is the best filling, at least when the contours are completely insulated (at infinite distance). Perhaps specifying some finite distance-functions $\rho_{i,j}$ between each pair of circles one can expect a least area connected filling (without shortenings), but I have presently no clear view on how to pose properly such generalized problem.

16.2 Open Riemann surfaces embed in \mathbb{C}^2 (Narasimhan, Gromov, Slovenian school, etc.)

The Slovenian school of complex geometry (Černe, Forstnerič, Globevnik, etc.) are also frequently employing the Ahlfors function. One among the most notorious elusive open problem (Narasimhan, Gromov, Forstnerič, Wold, etc.) is whether any open Riemann surface embeds properly in \mathbb{C}^2 .

In Forstnerič-Wold 2009 [247], the full problem is reduced to the finitistic question as to whether *each compact bordered Riemann surface F embeds holomorphically in the plane \mathbb{C}^2 .*

[06.11.12 (based on ideas of ca. Sept. 2011)] Such an embedding is possible whenever the corresponding real curve C (namely the Schottky double of F)

admits a *totally real pencil of lines*. This is for instance the case for Klein’s Gürtelkurve (any real plane quartic with 2 nested ovals). Fig. 50 below provides plenty of other baby examples. Indeed in this situation (total pencil of lines) the corresponding projection is totally real and the allied morphism $C \rightarrow \mathbb{P}^1$ induces a continuous map between the imaginary loci, i.e. $C(\mathbb{C}) - C(\mathbb{R}) \rightarrow \mathbb{P}^1(\mathbb{C}) - \mathbb{P}^1(\mathbb{R})$. It follows that an imaginary line of the pencil cuts the curve C *unilaterally* (i.e. only along one half of the orthosymmetric Riemann surface). Removing such an imaginary line from $\mathbb{P}^2(\mathbb{C})$ provides a replica of \mathbb{C}^2 containing entirely the original bordered surface F . This simple method fails miles-away from giving the full Forstnerič-Wold desideratum. Indeed Ahlfors theorem (1950 [17]) only implies existence of a totally real pencil but a priori involving auxiliary curves of order higher than one. On the other hand when starting from the abstract bordered surface (and its double) we may have first a projective model in \mathbb{P}^3 , which projected down to the plane \mathbb{P}^2 may develop singularities. Hence the model in question is only immersed in general. Our naive approach only helps grasping the notorious difficulty of the question, yet still permits to settle a limited collection of special cases. Actually the method, requiring a totally real pencil of lines, applies only to real dividing smooth curves of degree $m = 2k$ having a deep nest of profundity k (that is, higher order avatars of the Gürtelkurve).

Another classical idea was to exhibit the required embedding $F \hookrightarrow \mathbb{C}^2$ via a suitable pair of Ahlfors circle maps (not necessarily extremals) This works in special cases, e.g. hyperelliptic configurations cf. Černe-Forstnerič 2002 [166]. See also the related paper Rudin 1969 [723]. Maybe more sophisticated variants of Ahlfors maps arising in the broader Pick-Nevanlinna context could do the job, but looks extremely delicate.

Yet another natural strategy was to embed one representant in each topological type (this is actually possible by Černe-Forstnerič 2002 [166, Theorem 1.1]) and try to use a continuity argument inside Teichmüller (moduli) space as suggested in Forstnerič-Wold [247].

[06.11.12 (reported)] Another little puzzle is whether there is a connection with (Gromov’s and probably others) question as to whether any Riemannian surface embeds isometrically in Euclidean 4-space E^4 . (Compare Gromov 1999 [306] delightful preprint “Spaces and questions”). This is perhaps even unsettled in the compact orientable case. Via a bordered version of that conjecture, we can probably embed our Riemann surface F (equipped with a conformal Riemannian metric) in E^4 isometrically hence conformally. The desideratum should follow?

16.3 Pick-Nevanlinna interpolation

Compare the paper Jenkins-Suita 1979 [393].

17 Starting from zero knowledge

As yet the text was mostly historiographical, but from now on our intention was to elevate to the higher sphere of complete mathematical arguments. The success will be very limited, and we apologize for all inconveniences.

17.1 The Harnack-maximal case (Enriques-Chisini 1915, Bieberbach 1925, Wirtinger 1941, Huisman 2001)

As is well-known the theorem of Ahlfors (existence of circle maps) is easier in the planar case (and due in this case to Riemann-Schottky-Bieberbach-Grunsky, etc.). Using the corresponding Schottky double which is a real curve (of Harnack maximal type), the assertion follows quite immediately from Riemann-Roch (Riemann inequality) via a simple continuity argument. This argument is implicit in Enriques-Chisini 1915 [225] (probably even in Riemann 1857/58 manuscript [687]), and was then rediscovered by many people including Bieberbach 1925 [97], Wirtinger 1942 [891], Johannes Huisman 1999/01 [382], and

myself Gabard 2006 [255]. The nomenclature *Bieberbach-Grunsky theorem* used say by much of the Japanese school (e.g. A. Mori 1951 [570], etc.) is thus slightly jeopardized.

Lemma 17.1 (Riemann 1857/8, Schottky (\pm), Enriques-Chisini (\pm), Bieberbach 1925, Wirtinger 1942, etc.) *Given a planar bordered Riemann surface with r contours there is a circle map of degree r . Moreover the fibre over a boundary point may be arbitrarily prescribed as a collection of points having one point on each contour.*

Proof. We double the surface to get a closed one of genus $g = r - 1$. On the corresponding Harnack maximal curve (i.e. $r = g + 1$), we pick one point p_i on each oval to get a divisor D_0 of degree $g + 1$. Riemann's inequality states $\dim |D| \geq d - g$, where $|D|$ is the complete linear system spanned by the divisor D and d is its degree. (This is Riemann-Roch without Roch, and follows easily from Abel's theorem.) Applied to our divisor $D_0 = \sum_{i=1}^{g+1} p_i$, we see that the latter moves in its linear equivalence class. We may thus choose in the linear system $|D_0|$ a line (classically denoted) g_d^1 , consisting of groups of $d = g + 1$ points. Subtracting eventual basepoints, this g_δ^1 ($\delta \leq d$) induces a totally real morphism to \mathbb{P}^1 , since by continuity the points p_i cannot escape their respective ovals. Indeed looking at Fig.16 while imagining one point evading from the real locus $C(\mathbb{R})$ another one must make an instant jump to locate himself symmetrically w.r.t. the symmetry σ induced by complex conjugation. By the trivial fact that a totally real morphism has degree $\geq r$, the final degree δ must be $g + 1 = r$.

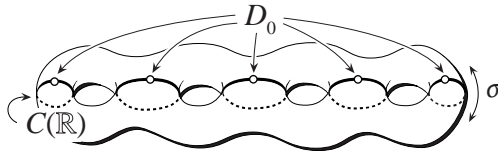

Figure 16: Totally real morphism in the Harnack-maximal case

■

17.2 Gabard's argument: circle maps of $\deg \leq r + p$

The basic principle used in Gabard 2006 [255] to prove existence of circle maps involves some topological stability of the embedding of a closed Riemann surface into its Jacobian via the Abel map. Philosophically, there is some topological stability of the Abel map making it quite insensitive to variations of the complex structure. This is essentially how we derived universal existence theorem valid for all Riemann surfaces with upper control on the degree of such maps.

We suspect that the same method (suitably adapted to closed surfaces) should recover the Riemann-Meis bound $\lfloor \frac{g+3}{2} \rfloor$ for the minimal sheet number required to concretize a genus g curve as a branched cover of the line $\mathbb{P}^1(\mathbb{C})$. (Compare Riemann 1857 [687] and Meis 1960 [541].) Yet we failed presently to write down the details.

[22.10.12] Let us recall briefly my argument so as to make apparent the structure of the proof quickly.

Theorem 17.2 *Given a bordered surface $\bar{F} = \bar{F}_{r,p}$ of type (r,p) , we can construct a circle map of degree $\leq r + p$.*

Proof. (Rapid sketch hence somewhat more readable, yet less reliable, than in the original paper Gabard 2006 [255].) Using the Schottky double, it is equivalent to find an unilateral divisor D (i.e. one contained in the interior denoted F) which is linearly equivalent to its conjugate D^σ . It follows indeed by a simple continuity argument that the pencil generated by those 2 divisors

D, D^σ is totally real, hence induces a circle map. (Compare Lemme 5.2 in Gabard 2006 [255].)

The problem is thus reduced to exhibit an unilateral divisor such that $D \sim D^\sigma$ (linear equivalence on the curve C manufactured by doubling \bar{F}). Using Abel’s map $\alpha: C \rightarrow J$ to the Jacobian (variety) this amounts to say that $\alpha(D)$ is a real point of the Jacobian. Looking in the quotient $J/J(\mathbb{R})$ this amounts to express zero as a sum of unilateral points. Taking any point x_d in F , we search points $x_i \in F$ so that

$$x_1 + \cdots + x_{d-1} = -x_d.$$

To solve this equation we use a principle of topological irrigation (subsumable to Brouwer’s theory of the mapping degree), but whose essence lies the periodicity behavior of the Abel map. Specifically, we know that α induces an isomorphism on the first homology. In a similar way the $r-1$ semi-cycles (linking one contour to the others) and the $2p$ cycles winding around the p handles form a basis of the first homology of the quotient $T^g := J/J(\mathbb{R})$, a g -dimensional (real) torus. The irrigation principle says that if we have g cycles representatives of a basis of the 1st-homology of a g -dimensional torus T^g then any point of the torus is expressible as the sum of at most g points situated on the given cycles. Applying this, we can solve the above equation for $d-1 \leq (r-1) + 2p$, i.e. $d \leq r + 2p$ recovering Ahlfors bound.

Now our points x_i are situated on curves traced in advance around the handles. This constraint is not inherent to our problem, where only unilaterality is required. Thus the points enjoy more freedom and this how we discovered (ca. 2002) the possibility of improving Ahlfors. More formally, we can imagine instead of the two cycles winding around a handle a 2-cycle having the shape of a 2-torus. The latter torus is not traced on our surface F , but a vanishing cycle operation makes the torus visible. This torus is interpreted as a cycle with stronger irrigating power. Summarizing, we have in the quotient T^g the $(r-1)$ semi-cycles and p many 2-tori of stronger irrigating power. An (evident) variant of the irrigation principle gives solubility of the above equation for $d-1 \leq (r-1) + p$, i.e. $d \leq r + p$ (Gabard’s bound). ■

Warning.—[06.11.12] Understanding the full details in some less intuitive manner occupies the last 7 pages of Gabard 2006 (*loc. cit.*). It is to be hoped that the $r + p$ result is correct, but one should not exclude that something is wrong in the final result (or at least that the proof is not convincing enough). Thus more investigations requires to be made to assess or disprove the above theorem. Of course the first part where I only recover Ahlfors’s bound $r + 2p$ seem less subjected to “corrosion”, because the irrigating cycles are readily traced on the bordered surface (without having to appeal to vanishing cycles, homologies, etc.).

17.3 Assigning zeroes and the gonality sequence

[22.10.12] Here we explore some little new ideas inspired by the irrigating method discussed in the previous section. Alas, details are a bit messy (mostly due to severe degradations of the little I knew about algebraic curves). Most propositions of this section thus suffer the plague of hypothetical character. We hope that, although our conclusions are extremely vague, the thematic addressed is worth clarifying. A general question of some interest is that of calculating for a given bordered surface the list of all integers arising as degrees of all circle maps tolerated by the given surface. We call this invariant the *gonality sequence*. Another noteworthy issue is that apparently Ahlfors upper bound $r + 2p$ is always effectively realized, in sharp contrast to Gabard’s one $r + p$ which can fail to be. Again we apologize that the sequel is not easy reading, but the problematic looks sufficiently interesting to justify a premature redaction.

In the above argument (proof of (17.2)) we may replace the point $x_d \in F$ by a collection of k points say $z_1, \dots, z_k \in F$. By the irrigation principle it is still

possible to solve the equation in the group $T^g = J/J(\mathbb{R})$

$$x_1 + \cdots + x_{d-1} = -(z_1 + \cdots + z_k)$$

for $d-1 \leq (r-1)+p$. Alas, if the divisor $z_1 + \cdots + z_k$ is linearly equivalent to its conjugate the right hand side vanishes in T^g , and all x_i could lie on the boundary of the semi-cycle (violating the unilaterality condition). However, in this case there is a circle map of degree k exactly given by the divisor $D = \sum_{i=1}^k z_i$. Thus, we can still conclude the following:

Proposition 17.3 (*Circle maps with assigned zeroes*) *Given any collection z_i of k points in a bordered surface \bar{F} of type (r, p) there is a circle map of degree $\leq (r-1) + p + k$ vanishing on the assigned points z_i .*

Proof. It must just be observed that the pencil through D, D^σ , where $D = x_1 + \cdots + x_{d-1} + (z_1 + \cdots + z_k)$ is basepoint free due to the unilaterality of this divisor. (This holds true even if some of the x_i or z_i come to coincide.) ■

It seems even that there exists circles maps of any degree $d \geq r + p$, but I am not sure about this point. Checking the truth of this requires the assertion that any point in the torus is expressible as the sum of the exact number of cycles available in the irrigating system. At first glance, this looks untrue in the trivial irrigating system for the flat 2-torus $\mathbb{R}^2/\mathbb{Z}^2$ consisting of the 2 factors. Yet the origin may be redundantly expressed as sum of two points. Idem for a point on the vertical axis, there is an expression as that point plus the origin. So maybe it works. The general (hypothetical) statement would be:

Lemma 17.4 (*Hypothetical lemma=Sharp irrigation principle*) *Given cycles $\gamma_1, \dots, \gamma_k$ of dimensions (say one and two, yet this is certainly not essential) in a g -torus T^g such that their Pontrjagin product $\gamma_1 \star \cdots \star \gamma_k$ represents the fundamental class of T^g . Then any point of T^g is expressible as the sum of k points x_i , one situated on each γ_i . (Some x_i may coincide.)*

Granting this we seem to get a sharper version of the previous proposition.

Proposition 17.5 (*Very hypothetical!!!*) *Given any collection z_i of k points in a bordered surface F of type (r, p) there is a circle map of degree exactly $(r-1) + p + k$ vanishing on the assigned points z_i . In particular there exists circles maps of any degree $d \geq r + p$.*

In fact the real problem is that our irrigating system involves the r semi-cycles on F (which close up into $J/J(\mathbb{R})$). If the sum involves points located on the boundary of those semi-cycles, then those points must be discarded to ensure unilaterality of the divisor. Thus our method gives only an upper bound on the degree of the final map, but never an exact control.

Basic examples shows that special Riemann surfaces may well admit circle maps of degree $d < r + p$ (cf. e.g. Fig. 49).

Definition 17.6 *Define the gonality $\gamma = \gamma(F)$ of a compact bordered Riemann surface F as the least possible degree of a circle map tolerated by F .*

Evidently $r \leq \gamma \leq r + p$ (the second estimate being Gabard's claim). One can ask if each value $d \geq \gamma$ above the gonality occurs as the degree of a circle map. Alas, the above irrigation technique fails close to imply this. Our guess is that the response is in the negative, that is, there may be "gaps" in the sequence of all circle mapping degrees.

Thus to detect a gap it is natural to look among "special" surfaces of small gonality in comparison to its generic value $r + p$. A rapid glance at the combinatorics of Fig. 50 (below) helps us identify the simplest such example as a hyperelliptic surface with $(r, p) = (2, 1)$. Then $\gamma = 2 < r + p = 3$. Borrowing an idea of Klein, we can think of the corresponding real curve as a doubled conic. This occurs actually via the so-called canonical mapping (of algebraic

geometry) which fails to be injective for hyperelliptic curves. (Note: we switch constantly from bordered surfaces to real dividing curves, committing off slight abuses of language.) Klein regards this doubled conic as a degeneration of the general Gürtelkurve (with two nested ovals) when both of them come to coalesce. This projective model of the hyperelliptic surface suggests that when projected from the doubled curve it has degree 2, but if the center of projection moves in the inside of the conic then the projection acquires degree 4 suddenly, without passing through the value 3. However substituting to the bordered surface this double conic is a bit fraudulent, e.g. because the latter is reducible and correspond rather to a disconnected Riemann surface. Also the doubled conic looks 2-gonal in ∞^1 ways whereas the original surface is uniquely 2-gonal. Thus another more reliable argument requires to be given. (This must probably be akin to the lemma proving uniqueness of the hyperelliptic involution.)

(★) If I remember well there is a lemma saying that any basepoint free pencil g_d^1 on a hyperelliptic curve is composed with the hyperelliptic involution g_2^1 . In other more concrete words, any morphism to the line factors through the hyperelliptic projection, and so has even degree. If this is correct, we see that Prop. 17.5 is **WRONG** while the gonality sequence is exactly the set of even integers $2\mathbb{N}$. This remark would equally applies to any hyperelliptic membrane with $r = 1$ or 2 , p arbitrary.

Note however that this conclusion conflicts with the Černe-Forstnerič claim (cf. 2002 [166]) that Ahlfors proved for any surface existence of a circle map of degree $r + 2p$ exactly (take r odd equal to 1).

Of course the mistake is mine and to be found in the parag. (★) right above, as shown by the following example.

Example 1. Consider for instance a quartic with one node (so genus is 2). This is hyperelliptic (alias 2-gonal) when projected from the node. However the curve also admits maps to the line of degree 3 (projection from a smooth point). It is interesting to manufacture a real picture. This gives the picture nicknamed 112 on Fig. 17 deduced via sense-preserving smoothings of both ellipses (ensuring the dividing character of the resulting curve by Fiedler 1981 [235]). The dashed circle indicates the node left unsmoothed. To avoid any mysticism, we should declare that our nicknaming coding consist in writing the 3 invariants r, p, γ as the string $rp\gamma$.

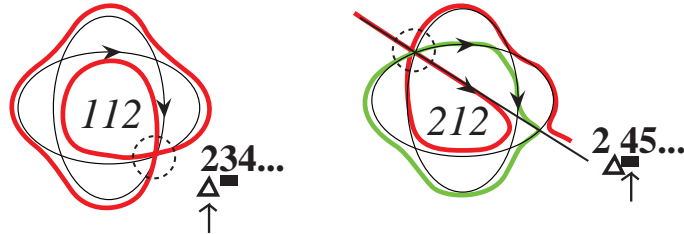

Figure 17: Towards detecting gaps in the gonality sequence

On it we see that there is total morphisms (i.e. with totally real fibers over real points) of degree 2 (projection from the node), of degree 3 (projection from the inner loop) and of degree 4 (projection from the inside of the inner loop). Switching to the corresponding bordered surface we get circle maps of the same degree, namely 2,3,4. One would like to know if 5 is also the degree of a circle map, etc. [We believe the answer to be positive: Ahlfors proves that there is always circle maps of degree exactly $r + 2p$, and of all higher values as well as follows from his convexity argument.] In conclusion this example seems to have the following gonality sequence $\gamma = 2 = r + p, 3 = r + 2p, \dots$ where the dots means that all higher gonality occurs after Ahlfors bound. Of course this is a bit notationally messy, and so we tried to introduce a system on the figure, where the gonality sequence $234\dots$ is decorated by a triangle for $r + p$, an underlining of Ahlfors bound $r + 2p$ (after which the gonality sequence is full, and the arrow indicating the least position from where the sequence ultimately turns out to

be full). Note that the given example does *not* confirm our initial guess about gaps in the gonality sequence. Hence let us look at another example.

Example 2. Another instructive experiment is to consider a hyperelliptic model of type $(r, p) = (2, 1)$. Then the genus g of the double is $g = (r - 1) + 2p = 1 + 2 = 3$. This prompts looking at plane smooth quartics which have the right genus 3, but alas the wrong gonality 3 (not 2). Thus we move to quintics (“virtual” smooth genus 6) and to go down to $g = 3$ we introduce one triple point (counting like 3 double points since perturbing slightly 3 coincident/concurrent lines creates 3 ordinary nodes). We obtain so the correct gonality 2 (as $5 - 3$). Doing a real picture one may draw the picture numbered 212 on Fig. 17. (Keep in mind that we always smooth in an orientation consistent way to ensure the diving orthosymmetric character of the curve). It has $r = 2$, and $p = [g - (r - 1)]/2 = 1$. We notice that there is total maps of degrees 2 (projection from the “tri-node”=triple point), degree 4 (projection from the inner circuit) and degree 5 (projections from the inside of this inner circuit). Yet we miss degree 3. Over the complex such a curve is not 3-gonal (because it is 2-gonal from the tri-node and 4-gonal when projected from a smooth point). Consequently, the allied bordered surface has circle maps of degrees 2,4,5 but not 3, which is missing. Hence this example probably corrupts our naive Prop.17.5. In other words, Gabard’s bound $r + p$ needs *not* to be exactly the degree of a circle map. Further more this example shows that the gonality sequence contains gaps in general.

Now one general question is to wonder what can be said about the following invariant.

Definition 17.7 *The gonality sequence $\Lambda = \Lambda(F)$ consists of the ordered list $\gamma < \gamma_1 < \gamma_2 < \dots$ of all values occurring as degrees of circle maps tolerated by a fixed bordered Riemann surface F , say of type (r, p) .*

Although quite primitive, fragmentary information includes the following facts, gathered as a theorem. (To nuance the reliability level of the varied constituents we assign them some percentages indicating their truth likelihood, adopting admittedly a very some Schopenhauer-style scepticism!)

Theorem 17.8 *Given any bordered Riemann surface with topological invariant (r, p) (viz. number of contours r and genus p) and gonality γ (i.e. the least degree of a circle map), we have the following estimates:*

- [100%] • (T) (Trivial) $r \leq \gamma$.
- [99%] • (KTA) Λ is non empty or equivalently $\gamma < \infty$ is finite (Ahlfors 1950 [17], albeit Teichmüller 1941 [826] credits Klein for the result?!, cf. also Köditz-Timmann 1975 [470] for a proof via Behnke-Stein).
- [100%] • (Semigroup property) the set Λ is “multiplicative”, i.e. whenever it contains an element $\lambda \in \Lambda$ it contain also all its integral multiple $k\lambda$. (This follows just by composing the corresponding circle map by a power map $z \mapsto z^k$ from the disc to itself.) In particular it follows from (KTA) that Λ is always infinite.
- [98%] • (A50) (Ahlfors 1950) $\gamma \leq r + 2p$.
- [75%?] • (G06) (Gabard 2006) $\gamma \leq r + p$.
- [75%?] • (C11) (Coppens 2011) γ takes all intermediate values $r \leq \gamma \leq r + p$ (if $r = 1$ the lower bound r must be modified as 2, excepted when $p = 0$).
- [97%] • (ACF) (Ahlfors 1950, as interpreted in Černe-Forstnerič 2002 [166]) Ahlfors bound $r + 2p \in \Lambda$ always belong to the gonality spectrum; and so did all higher values.

Proof. The last assertion follows from Ahlfors proof (1950 [17, pp. 124–126]) where the origin is expressed as a convex sum of points situated on a collection of circuits in \mathbb{R}^g . This is always possible for $g + 1 = r + 2p$ points, and a fortiori for more points. (We shall later on try to digest Ahlfors argument in subsequent sections.) ■

In contrast Example 2 (=212 on Fig. 17) above shows (or at least indicates strongly) that Gabard's bound $r + p$ is not necessarily realized by the gonality sequence.

Some further evaluation of the gonality sequence are tabulated on Fig. 50 as bold fonts. The underlined number is Ahlfors (universal) bound $r + 2p$, after which all gonalitys are realized. The position pointed onto, by a triangle, is Gabard's bound $r + p$. The little arrow is a pointer indicating the lowest integer after which the gonality sequence is full.

At an early stage of the tabulation, it seemed realist to advance the following.

Conjecture 17.9 (*Naive, destroyed by Example 4*) *Strictly above $r + p$ each gonality occurs.*

This is of course pure guess, but if true it would considerably lower Ahlfors' universal lower bound $r + 2p$ for "fullness". The next example still supports the guess, but the next Example 4 seems to violate it.

Example 3. We consider within the topological type $(r, p) = (1, 2)$, where $g = (r - 1) + 2p = 4$, at a hyperelliptic model ($\gamma = 2$). Looking at quintics (virtual genus 6) requires 2 nodes to correct the genus, but then the (complex) gonality is still 3 (and not 2 as we would like). The trick is (like in Example 2) to increase further the degree to permit a high order singularity lowering drastically the gonality. So we move to sextics (virtual genus 10) with a 4-node (counting for 6 ordinary nodes) that decreases correctly the genus to 4. As initial configuration we consider 3 coincident lines plus a conic through the coincidence and another line (in general position). An appropriate smoothing generates picture 122 on Fig. 18 with $r = 1$ (all real circuits connects through ∞). The gonality sequence seems to be 2, 5, 6, ... However 4 must be added to the list (being a multiple of 2). Hence the true sequence is 2, 4, 5, 6, ... Gabard's bound is $r + p = 3$, and strictly above it all values are realized (Ahlfors bound is $r + 2p = 5$).

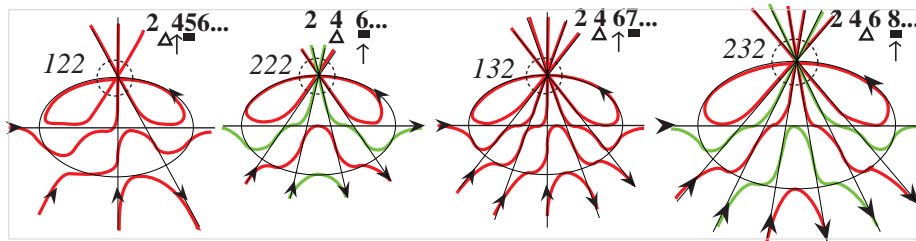

Figure 18: Some hyperelliptic curves and their gonality sequence. Those constructs are primarily intended to disprove the guess that above Gabard's bound $r + p$, all gonalitys arise. Yet, the real outcome is rather that for hyperelliptic curves one might be able to be completely explicit about the gonality sequence.

[23.10.12]—*Vague philosophy.* Some interesting feature of this example (122 on Fig. 18) is that when gonality is very low in comparison to topological complexity, the Riemann surface, after having dispensed much energy to reach such a low gonality, falls into some dormant state without creating many new gonalitys (missing the value 3). Perhaps this is a general phenomenon (prompted by a principle of energy conservation).

Example 4. We now consider, in the topological type $(r, p) = (2, 2)$ for which $g = (r - 1) + 2p = 5$, again a hyperelliptic model. Looking at sextics with smooth genus 10, we must use a correction term of 5 (alas this is not a triangular number as those involved in multiple points). Thus we move to septic (degree $m = 7$) of smooth genus $\tilde{g} = \frac{(m-1)(m-2)}{2} = 15$, and a 5-node (counting for $1 + 2 + 3 + 4 = 10$ ordinary nodes) effects the desired correction upon the genus. Smoothing a suitable configuration we get picture 222 on Fig. 18 with $r = 2$ (two real circuits red and green colored). The gonality sequence includes the values 2, 4, 6 = $r + 2p$, ... Six being Ahlfors bound the sequence is full

from there on. When projected from the 5-node the degree is 2. If we drag the center of perspective along one of the two red loops we get total maps of degrees $7 - 1 = 6$. The value 4 is not visible on the projective model, yet arises by the semigroup property. Studying the gonality over the complex, it seems evident that 3 and 5 are not even complex gonalitys, and we should be able to conclude that $2, 4, 6, \dots$ is the exact gonality spectrum. (Here the “dots” refer again to the issue that all higher values belong to the gonality list, according to Ahlfors.) But then our conjecture 17.9 is violated (as 5 do not belong the list). Incidentally, this example shows the sharpness of Ahlfors bound $r + 2p$ as the place from where the spectrum is full.

Example 5/6. Those examples can be iterated for higher values of the invariant (r, p) while staying in the hyperelliptic realm. The arithmetical issue is the possibility to compensate the genus by a high order singularity. We obtain for $(r, p) = (1, 3)$, hence $g = 6$, the figure 132, an octic (smooth genus 21) with a 6-node (counting for $(6 \cdot 5)/2 = 15$ ordinary nodes) hence lowering down the genus to 6. The gonality sequence is $2, 4, 6, 7 = r + 2p, \dots$. Similarly, for $(r, p) = (2, 3)$, $g = 7$. Browsing through increasing degrees the genus are $10, 15, 21, 28, \dots$, whereas the nodes give the list $1, 3, 6, 10, 15, 21, \dots$. The right pair is thus $28 - 21 = 7$. So we take a 9-tic (smooth genus $g = (9 - 1)(8 - 1)/2 = 56/2 = 28$) with a 7-node. We construct easily picture 232, a curve whose gonality sequence is $2, 4, 6, 8 = r + 2p, \dots$. (Note that in this case Ahlfors bound is sharp for the fullness of the sequence, but it was not in the previous example. It may again be observed that in the first example the $r + p$ bound occurs as a gonality, but it does not in the second example.)

The real outcome of these constructions is that for (certain, all?) hyperelliptic curves we can be totally explicit about the gonality spectrum. Iterating ad infinitum we have:

Proposition 17.10 *For any topological type (r, p) there is a surface of hyperelliptic type (r, p) (with $r = 1$ or 2) whose gonality spectrum Λ is known explicitly. Namely,*

- if $r = 1$, then $\Lambda = \{2, 4, 6, \dots, 2p, r + 2p, \dots\}$, where the first “dots” runs through even values and the second means fullness after Ahlfors bound $r + 2p$.
- if $r = 2$, then $\Lambda = \{2, 4, 6, \dots, r + 2p, \dots\}$, where the first “dots” runs through even values and the second means fullness after Ahlfors bound $r + 2p$.

The natural question is of course to know if this spectrum distribution is specific to our models or generally valid for all hyperelliptic surfaces. (This looks likely, we think, maybe just by counting moduli.)

17.4 A conjecture about fullness

[23.10.12] At this stage the situation is admittedly a bit messy. One can try to clarify the situation by bringing into the picture the *fullness invariant* φ , that it the least integer from where on the spectrum is full. (On the pictures discussed this is nothing but than the little arrow we used previously.) We have a string of inequalities:

$$r \leq \gamma \leq \begin{cases} \overset{Ga}{\leq} r + p \leq \\ \leq \varphi \leq \end{cases} \underset{Ah}{\leq} r + 2p \quad (3)$$

One can wonder if there is any comparison possible between $r + p$ and φ ? On Example 212 (of Fig. 50) $r + p = 3$ is smaller than the fullness $\varphi = 4$. Many examples on Fig. 50 satisfies $r + p \leq \varphi$, but there is also several counterexamples, e.g. Figures 313, 414 or 223.

The following is a trivial consequence of inequation $\gamma \leq \varphi$:

Lemma 17.11 *Fullness below Gabard’s bound (i.e. $\varphi < r + p$) implies low-gonality (i.e. $\gamma < r + p$).*

The converse fails, see Figures 212 or 222.

On the pictures of Fig. 50 the fullness φ is indicated by a little upward arrow. Looking at the examples of this figure it seems that when the surface has generic gonality (i.e. $\gamma = r + p$) then its fullness coincides with the gonality (i.e. $\varphi = \gamma$). It would be interesting to know if there is a general theorem behind this experimental observation.

Conjecture 17.12 (*Pressing up and down: fullness conjecture*) *If $\gamma = r + p$, then $\varphi = \gamma$. In other words if γ takes its maximum value (granting the truth of Gabard's bound!) then φ collapses to its minimum value (namely γ). In particular the gonality spectrum of a generic surface would be completely determined, as the full sequence starting from $r + p$. (This would also show that in general Ahlfors bound $r + 2p$ for the fullness of the spectrum can be drastically improved).*

Remark it seems plausible that an adaptation of Gabard 2006 could prove this conjecture. (Ahlfors original proof can also be useful.) The idea would be that in the irrigation method the equation $x_1 + \dots + x_{d-1} = -x_d$ which is soluble for $d \leq (r - 1) + p$ points is, by the assumption made on γ , not soluble for fewer points. One would then like to extend this "exact solubility" to the equation $x_1 + \dots + x_{d-1} = -(z_1 + \dots + z_k)$, where the z_i is a collection of points assigned in F . A vague idea is then that if some x_i (or their lift to \bar{F} belongs to the border) then upon dragging the z_i we may hope to displace them to avoid this circumstance (incompatible with unilaterality). This would construct an unilateral divisor of any assigned degree $\geq r + p$, implying in turn existence circle maps of all such degrees. The conjecture would follow.

Another interesting phenomenon is that even when two surfaces have the same invariants (r, p) and the same gonality γ their gonality sequence may differ. (See for such an example both figures 324). Interestingly the left figure 324 is 4-gonal in ∞^1 ways, whereas its companion 324bis, is 4-gonal in only 4 ways. Again it seems that a law of conservation is involved for all the energy absorbed by the many pencils of degree 4 living on the first model seems to provoke the missing of pencils of degree 6.

To investigate the fullness conjecture (17.12) further, we test curves of higher topological structure.

- For $(r, p) = (3, 2)$, we seek a surface with maximum gonality $\gamma = r + p = 5$. If we imagine this gonality arising via linear projection it is natural to look at a sextic having a deep nest. The virtual genus is then 10, but we want genus $g = (r - 1) + 2p = 2 + 4 = 6$. Thus we introduce 4 nodal singularities. To keep the gonality maximum those nodes must not be accessible from the inner oval, and consequently we distribute the dashed circles (indicating unsmoothed nodes) in the "periphery". We thus obtain curve nicknamed 325 (on Fig. 19). It has $\gamma = 5$ and the gonality sequence is $5, 6, 7 = r + 2p, \dots$. In fact γ could be < 5 via some nonlinear pencil harder to visualize. A pencil of conics with 4 basepoints matching with the 4 nodes creates a series of degree $2 \cdot 6 - 4 \cdot 2 = 12 - 8 = 4$, more economical than our 5. However looking at picture 325, the special conic consisting of two horizontal lines fails to intersect the inner oval. Thus this pencil is not total, and we safely conclude that $\gamma = 5$, exactly. In particular, the fullness conjecture (17.12) is verified on this example.

- For $(r, p) = (4, 2)$, we seek a surface with maximum gonality $\gamma = r + p = 6$. Imagine again this gonality arising via linear projection, we consider a septic with a deep nest. The virtual genus is then 15, but we want $g = (r - 1) + 2p = 3 + 4 = 7$, hence we conserve 8 nodal singularities. We obtain so the curve labelled 426 on Fig. 19. It has $\gamma = 6$ and the gonality sequence is $6, 7, 8 = r + 2p, \dots$. The fullness conjecture (17.12) seems verified on this example. Warning [25.10.12]: now the claim $\gamma = 6$ is possibly an optical illusion, for a pencil of cubics with basepoints assigned on the nodes has degree $3 \cdot 7 - 8 \cdot 2 = 21 - 16 = 5 < r + p$. If the latter is totally real then $\gamma \leq 5$, violating our claim $\gamma = 6$. Of course tracing pencil of cubics is not an easy game. Experience tell us that total pencils arises when basepoints are deeply rooted inside the deepest ovals. In the

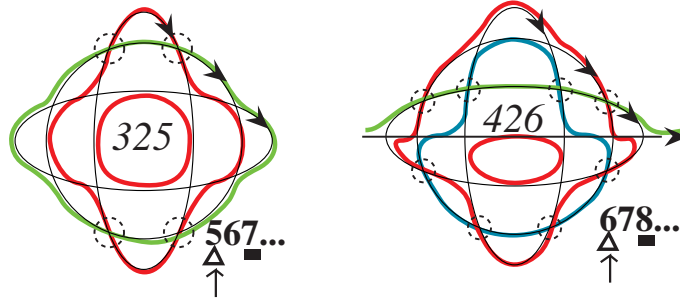

Figure 19: Testing the fullness conjecture

case at hand (curve 426), this feature is not fulfilled. The 8 basepoints of the cubics pencil lie outside the inner oval, yet, it could be that the 9th basepoint falls (by a lucky stroke) inside this oval. In fact, it is enough to observe that the cubic, consisting of the ellipse through the 6 points lying highest on figure 426, plus the line through the remaining 2 points (lying lowest on the same figure), fails to cut the inner oval. This gives evidence that our pencil of cubics is not total. We conclude $\gamma = 6$, exactly. In fact one must check that the 8 assigned basepoints impose independent conditions on cubics, and so our pencil is forced to contain the special reducible cubic just described. (Independence is checked by the usual stratification method, where one imposes more and more conditions while verifying that each extra condition imposes a real dropping of the dimension by checking that the corresponding inclusion is strict.) I think that the method applies to the case at hand, and we conclude $\gamma = 6$ (with reasonable self-confidence). Of course another details that must be more carefully studied is our somewhat tacit claim that the gonality (or the gonality sequence) do not depend tremendously on the choice of smoothing. The classical method (Brusotti, etc.) of small perturbation asserts existence of a curve effecting the assigned smoothings, but of course there is an infinity of choices for the coefficients. A priori the fine gonality invariants we are studying are sensitive to the choice effected. Remember that Brusotti's method relies on the fact that the initial curve thought of as a point in the discriminant hypersurface has a neighborhood consisting of several "falde analytice", i.e. a divisor with normal crossings each branch of which corresponding to the conservation of a certain node. This explains why we can smooth in a very liberal way the nodes of our initial configurations. Yet it is more hazardous to claim a smoothing conserving the exact location of all nodes. This additional remark looks convenient to complete the previous argument made on figure 426.

- We next test the invariants $(r, p) = (5, 2)$, and within it seek again a representative of maximum gonality $\gamma = r + p = 7$. Using the same device as above, we are inclined to look at an octic (degree $m = 8$) with an interior oval kept protected from intrusion of singularities. The smooth genus is then $\tilde{g} = \frac{7 \cdot 6}{2} = 21$ but need be lowered down to $g = (r-1) + 2p = 8$. We thus consider a distribution of 13 nodes distant from the inner oval and we produce the curve nicknamed 337 (on Fig. 50, see also Fig. 20 for a larger depiction). This curve has $r = 3$ (not 5 as desired!). This means that I am a bad experimentalist, but the curve 337 is worth looking at closer. Since $g = 8$ by construction, and $r = 3$ we have $p = 3$ (recall $p = [g - (r - 1)]/2$). When projected from a point on the inner oval the curve is 7-gonal. This degree is *larger* than Gabard's bound $r + p = 6$!!! The example seems to violate Gabard's bound $r + p$.

Summary: While trying to test the fullness conjecture, we rather arrived to a counter-example to Gabard's estimate $\gamma \leq r + p$. We thus switch slightly of game, but try to keep in mind the fullness problem for later.

17.5 Potential counterexamples to Gabard 2006 ($\gamma \leq r+p$)

[24.10.12] The curve just discussed (337) seems to be a potential violation of the theorem $\gamma \leq r+p$ asserted in Gabard 2006 [255]. Can we solve this unpleasant “paradoxical” situation? Either Gabard’s bound $r+p$ is false or something wrong happened. A probable phenomenon is that we were too cavalier when claiming that $\gamma = 7$ (in fact the total line pencil on curve 337 just shows that $\gamma \leq 7$). A priori there might be optical illusion about evaluating the gonality. For instance imagining our octic with 13 nodes swept out by a pencil of cubics with 9 base points located on the nodes gives a linear series of degree $3 \cdot 8 - 9 \cdot 2 = 24 - 18 = 6$, rescuing the $r+p = 6$ bound. Of course, it is another story to convince that such a map can be chosen total! Thus 337 still represents a severe aggression against $\gamma \leq r+p$.

Similar counterexamples (be they illusory or real) can be manufactured in lower topological complexity. Starting with a configuration of 3 conics, we conserve the deep nest, but keep the maximum number of singularities in the periphery so has to lower the genus as much as possible. Keeping 7 nodes unsmoothed, but smoothing all others crossings in a sense-preserving way (so as to ensure the dividing character of the curve), we obtain the curve 215 with $r = 2$ (cf. Fig. 20). Its genus is $g = 10 - 7 = 3$. Thus the genus of the half (complex locus split by the real one) is $p = [g - (r - 1)]/2 = (3 - 1)/2 = 1$. Projecting from the interior oval gives ∞^1 total maps of degree 5, and the hasty guess is that $\gamma = 5$. Since $r+p = 3$, Gabard’s bound $\gamma \leq r+p$ looks again violated.

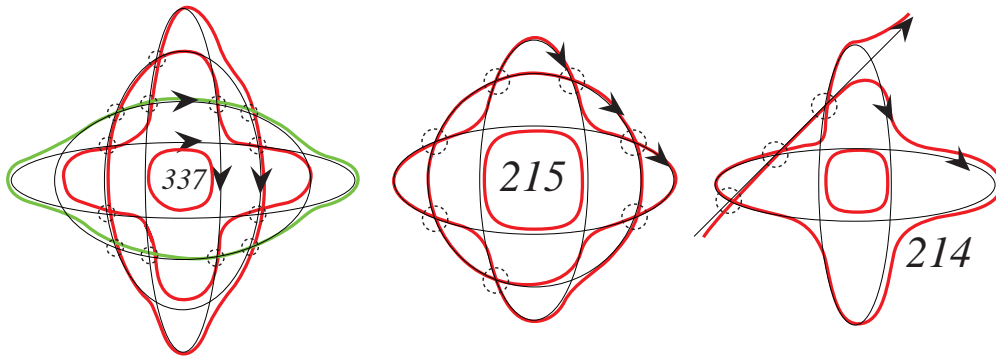

Figure 20: (Pseudo?)-counterexamples to Gabard’s bound $r+p$

However the curve at hand (215) having $g = 3$ (and being dividing), elementary knowledge of Klein’s theory prompts that the canonical map $C \rightarrow \mathbb{P}^{g-1}$, here \mathbb{P}^2 , will exhibit the curve as a “Gürtelkurve”, i.e. a quartic with two nested ovals. Then the gonality is reevaluated as $\gamma = 3$, and Gabard’s theorem is vindicated again (by the rating agency!).

Another way to argue, would be to take a pencil of cubics with 7 basepoints assigned on the 7 nodes and another basepoint on the curve. The degree is then $3 \cdot 6 - 7 \cdot 2 - 1 \cdot 1 = 18 - 14 - 1 = 3$. The bound $r+p$ looks rescued again. Yet some hard work is required to check total reality of a suitable pencil. Perhaps there is some conceptual argument, else one really requires tracing carefully the pencil after an educated guess of where to place the extra assigned basepoint.

It is even possible to construct a quintic with “visual” gonality exceeding $r+p$. The cooking recipe is the same as above. We start from a configuration of 2 conics and one line, keep the inner oval while maximizing the number of peripheral singularities. It results picture 214 on Fig. 20. We see that $r = 2$. The genus is $g = 6 - 3 = 3$ (3 nodes must be subtracted), and thus $p = 1$. The apparent (naïve) gonality seems to be 5, exceeding (and thus violating) Gabard’s bound $r+p = 3$. Again to resolve the paradox one can either argue via the canonical map supposed to take the curve to a Gürtelkurve, or find a total linear series of lower degree. Here this would involve a pencil of conics through the 3

nodes plus one assigned basepoint inside the deep oval. The resulting series has degree $2 \cdot 5 - 3 \cdot 2 - 1 \cdot 1 = 10 - 6 - 1 = 3$, in agreement with the $r + p$ bound.

A drawback of figure 214 is that the 3 remaining nodes are nearly collinear, rendering nearly impossible the depiction of the conics pencil. (In reality the 3 nodes are not collinear, otherwise the line through them would cut the quintic in 6 points.) It is convenient to consider rather a related quintic 214bis on Fig. 21, where the line has penetrated the inner oval (yet without destroying it). All invariants r, g, p (as well as the naive gonality) keeps the same value as on the previous example 214. On the new curve it is easier to trace a total series cut out by a pencil of conics (where the extra basepoint has been chosen in the most symmetric way). Each member of it has beside the 4 assigned basepoints (counting for $3 \cdot 2 + 1 \cdot 1 = 7$ intersections) 3 moving points which are permanently all real (as follows only (??) through patient contemplation of the pencil).

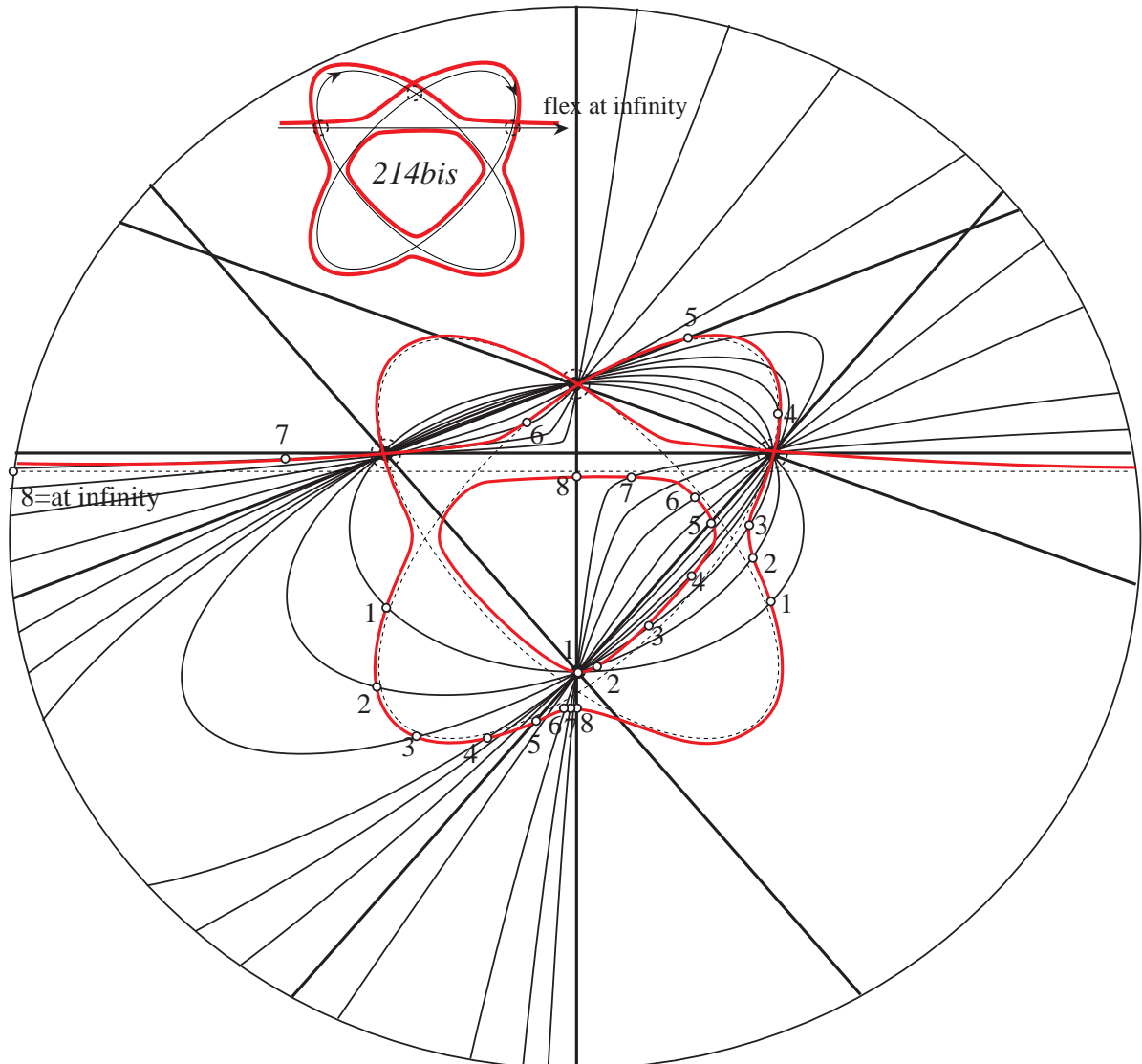

Figure 21: Constructing a total pencil of conics on a quintic

Fig. 21 attempts to show various members of the conics pencil, as well as the 3 mobile points of the series. Those sections are depicted by the same letters e.g. 1,1,1 corresponds to the section by the ellipse invariant under symmetry along the vertical axis. Ultimately, the whole figure has to be extended by this symmetry, but this is better done mentally so as to not surcharge the figure. The dynamics (circulation) is quite tricky to understand, but note that the motion is much accelerated (hence hard-to-follow) when the (red) curve crosses the basepoints of the pencil. This is a bit if the particle motion would be much accelerated by a gravitational black hole. Once the picture is carefully analyzed,

it is evident that all 3 mobile points stay permanently real. Thus our quintic curve has gonality $\gamma \leq 3$. (Gabard's theorem is rescued on this simple example.)

Perhaps similar miracles (via high order pencils hard-to-visualize) produce for all other pseudo-counterexamples to $\gamma \leq r + p$. Yet this probably requires considerable work even just for the previous curves (of Fig. 20). In full generality a divine act of faith is required to imbue with chimeric respect the last vestiges of truth imputable to Gabard's result. Note that pencil of cubics are required for the examples (Fig. 20): even our sextic with 7 nodes achieves, via conics, only gonality $2 \cdot 6 - 4 \cdot 2 = 4$, not as economic as the $r + p$ bound.

Summary. Two scenarios are possible: either Gabard's (pseudo)theorem $\gamma \leq r + p$ is false (which is not quite improbable as its proof is intricate and there is an infinite menagerie of potential counterexamples), or it is true in which case it might be proved extrinsically by a highbrow extension of the last example described (Fig. 21). This brings us to the next section, which albeit not very tangible in our fingers is perhaps technically implementable (at least at the level of Ahlfors bound).

17.6 Brill-Noether-type (extrinsic) approach to Ahlfors via total reality

[26.10.12] Killing all virtual counterexamples (of the previous section) to $\gamma \leq r + p$ amounts essentially to imagine a sort of high-powered Brill-Noether theory for totally real pencils able to reprove Ahlfors theorem $\gamma \leq r + 2p$ (and then optionally to corroborate Gabard's $\gamma \leq r + p$) in a purely synthetic way (assuming the latter to be correct at all). This section discusses very superficially this grandiose programme (albeit we are quite unable to complete it).

Definition 17.13 (*Convention*) *Below and in the sequel, we shall often say just total morphism instead of totally real morphism.*

[26.10.12] Let us be more explicit. As we know any smooth projective curve (or, what is the same, closed Riemann surface) embeds in \mathbb{P}^3 , and a generic projection will realize the curve (like a knot projection) as a nodal model in the plane \mathbb{P}^2 having at worst ordinary double points. Specializing this to real (orthosymmetric) curves, we get a model in the plane. On it one can hope to first prove existence of a total pencil, and then evaluate the least degree of such a pencil. This will essentially amount to consider adjoint curves passing through the nodes so as to lower most the degree. The procedure would be as follows.

Let F be a bordered Riemann surface of invariant (r, p) . We consider its Schottky double $C = 2F$, interpreted as a real orthosymmetric curve of genus $g = (r - 1) + 2p$ with r real circuits. Using a generic immersion in the plane we find a model Γ_m of the curve C_g of degree m having r real circuits, and a certain number of nodes δ . For simplicity we assume the nodes to be simple (but the more general situation must perhaps not be excluded). We have of course $g = \frac{(m-1)(m-2)}{2} - \delta$. Let Δ be the divisor of double points of Γ_m . (Those can occur in conjugate pairs under complex conjugation.) We consider in the complete linear system $|kH| := |\mathcal{O}_{\mathbb{P}^2}(k)|$ of all curves of degree k , a linear pencil L of curves passing through the nodes Δ of Γ (adjunction condition). The resulting series has degree $\leq k \cdot m - 2 \cdot \delta$. In fact a better control must be possible. First k has to be chosen large enough so that the adjunction condition is possible at all. Since $\dim |kH| = \binom{k+2}{2} - 1$, the integer k is chosen as the least integer such that this dimension exceeds δ . Then we may have some excess permitting to assign other (simple) basepoints.

Let us be even more explicit (we work first over the complex, for simplicity). So assume given C a curve of genus g . We look first at the canonical embedding $\varphi: C \rightarrow \mathbb{P}^{g-1}$. The image curve has degree $2g - 2$. We manufacture a plane model via successive projection from points chosen on the curve. This has the net effect of lowering the degree by one unit after each projection. We arrive ultimately at a nodal model $\Gamma_m \in \mathbb{P}^2$ of degree $m = (2g - 2) - [(g - 1) - 2] = g + 1$.

Experimental study or an inspired guess suggests considering adjoint curves of degree $k = m - 3$. This value is calibrated so that our k -tics have enough free parameters to pass through all δ nodes of Γ . Indeed

$$\begin{aligned} \dim |kH| &= \binom{k+2}{2} - 1 = \frac{(k+2)(k+1)}{2} - 1 = \frac{(m-1)(m-2)}{2} - 1 \\ &\geq \frac{(m-1)(m-2)}{2} - g = \delta. \end{aligned}$$

We look at all curves of degree k going through the nodes Δ of Γ . Denote $\mathfrak{d} = |kH(-\Delta)|$ the corresponding linear system, and let ε be its dimension. Obviously

$$\varepsilon \geq \dim |kH| - \delta.$$

(In fact since nodes of an m -tic impose independent conditions upon adjoint curves of degree $m-3$ this is an equality. But we do not this deep fact essentially equivalent to Riemann-Roch.) Both displayed formulas shows that $\varepsilon \geq 0$, and we may thus impose to our k -tics to pass through $\varepsilon - 1$ extra points, while still moving inside a linear system of dimension ≥ 1 (a so-called pencil). This gives a pencil $L \subset \mathfrak{d}$ of degree

$$\begin{aligned} &\leq k \cdot m - 2\delta - 1 \cdot (\varepsilon - 1) \\ &\leq k \cdot m - 2\delta - \left[\binom{k+2}{2} - 1 - \delta \right] + 1 \\ &= k \cdot m - \delta - \left[\binom{k+2}{2} \right] + 2 \\ &= k \cdot m + g - \binom{m-1}{2} - \binom{k+2}{2} + 2 \\ &= (m-3)m + (m-1) - 2 \binom{m-1}{2} + 2 \\ &= (m-3)m + (m-1) - (m-1)(m-2) + 2 \\ &= (m-3)m + (m-1) \underbrace{[1 - (m-2)]}_{-(m-3)} + 2 \\ &= (m-3)[m - (m-1)] + 2 \\ &= m - 1 = g. \end{aligned}$$

This proves that any curve of genus g admits a pencil of degree $\leq g$, which assumed basepoint-free will induce a map having, eventually, lower degree. (Of course our assertion is false in the exceptional case $g = 1$, but true otherwise granting some knowledge.) Note that this “degree g ” bound is a bit sharper than the usual degree $g + 1$ prompted by Riemann(-Roch)’s inequality, but much weaker than the Riemann-Meis bound $[(g + 3)/2]$ for the gonality of a complex curve (of genus g). A natural desideratum would be to obtain Riemann-Meis bound via the above strategy, upon hoping that special configurations of $\varepsilon - 1$ points on the curve impose less conditions than expected, leaving some free room for additional constraints permitting to lower further the degree just computed. Of course this is essentially what Riemann was able to do (at least heuristically) via transcendental methods, and exactly (?) what Brill-Noether’s theory is concerned with at the pure algebro-geometric level. (Recall, yet, that both works apparently fails to satisfy modern standards, cf. e.g. Kleiman-Laksov 1972 [428] and H. H. Martens 1967 [528], where the problem was not yet solved apart via Meis’ analytic (Teichmüller-style) approach).

At this stage, starts the difficulties. The big programme would be to adapt the above trick to real orthosymmetric curves, in order to tackle Ahlfors theorem. The latter prompts the bound $g + 1$ rather, but this little arithmetic discrepancy should not discourage us. So in some vague sense a “real” Brill-Noether theory is required, combining probably also principles occurring in Harnack’s proof (1876 [334]) of the after him named inequality.

Maybe from the real locus $\Gamma(\mathbb{R})$ one can identify deep nests, and it is favorable to choose them as the extra basepoints to ensure total reality of the pencil we are trying to construct. Then there is also a foliation on the projective plane induced by the member of the pencil. Inside each oval, the foliation must exhibit singularities (otherwise total reality is violated). Observe in fact that total reality imposes the foliation to be transverse to the real circuits. Hence if there is no singularity we would have a foliation of the disc which is impossible. Perhaps Poincaré’s index formula is also required. To be brief there is some little hope that via a very careful analysis of the geometry, one can prove existence of a totally real pencil of degree $g + 1 = r + 2p$, recovering so Ahlfors result.

This would be pure geometry (or the allied devil of algebra) without intrusion of either potential theory, nor transcendental Abelian integrals, nor even topological principles. Perhaps only elementary topological tricks are required to ensure total reality by gaining extra intersection via a continuity argument akin to Harnack. This offers maybe another approach to Ahlfors, yet it requires some deep patience. It looks perhaps somewhat cavernous as (extrinsic) plane curves with singularities are just a “Plato cavern”-style shadow of the full Riemannian universe.

If this dream of an essentially synthetic proof of Ahlfors theorem is possible, then it would be nice (if possible) to boost the method at the deeper level of special groups of points to gain the sharper Riemann-Brill-Noether-Meis sharp control upon the gonality, whose real orthosymmetric pendant is expected to be the $r + p$ bound (of Gabard).

Last but not least, I know (only through cross-citations) the work of Chaudary, ca. 1996 (Duke Math. J.?) where a real Brill-Noether theory is developed. This is probably helps clarify the above ideas.

Philosophical remark.—Everybody probably experimented difficulties when playing with extrinsic models of Riemann surfaces. A baby instance occurs with Harnack’s inequality $r \leq g + 1$, whose extrinsic proof (Harnack 1876 [334]) is quite more intricate than Klein’s intrinsic version (same year 1876 [432]) based on Riemann’s conception of the genus. By analogy, one can predict that any synthetic programme toward Ahlfors will ineluctably share some unpleasant features of Harnack’s proof. The substance of the latter is a spontaneous creation of additional intersection points forced by topological reasons, leading to an excess violating Bézout’s theorem. It may be imagined that arguments similar to Harnack’s are required to ensure total reality of a well chosen pencil (reassessing thereby Ahlfors theorem). Instead of being obnubilated by real loci (of both the curve and the plane), is is sometimes fruitful to move in the “complex domain” to understand better reality. A typical example is Lemme 5.2. (in Gabard 2006 [255]) about unilateral divisors linearly equivalent to their conjugates. This was one of the key to my approach to Ahlfors existence theorem. Perhaps this lemma is also relevant to the problem at hand for it would ensure total reality quite automatically. In the series of adjoint curves \mathfrak{d} , one then imposes passing not through deeply nested ovals, but rather through imaginary points all located on the same half. The difficulty is of course showing existence of such a curve intersecting the fixed one only along one half (unilaterality condition), except eventually some assigned basepoints (either real or imaginary conjugate).

17.7 Extrinsic significance of Ahlfors theorem

[07.11.12] Another (less retrograde) desideratum is to explicit the extrinsic significance of Ahlfors theorem for real algebraic (immersed) plane curves. We touched this already in the Slovenian section 16.2 but now a sharper idea is explored. The point is delicate to make precise and already quite implicit in my Thesis (2004 [254], especially p. 7 second “bullet”) plus of course in Rohlin 1978 [706] (albeit the latter may never have been aware of Ahlfors theorem). Today I discovered a certain complement which is perhaps useful presenting.

First Ahlfors theorem traduces in the following.

Lemma 17.14 *Any real orthosymmetric (=dividing) algebraic curve admits a*

totally real morphism to the line.

Proof. The half of the dividing curve is a bordered surface. By Ahlfors 1950, the latter tolerates a circle map, which Schottky-doubled gives the required totally real map. For another proof cf. e.g. the first half of Gabard 2006 [255].

■

This is a statement for abstract curves (equivalently Riemann surfaces) but it acquires some extra flavor when the curve becomes concrete. Of course the ontological problem of concreteness is that there are usually plenty of ways for an abstract object to become concrete. Thus concreteness is oft the opposite extreme of canonicalness. Arguably, there is perhaps still a preferred “Plato cavern” namely the projective plane which can be used as an ambient space where to trace all Riemann surfaces provided we accept nodal singularities. Concretely this is done via generic projections from a higher projective space (\mathbb{P}^3 actually suffices to embed any abstract curve), and then we project down to the plane \mathbb{P}^2 to get a nodal model.

All this being pure synthetic geometry it transpierces matters regarding fields of definition (A. Weil’s jargon) and so adapts to the reality setting. As yet just trivialities, but now we would like to interpret synthetically the (non-trivial) Ahlfors theorem.

Start with a real dividing curve in some projective space. Via projections, we exhibit a birational model, C , in the plane as a nodal curve. Existence of a total morphism traduces into existence of a total pencil, i.e. one all of whose members cuts only real points on the curve C , at least as soon as they are mobile. A priori basepoints may include conjugate pairs of points. (A simple example arises when we look at the pencil of circles through 2 points. Recall that circles always pass to the so-called cyclic points at ∞ , but this is just an affine conception).

In geometric extrinsic terms, Ahlfors theorem should essentially take the following form.

Theorem 17.15 (IAS=Immersed Ahlfors via Kurvenscharen) *Given a dividing (real algebraic) curve C immersed nodally in the plane \mathbb{P}^2 . There is a totally real pencil of (auxiliary) curves of some degree k all of whose members cuts on C exclusively real points plus eventually imaginary conjugate pairs of basepoints.*

Proof. Essentially this reduces to the basic theorem that any abstract morphism of algebraic geometry admits a concrete description in terms of ambient linear systems when the abstract object is projectively concretized. In substance this is just the spirit of Riemann (algebraic curves=Riemann surfaces) but extended to the realm of morphisms. So the required theorem is just basic algebraic geometry but I forgot all the foundations. Historically add to Riemann, certainly Cayley-Bachach, Brill-Noether, (Klein?), all the Italians, and finally Weil, Grothendieck, plus of course many others. ■

Now the new observation [dated 07.11.12] is that we may always assume $k = 1$ (in the theorem IAS) up to changing of birational nodal model. The idea is that we may first reembed the curve C via the complete linear system of all curves of degree k (alias Veronese embedding) in some higher space \mathbb{P}^N , where $N = \binom{k+2}{2} - 1$. Then the image curve C' is (totally) swept out by a pencil of hyperplanes corresponding to the original total pencil L of k -tics in the plane (k -tics=curves of degree k). If we project from the base locus of the hyperplane pencil which is a linear variety of codimension 2 we arrive down again in \mathbb{P}^2 , but now with a new model which is total under a pencil of lines. It seems to me that this trick works and we get the:

Theorem 17.16 (IAP=Immersed Ahlfors via lines pencils) *Given an abstract dividing (real algebraic) curve, there is always a nodal(ly immersed) model in the plane \mathbb{P}^2 which is totally real under a pencil of lines.*

This result permits to remove one of the obstruction in our discussion of the Forstnerić-Wold problem (already touched in Section 16.2). We now deduce the stronger assertion:

Corollary 17.17 *Any finite bordered Riemann surface immerses in \mathbb{C}^2 .*

Proof. Let F be the bordered surface, and $C := 2F$ be its Schottky double which is real orthosymmetric. By the theorem (IAP) we find a nodal model in the plane \mathbb{P}^2 which is total under a pencil of lines. The pencil being real its unique base point p is forced to be real. Since the allied morphism (projection) is total the fibre of an imaginary point is an unilateral divisor, i.e. confined to one half of the curve. This means that all imaginary lines through the base point cuts unilaterally the curve. It suffices thus to remove (from $\mathbb{P}^2(\mathbb{C})$) an imaginary line through p to obtain an immersed replica of F in \mathbb{C}^2 . Note that if p lies on the (nodal) curve then only the open half (interior of F) is so embedded, but we can probably arrange this by displacing slightly the center of perspective p outside the curve while conserving total reality. The net bonus is that the whole bordered surface (boundary included) is in \mathbb{C}^2 . ■

Of course this is still millions light-years away from the Forstnerić-Wold desideratum postulating an embedding (for all finite bordered surfaces). However this represents already a nice application of Ahlfors. Of course the corollary is also just a very special (finitary) case of the famous Gunning-Narasimhan theorem (1967 [325]), asserting that any open Riemann surface immerses in \mathbb{C}^2 . (Maybe their immersions are proper also, whereas ours are not. Maybe the Fatou-Bieberbach trick arrange this issue always(?), cf. e.g. Forstnerić-Wold 2009 [247]). Anyway using the quantitative form of Ahlfors (not used as yet) one can go perhaps further, may saying e.g. things on the degree of the model. Note also that the viewpoint of nodal model of orthosymmetric curves afford another numerical invariant, namely:

Definition 17.18 *(quite implicit in Matildi 1945/48 [536]) Given an abstract dividing real curve C . The least degree δ of a nodal birational model of C is termed (by us) the nodality of the curve C . Via the Schottky double this invariant also makes sense for finite bordered Riemann surfaces.*

Projecting down to \mathbb{P}^2 the canonical model in \mathbb{P}^{g-1} of a curve of genus g , we get a nodal model of degree $g + 1 = (2g - 2) - [(g - 1) - 2]$ (each projection from a point on the curve decreases the degree by one unit). Hence $\delta \leq g + 1$.

If the theorem (IAP) is correct, one could also try to define the linear gonality of a bordered surface (or the allied orthosymmetric double) as the least degree of a nodal plane model totally real under a pencil of lines. This gives perhaps yet another invariant λ , which seems to satisfy $\gamma \leq \lambda + 1$.

Another dream of longstanding (Gabard's thesis 2004 [254]) is whether the Ahlfors theorem implies Rohlin's inequality $r \geq m/2$ for a smooth dividing curve of degree m . If such a curve $C = C_m$ is totally real under a pencil of lines, then sweeping out the curve by the pencil gives collections of m real points. When rotating the line around the basepoint, those m points never enter in collision (else smoothness is violated), nor do they disappear in the imaginary locus (else total reality is violated). After a 180 degree rotation already, the line returns to its initial position while the group of m points recover its initial position giving raise to a monodromy permutation. Total reality forces each circuit of the curve C to be transverse to the foliation underlying the pencil of lines. It follows that the monodromy transformation is an involution (order 2) and we deduce:

Lemma 17.19 *(Rohlin essentially) Let C_m be a smooth real curve totally real under a pencil of line. Then the real locus $C_m(\mathbb{R})$ consists of a deep nest of $m/2$ ovals when m is even, and if m is odd there is as usual one pseudoline and ovals distributes in a nest of depth $(m - 1)/2$.*

In particular Rohlin's inequality $r \geq m/2$ follows in this special case where total reality is given by a pencil of lines. Now the general case of Rohlin still appeal to some formidable work, but perhaps may be derived via a linear pencil on a nodal model. Alas we are unable to complete this project.

Let us however try to be more explicit. Given a smooth dividing C_m . Let L be a total pencil of k -tics given by Ahlfors (theorem IAS). Then one can either try to study directly the corresponding foliation appealing to Poincaré's index formula, and hope to mimic the above argument. Alternatively one can try to use the reembedding trick, where we use another model total under a pencil of lines. Now on the new nodal model of degree say λ , we apply the same sweeping procedure. We see on one initial line L_0 (assumed generic, i.e. avoiding the nodes) λ points all real. When rotating by a half-twist the line we see groups of λ points which now may cross themselves, but one can still assign a monodromy permutation. Naively any point finishes its trajectory on the other side of the basepoint (alas this makes no sense since a projective real line is a circle not disconnected by a puncture). The number of real circuits r of the curve C is equal to the number of cycles of the monodromy permutation, but a priori the latter number can be very low since crossings are permitted. (Imagine e.g. a spiral which after several growing revolution times closes up to form a single circuit.) Note that we do not yet exploited the smoothness hypothesis of the original model C_m . A naive way to exploit this is via the complex gonality $\gamma_{\mathbb{C}}$. We have indeed $m - 1 = \gamma_{\mathbb{C}} \leq \gamma$ (C being smooth). On the other hand $\gamma \leq \lambda - 1$. Hence $m \leq \lambda$. This is interesting yet certainly not enough to conclude Rohlin's inequality. So we give up the question for the moment.

17.8 The gonality spectrum

An idea perhaps worth exploring is to sharpen the gonality sequence (Definition 17.7) into what could be called the *gonality spectrum*. This would just be the former weighted by the dimension of the space of all circle maps of the prescribed degree.

As we already observed earlier (hyperelliptic examples) it seems that when a surface has a very low gonality then it "somnolates" without creating new gonalities. Thus more generally, the intuition behind this spectrum invariant would be a conservation principle (somewhat akin to Gauss-Bonnet: whatsoever the Riemannian incarnation of a topological surface is the curvatura integra keeps constant value equal to the Euler characteristic).

Of course experiments requires to be made (using e.g. the specimens on Fig. 50). Alas I had not presently the time to do serious investigations about this spectrum. It seems also expectable that from a certain range on, the spectrum is independent from the conformal structure. (At least so is the case for the gonality sequence which is always full after $r + 2p$.)

Of course some convention is required, probably consider only maps up to automorphism of the disc.

Example the only example where the spectrum is very easy to describe is the disc: in this case the γ -sequence is full starting from 1, and there is essentially only one map of degree one (the Riemann map). Given any unilateral group D of d points in the disc, thought of as the north hemisphere of the Riemann sphere the pencil through D and its complex conjugate D^σ induces a totally real map. (cf. Lemme 5.2 in Gabard 06 [255]). Conversely, given the map its fibre over 0 gives an unilateral divisor, which up to a range automorphism may be assumed to contain 0. Normalizing by a rotation there are thus the map depends upon $2d - 3$ real constants. (Make this more precise...). Such maps are (in the complex function literature) often called finite Blaschke products.

Once the setting is well understood, this gonality spectrum encodes valuable information upon all circle maps. Of course one perhaps still want to know more; e.g. to understand the incidence relation among the varied maps, especially how high degree maps may degenerate to lower degree ones. Fig. 50 shows some

interesting examples. Considering e.g. picture 313 we see that both maps of degree 3 are limit of maps of degree 4 (actually can be connected by such), and both of them are also limits of maps of degree 5.

Looking at picture 112 (again on Fig. 50) we see that the unique (total) map of degree 2 is also the limit of maps of degrees 3 and 4. The gonality sequence $2, 3, 4, \dots$ can be enriched by weighting by dimensions to get $2_0, 3_1, 4_2, \dots$. Beware that probably there are other maps of degree 4 than those visible on the picture as linear projection, namely the unique 2-gonal map post-composed by circle maps of degree 2 from the disc to itself. Our guess is that such Blaschke maps may degenerate to their originator (the hyperelliptic projection) but not to maps of degree 3.

17.9 More lowbrow counterexamples to $\gamma \leq r + p$

[27.10.12] We now pursue the project of multiplying and diminishing further the degree of virtual counterexamples to Gabard's estimate $\gamma \leq r + p$ (cf. Fig. 20 and Fig. 21). There we found curves (via an uniform recipe) seemingly violating the gonality upper bound $r + p$. The simplest example had degree 5, but it is easy to get examples of degree 4. The game is again to depict total pencils vindicating Gabard's bound. This affords of course only a very modest corroboration of the bound, but we found instructive to visualize the corresponding total pencils.

First remember the general recipe: to manufacture an (at least virtual) counterexample to $\gamma \leq r + p$, we leave tranquil the inner oval but maximize the number of singularities, so as to lower the genus $g = (r - 1) + 2p$, and hence (r, p) . Having left quiet the inner oval the virtual gonality obtained by linear projection is one less than the degree, but $r + p$ may go lower down this value.

We first consider a configuration of degree 5 consisting of 2 conics plus one line, see picture 304 below (Fig. 22). Smoothing the configuration as dictated by orientations while keeping unsmoothed the dashed circles gives a curve with $r = 3$ (3 real circuits) of genus $g = 6 - 4 = 2$. Hence $p = [g - (r - 1)]/2 = 0$. The virtual gonality γ^* (arising from the best linear projection) is $\gamma^* = 4$ (projection from the inner oval). This seems to violate $\gamma \leq r + p = 3$. Looking at the pencil of conics through the 4 nodes we get a series of degree $2 \cdot 5 - 4 \cdot 2 = 10 - 8 = 2$. This violates the trivial bound $r \leq \gamma$, but of course this pencil is not total: e.g. the conic consisting of the 2 horizontal (or better oblique) lines misses the inner oval. Assigning instead one of the 4 basepoints on the inner oval we get a pencil of degree 3, which is claimed to be total.

Totality of the morphism requires contemplating (patiently) that each conic of the pencil cuts only real points on the quintic C_5 . This is depicted on the large part of Fig. 22, where each triad of moving points of the series are labelled by triples $1, 1, 1$, then $2, 2, 2$, etc. Let us start from the conic consisting of the oblique line through $1, 1$, plus the horizontal line. The latter cut the red pseudoline at infinity. This pair of lines deforms to a hyperbola cutting the triad $2, 2, 2$. This hyperbola is in turn pinched toward a pair of lines cutting the group $3, 3, 3$, etc, up to $7, 7, 7$. From here on, things becomes harder to visualize. (Alas our picture is not optimally designed.) The conic of the pencil now becomes very close to the primitive conic involved in the generation of the quintic C_5 via small perturbation. The net effect is that points on the green branch nearly "osculated" by the primitive ellipse are (violently) accelerated (like in CERN's particles accelerator). At this stage it is quite delicate to make a consistent picture, but total reality seems to work: all particles stay real during the motion without disappearing as ghost in the imaginary locus (as conjugate pairs of points under Galois).

We promised a similar example of degree 4; this will be pictured later (Section 18.3), being now sidetracked to another topic which looks more exciting.

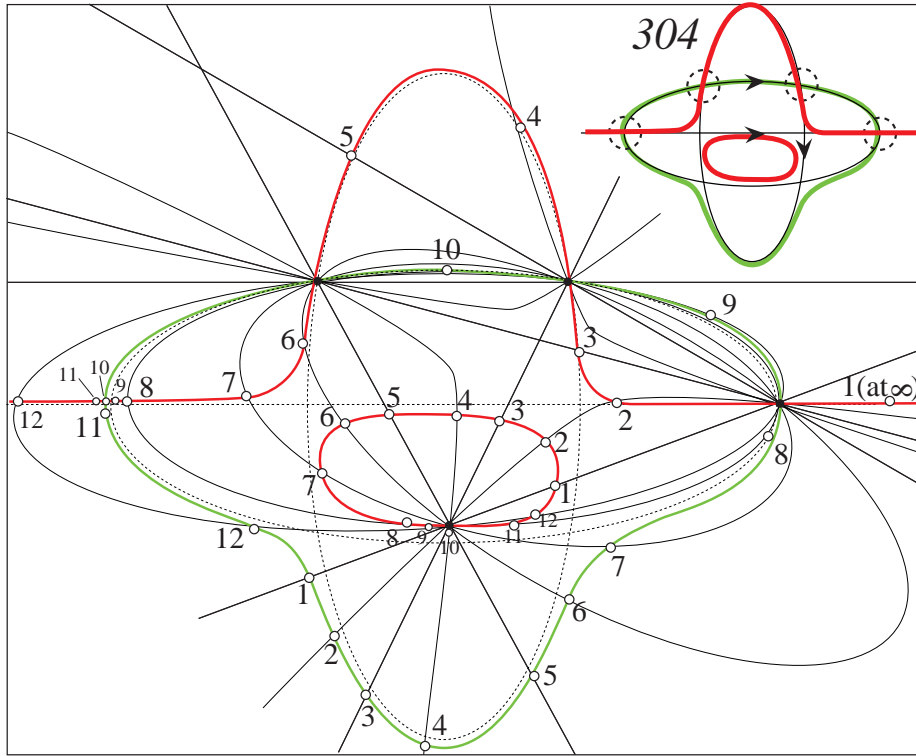

Figure 22: Tracing a totally real pencil of conics on a orthosymmetric quintic, whose underlying bordered Riemann surface has genus zero. This illustrates the Ahlfors map (rather its Bieberbach-Grunsky special case) at the extrinsic level. The circulation of real points is (violently) accelerated when the cutting conics nearly osculate the cutted quintic.

18 Some crazy ideas about gravitation and unification of forces

18.1 From gravitation to electrodynamics

Now we arrive at the following crazy interpretation (discovered the 27.10.12 at ca. 13h58). It would be nice if there is some relation of the Ahlfors maps with periodic solutions of the n body problem in gravitation (celestial mechanics). The 4 basepoints of Fig. 22 might be thought of as supermassive black-holes, so massive that there is no interaction between them (imagine purely static objects lying in different sheets of the multiverse). Dually, the moving points of the linear system are imagined as massless microparticles (electrons, or better photons). There is also no gravitational interaction between them. Thus the sole interactions reigning are those between black holes and photons. It is also imagined that a photon can traverse a black-hole (without captivation).

As a wild speculation, the trajectories described by the 3 photons on Fig. 22 may satisfy exactly Newton's law of gravitation. In particular the full trajectory would be the real locus of an algebraic curve! This would of course be a wide extension of Kepler's law (on the role of conics sections in the simplest case of one sun and one planet).

If this is true we see a deep connection between Klein's theory of orthosymmetric curves, Ahlfors maps of conformal geometry and the total real circulations positing periodic stable motions along circuits of an orthosymmetric curve.

Note that our basic experiment (with Fig. 22) is—as far as the speed of the motion is concerned—quite in line with this interpretation.

Let us look at one of the simplest example of orthosymmetric curve, namely the Gürtelkurve. The picture is given below (Fig. 23). One can convincingly

argue that the shapes of trajectories (especially the outer oval) are unlikely to be gravitational orbits. It seems that some hidden force repulses the particles (labelled 1 on the figure). Imagining some other (electric) force effecting repulsion between particles, then the trajectories of the Gürtelkurve looks again physically tolerable. Thus the “physical” model should include two types of interactions: gravitational and electromagnetic.

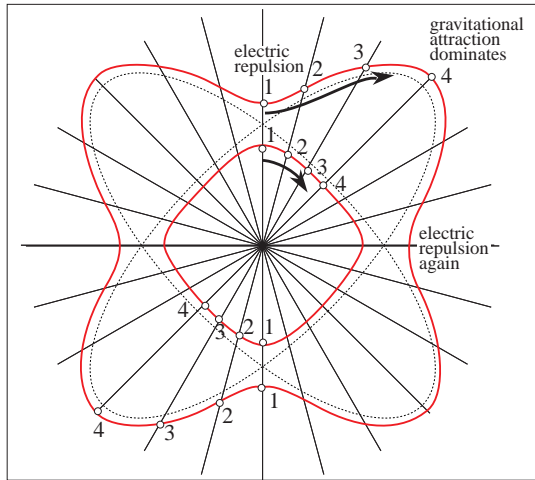

Figure 23: An electro-gravitational toy model with Klein’s Gürtelkurve. Four particles of electronic type (electrons) are gravitating around a single star (or better a proton). The unusual shapes of trajectories are explained by electric repulsion.

Of course one can drag the position of the sun while still having a totally real pencil. This gives the next figure (Fig. 24). Note that we did not changed the curve, yet it is still plausible that for suitable initial conditions (velocity vectors) the orbits of our 4 bodies follows exactly the same quartic curve.

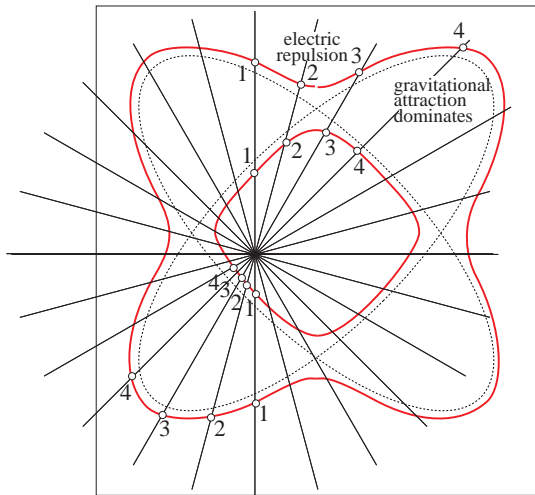

Figure 24: Moving the sun.

We arrive at the following metatheorem [14h57]:

Theorem 18.1 (*Kepler generalized?*) *Given any orthosymmetric real (algebraic) curve embedded (or immersed) in the Euclid plane \mathbb{R}^2 and a totally real pencil (existence ensured by Ahlfors theorem). There exists initial conditions (velocity vectors) such that the trajectories of the particles under the law of electro-gravitational forces (Newtonian dynamics with interactions governed by the inverse square law of attraction resp. repulsion) match exactly with the real circuits (“ovals”) of the given real algebraic curve. Further the dynamics (speed of the motion) is dictated by the pencil. In particular there is plenty of periodic solutions to the n -body problem, essentially one for each such curve.*

How to prove this? Philosophically the algebraicity might be not so surprising: recall Laplace's potential theoretic interpretation of Newton, and from Laplace there is just one step to Riemann, hence to Klein). The miracle could be essentially akin to Riemann's existence theorem prompting that any closed Riemann surface (an a priori completely fluid object) rigidifies canonically as an algebraic curve. Of course even if true the metatheorem is quite modest because in practice (meteorites, apocalyptic black holes scenarios, etc.) one is given the initial conditions and the goal is to predict the future evolution of the system. Here in contrast, we know in advance the trajectories (hence the destiny) while claiming existence of initial conditions compatible with the orbital structure. Generally, integrating the differential equations governing some motion, we meet a highly complex dynamical system (subjected to the paradigm of chaotic determinism à la Poincaré). (Note that a Euclidean model of the projective curve is required to give sense to Newton inverse square law.)

Several questions naturally occurs (assuming the truth of the metatheorem). The theorem affords plenty of periodic motions. Essentially we obtain as many periodic motions as there are real orthosymmetric curves. Even more than that, one requires an Ahlfors circle map (equivalently a totally real morphism à la Klein-Teichmüller). A first naive question is: do this recipe exhausts all periodic motions? Certainly not, try Euler and Lagrange's periodic motions. Roughly all algebraic motions are periodic, but the converse has no chance to be true.

Observationally, Fig. 24 looks anomalous because the series 1,2,3,4 closest to the sun looks much slowed down, whereas we are accustomed (Kepler) to rapid motions near a massive star. One requires perhaps a third type of interaction, say the *strong interaction*, to explain this. Namely both particles the sun and the electron are of a dualistic nature, hence they tend to "love" themselves like partners staying close to themselves for a long period of time. This third force would have the net effect of diminishing the real speed by a factor proportional to the (squared?) distance separating the bodies. What is then the fourth force, alias the *weak interaction* in contemporary physics? Maybe none is required in our model? Perhaps dually, particles of the same nature (namely electrons) dislike themselves like competitors and the *weak force* just produces some acceleration of the motion when they are in close vicinity. Visually this behavior is perhaps observed near the groups labelled 2,3 on the top part of Fig. 24.

We have now a model with 4 fundamental forces. One must of course still define time. This would, on our example, just be the angular parameter of the pencil. Presumably the metatheorem should take into account this two extra forces, becoming somewhat sophisticated system, yet probably still of completely deterministic, and hopefully reasonably easy to integrate. The miracle would be that it admits separating (=orthosymmetric) real curves as periodic orbits. [Added 27.11.12] Of course to relativize, one can do similar games with real diasymmetric curves, but then there is no total reality prompted by Ahlfors theorem and particle may disappear in the imaginary locus. We leave to the reader to imagine an appropriate physical interpretation (ghost particle, anti-matter, etc.)

Perhaps there is a more elementary way to explain slowness of the motion near the star (without appealing to the exotic forces at the subatomic level). Recall Kepler's law in the elliptical case stating that identic sectorial areas are swept out during any unit of time. This would suggest that the time parameter is not the angular parameter but the areal one. Of course one gets other troubles since the distant planet is supposed to move synchronically with the one closer to the sun.

[28.10.12] Another objection to our metatheorem is the following one. Assume the given orthosymmetric curve to be the simplest one, namely a line swept out by a total pencil of lines. Then one must assume that there is no forces between the two bodies to explain the rectilinear motion.

A more serious objection arises when C is an ellipse swept out by a total pencil of lines through the middle of both foci. If all forces involved satisfy the inverse square law the resulting force satisfies it too. Hence all interactions

reduce to a single one which is attractive (to get an elliptic trajectory). However according to Kepler the orbit must be an ellipse with the sun located at one of the foci of the ellipse. Hence our geometric model where the basepoint of the total pencil lies at the center of the ellipse is not physically relevant.

This example suggests that the metatheorem requires corrections. Maybe one is just given in advance an orthosymmetric curve C but not the total pencil L , and the (meta)theorem would state existence of a pencil which is physically observable. In the case of an ellipse we would only be allowed to take pencil of lines through one of both foci; if the ellipse degenerates to a circle only the center would be permissible.

Of course this Keplerian obstruction should not preclude physical systems obeying more complicated interactions laws (with say several fundamental forces, maybe not all subjected to the inverse square law). Such could validate the exotic orbital structure consisting of an ellipse with a sun in its center as physically reasonable.

Let us now leave such complex modelling question, to contemplate more complicated systems arising from other curves than the Gürtelkurve, especially some of higher order. First staying in degree 4 there is, dual to the Gürtelkurve, the curve arising by reversing the orientation of one of the ellipses (cf. arrows on Fig. 25). This gives a quartic with 4 ovals when smoothing compatibly with the prescribed orientation. A total pencil arises when looking at all conics through 4 basepoints distributed inside the ovals (Fig. 25).

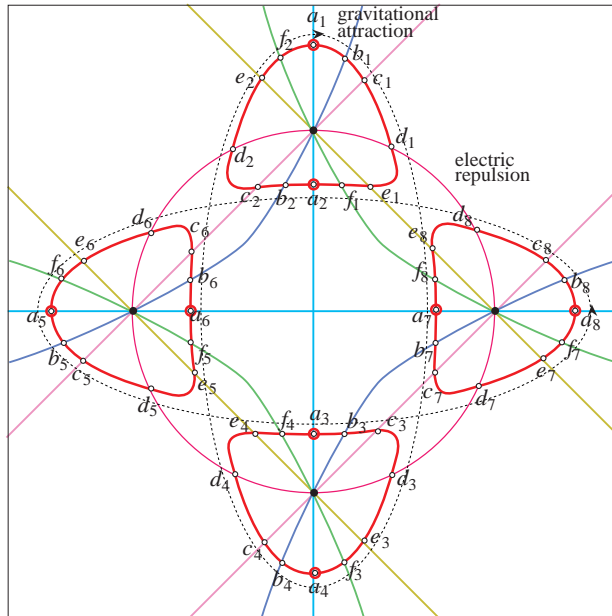

Figure 25: Harnack maximal quartic with a total pencil of conics traced through 4 basepoints located inside the ovals. Physically, this is a magneto-gravitational system with 4 stars and 8 electrons. The initial position is labelled a_1, a_2, \dots, a_8 whose forward orbit consists of b_i, c_i, d_i, \dots (increasing alphabetic order).

Initially the point a_1 animated by a suitable horizontal velocity vector is mostly subjected to the attraction of the nearby star (=upper basepoints of the conics pencil). If a_1 and this star where to be alone in the universe, a_1 's orbit would be close to the dashed ellipse of "vertical eccentricity", provided the upper star coincides with the focus of this ellipse. Yet in reality, as the body a_1 arrives near position d_1 and meanwhile body a_8 reached position d_8 , electric repulsion starts to be predominant ultimately causing a (finally violent) deviation from the elliptic trajectory.

Of course instead of appealing to gravitation one can just imagine the basepoints (alias "stars" previously) as positively charged protons and the whole system reduces to an electrodynamical one, obeying only the law of Coulomb's attraction resp. repulsion. The fixed protons would however not repulse, main-

taining their fixed position due to say some nuclear cohesion (strong/weak forces).

It is easy to produce examples of higher topological complexity via curves of higher orders. Instead of starting with two ellipses, take three of them and smooth the configuration in a sense preserving way to get Fig. 26.

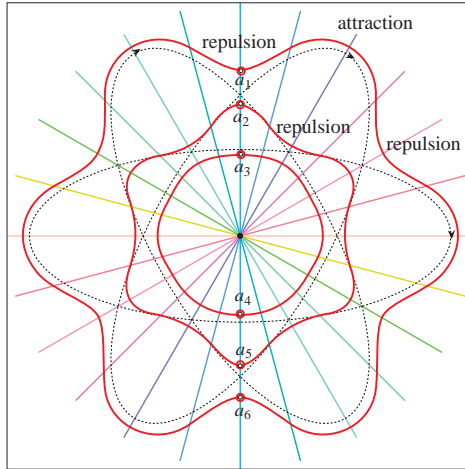

Figure 26: A sextic akin to the Gürtelkurve (nest of depth 3).

Reversing orientation of one of the ellipses (say that with horizontal major axis) gives the more interesting Fig. 27 requiring a pencil of conics to exhibit total reality.

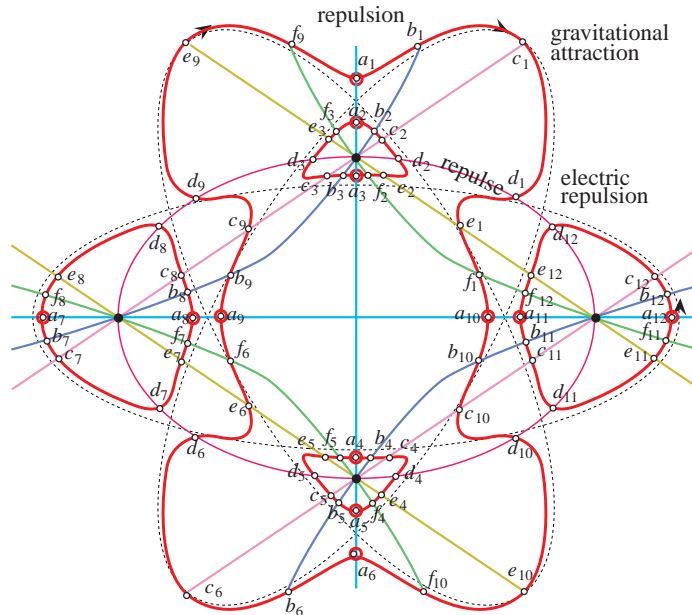

Figure 27: A sextic with a total pencil of conics through 4 deep nests. Physicochemically, an atomic nucleus consisting of 4 protons is gravitated around by 12 electrons dancing around in a fairly complicated way. The long orbit is circulated by 4 electrons (all others by 2). Is there a relation between Poincaré indices of the foliation and the number of moving points?

Again we use the same labelling as before, namely the first (cyan colored) conic consisting of the vertical and horizontal lines cuts on the sextic C_6 the group of points labelled a_1, \dots, a_{12} . All of them are real. Moving clockwise from the top, a subsequent conic (colored in blue) cuts the series denoted b_i , etc. One checks easily that all conics of the pencil cut only real points on the C_6 . Looking at the corresponding dynamical process, we note that a_1 is first repulsed against a_2 being rejected as far as c_1 , then attraction of the 4 protons

(mostly the North and East one) track back the orbit to position d_1 where a repulsion against d_{12} takes place, deflecting again the orbit along the way of the North proton, but then vicinity of d_2 causes another repulsion towards e_1 and f_1 , which is finally gently repulsed by a_{11} . Etc. the sequel of the story is symmetrical.

It is now fairly evident how to construct similar dynamical systems of ever increasing complexity. It may be observed that the totally real map induced by the pencil gives a circle map of degree 12. Now the topological invariants are $r = 5$ and $g = 10$. Hence the half-genus is $p = [g - (r - 1)]/2 = 3$. Hence this map as degree exceeding Ahlfors bound $r + 2p = 11 (= g + 1)$. However under a parietal degeneration of the 4 basepoints against the ovals enclosing the 4 basepoints, we find a total map of degree $2 \cdot 6 - 4 \cdot 1 = 12 - 4 = 8$. This is actually in accordance with the $r + p$ bound predicted in Gabard 2006 [255].

It is tempting to consider the (mildly singular) foliation induced by the pencil (of conics). It seems clear from the picture that there is a relation between the sum of Poincaré indices extended to the interior of an oval and the number of points circulating on the oval. Observe also that the foliation is transverse to the boundary of the disc bounding the oval. This property is general and follows at once from the fact that totally real maps lack real ramification points. Using Ahlfors total reality paradigm combined maybe with Poincaré's index formula we suspect that some old (and perhaps new?) information on the topology of real plane (dividing) curves can be re-derived. In particular we suspect that it must be possible to recover Rohlin's inequality. (This states $r \geq m/2$, i.e. any smooth dividing plane curve of degree m has at least as many circuits than the half value of its degree.) This is a fantastic project, but we leave it aside for now. [vague details p. 32 of hand-notes].

[08.11.12] Another highbrow (yet poorly explored) application of Ahlfors theorem was sketched in Gabard's Thesis (2004 [254], Introduction, ca. p. 7). This was an answer to Wilson's question on deciding the dividing character of a plane curve by sole inspection of its real locus. Here again Ahlfors theorem affords an answer: a real curve is dividing iff it admits a total pencil (with possibly imaginary conjugate basepoints). Yet it must be admitted that the answer, albeit perfectly geometric, has probably little algorithmic value unless complemented by further insights. Of course another question is to decide the dividing character from the sole data of a ternary form (homogeneous polynomial in 3 variables with real coefficients). The simplest case of Wilson's question is that of a deep nest, i.e. a smooth curve C_m of say even degree $m = 2k$ with a completely nested collection of k ovals. Then linear projection from a point on the deepest oval is total of degree $m - 1$. Since the complex gonality is also $m - 1$, we deduce that the gonality γ is also $m - 1$. On the other hand the topological invariants are $r = k$ and $g = \frac{(m-1)(m-2)}{2}$. Hence in this case Ahlfors bound $r + 2p = g + 1$ is strongly beaten by the gonality $\gamma = m - 1 \ll g + 1 = [1 + 2 + 3 + \dots + (m - 2)] + 1$. Gabard's bound $r + p$ is also much greater than the exact $\gamma = m - 1$; indeed $r + p$ is nothing but the mean value of r and $g + 1$ and in the case at hand the former is $m/2$ but the latter is quadratic in m .

[29.10.12] We consider next an octic (Fig. 28) arising from a sense-preserving perturbation of 4 ellipses rotated by 45 degrees. Of course if all ellipses are oriented clockwise we get a nest of depth 4 and accordingly a total pencil of lines through the innermost oval. Here instead, we reverse some orientations to create 16 ovals and no nesting (cf. black curve on Fig. 28). The theorem of Ahlfors predicts existence of a total pencil. The general principle is to impose basepoints inside the deepest ovals, hence the desired pencil must have degree 4. At this stage depiction can be a fairly difficult artform (reminiscent of gothical "rosaces" = rosewindows). Our trick was to use a ground ellipse of pretty large eccentricity so that oblique line of (angular) slope different from $\pi/4$ (the green and lilac colored ones) also passes through the deep nests. Of course this trick is not supposed to affect the generality of the method (i.e Ahlfors theorem) but just intended to simplify the artwork!

As to the arithmetics, recall that (plane) quartics depends upon $\binom{4+2}{2} - 1$

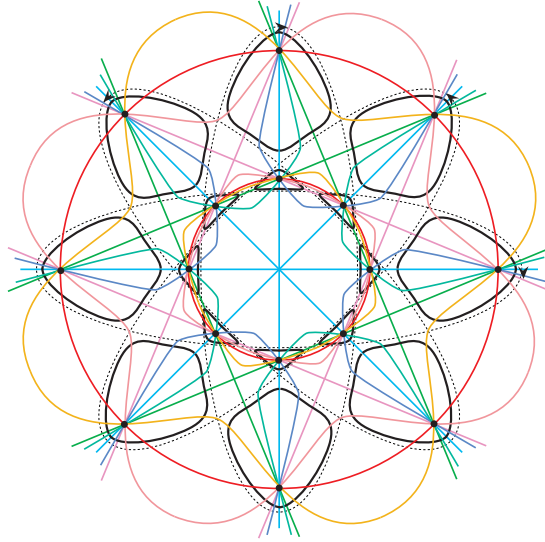

Figure 28: An octic (reminiscent of gothical rosewindow) swept out by a total pencil of quartics with 16 real basepoints distributed in the innermost ovals

parameters (coefficients counting), hence one is free to assign 13 basepoints. On the other hand, our dividing octic C_8 has genus $g = \frac{(m-1)(m-2)}{2} = \frac{7 \cdot 6}{2} = 21$ and $r = 16$ ovals, thus the genus of the half (semi Riemann surface) is $p = [g - (r - 1)]/2 = 3$. Imagine now that among all 16 basepoints of the pencil 13 moves against the ovals, then a series of (reduced) degree $4 \cdot 8 - 13 \cdot 1 = 32 - 13 = 19$ is obtained. This matches with the $r + p$ bound on the degree of circle maps predicted in Gabard 2006 [255]. Geometrically it is pleasant to observe that certain members of the pencil are Gürtelkurven (see the lilac-colored curve). Those are not connected. Hence total reality of a pencil is not necessarily allied to connectedness of the auxiliary curves. For the fun of depiction, one can increase the number of curves of the pencil while sweeping out more and more of the full color spectrum, creating a sort of rainbow effect (cf. Fig. 29).

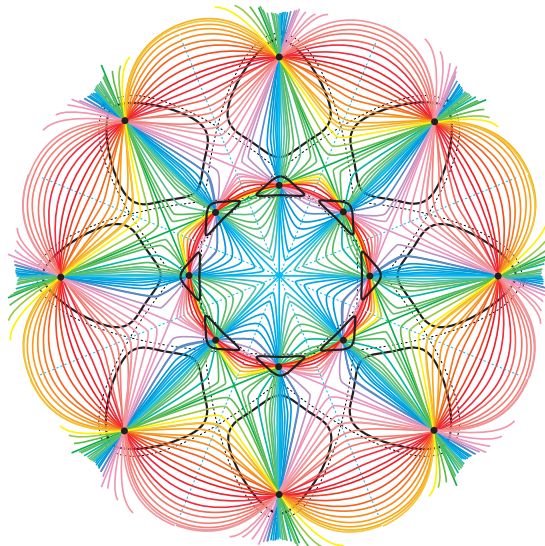

Figure 29: The rainbow effect

At this stage one gets the impression that the theory (or rather the pictures) works only for highly symmetric patterns. However the strength of Ahlfors result lies in its universal validness for all curves regardless of symmetry. This imbues some suitable respect plus a certain feeling of vertigo about the whole Ahlfors result.

Of course there is another possible orthosymmetric smoothing of our con-

figuration of 4 ellipses. This is given by reversing one of the orientations of the ellipses, and we obtain the black-traced curve on Fig. 30. This times there is only 4 deep nests and a pencil of conics suffices to exhibit total reality.

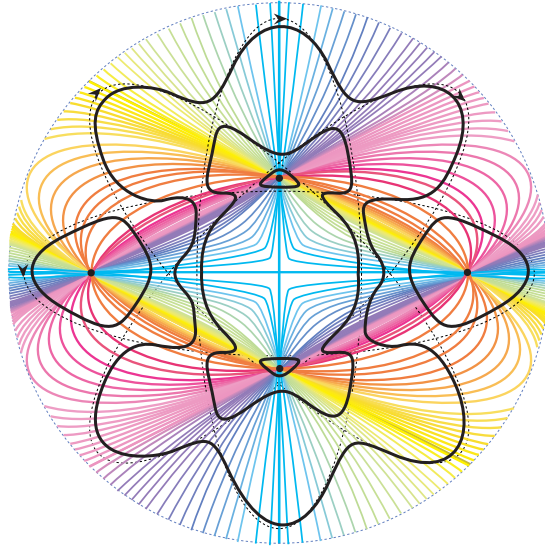

Figure 30: Another octic with a total pencil of conics

As to arithmetic matters, this octic has still $g = 21$ but now only $r = 6$ ovals. Hence the semi-genus $p = \frac{g-(r-1)}{2} = 8$. Dragging the 4 basepoints against the deep ovals gives a total map of degree $2 \cdot 8 - 4 \cdot 1 = 16 - 4 = 12$. This is more economical than the $r + p$ bound, here equal to 14.

Finally there is yet another smoothing of our 4 ellipses producing Fig. 31 with 4 nests of depth 2. A pencil of conics suffices to show total reality.

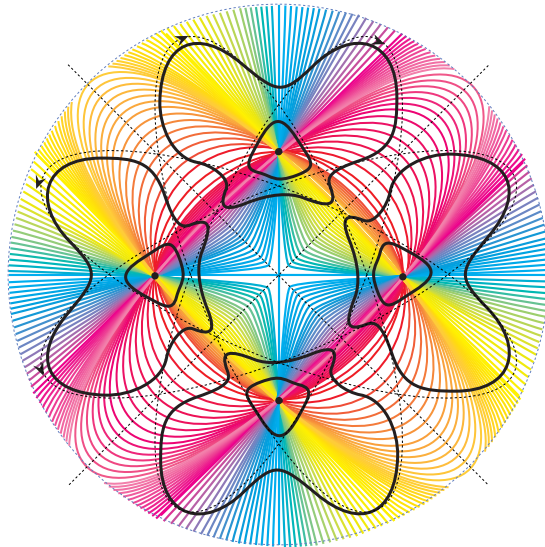

Figure 31: Yet another octic with a total pencil of conics

Regarding the topological invariants we have $r = 8$, hence $p = 7$. As before there is a total map of degree 12 (via parietal degeneration), which is better than Gabard's bound $r + p = 15$. Naively this relative improvement over the previous example (in comparison to the $r + p$ bound) could be explainable by the higher symmetry of the new curve probably reflecting a further particularization of the "moduli". (Recall that if one believes Gabard 2006 [255] and especially Coppens 2011 [183] a bordered surface of type (r, p) has generically gonality $\gamma = r + p$.)

Note yet that our total pencil of conics persists for any octic with 4 nests of depth 2, hence the symmetry of the pattern can be greatly damaged by large

deformation of the coefficients without affecting the (estimated) gonality. So we certainly have the:

Proposition 18.2 *Any octic curve with 4 nests of depth 2 has gonality $\gamma \leq 12$ (and presumably not lower, yet this remains to be elucidated).*

Having clearly exhausted the smoothing options of our 4 ellipses, one is somehow disappointed that pencils of cubics were not yet required. Looking on p.7 of my thesis [254] I rediscover a simple such example involving only a sextic. Let me reproduce this with the rainbow technology. We start now from a configuration of 3 ellipses one of which is a circle and get Fig. 32.

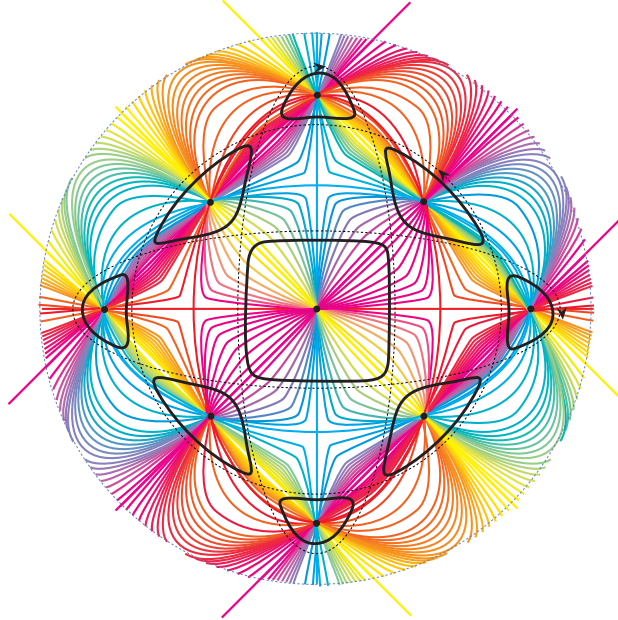

Figure 32: A sextic with a total pencil of cubics

The sextic has $g = 10$ and $r = 9$ (hence pre-maximal among dividing curves), and thus $p = 1$. Cubics depends on $\binom{3+2}{2} - 1 = 10 - 1 = 9$ parameters, hence 8 base points may be freely assigned. Pushing them along ovals gives a total map of degree $3 \cdot 6 - 8 \cdot 1 = 10$. This matches with Gabard's bound $r + p$, hence the curve should be considered has having general moduli. Of course if the smoothing is done very symmetrically and if moreover we play with the radius of the initial circle, we can perhaps arrange that all 9 base points lands on the sextic curve in which case the gonality would lover to 9 the minimum value (recall $r \leq \gamma$).

Starting from the above sextic, one can perform a large deformation of the coefficients staying inside the space of all smooth sextic curves. The real locus picture may then undergo drastic change of shape yet its topological type keeps unaltered and so in particular the orthosymmetric character. It is not clear anymore that our simple minded pencil of cubics (spanned by 2 pairs of 3 lines) suffices to exhibit total reality. This amounts essentially to the claim that for any 8 basepoints distributed among the ovals then the ninth basepoint luckily falls into the remaining one. This luckiness phenomenon becomes even more hazardous when it comes to vindicate Gabard's bound by a synthetical procedure. The latter seems equivalent to the claim that given any such curve (orthosymmetric with 9 non-nested ovals it is always possible to choose 8 points one on each oval) so that the pencil through them creates an extra basepoint inside the remaining oval. This lucky-stroke phenomenon should perhaps be further explored either as an application of the $r + p$ bound or as a way to disprove it.

[08.11.12] Let us fail to be more specific as follows. Remember first that a real sextic curve with 9 unnested ovals needs not to be dividing, cf. e.g.

Gabard's thesis 2004 [254] p.8, but this is of course well-known since at least the Rohlin-Fiedler era, e.g. Rohlin 1978 [706]. Second it is not even clear a priori that the conditions "dividing plus 9 unnested ovals" specifies a unique isotopy type of curves, i.e. a unique chamber in the space of all smooth sextics. This is a projective space of dimension $\binom{6+2}{2} - 1 = 28 - 1 = 27$ parcelled into chambers by the discriminant hypersurface of degree $3(m-1)^2 = 3 \cdot 5^2 = 75$.

Conjecture 18.3 (*very hypothetical!!*) *Any dividing sextic with 9 unnested ovals admits a total pencil of cubics with 8 basepoints on the sextic and the 9th basepoint inside the remaining oval.*

Proof. (pseudo-proof!) Since the curve is dividing we know by Ahlfors that there is a total pencil. We have very poor control on the degree of the curves of the pencil. We only know Ahlfors bound $r + 2p = g + 1 = 11$, Gabard's one $r + p = 10$ and the complex gonality $\gamma_{\mathbb{C}} = 5$ which is completely useless. Stronger information comes from the trivial bound $r \leq \gamma$. So the gonality γ is fairly well squeezed as $9 = r \leq \gamma \leq r + p = 10$. A priori a least degree total map could be given by a pencil of quartics. Then the degree could be as low as $4 \cdot 6 - 16 = 24 - 16 = 8$; for quintics as low as $5 \cdot 6 - 25 = 5$; for sextics as low as $6 \cdot 6 - 36 = 0$; septics $7 \cdot 6 - 49 = -7$; k -tics $k \cdot 6 - k^2$ highly negative! Hence we have virtually no control on the degree of (members of) a total pencil, despite the bounds on the degree of the abstract total map. Let us thus shamefully postulate that the pencil in question can be chosen among cubics. For foliated reasons it is clear that the nine basepoints (elliptic points or "foyers" of Poincaré index +1) must be surjectively distributed among the 9 ovals. Indeed the total pencil is transverse to the real circuits and the disc bounding an oval cannot be foliated transversely (Euler-Poincaré obstruction). Hence we have the:

Lemma 18.4 *All basepoints of a total cubics pencil on a smooth sextic with 9 unnested ovals are real, distinct, and surjectively(=equitably) distributed between the 9 ovals (either in their insides or their periphery).*

Applying the parietal degeneration trick we can take any 8 of the basepoints and drag them to the ovals. During the process we get new pencils (of possibly jumping dimension?) while the 9th basepoint could a priori escape its enclosing oval. The difficulty looks so insurmountable that we have to abort the project.

■

In fact the following principle is worth noticing. It gives a basic lower bound on the degree of total pencils, yet as we saw the real difficulty is rather upper bounds! As a matter of annoying nomenclature crash, note that the degree of the pencil is not that of the allied map but that of its constituting curves, so we should perhaps rather speak of the order of a (total) pencil.

Lemma 18.5 (Poincaré-style lower bound on the order of total pencils) *Given a (smooth) (dividing) plane curve with a total pencil of k -tics with D many deepest ovals (i.e. the minimal elements of the nesting ordered structure). Then $D \leq k^2$ or $k \geq \sqrt{D}$.*

Proof. Each deep oval must enclose at least one singularity of the foliation. Remember that the latter is transverse to the curve by total reality. Poincaré's index formula (1882/85) says that the sum of all indices equates the Euler characteristic. Applied to the disc bounding a deepest oval this forces the latter to enclose at least one singularity of index +1. Warning: one must explain why the disc could not be foliated by say two singularity of index 1/2, so-called thorn singularities. The pencil has at most k^2 singularities of the foyer type (index=+1) materialized by the basepoints. Thus $D \leq k^2$. Indeed for each deepest oval chose one foyer inside it. We get a map from the set of deepest oval to that of basepoints, which is injective since the deepest ovals are disjoint at least for a smooth curve. Try to clarify if smoothness is really required as a hypothesis! ■

[30.10.12] Let us look at another intriguing example. Start again with 2 ellipses invariant under rotation by 90 degrees, and add a concentric circle as the dashed one on Fig. 32, but shrink its radius slightly beyond the critical radius where the circle passes through the 4 intersections of the 2 ellipses. Smoothing this configuration along our choice of arrows gives Fig. 33: a sextic with $r = 9$ ovals one of them enclosing all others.

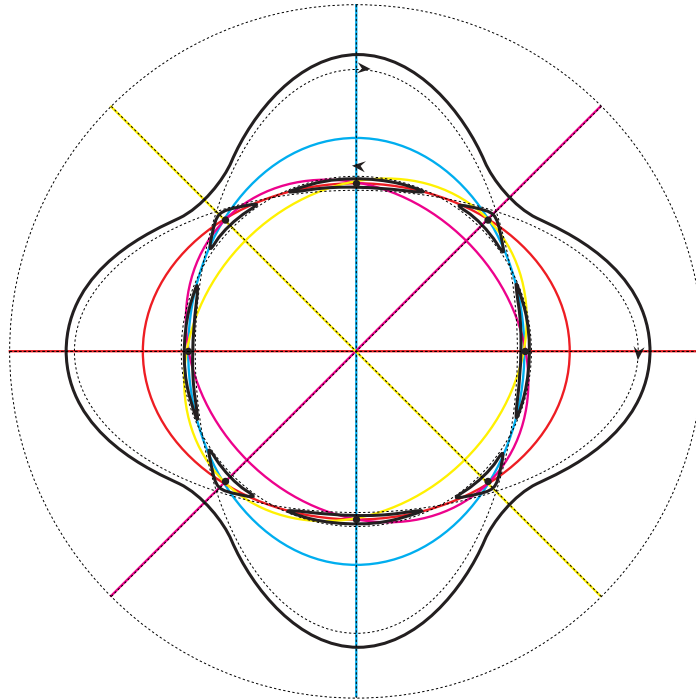

Figure 33: The archipelago: a sextic arising by smoothing 2 ellipses E_1, E_2 plus a circle of radius R pinched between the distance of E_i to the origin and that of $E_1 \cap E_2$ to the origin.

The picture has the annoying property that ovals are pretty small, challenging a bit the visual perception of homo habilis. Since the curve is dividing, Ahlfors theorem predicts the existence of a total map. It is evident that no pencil of lines, nor of conics, is total. (This is either optically clear or deduced from Poincaré's bound $k \geq \sqrt{D} = \sqrt{8} = 2.828\dots$, i.e. Lemma 18.5). The 8 deep ovals prompts seeking among pencil of cubics. Of course we may just assign 8 basepoints inside those deep ovals and hope for total reality. Yet to manufacture a concrete picture it is natural to assign basepoints in the most symmetric way. Once this is done one try to identify special singular curves passing through the 8 points. We find 4 degenerate cubics consisting of a line plus a conic (cf. colored curves on Fig. 33). Once those are detected it is an easy matter to interpolate between them (by continuity) to trace a qualitative picture of the pencil (Fig. 34).

This archipelago sextic C_6 has $g = 10$ as usual, and $r = 9$, thus $p = 1$. The total pencil can be lowered to degree $3 \cdot 6 - 8 \cdot 1 = 10$, as predicted by the $r + p$ bound.

[08.11.12] Again several questions poses themselves naturally. (The sequel uses some jargon of Rohlin 1978 [706], for instance the *real scheme* of a smooth plane real curve is the isotopy class of the embedding of its real locus in the real projective plane):

(1) Is any sextic C_6 belonging to the real scheme of the archipelago (i.e. 8 unnested ovals altogether surrounded by an outer oval) of dividing type? (The answer is probably known to Rohlin and students, especially if there is a non-dividing counterexample?) Rohlin distinguishes real schemes as definite or indefinite depending on whether all its representatives belongs to the same type or not, w.r.t. Klein's dichotomy (ortho- vs. diasymmetric). (cf. Rohlin 1978

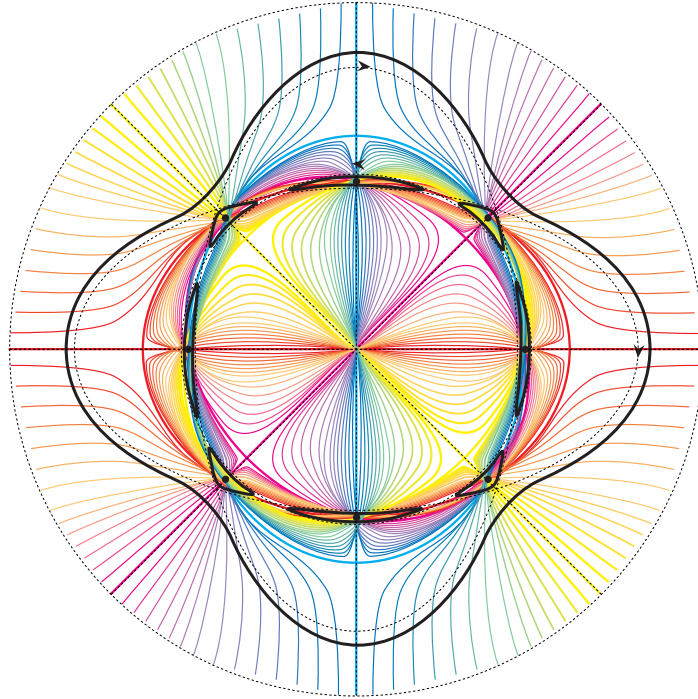

Figure 34: The archipelago sextic swept out by a total pencil of cubics with 8 basepoints in the deep ovals and one extra basepoint at the origin

[706]

(2) What is the exact gonality occurring in this archipelago scheme (of course restricting attention to dividing models in case the scheme is indefinite)? If we believe in Gabard’s bound $\gamma \leq r + p$, we have $9 = r \leq \gamma \leq r + p = 10$.

Perhaps answers are to be searched along the following direction. Maybe it is true that for any 8 basepoints (injectively) distributed in the 8 deepest ovals the corresponding cubics pencil is total. On counting intersections, we get roughly $8 \cdot 2 = 16$ many coming from the 8 deep ovals and the outer oval should also contribute for 2 intersections. This is at least evident if the real part of the cubics are connected since the real circuit of each such cubic has to go at “infinity” (in the sense of moving outside the outer oval, for otherwise it would be contractible inside the bounding disc of the latter, whereas we know the cubic circuit to realize an “odd” nontrivial class in the fundamental group $\pi_1(\mathbb{R}P^2)$ or just the allied homology). On the other hand, the cubic circuit must also visit the 8 assigned basepoint inside the outer oval, and so is forced to intercept the latter. We arrive at a total of 18 real intersections, the maximum permissible by Bézout ($3 \cdot 6 = 18$). Total reality would follow.

I remind vaguely of a standard result claiming that for a generic collection of 8 points there is a pencil of rational (hence connected) cubic interpolating them. (Cf. e.g. Kharlamov-Degtyarev survey ca. 2002). Now if all this is true, the archipelago scheme is dividing, and any such curve admits plenty of total cubics pencil of degree $3 \cdot 6 - 8 \cdot 1 = 10$ (essentially one for each selection of 8 points on the deep ovals). It seems however hard to lower the gonality γ up to the absolute minimum $r = 9$, but I know no argument.

18.2 Total reality in the Harnack maximal case

Quite paradoxically it is much harder to depict total pencils on Harnack maximal curves, alias M -curves (in Russia since Petrovskii 1938 [636], cf. Gudkov 1974 [323, p.18]), especially when the order is $m \geq 5$. (For lower orders $m \leq 4$ everything is essentially trivial: since $m = 4$ just requires a pencil of conics passing through the 4 ovals of the quartic (with $g = 3$.) Recall indeed that Ahlfors theorem is much easier in the planar case $p = 0$, where it goes back to Bieberbach-Grunsky, if not earlier. Logically the argument simplifies much via

Riemann-Roch and the absence of collision, cf. e.g. Gabard 2006 [255, Prop. 4.1] or Lemma 17.1 above in this text.

Shamefully, the following section climaxes the poor level of organization of the present text. Of course the game is quite outside the main stream of our subject (Ahlfors theorem), yet we think that some phenomena require to be clarified. In particular we were not able to make any reliable picture of a total pencil on a Harnack maximal (smooth) plane curve of order $m \geq 5$. After some three days of pictorial tergiversation we found a sort of weak obstruction to manufacturing such pictures involving a basic type of pencil spanned by two special cubics. This obstruction is described at the end of the section, which otherwise reduces to a messy gallery of failing attempts of the desired easy depiction! Yet the abstract theorem of Bieberbach-Grunsky implies the existence of total pencil but they probably involve delicate-to-visualize pencil of cubics (in the quintic case). We would like to challenge gifted amateurs to picture them appropriately.

Let us first recall the construction of such M -curves due to Harnack (in the variant of Hilbert). We start with degree 5. Consider as primitive configuration an ellipse E_2 plus a line L_1 . Take further 3 parallel lines l_1, l_2, l_3 . There is some psychological difficulties to know if we should first smooth $E_2 \cup L_1$ and then perturb along $l_1 \cup l_2 \cup l_3$ or if we can directly perturb $E_2 \cup L_1$ without taking care of smoothing. Let us adopt the shorter route (actually so do Hilbert) by putting directly $C_3 = (E_2 \cup L_1) + \varepsilon \vartheta_3$. This cubic (in black thick stroke) oscillates across the ellipse E_2 meeting it in the maximum number of 6 real points. Next smoothing their union (=product) $C_3 \cup E_2$ we get the (red-colored) quintic C_5 realizing the maximum number $r = 7(= g + 1)$ of ovals (one of them being in fact a pseudoline i.e. a Jordan curve in $\mathbb{R}P^2$ not bounding a disc).

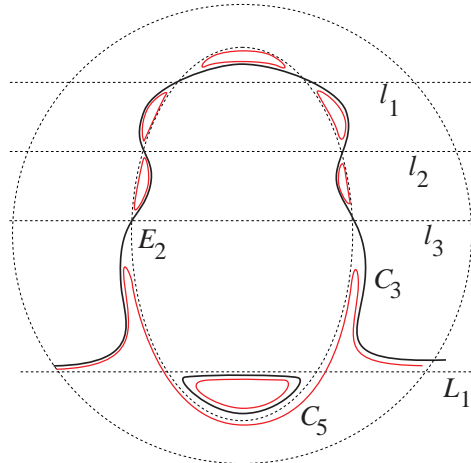

Figure 35: The Harnack-Hilbert oscillation trick creating a quintic with $r = 7$ real circuits

[31.10.12] Now the (perpetual) game is to find a total pencil on this dividing curve C_5 (recall that Harnack maximal curves are always dividing). As usual the recipe is to distribute imposed basepoints p_1, \dots, p_6 in the deepest ovals. Those are fixed once for all and marked by black points on Fig. 36. Since there are 6 ovals, pencil of lines or conics are not flexible enough to reveal the total reality of our C_5 . We thus have to look among pencils of cubics. In view of the (vertical) symmetry of the curve C_5 it is natural to seek a symmetric pencil. We shall define them by specifying two of its members. A first vertically symmetric cubic through the 6 base points is the union of the 3 cyan-colored lines. This special (cyan) cubic C_3 cuts our quintic C_5 twice along each oval and once on the pseudoline, hence in $12 + 1 = 13$ points. Those are at finite distance but looking at infinity both horizontal cyan lines cuts the pseudoline branch of C_5 in two extra points, yielding a total of 15 point, the maximum possible (all of them being real). Beside, we consider another vertically symmetric cubic, namely the red-colored cubic R_3 consisting of the red ellipse through 5 points p_i

plus the red horizontal line (denoted C) through the remaining p_i . We can now consider the corresponding pencil spanned by the cyan and red cubics (equation $\lambda C_3 + \mu R_3 = 0$). Unfortunately, the red cubic cuts C_5 along $2 \cdot 6 = 12$ points on the ovals and only once at infinity. Indeed the pseudoline branch of C_5 is asymptotic to the line D which in transverse to the red line C . Hence the intersection $R_3 \cap C_5$ is not totally real. Of course this defect does not prevent us from tracing the corresponding (non-total) pencil.

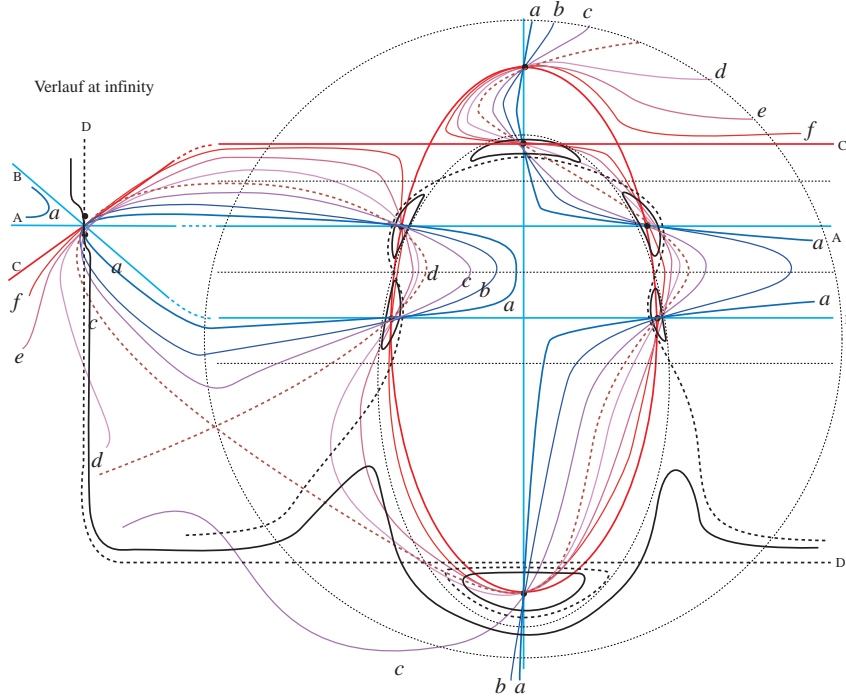

Figure 36: Trying to construct a total pencil on our M -quintic

Note.—A pencil of cubic may be defined by assigning 8 basepoints. By letting degenerate those against the 6 ovals (or the pseudoline) we get a series of degree $3 \cdot 5 - 8 \cdot 1 = 15 - 8 = 7$ as predicted by Bieberbach-Grusky (cf. e.g. Lemma 17.1). But it is far from evident to ensure total reality. Of course a coarse calculation would stipulate that the 6 ovals contributes for $2 \cdot 6 = 12$ many intersections and imposing 2 extra basepoints on the pseudoline gives 2 additional intersection, totalizing 14 many hence the last man surviving is forced to be real as well. This argument certainly holds good if we know that all cubics of the pencil are connected but a priori a cubic may well have an oval which could be nested in one of the tiny ovals of our sextic. If so is the case then this one cubic’s oval only visits one of the 8 basepoints, without spontaneous creation of intersection on one oval of the quintic C_5 . Maybe this scenario is quite improbable but I missed some argument.

A modest improvement over our previous attempt is to take a red-colored cubic satisfying total reality. This is given by changing the red-colored ellipse by taking the one passing through the 5 “highest” (relatively to our figure Fig. 37) black-colored basepoints. Symmetry forces us then to take an additional red-colored line passing through the “lowest” basepoint. We obtain the following Fig. 37. Alas it is not evident that total reality is satisfied.

A third option is to change the cyan configuration of 3 lines and we get the following Fig. 38, which alas again seems to fail total reality.

[01.11.12] Of course we would like ultimately to extend the game to sextic. Let us first reproduce a picture in Hilbert 1909 [378]. The idea is again that a union of two ellipses is vibrated into a quartic C_4 oscillating across one of the ellipse E_2 (which is a circle on Fig. 39, left), and next $E_2 \cup C_4$ is smoothed to a sextic with 11 ovals (compare Fig. 39, right).

Again the challenge would be to trace a total pencil of curves on this C_6 .

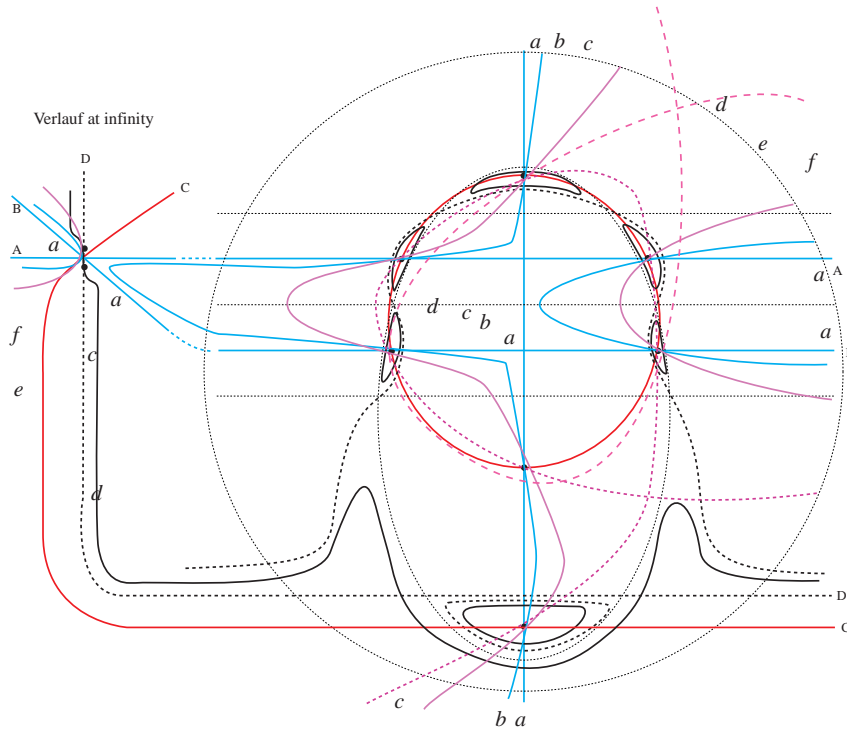

Figure 37: Trying to construct a total pencil on our M -quintic

We have 10 deep ovals, thus pencils of cubics look overwhelmed already with their only 8 assignable basepoints (and maximally 9 of them). Quartics have $\binom{4+2}{2} - 1 = 15 - 1 = 14$ free parameters hence we can impose 13 basepoints. Choosing them in the deep ovals and doing a parietal degeneration gives a series of degree $4 \cdot 6 - 13 \cdot 1 = 24 - 13 = 11$. This matches with the Bieberbach-Grunsky bound, however it is far from evident that total reality is ensured.

In general if C_m is a Harnack-maximal curve of order m , the previous examples (with $m = 5, 6$) suggest to consider auxiliary curves of degree $m - 2$ forming a space of dimension $\binom{(m-2)+2}{2} - 1 = \binom{m}{2} - 1$ and thus assigning $\binom{m}{2} - 2$ basepoints will define a pencil. By parietal degeneration the resulting series has degree $(m - 2)m - [\binom{m}{2} - 2]$, and this is easily calculated as being equal to

$$\begin{aligned}
 (m - 2)m - \left[\binom{m}{2} - 2 \right] &= (m - 2)m - \frac{m(m - 1)}{2} + 2 \\
 &= \frac{1}{2} [2(m - 2)m - m(m - 1) + 2] + 1 = \frac{1}{2} [m^2 - 3m + 2] + 1 \\
 &= \frac{(m - 1)(m - 2)}{2} + 1 = g + 1,
 \end{aligned}$$

where g is the genus. This again agrees with the Bieberbach-Grunsky theorem, but of course does not reprove it, be it just for the simple reason that smooth plane curves have specialized moduli among all curve sof the same genus. Still it would be exciting to manufacture tangible pictures of such total pencils in the planar case.

Now let us try again to do better pictures of the M -quintic. Any such M -quintic has 6 ovals and one pseudoline. By Bézout no three ovals can be aligned (otherwise 6 intersection with a line). Thus the six ovals are somehow distributed along a configuration resembling a hexagon. This raises some hope to draw reasonable pencil of cubics spanned by two configurations of 3 lines according to one of the following patterns (left of Fig. 40). This suggested to draw another model whose 6 ovals are nearly situated like a regular hexagon. A little piece of comment on the last Fig. 40r, of course we started with a circle divided primarily in 6 equal parts, and have chosen the 3 horizontal lines as passing through the cyclotomic points. Those three lines are those

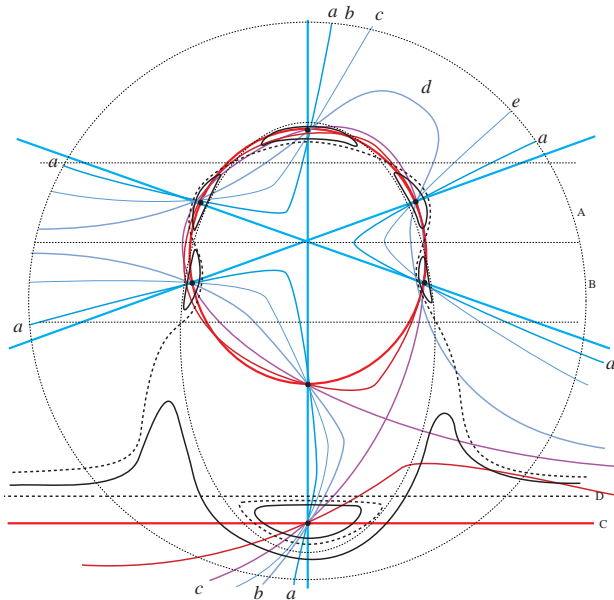

Figure 38: Failing again to construct a total pencil on our M -quintic

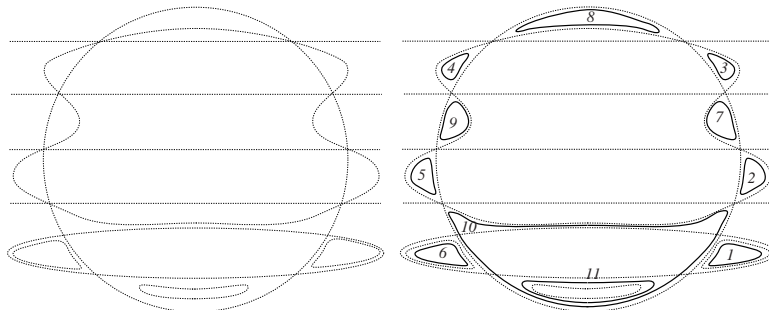

Figure 39: Hilbert's picture of an M -sextic: just vibrate and smooth!

used for the Harnack-Hilbert vibration trick, and the rest of the picture should be self-explanatory. Alas the bottom portion is quite difficult to observe. Yet a clear-cut portrait of Lars Valerian clearly emerges: the bottom oval is the mouth, then just above two big eyes “with an air of determination”, as well as some hairs emanating from the beret. In fact the portrait looks more like an alien, but the resemblance with Lars is much more flagrant when the circle is depicted as a “vertically oblong” ellipse. [I apologize for adding some extra prose as otherwise the figures desynchronize from the text.]

Now we consider the following pencil spanned by the cyan and red collections of lines (Fig. 41). Alas it fails to be totally real, for it contains the green cubic cutting only 13 real points on the quintic C_5 . Of course the advantage of our pencil is that it is simple to draw, yet its disadvantage is that it has only 6 among the 8 assignable points located on the quintic. Somehow one should try to conciliate both properties.

Testing the other configuration (of 2 pairs of 3 lines through the hexagon) one gets Fig. 42. The situation is not much improved. Now the 3 additional basepoints (intersection of pairs of parallel lines) are ejected at infinity but are not lying on the (black-colored) quintic curve C_5 whose pseudoline is asymptotic to the horizontal line. The corresponding pencil of cubics (spanned by the cyan and red colored lines) is probably not total, for it should contain a nearly circular ellipse through the hexagon plus the line at infinity, and the aggregated corresponding cubic seems to cut the C_5 only along 12, plus one at infinity, so a total of only 13 real points!?

One can also make the following picture Fig. 43, where the 3 additional basepoints are marked by circles, one of them lying, alas, quite outside the range of the picture. A possible, yet delicate, desideratum would be to distort the

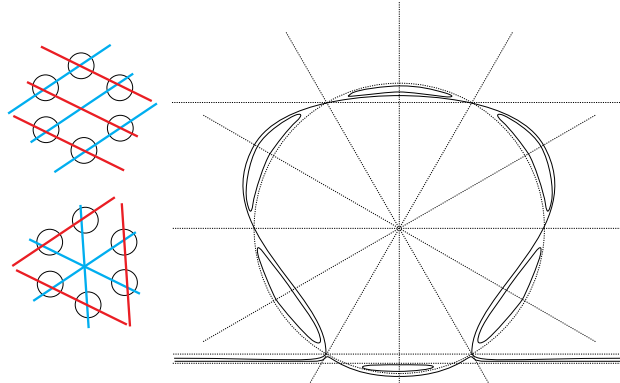

Figure 40: An M -quintic with hexagonal distribution of ovals

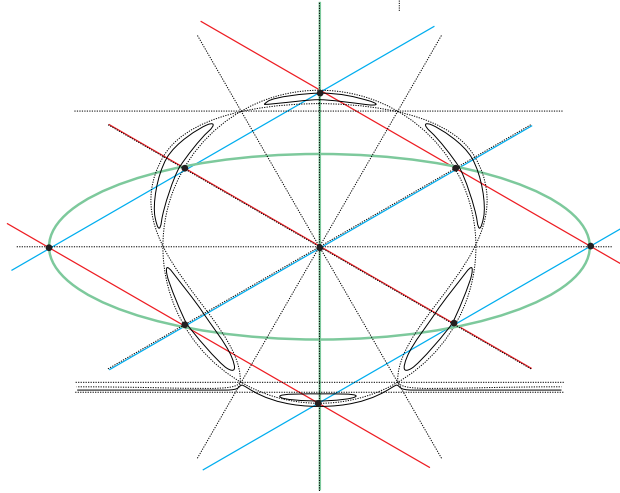

Figure 41: Total reality fails again!

configuration (pair of 3 lines arrangements) so that 2 of those circled basepoints lands on the quintic C_5 . Then we would get a good candidate for an easy to depict total pencil of cubics on our quintic. Evidently this desideratum is probably impossible to arrange (a so-called “Irrweg”).

Maybe another arrangement worth looking at is the following Fig. 44. Now among the 3 extra basepoints at least one (that one corresponding to the intersection of both horizontal lines) is located on the quintic C_5 (at infinity). Hence 13 points are ensured to be real for all members of the pencil. It is easily checked that both fundamental curves of the pencil (cyan and red cubics) cut the C_5 in a totally real fashion (15 real points). For symmetry reasons (along the axe at 120 degrees) the nearly circular ellipse through the 6 points at finite distance plus the line at angle 120 degrees belongs to the pencil, but alas its intersection with the C_5 it hard to understand. Note by the way that the hexagonal configuration of 6 points is slightly perturbed thus there is no perfectly well defined such ellipse. At this stage the whole exercise is akin to a dolorous acupuncture session. Note that our symmetry deduced member of the pencil has the wrong behavior through the basepoints at infinity, hence the right curve belonging to the pencil includes rather the line at infinity (or at least a slight perturbation thereof). Thus we count 12 intersections with the oval coming from the nearly circular circuit, and just one intersection at infinity. This underscored total of 13 seems to indicate that this pencil again fails total reality.

Albeit our exposition is not from the best stock, we hope at least to have demonstrated that the synthetic construction of total pencils on M -curves is not an easy matter. Of course it is not improbable that I missed something fairly easy!

Isoperimetric digression. During the session I wondered if the following

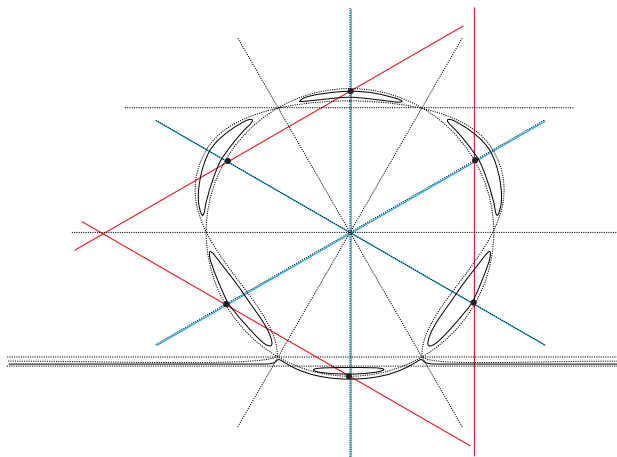

Figure 42: Total reality fails again (for radioactive configuration of lines)!

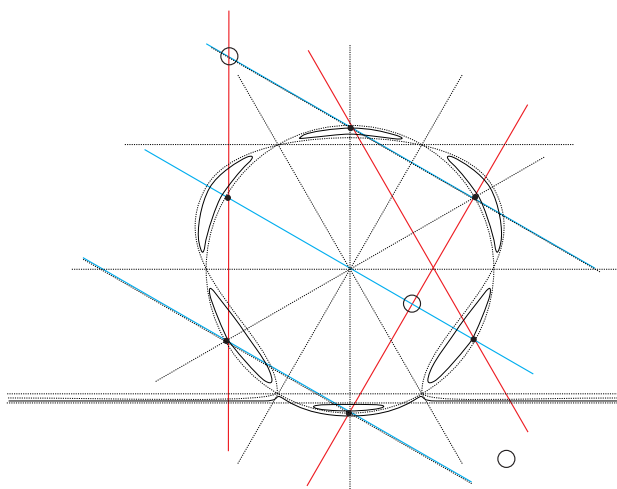

Figure 43: Another attempt!

problem makes sense. One of the notorious difficulty when trying to do real pictures of algebraic curves is that some ovals tend to be microscopic (especially for Harnack maximal curves). Is there some optimal curve best suited for depiction? Admittedly the problem makes sense only for Euclidean affine models as opposed to projective curves (which could be pictured on the sphere up to a double cover). One could for instance ask the curves to enclose maximum area for a given length of the circuits. (Of course this makes sense only for curves of even degrees, except if we neglect the pseudoline.) This would be a sort of isoperimetric problem for curves competing among algebraic ones (of some fixed degree). Of course for degree two the isoperimetric solution is the circle. What about degree 4? A candidate is perhaps the Fermat curve $x^4 + y^4 = 1$ whose real picture is somewhere between a circle $x^2 + y^2 = 1$ and a square $x^\infty + y^\infty = 1$. Of course one could argue that the optimal quartic is just a circle counted by multiplicity 2, but then the length of the circuit has to be counted twice. We have no certitude that our problem is well posed, nor that it is truly interesting. The naive scenario would be that the optimum is always the Fermat curves of higher even orders, yet what about M -curves? Maybe we need to restrict the problem to them, and ask for the best Euclidean realization of an M -curve? So for instance what is the best M -quartic? The best M -quintic? Does it looks like Ahlfors' portrait (on Fig. 40)?

Let us a last time return to our main problem of tracing a totally real pencil for an M -quintic. Remember once more that theoretical existence is ensured by the baby case (Bieberbach-Grunsky) of Ahlfors theorem on circle maps. Our dream would be that for such a quintic there is a simple-to-draw pencil generated by 2 configurations of 3 lines. Psychologically it is helpful to reverse

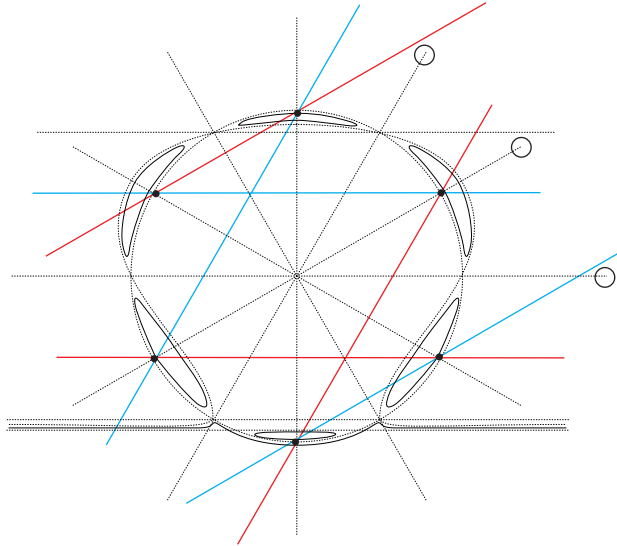

Figure 44: Another figure raising some hope but soon failing again!

the viewpoint. Instead of starting from the quintic M -curve C_5 and trying hard to depict the pencil, we shall start from the pencil and try to construct a curve tailored to it.

So we consider the pencil generated by 2 systems of parallel lines (colored cyan and red) with 9 base points (multicolored intersections) and try to build around this perfectly explicit pencil (cf. the previous Fig. 32 Fig. 45b below) a quintic having the following schematic picture (Fig. 45a). This is to mean that each of the 6 ovals encloses one of the 9 basepoints, with the Bézout restriction that no aligned triad are enclosed (else 6 intersections in C_5 with a line) and further the pseudoline passes through 2 other basepoints. If such a “real scheme” (Rohlin’s jargon) exists then each curve of the pencil will cut on the C_5 a total of 15 real points. Indeed the 6 ovals contribute each for twice (now Fig. 45b ensures connectedness of all cubics forming the pencil!) and the pseudoline for 2, hence a total of 14 and the last one is forced to be real as well (for algebraic “Galois theoretic” reasons).

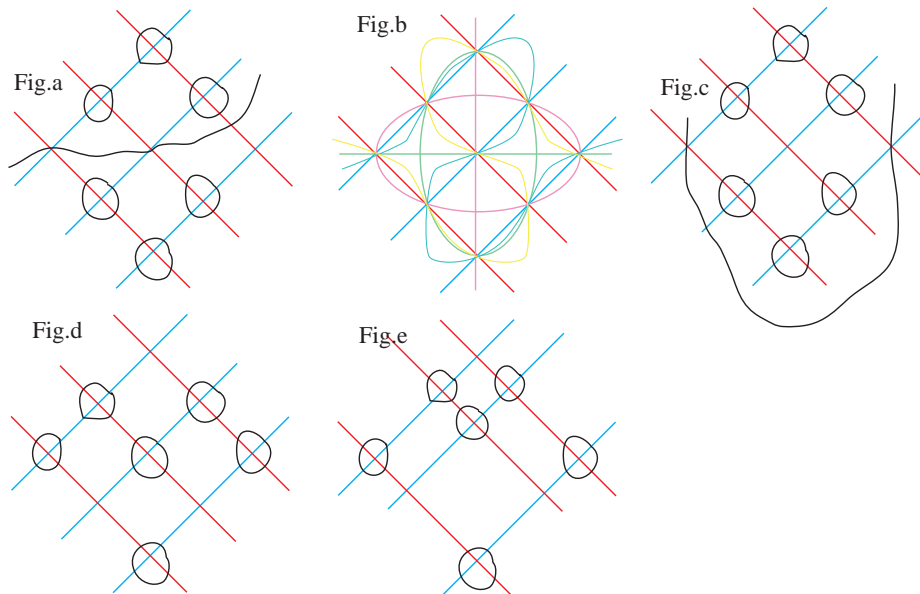

Figure 45: Trying to find an obstruction

So exhibiting this scheme would complete our goal. Note the absence of Bézout-type obstruction to the posited real scheme (Fig. 45a). Yet maybe there is deeper topological obstructions involving say the foliation underlying the pen-

cil. In fact the argument is more modest. The two basepoints connected by the pseudoline are separated by the green ellipse. So the arc joining them (choose one!) is forced to have an extra intersection with the green ellipse (on Fig. 45b). Topology forces the creation of a second intersection (intuitively the pseudoline once trapped in the green ellipse has to escape it). Thus we arrive at a total of 12 (6 ovals), plus the 2 assigned basepoints on the pseudo-line and plus the 2 extra-points just created. This gives 16 intersections between C_5 and the green cubic (enough to overwhelm Bézout). This prohibits the desired scheme.

Another (a priori) tangible real scheme is the one depicted on Fig. 45c. Then it seems that arguing with the lilac conic we may repeat something like the previous argument. More precisely, if the pseudoline never penetrates inside the lilac ellipse L_2 then it has to be tangent to it at the 2 assigned basepoints but this gives already 4 extra-points which added to the 12 God-given produce an excess $16 > 15!$ Thus we may assume the pseudoline P to penetrate in the lilac ellipse (total of 13 intersection). Then several cases may occur. If P tries to evade from the lilac ellipse L_2 then we have 14 intersections, yet it must still pass to the second basepoint and (being now outside the L_2) this creates at least 2 intersections (counted by multiplicity). So eventually the pseudoline P is forced to reach the other basepoint while staying inside the lilac L_2 , and hence to cut the lilac axis of this ellipse. The latter axis being contained in the inside of the green ellipse, we get again 4 extra intersections with the green cubic (beside the 12 arising de facto from the ovals); too much for Bézout.

All this (if correct?, and suitably simplified!) should prove the following:

Proposition 18.6 *It is impossible to sweep out in a totally real fashion an M -quintic via a basic pencil of cubics spanned by two arrangements of parallel lines.*

If true and suitably generalized to other configurations (see ★ right below) this explains perhaps why we had so much trouble to make an appropriate depiction of the desired pencil. Again totally real pencils exist in abstracto hence in concreto, yet are probably of a somewhat more elaborated vintage.

[02.11.12] ★ For instance it should be noticed that there is another possible scheme (distribution of 6 ovals) satisfying the “no-three-in-line” condition prompted by Bézout. This is depicted on Fig. 45d which is admissible provided the horizontal diagonal is not aligned. Hence the real picture looks rather like Fig. 45e. Of course it would be too cavalier to claim that the previous obstruction to the case at hand as the ellipses were destroyed during the process.

We leave the problem in this very unsatisfactory state of affairs, but let us perhaps try to motivate why the explicit depiction project could be fruitful!

From the viewpoint of gravitational systems (cf. the previous Section 18.1) the interest of M -curves is that they express in some sense the most complex orbital structure permissible for a given genus (at least the maximum number of real circuits). Hence if Metatheorem 18.1 is reliable such M -curves should display some remarkable motions. The intricacy of the trajectories is already suggested by Hilbert’s M -sextic on Fig. 39. However until the total pencil (of Bieberbach-Grunsky-Ahlfors) is not made explicit the dynamics of the electrons is imbued by mystery and darkness. Remind from Bieberbach-Grunsky (=Lemma 17.1) that Hilbert’s M -sextic is not only static object but one animated by a circulation (total pencil) having one electron on each oval. We can from the static picture vaguely try to guess where repulsions take places and arrive at something like Fig. 46.

On Fig. 46, italics numbers enumerate ovals while roman numbers indicates positions at various times 1, 2, 3, 4. Note that our Harnack maximal curve being dividing, it has a complex orientation (as the border of one half). This orientation agrees with that inherited from the smoothing. Further it has to be respected by the circulation due to the holomorphic character of the (Bieberbach-Grunsky) circle map. Having this in mind it is straightforward to make the picture above (Fig. 46) using the rule that whenever a repulsion is observed

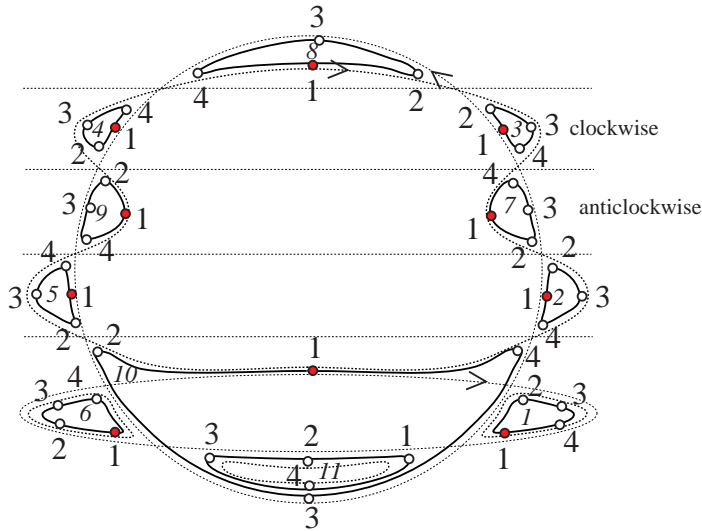

Figure 46: Trying to guess the dynamics from the static locus

then electrons must be in close vicinity and thus any pair of points minimizing the distance between two neighboring ovals must be synchronized, hence labelled by the same time unit. In contrast when two close ovals do not repulse them (like ovals 1 and 10) then they must be anti-synchronized in the sense that both particles do not visit the contiguity zone at the same moment. For instance there is also a repulsion between electrons on ovals 1 and 11 at time 1. So far so good. However on completing the picture one sees between ovals 6 and 11 some anomalous (asynchronic) repulsion. Maybe one can explain this via distant repulsion involving other particles of the system (especially the electron on oval 10).

All this is very informal and saliently illustrates the sort of obscurantism caused by a lack of explicit knowledge of the total pencil. This perhaps motivates once more to complete the programme of the present section (construction of total pencils in Harnack maximal cases). Ultimately one could dream of a computer program showing in real time the circulation of electrons prompted by the Bieberbach-Grunsky Kreisabbildung(en) along an Hilbert M -sextic.

Let us finally observe that there are other M -sextics (Harnack's, Hilbert's and even Gudkov's). Basically the one we depicted (Hilbert's) is obtained by smoothing the configuration $E_2 \cdot C_4 = 0$ consisting of an ellipse E_2 (circle on the picture) and an M -quartic C_4 one of whose oval oscillates across the ellipse E_2 . It may be noticed that the oscillating oval lies mostly inside the ellipse (cf. the left-top part of Fig. 47). [This schematic—yet Bézout compatible—style of depiction is borrowed from Gudkov 1974 [323, p. 20].] One can reverse this situation, by putting the vibrating oval outside the ground ellipse to get another M -sextic (cf. the right-top part of Fig. 47). A concrete construction this is achieved on the bottom part of Fig. 47).

This curve has one “big” oval enclosing nine “small” ovals and the other lies outside. Of course if our metatheorem (18.1) is plausible then it is challenging to interpret the dynamics especially the orbit along this long oval enclosing all others but one. Of course this would essentially boils down to visualize a total pencil for this C_6 .

Finally let us make a little remark. We see that there must a deep reaching connection between Ahlfors theory of circle maps and the extrinsic geometry of real dividing curves, the link being given by the notion of total pencil. Another basic application of total pencils could arise in curve plotting problems. Assume given an algebraic equation $f(x, y) = 0$ and a machine supposed to make a plot of the real locus. Suppose e.g. that the polynomial has degree 5, defines a smooth curve and that we have already traced within reasonable accuracy 2 ovals and a pseudoline and finally that both ovals are nested. Then the theory

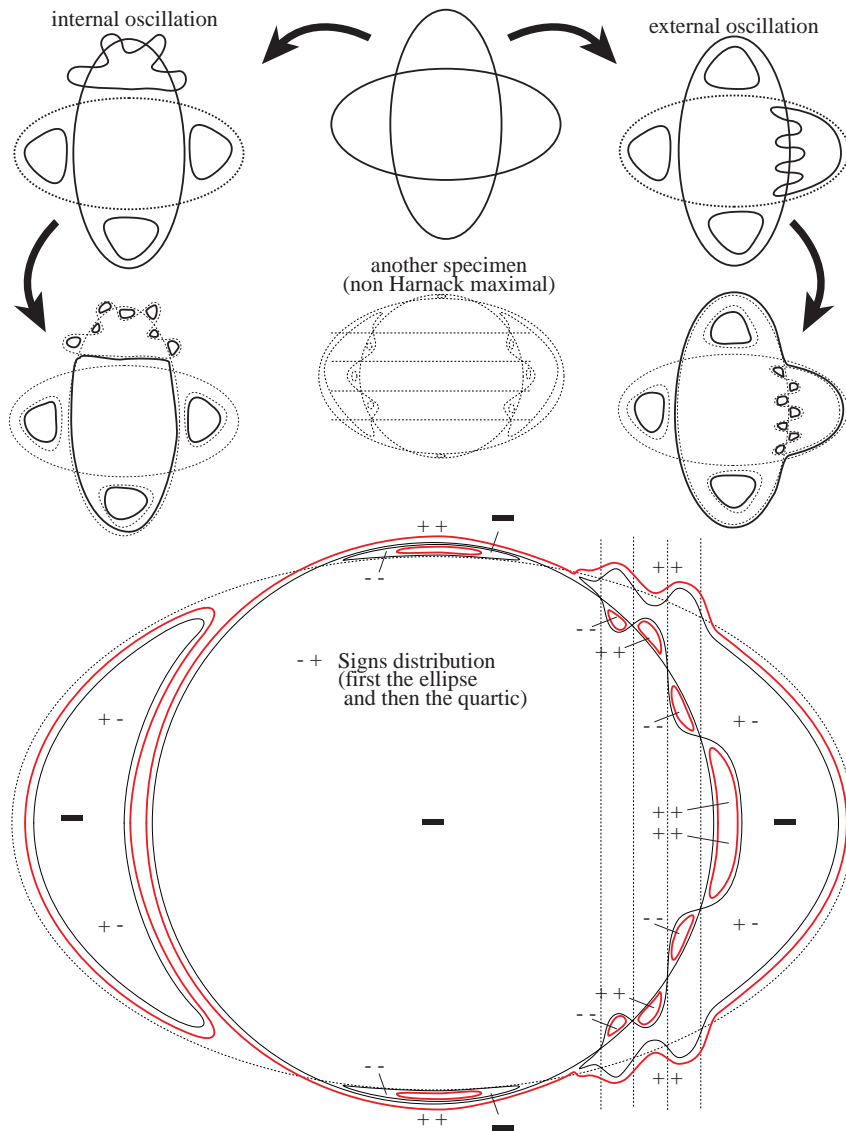

Figure 47: Two constructions of M -sextics (Harnack and Hilbert) in Walt-Disney mode of depiction borrowed by Gudkov 1974 [323, p. 20].

of total maps (but in fact Bézout suffices) ensures that the real locus has already been exhausted and we may stop the “root finding” algorithm. Of course the story becomes even more grandiose on appealing to Newton-Cayley iteration method and the allied fractals appearing as attracting basins. Likewise if an octic has 4 nests of depth 2 its real locus has already been exhausted (compare Fig. 31). Indeed in that case the pencil of conics through the 4 deeply nested ovals imposed to pass through another hypothetical point would create an excess of $8 \cdot 2 + 1 = 17 > 16$ intersection points.

18.3 A baby pseudo-counterexample in degree 4

We now give an example in degree 4. The recipe is always is the same and we get the example 102 below (Fig. 48). It has $g = 0$, $r = 1$, thus $p = 0$. At first glance the visual gonality as measured via a pencil of lines is $\gamma^* = 2$ (projection from one of the nodes). This seems of course to violate Gabard’s bound $\gamma \leq r + p$. However using a pencil of conics passing through the 3 nodes plus the point (labelled 8 on the figure) gives a total pencil of the right degree. Of course the example is a paroxysm of triviality, yet it is still a nice case to visualize the

fairly complex dynamics of total pencils. The forward semi-orbit of the series is depicted by points $1, 2, \dots, 8$ after which the motion reproduces symmetrically.

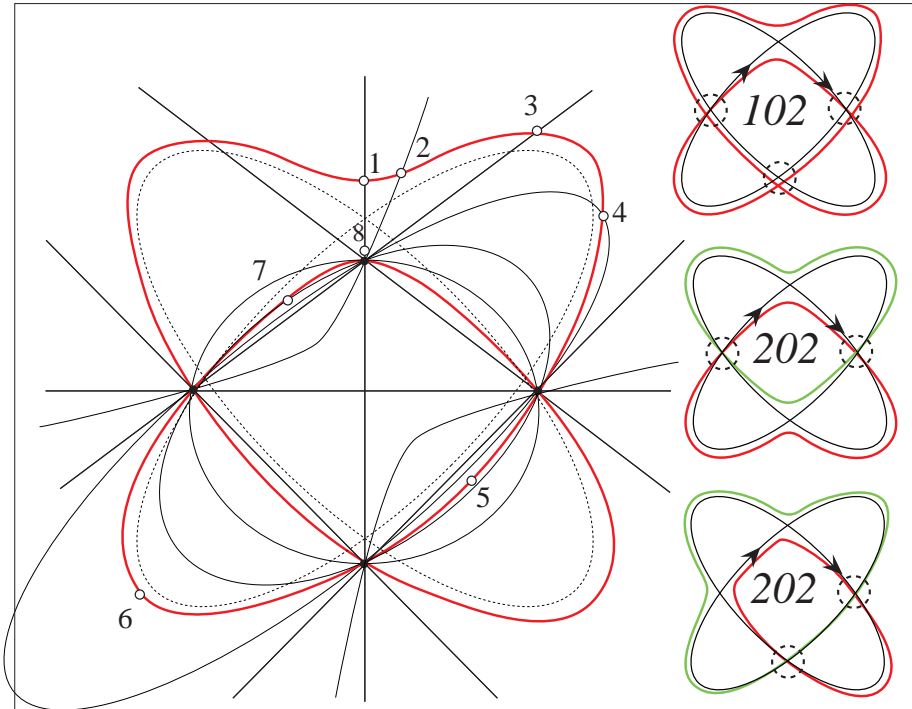

Figure 48: Tracing a totally real pencil of conics on an orthosymmetric quartic

Another example arises when we keep less singularities unsmoothed. We obtain so a linkage of “heartsuits” (cf. the middle picture 202 on Fig. 48). Now $r = 2$, $g = 3 - 2 = 1$, and so $p = 0$. A linear projection from one of the 2 nodes suffices to exhibit total reality, and so the gonality is $\gamma = 2$. One can still trace pencils of conics through the nodes plus 2 extra points on the curve to get series of degree $2 \cdot 4 - 2 \cdot 2 - 2 \cdot 1 = 8 - 4 - 2 = 2$. Those gives more maps realizing the gonality. Of course one can also materialize such a curve as a smooth plane cubic, in which case we also see ∞^1 total pencils induced by linear projection from the unique oval. (Projecting from the pseudo-line, the oval of the cubic has some “apparent contour” and total reality fails.) One can also get the bottom picture 202 on Fig. 48, which has the same invariants.

18.4 Low-degree circle maps in all topological types by Harnack-maximal reduction

[Source=Gabard 2005, Chambéry talk (unpublished as yet)] Once Ahlfors theorem is known in the simple Harnack maximal case (cf. Lemma 17.1) one can easily exhibit in any topological type some very special surfaces (in Euclid’s 3-space) admitting a circle map to the disc having very low degree. Of course this is far remote from reassessing the full Ahlfors theorem, yet it is an interesting construction, which perhaps could lead to a general proof when combined with some Teichmüller theory. But this is only a vague project we shall not be able to pursue further.

Let us start with a membrane in Euclidean 3-space (endowed with the conformal structure induced by the Euclidean metric). Suppose the surface invariant under a symmetry of order two (cf. Fig. 49). The key feature of this figure is that the axis of rotation “perforates” each “hole” of the pretzel. Hence, when taking the quotient all handles are killed, and we get a proper(=total) morphism to a schlichtartig configuration (i.e. of genus $p = 0$). This in turn admits a circle map of degree equal to the number of contours (by the Bieberbach-Grunsky theorem=Lemma 17.1).

The composed mapping gives a circle map of degree $2 \cdot \frac{r}{2} = r$ when r is even, and of degree $2 \cdot \frac{r+1}{2} = r + 1$ if r is odd. (Compare again Fig. 49.)

Of course this has little weight in comparison to the general theorem of Ahlfors (1950 [17]), yet it is a simple example showing that the degree of circle maps can be fairly lower than the degrees $r + 2p$ or even $r + p$.

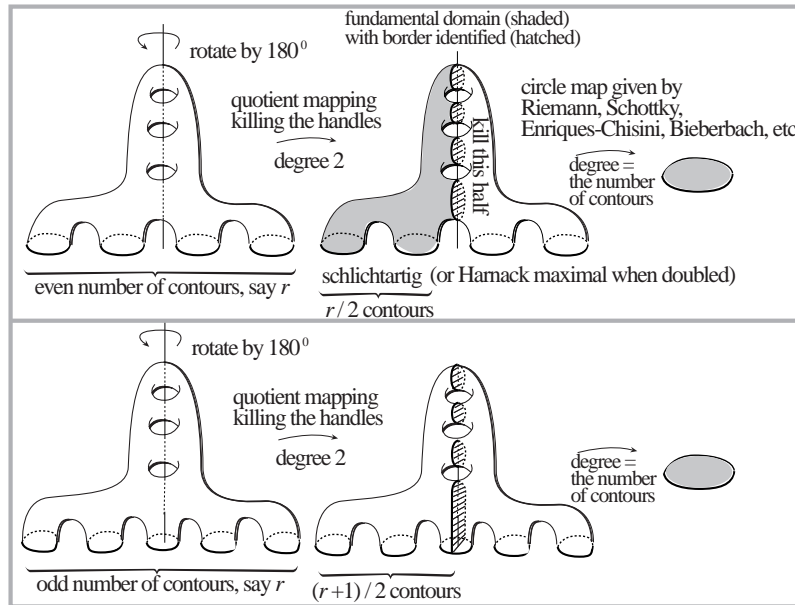

Figure 49: Low-degree circle maps for pretzels with 2-fold rotational symmetry

18.5 Experimental evidence for Coppens' gonality

[24.03.12]/[19.10.12] In this section we discuss Coppens result (2011 [183]) on the realizability of all gonality compatible with the $r + p$ bound (Gabard 2006 [255]) on the degree of an Ahlfors circle map. Our superficial approach will not recover Coppens full result, yet is worth presenting for it enhances the depth of Coppens' result. Looking at explicit projective models of Riemann surfaces always makes Riemann-type existence theorems (like Ahlfors maps) look quite formidable jewels (not to say miracles) when looked at experimentally through the Plato cavern of extrinsic algebraic geometry. The game is also pleasant because sometimes one gets the impression that Gabard's bound $r + p$ looks blatantly violated. Also interesting is the issue that such basic experimental studies (akin to the CERN particles collider at a modest scale) are quite useful for understanding the failure of connectivity of the space of minimal circle maps (those of lowest possible degree). Further experiments should contribute to add some valuable insights over Ahlfors' theory. (A. Einstein puts it as follows: "Any knowledge of the world starts and ends with experiments.")

Coppens' result is the following. To stay closer to Ahlfors' viewpoint, we paraphrase it in the language of *compact bordered Riemann surfaces* (abridged membranes) instead of that of real dividing curves. Albeit most of our examples are derived via algebraic geometry, we will never have to write down any (boring) equation due to the graphical flexibility of plane curves à la Brusotti/Klein/Plücker (reverse historical order). So we are drifted to a sort of synthetic geometry.

Theorem 18.7 (Coppens 2011 [183]) *Given any two integers $r \geq 1$ and $p \geq 0$, and any integer γ satisfying $\max\{2, r\} \leq \gamma \leq r + p$, there is membrane $F_{r,p}$ with r contours of genus p whose gonality is the assigned value γ .*

Recall that the gonality of the membrane is understood as the least degree of a circle map from the given membrane (to the disc).

- For $(r, p) = (1, 0)$, the statement becomes vacuous, but of course we can alter the range of permissible values as $r \leq \gamma \leq r + p$.
- When $p = 0$, γ can take only the value r and the latter is realized via the Bieberbach-Grunsky theorem (Lemma 17.1).
- For $(r, p) = (1, 1)$, the double has genus $g = (r - 1) + 2p = 2$ hence is hyperelliptic. This actually proves the existence of a circle map of degree 2 ($= r + p$) in accordance with Gabard's bound $r + p$. Coppens's realizability theorem is trivially verified in this case for γ can only assume value 2.
- For $(r, p) = (2, 1)$, the range of γ is $2 \leq \gamma \leq 3$. The value $\gamma = 2$ is realized by a hyperelliptic model. The value $\gamma = 3$ is obtained by considering a smooth quartic C_4 with two nested ovals while projecting it from a point on the innermost oval. This gives a *totally real* morphism of degree 3. Total reality means that fibers above real points consists entirely of real points. We use also the abridged jargon *total map* which is quite in line with terminology used by Stoilow 1938 [800] or Ahlfors-Sario 1960 [22], who use "complete coverings".

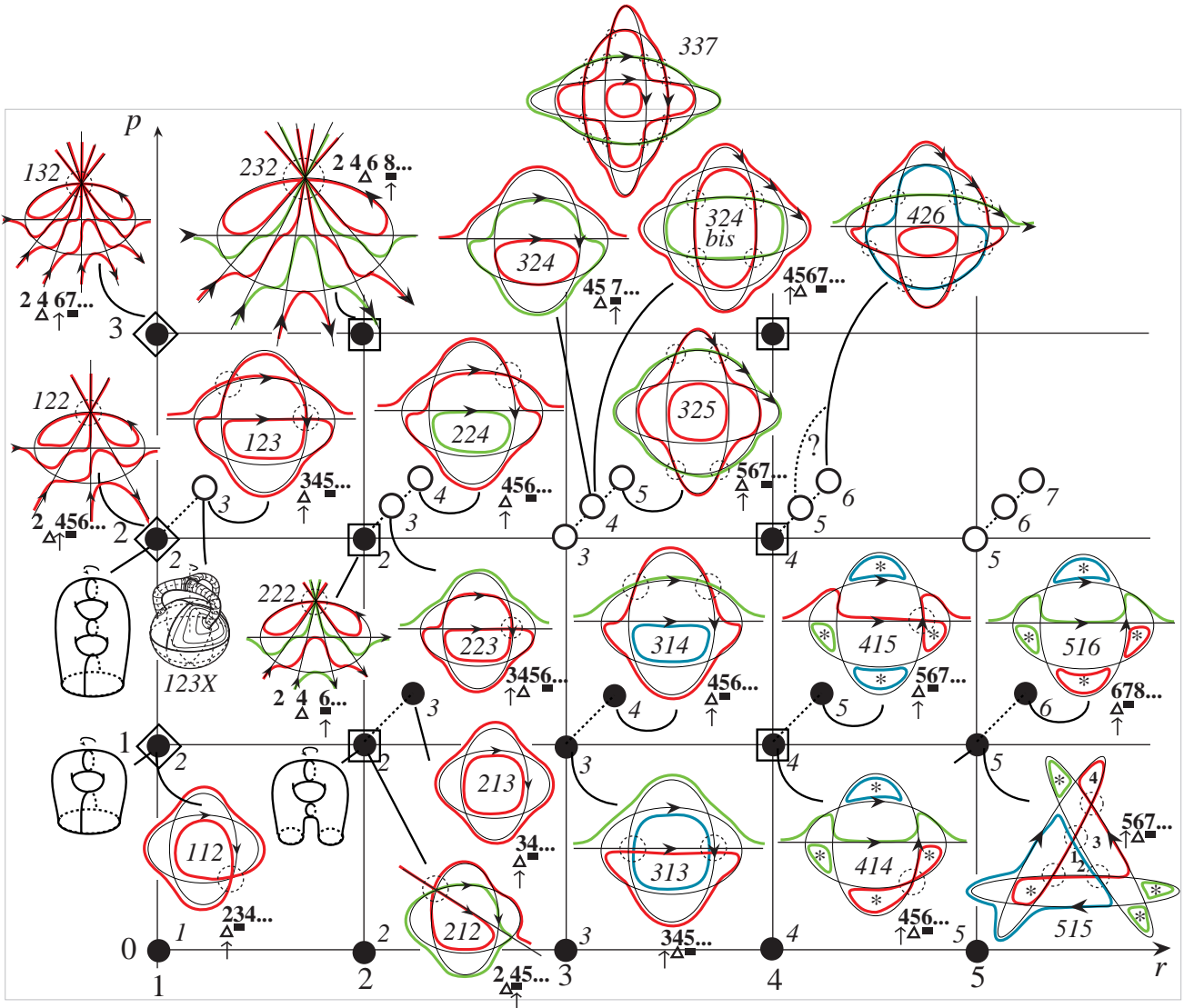

Figure 50: Tabulation of bordered surfaces with assigned gonality: for each value (r, p) the array of permissible gonalities is depicted as a dashed line imagined as lying over the grid. Italicized integers indicate the corresponding gonality.

- For $(r, p) = (3, 1)$, the genus of the double is $g = (r - 1) + 2p = 2 + 2 = 4$. This is not the genus $g = \frac{(m-1)(m-2)}{2}$ of a smooth plane curve of order m which belongs to the list $0, 1, 3, 6, 10, \dots$ of triangular numbers, yet suggests looking

at a quintic C_5 with two nodes. We thus consider a configuration of two conics plus a line and smooth it out in an orientation preserving way (so as to ensure the dividing character of the curve by a result of Fiedler 1981 [235]). We obtain so the curve depicted on Fig. 50 bearing the nickname 313. This actually encodes the value of the invariant (r, p, γ) written as the string $rp\gamma$, yet a priori the gonality γ is not known and its value must be justified. On that figure 313 the dashed circles indicate those crossings that were *not* smoothed. The half of this curve is a bordered surface of type $(r, p) = (3, 1)$, since $p = [g - (r - 1)]/2$. It remains to evaluate its gonality. The idea is always to look at the curve from the innermost oval. In the case at hand, we project the curve from one of the two nodes to get a total morphism of degree $5 - 2 = 3$. Since $r = 3$ is a lower bound on the gonality γ , it follows that $\gamma = 3$, exactly. Note that this example seems to *answer in the negative our question about the connectivity of the space parameterizing minimal circle maps*. Further one can drag one point to the other while travelling only through *total* maps of degrees 4 (namely projections from points located in the intersection of the interiors of the blue resp. red ovals). [09.11.12]—*Warning*. Remember that a similar picture (Fig. 48, right-middle part) gave an example where the curve looked 2-gonal in only 2 ways, but another model of the curve (as a plane cubic) prompted the same gonality in ∞^1 fashions. So some deeper argument is required either to assess (or disprove) the italicized assertion.

Next, still for the same topological invariants $(r, p) = (3, 1)$, we would like to find a membrane of gonality $\gamma = 4$. This may be obtained from the same initial arrangement while moving the location of the dashed circles (of inert crossings) to get picture labelled 314 on Fig. 50. The corresponding quintic projected from a point situated on the inner (blue-colored) oval has $\gamma \leq 4$. Over the complexes, this quintic has gonality $\gamma_{\mathbb{C}} = 3$ (projection from one of the nodes) and this is the only way for the curve to be trigonal. Yet over the real picture (our 314) none of these (trigonal) projections is total (since the inner oval has an apparent contour, i.e. some tangent to it passes through the node). It follows that $\gamma = 4$, exactly.

- Let us next examine $(r, p) = (4, 1)$. Then $g = (r - 1) + 2p = 5$, so we look at quintics with one node. To create as many ovals, it proves convenient to reverse the orientation of one of the conics. We obtain so the figure coded 415. After noting that $r = 4$, we project the curve via a pencil of conics assigned to pass through 4 points chosen in the innermost ovals (asterisks on the figure). Letting those 4 points degenerate against the ovals while exploiting the possibility of pushing one of them toward the node (so as to lower by 2 units the degree) we find $\gamma \leq 2 \cdot 5 - 3 \cdot 1 - 1 \cdot 2 = 10 - 3 - 2 = 5$. Over the complexes, the curve at hand (uninodal quintic) is trigonal only when seen from its unique node and 4-gonal only when projected from a smooth point. Inspection of the figure shows that none of these maps is total. It follows that $\gamma = 5$ exactly.

It remains to find an example with $\gamma = 4$. For this we just drag below the dashed circle (cf. label 414 on Fig. 50), do the prescribed smoothing (always in the orientation consistent way). The resulting curve has $r = 4$ (as it should). The novel feature is that the node is now accessible from 2 basepoints of the pencil of conics assigned in the deep ovals. This permits a lowering of the degree to $\gamma \leq 2 \cdot 5 - 2 \cdot 1 - 2 \cdot 2 = 10 - 2 - 4 = 4$. Remarking that the unique morphism of lower degree 3 (linear projection from the node) is not total we deduce that $\gamma = 4$ exactly. The other morphisms of degrees 4 (namely projections from real points on the curve) obviously fails to be total, thus we infer that the curve (or the allied membrane) is uniquely minimal (i.e. there is a unique circle map of minimum degree).

Before embarking on larger values of the invariants (r, p) , we make a general remark, related to the previous Section 18.4. There a suitable membrane in 3-space invariant under rotation by $\pi = 180^0$ with a totally vertical array of handles (cf. Fig. 49) showed the following:

Lemma 18.8 (Barbecue/Bratwurst principle) • *If r is even, there is for any*

value of p a membrane of type (r, p) admitting a circle map of degree r (the minimum possible value), whose gonality is therefore $\gamma = r$ exactly.

- If r is odd (p arbitrary), there is a membrane of type (r, p) admitting a circle map of degree $r + 1$, whose gonality γ is therefore $r \leq \gamma \leq r + 1$. (Alas, the exact value remains a bit undetermined!)

This lemma fills quickly several positions of our Fig. 50, namely those marked by a square. In the special case $r = 1$ (belonging to the indefinite odd case), we can get rid off the annoying indetermination, because as soon as $p \geq 1$ the minimal value r of the range $r \leq \gamma \leq r + 1$ cannot be attained. Corresponding invariants are reported by rhombuses (squares rotated by $\pi/4$) on Fig. 50.

- Next we study $(r, p) = (5, 1)$. Then $g = (r - 1) + 2p = 6$, prompting to look at smooth quintics (without nodes). Consider the curve denoted 516 on Fig. 50, which has $r = 5$. When projected via a pencil of conics through the assigned 4 basepoints (depicted by asterisks on the figure) and letting them degenerate toward the ovals gives a total map of degree $2 \cdot 5 - 4 \cdot 1 = 10 - 4 = 6$. Hence $\gamma \leq 6$. Morphisms of lower degrees exist in degree 4 (linear projection from a point situated on the curve), and degree 5 (projection from points outside the curve). Clearly none of these maps is total, so that $\gamma = 6$ exactly. Of course the minimal degree maps considered are plenty (no uniqueness), yet their parameter space is connected.

Next we require a specimen with $\gamma = 5$. It seems evident that we have exhausted the patience of quintics (at least for the given arrangement), hence let us move to sextics of genus 10 (when non-singular). To get the right genus $g = 6$, we have to conserve 4 nodes. Starting from a configuration of 3 conics suitably oriented and smoothed we obtain the figure denoted 515 with $r = 5$ (still on Fig. 50). Using a pencil of conics with 4 assigned basepoints (asterisks on the figure) gives a (probably total) map of degree $2 \cdot 6 - 1 \cdot 2 - 3 \cdot 1 = 12 - 2 - 3 = 7$. This agrees with Ahlfors bound $r + 2p$, but seems to challenge Gabard's bound $r + p = 6$. Maybe a pencil of cubics is required instead. Such a cubics pencil has 9 basepoints but only 8 of them may be assigned. Hence creating some 4 new basepoints (denoted by bold letters **1,2,3,4** on the figure) and letting them degenerate to the ovals or better the nodes (when some are accessible) gives a map of degree $3 \cdot 6 - 3 \cdot 1 - 5 \cdot 2 = 18 - 3 - 10 = 5$, rescuing Gabard's $r + p = 6$ and also giving the desired gonality $\gamma = 5$. Admittedly this example is quite complex and perhaps not the best suited to illustrate Coppens' gonality result. Its interest is still that it seems to corrupt Gabard's bound $r + p$, and the latter can only be rescued by appealing to fairly sophisticated pencils. Of course it could be the case a priori that our curve (515) admits a pencil of conics of lower degree than 7, but under the totality condition basepoints must be distributed in the deep ovals by a Poincaré index argument (cf. Lemma 18.5). This impedes a lowering of the degree via a more massive degeneration of the base-locus to the nodes of picture 515 on Fig. 50. Admittedly the predicted total pencil of cubics ought to be described more carefully.

Summary of the situation.—Of course one should still work out the higher values of r while keeping $p = 1$. As you notice our method is far from systematic. (All the difficulties encountered so far already enhance the power of Coppens' result.)

- Then one must also handle higher values of p , starting with $(r, p) = (1, 2)$. The case $\gamma = 2$ is easy (via the barbecue construction, Lemma 18.8). For $\gamma = 3$ we can imagine a surface with 3-fold rotational symmetry (cf. picture 123X on Fig. 50). For it $\gamma \leq 3$, but how to show equality? Alternatively, one may consider an algebraic model. Since $g = (r - 1) + 2p = 4$, we look among quintics with 2 nodes. A suitable smoothing gives figure named 123, with $r = 1$ (one circuit). Linear projection for the “inner” node gives a total map of degree $1 \cdot 5 - 1 \cdot 2 = 5 - 2 = 3$, so $\gamma \leq 3$. But the complex gonality of such a quintic is $\gamma_{\mathbb{C}} = 3$. Since $\gamma_{\mathbb{C}} \leq \gamma$ it follows that $\gamma = 3$ exactly.

- Let us next explore $(r, p) = (2, 2)$. Then $g = 5$. A surface with $\gamma = 2$ is easily found (barbecue rotational symmetry). To realize the other gonalitys we

look among quintics with one node. We first meet figure 223, which has a total morphism of degree 3 (projection from the node). Hence $\gamma \leq 3$ which is in fact an equality, since 3 is also the complex gonality of an uninodal quintic. To get a curve with $\gamma = 4$ we just drag the unsmoothed singularity to get figure 224. Projection from the node is not total anymore, but a total map arises when projecting from the (green) oval giving rise to degree $5 - 1 = 4$. Since such a quintic is uniquely trigonal (via projection from the unique node, which which failed to be total), we infer that $\gamma = 4$, exactly. Coppens's theorem is verified for this topological type.

Premature conclusion/State of the art. It is clear that one can continue the game to tackle higher and higher values of the invariants. Instead of looking solely in \mathbb{P}^2 it is also pleasant to trace curves in $\mathbb{P}^1 \times \mathbb{P}^1$, albeit \mathbb{P}^2 is a universal receptacle (any Riemann surfaces nodally immerses in the projective plane). However it is clear that our naive approach is quite time consuming and as yet we did not deciphered a combinatorial pattern permitting to boost the speed of the procedure to the level of an inductive process. (Curves or Riemann surfaces of higher topological structures are like *homo sapiens*, the result of a long, intricate morphogenesis.) Coppens proved the full result in one stroke by somehow penetrating the genetic code governing the evolution of all species.

18.6 Minimal sheet number of a genus g curve as a cover of the line

It is classical (since Riemann 1857 [687, §5, p.122–123]) that a general curve of genus g is expressible as a branched cover of the sphere \mathbb{P}^1 of degree the least integer $\geq \frac{g}{2} + 1$ (equivalently of degree $\lceil \frac{g+3}{2} \rceil$). [Indeed if g is even $g = 2k$ the first value is $k + 1$ and $\lceil (g + 3)/2 \rceil = \lceil (2k + 3)/2 \rceil = (2k + 2)/2 = k + 1$; if $g = 2k + 1$ is odd then the first value is $g/2 + 1$ which rounded from above gives $(2k + 2)/2 + 1 = k + 2$, and $\lceil (g + 3)/2 \rceil = \lceil (2k + 4)/2 \rceil = k + 2$.]

Riemann's truly remarkable argument (involving Abelian integrals) is beautifully cryptical (I should still study it properly). It is not clear (to me) if it includes the stronger assertion that *any* curve of genus g admits a sphere-map of degree $\leq \lceil (g + 3)/2 \rceil$. At any rate, all modern specialists agree that the first acceptable proof of this pièce de résistance is Meis's account (1960 [541]). (Meanwhile the algebro-geometric community devised several alternative approaches.)

Another allied (but different?) argument is the one to be found in Klein's lectures 1892 [439, p.98–99], cf. also Griffiths-Harris 1978 [303, p.261].

The latter's argument works as follows. Assume there is a d -sheeted map $C_g \rightarrow \mathbb{P}^1 \approx S^2$ of a genus g surface to the Riemann sphere. Then Euler characteristics are related by $\chi(C_g) = d\chi(S^2) - b$, where b is the number of branch points. This gives b ramified positions, whose locations determine the overlying Riemann surface up to finitely many ambiguities. So the d -sheeted surface depends upon $b - 3$ essential parameters (after subtraction of the 3 arising from the linear transformations on \mathbb{P}^1). This quantity has to be $\geq 3g - 3$ the number of moduli of genus g curves. This implies $b \geq 3g$, i.e. $2d - \chi(C_g) \geq 3g$, or $2d \geq 3g + (2 - 2g) = g + 2$. *q.e.d.*

So far as we know, a similar computation as never been written down for the case of a bordered Riemann surface expressed as a d -sheeted cover of the disc (i.e., the context of Ahlfors circle maps). The reason is probably quite mysterious, yet also quite simply that the naive parameter count seems to lead nowhere.

Let us attempt the naive computation. Suppose $F_{p,r} \rightarrow D^2$ to be a membrane of genus p with r contours expressed as a d -sheeted cover of the disc. Euler characteristics are related by $\chi(F) = d\chi(D^2) - b$, where b is the number of branch points. The group of conformal automorphisms of the disc as (real) dimension 3. Hence our d -sheeted surface depends upon $2b - 3$ real constants, whereas the membrane F itself depends on $3g - 3$ real constants, where g is the genus of the double (cf. Klein 1882 [434]). The Ansatz $2b - 3 \geq 3g - 3$ gives

$2b \geq 3g$, and since $b = d - \chi$ and $g = (r - 1) + 2p$, this gives $2d \geq 3g + 2\chi = 3[(r - 1) + 2p] + 2(2 - 2p - r) = r + 2p + 1$, equivalently $d \geq (r + 1)/2 + p$.

This beats the value $r + p$ predicted in Gabard 2006 [255], but looks blatantly overoptimistic. For instance taking $p = 0$, gives the degree $\frac{r+1}{2}$ violating the absolute lower bound r on the degree of a circle map. The provisory conclusion is that the naive parameters count leads nowhere in the bordered case. Does somebody know an explanation?

[21.10.12] A crude attempt of explanation is that the above count merely uses the Euler characteristic which is a complete topological invariant only for closed surfaces, but not for bordered ones. (Since $\chi(F_{p,r}) = 2 - 2p - r$, trading one handle against two contours leaves χ unchanged.) Of course the above counting uses also g (the genus of the double $2F$) but the latter is also uniquely defined by $\chi(F)$, via the relation $2 - 2g = \chi(2F) = 2\chi(F)$. Thus it is maybe not so surprising that Riemann(-Hurwitz)'s count predicts correctly the gonality of closed Riemann surfaces but fails seriously to do so in the bordered case. It could be challenging to find a moduli count existence-proof of Ahlfors circle maps supplemented probably by an adequate continuity method. For an (unsuccessful) attempt cf. Section 21.

A very naive (numerological) parade is to introduce a new bound $\nu := \max\{p + \frac{r+1}{2}, r\}$ between the one found above and r the absolute minimum of a total morphism. However a simple example probably shows this to be overoptimistic as well. Consider the plane quintic C_5 derived via a sense preserving smoothing of the depicted configurations of 2 conics and a line (cf. Fig. 51).

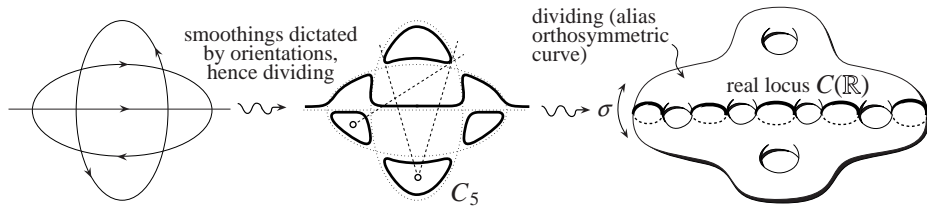

Figure 51: A quintic with gonality $\gamma = 6$?

Its genus is $g = \frac{(m-1)(m-2)}{2} = \frac{4 \cdot 3}{2} = 6$, and we see $r = 5$ real circuits. The relation $g = (r - 1) + 2p$ gives $p = 1$ (genus of the half). Hence the new bound is $p + \frac{r+1}{2} = 1 + 3 = 4$, but $r = 5$ so $\nu = \max = 5$. However the membrane (corresponding to one half of the dividing curve C_5) cannot be represented with 5 sheets over the disc. Indeed a morphism of degree 5 from C_5 to the line \mathbb{P}^1 can only arise through linear projection of the quintic C_5 from a point not on the curve (else degree 4), but no such projection is totally real (compare central part of Fig. 51, or argue via the Poincaré index, cf. Lemma 18.5).

[09.11.12] *WARNING about the underlined "only".*—This argument looks at first sight quite convincing, yet it appears to be insufficient, and possibly the assertion itself on the gonality $\gamma(C_5) = 6$ is erroneous. First, a total morphism of degree $r + p = 5 + 1 = 6$ (as predicted in Gabard 2006 [255]) should exist. This is corroborated by taking a pencil of conics through 4 points inside the 4 ovals of the above depicted C_5 (cf. Fig. 52, left part) and letting them degenerate against the ovals, giving a total map of degree $2 \cdot 5 - 4 = 6$. This tell us only $\gamma \leq 6$. A priori, it could be the case that higher order pencils access the low degree 5, and with some good-fortune do it in a totally real way. In that case the gonality lowers down to $\gamma = 5$ (the minimum permissible as $r = 5$). Let us quickly discuss how this could happen, at least over the complexes. A priori pencils of cubics may have degrees as low as $3 \cdot 5 - 3^2 = 6$ (hence not violating the previous token); quartics as low as $4 \cdot 5 - 4^2 = 4$, but quartics have dimension $\binom{4+2}{2} - 1 = 14$ so that in reality only 13 basepoints may be assigned freely, hence the right value is $4 \cdot 5 - 13 = 7$; for quintics this is as low as $5 \cdot 5 - 5^2 = 0$ (yet all values < 4 violates already the complex gonality of a smooth quintic, cf. e.g. Arbarello et al. 1985 [48, p. 56, Exercise 18]). In fact the dimension of quintics is $\binom{5+2}{2} - 1 = 20$ and thus the minimum degree is $5 \cdot 5 - 19 = 6$. For

sextics the degree is as low as $6 \cdot 5 - 6^2 = -6$, but since the sextics dimension is $\binom{6+2}{2} - 1 = 27$, the real minimum degree is $30 - 26 = 4$ (and this beats linear projections from outside the curve). Recall incidentally that this is the value of the universal Riemann-Meis bound $[(g+3)/2] = [9/2] = 4$, which was already attained by linear projections from the curve but nobody will exclude a priori a second return. Actually all 26 assigned base points fails to impose independent conditions on sextics, because our quintic C_5 aggregated to any line is a sextic meeting the requirement and varying among ∞^2 parameters (and not just the expected ∞^1 pencil). Thus we seem to fail getting a genuine pencil, but contrast this with the just remembered Riemann-Meis gonality. The situation is quite more tricky than initially expected. Another torpedo against the naive belief that a smooth C_5 has only ∞^1 series of type g_5^1 is the existence theorem of Brill-Noether-Kempf-Kleiman-Laksov theory (cf. e.g. Arbarello et al. [48, p.206]). The latter states the following.

Theorem 18.9 *Let C be a (complex) curve of genus g . Every component of the variety G_d^r parameterizing all linear series g_d^r of dimension r and degree d has dimension at least equal to the so-called Brill-Noether number ρ , symbolically:*

$$\dim_* G_d^r \geq \rho := g - (r+1)(g-d+r).$$

In particular when the latter number ρ is ≥ 0 the variety G_d^r is non-empty.

In the case at hand it follows that $\dim_* G_5^1 \geq 6 - (1+1)(6-5+2) = 6 - 2 \cdot 2 = 6 - 4 = 2$. Hence there are other pencils of degree 5 than those readily visualized on the projective realization! This shows how vicious the Plato cavern is! Of course our appeal to the above general theorem, is a violation against the principle of do-it-yourself-ness, since low genus cases are in best treated by hand (cf. Arbarello et al. [48, p.209–211] for a possible treatment, alas not perfectly self-contained).

The following summarizes the swampy situation (while trying to extend the generality):

Lemma 18.10 (To be clarified with percentages of truth)

- [100 %] *Any smooth real quintics C_5 with $r = 5$ (hence 4 ovals and one pseudoline) is unnested (otherwise the line through the nest plus another oval gives 6 intersections, corrupting Bézout).*
- [80 %] *Furthermore taking a pencil of conics through the 4 nests gives a total pencil (why exactly? clear on the Fig. refFGuerN:fig(left part) but why in general?).*
- [79 %] *Assuming the previous point, the gonality is $\gamma \leq 2 \cdot 5 - 4 \cdot 1 = 6$ (in accordance with Gabard's bound $r + p$, but it is preferable to mistrust this!).*
- [100 %=0 %] *Alas it is not clear a priori that pencils of orders ≥ 6 do not induce total pencils of possibly lower degree = 5. (Recall that $r = 5$ is an absolute lower bound for total maps!)*

[10.11.12] In the light of the Kempf-Kleiman-Laksov existence theorem of special divisors (ESD) in the case of complex curves one may wonder about its relativization in the Ahlfors context of total maps. The point is of course that for g_d^1 's the existence theorem (ESD) boils down to Riemann-Meis's bound $\gamma_C \leq [(g+3)/2]$ for the gonality of complex curves. (Plug $d \geq g/2+1$ in the Brill-Noether number ρ and notice its non-negativity.) Since Ahlfors 1950 $\gamma \leq r + 2p$ or maybe Gabard 2006 $\gamma \leq r + p$ is to be considered as the genuine bordered (or orthosymmetric) avatar of the Riemann-Meis theorem one can dream of an orthosymmetric(=dividing) version of the whole special of divisor theory. It is not clear how to extend total reality for higher series g_d^r which are not pencils g_d^1 . Of course one can ask that all real members are totally real but this seems too restrictive. Is there any example at all? Perhaps not for simple dimension reason. For g_d^2 's this would amount to a plane model of the curve cut by all real lines in real points only. This looks overambitious by just perturbing a tangent at a non-inflection point outside the sense of curvature.

At any rate the theory surely works for pencils and the bonus is that we have a certain variety akin to G_d^1 parameterizing all total pencils of degree d on a given dividing curve. How to denote it? I never understood for what the “ g or G ” of resp. g_d^1 or G_d^1 is standing? (Candidates: groups of points, Gerade, Gebilde, Grassmann, ?) Improvising notation, we define T_d^1 the variety of total linear series of degree d on a given dividing curve. We dream about repeating all the phenomenology of the classic theory, cf. e.g. p.203 of ACGH 1985 [48]:

“A genus g curve depends on $3g - 3$ parameters, describing the so-called moduli. Our goal is to describe how the projective realizations of a curve vary with its moduli, and what it means to say that a curve is general or special. Accordingly, we would like to know, what linear series can we expect to find on a general curve and what the subvarieties of the moduli space corresponding to curves possessing a series of specified type look like. [...] A natural question is, how can we tell one curve from another by looking at these configurations $[G_d^r]$, or more precisely, what do these look like in general, and how—and where—can they degenerate?”

For our “totality” varieties T_d^1 of total pencils we would gather them into a “telescope” $T^1 := \cup_{d=1}^{\infty} T_d^1$ naturally embedded in $C^{(\infty)}$, the infinite symmetric power of the (dividing) curve C . We have the degree function $\text{deg}: C^{(\infty)} \rightarrow \mathbb{N}$, and the image of T^1 is nothing but than the gonality sequence Λ (Definition 17.7), whose least member is the (separating) gonality γ (of Coppens). One would like to understand how total pencils may degenerate to lower degrees w.r.t the natural topology induced by $C^{(\infty)}$. We probably get a sort of telescope with high strata attached to lower dimensional ones (like in a CW-complex) and the game would be to understand the geometry or combinatoric of this tower. Understanding all this is arguably the most refined form of Ahlfors theorem one could desire. One would then like to know not only the gonality spectrum telling one the dimension of each strata T_d^1 , but also know how they can degenerate to lower strata. Degeneration could still be encoded combinatorially in a simplicial-complex Λ^* with vertices Λ (gonality sequence). Two vertices $d_1 < d_2 \in \Lambda$ are linked by an edge if a total $g_{d_2}^1$ can degenerate to a $g_{d_1}^1$. More generally $d_1 < d_2 < \dots < d_{k+1} \in \Lambda$ form a k -simplex whenever each integer of the sequence admits a representative g_d^1 degenerating to its immediate predecessor, hence to all predecessors.

Working out this explicitly looks tedious already for simple example. For the Gürtelkurve (any smooth quartic C_4 with 2 nested ovals) the variety T_3^1 is a circle and T_4^1 is a 2-cell attached to the former in a natural way. Of course when a total g_4^1 degenerates to a total g_3^1 it acquires a basepoint, which as to be deleted (particle destruction). Total g_d^1 will ultimately be denoted as t_d^1 's. In view of the Brill-Noether theorem (ESD) the variety G_4^1 has dimension $\geq \rho = 3 - 2(3 - 4 + 1) = 3$ and so we have a priori more than the ∞^2 evident total pencils t_4^1 arising via projection from the inner oval. For instance pencils of conics may have degree as low as $2 \cdot 4 - 4 \cdot 1 = 8 - 4 = 4$. Can they be total? I would have guessed not, but it seems that they can. Compare Fig. 52 below.

It would be desirable if some continuity principle can ensure total reality, e.g. if the 4 basepoints are distributed both inside and outside the nested resp. unnested oval. Then like a salesman traveller, the conic has to visit all 4 basepoints and thus creates at least 8 real intersections. Our picture would just be the limiting position of such a bipartite pencil, and the variety T_4^1 would be ∞^4 , a much larger dimension than initially expected. Further if 3, among the 4 basepoints, become collinear then it may be argued that the conics pencil specializes to one of lines (after removing the static line). All this remains to be better analyzed.

18.7 Heuristic moduli count to justify Ahlfors or Gabard (Huisman 2001)

It is still plausible that one may gain some evidence in favor of the Ahlfors circle map (either with Ahlfors $r + 2p$ or preferably the improved Gabard's

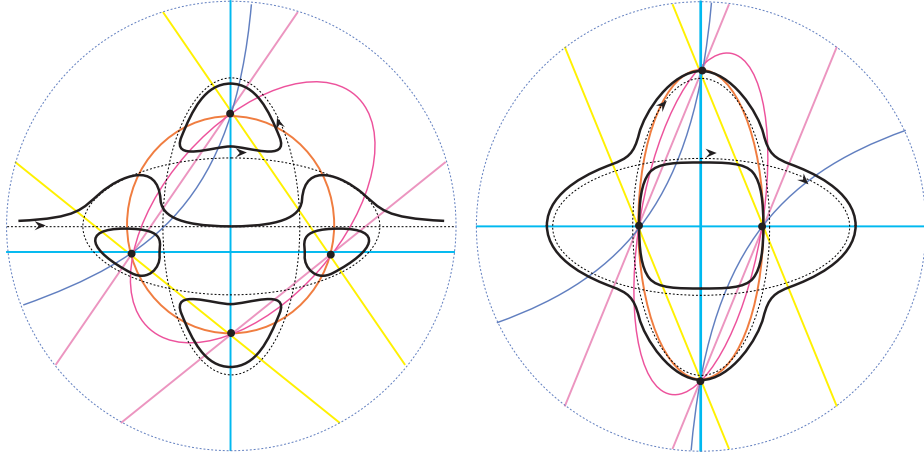

Figure 52: A total pencil on the Gürtelkurve cut out by conics

bound $r + p$) by arguing via a moduli count. (The reader reminds to have discussed orally this option with Natanzon and Huisman in Rennes in Summer 2001, resp. December 2001.) I do not know if it is possible to supply a better count than the unrealistic one of the previous section.

[14.10.12] In fact at a time when I only conjectured the bound $r + p$, Huisman (December 2001 or 2002?) reacted instantaneously with a parameter count giving some evidence to the conjecture. Let me reproduce this faithfully from hand written notes.

We adopt the viewpoint of dividing real (algebraic) curves. So let C be a such with $r \geq 1$ ovals and of genus g . I mentioned to Johannes Huisman the intuition that there is a totally real morphism $C \rightarrow \mathbb{P}^1$ (i.e. inverse image of real locus contained in the real locus) whose degree is the barycenter of r and $g + 1$, that is $\frac{r+(g+1)}{2}$. (The heuristic reason behind this 2001 intuition are given in Gabard 2006 [255], and in its most primitive form in the previous Section17.2.) “Let us count parameters!”. Thus spoke Huisman, like Zarathustra.

First the Riemann-Hurwitz relation written for the Euler characteristic is $\chi(C) = d \cdot \chi(\mathbb{P}^1) - b$, where d is the degree and b the number of branch points (with multiplicity). Now we count real moduli. The ramification divisor of any totally real morphism actually lies in the imaginary locus of the sphere (not on the equator), but is of course symmetric w.r.t. the involution. Hence we may imagine the $b/2$ branch points prescribed only in the north hemisphere, thus depending on $2 \cdot (b/2) = b$ real constants. The curve itself depends on $b - 3$ moduli (subtract the dimension of the automorphism group of \mathbb{P}^1 defined over \mathbb{R}), that is

$$\begin{aligned} b - 3 &= d \cdot \chi(\mathbb{P}^1) - \chi(C) = \frac{r + g + 1}{2} \cdot 2 - \chi(C) - 3 \\ &= (r + g + 1) - (2 - 2g) - 3 = 3g - 4 + r \geq 3g - 3. \end{aligned}$$

This prompts enough free parameters to sweep out the full moduli space. Of course this does not reprove the existence of circle maps of the prescribed degree, yet give some evidence to the assertion.

[15.10.12] A notable defect of this Huisman count is that it is a posteriori, giving no hint why the degree value should be given by our Ansatz. It is thus preferable to make the same computation in a more organical way. As above the curve C depends on $b - 3$ real moduli, and we demand $b - 3 \geq 3g - 3$. This gives $d \cdot \chi(S^2) - \chi(C) \geq 3g$, i.e. $2d \geq 3g + (2 - 2g) = g + 2$, or $d \geq g/2 + 1$.

Two remarks are in order. The above is exactly the same heuristic calculation as the that (going back to Riemann) to be found in Griffiths-Harris for the complex gonality of a curves, and which we remembered before. (The least integer $d \geq (g + 2)/2$ is $[(g + 3)/2]$, obvious for g even and also obvious when g is odd.) Hence in substance this modification of Huisman’s count truly just

assert that Gabard's bound is compatible with the gonality of the underlying complex curve, yet does not predict the bound $(r + g + 1)/2$.

Perhaps there is a better way to count, compare the section devoted to Courant (Section 7.4).

18.8 Other application of the irrigation method (Riemann 1857, Brill-Noether 1874, Klein, etc.)

The method used in Gabard 2006 [255] is primarily based upon an irrigation principle in a torus, which in turn is logically reducible to the surjectivity criterion via the (Brouwer) topological degree of a mapping to a manifold.

Via this method we obtained (in *loc. cit.*) the existence of an (Ahlfors) circle map of degree $\leq r + p$. As pointed out there, the method also supplies a purely topological proof of Jacobi inversion theorem, to the effect that the Abel-Jacobi mapping from the symmetric powers $C^{(d)}$ of a complex curve to its Jacobian is surjective as soon as dimension permits (that is for $d \geq g$).

Of course the complex (or closed) avatar of the Ahlfors mapping is just the mapping of a closed genus g surface as a branched cover of the sphere. In this situation it is classically known since Riemann 1857 [687] and Brill-Noether 1874 [116] (but disputed by the modern writers) that the most economical sheet number required is $\lceil \frac{g+3}{2} \rceil$.

Contributions on this problem is vast (and according to the modern consensus first *rigorously* proved in Meis 1960 [541] for linear series of dimension one, whereas some classic references includes the more case of arbitrary dimensional series, esp. Brill-Noether and Severi)

- Riemann 1857 (Theorie der Abel'schen Functionen) [687, §4],
- Brill-Noether 1874 [116] (working with plane curves with singularities, so a pure algebraization of Riemann's theory if one does not fell claustrophobic in the Plato cavern.)
- Klein's lectures of 1891 [439, p. 99] (based on Abelian integrals and Riemann-Roch, essentially akin to Riemann's original derivation)
- Hensel-Landsberg 1902 [370, Lecture 31] (probably quite similar to Brill-Noether or inspired by Dedekind-Weber)
- Severi 1921 [780, Anhang G]

Then the modern era begins with:

- Meis 1960 [541] (Teichmüller theoretic) [alas, this monograph is notoriously difficult to obtain]
- H. H. Martens 1967 [528] (no proof, but a remarkable study of the geometry assuming non-emptiness)
- Kempf 1971 [422] the first existence proof (simultaneous with the next contributors) of special divisors in general case (linear series of arbitrary dimension, extending thereby the pencil case first established by Meis 1960)
- Kleiman-Laksov 1972–74 [428] [429] (using resp. Schubert calculus, plus Poincaré's formula and resp. singularity theory à la Thom, Porteous)
- Gunning 1972 [326] using MacDonal computation of the homology of the symmetric power of the curve
- Griffiths-Harris 1978 [303, p. 261], where the heuristic count à la Riemann-Klein is reproduced; and latter a rigorous argument (p. 358) is supplied (along the line of Kempf's Thesis ca. 1970).

In view of the interest aroused by this Riemann-Meis bound, and the apparent difficulty to prove it (appealing to a variety of ingenious devices), it seems reasonable to wonder if there is not a much simpler argument based upon the same "irrigation method" as the one used by the writer in relation with the Ahlfors map. This would merely use simple homology theory and the allied surjectivity criterion in term of the Brouwer degree. Heuristically, this amounts to see the genus g pretzel inside its Jacobian and let it homologically degenerate over a bouquet (wedge) of g 2-tori irrigating the Jacobian. Thus it seems evident that with roughly $g/2$ points we may find a pair of (effective) divisor

of that degree collapsing to the same point of the Jacobian. This pair of disjoint divisors serves to define the desired morphism to \mathbb{P}^1 . The writer as yet did not find the energy to write down the details, but is quite confident that the strategy is worth paying attention. Of course it could be the case that this merely boils down (up to phraseological details) to the already implemented attack of Gunning 1972 [326]. (Shamefully, I did not yet had the time to consult this properly.) Of course “irrigation” would not establish the sharpness of Meis’ bound (which is another question), but could predict its value as universal upper-bound upon the gonality.

18.9 Another application: Complex manifolds homeomorphic to tori

This section deviates from the mainbody of the text, but serves to illustrate another spinoff of the irrigation method. The writer wondered about the following naive question (ca. 2001/2?). Assume given a complex (analytic) manifold (arbitrary dimension), and suppose also the underlying manifold to be homeomorphic to a torus. *Must such a manifold be biholomorphic to a complex torus, i.e. \mathbb{C}^n modulo a lattice?* The answer is easy in dimension one (Abel essentially). In general the answer is negative, by virtue of a construction of Blanchard (Thesis ca. 1955) closely allied to the Penrose twistor. Basically there is over S^2 a certain bundle parametrizing quaternionic structures, and taking a fiber product with an elliptic curve yields on the torus T^6 (of 6 real dimensions) a complex structure which turns out to be not Kähler. This answers negatively the question when the complex dimension is 3. (For more details cf. also work by Sommese (ca. 1978), etc.)

All this is rather exotic complex geometry, but one may wonder if the assertion becomes true under the Kähler assumption. Then Hodge theory applies, and we dispose of a bona fide analog of the Abel mapping (sometimes called the Albanese mapping). The latter is also a map to a complex torus (called Albanese) and using the irrigation principle it is easy to show that α induces an isomorphism on the top-dimensional homology. First, it induces an isomorphism on the H_1 , but the latter elevates up to the top-dimension since tori have a total homology H_* modelled upon the exterior algebra over the H_1 . By the Brouwer degree argument (irrigation intuitively), it follows that α is surjective. Then one can show that it is injective as well (I have forgotten the exact argument, but essentially if Albanese collapse a submanifold then like by Abel it collapses linear varieties which are simply-connected projective spaces, hence liftable to the universal cover of the Albanese torus).

Lemma 18.11 *Any torus shaped Kähler manifold is biholomorphic to its Albanese torus.*

Of course this is surely well-known, but we just wanted to remember this as another high dimensional—but baby—application of the irrigation principle. Further Kodaira’s classification of (complex analytic) surfaces plus a deformation argument of Andreotti-Grauert (which I learned from R. Narasimhan) implied also a positive answer to the basic question in (complex) dimension 2. But I take refuge in my failing memory, and to not remember the exact details. Thus in principle, Blanchard’s 3-dimensional counterexample is sharp.

18.10 Invisible real curves (Witt 1934, Geyer 1964, Martens 1978)

Ahlfors’ theorem bears some analogy with Witt’s theorem (1934 [892]) stating that a (smooth) real curve without real points admits a morphism (defined over the reals \mathbb{R}) to the invisible real line (materialized by the conic $x_0^2 + x_1^2 + x_2^2 = 0$). The analogy is again that when there is no topological obstruction, then a geometric mapping exists.

Subsequent works along Witt’s direction are due to:

- Geyer 1964/67 [289] (alternative proof of Weichold, and Witt via Galois cohomology and Hilbert’s Satz 90);
- Martens 1978 [526], where the precise bound on the degree of the Witt mapping has been determined.

Philosophically, it seems challenging to examine if such strongly algebraic techniques (Riemann-Roch algebraized à la Hensel–Landsberg 1902, Artin, etc.) are susceptible to crack as well the Ahlfors mapping? Geyer, Martens or others are perhaps able to address this challenge? (So far as we know, no such account exist in print.)

Martens’ statement (quantitative version of Witt) is the following.

Theorem 18.12 (Martens 1978 [526]) *Given a closed non-orientable Klein surface with algebraic genus g (i.e. the genus of the orientable double cover⁶) there is a morphism to the projective plane of degree $\leq g + 1$. Moreover this is the best we can hope for, i.e. for each g there is a Klein surface not expressible with fewer sheets.*

Perhaps the first portion of the statement is already in Witt 1934 [892]. Of course this can—via the Schottky-Klein Verdoppelung—also be stated in term of symmetric Riemann surfaces (equivalently real algebraic curves) as follows:

Theorem 18.13 (Martens 1978 [526]) *Given a symmetric Riemann surface of genus g without fixed point, there is an equivariant conformal mapping to the diasymmetric sphere of degree $g + 1$. Moreover the bound is sharp.*

This formulation of Martens’s result also appears in Ross 1997 [713, p. 3097], who supplies additional comments which are quite in accordance with our own sentiments, especially the issue that the short argument by Li-Yau 1982 [506, p. 272] does not appear as very convincing. Moreover Ross supplies some attractive differential geometric applications of this Witt-Martens mapping theorem, e.g. to the effect that the totally geodesic $\mathbb{R}P^2$ is the only stable minimal surface in $\mathbb{R}P^3$.

18.11 The three mapping theorems (Riemann 1857, Ahlfors 1950, Witt 1934)

From the conformal viewpoint we have thus three basic mapping theorems enabling a gravitational collapse of all compact surfaces to their simplest representatives (the sphere, the disc or the projective plane) depending on whether the original surface is:

- closed orientable (Riemann 1857 [687]);
- compact bordered orientable (Ahlfors 1950 [17]);
- closed non-orientable (Witt 1934 [892]).

None of those results tells what to do with a compact bordered non-orientable surface (whose simplest specimen is the Möbius band/strip). The latter does not carry positive curvature, which implies finiteness of the fundamental group for complete metrics (else punctured sphere). Alternatively the orientable double cover of Möbius is the torus, which has already moduli. Hence it is quite clear that the above three theorems form an exhaustive list of truths positing a fundamental trichotomy (of definitive crystallized shape). The motto “Alle guten Dinge sind drei”, is quite ubiquitous in life and mathematics! It is reasonable to expect that each of those mappings will pursue to find valuable applications in the future, yet much work remain to be done as to the stratification of the moduli space induced by the degree of such representations, etc.

For each of these 3 concretization problems one is interested in the exact determination of the lowest possible sheet number. In principle the answer is already known as follows:

⁶This is not explicitly specified in the paper, but is the (common) jargon in Klein surface theory, probably due to Alling-Greenleaf 1971 [39].

Theorem 18.14 *For all 3 types of conformal mapping to elementary surfaces of positive Euler characteristics $\chi > 0$ (including $\chi(S^2) = 2, \chi(\mathbb{R}P^2) = 1, \chi(\Delta = D^2) = 1$) the sharp universal bound on the degree of such representation is known. More precisely,*

- $\lceil (g+3)/2 \rceil$ always concretizes closed genus g surfaces expressed as cover of the sphere (Riemann, Meis 1960 [541]), and the bound is sharp (again Meis 1960 [541]).
- $g+1$ always concretizes non-orientable closed surface of algebraic genus g (i.e. genus of the orientation double cover) expressed as cover of the projective plane (Witt 1934 [892]), and the bound is sharp (Martens 1978 [526]).
- $r+p$ always concretizes bordered orientable surfaces with r contours and p handles as (full or total) cover of the disc (Gabard 2006 [255]), and the bound is sharp (Coppens 2011 [183]).

Adhering to Klein's viewpoint of symmetric surfaces, one can always interpret such objects as real curves of some genus g (the first class is an exception except if one tolerates disconnected surfaces). In the third bordered case $g = (r-1) + 2p$. The $r+p$ bound can be rewritten as $\frac{r+(g+1)}{2}$. If r is lowest, i.e. $r = 1$, this is statistically equal to $g/2$, as so is the first Riemann-Meis bound. In contrast the Witt-Martens bound looks much higher. Of course if $r = g+1$ is highest (Harnack maximality) then $r+p = r+0 = g+1$, agreeing with Witt-Martens's bound. In the overall it may be argued that both Martens' and Gabard's bound are fairly less economical than Riemann-Meis', and that this is due to the equivariance or even total reality of the corresponding maps. On the other hand Ahlfors bound $r+2p = g+1$ looks much more compatible with Martens' and if one is sceptical about Gabard's version one could imagine that Ahlfors is asymptotically sharp for large values of the invariants. This scenario remains hypothetically possible in case we are unable to reassess through other means Gabard's $r+p$ or able to disprove its validity.

The following tabulation summarizes the key contributions:

(1) Riemann 1857: any (or at least the general) closed Riemann(ian) surface maps conformally to the sphere with $\leq \lceil \frac{g+3}{2} \rceil$ sheets, where g is the genus. It is not clear-cut if Riemann showed sharpness of the bound.

Related works includes (in chronological order):

- Brill-Noether 1873 [116];
- Klein 1891 [439, p. 99];
- Severi 1921 [780];
- B. Segre 1928 [775];
- Meis 1960 [541];
- Kempf 1971 [422] and Kleiman-Laksov 1972–74 [428] [429];
- Gunning 1972 [326];
- Griffiths-Harris 1978 [303, p. 261];
- Arbarello-Cornalba 1981 [47].

This sharp bound $\lceil \frac{g+3}{2} \rceil$ as applied to spectral theory is observed in El Soufi-Ilias 1983/84 [221] (Yang-Yau 1980 [898] contented themselves with the weaker value $g+1$.) An interesting aspect of the Italian works is that they not only focus on the gonality upper bound, but also compute the dimensions of the lower dimensional strata for a prescribed gonality. Of course, the answer is the expected one (as easily predicted by Riemann-Hurwitz). [The above Italian works, especially Segre has however a little objection to the simplicity of the exercise.] We point out this is issue as it could be interesting to make a similar count for the Ahlfors circle map (bordered case). This topic will be briefly addressed in the next Section 18.12.

(2) Ahlfors 1950 [17]: any compact bordered Riemann surface maps conformally to the disc with $\leq r+2p$ sheets (where as usual r is the number of boundary contours and p the genus). This bound is not sharp (at least for low values of the invariants (r,p) , e.g. for the Gürtelkurve type $(r,p) = (2,1)$). Modulo a mistake by the writer (in Gabard 2006 [255]), Ahlfors bound can be

improved as $\leq r + p$. The latter is in turn sharp according to Coppens 2011 [183].

(3) Witt 1934 [892]: any closed non-orientable surface maps conformally to the projective plane $\mathbb{R}P^2$. Witt does not specify a bound (?), or maybe he does but sharpness was obtained by Martens 1978 [526].

Witt's result received, arguably, only sporadic spectral applications, except in the article Li-Yau 1982 [506], which however does not quote Witt, but whose authors were apparently able to reprove the result by their own [compare their argument on p. 272]. (As already mentioned, Ross 1997 [713] does not seem to be convinced by the Li-Yau argument.)

Of course all this "diaporama" is the direct heritage of Riemann (plus maybe indirectly some Abel!) the first result being often called Riemann's existence theorem. The 2 avatars of Ahlfors and Witt are akin to the absolute case of Riemann, via the trick of the Schottky-Klein double (or Verdoppelung as Teichmüller calls it) but then some equivariance or total reality is required, acting as a sort of boundary condition explaining probably why those versions took longer to emerge. Of course such equivariance/or boundary behaviors just hide a reality condition encoded in the field of definition of the allied Riemann surfaces. All this is best summarized diagrammatically:

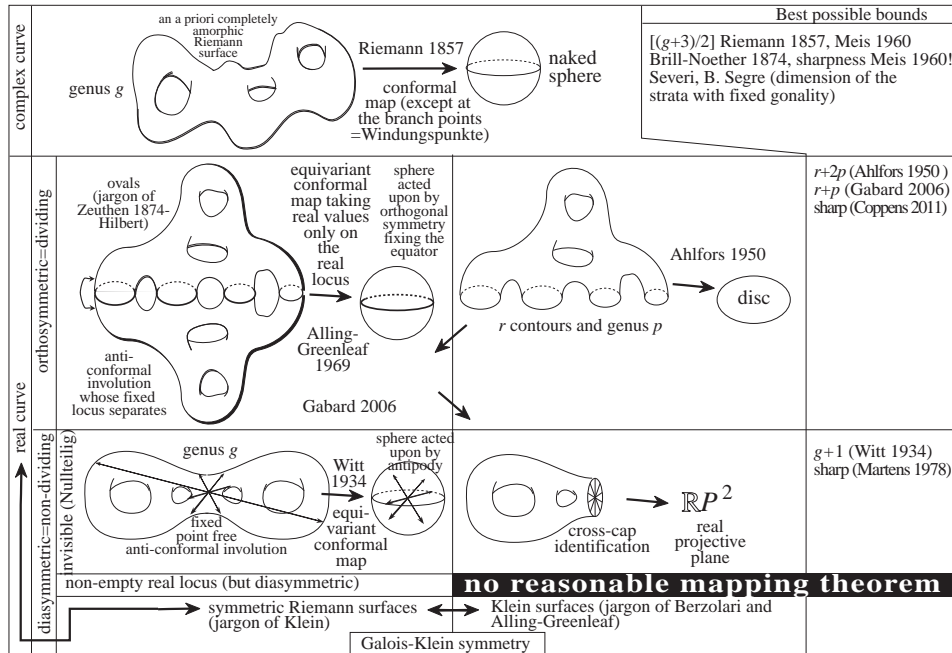

Figure 53: The 3 types of conformal maps to the simplest configurations ($\chi > 0$)

18.12 The gonality profile, moduli strata and the Ahlfors space

[10.11.12] Heuristically (cf. e.g. Segre 1928 [775]) one can count the dimension of closed Riemann surfaces expressible as coverings of degree d of the sphere as follows. By Riemann-Hurwitz $\chi(C_g) = d\chi(S^2) - b$. Hence there are $b - 3$ free parameters, that is

$$b - 3 = (2d - \chi) - 3 = 2d - (2 - 2g) - 3 = 2d + 2g - 5.$$

In particular the strata of given gonality $\gamma = d$ increases its dimension along a very simple arithmetic progression (as a function of d) until the full moduli space is exhausted for d the least integer $\geq g/2 + 1$ (Riemann-Meis bound). The smallest strata is the *hyperelliptic locus* ($d = 2$) of dimension $4 + 2g - 5 = 2g - 1 = (2g + 2) - 3$, in accordance with the $2g + 2$ ramification points visible as

invariant points of an half twist acting upon a purely vertical pretzel in 3-space. I do not know if such a regularity occurs for bordered surfaces. Coppens's theorem states another form of regularity, namely full realizability of all intermediated gonality, but it does not pertain to the dimensions of the corresponding moduli strata.

On behalf of Coppens's theorem the situation could be as follows. For a given topological type (r, p) , Coppens tells us that all intermediate $r \leq \gamma \leq r + p$ are realized. So we have $p + 1$ possible gonalitys, the largest of which $\gamma = r + p$ fills the full moduli space of real dimension $3g - 3$ (Klein's count conjointly with Gabard's bound). As usual $g = (r - 1) + 2p$, so $3g - 3 = 6p + 3r - 6$. If we knew the number of moduli of the minimal strata $\gamma = r$ we could try a linear interpolation as a possible scenario for the dimensions increments of the gonality strata. Naively our rotationally invariant picture (Fig. 49) could act as a bordered substitute to the hyperelliptic closed case (at least for r even). If so is the case can we count its moduli? Everything would be determined by the quotient planar surface with $r/2 = r'$ contours. This planar surface (whose double has genus $g' = r' - 1$) depends on $3g' - 3$ moduli. This expressed in terms of r , gives the following $3g' - 3 = 3r' - 6 = 3/2 \cdot r - 6$. This a candidate for the dimension of the lowest strata. Looking for a progression in p steps toward the maximum value, we consider the difference $[6p + 3r - 6] - [3/2 \cdot r - 6] = 6p + 3/2 \cdot r = 1/2[12p + 3r]$, which is not easily divided by p . • In fact we have looked at the quotient but barely omitted the branched locus. Taking this into account we get rather a dependance on $3g' - 3 + 2(2p + 2)$ (real) moduli for the lowest strata. Expressing this in terms of (r, p) , gives $3/2 \cdot r + 4p - 2$. Hence the difference of the top and lowest strata would be $2p + 3/2 \cdot r - 1$, which is alas still not nicely divisible by p . • Another idea is just to use maps from $F_{r,p}$ to the disc of minimum degree r . Then we have $\chi(F) = r\chi(\Delta) - b$. Hence there are $2b - 3$ free real parameters. Expressed in terms of (r, p) , this is $2b - 3 = 2(r - \chi) - 3 = 2(r - (2 - 2p - r)) - 3 = 4r + 4p - 7$. Hence the difference between the top dimensional and the lowest dimensional strata is $\delta = (6p + 3r - 6) - (4r + 4p - 7) = 2p - r + 1$, which is not even positive in general. It looks again dubious to divide this in p equal parts as suggests Coppens result. Again this just confirms what we already noticed (earlier in the text) that the Riemann-Hurwitz count looks seriously jeopardized in the bordered case, at least as long as we apply it so naively as we do.

One can reverse the game: instead of speculating on the size of the lowest strata we can speculate on the increment as being by 2 real units (like in the complex case) and draw the dimension λ of the lowest strata. This would give $\lambda = \dim(\text{top strata}) - p \cdot 2 = (6p + 3r - 6) - 2p = 4p + 3r - 6$. Testing this on the type of the Gürtelkurve $(r, p) = (2, 1)$ gives $\lambda = 4 + 6 - 6 = 4$, whereas the hyperelliptic model depends on $2g + 2 - 3 = 2 \cdot 3 + 2 - 3 = 5$ real parameters. Hence the later has codimension 1 in the full moduli of the Gürtelkurve type, which as dimension $3g - 3 = 3 \cdot 3 - 3 = 9 - 3 = 6$. This motivates modifying the increment to one of only 1 unit. This leads to the following Ansatz: $\lambda = 5p + 3r - 6$. This gives for $(r, p) = (2, 1)$, $\lambda = 5 + 6 - 6 = 5$ the correct number. But if we look at the type $(r, p) = (2, 2)$ we get $\lambda = 10 + 6 - 6 = 10$; but on the other hand the hyperelliptic models have $2g + 2 - 3 = 2 \cdot 5 + 2 - 3 = 9$ moduli conflicting the new Ansatz for λ .

Of course the real scenario about the increments might be pretty more complicated than the linear progression observed in the complex case (corresponding to closed Riemann surface).

Another more neutral way to look at the question is as follows. Given is (r, p) a pair of integers. Allied to this there is a moduli space $M_{r,p}$ of all bordered (Riemann) surfaces of type (r, p) . Its dimension is $3g - 3$ (Klein 1882 [434]), where g is the genus of the double. We imagine the range of all possible gonalitys $r \leq \gamma \leq r + p$ as a horizontal array of entries above each of which is reported the dimension of the moduli space of curve having gonality $\leq \gamma$. This is depicted as a vertical bar. At first, only the top dimension attached to $\gamma = r + p$ is known as $3g - 3$. By Coppens we know that there will be p descents of this

highest bar to the lower gonality between r and $r + p$. Pause at this stage to notice that assigned to the sole data (r, p) there is assigned unambiguously such a histogram of gonality (cf. Fig. 54).

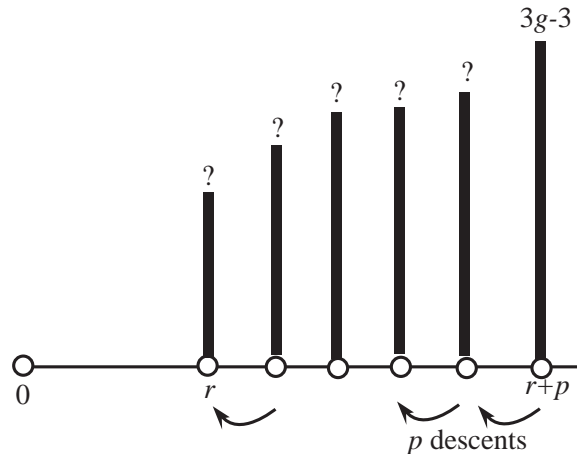

Figure 54: Histogram coding the dimensions of each gonality strata (alias the gonality profile)

One special case in which we can hope to be more explicit regarding the lowest strata is when r equals 1 or 2. In this case we know that the moduli space contains hyperelliptic membranes. Assuming p large enough ($p \geq 1$) the lowest gonality is $\gamma = 2$. It is tautological that the hyperelliptic locus has this gonality, and conversely. So we control explicitly the dimension of the lowest strata. We find $(2g + 2) - 3$ real constants. Thus the dimension difference δ of the top and lowest strata is $\delta = 3g - 3 - [(2g + 2) - 3] = g - 2$. This rewritten in terms of (r, p) is also $g - 2 = (r - 1) + 2p - 2 = r + 2p - 3$.

- If $r = 1$, this gives $\delta = 2p - 2 = 2(p - 1)$. Positing linearity of the increment, this ought to be divided in $p - 1$ equals parts (since $r = 1$ itself is not a gonality when $p \geq 1$), and we get exactly a progression by 2 units. Hence under the Ansatz of linearity the histogram would be completely known.

- If $r = 2$, this gives $\delta = 2p - 1$. Assuming linearity of the increment, this ought to be divided in p equals parts, and we get something like a progression by 2 units. However the non-divisibility implies that in this case it is impossible to have a linear progression of the histogram. Hence some jumps must occurs.

So in these cases there is some hope to be completely explicit about the histogram attached to (r, p) . It would essentially suffices to decide where occur some irregular jumps.

Let us formalize a bit. Given a pair of integers (r, p) , we have a moduli space $M := M_{r,p}$ of all bordered Riemann surfaces of type (r, p) . (To allege notation with omit the indices (r, p) , as the topology is fixed once for all.) Its dimension is invariably $3g - 3$, where $g = (r - 1) + 2p$ is the genus of the double. Inside it we define the locus M_d of all surfaces with gonality $\gamma \leq d$, and let $\mu_d = \dim M_d$ be its dimension. The histogram we were speaking about is essentially the function $d \mapsto \mu_d$. It is evidently monotone but a priori not strictly. Misinterpreting Coppens's result one would guess strict monotony, but Coppens states only that each gonality is exactly realized, hence in symbols that $M_d - M_{d-1}$ is non-void (at least for d in the range $[r, r + p]$). Thus a priori it could be the case that when incrementing the parameter d we get new surfaces but their variety is not of larger dimension. Of course this scenario may look a bit unlikely due to the algebro-geometric character of the whole topic, but I do not know an argument. The domain of our function $d \mapsto \mu_d$ is the set of all integers but the interesting range is $[r, r + p]$ at least taking Gabard for granted. The latter amounts to say that $\mu_{r+p} = 3g - 3$.

Now if $r = 1$ or 2, then the moduli space $M = M_{r,p}$ contains hyperelliptic representatives, and the latter exhaust the locus M_2 . We calculate easily $\mu_2 =$

$(2g + 2) - 3 = 2g - 1$ and deduced the difference $\delta = \mu_{r+p} - \mu_2 = (3g - 3) - (2g - 1) = g - 2$. From here we inferred that:

- when $r = 1$ (and $p \geq 1$) then r itself is not a gonality and so there is really only $p - 1$ descents. Since $\delta = g - 2 = r + 2p - 3 = 2p - 2 = 2(p - 1)$, we can divide (without rest) this by the number of $p - 1$ descents, to get a statistical increment of 2 units. If one believes in the linearity regularity then the histogram would be completely known in that case.

- when $r = 2$ then r is a gonality, and we have exactly p admissible descents along the range $[r, r + p]$. Now $\delta = g - 2 = r + 2p - 3 = 2p - 1$, which is not divisible by p . We infer an obstruction to the scenario of linearly evolving histogram. (In other words the function is not linear on the segment $[r, r + p]$.) Perhaps it is just doing a gentle seesaw at some early place?

At this stage we may have exhausted all what can be said on trivial arithmetical grounds. Going further probably requires some geometric impetus, like looking at explicit models (extending the hyperelliptic case). So one needs probably to describe large families of d -gonal surfaces for $d \geq 2$. If a general result describing the gonality profile $d \mapsto \mu_d$ looks out of reach, one can start examining low values of (r, p) to explore the situation.

[11.11.12] *Examples.*—• E.g. for $(r, p) = (2, 1)$ (thus $g = 3$) (the Gürtelkurve type) then the profile is completely known, namely $\mu_2 = 5$ (hyperelliptic locus of dimension $(2g + 2) - 3$) and $\mu_3 = 6$ (equal to $3g - 3$). Of course Gabard's $\gamma \leq r + p$ follows in this case via the canonical embedding realizing the curve as a Gürtelkurve in \mathbb{P}^2 .

- For $(r, p) = (2, 2)$ (thus $g = 5$), we have again the hyperelliptic locus giving $\mu_2 = (2g + 2) - 3 = 9$. The top locus $M_{r+p} = M_4$ has dimension $\mu_4 = \mu_{r+p} = 3g - 3 = 15 - 3 = 12$ (Gabard is used but maybe there is an argument by hand). What about μ_3 ? To seek an answer we refer back to the table of Fig. 50, where we traced a picture (label 223) of an uninodal quintic with gonality $\gamma = 3$. Quintics depends on $\binom{5+2}{2} - 1 = \frac{7 \cdot 6}{2} - 1 = 20$ parameters, but modulo the collinearity group $PGL(3) = \text{Aut}(\mathbb{P}^2)$ of $3^2 - 1 = 8$ dimensions, this boils down to 12 effective parameters. Of course the uninodal quintic we consider is really compelled to live on the smaller discriminant hypersurface of dimension 19 and so our curve 223 truly depends on only 11 essential parameters. Assuming that a full neighborhood of curve 223 consists of curves keeping the same gonality $\gamma = 3$ suggests therefore the value $\mu_3 = 11$ (at least as a lower bound). Observe that the picture 223 is total under a pencil of lines, and it seems reasonable to expect that when the curve is slightly perturbed along the discriminant hypersurface, total reality of the pencil persists on the ground of some topological *stability*. Remember e.g., that total reality amounts to the transversality of the foliation (induced by the pencil) along the curve, and transversality is the mother of any topological stability (Thom-style philosophy). Note of course that our curve (being uninodal) represents actually a smooth point of the discriminant and so we safely dispose of the required parameters of deformation. This is perhaps worth saying if one remembers certain plane cubics (or even conics) as examples of real algebraic varieties having an isolated real point. Maybe the above stability argument adapts to situations where there are several nodes via Brusotti's theorem describing the infinitesimal structure of the discriminant near a multi-nodal curve (with say δ nodes) as an union of smooth branches crossing transversally (normal crossing).

- For $(r, p) = (3, 2)$ (thus $g = 6$), we have no hyperelliptic locus. The top locus $M_{r+p} = M_5$ has dimension $\mu_5 = \mu_{r+p} = 3g - 3 = 18 - 3 = 15$ (Gabard is used but maybe there is an argument by hand). What about μ_3 and μ_4 ? We look again back to Fig. 50, where we find curve 324. This is merely a smooth quintic with 2 nested ovals hence with gonality $\gamma = 4$. Remember that smooth plane m -tics have in general complex gonality $(m - 1)$. As quintics depends on 12 essential parameters, the above stability argument shows that the strata M_4 contains the locus of all such quintics, and we infer $\mu_4 \geq 12$. Is this an equality? How to estimate μ_3 ? Due to time limitation, we have to leave all this (in our opinion) exciting topic at a fragmentary stage. Perhaps a last

word, if we use picture 324bis (still on Fig. 50), which is a sextic with 4 nodes also having $\gamma \leq 4$ (projection from the node), then we get a model depending on $\binom{6+2}{2} - 1 = \frac{8 \cdot 7}{2} - 1 = 27$ constants, minus the 8 coming from $PGL(3)$ gives 19, of which must be subtracted 4 units (using Brusotti's normal crossings description). The final result is 15. Repeating the above stability argument implies that $\mu_4 \geq 15$. This is a much stronger lower estimate, which in fact must be an equality since we have already attained the dimension of the full moduli space. Hence we conclude $\mu_4 = 15$; strikingly as big as μ_5 ! This answer is quite intriguing in case it is correct at all? It would show that the gonality profile does not need to be strictly increasing!

Finally, it is perhaps fruitful to keep a view on the space of all (total) circle maps. This is the *Ahlfors space* (improvised jargon) quite akin to so-called Hurwitz spaces. All what we were concerned with in this subsection is arguably just a shadow of this larger space dominating the moduli space $M_{r,p}$. Precisely, the *circle maps (or Ahlfors) space* $C_{r,p}$ consists for a fixed pair (r, p) (number of contours and handles resp.) of all circle maps $f: F \rightarrow \Delta$ on a “variable” bordered Riemann surface of specified topological type (r, p) . Forgetting the circle map f induces a natural map $C_{r,p} \rightarrow M_{r,p}$ to the moduli space. Of course one must consider the space C modulo the equivalence relation of a conformal diffeomorphism commuting with the maps to the disc. The strata M_d of all surfaces of gonality $\gamma \leq d$ appear then as the projections of the fibres of the degree function on $C_{r,p}$. The fibre of the map $C \rightarrow M$ (indices omitted) is the space of all total maps on a fixed bordered Riemann surface F .

19 Existence of Ahlfors maps via the Green's function (and the allied Dirichlet principle)

All what follows is extremely classical, yet the writer confesses to have assimilated (the first steps of the argument) as late as the [04.08.12]! First it is well-known that the solubility of the Dirichlet problem (say on a bordered Riemann surface) is tantamount to the existence of the Green's function $G(z, t)$ with pole at t , for each t . (Actually, we primarily need that the former implies the latter.) This “Dirichlet-to-Green” mechanism will be recalled below along with the definition and some geometric (biochemical) intuition about the Green's function. The latter has also strong electrostatic or hydrodynamic connotations. The definition of the Green's function is somewhat easier in the case of plane domains, and its extension to bordered surface—while still laying in the range of Dirichlet—implicates some conceptual difficulties.

The *Green's function* $G(z, t)$ with pole at t (a fixed interior point) is a completely canonical function characterized by the properties: it is harmonic off t , vanishes along the boundary and its germ near t has the singular behavior prescribed by the function $\log|z - t|$ in any local uniformizer z . It will be verified that $G(z, t)$ is negative on the interior of the bordered surface (consequence of Gauss' mean value property of harmonic function and the resulting maximum principle). Then we shall try to approach the existence of the Ahlfors function by duplicating the Green-type proof of the Riemann mapping theorem (simply-connected case), which just amount to write down the magic formula $f(z) = e^{G(z,t)+iG^*(z,t)}$, where G^* is the conjugate potential. Note that $G(z, t) \leq 0$ ensures $|f(z)| = e^{G(z,t)} \leq 1$ with equality precisely along the boundary. The main difficulty about extending this “Green-to-Riemann” trick to the multiply-connected setting is to arrange single-valuedness of the conjugate potential G^* . This amounts to kill all periods of the 1-form dG^* from which G^* arises through line-integration. To achieve this one is invited to introduce enough free parameters in the problem by considering a superposition of various Green's functions $\sum_i \lambda_i G(z, t_i)$ for several poles t_i sufficiently abundant so as to enable the killing of all periods (via linear algebra). Since a planar domain with r contours has $r - 1$ essential cycles (up to homology) and attaching p handles creates 2 new essential cycles, we need annihilating $(r - 1) + 2p$ periods. Taking

one more pole (raising the total number to $r + 2p$) supplies enough parameters for linear algebra to ensure existence of a non-trivial solution in the kernel of the period mapping. This prompts (almost) the existence of an Ahlfors circle map of degree $r + 2p$ (as predicted in Ahlfors 1950 [17]). Alas, a serious technical difficulty occurs, namely ensuring the positivity of all λ_i . Ignoring this issue, any $r + 2p$ points (in the interior) could be the zeroes of a circle map. Presently, we lack a complete existence of an Ahlfors map through this procedure. Of course it would be even more challenging to arrive at Gabard's bound (mapping degree $\leq r + p$) through this classical strategy (à la Green, Riemann, Grunsky, Ahlfors, Kuramochi, etc.). In Riemann the trick of annihilating periods appears of course very explicitly in the following jargon: “*so bestimmen daß die Periodicitätsmoduln sämtlich 0 werden.*” (cf. e.g. Riemann 1857 [687, p.122]). The core of Heins' argument 1950 [358] is also exactly in this spirit and Heins seems able to complete the program via consideration of convex geometry. Our intention is first to recall the basic procedure, and we hope to be able later to settle the positivity problem. A priori it is not evident that the latter condition is always achieved for an arbitrary selection of poles t_i of Green's functions (which will mutate into zeroes of the “Riemann-Ahlfors map” f after exponentiation).

[25.08.12] *Corrigendum.*—The above linear superposition $\sum_i \lambda_i G(z, t_i)$ on Green's functions is maybe somewhat too continuous in nature. This may be seen by exponentiating and looking at the local behavior of f . Near some t_i , $G(z, t) \sim \lambda_i G(z, t_i) \sim \lambda_i \log |z|$ so that $|f(z)| \sim \exp(\lambda_i \log |z|) = |z|^{\lambda_i}$ so that f has not the character of a holomorphic function when λ_i is not integral.

Another way to argue in the same sense is suggested by Ahlfors 1950 [17, p.126–7, §4.3]. Assume that $f(z)$ is a circle-map $f: F \rightarrow \overline{\Delta}$ with zeros at t_1, \dots, t_d (counted with multiplicities), then upon post-composing with the function $\log |z|$ (harmonic off the origin) we get the function $\log |f(z)|$ harmonic on F save at the t_i where it has logarithmic poles. Therefore this function must coincide with superposition $G := \sum_{i=1}^d G(z, t_i)$ of Green's potentials. Indeed, the difference $\log |f(z)| - G$ is throughout F harmonic (cancellation of singularities) and vanishes along the border ∂F , hence is identically zero. [NB: the above remark is to be found in Ahlfors (*loc. cit.*), who (in our opinion) fails to insist on the assumption that f is a circle-map (i.e. $|f| = 1$ along the border), which is crucial to ensure that $\log |f(z)|$ vanishes along the border ∂F .]

So given a circle-map f with d zeros t_i we have the formula

$$\log |f(z)| = \sum_{i=1}^d G(z, t_i).$$

Conversely, given points t_i , we may consider the right-hand side of the previous equation

$$G := \sum_{i=1}^d G(z, t_i) \tag{4}$$

and the following formula will define a circle-map

$$f(z) = e^{G+iG^*}$$

provided dG^* (the conjugate differential of G) has all its periods integral-multiples of 2π . (It follows incidentally, that a circle-map is uniquely determined up to a rotation by the geographic location of its zeros. This can also be seen algebro-geometrically, by considering the Schottky double, where the divisor of zeros D becomes linearly equivalent to its symmetric conjugate D^σ , spanning together a pencil g_d^1 defining a total morphism to \mathbb{P}^1 of degree d , cf. Lemme 5.2 in Gabard 2006 [255].

The desired integrality of periods resembles a *Diophantine condition* (at least is qualified as a such by Ahlfors 1947 [16, p.1]), emphasizing from the outset the relative difficulty of the problem. All of our freedom relies on dragging the points t_i through the surface F hoping that for a lucky constellation the 1-form dG^* acquires simultaneous integrality of all its periods along $\gamma_1, \dots, \gamma_g$ the $g := (r - 1) + 2p$ many essential 1-cycles traced on F (cf. Fig. 55e).

As a personal trouble, dG^* seems to have singularities where G does, but maybe they disappear. Bypassing this point, Ahlfors' Diophantine problem

(1947) looks well-posed and one may hope a direct attack upon arranging integrality of all periods. (Ahlfors 1950 [17] (p. 127) first reformulates the condition in term of Schottky differentials and then switches quickly to the extremal problem, so does not seem to attack directly the Diophantine question. In fact, its elementary proof on p. 124–126 follows a somewhat different route by constructing a half-space map involving avatars of Green’s function with poles situated along the boundary. We shall come back to this subsequently.)

Trying a direct attack. Assuming the problem well-posed, we can consider a period mapping

$$\wp: R^d \longrightarrow \mathbb{R}^g \longrightarrow (\mathbb{R}/2\pi\mathbb{Z})^g =: T^g,$$

where $R = \text{int}(F)$ is the interior of the bordered surface F , and the first map takes the periods along the fixed basis of the first homology γ_i of the 1-form dG^* corresponding to the points $(t_1, \dots, t_d) \in R^d$ via formula (4). The second map is just the natural quotient map.

Now one may hope to apply the usual surjectivity criterion for a continuous map to a closed manifold (here $R^d \rightarrow T^g$) saying that if the representation induced on the top-dimensional homology of the target-manifold is non-zero then the mapping is surjective. For definiteness we recall its statement and short proof.

Lemma 19.1 *Let $f: X \rightarrow T$ be a continuous map from a (topological) space X to a (target) manifold T of dimension n , say. It is assumed that T is closed (i.e. compact borderless). It is also essential to assume that T is a Hausdorff manifold. If the induced homomorphism $H_n(f)$ is non-zero, then f is onto.*

Proof. One considers the map induced on the homology H_n of dimension n equal to that of the manifold T . If f fails to be surjective, it factors through the punctured manifold $X \rightarrow T - \{t\}$ for some point t . Now it is a simple fact that the top-dimensional homology of a (Hausdorff) manifold vanishes, so in particular $H_n(T - \{t\})$ is trivial. By functoriality it follows that $H_n(f) = 0$, violating our assumption. ■

In particular $0 = (0, \dots, 0) \in T^g$ would be the image of some $(t_1, \dots, t_d) \in R^d$ and the corresponding potential G given by (4) would have a conjugate differential dG^* meeting the Diophantine requirement.

This strategy requires a good understanding of the mapping \wp perhaps in the sense that when one pole t_i is dragged along the cycle γ_j then the image winds once around the corresponding factor of the torus T^g . Choosing $d = g$ and in the Künneth factor of $H_g(R^d)$ the element $\gamma_1 \otimes \dots \otimes \gamma_g$ which has the correct weight g so as to be an element of $H_g(R^g)$ whose image would be the fundamental class of the torus T^g . This would establish the surjectivity of \wp for $d = g$. Alas, this is a bit too optimistic in the planar case ($p = 0$). So our argument must be foiled at some place. The reasonable result to be expected is $d = g + 1$ (like Ahlfors 1950 [17]) and boosting the method upon choosing $\gamma_1 \otimes \dots \otimes \gamma_{r-1} \otimes (\alpha_1 \star \beta_1) \otimes \dots \otimes (\alpha_p \star \beta_p)$ where the α_i, β_i are the cycles winding around the handles (cf. Fig. 55e) one may expect to achieve $d = r + p$ as predicted in Gabard 2006 [255].

19.1 Digression on Dirichlet (optional)

The Dirichlet solution may be interpreted as the permanent equilibrium state of temperature in a heat-flow conducting medium. Arguably (physico-chemical intuition?), this phenomenology is completely insensitive to the topology. Hence Dirichlet’s problem is always soluble whatever the topological complexity of the bordered manifold is. One only requires a Riemannian metric to give a good sense to the (Beltrami) Laplacian (or the allied mean value property). Hence any metric bordered smooth manifold, say compact to stay in the reasonable realm of finiteness is suitable to pose and solve the first boundary value problem. [Remember maybe that there is vast jungle of non-metric manifolds, those of

Cantor 1883 and Prüfer 1922 being the most prominent examples, but the latter do not enter the scene of function theory at least in complex dimension 1.] Hence Dirichlet makes sense also on non-orientable manifolds, but the case of immediate interest is that of compact bordered Riemann surfaces (*ipso facto* orientable). Solid existence proofs were primarily devised by H. A. Schwarz, alternating method (ca. 1870), etc. with many subsequent extensions, e.g. Nevanlinna 1939 [609], several works of Ahlfors, H. Weyl 1940 [883] (method of orthogonal projection), not to mention Neumann, Poincaré, Korn-Lichtenstein, etc., cf. e.g. Neumann 1900 [603]). Another source is Hilbert-Courant's book cited e.g. for this purposes in Royden's Thesis 1950/52 [714]. [For those inclined toward modern expressionism, there is surely a concept of "Dirichlet space" (Brelot, Beurling, Deny, etc.) which should englobe any bordered Riemannian manifold and much more.]

In the appropriate Hilbert space, minimizing the Dirichlet integral amounts to minimize the length of a vector lying on a certain hypersurface M corresponding to the boundary data $f: \partial F \rightarrow \mathbb{R}$. A priori this hypersurface could spiral around the origin impeding existence of a minimum or be bumpy enough as to violate uniqueness. But one rather imagine it to be a linear manifold implying a unique minimum of the distance function (norm). Of course the hypersurface in question (corresponding to a certain boundary prescription) is readily shown to have linear character, as subtracting any member of it, its translate through the origin identifies with the set of functions vanishing along the boundary. The latter is vectorial, being the kernel of a linear mapping (restriction to the boundary). Dirichlet principle looks thus immediately imputable to an Euclid-Hilbertian conception of space, yet with difficulty concentrating on the existence question of a member (=point) in this hypersurface M (i.e., of a function matching the boundary prescription having with finite Dirichlet integral). As we know Hilbert's solution primarily involved the compactness paradigm, formalized as a such some few years later by Fréchet. The naive minimization procedure is not fairly evident, and indeed plagued by the counterexample of Hadamard 1906 [330], and the earlier one of Prym 1871 [664]. Prym (1871 *loc. cit.*) describes a continuous function on the boundary of the unit disc such that the Dirichlet integral for the associated harmonic extension of the boundary function is infinite. [The latter harmonic extension is known to exist independently of the Dirichlet principle, e.g. on the ground of Poisson's formula which solves Dirichlet in the disc-case.] Later Hadamard (1906 *loc. cit.*) gave a similar example where any (continuous) function matching the boundary data has infinite Dirichlet integral. (Perhaps, any Prym data is also explosive in the sense of Hadamard?) The moral is quite subtle to grasp: roughly the Dirichlet principle fails but not the Dirichlet problem which is always uniquely soluble! Hilbert's solution (ca. 1900 [374], [375]) under special hypotheses (involving only the space and not the boundary data?!) is certainly sufficient for the purpose at hand. Hilbert's hypothesis where weakened in subsequent works by B. Levi 1906 [505], Fubini 1907 [251], Lebesgue 1907 [499], compare also the historiography in Zaremba 1910 [908]. For practical purposes (e.g. for the construction of the Green's function) one can probably restrict attention to reasonable boundary data, as those arising via geometric construction (e.g., the logarithmic charge allied to the construction of the Green's function of a plane smoothly bounded domain). Possibly, for tame boundary data the original Dirichlet principle remains an efficient tool for a direct variational treatment of the boundary value problem.

Alternatively, of Dirichlet-Riemann-Hilbert one may use the classical but cumbersome alternating method of Schwarz (or Neumann's variant) to solve the Dirichlet problem. To summarize we need the result:

Theorem 19.2 (Dirichlet, Riemann, Schwarz 1870, Hilbert 1900, etc.) *Given a compact bordered Riemann surface F , and a continuous boundary function $f: \partial F \rightarrow \mathbb{R}$. There is a unique harmonic function $u: F \rightarrow \mathbb{R}$ extending f .*

Proof. First (rigourously) obtained in Schwarz 1870 [771] via the alternating method. Variation of this technique Picard's method of successive approx-

imation (cf. Picard, Zaremba, Korn, Lichtenstein). Another variant of proof is Hilbert's resurrection of the Dirichlet principle (direct variational method). Reference in book form cf. Hilbert-Courant. Another more modern trend is to use Perron's method which affords great simplification. Compare for instance Ahlfors-Sario 1960 [22, p. 138–141, esp. 11G] for an execution of Perron's method (joint with Harnack's principle) in the context of abstract Riemann surfaces. ■

19.2 From Green to Riemann

In term of the Green function for a simply-connected domain one may write down the Riemann map as

$$f(z) = e^{G+iG^*},$$

where G^* is the conjugate potential (satisfying the Cauchy-Riemann equations). [This is basically the second proof given by Riemann in 1857 [688], and see also e.g. Picard 1915 [645].] That f is a circle map follows from $G \leq 0$ with vanishing precisely on the boundary, and the fact that G^* is single-valued since the domain is simply-connected. Details are supplied during the next Steps, where we examine the more delicate multiply-connected domains or even general compact bordered Riemann surfaces.

Step 3 (Memento about the conjugate potential) The conjugate G^* potential is defined by the desideratum that $G + iG^*$ is holomorphic, i.e. \mathbb{C} -linearizable in the small. This gives the Cauchy-Riemann equations

$$\frac{\partial G}{\partial x} = \frac{\partial G^*}{\partial y}, \quad \frac{\partial G^*}{\partial x} = -\frac{\partial G}{\partial y}.$$

Writing formally G^* as the integral of its differential, gives

$$G^* = \int dG^* = \int \left(\frac{\partial G^*}{\partial x} dx + \frac{\partial G^*}{\partial y} dy \right) = \int \left(-\frac{\partial G}{\partial y} dx + \frac{\partial G}{\partial x} dy \right), \quad (5)$$

whose integrand (a 1-form) coincides actually with the dG twisted by multiplication by i on the tangent bundle. Therefore dG^* is a genuine 1-form canonically attached to the function G . (*Warning.*—The symbol G^* (taken alone) as no intrinsic meaning at least as a single-valued function unless dG^* is period free.)

19.3 The Green's function

But what is the Green's function at all about? It is a sort of logarithmic potential attached to an electric charge placed at t . It is easier to define in the case of a plane domain bounded by smooth curves. The case of ultimate interest (compact bordered Riemann surfaces) will be discussed later. Given a domain $B \subset \mathbb{C}$ (smoothly bounded) marked at an (interior) point t one considers the function $\log |z - t|$ which induces (by restriction) a charge (temperature) on the boundary $\partial B = C$ and one solves the Dirichlet(=first boundary-value) problem for this data. It results an (everywhere regular) harmonic function $u = u(z, t)$, which subtracted from the original logarithmic potential gives the (so-called) *Green's function with pole at t*

$$(\log |z - t|) - u(z) =: G(z, t). \quad (6)$$

By construction, it vanishes along the contour ∂B and possesses a logarithmic singularity near the point t . This is a canonical function attached to the sole data of B and a certain interior point t . Note that $G(z, t)$ tends to $-\infty$ as z approaches t , so one may think of the Green's function as a black hole centered at t with a vertiginous sink plunging into deep darkness.

One can interpret this Green's function as some electric potential (Galvanic current) on a conducting plate. If one prefers a biological metaphor one can

visualize $G(z, t)$ as the proliferation of bacteroides originating from t while expanding through the medium B driven by an apparent global knowledge of the shape of the universe. To be more concrete, the expansion is more rapid where more free resources are available. In particular all bacteria reach synchronously the boundary having consumed all resources of the nutritive substratum in what looks to be the most equitable way. Compare the pictures in the simply-connected case (Fig. 55a) and then for a multi-connected region (Fig. 55b). Trying to imagine the same proliferation occurring on a bordered surface realized say in Euclidean 3-space we get something like Fig. 55d.

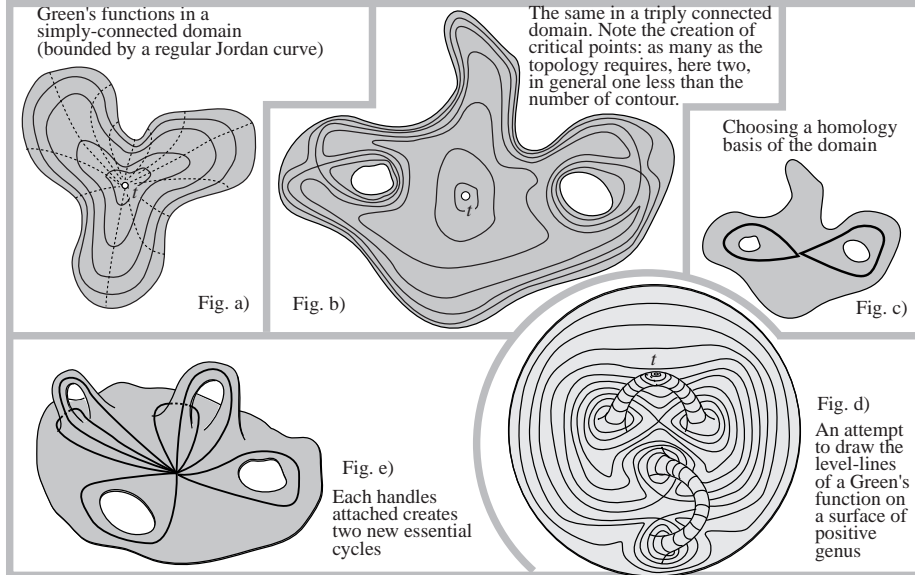

Figure 55: The levels of Green's functions of two planar domains with pole at t , and an attempt to draw Green on a surface of genus 2 (an aggressive bulldog?)

Now it is clear that the above formula $f(z) = f(z, t) = e^{G(z,t)+iG^*(z,t)}$ supplies the Riemann map with $f(t) = 0$ and $f(z) \in S^1$ (unit circle) whenever z lies on the boundary, where G vanishes. Of course the map is only defined up to rotation, coming from an arbitrary additive constant in G^* . [Compare for instance Riemann 1857 [688], Picard 1915 [645], etc.]

If one tries to adapt this proof to multi-connected domains one meets the notorious difficulty that the conjugate potential G^* is not single-valued, a priori. So the efforts focus on eliminating the periods of its differential dG^* by choosing appropriately some accessory parameters. [This universally known device goes back at least to Riemann 1857 [687, p. 122] Schottky 1877 [763], see also Picard 1913 [644], Koebe 1922, Julia 1932 [407], Grunsky 1937 [315], etc.]

Using this idea we may concoct a circle map $B \rightarrow \overline{\Delta}$. [cf. Grunsky 1937 [315] or Grunsky 1978 [322] and also Ahlfors]. The natural trick is probably to take several poles t_i (say d many). Those will ultimately become the zeroes of the circle map we are looking for as $e^{-\infty} = 0$. One now form the combination of the corresponding Green's functions

$$G(z) := \sum_{i=1}^d \lambda_i G(z, t_i) \quad (\lambda_i \in \mathbb{R}).$$

This gives a (finite) constellation of black holes scattered through the domain B and we shall try to choose the constants λ_i so that dG^* has no period. Since the combination G vanishes on the contour ∂B (being a superposition of Green's functions) the allied function $f(z) = f(z; t_i, \lambda_i) := e^{G(z)+iG^*(z)}$ will map ∂B onto S^1 . To arrange it as a circle map $f: B \rightarrow \overline{\Delta}$ requires the basic remarks of the next section, plus the more delicate issue of being able to choose positive $\lambda_i > 0$.

19.4 Quasi-negativity of Green

The following property of the Green's function is basic, yet important.

Lemma 19.3 *Each Green function $G_t(z) := G(z, t)$ is quasi-negative (i.e. ≤ 0 throughout the domain and strictly < 0 in its interior).*

Proof. From its definition (6) it is clear that $G_t(z) \rightarrow -\infty$ as t approaches the pole t . Thus choosing a very large negative (real) constant $C < 0$ the corresponding level line L_C of Green $G_t^{-1}(C)$ will be a nearly circular (Jordan) curve enclosing the pole t in its interior. Further it looks evident that for $C < 0$ large enough (in absolute value) this Jordan curve bounds a (topological) disc in the domain. (One could use the general Schoenflies theorem requiring just to check that L_C is null-homotopic in the domain D .) Next it is intuitive (but need to be arithmetized) that within this sufficiently small disc-shaped domain (i.e. the inside of L_C for $C < 0$ sufficiently large) the Green function G_t is negative (indeed $\leq C$).

Cutting away from the domain D the interior of L_C we obtain an excised domain D^* with one more contour. On this new domain, the Green's function G_t solves Dirichlet (first boundary-value) problem for the data 0 on all contours but $C < 0$ on the newly created contour L_C . We now conclude via the next lemma. ■

Lemma 19.4 (Depressiveness of Dirichlet, or rather the allied harmonic functions) *Let F be a compact bordered Riemann surface. If the (continuous) boundary data function $f: \partial F \rightarrow \mathbb{R}_{\leq 0}$ is non-positive, then so is its Dirichlet solution $u := u(f)$, i.e. $u \leq 0$ throughout F .*

Proof. If not then $u(z_0) > 0$ (positive) at some interior point z_0 of the surface F . By compactness u achieves its maximum, which is positive. Since $f \leq 0$ the latter would not be achieved on the boundary violating the maximum principle (compare the next lemma). ■

Lemma 19.5 (Maximum principle) *Any harmonic function u on a compact bordered surface F achieves its maximum on the boundary ∂F . In fact, if the maximum is achieved at some interior point then the function u is constant.*

Proof. Assume z_0 to be an interior point realizing the maximum M of the harmonic function u defined on F . We trace a little (metric) circle about z_0 of sufficiently small radius as to lie entirely inside F (together with its interior disc D). Harmonicity may be characterized via the *mean-value property* (Gauss, it seems):

$$\int \int_D u(z) d\omega = \text{area}(D) \cdot u(z_0). \quad (7)$$

As $u(z) \leq M$, we get $M \cdot \text{area}(D) \geq \int \int_D u(z) d\omega = \text{area}(D) \cdot u(z_0)$. Since $M = u(z_0)$, both extreme members coincide and so does the last inequality. This forces constancy on the little disc D (u being continuous).

It follows by 'propagation' that u is globally constant. (Alternatively use general topology: the set of points where u achieves its maximum is both non-empty (compactness), closed and open.) Indeed choosing a path from z_0 to any point $z \in F$ covered by a chain of little discs D_1, \dots, D_k , each D_i centered on the border of the previous one D_{i-1} , one argues that two successive discs have enough overlap to ensure constancy over the next disc. ■

Micro-Warning [11.08.12] There is a Garabedian paper 1951 (A PDE..., p. 486) where it is asserted that the Green's function of a convex clamped plate need not be of one sign; but of course this is not relevant to our matter were we use the usual the Laplacian Δ and not the bi-Laplacian Δ^2 corresponding to clamped plates, instead of vibrating membranes. This is the seminal work of Garabedian (but others were also involved) where the famous Hadamard conjecture on the bi-Laplacian was disproved.

19.5 Killing the periods

The previous section ensures that any superposition of Green's functions $G := \sum_i \lambda_i G(z, t_i)$ will be likewise quasi-negative provided all λ_i are positive. In this circumstance the function $f = e^{G+iG^*} = e^G \cdot e^{iG^*}$ (whose modulus is e^G) is a unit-circle map ($|f| \leq 1$), because the real exponential takes nonpositive values $(-\infty, 0]$ to $(0, 1]$. It is consistent by continuity to send the t_i on 0.

If r is the connectivity of the domain B (number of its contours) then there are homologically $r - 1$ non-trivial loops $\gamma_1, \dots, \gamma_{r-1}$ running around the $r - 1$ holes in our domain (cf. Fig. 55c illustrating the case $r = 3$). We consider the linear period mapping

$$\begin{aligned} \mathbb{R}^d &\longrightarrow \mathbb{R}^{r-1} \\ (\lambda_1, \dots, \lambda_d) &\mapsto \left(\int_{\gamma_1} dG^*, \dots, \int_{\gamma_{r-1}} dG^* \right) \end{aligned} \quad (8)$$

By linear algebra if d is large enough (precisely already for $d = r$) we have enough free constants so as to find non-trivial λ_i extinguishing all periods. [Heuristically the electric poles of the multi-battery in the electrolytic tank (nomenclature as in e.g. Courant 1950/52 (Conformal book)) are affected by suitable charges so as to generate an "ideal" potential with single-valued conjugate.] Exponentiating gives $f = e^{G+iG^*}$ a circle map with $d = r$ zeroes, provided one is able to ensure all $\lambda_i > 0$.

Without taking care of this last proviso, one may reach too hastily the impression that we have complete freedom in prescribing the location of the $d = r$ poles (of the Green's functions, which convert ultimately to zeroes of the related circle map). The linear-algebra argument gives only a real-line inside the kernel of the (linear) period-mapping (8), but a priori this line could miss the "octant" $\mathbb{R}_{>0}^d$ consisting of totally positive coordinates. In fact upon letting vanish some of the λ_i what is only required is a non-trivial penetration of this line ℓ into the closed octant $\overline{O} = \mathbb{R}_{\geq 0}^d$, i.e. the intersection $\ell \cap \overline{O}$ should not reduce to the origin. A true penetration of this line in the interior of O , or a degenerate one where the line meet along one of its face would be enough to complete the existence-proof. The latter case amounts to extinct some Green's "batteries" by assigning a vanishing coefficient $\lambda_i = 0$. The net effect would be degree lowering of the circle map f . Beware, that for planar domains (which correspond to Harnack-maximal Schottky doubles) no such lowering of the degree is possible for simple topological reasons ($r \leq \gamma$). However the described theoretical eventuality may well happen in the non-planar case to be soon discussed. Understanding how and why to arrange degenerate penetrations could well offer a strategy toward improving Ahlfors $r + 2p$ bound.

19.6 Extra difficulties in the surface case

It is obvious that the above method via Green's functions adapts to bordered Riemann surface $F = F_{p,r}$ of (positive) genus p with r contours (Rand). Remember however that at this stage we did not offered a complete treatment of the planar case ($p = 0$).

First note a conceptual difficulty regarding Green's function, which, in the plane case of a domain $B \subset \mathbb{C}$, is constructed via $\log |z - t|$ appealing to a global coordinate system. In the abstract bordered setting, there is no such ambient medium. One could try to work with a (conformal) Riemann metric and the allied logarithmic distribution $\log \varrho(z, t)$, where ϱ is the intrinsic distance (defined as usual as the infimum of lengths of rectifiable pathes joining two given points). Note however that this construction specialized to the domain case does not duplicate the former, since the intrinsic distance $\varrho(z, t)$ does not coincide with the extrinsic one $|z - t|$, unless the domain $B \subset \mathbb{C}$ is starlike about t .

Bypassing this difficulty [which will be resolved later], we first note that each handle creates two 1-cycles yielding a total of $(r - 1) + 2p$ many essential loops (compare Fig. 55 e). Thus introducing $d := r + 2p$ poles t_i we dispose of enough free parameters to arrange (via linear algebra) the vanishing of all periods of

the conjugate differential dG^* of the potential $G = \sum_{i=1}^d \lambda_i G_{t_i}$. This explains quite clearly why Ahlfors discovered (about 1948) the upper-bound $r + 2p$ for the degree of a circle map. Of course there is still the subtlety of explaining why it is possible to choose all $\lambda_i > 0$ at least for a clever choice of the poles t_i .

All this is probably when suitably interpreted the quintessence of the Ahlfors mapping (of degree $r + 2p$). Again the writer does not mask his happiness after having understood this point (as late as the 04.08.12). Now it is evident to reconstruct (even if somewhat fictionally) what must have happened in Ahlfors' brain (at least as early as 1948, and presumably much earlier, yet no record in print). With this piece of information and, on the other hand, being well-aware of the modern purely function-theoretic proofs of RMT (à la Koebe-Carathéodory, Fejér-Riesz 1922 (published by Radó 1923), Carathéodory 1928 and Ostrowski 1929) it must have seemed highly desirable (or trendy) to reinterpret the above (somewhat heuristic but fruitful potential theory) in terms of a function-theoretic extremal problem. This leads e.g. to the problem we discussed at length of maximizing either the modulus of the derivative at some inner point $t = a$, or to maximize the distance of two points a, b where the first maps to 0 and the second is repulsed at maximum distance from the origin. In both case the competing functions are analytic and bounded-by-one in modulus $|f| \leq 1$. So we get the Ahlfors function f_a or $f_{a,b}$. It seems obvious that all those Ahlfors functions are included in the above trick à la Green-Riemann (GR), and thus subsumed to an electrolytic interpretation. Yet the exact dependance and location of the corresponding logarithmic poles of Green's G (becoming the zero of Riemann's f , after exponentiation) must be a transcendentially sublime business. Also the corresponding degree of the Ahlfors function is another mystery.

It is conceivable that less than the $r + 2p$ generically required poles suffices in case the linear period mapping $\mathbb{R}^d \rightarrow \mathbb{R}^{(r-1)+2p}$ along fundamental loops has a degenerate image permitting to economize some poles t_i . The task is reduced to find the lowest d such that the kernel of the period map is non-trivial and contains a non-zero element all of whose coordinates are ≥ 0 . Remember, that Gabard 2006 [255] showed—using another method, based on a topological argument of irrigation (Riemann-Betti-Jordan-Poincaré's homologies, and Brouwer's degree plus some basic Pontrjagin theory in the Jacobian torus as a very special commutative Lie group—that there is a circle map of degree $\leq r + p$ (i.e. with one unit economized for each handle). Assuming that any circle map is allied to a Green-Riemann map there would be a fewer number namely $d \leq r + p$ of batteries required to generate this mapping. Of course, the first part of the assertion looks evident: given a degree d circle map f with zeroes at t_i , then $\log |f(z)|$ coincides with $\sum_{i=1}^d G(z, t_i)$. This is Ahlfors formula following from the fact that both functions vanishes on the border and have the same singularities.

Philosophy. [08.08.12] Modulo elusive details, it is fair to resume the situation by saying that the Ahlfors circle maps (if not all existence theorems of function theory) derives form the Dirichlet principle (or the allied Green's functions). [This was of course best incarnated by Riemann, 1851 and 1857, where in bonus the whole algebraic geometry of curves was subsumed to this principle!] Conversely one could hope that the Ahlfors function could be used to lift the Dirichlet solubility on the disc (via Poisson integral formula) to an arbitrary bordered surface. However it seems obvious that there is no way to descend the boundary function to the disc since the Ahlfors branched covering is multi-valent. We arrive at the conclusion that the true mushroom is the Dirichlet principle, while Ahlfors function being just one tentacle of the mushroom. Of course, the only paradigm susceptible of competing with Dirichlet are the function-theoretic extremal problems à la Koebe-Carathéodory-Fejér-Riesz-Bieberbach-Ostrowski, etc. For plane domains the Kreisnormierung (instead of the Ahlfors map) may be used as normal domains where the Dirichlet problem is easier to solve. This is akin to Poisson's formula for the round disc case of Dirichlet, and quite implicit in Riemann's Nachlass 1857 [689] (cf. also Bieberbach 1925 [97]). A similar reduction of Dirichlet for bordered surfaces occurs is also likely on the ground of Klein's Rückkehrsnitttheorem (cf. Section 6.5), supposed to be an extension of the Kreisnormierung.

Regarding the detailed execution of the removal of the period as to construct

an Ahlfors-type mapping one should compare also the paper of Heins 1950 [358], Kuramochi 1952 [487] and (albeit confined to planar domains) the paper by D. Khavinson 1984 [425], whose argument is considered by its author akin to the arguments of Grunsky.

19.7 The Green's function of a compact bordered Riemann surface=CBRS

[14.08.12] This section examines the issue that the Green's function $G(z, t)$ with pole at t is a canonically defined function in the generality of a CBRS. This is super-classical, cf. e.g., the treatises Ahlfors-Sario 1960 [22] or Schiffer-Spencer 1954 [753]. It is to be expected to find older treatments by Riemann, Schwarz, Klein, Koebe, etc. Several accounts by Nevanlinna proceed via Schwarz's alternating method, a viewpoint which looked most convenient to adhere with.

As already noticed, the case of a plane domain $B \subset \mathbb{C}$ (bounded by smooth curves) it is easy to define Green's function $G(z, t)$ via the (logarithmic) potential $\log|z-t|$ from which we subtract the Dirichlet solution matching the logarithmic potential restricted to the boundary ∂B . Alas, for a CBRS F one lacks an ambient space like \mathbb{C} permitting an analogous construction.

Of course, $\log|z-t|$ bears some significance only locally within a uniformizer chart about t . Taking another local chart, one may argue that in the small the expression will mutate into $\log|\alpha(z-t)|$ for some $\alpha \in \mathbb{C}^*$ incarnating the derivative of the transition between the two charts. Thus the log-potential w.r.t. the new chart is $\log|\alpha| + \log|z-t|$, hence equal to the old one modulo an additive constant. Presumably some philosophical argument can corroborate the vague feeling that the asymptotic of the logarithmic pole is unaffected by such additive constant. [Added in proof: compare Pfluger 1957 [640, p. 110, 28.3] for an accurate formulation, or Farkas-Kra 1980/1992 [230, p. 182, Remark].] It seems then meaningful to set:

Definition 19.6 *The Green's function of a CBRS F with pole at t (an interior point of F) is the unique harmonic function on F save t with singularity $\log|z-t|$ near t which vanishes continuously on the boundary ∂F .*

Compare (modulo a different sign convention) Ahlfors-Sario 1960 [22, p. 158, 4B]. Uniqueness is considered as evident there. Indeed, a chart change affect the logarithmic potential by an additive constant and harmonic functions are quite rigid (being determined by their values on any open disc). Hence knowledge of the function on any punctured chart about t via $\log|z-t|$ determines it uniquely. The delicate point is existence. Choose around t a nice analytic Jordan curve J and via RMT construct a holomorphic chart taking D (the "sealed" interior of J , i.e. J included) to the unit disc $\overline{\Delta}$. Consider $\log|z|$ in the unit circle and transplant to $D \subset F$ and then after adding an additive constant we try to solve a Dirichlet-Neumann problem on $F - D$ piecing together smoothly the logarithmic piece with the Dirichlet-Neumann solution. In this procedure the Green's function looks highly non-unique depending on the "ovaloidness" of the Jordan curve J chosen. In fact J cannot be chosen at will but must somehow be a level-line of Green (still undefined). Infinitesimally J should be a perfect circle, and this is perhaps the key to put the naive pasting argument on a sound basis via a convergence procedure. (Infinitesimal circles are well-defined on Riemann surfaces via the conformal structure.) Existence and uniqueness look then plausible, but involve a considerable sophistication over the plane-case where the Green's function reduced straightforwardly to the Dirichlet problem.

Let us paraphrase the above more formally. Take any chart $\varphi: U \rightarrow \Delta$ about the "pole" point t (sending t to the origin $0 \in \mathbb{C}$), write down $\log|z|$ in that chart and shrink gradually attention to the (round) disc Δ_ε of radius ε . Let D_ε be $\varphi^{-1}(\Delta_\varepsilon)$. For each (positive) value of ε one can solve the Dirichlet problem in $F - \text{int}D_\varepsilon$ with boundary value 0 on ∂F and $\log \varepsilon$ on ∂D_ε . Denote by u_ε the corresponding solution. By construction u_ε pasts continuously with the φ -pullback of the log-potential (i.e. $(\log|z|) \circ \varphi$). Of course this glued function

is a Frankenstein creature lacking a smooth juncture. For instance, if $\varepsilon = 1$ then u_ε is identically zero, whereas in D_1 we have the logarithmic “trumpet” with derivative 1 along the normal direction. However as ε decreases from 1 to 0, u_ε becomes ≤ 0 (having prescribed the negative value $\log \varepsilon$ on ∂D_ε) and the dependence of u_ε is perhaps monotonic. So it seems arguable (Harnack?) that while $\varepsilon \rightarrow 0$ (say via dyadic numbers $\varepsilon_n = 1/2^n$) the u_n converges to a harmonic function on $F - t$ which is the desired Green’s function $G(z, t)$. It seems evident (since ∂D_n becomes more and more circular in F as n grows to infinity) that the limit is harmonic and independent of the gadgets used along the way (chart φ , dyadic sequence ε).

This vaguely explains existence and uniqueness can maybe be derived by a similar trick (combined with a “leapfrog” argument). Try to locate a reference along this naive line: maybe Schwarz?, Klein? Koebe? Weyl? Pfluger? and otherwise try Ahlfors-Sario [22], Sario-Oikawa [739]. (Sometimes Sario’s formalism of the normal/principal operator is a bit awkward to digest.) For treatments of the Green’s function on a CBRS cf. Schiffer-Spencer 1954 [753, p. 33, and 93–94]. See also Sario-Oikawa 1969 [739, p. 49–50]. We summarize the discussion by the

Theorem 19.7 *Given a CBRS F and an interior point t , there is a uniquely defined Green’s function $G(z, t)$ with pole t which is characterized by the following conditions: it is harmonic on $F - t$, vanishes (continuously) on the boundary ∂F and it has the prescribed singularity $\log |z - t|$ near t .*

Proof. For complete details, compare several sources:

- first Ahlfors-Sario 1960 [22, p. 158] and Sario-Oikawa 1969 [739, p. 50] (both via Perron’s method, and Sario’s formalism of the normal operator).
- Then also Pfluger 1957 [640, p. 110, end of §28.2, as well as p. 110, §28.3 and last 3 lines of p. 111]
- Schiffer-Spencer 1954 [753, §4.2, p. 93–94]
- Nevanlinna 1953 [612] via Schwarz’s alternating method (SAM). We detail this argument in the next section. ■

19.8 Schwarz’s alternating method to construct the Green’s function of a compact bordered surface (Nevanlinna’s account)

[15.08.12] As promised, in this section we attempt to understand Nevanlinna’s exposition of the existence of Green’s functions on compact bordered surfaces. All pagination given refers to Nevanlinna 1953 [612], the book “Uniformisierung”. Nevanlinna follows Schwarz’s alternating method (SAM) quite closely. The argument is a bit tedious but quite elementary. It uses merely the following facts on a bordered surface F :

- (1) if $f \leq g$ on ∂F then the associated Dirichlet solution $u(f) \leq u(g)$ (compare Lemma 19.4).
- (2) maybe Harnack’s theorem is required?

In Nevanlinna’s book the relevant information is scattered at two places (at least) so we attempted to compactify the presentation for our own understanding.

First Nevanlinna introduces a concept of “Kreisbereich”. Alas the jargon is not very fortunate being already consecrated by Koebe in a different context, so let us speak rather of a “celluloid” (or a “Kreisgebilde”). This is [cf. p. 142] a connected finite union of (closed) discs in a Riemann surface (whose images by a (parametric) chart are round discs in \mathbb{C}). On each such disc the first boundary value problem (abridged DP=Dirichlet problem) is soluble via Poisson’s formula. Assuming the contours of each pair of discs to have finite intersection, SAM enables one to solve DP on the union, hence on any celluloid.

So for instance it is clear that any CBRS is a celluloid. (A formal proof certainly requires Radó’s triangulation theorem 1925 [670].) To absorb the

boundary in one stroke one could add annular regions where the DP is also soluble by an explicit recipe, sometimes ascribed to Villat 1912 [847].

The Green's function will be obtained by specializing the following technical lemma [cf. p. 148] [due to Schwarz and probably related to what Koebe's calls the "gürtelförmige Verschmelzung" (\approx belt-shaped fusion)]. Intuitively, the lemma amounts to construct a harmonic function u with prescribed boundary values and with prescribed singularity u_0 near a point t , or rather on a ring enclosing the pole t . (At first, it is not perfectly transparent how to deduce the Green's function from the lemma, but we shall try elucidate this issue later.)

Lemma 19.8 *Let F be a compact bordered Riemann surface and $t \in \text{int}F$ an interior point. Let U be a neighborhood of t mapped to the unit-disc $\Delta = \{|z| < 1\}$ via a chart. In U , let K be the ring corresponding to $r_1 \leq |z| \leq r < 1$. [It seems that $r_1 = 0$ is permissible and needed for the application to the Green's function.] Let further X be a celluloid containing the external contour of the ring K ($|z| = r$) in its interior, as well as the boundary ∂F but missing the small disc in U corresponding to $|z| \leq r_1$. Set finally $A := X \cup K$ (compare Fig. 56).*

Then given $u_0 \in H(K)$ (harmonic on the ring K) and $f: \partial F \rightarrow \mathbb{R}$ continuous, there is a unique $u \in H(A)$ such that $u|_{\partial F} = f$ and with $u - u_0$ extending harmonically to B , the disc corresponding to $|z| \leq r$.

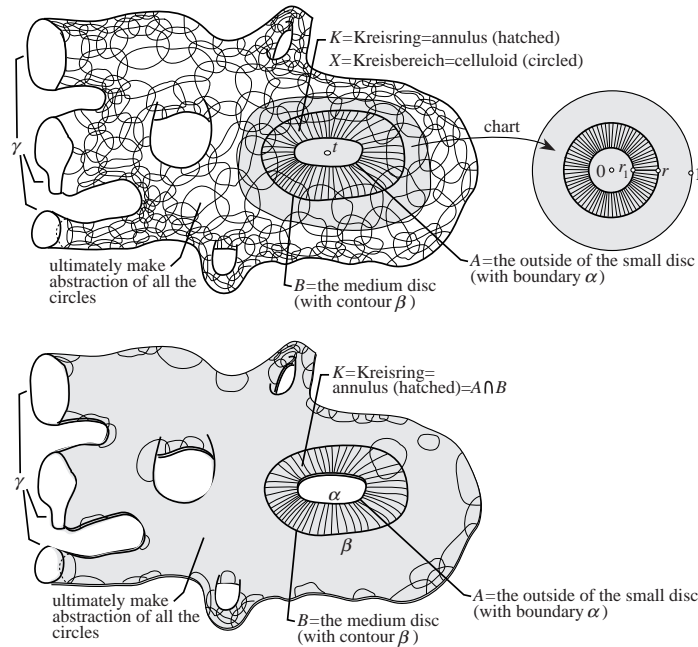

Figure 56: Schwarz's alternating method (Nevanlinna's implementation) to construct the Green's function of a compact bordered surface with pole at t

Before detailing the proof, let us see how this helps defining $G(z, t)$ the Green's function. [The difficulty is just so trivial to be not completely explicit in Nevanlinna [p. 198–199, §2, Art. 6.4].] First we impose $f \equiv 0$. Then we choose the singularity function $u_0 = \log |z|$ which has to be defined on K , hence we shrink r_1 to 0 via a sequence of dyadic radii $r_n = 1/2^n$. On applying the lemma we get a sequence of solution $u = u_n$ defined on A_n a sequence of expanding subsurfaces (the outsides of the shrinking discs $|z| < 1/2^n$). Now observe that u_n for a large n solves the problem of the lemma for all smaller values of n : just take the restriction (and use uniqueness). Consequently all the u_n form a telescopic system of functions (each restricting to all its predecessors) defined on larger and larger compact subregions A_n ultimately expanding to the punctured surface $F - t$. The very constant (indeed completely monotone) limit of those u_n gives the desired Green's function $G(z, t)$.

It is harmonic on F save t , vanishes on the boundary and $G(z, t) - \log |z|$ extends harmonically through t (on a little neighborhood). It remains to check that those 3 properties defines $G(z, t)$ unambiguously. This is again the same sort of argument. Assume there were two Green's solutions G_1, G_2 , then $G_i - u_0 =: h_i$ harmonic on some neighborhoods V_i of t . So $G_1 - G_2 = (h_1 + u_0) - (h_2 + u_0) = h_1 - h_2$ which is harmonic on the intersection $V_1 \cap V_2$. Hence the difference $G_1 - G_2$ is harmonic throughout F , but with vanishing boundary value on ∂F . Consequently it must be identically zero (by the uniqueness part of Dirichlet) which follows from the maximum principle.

Proof. This is a matter of implementing Schwarz's alternating method [see p. 148–150] and we follow exactly Nevanlinna's text (annotating our copy by the symbol \star to indicate the sole cosmetic difference).

- *Uniqueness* Assuming the existence of two functions u_1, u_2 solving the problem, their difference $u_1 - u_2$ will be harmonic on A , and 0 on $\gamma := \partial F$. But each difference $u_i - u_0 =: h_i \in H(B)$ extends harmonically across B ($i = 1, 2$). Hence on B , $u_1 - u_2 = (h_1 + u_0) - (h_2 + u_0) = h_1 - h_2 \in H(B)$, and therefore $u_1 - u_2 \in H(A \cup B)$, and $A \cup B$ is all of F . It follows (Dirichlet's uniqueness) that $u_1 - u_2$ vanishes identically.

- *Optional remark.* It is clear that the case $f \equiv 0$ is typical, since the general case just requires adding the Dirichlet solution for the data f . [This explains why I had the impression to find many misprints!]

- *Existence (after Schwarz)* First it is observed that DP is solvable on both A and B (B is just a ball and A is a celluloid, yet of the general type involving a ring). Of course A is also a compact bordered surface and therefore one is ensured of Dirichlet solvability, thereby bypassing the concept of a celluloid, and accordingly one can shorten slightly the statement of Nevanlinna's lemma, with the direct bonus that one can make abstraction of all the little discs drawn on the picture. [CAUTION: here it is perhaps NOT permissible to take $r_1 = 0$]

We denote by α and β the internal resp. external contour of K , and let $\gamma := \partial F$. Set first $v_0 \equiv 0$. We define inductively sequences $u_n \in H(A)$ and $v_n \in H(B)$ by their boundary values ($n \geq 1$)

$$u_n = \begin{cases} v_{n-1} + u_0 & \text{on } \alpha, \\ 0[\star \text{or } f] & \text{on } \gamma, \end{cases} \quad (9)$$

and

$$v_n = u_n - u_0 \quad \text{on } \beta.$$

[This Ansatz comes a bit out of the blue, but notice that passing to the limit both definitions leads to the identity $u - u_0 = v$ holding on $\alpha \cup \beta$ which is the full contour of the ring K , so that anticipating harmonicity this will hold throughout K , and v will afford the required extension of $u - u_0$ (only defined on $A \cap K = K$) to the disc B containing the ring K . Of course, it is also crucial to notice that both sequences u_n, v_n are "interlocked" or "leapfrogged" requiring an alternating progression of one term to go one step further with the other.]

The successive differences are given by

$$u_{n+1} - u_n = \begin{cases} v_n - v_{n-1} & \text{on } \alpha \\ 0 & \text{on } \gamma \end{cases} \quad (10)$$

and

$$v_{n+1} - v_n = u_{n+1} - u_n \quad \text{on } \beta.$$

Let us write

$$M_n := \max_{\beta} |u_n - u_{n-1}| = \max_{\beta} |v_n - v_{n-1}|,$$

then by the maximum- and minimum-principle $|v_n - v_{n-1}| \leq M_n$ in B , and so in particular on α . Hence by (10), $|u_{n+1} - u_n| \leq M_n$ on α . Further, the difference $u_{n+1} - u_n$ vanishes on γ (cf. (10)), and so it is bounded on the boundary of A

(and therefore throughout A) by the potential $M_n \cdot \omega$, where ω is the harmonic function vanishing along γ and equal to 1 on α . Hence

$$|u_{n+1} - u_n| \leq M_n \cdot \omega \quad \text{in } A. \quad (11)$$

In the interior of A , one has $0 < \omega < 1$. If q is the maximum of ω on β , then $0 < q < 1$. Further on β we have

$$|u_{n+1} - u_n| \leq q \cdot M_n,$$

and also (by definition of M_n)

$$M_{n+1} \leq q \cdot M_n.$$

By induction, it follows that

$$M_{n+1} \leq q^n \cdot M_1,$$

and recalling again the definition of M_n we get (first on β and thus on B)

$$|v_{n+1} - v_n| \leq M_{n+1} \leq q^n \cdot M_1.$$

When particularized to α , this implies in view of (10)

$$|u_{n+1} - u_n| \leq q^{n-1} \cdot M_1 \quad \text{in } \alpha,$$

and by the maximum principle this extends to A (recall that $\partial A = \alpha \cup \gamma$ and the function $u_{n+1} - u_n$ vanishes on γ). Consequently, both series $\sum_n (u_{n+1} - u_n)$ and $\sum_n (v_{n+1} - v_n)$ converges uniformly on A resp. B .

The limiting functions u and v of u_n resp. v_n are therefore harmonic on A resp. B , and taking the limit in the definition of u_n (see (9)) we see that u vanishes on γ [\star equals f on γ].

We show finally that $u - u_0 = v$ on B [\star K probably?]. Indeed, taking the limit in the first line of (9) gives $u = v + u_0$ on α , and the definition of v_n pushed to its limit gives $v = u - u_0$ on β . Therefore the same identity $u - u_0 = v$ holds on both contours of the ring K , and consequently its validity propagates throughout K .

Finally, as v is harmonic on B we are happy to conclude that u fulfills all of our requirements: namely $u \in H(A)$, $u = f$ on $\gamma = \partial F$ and $u - u_0$ defined on $A \cap K = K$ coincide there with v defined on the larger set $B \supset K$, yielding the asserted harmonic extension. \blacksquare

[NAIVE AND WRONG—see rather the argument given above] Finally, [compare p.198–199] one obtains the Green's function $G(z, t)$ by taking $u_0 = \log |z|$, $f \equiv 0$ and $r_1 = 0$ [Caution: this point is not made explicit in Nevanlinna]. For this choice of r_1 , note that $A = F - t$. The lemma supplies a unique $u \in H(F - t)$ such that $u|_{\partial F} = 0$ and so that $u - \log |z| =: h$ is harmonic on F . The function u is the desired Green's function $G(z, t)$.

19.9 From Green to Gromov? (directly bypassing Riemann and Löwner)

The following three subsections are optional reading containing more questions than answers. The reader interested primarily in the Ahlfors map should preferably skip them.

To mention once more a deep frustration (the Gromov filling conjecture) it looks not completely crazy to hope that a careful examination of the Green's function and the allied isothermic coordinates could prompt a solution of this problem. We tried quickly the [14.08.12] but failed dramatically as usual (i.e. together with circa 10 attempts of essentially the same vein). Roughly the idea would be to look at the streamlines of Green and its equipotentials, and remove every trajectory ending to the (finitely many) critical points of Green while attempting to estimate area via this (isothermic) parametrization. Of course, Schwarz's inequality enters into the game but I only arrived at weak estimates like π or $\pi/2$ (in place of 2π !) upon doing highly fallacious calculus.

19.10 Schoenflies via Green?

A notorious topological paradigm is the so-called Schoenflies theorem to the effect that a reasonably embedded sphere S^{n-1} in \mathbb{R}^n bounds a topological ball B^n . (There is a large debate (cf. e.g. Siebenmann 2005 [788]) about who (and more broadly speaking which community) proved first the case $n = 2$. In the topological-combinatorial realm there is a contribution of Schoenflies reaching full maturity ca. 1906, and somewhat earlier there is the contribution of Os-good which may have reached full stability with Carathéodory 1912 [138]. Of course the statement (for $n = 2$ and maybe even $n = 3$) was largely anticipated heuristically by other workers, e.g. Moebius 1863 [565]. Schoenflies's theorem was extended to higher dimensions by J. W. Alexander ($n = 3$ ca. 1922), B. Mazur and M. Brown (all n ca. 1960) for any locally flat (e.g. smooth) hypersphere in \mathbb{R}^n . From Thom or Smale's h -cobordism theorem (early 1960's) it is inferred that the closed ball B^n carries a unique smooth structure when $n \neq 4$ (the case $n = 4$ being still largely unsettled). It follows that the interior of the smoothly embedded sphere is a ball differentiably. Another unsolved problem of longstanding is the truth of the same conclusion for $n = 4$ (the so-called *smooth Schoenflies* in dimension 4, SS4, see e.g. papers by Scharlemann). Naive physical (or bacteriological, cf. Fig. 55) intuition about the Green's function makes hard to visualize why there should be any anomaly for $n = 4$, yet nobody ever succeeded to prove or disprove SS4. This belongs to the charming mysteries of low-dimensional differential topology at the critical dimension $n = 4$. One may speculate about a naive approach to SS4 through the ca. 200 years older potential theory (of Laplace, Poisson, Green, Gauss, Dirichlet and Riemann's era). Alas, there is few records in print of analysts feeling confident enough about the explorative aptitudes of the Green's function (compare Fig. 55) to claim the required diffeomorphism with B^4 . Of course in the very small vicinity of the pole t the levels of $G(z, t)$ (now $z \in \mathbb{R}^n$) look alike round spheres, and by the synchronization principle stating that each bacteria reaches the boundary at the same moment it may look immediate how to write down the diffeomorphism. Can somebody explain why this Green's strategy fails to establish SS4. Less ambitiously can somebody reprove SS n (for $n \neq 4$) via the Green's function. If yes with some little chance his/her proof will possibly include the case $n = 4$.

19.11 Green, Schoenflies, Bergman and Lu Qi-Keng

[06.08.12] As discussed in the previous section, a dream would be to show SS4 (smooth Schoenflies conjecture) via the Green's function in 4D-space \mathbb{R}^4 . On reading an article by Boas 1996 (PAMS), where Suita-Yamada 1976 [817] is cited we see a potential connection between both problems.

The problem of Lu Qi-Keng asks for domains where the Bergman kernel is zero-free (so-called Lu Qi-Keng=LQK-domains). Since Schiffer 1946 [748], there is an identity connecting the Bergman kernel to the Green's function. It seems that the zeros of Bergman corresponds to the critical points of Green. Of course the latter is forced to have critical points as soon as the topology is complicated (not a disc). Suita-Yamada's result that the Bergman kernel necessarily exhibits zeroes for membranes which are not discs looks nearly obvious. Hence LQK-bordered surfaces are precisely those topologically equivalent to the disc.

Now Boas in 1986 found a counterexample showing that no topological characterization of LQK-domains holds in higher dimensions: there exists in \mathbb{C}^2 a bounded, strongly pseudoconvex, contractible domain with C^∞ regular boundary whose Bergman kernel does have zeroes. [Addendum [18.09.12]: in fact upon reading Boas original paper (1986), Boas' domain is diffeomorphic to the ball B^4 .]

Optimistic scenario (Green implies Schoenflies) It would be interesting to know what the topology of Boas' hypersurface $S = \partial\Omega$ is. In view of Poincaré-Alexander-Lefschetz duality S must be a homology sphere, if I don't mistake. Now upon speculating that SS4 is true (by naive geometric intuition), and even more that it is provable via the streamlines of Green's function, and

granting a persistence of Schiffer’s Green-Bergman identity (in the realm of two complex variables), it may seem that Boas’s counterexample must have an “exotic” boundary (not diffeomorphic to S^3). [Of course, not so in view of the just given Addendum.]

Pessimistic scenario (Green does not implies Schoenflies). The other way around, assuming that Boas’ boundary is the 3-sphere, there would be critical points of the Green’s function $G(z, t)$ and Boas’s example may foil any naive attempt to reduces SS4 to the streamlines of the Green’s function. But even so maybe the Green-Bergman identity of Schiffer is specific to one complex variable, leaving some light hope that there is a potential theoretic proof of the differential-topology puzzle of SS4.

So a bold conjecture (somewhat against Boas’ philosophy that there is no topological characterisation of LQK-domains) would be that any domain in \mathbb{C}^2 bounded by a smoothly embedded 3-sphere is a LQK-domain (i.e. its Bergman function is zero-free). [This is wrong in view of Boas 1984 (addendum just mentioned)]. However it could be true that the Green’s functions $G(z, t)$ for any center t located in the inside of Σ is critical point free, whereupon an elementary integration of its gradient flow should establish a diffeomorphism of the inside the spheroid with the ball B^4 with its usual differential structure. (Recall that it is yet another puzzle of low-dimensional topology, whether the 4-ball has a unique smooth structure! All others balls (maybe except the five-dimensional one) do enjoy uniqueness by virtue of Smale’s h -cobordism theorem.) Note that the Bergman kernel is defined without reference to a basepoint whereas Green’s function requires a basepoint (its pole).

19.12 Arithmetics vs. Geometry (Belyi-Grothendieck vs. Ahlfors)

[10.08.12] Closed Riemann surfaces are subsumed to the (alienating) theorem of Belyi-Grothendieck, that *a surface is defined over $\overline{\mathbb{Q}}$ iff it admits a morphism to the line \mathbb{P}^1 ramified at only 3 points* (so-called *Belyi map*). Another characterization (due to Shabat-Voevodsky 1989 [782]) is the possibility to triangulate the surface by equilateral triangles (with or without respect to the hyperbolic uniformizing metric). Basically this follows as one may sent homographically the 3 points to the vertices of the regular tetrahedron inscribed in the sphere. (Compare Belyi 1979/80 [90], Grothendieck 1984 [310] “Esquisse d’un programme”, Shabat-Voevodsky 1989 [782], Bost 1989/92/95 [112] (p. 99–102), Colin de Verdière-Marin, etc.)

Is there an analog of this result for bordered surfaces in the context of Ahlfors (circle) mapping to the disc, and if so what is its precise shape? In the Riemann sphere any 3 points are transmutable through a Moebius rigid motion. The analog statement in the disc involves either one boundary point plus one interior point or 3 boundary points. Those are of course just the (heminegligent) hemispherical trace of real triads on the equatorial sphere corresponding to \mathbb{P}^1 with its standard real structure. (Remember that there is an exotic twisted real structure projectively realized by the invisible conic $x_0^2 + x_1^2 + x_2^2 = 0$.) This lack of canonical choice of a real triad on \mathbb{P}^1 could plague slightly an appropriate bordered version of Belyi-Grothendieck. [12.11.12] More seriously the ubiquity of real points in both those triads of the disc looks incompatible with Ahlfors maps lacking real ramification (when Schottky doubled to the realm of Klein’s orthosymmetric curves). Of course since bordered surfaces are in bijective correspondence with real orthosymmetric curves, one may expect first an answer along the line: *a real orthosymmetric curve is defined over $\overline{\mathbb{Q}} \cap \mathbb{R} \supset \mathbb{Q}$ iff it admits a totally real map ramified solely at 3 real points or at one real point and 2 imaginary conjugate points*. Remember yet that total reality means that the inverse image of the real line is the real locus of the (orthosymmetric) curve, and since such maps lack real ramification our naive real version of Belyi-Grothendieck looks foiled. There seems to be a structural incompatibility between Belyi-Grothendieck and Klein-Ahlfors. Of course our desideratum of a

simultaneous realization of Belyi-Grothendieck and arithmetization of Ahlfors may well just be a nihilist folly. By an “arithmetization of the Ahlfors map” we just mean something in much the same way as Belyi-Grothendieck arithmetizes Riemann’s existence theorem (any closed Riemann surface admits a morphism to the sphere $\mathbb{P}^1(\mathbb{C})$). Possibly, one should be content with a reality version of Belyi-Grothendieck without bringing Ahlfors’ total reality into the picture. Then we have something like *a real curve is defined over $\overline{\mathbb{Q}}$ iff it admits a real morphism to the line ramified above only one of the two real triads, i.e. $0, 1, \infty$ or $0, \pm i$* . A priori this statement tolerates both types of real curves (ortho- and diasymmetric) and thus be more liberal than Ahlfors theorem (which tolerate only orthosymmetric curves). Adhering instead to the geometric interpretation of Belyi-Grothendieck (due to Shabat-Voevodsky 1989/89 [782]) in terms of equilateral triangulations might be more appealing. For instance one can imagine an orthosymmetric real curve with an equilateral triangulation invariant under (complex) conjugation. A such would according to BG be defined over $\overline{\mathbb{Q}}$. It is clear that such a triangulation would contain the real circuits as subcomplex of the triangulation. In particular what is the significance of the corresponding vertices, e.g. as rational points of the curve. Also the tetrahedron plays some role in Belyi-Grothendieck-Shabat-Voevodsky and what are the role of the other Platonic solids? In particular the octahedron looks particularly well suited for getting pull-backed by the the Ahlfors map? etc. [14.11.12] Of course invariant equilateral triangulability is not reserved to orthosymmetric patterns, as shown e.g. by the sphere acted upon by the antipodal map endowed with a Platonic triangulation invariant under the involution (octahedron and icosahedron). One can also consider in genus 1 a rhombic lattice in \mathbb{C} leading to a diasymmetric (non dividing) curve with $r = 1$ real circuit. When the lattice is equilateral say spanned by 1 and ω a cubic root of -1 , we have an obvious invariant equilateral triangulation by 8 triangles (with vertices at $0, 1/2, 1, \omega/2, \omega/2 + 1/2, \omega$ and their conjugates).

[10.08.12] Back to the closed case, we know (Mordell-Faltings ca. 1981) that when the genus is $g \geq 2$ then the curve has finitely many rational points in any number field (finite extension of \mathbb{Q}). Of course this fails if we raise up to the full $\overline{\mathbb{Q}}$ (as slicing a plane model by rational lines gives infinitely many $\overline{\mathbb{Q}}$ -points on the curve). One can dream on a connection between the “canonical” equilateral triangulation (ET) and the finitely many rational points evaluated in the various number fields.

Of course given an ET of an arithmetic (Riemann) surface we can imagine a subdivision into another ET. Given a Euclidean equilateral triangle it is obvious how to subdivide it in 4 smaller equilateral triangles (bisecting the edges). Is there an equivalent subdivision for hyperbolic equilateral triangles? (I cannot see one...) Thus maybe there is some rigidity. At any rate among all ET of an arithmetic $\overline{\mathbb{Q}}$ -surface there is one involving the least number of triangles. This gives an integer invariant for any Riemann surface defined over $\overline{\mathbb{Q}}$. Can this value be related to the finitely many rational points when $g \geq 2$?

By Gauss(-Bonnet) $[\alpha + \beta + \gamma = \pi + \int_T K dA]$ which reduces to $3\alpha = \pi - area$ for an equi-triangle in constant negative curvature equal to -1 we see a direct relation between the area and its angle of an equi-triangle.

20 Ahlfors’ proof

[27.08.12] This section is our modest attempt to examine and understand Ahlfors’ existence proof of a circle map (of degree $\leq r + 2p$). Alas we failed this basic goal, but it is perhaps of some interest to discuss the original text while trying to capture some mental pictures (made real) which may have circulated in Ahlfors’ vision. More objectively we also try to identify if Ahlfors argument can be boosted to reassess the prediction of maps with smaller controlled degree $\leq r + p$ (Gabard 2006 [255]). We emphasize once more that Gabard’s result is potentially false, but even if so, it is evident that for low values of the invariants

(r, p) Ahlfors bound $r + 2p$ fails sharpness. Near its completion, Ahlfors proof takes a geometric “tournure” (convex geometry) where there seems to be some free room suitable for improvements. We tried to imagine some (topological) strategy which could possibly sharpen Ahlfors result along his method (at least for low invariants). This is, apart from didactic interest, the only original idea of the present section.

In the original paper Ahlfors 1950 [17, p.124–126], the existence proof, we are interested in, occupies only a short 2 pages argument which looks essentially self-contained albeit not quite easy to digest. I would (personally) be extremely grateful if someone understanding Ahlfors proof could publish a more pedestrian account than Ahlfors’s, explaining it in full details. Some of the background required is dispatched earlier in the text (esp. p.103–105 in *loc. cit.*), hence trying some rearrangement could improve readability. We were personally not able to follow all the (boring) computations or formulas required by Ahlfors.

Alas, big masters tend to give only cryptical output of boring computations. Ahlfors is further typical for his annoying (arrogant?) style “it is clear that”, etc. and one often suffers a lot just to fill some details. Of course, nothing is clear in mathematics especially when it comes to follow mechanical computations. Maybe the presence of those just reveals a lack of conceptual grasp over the underlying geometry. Trying to be more optimistic and less severe due to frustration, it would be nice—I repeat myself intentionally—if somebody could take the defense of Ahlfors by presenting an argument as close as possible to the original (meaning perhaps just eradication of misprints, if any?) which further would be completely mechanical, i.e. where each identity is decorated by the appropriate tag referring to the formula under application.

Of course, Ahlfors’s proof seems to involve nothing more than the formalism of differential forms (à la Cartan, de Rham, etc., which he learned from A. Weil’s visit in Scandinavia during World War II), plus Stokes’ formula (already a nightmare to prove, at least for Bourbaki) and the allied integration-by-part formula (consequence of Leibniz’s rule). We were personally unable to produce a perfectly pedestrian (accessible to anybody, in particular myself!) exposition of Ahlfors’ account, lacking both intelligence and patience to make his text perfectly intelligible. The writer probably read this Ahlfors’ argument several times in diagonal (since ca. 2001/02), but never completely understood the details. My motivation for looking at it more closely became more acute, after realizing (August 2012) that it is not completely trivial to complete the Green’s function strategy to the problem (cf. previous Section 19). It should be noted that Ahlfors’s argument does not employ exactly the Green’s function, but a close relative cousin with pole located on the boundary instead of the interior. As a matter of joking we refer to it as the *Red’s function*, and as far as we know there is no (standardized) terminology to refer to this object! Accordingly, Ahlfors rather constructs an half-plane map instead of a circle map. Of course both moneys are ultimately convertible, yet both geometrically and analytically this implies a little alteration of the viewpoint. One may then may get a bit confused about wondering on the optimal strategy.

Finally, remember that several workers in Japan or the US seem to have found necessary to rework Ahlfors’s proof in a more do-it-yourself fashion. Several other authors, having to cite Ahlfors work, often cross-cited those alternative proofs, like those produced by Heins 1950 [358] or Royden 1962 [716] (cf. e.g. Stout 1972 [805] or Gamelin 1973 [267, p.3], who both cite Royden for the piece of work originally due to Ahlfors). For a more complete list of “dissident” authors drifting from Ahlfors’s account as the optimal source compare Section 22.2. The latter tabulation is supposed to illustrate that I may not be isolated in having missed the full joy of complete satisfaction with Ahlfors’ output. Yet, personally we still would like to believe that Ahlfors account is superior in geometric quintessence to all of what followed, but only regret to have missed some crucial details. As far as we know, nobody ever raised a fatal objection against Ahlfors’ proof. (Personally, I only criticize a lack of details in the execution, plus a matter of organization⁷ and finally a lack of geomet-

⁷Of course this can hardly be taken seriously, in view of the messy nature of the present text!

ric visualization.) It may also be speculated that the argument published by Ahlfors 1950 [17] (and reproduced below) is not the way Ahlfors originally discovered the statement (as early as 1948, cf. Nehari 1950 [591]), which looks more intuitive when approached from the Green's function viewpoint, or just bare Riemann-Roch theorem (yet with dangerous probability of collision, cf. the remark in Gabard 2006 [255, p.949]). In the sequel we shall attempt to conciliate Ahlfors' analytic treatment with the geometric intuition behind it.

The goal is (as usual) to prove:

Theorem 20.1 (Ahlfors 1950 [17, p.124–126]) *Let \overline{W} be a compact bordered Riemann surface of genus p with $r \geq 1$ contours. Then there exists a circle map $f: \overline{W} \rightarrow \overline{\Delta}$ of degree $\leq r + 2p = g + 1$, where $g := (r - 1) + 2p$ can be either interpreted as the genus of the (Schottky) double or as the number of essential 1-cycles on F considered up to homologies (the so-called Betti number).*

20.1 The core of Ahlfors' argument

For the proof Ahlfors uses the concept of a Schottky differentials. Those are differentials on the bordered surface which extends to the Schottky double. The following subclass plays a special role:

$S_r =$ the space of analytic Schottky differentials which are real along $C = \partial\overline{W}$.

Lemma 20.2 *Given $g + 1$ distinct points z_j on the contour $C = \partial\overline{W}$ and corresponding reals $A_j \in \mathbb{R}$, it is possible to construct an analytic differential θ_0 which is real on⁸ C and whose only singularities are double poles at the z_j with singular parts:*

$$A_j \frac{dz}{(z - z_j)^2},$$

where the local variable z at z_j is chosen so as to map C onto the real-axis \mathbb{R} and inner points of W into the upper half-plane.

Further such a differential θ_0 is uniquely determined up to a differential $\theta \in S_r$, and for a proper choice of the latter we can make vanish the periods and half-periods of the imaginary-part $\Im\theta_0$.

Ahlfors prefers to construct instead of a circle map a upper half-plane mapping $F: \overline{W} \rightarrow \overline{H} = \{\Im z \geq 0\}$ which will ultimately arise through the equation $\theta_0 = dF$, after arranging exactness of θ_0 for a suitable location of the z_j and some $A_j \geq 0$.

Once this is achieved we may write $\theta_0 = dF$ for some analytic function F on \overline{W} . The latter is uniquely defined modulo an additive constant and can be chosen real on $C = \partial\overline{W}$, except at the z_j where $\Im F$ becomes positively infinite. The maximum principle ensures $\Im F > 0$ on the whole interior W , and therefore F is the desired half-plane mapping of degree $\leq r + 2p$.

This is the bare strategy of the argument, but it is time to adventure into the details.

A first ingredient is the fact (compare the second Corollary on p. 109):

Lemma 20.3 *The real vector space S_r (of Schottky differentials real along the border) has real dimension g .*

This looks rather plausible upon thinking with the Schottky double and explains the second (uniqueness) clause of the above lemma. Notice indeed that there is $(r - 1)$ half-periods corresponding to pathes on the bordered surface \overline{W} joining a fixed contour C_1 to the remaining ones C_2, \dots, C_r and $2p$ full periods arising by winding around the p handles.

To arrange exactness of θ_0 , Ahlfors employs the inner product (θ_0, θ) and a corresponding criterion for exactness in terms of orthogonality to the space

⁸Perhaps it would be more corrected to say "along" here. Compare in this respect Ahlfors, p. 108, the text just preceding footnote 3)

S_r (cf. Lemma 20.5 below). (The reader can skip the proof of the next two lemmas to move directly to the core of the argument which in our opinion is Lemma 20.6.)

Before attacking the proof we first recall the pertinent definitions. The *inner product* of two differentials on a Riemann surface is defined by:

$$(\omega_1, \omega_2) = \int_W \omega_1 \overline{\omega_2}^*,$$

where the star denotes the *conjugate differential* and the bar is the *complex conjugate* (compare Ahlfors, p.103). (Locally if $\omega = a dx + b dy$ then $\omega^* = -b dx + a dy$ and $\overline{\omega} = \bar{a} dx + \bar{b} dy$)

Further we need probably Stokes

$$\int_W d\omega = \int_C \omega,$$

which combined with Leibniz

$$d(f\omega) = df \cdot \omega + f d\omega.$$

gives the so-called integration by parts formula

$$\int_W (df \cdot \omega + f d\omega) \stackrel{\text{Leibniz}}{=} \int_W d(f\omega) \stackrel{\text{Stokes}}{=} \int_C f\omega,$$

which can be rewritten as

$$\int_W df \cdot \omega = \int_C f\omega - \int_W f d\omega,$$

which is hopefully the exact form used (subconsciously) in the sequel.

Further he requires an expression of this inner product in term of local variables. Namely the following:

Lemma 20.4 *If $\theta = \alpha dz$ near z_j , then we have the following formula for the inner product*

$$(\theta_0, \theta) = -\pi \sum_{j=1}^{g+1} A_j \alpha(z_j), \quad (12)$$

where θ_0 is the differential of Lemma 20.2.

Proof. As in the first lemma, once we have arranged vanishing of the period and the half-period of the imaginary part $\Im\theta_0$ we may write something like

$$\theta_0 - \overline{\theta_0} = i dG,$$

where G vanishes on C except at the z_j . Then brute-force computation gives

$$(\theta_0, \theta) \stackrel{?}{=} (\theta_0 - \overline{\theta_0}, \theta) = (i dG, \theta) = \dots = - \int_C G \bar{\theta}, \quad (13)$$

where the “dots” indicates steps left un-detailed by Ahlfors. Of course one should first apply the definition of the inner product and then use integration-by-part, as we just recalled, while noticing that the second term vanish involving the differential of an analytic function. [Alas, the writer had not the energy to complete the detailed computation.]

Now writing $\theta = \alpha dz$ near z_j , Ahlfors claims the following local expression for G

$$G \sim i A_j \left(\frac{1}{z - z_j} - \frac{1}{\bar{z} - z_j} \right),$$

whereupon he claims that the singularity at z_j contributes the amount $-\pi A_j \alpha(z_j)$ to the last integral of (13). The announced formula should follow easily. ■

Lemma 20.5 θ_0 is exact iff $(\theta_0, \theta) = 0$ for all $\theta \in S_r$.

Proof. A priori we could expect to save forces by proving only sufficiency (i.e. the implication $[\Leftarrow]$), but alas Ahlfors' proof requires the direct sense as well, plus the previous lemma involving the rather (unappealing) computation in local coordinate. Enough philosophy and lamentation, and let us follow along Ahlfors' exposition.

$[\Rightarrow]$ Write $\theta_0 = dF$. Then Ahlfors write cryptically

$$(\theta_0, \theta) \stackrel{?}{=} (\theta_0, \theta + \bar{\theta}) = \int_W dF \cdot \bar{\theta} = i \int_C F(\bar{\theta} - \theta) = \pi \sum_{j=1}^{g+1} A_j \alpha(z_j),$$

and comparison with Equation (12) shows that $(\theta_0, \theta) = 0$, as required.

$[\Leftarrow]$ Conversely, suppose $(\theta_0, \theta) = 0$ for all $\theta \in S_r$, and let φ be the analytic Schottky differential making $\theta_0 - \varphi$ exact. Then by the former implication⁹ $(\theta_0 - \varphi, \theta) = 0$ and so $(\varphi, \theta) = 0$ for all $\theta \in S_r$. This implies $\varphi = 0$, and we conclude that θ_0 is exact. ■

Combining both those lemmas, the exactness of θ_0 is reduced to the following (tricky) lemma, involving a mixture of convex geometry and Stokes formula (which Ahlfors calls the *fundamental formula* probably due its anticipation by Green or Gauss and others).

Lemma 20.6 *It is possible to choose the z_j and the $A_j \geq 0$ so that*

$$\sum_{j=1}^{g+1} A_j \alpha(z_j) = 0 \tag{14}$$

for all $\theta \in S_r$ locally expressed as $\theta = \alpha dz$.

Proof. Let $\theta_i \in S_r$ ($i = 1, \dots, g$) be a basis of the g -dimensional space S_r (cf. Lemma 20.3). Locally we can write $\theta_i = \alpha_i dz$ near z_j . Equation (14) can be satisfied with $A_j \geq 0$ iff the simplex with vertices

$$(\alpha_1(z_j), \dots, \alpha_g(z_j)) \in \mathbb{R}^g \quad \text{for } j = 1, \dots, g+1$$

contains the origin $0 \in \mathbb{R}^g$.

If this condition is not full-filled for any choice of the z_j , the convex-hull of the set of points

$$K := \{(\alpha_1(t), \dots, \alpha_g(t)) : \text{for } t \in C\}$$

would fail to contain 0. (One can think of this set as a sort of link (in the sense of knot theory) traced in \mathbb{R}^g with r components. However the latter is not perfectly canonical since the $\alpha_i(t)$ depends on the local chart.

Expressing some naive doubts. So here Ahlfors argument looks a bit fragile (or at least sketchy) as one probably requires to fix a finite system of holomorphic charts covering the full contour of the bordered surface). [We do not have a specific objection, yet it should be noted that the whole Ahlfors theory even that of the refined extremal problem depends on the non-emptiness of the class of bounded functions, hence upon the present argument! In principle even if there should be a global crash of Ahlfors's proof here, then the theorem should conserve its validity in view of several subsequent treatments hopefully logically more reliable, we cite:

- Kuramochi 1952 [487] (alas quite unreadable?),
- Mizumoto 1960 [564],
- Royden 1962 [716] (alas a bit functional-analytic, whereas the statement sentimentally belongs to pure geometric function theory), and maybe
- Gabard 2006 [255] (hopefully reliable, at least it first part not improving Ahlfors' $r + 2p$).

However it is likely that the set K can be defined according to the totality of possible $\alpha_i(t)$ arising through a fixed system of permissible charts covering the contour C .

⁹Here our argument shorten slightly the prose of Ahlfors, hopefully without loosing in precision?!

Now a (Euclidean) set of \mathbb{R}^g whose convex-hull misses the origin is contained in a closed half-space [maybe even an open half-space?]. Thus there exists scalars $a_1, \dots, a_g \in \mathbb{R}$ (not all zero) so that

$$\sum_{i=1}^g a_i \alpha_i(t) \geq 0 \quad \text{for all } t \in C.$$

(Geometrically, this is to be interpreted as the scalar product with the vector $(a_1, \dots, a_g) \in \mathbb{R}^g$ orthogonal to the hyperplane whose half contains the set K .) Hence the corresponding differential $\theta = \sum_{i=1}^g a_i \theta_i$ is ≥ 0 along C . [Maybe strict??] However this violates the fact that $\int_C \theta = 0$, as prompted by Stokes' formula

$$\int_{C=\partial\overline{W}} \theta = \int_{\overline{W}} d\theta,$$

and the fact that θ belongs to S_r , hence analytic, and thus closed, i.e. $d\theta = 0$.

■

20.2 Geometric interpretation as dipoles

[28.08.12] Let F be a membrane (=compact bordered Riemann surface), then Ahlfors constructed (cf. previous subsection) a half-plane map $F \rightarrow \overline{H} := \{\Im z \geq 0\}$ to the closed upper-half plane. We get a circle map after post-composing with the natural conformal map to the unit-disc $\overline{H} \rightarrow \overline{\Delta}$. Under such a map, the horizontal lines transform to a pencil of circles tangent to the boundary and vertical lines mutate to arcs of circles orthogonal to the boundary. (cf. Fig. 57a). One recognizes essentially the so-called Hawaiian earrings (cf. Fig. 57b).

Given a circle map, one can pull-back the isothermic (=right-angled) Hawaiian bi-foliation to obtain a graphical representation of the circle map.

Starting with a (doubly-connected) ring, one obtains Fig. 57c or Fig. 57d. Going to higher connectivity one gets for instance Fig. 57e. The Bieberbach-Grunsky theorem (or just Riemann-Roch, cf. e.g. Lemma 17.1) tell us that we can prescribe a point on each contour and there is a circle map taking all those points to the same image in the unit-circle $S^1 = \{|z| = 1\}$. Hence, we enjoy complete freedom in picturing the isothermic bi-foliation of circle maps, at least in the planar case. This situation is to be contrasted with the situation for the zeros, where some hidden symmetry requires to be fulfilled (compare e.g. Gabard 2006, where we have the condition $D \sim D^\sigma$ of linear equivalence of the divisor with its conjugate, and also Fedorov 1991 [233] who speaks of an opaque condition that must be satisfied to prescribe the zeros).

Of course, the contemplation (and manufacture) of such pictures raises more questions than clarifying the perception of Ahlfors' theorem. One can hope some guidance via physical intuition (if one feels comfortable with the mineral world) or appeal again to the metaphor about proliferation of bacteria in some nutritive medium. We do not repeat the long discourse we made already for Green (cf. Section 19, esp. Fig. 55) where one had radial expansions emanating from an inner point. Presently, the bacteria are rather located on the boundary, whereupon their local expansion is more of the Hawaiian type, or if you prefer look alike the Doppler effect at the critical speed of sound. The dipole of our title would occur upon considering the symmetric Schottky double of the membrane. This new Hawaiian/Doppler mode of expansion can again be explained via lacking nutritive resources caused by the boundary where the world stops.

On Fig. 57f, we have attempted to picture the pull-back of the Hawaiian foliation under a circle-map of degree $r + p = 1 + 1 = 2$ (for the value $r + p$ predicted by Gabard). This picture looks anomalous for the following reason. Letting grow the population, there is a first junction of the 2 populations right "under" the handle, then there is 2 self-junction at 2 points aside the handle. From now on the bacteria starts invading the handle from both "sides" and will actually merge on the core circle of it. This is problematic since ultimately the expansion should finish along the boundary contours (by definition of a

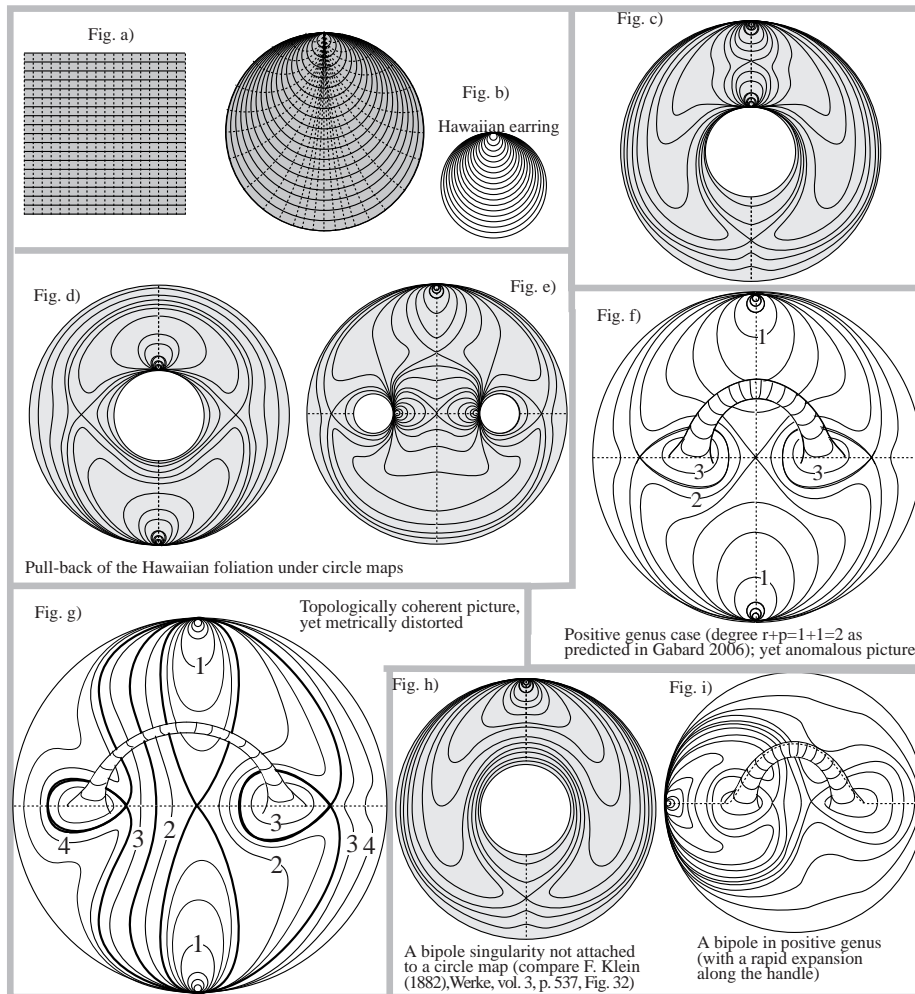

Figure 57: Some pictures of dipoles (another attempt to visualize Ahlfors circle maps)

circle-map). It is easy to manufacture a picture where no such anomaly occurs (cf. e.g. Fig. 57g which admittedly requires some little effort of concentration to contemplate its morphogenesis). Of course, similar pictures can be made by prescribing less boundary points than the degree of circle-maps predicted by Ahlfors $r + 2p$ or $r + p$, e.g. by choosing a single dipole, cf. Fig. 57h and Fig. 57i. However, those patterns cannot correspond to circle-maps due to obvious topological obstructions: first the degree of a circle-map must be $\geq r$ impeding Fig. 57h to be allied to a circle-map. As to Fig. 57i the degree would be one, implying the circle-map to be unramified and covering theory (of the simply-connected disc) implies the membrane F to be the disc, violating its genus 1 nature.

We stop this graphical discussion at this primitive stage, yet it is to be hoped that a deeper study of such figures could lead to some theoretical results complementing the understanding of the Ahlfors maps. Perhaps such (dipole) isothermic drawings are of some relevance to Gromov's filling conjecture, as we already suggested in the case of Green's function (Section 19.9).

[29.08.12] In fact there is another more convincing obstruction impeding Fig. 57f to represent a circle-map. This consists in identifying the counter-images of the growing Hawaiian circles past the critical levels while checking if they contribute to the correct numerical multiplicity permissible with the degree of the branched covering. To be concrete we enumerate a series of typical smooth levels on Fig. 57f. The first one denoted 1 consists of 2 little circles. Past the first critical level, we see the curve 2 with 1 component. After the next critical level, we pick a curve 3, which has 3 components. This is too much for our

mapping to be of degree 2. This proves that Fig. 57f do not correspond to a circle-map.

In contrast repeating the same counting exercise for Fig. 57g, no such excess occurs. The level 1 has 2 components, level 2 (chosen after the first critical level) has one component, level 3 has 2 components and finally level 4 has 1 component. Thus the picture looks topologically coherent, but it is evident that it is far from metrically realist. Naively speaking we were forced to distort the propagation so has to have a virtually planar mode of depiction for the levels.

20.3 Trying to recover Ahlfors from the Red's function

[29.08.12] Let F denote a finite (=compact) bordered Riemann surface of genus p and with r contours. From the previous section, it seems evident that there is some canonical function akin to the Green's function yet with pole pushed to the boundary (dipole singularity when doubled). Call them perhaps the *Red's function* as an *ad hoc* acronym honoring writers like Riemann, Schwarz, Klein, Koebe, Ahlfors, etc. Such a Red's function denoted $R(z, t) = R_t(z)$ with (di)pole at $t \in \partial F$ (a boundary-point) is defined by the property of being harmonic, null along ∂F save at t where it becomes positively infinite according to a specific local singularity (maybe like $\text{Re}(1/z^2)$). [18.10.12] As a more intrinsic definition one can define R_t as the unique positive harmonic function vanishing continuously along $\partial F - \{t\}$. The function then looks unique up to scalar multiple. Note however that Heins (in e.g. Heins 1985 [363, p. 241, right after Thm 3.1]) defines the function u_ζ our R_t by adding the requirement of minimality (in the sense of Martin 1941 [529]). A positive function u is minimal if whenever there is a smaller function $0 < v < u$, v is a constant multiple of u .

The sudden explosion of R_t at just one boundary point looks at first almost paradoxical, but see again our previous Fig. 57b-h-i) for a depiction of their levels and one can of course imagine such a function just as a "borderline" degeneration of the usual Green's function. Now one can attempt to construct a half-plane-map (HP-map, for short), by considering a superposition $R(z) := \sum_{i=1}^d R(z, t_i)$ of such Red's functions $R(z, t_i)$ for several points t_i on the border. The formula

$$\varphi := R + iR^*,$$

where R^* is the conjugate function would then define the HP-map provided the conjugate potential is single-valued in other word that the conjugate differential of R , $(dR)^*$ is period free. Since F has $(r - 1) + 2p =: g$ essential cycles (homologically independent), a parameter count suggests that if $d = g + 1$ there is enough freedom to annihilate all the g periods of dR^* .

Maybe this approach (which presumably differs not very much from Ahlfors') has some technical advantage over the Green's technique (presented in Section 19). First it seems that the dipole singularity has some linear character contrasting with the arithmetical rigidity of the logarithmic singularity. Thus it is permissible to form a more general linear combination

$$R(z) := \sum_{i=1}^d \lambda_i R(z, t_i),$$

with some reals λ_i which must however be ≥ 0 . Hence killing the periods essentially reduces to linear algebra. Another advantage over the Green's approach stems from the fact that in the interior we meet no singularity thus the period mapping looks less dubious.

As usual we write down the period mapping by integrating the 1-form dR^* along the g many 1-cycles $\gamma_1, \dots, \gamma_g$ and obtain for each fixed $t_1, \dots, t_{g+1} \in \partial F$ a linear map $\mathbb{R}^{g+1} \rightarrow \mathbb{R}^g$. Thus there is some non-zero vector in the kernel, and the corresponding (λ_i) would solve the problem, provided one is able to check that they can be chosen ≥ 0 . This is non-trivial and a priori it is not evident (and nobody ever asserted) that this can be done for any choice of the $(g + 1)$ -tuple t_i .

So it is just here that the difficulty starts, and that some idea is required to complete the proof.

[04.09.12] Due to a lack of creativity/energy, I was blocked here for a couple of days. So let me make a list of writers who seem to have grasped the geometric quintessence of Ahlfors' argument:

- Gamelin-Voichick 1968 [261, p. 926]: “According to [1, § 4.2](=Ahlfors 1950 [17]), there exist $r + 1$ ($r = g$ in our notation) points w_1, \dots, w_{r+1} on bR such that if B_j is the period vector of the singular function T_j corresponding to a unit point mass at w_j , then B_1, \dots, B_{r+1} are the vertices of a simplex in \mathbb{R}^r which contains 0 as an interior point.” [10.09.12]

- Fisher 1973 [240, p. 1187/88]: “By a theorem of Ahlfors [A1; §4.2] there is a set of $r + 1$ points p_j in Γ such that if v_j is the period vector of a unit mass at p_j , then v_0, \dots, v_r form the vertices of a simplex in \mathbb{R}^r which contains the origin as an interior point.” [this looks alike verbatim copy of the previous source, yet reinforce confidence in the viewpoint]

[07.09.12] In fact some little hope to complete the argument is raised by borrowing ideas of convex geometry used by Ahlfors, yet in our context which is perhaps not so reliable (albeit it seems to match with the Gamelin-Voichick twist of Ahlfors). Alas, we failed to recover Ahlfors statement, but we see obvious room for improving upon Ahlfors by using essentially his method of proof augmented by some further geometric tricks. Ideally one would like to recover the bound predicted in Gabard 2006 [255] by using an argument very close to Ahlfors'. Let us now be more concrete.

Again we fix some d points t_1, \dots, t_d on the boundary ∂F , with at least one point on each contour C_i (forming the boundary ∂F). For any point $t \in \partial F$ the function $R_t(z) := R(z, t)$ is uniquely defined once a chart around t is specified (otherwise it is unique only up to a positive scaling factor). Let us assume R_t fixed once for all with a continuous dependence over the parameter t . (Alas the writer has no clear-cut justification of this possibility. [09.09.12] Maybe use a boundary uniformizer for an annular tubular neighborhood of each contour, cf. e.g. Hasumi 1966 [339, p. 241], also Gamelin-Voichick 1968 [261, p. 926]. [18.10.12] Of course since R_t is unique up to scalar multiple, we are somehow choosing a section of a ray-bundle and even if after winding once around an oval of ∂F the R_t should not return to its initial position R_{t_0} , it seems easy to apply a sort of “closing lemma” so that R_t comes back to the original choice.)

We now introduce $\Pi(t)$ the period of $(dR_t)^*$ along the fixed representatives $\gamma_1, \dots, \gamma_g$ of the first homology, that is,

$$\Pi(t) = \left(\int_{\gamma_1} (dR_t)^*, \dots, \int_{\gamma_g} (dR_t)^* \right) \in \mathbb{R}^g.$$

We seek R of the form $R = \sum_{i=1}^d \lambda_i R_{t_i}$ with $\lambda_i > 0$ such that the conjugate differential $(dR)^*$ is period-free. Period-freeness amounts to say that *the simplex of \mathbb{R}^g spanned by the $\Pi(t_1), \dots, \Pi(t_d)$ contains the origin in its interior*¹⁰. Then positive masses λ_i can be assigned to the $\Pi(t_i)$ so that the origin occurs as barycenter of this masses distribution.

The italicized condition is equivalent to saying that the convex-hull of the set $X := \Pi(\partial F)$ contains the origin (say then that the set X is balanced). Balancedness paraphrases also into the condition that the set is not contained in a half-space delimited by a hyperplane through the origin.

Ahlfors derives his result from the following simple lemma applied to $X = \Pi(\partial F)$.

Lemma 20.7 *Let X be a subset of some number space \mathbb{R}^g . Any point in the convex-hull of X is the barycenter (=convex combination involving positive coefficients) of at most $g + 1$ points of X .*

Of course the lemma is sharp in general: consider $X \subset \mathbb{R}^2$ a set of 3 points in general position (not collinear) then any point chosen in the interior of the

¹⁰In the combinatorial sense, by opposition to the topological sense.

convex-hull of X (a simplex) requires all 3 points in a barycentric combination. However if X is a more continuous shape like a topological circle in \mathbb{R}^2 it is clear that 2 points situated on X will suffice (cf. Fig. 58a). Indeed, imagine first that X is a Jordan curve and that the point lies in its interior. Any line through the point intercepts the Jordan curve in at least 2 points which can be used for a convex combination of the given point. If the point is not in the interior, one can meet an “U-shaped” Jordan curve where the point is situated near the top of the “U” (Fig. 58b), yet still expressible as the barycenter of 2 points on the top of the “U”. This already raises some hope upon improving Ahlfors, and optimistically a careful inspection could recover the $r + p$ bound of Gabard 2006 [255].

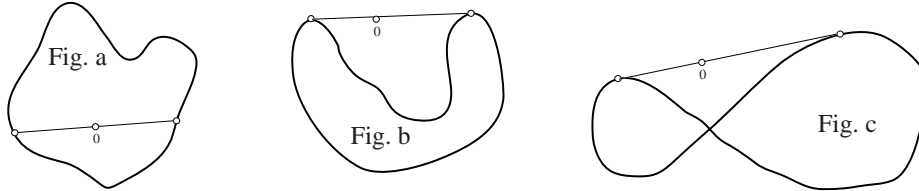

Figure 58: Improving upon Ahlfors by using Ahlfors

Let us summarize the situation. The lemma shows is that if the convex-hull of $\Pi(\partial F)$ contains the origin 0, then one can certainly find $g + 1$ points t_i (eventually fewer) and corresponding $\lambda_i > 0$ such that $R = \sum \lambda_i R_{t_i}$ has a period-free conjugate differential. This implies the existence of a half-plane map (via $f = R + iR^*$) of degree $\leq g + 1 = r + 2p$, recovering therefore Ahlfors’ result of 1950.

Thus the problem splits in two parts:

- Step (1): explain why the convex-hull of $\Pi(\partial F)$ contains the origin 0 (implying Ahlfors’ $r + 2p$ bound); (Ahlfors is able to do this, yet hopefully the ambient context of his argument can be slightly simplified to our present setting which is closer say to Heins’ accounts in 1950 [358] or 1985 [363])
- Step (2): try to lower Ahlfors degree $r + 2p$ by taking advantage of the fact that $X = \Pi(\partial F)$ is not an arbitrary set but the continuous image of r circles; (ideally try to recover the $r + p$ upper bound predicted in Gabard 2006 [255], or at least partial improvements of Ahlfors bound $r + 2p$ for low values of the invariants (r, p)).

As to the first point (1), we notice that if it is violated then the set $\Pi(\partial F)$ is contained in a half-space of \mathbb{R}^g . Thus there is a non-zero vector $a = (a_1, \dots, a_g) \in \mathbb{R}^g$ such that the scalar product $(a, \Pi(t)) > 0$ for all $t \in \partial F$. This means

$$\sum_{i=1}^g a_i \int_{\gamma_i} (dR_i)^* > 0 \text{ for all } t \in \partial F.$$

Alas, the writer failed to find a reason why this should be a contradiction. (In Ahlfors’s presentation Stokes’ theorem plays a crucial role.)

Even if the present geometric strategy (cooked by the writer via slow assimilation of the very classical strategy of annihilating periods) should be impossible to complete, nothing forbids to switch again to the original treatment of Ahlfors, and apply our Step (2), whose tangibility relies on Fig. 58. The essential point is that ultimately the geometric setting is invariably the one and same problem of convex geometry, whether we start from Ahlfors “analytic” approach or from our more geometric reformulation via the Red’s functions.

Let us be more explicit. We have a map $\Pi: \partial F =: C \rightarrow \mathbb{R}^g$. (“ C ” for contours, like in Ahlfors notation.) In Ahlfors’ paper this occurs as the map $C \ni t \mapsto (\alpha_1(t), \dots, \alpha_g(t))$ cf. p.125 of his article. (From the algebro-geometric viewpoint this must probably be the vectorial lift of the so-called *canonical map* $\varphi: C \rightarrow \mathbb{P}^{g-1}$ (usually ascribed to Noether or Klein) allied to the canonical series $|K|$ living over the curve C , obtained by doubling the bordered Riemann surface.)

We try to address the second issue (2). The setting is a map $\Pi: C \rightarrow \mathbb{R}^g$ whose image is balanced (i.e. the convex-hull of the image contains the origin, or equivalently the set $\Pi(\partial F)$ is not contained in any open half-space of \mathbb{R}^g delimited by a hyperplane through the origin). The whole problem is then reduced to the following geometric question.

Problem 20.8 *Given two integers $r \geq 1$ and $p \geq 0$. Let $g := (r - 1) + 2p$, and suppose given in the corresponding Euclidean space \mathbb{R}^g a collection of r (possibly singular) circles C_1, \dots, C_r . It is assumed that the union of all these circles is balanced. Find the minimum cardinality of a group of d points with at least one point on each C_i spanning a simplex containing the origin.*

The previous lemma solves the problem for degree $d = g + 1 = r + 2p$ (recovering Ahlfors's result). To do better we start from such a group and try to move the vertices, while taking care that the simplex still contains 0. From the $r + 2p$ points, we imagine r many as essentially fixed and the other coupled in p many pairs. The initial simplex is top-dimensional matching the dimension g of the ambient number-space \mathbb{R}^g . Moving vertices, it looks reasonable that we may coalesce two points of the g -simplex to get a $(g - 1)$ -simplex still containing 0. This presupposes both coalescing points being located on the same circuit C_i (try to argue with the pigeon hole principle). After p such collisions (one for each pair) we reach the degree $r + p$ predicted by Gabard 2006 [255].

Alas this "piano mover" argument is not easy to believe, nor to prove. Perhaps a less naive variant involving an adequate trick (most probably of a topological nature akin say to the Borsuk-Ulam proof of the ham-sandwich theorem) could recover the $r + p$ bound. Less optimistically, it may happen that the above problem is not always soluble with $d \leq r + p$, but only for circuits C_i arising from bordered Riemann surfaces via the period map recipe.

At any rate, we see the prominent role of convex geometry in the question of the least possible degree of the Ahlfors function. In principle there is a canonically defined set $\Pi(C) \subset \mathbb{R}^g$ (we shall call the *Ahlfors figure*) whose spanning simplices going through the origin affords a complete understanding (in theory at least) of the minimal degree of a circle map concretizing the given bordered surface F .

[11.09.12] Perhaps one can solve the above problem (20.8) for $d = r + p$ by an inductive procedure. Let us sketch an attempt that fails (reasonably close to the goal). Recall that given two integers (r, p) and a balanced configuration of r circles C_i in \mathbb{R}^g , where $g := (r - 1) + 2p$. We would like to show that the origin is the barycenter of at most $r + p$ points with at least one on each C_i . Of course the assertion holds true when $p = 0$, because we know (by the lemma) that $d \leq g + 1 = r + 2p = r$ and on the other hand we have the trivial lower-bound $r \leq d$ imposed by the fact that each circle supports at least one point. It follows that $d = r = r + p$, and the claim is vindicated.

Thus one can try an induction reducing to the "planar case" $p = 0$. This can be done in several ways via the moves $(r, p) \mapsto (r, p - 1)$, or $(r, p) \mapsto (r + 1, p - 1)$ or finally $(r, p) \mapsto (r + 2, p - 1)$. The latter of which has the advantage that the new value of g , denoted g' stays invariant. Now given a geometric configuration of type (r, p) in the number-space \mathbb{R}^g we construct one of type $(r + 2, p - 1)$ in the same \mathbb{R}^g , maybe naively just by duplicating two of the circles (i.e., assigning them a multiplicity). This new configuration is still balanced, so by induction hypothesis the origin is expressible as the barycenter of $r' + p' = (r + 2) + (p - 1) = r + p + 1$ points located on the C_i . Alas, this exceeds by one unit the desired $r + p$.

[18.10.12] Low-dimensional examples may help to give some weak evidence toward solving Problem 20.8 with Gabard's bound $d = r + p$. Let us discuss this aspect. If we take $(r, p) = (1, 1)$, then $g = 2$. So geometrically we have one circuit in the plane \mathbb{R}^2 . In this situation our Fig. 58 prompts solubility of the problem with $d = 2$. Note the agreement with Gabard's bound $r + p$. This proves the (modest) theorem that *a bordered surface with one contour and of genus one always admits a circle map of degree 2*, whereas Ahlfors only

predicts degree $r + 2p = 1 + 2 = 3$. Another evidence comes from the well-known hyperellipticity of genus 2 curves. Indeed the double of such a membrane having genus 2, it is hyperelliptic and can therefore be visualized in 3-space as something like Fig. 59a. Doing a rotation of angle π we find the required circle map of degree 2 (look at the Figs. 59b and 59c).

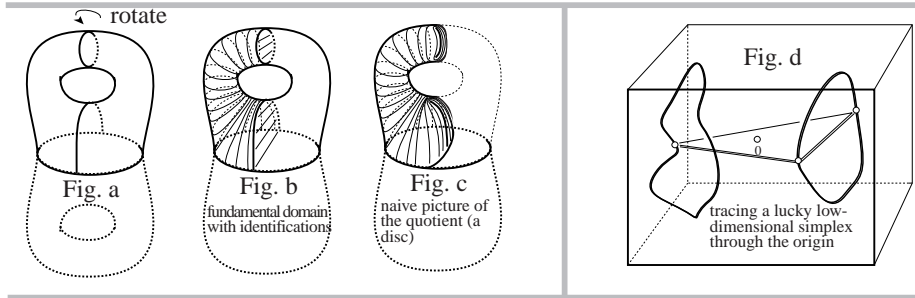

Figure 59: Low-dimensional improvements of Ahlfors's convexity argument

Let us next examine the case $(r, p) = (2, 1)$, then $g = (r - 1) + 2p = 1 + 2 = 3$. So we have 2 circuits in space \mathbb{R}^3 (like in knot or link theory). Since the set of circuits is balanced, we have something like Fig. 59d (assuming no knotting for simplicity). Balancing amounts picturesquely to say that if you dispose of a 180 degrees angular vision (like any respectable homo sapiens) you will never be able from the origin to contemplate the full link. Paraphrased differently, whatever the direction you choose to focus your vision the link will always move in your back. It seems plausible that, instead of the 4 points prompted by Ahlfors' top-dimensional 3-simplex, 3 points actually suffices to span a 2-simplex passing through the origin (see again Fig. 59d). Justifying this intuition could again corroborate the $r + p$ bound (at least for low invariants). Of course the genus (of the double) being now $g = 3$ there is no hyperelliptic reduction, yet appealing to the canonical map $C_g \rightarrow \mathbb{P}^{g-1}$ (an embedding precisely when the curve is not hyperelliptic) our curve is concretized as a plane quartic (the canonical divisor K having degree $2g - 2$). Some basic knowledge of Klein's theory then prompts that our orthosymmetric real quartic with $r = 2$ must consist of two nested ovals. Projecting from a real point on the inner oval gives a totally real morphism of degree $4 - 1 = 3$, in accordance again with the $r + p$ bound.

All these little experiments raise the hope that Ahlfors original approach suitably sharpened by a geometric lemma about balanced collections of circuits in \mathbb{R}^g should enable some improvements, and eventually confirm the prediction of the $r + p$ bound. However we confess that the required positive solution to Problem 20.8 with $d = r + p$ looks difficult to obtain and perhaps only true for special circuits arising through period maps. It is quite hard to connect Ahlfors method with the one in Gabard 2006 [255] in which Abel's map was exploited more systematically. Since both maps, Π an Abel, involve periods, a natural guess is that *Ahlfors' figure*, that is the set $\Pi(\partial F) \subset \mathbb{R}^g$, is closely related to the Abel map or at least the so-called (Noether-Klein) canonical map $C \rightarrow \mathbb{P}^{g-1}$ which is just the Gauss map of the Abel map: each tangent to the curve seen in its Jacobian is reported to the origin via translation in the Jacobi torus. If so interpretable, it is perhaps no surprise that Ahlfors approach is cumbersome because one is working in the Plato cavern where the essence (embedded-ness) of things is lost.

Still, the Ahlfors figure is perhaps useful for other questions. For instance if we take a top-dimensional spanning simplex with $g + 1 = r + 2p$ vertices containing 0 in its interior, it is clear that we may perturb slightly the vertices keeping the origin inside the simplex. This shows a sort of topological stability of Ahlfors maps having degrees $r + 2p$. (This phenomenon is not new, compare Černe-Forstnerič 2002 [166].) The same stability cannot be expected with the more economical $r + p$ bound, for a slight perturbation of our hypothetical simplex will generally miss the origin. Ahlfors' figure also shows existence of circle maps for each degree $\geq r + 2p$. For those of degrees $> r + 2p$ there is a

menagerie of convex combinations expressing 0 and accordingly plenty of circle maps having the same fibre above a boundary point. Such results look not easily accessed via Gabard’s method (in Gabard 2006 [255]).

Trying to make the last “menagerie” point more accurate could lead to interesting result. For simplicity imagine \mathbb{R}^g as the plane \mathbb{R}^2 and in it a 2-simplex spanning the origin. If we have more than $(g + 1)$ points, say $g + 2 = 4$ then we may interpret the convex-hull of those 4 points as the shadow (projection) of a 3-simplex living in \mathbb{R}^3 . Hence above the origin there is a segment in this higher 3-simplex each elements of which is a convex sum of the 4 vertices. Hence we get ∞^1 circle maps having the same 4 points as prescribed value. This requires of course to be better presented but should be straightforward application of Ahlfors method.

20.4 Strip mappings (Nehari, Kuramochi)

[31.08.12] As we saw instead of a circle map, Ahlfors 1950 [17] prefers to construct a half-plane map. Ultimately this amounts to the same except that the disc instead of being decorated by the polar coordinates it is by the Hawaiian dipole (Fig. 57a). A third option is to envisage (as Nehari and Kuramochi 1952 [487]) a strip mapping to the strip $S := \{z : -1 \leq \Re(z) \leq 1\}$. When rectangular coordinate on the strip are transplanted to the disc we obtain a dipole looking like a mitosis. This yields yet another isothermic system on the disc.

To synthesize, the disc can be decorated by 3 types of isothermic coordinates (systems):

(1) the monopole attached to an inner point of the disc, which when the pole is the center is just the foliation by concentric circles plus the orthogonal rays. We may from here drag the pole away from the center to get other isothermic systems best interpreted as the geodesic expansion w.r.t. to the hyperbolic metric on the disc. Upon letting degenerate the pole to the boundary circle we get:

(2) the dipole depicted on Fig. 57a and finally upon disintegrating this source of multiplicity 2 into two separate elements of multiplicity one we get:

(3) a genuine dipole which ultimately can be the mitosis about antipodal points of the circle.

In principle to each of these geometric decoration of the disc corresponds an existence-proof of the Ahlfors function differing so-to-speak just in the “cosmetic details”.

Finally, each isothermic system suggests an angle of attack to Gromov’s filling conjecture. Eventually, it seems plausible that the totality of those isothermic systems could be exploited collectively upon using an averaging process (somehow reminiscent to Löwner-Pu’s trick).

21 Hurwitz type proof of Ahlfors maps?

[21.10.12] This section wonders about an elementary existence-proof of circle maps via a continuity method reinforcing some naive moduli count. As we noted (in Section 18.6) the disaster with bordered surfaces is that their gonality is not prompted by a naive moduli count, and thus the project looks from the scratch a bit hazardous. However it is not impossible that we missed something crucial.

The general philosophy would be not to fix a surface and try hard to find a map, but rather to look at all possible maps and lift the complex structure of the disc while hoping that if the degree is large enough there are sufficiently many free parameters to paint the full moduli space. Hence any Riemann surface would be expressible as a branched cover of the disc of some controlled degree. (Natanzon suggested to me this strategy during an oral conversation at the Rennes conference 2001, and I came again to this idea by reading Natanzon et al. 2001 [586].)

The basic idea may be formalized as follows. We fix a topological type (r, p) encoding the number of contours and the genus. We introduce the (Hurwitz) space

$$H_{r,p}^d := \text{set of all circle maps from surfaces of type } (r, p) \text{ having degree } \leq d.$$

An element of this natural set (hence a space!) is a branched cover of which we may keep in mind only the “total space”. This gives a map

$$\tau: H_{r,p}^d \rightarrow M_{r,p},$$

to the moduli space of bordered surfaces of type (r, p) . We want to show that this mapping is surjective for d sufficiently large (but controlled à la Ahlfors). First, we know (since Klein essentially) that $M_{r,p}$ is connected. Thus it would be enough to find a suitable d so that the τ -image is closed, open and non-empty.

As (r, p) is fixed we may omit it from the notation. Of course $H^d := H_{r,p}^d$ is empty when $d < r$. The example of rotational surfaces (cf. Fig. 49) shows that H^d is non-void for $d = r$ or $d = r + 1$ when r is even resp. odd.

It seems also trivial (since we have defined H^d by the condition $\deg(f) \leq d$) that the image $\tau(H^d)$ is closed for any d . Intuitively a map can degenerate to a map of lower degree, but will never degenerate to one of higher topological complexity. Observationally, this is well seen on the example of the Gürtelkurve (plane quartic with two nested ovals): when projected from a point in the interior of the oval we get a total map of degree 4, which can degenerate to one of degree 3 if the center of projection is specialized toward the inner oval. However, if we take a sequence of maps of degree 3 given by such projections the limit will be a similar projection (the oval being closed) and we never reach a map of degree 4. Of course an abstract explanation requires be given (perhaps just by compactness of H^d).

The hard part is to show that τ is open for some large d .

Naively one could hope to do this via Brouwer’s invariance of the domain requiring something like $\tau = \tau_d$ being étale for a suitable d .

Another idea is perhaps to factorize τ by taking the fibre of the circle map $f: F \rightarrow \Delta$ (Δ =closed disc, here!) over the origin 0 of the disc to get a surface marked by a group of d points. The nice feature is that $(F, f^{-1}(0))$ permits one to recover uniquely (up to rotation) the map f (cf. Lemma 5.2 about unilateral divisors in Gabard 2006 [255]). Taking instead the fibre over the real unit $1 \in \Delta$ gives a surface marked by a group of d distinct along the boundary. Taking simultaneously the fibre over 0 and 1 gives a surface marked by d points on both the interior and the border.

So we have 3 natural spaces of marked surfaces living above the moduli space $M = M_{r,p}$, namely I^d (interior marking); B^d (bordered marking); and M^d (mixed marking). Forgetting the markings gives varied arrows descending to M . The map τ factorizes through all these marked moduli space.

An idea could be to show that the lift of τ (which is an embedding especially when we factor through the mixed marking) is sufficiently horizontal w.r.t. to the fiber bundle projection afforded by the forgetful map. Alas, this is not very evident and should of course hold for some special value of d .

Another route to explore is to make a Lüroth-Clebsch/Hurwitz type analysis of trying to understand from ramification and monodromy how one reconstruct the Riemann surface.

22 Synoptic tabulations

This is an attempt to gather information scattered through the literature. The first synoptic project compiles a list of nomenclatures. A second tabulation reflects how Ahlfors work (existence of circle maps) has been appreciated by subsequent workers of a slightly dissident nature in the sense that they cite conjointly other sources.

22.1 Nomenclature project

This section tries to get sharp lower bounds on the basic nomenclature of our topic. As Poincaré tried to convince Felix Klein “Name ist Schall und Rauch” (cf. e.g. Klein 1923 [443, p. 611]), but it is somehow pleasant to investigate the historical background of some jargons to use them hopefully appropriately.

- (1825?) **Conformal mapping=konforme Abbildung**, maybe first in Gauss 1825 [286].

- (1865) **Riemann surface**, maybe first coined by C. Neumann 1865 [599], followed by Lüroth 1871 [520], Clebsch 1872 [178], Klein 1874–76 [432], [432], Clifford 1877 [179] and then too many to record.

- **Berandete (Riemannsche) Flächen, Compact bordered Riemann surfaces, finite Riemann surface, membranes**. The first appellation appears often in Klein 1882 [434] (reprint in Klein 1923 [443, p. 569, §23]) and others. The second appellation is coined and popularized in Ahlfors-Sario’s 1960 book [22], whereas the third competing name is used in Schiffer-Spencer’s book of 1954 [753]. The term membrane also occurs (in this context) by Klein in his lecture notes.

- (1907?) **Uniformization** probably a coinage of Poincaré. In 1883, just the word “fonction uniforme” appears and the word “uniformization” as a such, came in vogue ca. two decades latter in Poincaré 1907 [653] and Koebe 1907 [450].

- (1908) **Kreismormierungsprinzip** coined and proved (in fairly general special cases: finite connectivity and symmetric under complex conjugation) by Koebe in 1908 [452].

- (1912) **Schwarz’s lemma**. The coinage as a such appears first in Carathéodory 1912 [138], but already published in the modern fashion in 1907 by the same writer [134], acknowledging the argument of E. Schmidt.

- (1916) **Extremal problems=Extremalprobleme** used in function theory by Bieberbach 1916 [95].

- (ca. 1914) **Circle mapping=Kreisabbildung**. This is used (at least) since Bieberbach 1914 [92, p. 100], Koebe 1915 [464], Bergman[n] 1922 [75, p. 238], Bochner 1922 [107, p. 184], with the English translation appearing first in Garabedian-Schiffer 1950 [279].

- (ca. 1950) **Ahlfors function, Ahlfors mapping, Ahlfors map** coined by the Russians [at least according to Ahlfors’ Commentary in his Coll. Papers [25, p. 438]] (probably Golusin, Havinson, etc.). However, the longer appellation “Ahlfors’ extremal function” occurs already in Nehari’s survey 1950 [592, p. 357], and “Ahlfors mapping” alone occurs in the article Nehari 1950 [591, p. 267]. So the terminology is probably a Russian coinage, but Nehari’s enthusiastic reception of Ahlfors’ work seems to have also been a contributing factor in the West.

The following concept is a priori foreign to our survey, albeit it would be interesting to see if the methods of Grötzsch-Teichmüller are of some relevance to the Ahlfors mapping of 1950. This is another mathematical question, but here we content ourselves with a point of terminology:

- (1928/1935) **Quasiconformal mappings=quasikonforme Abbildungen**. This nomenclature is usually ascribed to Ahlfors 1935, who however could not remember precisely from where he borrowed the jargon, according to Kühnau 1997 [486, p. 133]), which is worth quoting:

Quote 22.1 (Kühnau 1997) Der Name Grötzsch ist wohl bei vielen vor allem mit der Theorie der quasikonformen Abbildungen verbunden, die er ab 1928 begründete. Die Bezeichnung “Quasikonforme Abbildungen” wurde allerdings erst später von L. V. Ahlfors eingeführt. (Freilich sagte mir Ahlfors Februar 1992 in Oberwolfach, daß er diese Bezeichnung bei jemandem “gestohlen” habe, er wisse nur nicht mehr bei wem.)

Maybe it contributes to the question to rememeber that the jargon “*quasikonform*” appears already in 1914, und zwar bei Carathéodory 1914 [141, §16](=page 294 in the pagination of the Ges. Math. Schriften, Bd. 3).

22.2 Dissidence from Ahlfors

[31.08.12] Section 20 attempted to present Ahlfors’s proof in full details, but failed to digest the details. This deplorable issue motivated us to tabulate a list of “dissident” authors, who instead of quoting the original source Ahlfors 1950 [17] adhered to subsequent treatments. Two accounts emerge with high rating, namely:

- Heins 1950 [358]
- Royden 1962 [716]

Of course, our “dissident” writers (quoting beside Ahlfors some derived product) never (as far as I know) criticizes directly the 1950 work of Ahlfors. At least there dissidence may suggest that themselves were not completely happy with (resp. convinced by) the original text finding more convenient another implementation. Albeit nobody ever expressed frontal objections against Ahlfors 1950 [17], it is not to be excluded (yet of very low probability ca. 10^{-14}) that somebody once detected some little bug, explaining perhaps the numerous initiatives to reprove Ahlfors’ result from different viewpoints. (We mention again the articles by Mizumoto 1960 [564] and Kuramochi 1952 [487] (undigest?), and refers for a extensive tabulation of such initiatives to the circled item of Fig. 3).

Here is a sample of dissident authors (grouped according to their preferred source) with relevant extracts in “...”:

VOTING FOR HEINS 1950:

- Stout 1972 [805, p.345]: “... a theorem of Ahlfors [2](=Ahlfors 1950 [17]) shows that $\mathcal{H}(\mathcal{R})$ contains many inner functions. (See also the elegant [sic!] construction of Heins [15](=Heins 1950 [358]) as well as the earlier paper of Bieberbach [3](=Bieberbach 1925 [97]) which deals with the case of planar domains.)”

- Khavinson 1984 [425, p.377]: “The following theorem is a classical result of Bieberbach and Grunsky (see [6](=Golusin 1952/57 [296]), [8](=Grunsky 1978 [322])). For a different approach due to L. Ahlfors, see [1](=Ahlfors 1950 [17]). Our proof, although discovered independently, is almost the same as that due to M. Heins in [11](=preprint=now published as Heins 1985 [363]) or H. Grunsky in [8](=Grunsky 1978 [322]). THEOREM 3. *Let ζ_1, \dots, ζ_n be arbitrary fixed points on $\gamma_1, \dots, \gamma_n$ respectively. Then, for each j , $\phi(z)$ is the unique function giving a conformal mapping of G onto an n -sheeted right half-plane such that $\phi(\zeta_j) = \infty$, for all j , $\phi(z_0) = 1$.*

★ admittedly, this Khavinson’ extract in not hundred percent pertinent to our present purpose inasmuch as the Bieberbach-Grunsky theorem is confined to the planar case.

VOTING FOR ROYDEN 1962:

- Stout 1965 [802]: “In order to establish our result, we shall need to make use of a result of Ahlfors [1](=Ahlfors 1950 [17]). (For an alternative proof, one may consult Royden [15](=Royden 1962 [716]).)

Theorem 3.1 *There exists a function P holomorphic on a neighborhood of \bar{R} which maps R onto the open unit disc in an one-to-one manner for some n and which satisfies $|P| = 1$ on ∂R .*”

★ Of course the above “one-to-one” is a typo to be read as “ n -to-one”.

- Alling 1966 [36, p.346]: “Finally, I am indebted to Professor Royden for his excellent paper, *The boundary values of analytic and harmonic functions*, [24](=Royden 1962 [716]), which not only gave a new proof of the existence of the Ahlfors’ map, but also gave generalizations of the classical boundary value theorems over the disc. ...”

- Stout 1966/67 [803, p.366]: “Let R be a finite open Riemann surface whose boundary Γ consists of N analytic, pairwise disjoint, simple closed curves. Let η be an analytic mapping from R onto U , the open unit disc which is holomorphic on a neighborhood of \bar{R} and which is of modulus one on Γ . That such functions exists was first established by Ahlfors [1](=Ahlfors 1950 [17]); another proof of their existence is in the paper [12](=Royden 1962 [716]).”

- Stout 1967 [804]: “It is convenient to make use of an *Ahlfors map* for R , i.e., a function continuous on \overline{R} and holomorphic in R which is constantly of modulus one on Γ . The existence of such function was established by Ahlfors in [1](=Ahlfors 1950 [17]); an alternative proof of their existence is in [4](=Royden 1962 [716]).”

- O’Neill-Wermer 1968 [618]: “Let W be a region on some Riemann surface whose boundary is the union of a finite number of analytic simple closed curves and with W having compact closure. In “Open Riemann surfaces and extremal problems on compact subregions”, (1950), L. Ahlfors considers the following extremal problem:

Problem I. Let a, b be points of W . among the functions F analytic on W with $|F(z)| \leq 1$ on W and $F(a) = 0$, it is required to find the one which makes $|F(b)|$ a maximum.

He shows that this problem has a unique solution¹¹ f which maps W in an n -to-1 fashion¹² onto the unit disk, for some n . His method of proof depends on a certain associated extremal problem introduced by P. R. Garabedian in his thesis. (See Garabedian 1949 [276]). Another proof is given by H. Royden, “The boundary values of analytic and harmonic functions,” *Math. Z.* 78 (1962), 1–24.”

- Stanton 1971 [797, p. 293]: “Our argument rests on the following theorem of Ahlfors [1](=1950). THEOREM. *There is a function f which is analytic on $W \cup \Gamma$ and which maps [the interior] W onto U and Γ onto T .* This theorem is also proved in Royden [7](=1962). A function f of the kind described in this theorem is called an *Ahlfors mapping*.”

★ Upon recalling, that Stanton is a Royden student this may eventually be counted as a self-voting.

- Hejhal 1972 [365, p. 119]: “Suppose first of all that W is the interior of a compact bordered surface \overline{W} . L. Ahlfors [2](=1950) and H. Royden [24](=1962) have studied the present linear extremal problem on such W at least for the case $\chi \equiv \text{constant}$ and $\mathfrak{L}[f] = f(b)$ with $b \in W$”

- Gamelin 1973 [267, p. 3]: “. . . the paper of H. L. Royden deals with finite bordered Riemann surfaces.”

- Gamelin 1973 [266, p. 1105]: “For dual extremal problems on Riemann surfaces, see [2](=Ahlfors 1950 [17]) and [36](=Royden 1962 [716]).”

- Fisher 1973 [240, p. 1183]: “A similar problem [. . .] has been investigated by L. Ahlfors [A1], H. Royden [R], and others. In that case, the class of competing function is convex, the solution is unique, is analytic across the boundary Γ , and has modulus one on Γ .” And further on page 1187: “Let F be the solution to the Ahlfors-Royden extremal problem described in the introduction. . . .”

- Lund 1974 [519, p. 495]: “Let U be the open unit disk in \mathbb{C} . We call F an unimodular function if F is analytic in a neighborhood of \overline{R} and maps \overline{R} onto \overline{U} so that F is n -to-one if we count the multiplicity of F where dF vanishes. If T is the unit circle, then F maps Γ onto T . The existence of such a function was first proved by Ahlfors [1](=1950). Later, Royden [4](=1962) gave another proof of this result.”

- Kirsch 2005 [427]: “Ahlfors generalized Garabedian’s result to regions on Riemann surfaces [2](=Ahlfors 1950 [17]); see Royden’s paper [159](=Royden 1962 [716]) for another treatment as well as further references to the literature.”

OTHER VOTES:

- Alpay-Vinnikov 2000 [41, p. 240]: “It has been shown by Ahlfors [4](=Ahlfors 1950 [17]) that such a function [=ramified n -sheeted covering of the unit disk] always exists, and it may be chosen to have the minimal possible degree $g + 1$; see also [5](=Alling-Greenleaf 1971 [39]), [19](=Fay 1973 [232]), and [21](=Fedorov 1991 [233]).”

Apart from the fact that the writer (Gabard) does not adhere with Alpay-Vinnikov’s claim about $g + 1$ being the minimal possible degree for such a

¹¹Presumably, the authors omit the rotational ambiguity.

¹²Of course Ahlfors’ statement is somewhat stronger giving $r \leq n \leq r + 2p$, where r is the number of contours and p the genus.

mapping (g is the genus of the double, cf. op. cit. p. 230), the three proposed references are in our opinion not perfectly adequate as substitute to Ahlfors 1950 [17]. Alling-Greenleaf [39, p. 16, Thm 1.3.6] only states Ahlfors' result yet without reproving it, whereas both Fay and Fedorov recover the result in the planar case only.

22.3 Acknowledgements

The author wishes to thank the following long list of geometers (in chronological order of their interaction with the writer in connection to the present text)

- Felice Ronga (ca. 1997/98 for his explanation of Brusotti's theorem),
- Claude Weber, Michel Kervaire (for their explanations on how to classify Klein's symmetric surfaces by looking at the quotient bordered surface)
- Frédéric Bihan for pleasant discussions about real algebraic geometry,
- Lee Rudolph (ca. 1999 for explaining to us what is the natural topological model for a real elliptic curve with only one "oval", namely just a torus acted upon by factor permutation fixing thereby the diagonal circle),
- Alexis Marin, Viatcheslav Kharlamov, Oleg Viro, Jean-Jacques Risler, Thierry Vust, Michel Kervaire, Pierre de la Harpe, John Steinig (for their comments and corrections improving the shape of the article Gabard 2000 [253])
- Ragahavan Narasimhan, Jacek Bochnack (ca. 1999 for *not* having been in touch with Ahlfors' result of 1950 [17] enabling me some free gestation about thinking on the problem)
- Manfred Knebusch for his kind interest in the modest work Gabard 2000 [253],
- Johannes Huisman for his constant interest (2001–04–06), and his care about correcting bugs in both my Thesis and the article Gabard 2006 [255],
- Sergei Finashin for an exciting discussion in Rennes 2001,
- Jean-Claude Hausmann (ca. 2000/01) for telling me about the standard surjectivity criterion via the Brouwer degree, which was decisive to complete Gabard 2006 [255],
- Antonio Costa, for his fascinating talks in Geneva,
- Bujalance for his surely over-enthusiastic Zentralblatt review of my article (Gabard 2006 [255]),
- Fraser-Schoen, whose brilliant work revived my interest in the theory of the Ahlfors' mapping (ca. the 13 March 2011) at a stage were I was mostly sidetracked by "non-metric manifolds".
- Stefan Orevkov, Oleg Viro (2011) for their talks and pleasant discussions,
- Marc Coppens (2011–12) for e-mails, and his work on the separating gonality adumbrating sharper insights on the degree of the Ahlfors function (or rather the more general allied circle maps). His turning-point result appeals to a better conciliation of the analytic theory of Ahlfors with the algebro-geometric viewpoint.
- (2011/12) Hugo Parlier, Peter Buser, Alexandre Girouard, Gerhard Wanner und Martin Gander are acknowledged for their recent e-mail exchanges.

23 Bibliographic comments

The writer does not pretend that the following bibliography is complete (nor that he absorbed all those fantastic contributions in full details). More extensive bibliographies (overlapping ours), but covering more material include those of:

- Ahlfors-Sario 1960 [22] (ca. 40 pages times 25 items per pages=1000 entries covering such topics as the Dirichlet problem, extremal problems, the type problem, the allied classification theory, etc.);
- Grunsky 1978 [322] (=562 refs, including 48 Books).

Most entries of our bibliography are followed by some comment explaining briefly the connection to our primary topic of the Ahlfors map. The following symbolism is used:

♣ serves to point out a special connection to Ahlfors 1950 (especially alternative proofs).

♠ gives other comments (attempting to summarize the paper contents or to explicit the connection in which we cite it).

★ marks sources, I could not as yet procure a copy.

• the stickers/sigles AS60, G78 are assigned when the source has already been cited in Ahlfors-Sario 1960 [22] resp. Grunsky 1978 [322].

• A50 designates those references citing the paper Ahlfors 1950 [17] (there represents circa 106 articles on “Google”), and occasionally A47 those quoting Ahlfors 1947 [16].

♡*n* is something like the indicator of the US rating agency (to be read “liked by *n*”). It indicates the cardinal number *n* of citations of the paper as measured by “Google Scholar”. The latter machine often misses cross-citations, especially those in old books, or old articles with references given in footnotes format. Many sources cited in Grunsky’s book (1978 [322]) are never cited electronically. Accordingly, those rating numbers only supply a statistical idea of the literature ramifications lying beyond a given entry. Also low-citation articles are sometimes the most polished product ripe for museum entrance. Forelli 1979 [246] is typical: self-contained, elegant and polished proof of Ahlfors result, yet only rated by 3.

Our bibliography is somewhat conservative with comparatively few modern references. Our excuse is two-fold: modern expressionism is sometimes harder to grasp, and recent references are usually well detected through computer search.

(Papers are listed in alphabetical, and then chronological order, regardless of shared co-authorship.)

The primary focus is on the Ahlfors map and the weaker (but more general) circle maps. As a such the topic overflow slightly over the territory of real algebraic geometry. Ahlfors-Sario’s book AS60 address Riemann surfaces, whereas Grunsky’s book G78 focuses to the case of planar domains. Hence both bibliographies AS60, G78 are quite complementary, and ours is essentially a fusion of both, but we gradually included more and more recent contribution. Still additional references are welcome.

For conformal maps, it is helpful when browsing the vast literature to keep in mind the basic question: *what result through which method?*

Results. Objects traditionally range along increasing order of generality through: simply-connected regions, multiply-connected ones and finally Riemann surfaces. We often add a humble compactness proviso, as the passage to open objects is traditionally achieved through the exhaustion trick (going back at least to Poincaré 1883 [649], and see also Koebe 1907 [450]), and active in recent time (e.g. Garabedian-Schiffer 1950 [279].)

As to the mappings, they may all be interpreted in some way or another as ramification of RMT (Riemann’s mapping to a circle=disc). We distinguish primarily:

• CM=circle maps (usually not univalent, but multi-sheeted disc with branch, or winding points=Windungspunkte)

• KNP=Kreisnormierung(sprinzip) (univalent map to a circular domain)

• SM=slit mappings for various types of them (parallel, circular, radial, logarithmic spiral, etc.). Those are all allied to certain natural foliation of the sphere, and some extreme generality in this respect is achieved in Schramm’s Thesis where any foliation is permitted as support for the slits.

Methods. They may be classified in two broad classes quantitative vs. qualitative (each having some branchings):

★ (Quantitative) variational methods, including:

• DP=Dirichlet principle (or more broadly speaking, potential theory=PT, centering around such concepts as the Green’s function, harmonic measures (i.e. harmonic function with special null/one boundary prescription of the various contour), etc. Of course, there is a standard yoga between Dirichlet and Green, so all this is essentially one and the same method.

- IM=Iterative methods (originators: Koebe and Carathéodory), and by extension this may proliferate up to including the circle packings.
- EP=extremal problems (e.g. the one of maximizing the derivative amongst the class of function bounded-by-one) and leads to the Ahlfors map.
- BK=Bergman kernel (or Szegő kernel), here the fundamental ideas rest upon Hilbert's space methods, and the idea of orthogonal system. Initially, the method is also inspired by Ritz, and Bieberbach extremal problem (1914 [92]) for the area swept out by the function. Since the middle 1940's, there were found several conformal identities among so-called domain functions (Green's, Neumann's, etc.) and the kernel functions so that virtually this is now highly connected to DP≈PT. Also the Ahlfors map is expressible in term of the Bergman kernel (cf. e.g., Nehari 1950 [591]) so that this heading is strongly connected to EP.
- PP=Plateau problem style methods (for RMT, this starts with the observation of Douglas 1931 [209]). This strongly allied to DP, albeit some distinction is useful to keep in mind just for cataloguing purposes.

★ (Qualitative) topological methods:

- the *continuity method*, as old as Schläfli, (as Koebe notices somewhere) is involved in the accessory parameters of Schwarz-Christoffel, in Klein-Poincaré's uniformization through automorphic functions, Brouwer (invariance of the domain), Koebe, etc., e.g. Golusin 1952/57 [296])
- Brouwer topological degree and the allied surjectivity criterion (cf. e.g., Mizumoto 1960 [564], Gabard 2006 [255]). Here the idea is that there is some topological stability of the embedding of a curve into its Jacobian via the Abel mapping in the sense that its homological feature are unsensitive to variation of the complex (analytic) structure (moduli), and this enables one to draw universal statement by purely topological considerations.

Finally we have attempted to manufacture a genealogy map showing the affiliation between the authors. The picture turned out to be so large that TeX prefers reject it at the very end of the file.

[15.10.12] When I reached 884 references, I unfortunatel met the so-called "TeX capacity exceeded, sorry." obstruction (cf. Knuth's "The TeX Book", p.300 for more details). Thus I had to deactivate some references which are not used for cross-citation, albeit they clearly belong to our topic. [16.10.12] This problem was ultimately solved by my advisor Daniel Coray, to whom I express my deepest gratitude for enlarging the TeX capacity of my compiler.

References

- [1] H. Abe, *On some analytic functions in an annulus*, Kodai Math. Sem. Rep. 10 (1958), 38–45. [♠ quoted in Minda 1979 [554] in connection with the theta function expression of the Ahlfors function of an annulus] ♡??
- [2] N.H. Abel, *Mémoire sur une propriété générale d'une classe très étendue de fonctions transcendentes*, présenté à l'Académie des Sciences à Paris le 30 octobre 1826; published (only) in: *Mémoires présentés par divers savants*, t. VII, Paris, 1841. Also in Œuvres, t. I, 145–211. [♠] ♡??
- [3] N.H. Abel, *Remarques sur quelques propriétés générales d'une certaine sorte de fonctions transcendentes*, Crelle J. Reine Angew. Math. 3 (1928). [♠] ♡??
- [4] N.H. Abel, *Démonstration d'une propriété générale d'une certaine classe de fonctions transcendentes*, Crelle J. Reine Angew. Math. 4 (1929), 201–202. [♠] ♡??
- [5] M.B. Abrahamse, *Toeplitz operators in multiply connected domains*, Amer. J. Math. 96 (1974), 261–297. [♠ extend to finite Riemann surfaces? try Alpay-Vinnikov 2000 [41]] ♡41
- [6] M.B. Abrahamse, R. G. Douglas, *A class of subnormal operators related to multiply connected domains*, Adv. Math. 19 (1976), 106–148. [♠ for extension to finite Riemann surfaces? try Alpay-Vinnikov 2000 [41], Yakubovich 2006 [893]] ♡??
- [7] M.B. Abrahamse, J. J. Bastian, *Bundle shifts and Ahlfors functions*, Proc. Amer. Math. Soc. 72 (1978), 95–96. A47 [♠ the Ahlfors function of a domain R with n

- contours is applied to the calculation of a bundle shift (that is, a pure subnormal operator with spectrum contained in the closure of R and normal spectrum contained in the boundary of R) ♡2
- [8] M. B. Abrahamse, *The Pick interpolation theorem for finitely connected domains*, Michigan J. Math. 26 (1979), 195–203. [♠ extend to finite Riemann surfaces? try Heins 1975 [361], Jenkins-Suita 1979 [393], both works subsuming in principle Ahlfors 1950 [17]] ♡??
- [9] R. Accola, *The bilinear relation on open Riemann surfaces*, Trans. Amer. Math. Soc. ?? (1960), ??–??. A50 [♠] ♡31
- [10] J. Agler, J. Harland, B. J. Raphael, *Classical function theory, operator dilation theory, and machine computation on multiply-connected domains*, Mem. Amer. Math. Soc. 191 (2008), 159 pp. G78 [♠ cite Grunsky 1978 [322] and gives via the Grunsky-(Ahlfors) extremal function an interpretation of the Herglotz integral representation via the Kreĭn-Milman theorem ♠ [06.10.12] contains also a nice description of circle maps (in the form of half-plane maps, which seems to be directly inspired from Heins’ treatment (1985 [363]) who probably offers an alternative derivation of Ahlfors’ bound $r + 2p$) ♠ “In three chapters the authors first cover generalizations of the Herglotz representation theorem, von Neumann’s inequality and the Sz.-Nagy dilation theorem to multiply connected domains. They describe the fist through third Herglotz representation and provide an . . .”] ♡9
- [11] D. Aharonov, H. S. Shapiro, *Domains on which analytic functions satisfy quadrature identities*, J. Anal. Math. 30 (1976), 39–73. G78 [♠ includes the result that the Ahlfors map of a quadrature domain is algebraic, see also papers by Gustafsson, Bell, etc.] ♡126
- [12] P. R. Ahern, D. Sarason, *On some hypo-Dirichlet algebras of analytic functions*, Amer. J. Math. 89 (1967), 932–941. [♠] ♡??
- [13] P. R. Ahern, D. Sarason, *The H^p spaces of a class of function algebras*, Acta Math. 117 (1967), 123–163. [♠ “This paper is a study of a class of uniform algebras and of the associated Hardy spaces of generalized analytic functions. It is a natural continuation of a number of similar studies which have appeared in recent years; see Bochner [7], Helson and Lowdenslager [15], ...”] ♡53
- [14] P. R. Ahern, *On the geometry of the unit ball in the space of real annihilating measures*, Pacific J. Math. 28 (1969), 1–7. A50 [♠ Ahlfors 1950 [17] is cited on p. 4, yet not exactly for the result we have in mind, but see also the related paper Nash 1974 [582] where the fascinating study of the geometry of the convex body of representing measures is continued ♠ [13.10.12] it could be fascinating to penetrate the geometry of this body in relation to the “link” (collection of circles in the “same” Euclidean space \mathbb{R}^g , where g is the genus of the double), as it occurs in Ahlfors original proof 1950 [17]). Understanding this is probably the key to a sharper understanding of circle maps, in particular of their lowest possible degrees] ♡5
- [15] L. V. Ahlfors, H. Grunsky, *Über die Blochsche Konstante*, Math. Z. 42 (1937), 671–673. [♠ not directly relevant to this text, except for the hardness of some extremal problems. Compare the front cover of Grunsky’s Coll. Papers for a depiction of the hyperbolic tessellation allied to the conjectured extremal function.] ♡47?
- [16] L. V. Ahlfors, *Bounded analytic functions*, Duke Math. J. 14 (1947), 1–11. AS60, G78 [♣ the planar case of Ahlfors 1950 [17], cite Grunsky 1940–42 [317, 318] as an independent forerunner ♠ albeit less general than the next item (Ahlfors 1950 [17], which includes the case of positive genus) this article is more quoted that its successor essentially due to the intense activity centering around analytic capacity and the Painlevé null-sets implying a super vertical series of workers like Vitushkin, Melnikov, Garnett, Calderón 1977 [131], David, etc. culminating to Tolsa’s 2002/03 [834] resolution of the Painlevé problem ♠ as a detail matter, it may be recalled that the present article contains a minor logical gap fixed in Ahlfors 1950 [17] (cf. the later source, especially footnote p. 123) and also the “Commentary” in the Collected papers Ahlfors 1982 [25, p. 438]: “When writing the paper I overlooked a minor difficulty in the proof. This was corrected in [36](=Ahlfors 1950 [17]).” ♠ compare also the comment in the German edition of Golusin 1952/57 [296, p. 415, footnote 2]: “Der bisherige Beweisgang erlaubt es nicht, zu schließen, daß keine der $n - 1$ Nullstellen eine mehrfache ist. Diese Lücke des AHLFORSschen Beweises wurde von P. R. Garabedian in seiner Dissertation (=1949 [276]), beseitigt., Anm. d. Red. d. deutschen Ausgabe.”] ♡180

- [17] L. V. Ahlfors, *Open Riemann surfaces and extremal problems on compact subregions*, Comment. Math. Helv. 24 (1950), 100–134. AS60, G78 [♣ the central reference of the present article ♣ contains the first existence-proof of a circle map on a general compact bordered Riemann surface ♣ in fact both a qualitative existence result as well as a quantitative extremal problem are presented] AS60, G78 ♥106
- [18] L. V. Ahlfors, A. Beurling, *Conformal invariants and function-theoretic null sets*, Acta Math. 83 (1950), 101–129. AS60, G78 ♥high 300?
- [19] L. V. Ahlfors, *Development of the theory of conformal mapping and Riemann surfaces through a century*. In: *Contributions to the Theory of Riemann Surfaces. Centennial Celebration of Riemann's Dissertation*, Annals of Math. Studies 30, 3–13, Princeton 1953; or *Collected Papers*, Vol. 1, 1929–1955, Birkhäuser, 1982. [♠ a colorful historical survey of Riemann, Schwarz, Poincaré, Koebe, Nevanlinna, Grötzsch, Grunsky and Teichmüller] ♥??
- [20] L. V. Ahlfors, *Variational methods in function theory*. Lectures at Harvard University, 1953 transcribed by E. C. Schlesinger. [♠ cited in Read 1958 [676]. Does this contain another (more pedestrian) treatment of Ahlfors 1950 [17]?]★★ ♥??
- [21] L. V. Ahlfors, *Extremalprobleme in der Funktionentheorie*, Ann. Acad. Sci. Fenn., A.I., 249/1 (1958), 9 pp. [♠ survey like, but pleasant philosophy] ♥3?
- [22] L. V. Ahlfors, L. Sario, *Riemann Surfaces*, Princeton Univ. Press, 1960. ♥600?
- [23] L. V. Ahlfors, *Classical and contemporary analysis*, SIAM Review 3 (1961), 1–9. ♥??
- [24] L. V. Ahlfors, *Complex Analysis*, McGraw-Hill Book Co. (2nd ed.), 1966. [♠ p.243–253 proof of the PSM (and other radial/circular avatars) via the Dirichlet principle] ♥2500?
- [25] L. V. Ahlfors, *Collected Papers, Vol. 1, 1929–1955*, Birkhäuser, 1982. [♠ p. 438 is worth quoting in extenso: “The point of departure in [30](=Ahlfors 1947 [16]) is Painlevé’s problem: Given a compact set $E \subset \mathbb{C}$, when does there exist a nonconstant bounded analytic function $f(z)$ on $\mathbb{C} \setminus E$? I was really interested in the function with the smallest upper bound of $|f(z)|$ when normalized so that $f(z) \sim 1/z$ at ∞ . This smallest maximum is now called the *analytic capacity*¹³ of E , and the Russians¹⁴ used to refer to the extremal function, if it exists¹⁵, as the “Ahlfors function”, an unexpected and probably unearned distinction. In this form Painlevé’s problem is closely related to the precise form of Schwarz’s lemma¹⁶ for an arbitrary region, and that is what the paper is actually about. To be specific: if $\Omega \subset \mathbb{C}$ is a region and if $|f(z)| \leq 1$ in Ω while $f(z_0) = 0$ for a given $z_0 \in \Omega$, exactly how large can $|f'(z_0)|$ be?—The difficulty lies in the fact that while $u = \log |f(z)|$ is a harmonic function with a logarithmic pole at z_0 , the single-valuedness of f translates into diophantine conditions on the conjugate harmonic function v . Quite obviously this makes the problem much harder than if only the absolute value $|f(z)|$ were required to be single-valued.—In my paper I restrict myself to a region Ω of finite connectivity n , and my aim is to describe the extremal function $f(z)$. I show that $|f(z)| = 1$ on the boundary and that f has exactly $n - 1$ zeros¹⁷. In other words, f maps Ω on an $n - 1$ times covered disk¹⁸. In addition there are conditions on the location of the zeros¹⁹. When writing the paper

¹³According to Havinson 2003/04 [347], this terminology is due to Erokhin 1958: “In accordance with V. D. Erokhin’s proposal (1958), the quantity $\gamma(F)$ has been called the *analytic capacity* or the *Ahlfors capacity* since that time.”

¹⁴Who exactly? candidates: Golusin, Havinson, Havin, Vitushkin, etc., but see also Nehari (alias Willi Weisbach) as early as 1950. Indeed, “Ahlfors’ extremal function” occurs already in Nehari’s survey 1950 [592, p. 357], and “Ahlfors mapping” alone occurs in Nehari 1950 [591, p. 267]. This probably beats any Russian contribution, for one of the first text is Golusin 1952/57 [296], where actually the term “Ahlfors function” is not employed. However Havinson torrential list of publication on the topic starts as early as 1949 [341].

¹⁵Existence is ensured under the mild condition that the domain supports nonconstant bounded analytic functions.

¹⁶A coinage of Carathéodory, cf. Carathéodory 1912 [138].

¹⁷This seems to be a misprint, and should be “ n zeros” ([27.09.12]). Further it is tacitly assumed that the domain is bounded by Jordan curve, for pointlike punctures are removable singularities hence do not affect the Ahlfors function. To be concrete making $(n - 1)$ punctures in the unit disc the domain reaches connectivity n but its Ahlfors function is still the identity as if there were no punctures.

¹⁸Again “ n times covered disk” sounds more correct.

¹⁹This is indeed one of the fascinating difficulty also discussed in A. Mori 1951 [570] and Fedorov 1991 [233], who coins the lovely prose of a “rather opaque condition must be satisfied”.

I overlooked a minor difficulty in the proof. This was corrected in [36](=Ahlfors 1950 [17]).—The purpose of [36](=Ahlfors 1950 [17]) was to study open Riemann surfaces by solving extremal problems on compact subregions and passing to the limit as the subregions expand. The paper emphasizes the use of harmonic and analytic differentials in the language of differential forms. It is closely related to [35](=Ahlfors-Beurling 1950 [18]), but differs in two respects: (1) It deals with Riemann surfaces rather than plane regions and (2) the differentials play a greater role than the functions.—I regard [36] as one of my major papers. It was partly inspired by R. Nevanlinna, who together with P. J. Myrberg (1954²⁰) had initiated the classification theory of open Riemann surfaces, and partly by M. Schiffer (1943 [747]) and S. Bergman (1950 [84]), with whose work I had become acquainted shortly after the war. The paper also paved the way for my book on Riemann surfaces with L. Sario (1960 [22]), but it is probably more readable because of its more restricted contents.—I would also like to acknowledge that when writing this paper I made important use of an observation of P. Garabedian to the effect that the relevant extremal problems occur in pairs connected by a sort of duality. This is of course a classical phenomenon²¹, but in the present connections it was sometimes not obvious how to formulate the dual problem.” ♡??

- [26] L. V. Ahlfors, *The Joy of function theory*, ca. 1984. [♠ p. 443: “It has been customary to write about the joy of everything, from the joy of cooking to the joy of sex, so why not the joy of function theory?” ♠ p. 444: “I remember vividly how he [=Lindelöf] encouraged me to read the collected papers of Schwarz and also of Cantor, but he warned me not to become a logician, for which I am still grateful. Riemann was considered too difficult, and Lindelöf never quite approved of the Lebesgue integral.” ♠ p. 445: “It is impossible to change an analytic function at or near a single point without changing it everywhere. This crystallized structure is a thing of great beauty, and it plays a great role in much of nineteenth-century mathematics, such as elliptic functions, modular functions, etc. On the other hand, it was also an obstacle, perhaps most strongly felt in what somewhat contemptuously was known as “Abschätzungsmathematik”. Consciously or subconsciously there was a need to embed function theory in a more flexible medium. For instance, Perron used the larger class of subharmonic functions to study harmonic functions, and it had also been recognized, especially by Nevanlinna and Carleman, that harmonic functions are more malleable than analytic functions, and therefore a more useful tool.”] ♡??
- [27] Ju. E. Alenicyn, *On some estimates for functions regular in a region of finite connectivity*, (Russ.) Mat. Sb. N. S. 49 (1959), 181–190. G78 ★ ♡??
- [28] Ju. E. Alenicyn, *An extension of the principle of subordination to multiply connected regions*, (Russ.) Trudy Mat. Inst. Steklov 60 (1961), 5–21; Amer. Math. Soc. Transl. (2) 43, 281–297. G78 ★ ♡??
- [29] Ju. E. Alenicyn, *Conformal mappings of a multiply connected domain onto many-sheeted canonical surfaces*, (Russ.) Izv. Akad. Nauk SSSR, Ser. Mat. 28 (1964), 607–644. G78 ♡??
- [30] Ju. E. Alenicyn, *An estimate of the derivative in certain classes of function, analytic in a multiply connected domain*, Zap. Nauch. Sem. Leningrad Otdel. Mat. Inst. Steklov 24 (1972), 6–15; English transl. (1974), 565–571. G78 [♠ Ahlfors extremal problem is recalled and extended to a more general setting, where instead of considering functions bounded-by-one in modulus, there is some continuous positive function $\lambda(z)$ defined on the contour which acts as the upper-bound over the permissible modulus via $\limsup_{z \rightarrow z_0 \in \partial D} |f(z)| \leq \lambda(z_0)$] ♡??
- [31] Ju. E. Alenicyn, *Inequalities for generalized areas for multivalent conformal mappings of domains with circular cuts*, Translated from Matematicheskie Zametki 29 (1981) 387–395; [♠ extension of the result of Vo Dang Thao 1976 [856] and Gaier 1977 [259] (which the latter ascribes to Grötzsch 1931 [313]) ♠ this is close to (but not exactly) the desideratum that Bieberbach’s minimum problem (1914 [92]) yields another interpretation of the Ahlfors circle map when extended to multiply-connected domains ♠ p. 202 a cross-reference to Nehari 1952 [594] is given, but this does not really answer our question whether the minimal map (of least area) is a circle map (it is just observed that in higher-connectivity it is *not* schlicht)] ♡??

²⁰Here there is maybe a wrong cross-reference and Myrberg 1933 [577] was rather understood?

²¹Can one be more explicit? Hahn-Banach like in Read 1958 [676] or Royden 1962 [716] or just something more in the realm of classical analysis.

- [32] Ju. E. Alenicyn, *Least area of the image of a multiconnected domain of p -sheeted conformal mappings*, Translated from *Matematicheskie Zametki* 30 (1981) 807–812; [♠ extension of the result of Vo Dang Thao 1976 [856] and Gaier 1977 [259] (which Gaier 1978 [260] ascribes to Grötzsch 1931) ♠ this is close to (but not exactly) the desideratum that Bieberbach’s minimum problem (1914 [92]) yields another interpretation of the Ahlfors circle map when extended to multiply-connected domains] ♥??
- [33] J. W. Alexander, *Functions which map the interior of the unit circle upon simple regions*, *Ann. of Math. (2)* 17 (1915), 12–22. [♣] ♥??
- [34] N.L. Alling, *A proof of the corona conjecture for finite open Riemann surfaces*, *Bull. Amer. Math. Soc.* 70 (1964), 110–112. [♣ applies Ahlfors 1950 [17] to the corona as a lifting procedure of the disc-case established in Carleson 1962 [154] ♠ for an alternative proof of the same result avoiding the Ahlfors map but using uniformization instead, cf. Forelli 1966 [244]] ♥18
- [35] N.L. Alling, *Extensions of meromorphic function rings over non-compact Riemann surfaces. I*, *Math. Z.* 89 (1965), 273–299. [♣ idem as Alling 1964 [34] with full details] ♥17
- [36] N.L. Alling, *Extensions of meromorphic function rings over non-compact Riemann surfaces. II*, *Math. Z.* 93 (1966), 345–394. A50 [♣ p.346: “Finally, I am indebted to Professor Royden for his excellent paper, *The boundary values of analytic and harmonic functions*, [24](=Royden 1962 [716]), which not only gave a new proof of the existence of the Ahlfors’ map, but also gave generalizations of the classical boundary value theorems over the disc. . .” ♠ p.345: “As in Alling 1965, theorems are frequently proved for \overline{X} [=a finite open Riemann surface] by lifting the corresponding classical result for the disc, using the Ahlfors map in conjunction with various algebraic facts. For example, Fatou’s theorem and Nevanlinna’s theorem (about functions of bounded characteristics) are easily proved in this way.”] ♥7
- [37] N.L. Alling, in *MathReviews*, Review of Stout 1965, Bounded holomorphic functions on finite Riemann surfaces. [♣ quoting an extract of the text: “It is now clear that a great many of the results for the disc U , which can be found, for example in K. Hoffman’s book (=1962 [381]), also hold for R [=the interior of a compact bordered surface]. The choice of technique to extend such results depends then on the ease of proof, the intuition generated by the setting, and the predisposition of the investigator. Uniformization and the algebraic approach [based upon Royden’s idea (1958=[715]) of a lifting procedure along an Ahlfors map] seem to have an advantage over annular analysis in that they treat the whole space and the whole ring simultaneously. Still, special advantages in using uniformization and in using the algebraic approach persist. For example, the theory of the closed ideals in the standard algebra on R , $\mathcal{A}(R)$, and the theory of invariant subspaces have been worked out by M. Voichick (=1964 [857]), using uniformization, but has not been achieved yet using the algebraic approach. (See also Voichick 1966 [859], and a paper by Hasumi now in preprint [=Hasumi 1966 [339]], all of which deal with the invariant subspace problem.)” ♠ [13.10.12] for an upgrade giving full answer to Alling’s desideratum of an Ahlfors-map proof of the closed ideals, see Stanton 1971 [797] ♠ the review is concluded with the following: “Finally, concerning the corona problem, as far as the reviewer knows, no one has given a new proof of Carleson’s theorem or re-proved it on R ; everyone, to generalize it to R , has merely lifted the result to R [Or “descended” in the case of the uniformizing approach.]. A substantially simpler and more lucid proof of Carleson’s theorem still remains the most challenging question in this subject.” ♠ possible upgrades the new proofs à la Hörmander/Wolff (cf. e.g. Gamelin 1980 [272]), and also the localization of the corona done by Gamelin 1970 [264] should be satisfactory answers. Yet our impression is that eventually any sharper understanding of the geometry of Ahlfors map (e.g. Gabard’s improved bound (2006 [255]) on the degree of the Ahlfors circle maps) could implies modest quantitative refinements in the corona with bounds (cf. Hara-Nakai 1985 [333] and Oh 2008 [616]]) ♥??
- [38] N.L. Alling, N. Greenleaf, *Klein surfaces and real algebraic function fields*, *Bull. Amer. Math. Soc.* 75 (1969), 869–872. [♣ the first paper (to the best of my knowledge) which makes explicit the link between Ahlfors 1950 [17] and the much older Kleinian theory (1876–82) of orthosymmetric (=dividing) real algebraic curves, see Klein 1876 [432] and Klein 1882 [434]] ♥14

- [39] N.L. Alling, N. Greenleaf, *Foundations of the Theory of Klein Surfaces*, Lecture Notes in Math. 219, Springer-Verlag, Berlin, 1971. [♣ repeat the same Klein-Ahlfors connection (cf. comments to the previous entry Alling-Greenleaf 1969 [38]), and develop a systematic theory of Klein surfaces, a new jargon derived from Berzolari 1906 [87] ♣ Ahlfors' theorem (compare p.16, Theorem 1.3.6) is stated as follows: "Theorem 1.3.6 (Ahlfors [A₁]). Let \mathfrak{X} be [a] compact, connected, orientable Klein surface with non-void boundary. There exists $\underline{f} \in E(\mathfrak{X})$ such that $\partial X = \Gamma_{\underline{f}}$. ♠ if I do not mistake Ahlfors' result is only stated but not proved in the text (perhaps quite contrary to the hope borne out by the cross-citation in Alpay-Vinnikov 2000 [41]) ♠ personal reminiscence [03.09.12]: I can remind clearly that I knew this famous Alling-Greenleaf text quite early (ca. Spring 1999), but did not appreciated directly the significance of Ahlfors result, and had to rediscover it later (ca. 2001) after some intense own work (ca. 2 years of efforts) ♠ this is a bit ironical for showing how one can severely miss a crucial information through quick reading, but permitted me to develop an independent approach which ultimately turned out to give a sharper result than Ahlfors's ♠ so this is probably a perfect illustration of how a poor knowledge of the literature is sometimes beneficial for the creativity in "young men games" (if we can borrow Hardy's bitter joke)] ♡200
- [40] N.L. Alling, B.V. Limaye, *Ideal theory on non-orientable Klein Surfaces*, Ark. Mat. ?? (1972), 277–292. [♣ extension of the Beurling-Rudin result for the disc to non-orientable bordered surfaces, hence cannot employ the Ahlfors map (whose existence is confined to the orientable case), for which case see Stanton 1972 [797] who uses the Ahlfors map for the same purpose (extension of Beurling-Rudin)] ♡4
- [41] D. Alpay, V. Vinnikov, *Indefinite Hardy spaces on finite bordered Riemann surfaces*, J. Funct. Anal. 172 (2000), 221–248. A50 [♣ p.240 Ahlfors 1950 [17] is cited and other references are given namely Alling-Greenleaf 1971 [39] (where however no existence-proof is given), Fay 1973 [232] (where perhaps only the schlicht case is treated?), and finally Fedorov 1991 [233] (where probably only the planar case is treated) ♠ still on p.240 it is asserted that $g + 1$ is the minimal possible degree for expressing a compact bordered Riemann surface as ramified covering of the unit-disc (g being as usual the genus of the double, cf. p.230) ♠ if correct this assertion would (blatantly) corrupt the main result of Gabard 2006 [255] (which by virtue of the incertitude principle could be false) ♠ however the sharpness of $g + 1$ in general is easily corrupted on the basis of simple concrete example of Klein's Gürtelkurve (real quartic with two nested ovals) projected from a real point situated in the inner oval (cf. Figure 6 in Gabard 2006 [255, p.955]), and therefore Alpay-Vinnikov's assertion looks slightly erroneous. NB: this little misconception about the sharpness of Ahlfors bound seems to originate in Fay's book, cf. Fay 1973 [232] ♠ of course this sloppy detail does not entail at all the intrinsic beauty of this paper namely the study of Hardy spaces on finite bordered Riemann surface: "Furthermore, each holomorphic mapping of the finite bordered Riemann surface onto the unit disk (which maps boundary to boundary)determines an explicit isometric isomorphism between this space [a certain Kreĭn space] and a usual vector-valued Hardy space on the unit disk with an indefinite inner product defined by an appropriate Hermitian matrix."] ♡11
- [42] C. Andreian Cazacu, *On the morphisms of Klein surfaces*, Rev. Roumaine Math. Pures Appl. 31 (1986), 461–470. [♣ inspired by Alling-Greenleaf 1971 [39] and Stĭlow 1938 [800] ♠ [17.10.12] for another (more elementary) proof of this result, cf. a paper by Cirre 1997] ♡??
- [43] C. Andreian Cazacu, *Interior transformations between Klein surfaces*, Rev. Roumaine Math. Pures Appl. 33 (1988), 21–26. [♣ from the Introd.: "The interior transformations were introduced by Simion Stoilow in order to solve Brouwer's problem: the topological characterization of analytic functions. By means of these transformations he founded a vast topological theory of analytic functions with essential implications in the study of Riemann surfaces [8](=Soilow 1938 [800]). In this paper we show that interior transformations are a powerful tool in Klein surfaces theory [2](=Alling-Greenleaf 1971 [39]) too. [...]"] ♡??
- [44] C. Andreian Cazacu, *Complete Klein coverings*, Bull. Soc. Sci. Lett. Łódź Sér. Rech. Déform. 37 (2002), 7–14. [♣ the notion of the title is introduced as a generalization of the Ahlfors-Sario notion of complete Riemann coverings (1960 [22, p.42, §21A]), i.e. any point in the range has a neighborhood whose inverse image consists only of compact components. For the case of coverings with a finite number of sheets, it is shown that a Klein covering is complete iff it is total, in the

sense of Stoilow (1938 [800]), that is any sequence tending to the boundary has an image tending to the boundary. ♠ [13.10.12] such purely topological conceptions are mentioned for they subsume the topological behaviour of Ahlfors circle maps (i.e. full covering of the circle, alias disc) ♡??

- [45] A. Andreotti, *Un'applicazione di un teorema di Cecioni ad un problema di rappresentazione conforme*, Ann. Sc. Norm. Super. Pisa (3) (1950), 99–103. AS60, but not in G78 [♣ seems to extend the result of Matildi 1948 [536] to the case of several contours, hence could be an (independent) proof of the existence of a circle map (than that of Ahlfors 1950 [17]) ♣ in fact the writer (Gabard) was not able to follow all the details of Andreotti's proof but I have no specific objection to make (it would be a good challenge if somebody is convinced by the argument to translate it in English to make the argument more generally accessible, ask maybe Coppens or Huisman) ♣ it would be interesting to see which degree is obtained by this method (presumably the genus of the double plus one, i.e. $p + 1$ cf. p. 101, where $k > p$ [by Riemann-Roch]) ♣ maybe a last comment is that in Andreotti's result it is not perfectly clear if the circumference can be arranged to coincide, so has to get an Ahlfors circle map] ♡??
- [46] P. Appell, E. Goursat, *Théorie des fonctions algébriques d'une variable et des transcendentes qui s'y rattachent*, Deuxième édition revue et augmentée, Tome II, Fonction automorphes, par Pierre Fatou, Paris, Gauthier-Villars, 1930. AS60 [♠ discusses Klein's orthosymmetry] ♡??
- [47] E. Arbarello, M. Cornalba, *Footnotes to a paper of Beniamino Segre. The number of g_d^1 's on a general d -gonal curve, and the unirationality of the Hurwitz spaces of 4-gonal and 5-gonal curves*, Math. Ann. 256 (1981), 341–362. ♡??
- [48] E. Arbarello, M. Cornalba, P. A. Griffiths, J. Harris, *Geometry of algebraic curves, Volume I*, Grundlehren der math. Wiss. 267, Springer-Verlag, 1985. [♠ p. 217: “The existence theorem for g_d^1 's was first proved by Meis [1](=Meis 1960 [541]). Later, at a time when the techniques of enumerative geometry were better understood, the first fundamental theorem of the theory was established with a completely modern approach. In fact (partly under the influence of unpublished work of Mumford) simultaneously Kempf and Kleiman–Laksov gave the first rigorous proof of the Existence Theorem, and of Theorem (1.3). (See Kempf [1](=1971/72 [422]), Kleiman–Laksov [1,2](=1972 [428], 1974 [429]))” ♠ [09.10.12] again one may wonder if this enumerative geometry technology is susceptible to adapt to the context of the Ahlfors map, which amounts to real curves of the orthosymmetric(=dividing) type (ideally the goal would be to adapt the Kempf/Kleiman–Laksov proof to recover the bound of Gabard 2006 [255] interpreted as a bordered avatar of Meis 1960 [541]) ♠ another reason for quoting this book in connection with the Ahlfors map is the issue about generalized Ahlfors maps taking values not in the disc but in another finite bordered Riemann surface. Then there is a certain evidence that such Ahlfors maps generally fail to be full covering surface, for the doubled map relates two closed Riemann surfaces. But the latter are severely restricted and generally not existing. This can be either argued via a moduli count as in Griffiths-Harris 1980 [304] or via Exercise C-6. given on p. 367 (of the book under review): “From the preceding exercise and the theorem on global monodromy proved in Chapter X conclude that a general curve of genus $g \geq 2$ does not admit a nonconstant map to a curve of positive genus.” ♠ of course the statement is a bit sloppy for there is always the identity map as a trivial counterexample, but probably maps of non-unity degree are excluded tacitly. The proof given seems to use the fact that given a branched covering of curves the fundamental class of the inverse image of the Jacobian variety of the image curve is not a rational multiple of θ^{g-h} , where θ is the theta divisor and g, h are the resp. genres of the curves] ♡??
- [49] R. Arens, *The closed maximal ideals of algebras of functions holomorphic on a Riemann surface*, Rend. Circ. Mat. Palermo 7 (1958), 245–260. [♠] ♡14
- [50] N. Aronszajn, *Theory of reproducing kernels*, Trans. Amer. Math. Soc. 68 (1950), 337–404. [♠ abstract unified view on the theory of the reproducing kernel containing the special cases of Bergman and Szegő, etc.] ♡??
- [51] C. Arzelà, *Sul Principo di Dirichlet*, Nota letta alla R. Accademia delle Scienze dell'Instituto di Bologna nell'Adunza del 24 Gennaio 1897. [♠ cited in Zaremba 1910 [908] as a precursor of Hilbert's resurrection of the Dirichlet principle]★★★ ♡??

- [52] G. Aumann, C. Carathéodory, *Ein Satz über die konforme Abbildung mehrfach zusammenhängender ebener Gebiete*, Math. Ann. 109 (1934), 756–763. G78, but not in AS60 ♡??
- [53] J. A. Ball, *Operators of class C_{00} over multiply-connected domains*, Michigan Math. J. 25 (1978), 183–196. A47 [♠ p.187, Ahlfors 1947 [16] is cited for the following result (in fact due to Bieberbach 1925 [97] in this formulation): “If R is a domain in the complex-plane bounded by $n + 1$ nonintersecting analytic Jordan curves, there exists a complex-valued inner function on R , which is analytic on a neighborhood of \bar{R} , has precisely $n + 1$ zeros in R , and wraps each component of the boundary of R once around the unit disk [sic, but “disk” should rather be “circle”] ♠ this theorem (of Bieberbach-Grunsky-Ahlfors) is then applied to a problem in operator theory] ♡??
- [54] J. A. Ball, *A lifting theorem for operator models of finite rank on multiply-connected domains*, J. Operator Theory 1 (1979), 3–25. A47 [♠ Ahlfors 1947 [16] is cited on p.11 (in a context where perhaps Bieberbach 1925 [97] would have been logically sufficient) ♠ again the philosophy of the paper seems to transplant via the Ahlfors function a certain lifting theorem for operator models on the disc (due to Sz.-Nagy-Foias) to the more general case of a multi-connected domain ♠ one can of course wonder about extension on bordered Riemann surfaces, probably established meanwhile (?)] ♡??
- [55] J. A. Ball, K. Clancey, *Reproducing kernels for Hardy classes on multiply-connected domains*, Integral Equations Operator Theory 25 (1996), 35–57. [♠ extension to finite bordered Riemann surface, try Alpay-Vinnikov 2000 [41]] ♡??
- [56] S. Banach, *Théorie des opérations linéaires*, Warsaw, 1932. [♠ cited in Read 1958 [676], where the Hahn-Banach theorem is put in connection to the Ahlfors map] ♡??
- [57] C. Bandle, M. Flucher, *Harmonic radius and concentration of energy; hyperbolic radius and Liouville’s equations $\Delta U = e^U$ and $\Delta U = U^{\frac{n+2}{n-2}}$* , SIAM Review 38 (1996), 191–238. A47 [♠ Ahlfors 1947 [16] is cited on p.200 as follows: “Corollary 4 extends Liouville’s formula to multiply connected planar domains and so does the following formula from Mityuk’s monograph [79](=1985). Denote by $f: \Omega \rightarrow B$ an Ahlfors map of Ω (cf. Ahlfors [1](=Ahlfors 1947 [16]), obtained as a solution of the same extremal problem that we used for the definition of the Riemann map (§1). Then the inner radius of Ω is given by $r(x) = \frac{1-|f(x)|^2}{|f'(x)|} \exp(-2\pi \sum_{\{y \neq x: f(y)=x\}} G_x(y))$, provided $f'(x) \neq 0$. Note that on a k -connected domain the Ahlfors map is a k -sheeted branched covering. A modified formula involving higher derivative of f holds at the branch points. The proof is similar to that of Corollary 4.” ♠ perhaps instead of the mentioned monograph, the original articles of Mityuk already contain this (multi-connected) extended formula, cf. Mityuk 1965 [560] (and also Mityuk 1968 [561] for the statement (in English), yet without the proof)] ♡??
- [58] V. Bangert, C. Croke, S. Ivanov, M. Katz *Filling area conjecture and ovalless real hyperelliptic surfaces*, Geom. Funct. Anal. ?? (2005), ?-?. [♠ solve the hyperelliptic case of the filling area conjecture due to Gromov, hence in particular the genus-one case $p = 1$ ♠ the hearth of the argument seems to be an old result of Hersch] ♡26
- [59] W. H. Barker II, *Kernel functions on domains with hyperelliptic double*, Trans. Amer. Math. Soc. 231 (1977), 339–347. (Diss. under M. M. Schiffer) [♠ p.345, the Ahlfors (extremal) function of a domain is discussed by referring to Bergman 1950 [84], Heins 1950 [358], and also the original treatment due to Ahlfors 1947 [16] and that of Garabedian 1949 [276]] ♡5
- [60] E. Bedford, *Proper holomorphic mappings*, Bull. Amer. Math. Soc. (N.S.) 10 (1984), 157–19?. A50 [♠ p.159, Ahlfors 1950 is quoted as follows: “The existence of many proper mappings is given by a result of Grunsky [55](=[315]) and Ahlfors [1](=1950 [17]). THEOREM. If M is a finite Riemann surface with nondegenerate boundary components, then there exists a proper mapping $f: M \rightarrow \Delta$. In general, however, given two Riemann surfaces M and N , it does not seem easy to say whether there exists a proper mapping $f: M \rightarrow N$.”] ♡43
- [61] H. Behnke, H. Zumbusch, *Konforme Abbildung von Bereichen auf in ihnen liegenden Bereiche*, Semester-Ber. math. Sem. Münster 8 (1936), 100–121. [♠ quoted in Grunsky 1940 [317, p.233], in connection with the definition of the Carathéodory metric (first appearance in Carathéodory 1926 [142]) for multi-connected domains] ♡??

- [62] H. Behnke, K. Stein, *Entwicklungen analytischer Funktionen auf Riemannschen Flächen*, Math. Ann. 120 (1947/49), 430–461. [♠ proves that any open Riemann surface carries a nonconstant analytic function ♠ in the case where the Riemann surface is the interior of a compact Riemann surface this also follows from Ahlfors 1950 [17] in the much sharper form of a branched covering of the disc ♠ naive question [01.10.12]: by using an exhaustion of the open Riemann surface by finite bordered ones what sort of functions can be constructed on the whole surface? Is it in particular possible to subsume the Behnke-Stein theorem to that of Ahlfors? (looks a bit naive I confess)] ♡??
- [63] H. Behnke, F. Sommer, *Theorie der analytischen Funktionen einer komplexen Veränderlichen*, Third Edition, Springer-Verlag, New York, 1965. [♠ pp. 581–2 is quoted in Černe-Forstnerič 2002 [166] for the “(Schottky) double” ♠ other sources for this purposes are Klein 1882 [434] (in romantic pre-axiomatic style), else Koebe 1928 [?], or Teichmüller 1939 [825] and of course also Springer’s book 1957 [796] or Schiffer-Spencer 1954 [753]] ♡262
- [64] S. R. Bell, *Numerical computation of the Ahlfors map of a multiply connected planar domain*, J. Math. Anal. Appl. 120 (1986), 211–217. [♠ from the Introd.: “N. Kerzman and E. M. Stein discovered in [6](=1978 [423]) a method for computing the Szegő kernel of a bounded domain D in the complex plane with C^∞ smooth boundary. In case D is also simply connected, the Kerzman-Stein method yields a powerful technique for computing the Riemann mapping function associated to a point $a \in D$ (see [6](=Kerzman-Stein 1978 [423]), [7](=Kerzman-Trummer 1984)). In this note, we show how the Kerzman-Stein method can be generalized to yield a method for computing the Ahlfors map associated to a point in a finitely connected, bounded domain in the plane with C^2 smooth boundary. The Ahlfors map is a proper holomorphic mapping of D onto the unit disc which maps each boundary component of D one-to-one onto the boundary of the unit disc.—The Ahlfors map might prove to be useful in certain problems arising in fluid mechanics. For example, in the problem of computing the transonic flow past an obstacle in the plane, a conformal map of the outside of the obstacle onto the unit disc is used to set up a grid which is most convenient for making numerical computations (see [5](=Jameson 1974, “Iterative solution of transonic flows over airfoils and wings, including flows at Mach 1”)). The Ahlfors map could be used in a similar way in problems of this sort in which more than one obstacle is involved. [...]”] ♡8
- [65] S. R. Bell, *The Szegő projection and the classical objects of potential theory in the plane*, Duke Math. J. 64 (1991), ?–?. [♠ quoted in McCullough 1996 [540] for the result that the Ahlfors function acquires distinct (simple) zeros when the center a (the place where the derivative is maximized) is chosen near enough the boundary of the domain ♠ a probably related result is to be found in Ovchintsev 1996/96 [628] ♠ question [20.09.12]: does this result extend to bordered surfaces] ♡??
- [66] S. R. Bell, *The Cauchy transform, potential theory, and conformal mapping*, CRC Press, Boca Raton, Florida, 1992. A50 [♠]★ ♡147
- [67] S. R. Bell, *Complexity of the classical kernel functions of potential theory*, Indiana Univ. Math. J. 44 (1995), 1337–1369. [♠] ♡??
- [68] S. R. Bell, *Ahlfors maps, the double of a domain, and complexity in potential theory and conformal mapping*, J. d’Anal. Math. 78 (1999), 329–344. [♠ proof that generically two Ahlfors maps suffice to generate the field of meromorphic function of the double of the domain (so-called primitive pairs)] ♡13
- [69] S. R. Bell, *Complexity in complex analysis*, Adv. Math. 172 (2002), 15–52. A50 ♡??
- [70] S. R. Bell, *Möbius transformations, the Carathéodory metric, and the objects of complex analysis and potential theory in multiply connected domains*, Michigan Math. J. 51 (2003), 352–361. [♠ p. 361: “It is also a safe bet that many of the results in this paper extend to the case of Riemann surfaces. I leave these investigations for the future.”] ♡5
- [71] S. R. Bell, *Quadrature domains and kernel function zipping*, Ark. Math. 43 (2005), 271–287. [♠ p. 271 (Abstract): “It is proved that quadrature domains are ubiquitous in a very strong sense in the realm of smoothly bounded multiply connected domains in the plane. In fact they are so dense that one might as well assume that any given smooth domain one is dealing with is a quadrature domain, and this allows access to a host of strong conditions on the classical kernel functions associated to the domain.”] ♡5

- [72] S. R. Bell, *The Green's function and the Ahlfors map*, Indiana Univ. Math. J. 57 (2008), 3049–3063. [♠ yet another fascinating paper among the myriad produced by the author, where now a striking expression is given for the Green's function of a finitely connected domain in the plane in terms of a single Ahlfors mapping answering thereby (see third page of the introd.) a subconscious desideratum of Garabedian-Schiffer 1949 [275]] ♡??
- [73] S. R. Bell, *The structure of the semigroup of proper holomorphic mappings of a planar domain to the unit disc*, Complex Methods Function Theory 8 (2008), 225–242. [♠ a description of all circle maps is given by returning to the original papers of Bieberbach and Grunsky] ♡2
- [74] S. R. Bell, *The Szegő kernel and proper holomorphic mappings to a half plane*, Comput. Methods Funct. Theory 11 (2011), 179–191. A50 [♠ construction (for domains) of proper holomorphic maps of arbitrary mapping degree, reminiscent of Heins's argument 1950 [358] about positive harmonic functions] ★★ ♡0
- [75] S. Bergman[n], *Über die Entwicklung der harmonischen Funktionen der Ebene und des Raumes nach Orthogonalfunktionen*, Math. Ann. 86 (1922), 238–271. (Thesis, Berlin, 1921.) [♠ formulates—like Bieberbach 1914 [92]—the desideratum that the function minimizing the area integral $\int \int |f'(z)|^2 d\omega$ is the Kreisabbildung (alias Riemann mapping) ♣ this desideratum will be only accomplished in the late 1940's, i.e. Garabedian/Lehto's era] ♡60
- [76] S. Bergman[n], *Über eine Darstellung der Abbildungsfunktion eines Sternbereiches*, Math. Z. 29 (1929), 481–486. [♠ Minimalbereich in a special case] ♡??
- [77] S. Bergman[n], *Über unendliche Hermitesche Formen, die zu einem Bereiche gehören, nebst Anwendungen auf Fragen der Abbildung durch Funktionen von zwei komplexen veränderlichen*, Math. Z. 29 (1929), 641–677. [♠ p.641 formulates—inspired by Bieberbach 1914 [92]—the concept of a Minimalbereich, by referring to 3 of his previous work (alas no precise cross-references)] ♡??
- [78] S. Bergman[n], *Eine Bemerkung über schlichte Minimalabbildungen*, Sitzgsber. Berliner Math. Ges. 30 (1932) [♠ quoted in Lehto 1949 [500] for yet another formulation—like Bieberbach 1914 [92]—of the desideratum that the function minimizing the area integral $\int \int |f'(z)|^2 d\omega$ is the Kreisabbildung (alias Riemann mapping) ♣ this desideratum will be only accomplished in the late 1940's, i.e. Garabedian/Lehto's era, cf. Lehto 1949 [500, p. 46]] ♡60
- [79] S. Bergman[n], *Über die Kernfunktion eines Bereiches und ihr Verhalten am Rande*, J. Reine Angew. Math. 169 (1933), 1–42; and 172 (1934), 89–128. [♠ p. 3 footnote 2 contains some brief indication on the case of multi-connected domains (in one complex variable) and a cross-ref. to Zarankiewicz 1934 [906]] ♡60
- [80] S. Bergman, *Partial differential equations, Advanced topics* (Conformal mapping of multiply connected domains), Publ. of Brown Univ., Providence, R. I., 1941. [♠ probably completely incorporated in Bergman 1950 [84]] ★★★ ♡60
- [81] S. Bergman, *A remark on the mapping of multiply-connected domains*, Amer. J. Math. 68 (1946), 20–28. [♠ uniformize via the Bergman kernel domains of finite connectivity, and via Koebe (1914/15) can be used for the Kreisnormierung.] G78 ♡??
- [82] S. Bergman[n], *Sur les fonctions orthogonales de plusieurs variables complexes avec les applications à la théorie des fonctions analytiques*, Mémoires des Sci. Math. 106 (1947), 1–63. [♠ p.32 points out that the old desideratum of Bieberbach-Bergman 1922 [75] of reproving RMT via the problem of least area was still not achieved until this date of 1947, except for the special case of starlike domains (Bergman 1932 [78] and Schiffer 1938 [744]). The breakthrough may have occurred only by Garabedian and Lehto's Thesis, cf. e.g. [500]] ♡??
- [83] S. Bergman[n], *Sur la fonction-noyau d'un domaine et ses applications dans la théorie des transformations pseudo-conforme*, Mémoires des Sci. Math. 108 (1948). [♠ quoted in Maschler 1956 [530] for the theory of minimal domains ♠ p.41, Kufarev [483] is credited for the issue that for a doubly-connected domain the least area map is not univalent(=schlicht) ♠ of course it looks evident that univalence fails as well in higher connectivity, cf. e.g. Garabedian-Schiffer 1949 [275] ♠ yet nobody seems to claim that the range is a circle] ♡??
- [84] S. Bergman, *The kernel function and conformal mapping*, Mathematical Surveys 5, Amer. Math. Soc., New York, 1950. A50, AS60, G78 [♠ p.87 existence of a circle map for domains via an explicit formula (p.86) as a ratio of two kernel functions ♠ a second revised edition was published in 1970] ♡664

- [85] S. Bergman, M. Schiffer *Kernel functions and conformal mapping*, *Compositio Math.* 8 (1951), 205–249. AS60, G78 ♡??
- [86] A. Bernard, J. B. Garnett, D. E. Marshall, *Algebras generated by inner functions*, *J. Funct. Anal.* 25 (1977), 275–285. [♠ p. 282, the Ahlfors function is briefly mentioned as follows: “To show the inner functions separates the points of X we modify the well-known construction of the Ahlfors function for a Denjoy domain.” ♠ the bulk of the paper is devoted to the question of knowing when the unit ball of an uniform algebra (typically $H^\infty(\Omega)$ for Ω a finitely connected domain) is the closed convex hull of the inner functions ♠ Corollary 5.2 (p. 285) gives this conclusion provided the inner functions separate the points of the Shilov boundary, but the authors seem to confess that they do not know whether this proviso is automatically fulfilled (note: of course the simple argument of Stout 1966 [803, p. 375] saying that inner functions separates points on the Riemann surface (just because the Ahlfors function based at the two given points do separate them) does not apply here, as we are truly looking at mystical points of the Shilov boundary) ♠ p. 276, one reads: “Minor modifications of the proof for this case [i.e. finitely connected plane domain] will give the result when Ω is a finite open Riemann surface, but we leave those details to the interested reader.” ♠ conclusion: since the whole paper actually seeks for an extension of a disc result of Marshall (asserting precisely that the unit ball of the disc algebra $H^\infty(\Delta)$ is the closed convex hull of the inner functions), one could wonder if there is not a more naive strategy exploiting more systematically the Ahlfors function] ♡??
- [87] L. Berzolari, *Allgemeine Theorie der höheren ebenen algebraischen Kurven*, *Enzyklopädie der math. Wiss.*, III, 2, Leipzig, 1906. [♠ includes a shortsurvey of Klein’s theory of symmetric surfaces while coining first the designation “*Klein’s surfaces*” made popular much later by Alling-Greenleaf 1971 [39].] ♡??
- [88] A. Beurling, *Sur un problème de majoration*, Thèse, Upsala, 1935, 109 pp. ♡??
- [89] A. Beurling, *On two problems concerning linear transformation in Hilbert space*, *Acta Math.* 81 (1949), 239–255. [♠ the so-called Beurling’s invariant subspaces theorem ♠ for an extension to finite bordered Riemann surface see M. Hasumi 1966 [339] (and also related work by Voichick 1964 [857]), yet without using the Ahlfors map, but cite Royden 1962 [716] which is closely allied ♠ [03.10.12] one can wonder if like for the corona problem/theorem there is a direct inference of the Ahlfors map upon Beurling’s invariant subspaces (as Alling 1964 [34] managed to do for the corona)] ♡??
- [90] G. V. Beyli, *On Galois extensions of the maximal cyclotomic field*, *Izv. SSSR* 43 (1979), 269–276. [♠ proof that a closed surface is defined over $\overline{\mathbb{Q}}$ iff it ramifies only above 3 points of the sphere] ♡??
- [91] L. Bieberbach, *Über ein Satz des Herrn Carathéodorys*, *Gött. Nachr.* (1913), 552–560. ♡??
- [92] L. Bieberbach, *Zur Theorie und Praxis der konformen Abbildung*, *Rend. del Circolo mat. di Palermo* 38 (1914), 98–112. [♠ this had some influence over Bergman’s Thesis 1921/22 [75], and is in turn inspired by W. Ritz ca. 1908–09 ♠ p.100, first formulation of the principle that the function minimizing the area integral $\int \int |f'(z)|^2 d\omega$ is the Kreisabbildung (alias Riemann mapping), and the hope is expressed of getting an independent proof of its existence through this least area problem ♣ this desideratum (vividly sustained in Bergman’s Thesis 1921/22 [75] and Bochner’s 1922 [107]) will be only achieved in the late 1940’s, i.e. Garabedian/Lehto’s era (see Lehto 1949 [500]) ♣ another desideratum (Gabard 16- ϵ June 2012, but perhaps already known) would be that such an extremal problem (closely allied to the theory of the Bergman kernel) yields an alternative proof of the Ahlfors mapping ♣ even more since it is eminently geometric can we crack—via this Bieberbach-Bergman philosophy—the Gromov filling area conjecture? (Recompense 50 Euros)] ♡??
- [93] L. Bieberbach, *Einführung in die konforme Abbildung*, *Sammlung Göschen*, Berlin, 1915. [♠ pp. 94–108 deal specifically with Bieberbach’s minimizing principle (cf. Bieberbach 1914 [92])] ♡??
- [94] L. Bieberbach, $\Delta u = e^u$ und die automorphen Funktionen, *Math. Ann.* 77 (1916), 173–212. [♣ p. 175 speaks of (Klein’s) orthosymmetry, and write a sentence (which when read outside of its context) bears strange resemblance with the Ahlfors circle map: “*Wir nehmen die Fläche orthosymmetrisch an, d. h. sie möge durch diese Symmetrielinien in zwei symmetrische Hälften zerlegt werden, so daß es sich also*”

- im Hauptkreisfalle um die konforme Abbildung eines berandeten Flächenstückes—der einen Flächenhälfte—auf das Innere des Einheitskreises handelt.* ♠ the real issue in this paper is to implement Schwarz’s desideratum (Göttinger Preisaufgabe 1889) (primarily followed by Picard and Poincaré) of uniformizing (compact) Riemann surfaces via the Liouville equation whose geometric interpretation amounts searching a conformal metric of constant Gaussian curvature ♠ [03.10.12] probably the above should not be interpreted as an Ahlfors map but rather as the fact that the interior of any compact bordered Riemann surface is uniformized by the unit disc (i.e. the universal covering of the interior is the unit disc] ♡??
- [95] L. Bieberbach, *Über einige Extremalprobleme im Gebiete der konformen Abbildung*, Math. Ann. 77 (1916), 153–172. [♠ includes (among other nice geometrical things) the first proof of Koebe’s Viertelsatz with the sharp constant $1/4$ upon the radius of a disc contained in the range of a schlicht map of the unit disc normed by $|f'(0)| = 1$] ♡??
- [96] L. Bieberbach, *Über die Koeffizienten derjenigen Potenzreihen, welche eine schlichte Abbildung des Einheitskreises vermitteln*, S.-B. Preuss. Akad. Wiss. Berlin (1916), 940–955. [♠ where the Bieberbach/coefficient conjecture is first formulated. Solution: de Branges 1984/85.] ♡??
- [97] L. Bieberbach, *Über einen Riemannschen Satz aus der Lehre von der konformen Abbildung*, Sitz.-Ber. Berliner Math. Ges. 24 (1925), 6–9. AS60, G78 (also cited in Courant 1939 [191]) [♣ the schlicht(artig) case of Ahlfors 1950 [17] is proved, and earlier work by Riemann 1857/58 [689] and Schottky 1877 [763] is put in perspective] ♡25
- [98] L. Bieberbach, *Lehrbuch der Funktionentheorie*, vols. 1 and 2, Berlin, New York, 1945. (Photographic reprint of the 4th edition of Band I (1934) and the 2nd edition of Band II (1931)) [♠ cited by Bergman 1950 [84, p.24] for the proof that the minimum function for the problem $\int \int_B |f'(z)|^2 d\omega$ has circle range; of course the original source is Bieberbach 1914 [92]] ★★★ ♡??
- [99] L. Bieberbach, *Conformal mapping*, Chelsea, New York, 1953. [♠]★ ♡??
- [100] L. Bieberbach, *Eine Bemerkung zur konformen Abbildung zweifach zusammenhängender Gebiete*, Math. Z. 67 (1957), 99–102. G78 ♡??
- [101] L. Bieberbach, *Einführung in die konforme Abbildung*, Sammlung Göschen Bd. 768/768a, Walter de Gruyter and Co. (6th ed., 1967). G78 [♠ includes a proof of the Hilbert-Koebe PSM (in infinite connectivity) ♠ presumably an earlier edition (as the one cited in Burckel 1979 [128]) do the job as well] ♡??
- [102] L. Bieberbach, *Das Werk Paul Koebes*, Jahresber. Deutsche Math.-Verein. 70 (1968), 148–158. G78 [♠ contains a complete tabulation of Koebe’s work] ♡??
- [103] E. Bishop, *Subalgebras of functions on a Riemann surface*, Pacific J. Math. 9 (1959), 629–642. [♠] ♡??
- [104] E. Bishop, *Abstract dual extremal problems*, Notices Amer. Math. Soc. 12 No. 1 (1965), 123. [♠ cited in O’Neill-Wermer 1968 [618] for an abstract version of Ahlfors’ extremal problem pertaining to a function algebra over a compact space X] ♡??
- [105] A. Bloch, *La conception actuelle de la théorie des fonctions entières et méromorphes*, L’Enseign. Math. 25 (1926), 83–103. [♠ great French prose and finitistic philosophy à la Kronecker, culminating to the slogan “Nihil est infinito...”] ♡??
- [106] A. Bloch, *Les fonctions holomorphes et méromorphes dans le cercle-unité*, Mémorial des Sci. Math. 20 (1926), 1–61. ♡??
- [107] S. Bochner, *Über orthogonale Systeme analytischer Funktionen*, Math. Z. 14 (1922), 180–207. (Thesis, Berlin, 1921.) [♠ p.184: like Bieberbach 1914 [92] and Bergman 1922 [75] the author confesses to be not able to reprove the RMT via Bieberbach’s minimum problem (least area map) ♠ this problem will be cracked (independently) in Garabedian and Lehto’s thesis (cf. Garabedian 1949 [276] and Lehto 1949 [500])] ♡??
- [108] S. Bochner, *Fortsetzung Riemannscher Flächen*, Math. Ann. 98 (1927), 406–421. [♠ any Riemann surface of finite genus embeds conformally into a closed Riemann surface of the same genus ♠ any Riemann surface embeds into a non-prolongeable Riemann surface] ♡??

- [109] C. F. Bödigheimer, *Configuration models for moduli spaces of Riemann surfaces with boundary*, Abh. Math. Seminar Hamburg (2006). [♠] ♥14
- [110] M. D. Bolt, S. Snoeyink, E. van Anandel, *Visual representation of the Riemann and Ahlfors maps via the Kerzman-Stein equation*, Involve 3 (2010), 405–420. [♠ from MR: “The paper provides an elementary description of the Riemann and Ahlfors maps using the Szegő kernel. It further describes a numerical implementation of the maps.”]★★♥??
- [111] E. Borel, *Leçons sur la théorie des fonctions*, Gauthier-Villars, Paris, 1898. [♠ complex function theory, but also the starting point of modern measure theory (influence over Lebesgue)] ♥??
- [112] J. B. Bost, *Introduction to compact Riemann surfaces, Jacobians and Abelian varieties*, in: From Number Theory to Physics, Springer-Verlag, 1992, Second Corrected Printing 1995. [♠ p.99–104 contains an account of the Belyi-Grothendieck theorem as well as its geometric traduction in terms of equilateral triangulations] ♥??
- [113] M. Brandt, *Ein Abbildungssatz für endlich-vielfach zusammenhängende Gebiete*, Bull. de la Soc. des Sciences et des Lettres de Łódź XXX, 3 (1980). [♠ extension of Koebe’s KNP to shapes with arbitrary contours; similar result in Harrington 1982 [338] ♠ variant of proof in Schramm 1996 [766]] ★★★♥??
- [114] M. Brelot, G. Choquet, *Espaces et lignes de Green*, Ann. Inst. Fourier 3 (1951), 199–263. AS60 [♠ the paper is started with a result of Evans (1927) that the streamlines of the Green’s function $G(z, t)$ [with pole at t] in a simply-connected plane domain have almost all (in the angular sense about t) finite length and therefore converge to a frontier-point ♠ this is adapted to domains of arbitrary connectivity (as well as to “superior spaces”) ♠ presumably as well as to bordered surfaces: [11.08.12] incidentally one could dream of a proof of Gromov’s FAC just via the Green’s function, while using the corresponding isothermic coordinates to calculate the area] ♥??
- [115] M. Brelot, *La théorie moderne du potentiel*, Ann. Inst. Fourier 4 (1952), 113–140. [♠ p. 114 “Mais si l’on peut dire que tout est dans l’œuvre de Gauss, il apparut bientôt que la rigueur était insuffisante” ♠ a historical survey starting from Poisson, then Gauss 1840 (who considers as evident that the minimum energy is attained, electrostatic influence, problème du balayage), and the culmination of Frostman’s thesis (1935); meanwhile Dirichlet, Riemann and Hilbert; and also Neumann, Schwarz, Harnack and Poincaré’s balayage; next Fredholm’s theory (1900) and its application to Dirichlet and Neumann; Zaremba’s works; Lebesgue’s integral found an application in Fatou’s study of the Poisson integral and Evans introduced the Radon integral in potential theory; Perron and Wiener renewed the Dirichlet problem; F. Riesz introduced subharmonic functions (precursors like Poincaré and Hartogs are signaled on p.134); ca. 1930 de la Vallée Poussin took up again the méthode du balayage to study “les masses balayées”, etc.] ♥??
- [116] A. Brill, M. Noether, *Über die algebraischen Functionen und ihre Anwendungen in der Geometrie*, Math. Ann. 7 (1873), 269–310. CHECK DATE 1874? ♥??
- [117] A. Brill, M. Noether, *Bericht über die Entwicklung der Theorie der algebraischen Functionen in älterer und neuerer Zeit*, Jahresber. Deutsche Math.-Verein. 3 (1894), 107–566. [♠ a monumental historiography spread over more than 400 pages, from Descartes to Riemann and more] ♥??
- [118] L. E. J. Brouwer, *Über die topologischen Schwierigkeiten des Kontinuitätsbeweises der Existenztheoreme eindeutig umkehrbarer polymorpher Funktionen auf Riemannschen Flächen*, Gött. Nachr. (1912), 603–606. AS60 [♠ topological methods as applied to uniformization] ♥??
- [119] L. E. J. Brouwer, *Über die Singularitätenfreiheit der Modulmannigfaltigkeit*, Gött. Nachr. (1912), 803–806. AS60 [♠ idem] ♥??
- [120] L. E. J. Brouwer, *Ueber eineindeutige, stetige Transformationen von Flächen in sich (6. Mitt.)*, KNAW Proceedings 21 (1919), 707–710. [♠ Brouwer seems to vindicate his priority over Koebe for a topological proof of uniformization via the continuity method] ♥??
- [121] L. Brusotti, *Sulla “piccola variazione” di una curva piana algebrica reale*, Rend. Rom. Acc. Lincei (5) 30 (1921), 375–379. [♠ systematic small perturbation method for the independent smoothings of nodal plane curves (based upon an extrinsic version of Riemann-Roch, worked out over \mathbb{C} by Severi)] ♥??

- [122] E. Bujalance, J. J. Etayo, J. M. Gamboa, G. Gromadzki, *Automorphisms groups of compact bordered Klein surfaces*, Lecture Notes in Math. 1439, Springer-Verlag, 1990. [♠] ♥??
- [123] J. Burbea, *The Carathéodory metric in plane domains*, Kodai. Math. Sem. Rep. 29 (1977), 159–166. [♠ application of the Ahlfors function to a curvature estimate of the Carathéodory metric (defined via the analytic capacity) along the line of Suita’s works ♠ Abstract: “Let $D \notin O_{AB}$ be a plane domain [i.e., supporting non-constant bounded analytic functions] and let $C_D(z)$ be its analytic capacity at $z \in D$ [that is the maximum distortion of a circle-map centered at z]. Let $\mathcal{K}_D(z)$ be the curvature of the Carathéodory metric $C_D(z)|dz|$. We show that $\mathcal{K}_D(z) < -4$ if the Ahlfors function of D w.r.t. z has a zero other than z . For finite [domains] D , $\mathcal{K}_D(z) \leq -4$ and equality holds iff D is simply connected. As a corollary we obtain a result proved first by Suita, namely, that $\mathcal{K}_D(z) \leq -4$ if $D \notin O_{AB}$. Several other properties related to the Carathéodory metric are proven.” ♠ a little anachronism is noteworthy, here logically the Ahlfors function and the allied analytic capacity (1947 [16]) precedes the Carathéodory metric (1926 [142] and 1927 [143]), but of course in view of the real history, especially Carathéodory 1928 [144] the definitional aspect is essentially compatible with the historical flow] ♥??
- [124] J. Burbea, *The curvatures of the analytic capacity*, J. Math. Soc. Japan 29 (1977), 755–761. [♠ p.755: Ahlfors function à la Havinson 1961/64 [345], i.e. for domains $D \notin O_{AB}$, analytic capacity, method of the minimum integral w.r.t. the Szegő kernel] ♥??
- [125] J. Burbea, *Capacities and spans on Riemann surfaces*, Proc. Amer. Math. Soc. 72 (1978), 327–332. [♠ p.329: “Ahlfors function” is mentioned (in connection with the analytic capacity, yet it is not clear to me [03.10.12] if this definition is meaningful not for a domain but also on a finite Riemann surface)] ♥??
- [126] J. Burbea, *The Schwarzian derivative and the Poincaré metric*, Pacific J. Math. 85 (1979), 345–354. [♠] ♥??
- [127] J. Burbea, *The Cauchy and the Szegő kernels on multiply connected regions*, Rend. Circ. Mat. Palermo (2) 31 (1982), 105–118. [♠ Ahlfors function mentioned on p.106 an p.116] ♥9
- [128] R. B. Burckel, *An Introduction to Classical Complex Analysis*, Vol.1, Mathematische Reihe 64, Birkhäuser, 1979. [♠ p.357 some nice comments upon the literature about PSM] ♥??
- [129] W. Burnside, *On functions determined from their discontinuities, and a certain form of boundary condition*, Proc. London Math. Soc. 22 (1891), 346–358. [♠ detected [30.07.12] via W. Seidel’s bibliogr. (1950/52), who summarize the paper as: a method is given for mapping a region bounded by m simple closed curves C_i on an n -sheeted Riemann surface over the w -plane, where the curves C_i correspond to rectilinear slits ♠ surprisingly this paper is not quoted in Ahlfors-Sario 1960 [22] nor in Grunsky 1978 [322] ♠ the topic addressed bears some vague resemblance with the Bieberbach-Grunsky-Ahlfors paradigm of the circle map] ♥??
- [130] P. Buser, M. Seppälä, R. Silhol, *Triangulations and moduli spaces of Riemann surfaces with group actions*, Manuscr. Math. 88 (1995), 209–224. [♠ connectedness of the moduli space of real curves when projected down in the complex moduli] ♥??
- [131] A. P. Calderón, *Cauchy integrals on Lipschitz curves and related operators*, Proc. Nat. Acad. Sci. U.S.A. 74 (1977), 1324–1327. [♠ implies a resolution of the so-called Denjoy conjecture, according to which a subset of a rectifiable curve is removable for the class of bounded analytic functions (alias Painlevé null-sets) iff it has zero length ♠ the explicit link from Calderón-to-Denjoy is made explicit in Marshall [525], upon combining a long string of previous works (Garabedian, Havinson, Davie 1972 [200])] ♥318
- [132] A. P. Calderón, *Commutators, singular integrals on Lipschitz curves and applications*, ICM Helsinki 1978, 85–96. [♠ the Denjoy’s conjecture is mentioned as an application of Calderón 1977 [131], as follows (p.90): “Now let us turn to applications. Let Γ be a simple rectifiable arc in the complex plane. Then the function $G(z) = \frac{1}{2\pi i} \int_{\Gamma} \frac{f(w)}{w-z} dw$, where $f(w)$ is a function on Γ which is integrable w.r.t. arc length, has a limit almost everywhere in Γ as z approaches nontangentially a point of Γ . [...] Another application is the following result due to D. E. Marshall (personal communication) which confirms an old conjecture of A. Denjoy (1909 [205]): the analytic capacity $\gamma(E)$ of a compact subset E of a rectifiable arc in

- the complex plane is zero if and only if its one-dimensional Hausdorff measure vanishes.” ♠ for the detailed proof see Marshall [525] (and maybe also Melnikov 1995 [544]) ♡56
- [133] A. P. Calderón, *Acceptance speech for the Bôcher Price*, Notices A.M.S. 26 (1979), 97–99. [♠ the solution to the Denjoy’s conjecture is mentioned as one of the most significant application of the article Calderón 1977 [131]]★★ ♡4
- [134] C. Carathéodory, *Sur quelques applications du théorème de Landau-Picard*, C. R. Acad. Sci. Paris 144 (1907), 1203–1204; also in: Ges. Math. Schriften, Band 3, 6–9. [♠ first modern proof of the Schwarz lemma, acknowledging E. Schmidt, compare footnote 2: “Je dois cette démonstration si élégante d’un théorème connu de M. Schwarz (Ges. Abh., t. 2, p. 108) à une communication orale de M. E. Schmidt.”] ♡??
- [135] C. Carathéodory, *Über die Variabilitätsbereich der Koeffizienten von Potenzreihen die gegebene Werte nicht annehmen*, Math. Ann. 64 (1907), 95–115. [♠ this and the next entry where the first work bringing together Minkowski’s theory of convex sets with complex function theory ♠ for an extension of this Carathéodory theory to finite Riemann surface, cf. Heins 1976 [362]] ♡220
- [136] C. Carathéodory, *Über die Variabilitätsbereich der der Fourierschenkonstanten von positiven harmonischen Funktionen*, Rend. Circ. Mat. Palermo 32 (1911), 193–217. [♠] ♡220?
- [137] C. Carathéodory, L. Fejér, *Über den Zusammenhang der Extremen von harmonischen Funktionen mit ihren Koeffizienten und über den Picard-Landauschen Satz*, Rend. Circ. Mat. Palermo 32 (1911), 218–239. [♠ for a (vague?) interconnection of this article with the Ahlfors map, cf. Jenkins-Suita 1979 [393]] ♡??
- [138] C. Carathéodory, *Untersuchungen über die konformen Abbildungen von festen und veränderlichen Gebieten*, Math. Ann. 72 (1912), 107–144. G78 ♡??
- [139] C. Carathéodory, *Über die gegenseitige Beziehung der Ränder bei der konformen Abbildung des Inneren einer Jordanschen Kurve auf einen Kreis*, Math. Ann. 73 (1913), 305–320. ♡??
- [140] C. Carathéodory, *Über die Begrenzung einfach zusammenhängender Bereiche*, Math. Ann. 73 (1913), 323–370. ♡??
- [141] C. Carathéodory, *Elementarer Beweis für den Fundamentalsatz der konformen Abbildung*. In: Mathematische Abhandlungen, Hermann Amandus Schwarz zu seinem fünfzigjährigen Doktorjubiläum am 6. August 1914 gewidmet von seinen Freunden und Schülern, 19–41; also in: Ges. Math. Schriften, Band 3, 273–299. [♠ p. 294 perhaps the first usage of the jargon “*quasikonform*”, compare Ahlfors’ memory failure reported in Kühnau 1997 [486] ♠ more importantly the classical square-root procedure is developed in detail] ♡??
- [142] C. Carathéodory, *Über das Schwarzsche Lemma bei analytischen Funktionen von zwei komplexen Veränderlichen*, Math. Ann. 97 (1926), 76–98. [♠ quoted in Grunsky 1940 [317, p. 233], who discusses the connection between the Carathéodory metric and the “Ahlfors” function (which in the present connection should be definitively better called the “Grunsky-Ahlfors function”)] ♡??
- [143] C. Carathéodory, *Über eine spezielle Metrik, die in der Theorie der analytischen Funktionen auftritt*, Atti Pontifica Acad. Sc., Nuovi Lincei 80 (1927), 135–141. [♠ where the so-called Carathéodory metric is first defined (but see also the previous entry Carathéodory 1926 [142]), which in turn turned out to be closely related to the Ahlfors function, cf. e.g. Grunsky 1940 [317], Simha 1975 [790], Burbea 1977 [123], Krantz 2008 [477]] ♡??
- [144] C. Carathéodory, *Bemerkungen zu den Existenztheoremen der konformen Abbildung*, Bull. Calcutta Math. Soc. 20 (1928), 125–134; also in: Ges. Math. Schriften, Band 3, 300–310. AS60 [♣ along lines initiated by Fejér-Riesz (published by Radó 1922/23 [666]) a new proof of RMT is given via an extremal problem, which is a simply-connected prelude to Ahlfors 1950 [17] ♣ as pointed out by Remmert 1991 [679] Carathéodory’s elegant proof appears rarely in book form (exception Narasimhan’s book), and is somewhat less popular than the variant of Fejér-Riesz-Bieberbach-Ostrowski ♠ the article involves (cf. p. 303) the extremal problem $\max |f(z_1)|$ of maximizing the modulus of the function at an auxiliary point z_1 , whereas the other method (Fejér-Riesz, etc.) maximizes the derivative at the base-point z_0 ♠ it is precisely Carathéodory’s version which is extended in Ahlfors 1950 [17], but of course the other formulation lead likewise to a circle map] ♡??

- [145] C. Carathéodory, *Conformal representation*, Cambridge Tracts in Math. and Math. Physics 28, London 1932. (2nd edition 1958) AS60, G78 [♠ an introduction to problem of conformal mapping] ♡??
- [146] C. Carathéodory, *On Dirichlet's problem*, Amer. J. Math. 59 (1937), 709–731. [♠ surprisingly this item is not quoted in Ahlfors-Sario 1960 [22] ♠ p. 710: “In the foregoing chapter, I have tried to give a very elementary treatment of the principal properties of harmonic functions culminating in the existence proof for Dirichlet's problem devised by O. Perron [=1923 [635]] and very much simplified by T. Radó and F. Riesz [=1925 [671]]. I have done this in order to show how the whole theory can be condensed if one puts systematically from the outset Poisson's Integral in the limelight.”] ♡??
- [147] C. Carathéodory, *A proof of the first principal theorem on conformal representation*, Studies and Essays presented to R. Courant on his 60th birthday, Jan. 8, 1948, Interscience Publ., 1948, 75–83; also in: Ges. Math. Schriften, Band 3, 354–361. AS60, G78 [♠ another proof of RMT through an iterative method, using square-roots operations, Schwarz's lemma and Montel ♠ naive question, although this might be more in line with the earlier approach ca. 1910 of Koebe-Carathéodory, this approach looks more involved than the extremum problem in the previous item [144], and perhaps less susceptible of extension to Riemann surfaces] ♡??
- [148] C. Carathéodory, *Funktionentheorie, I, II*, Birkhäuser, Basel, 1950. AS60, G78 ♡??
- [149] C. Carathéodory, *Bemerkung über die Definition der Riemannschen Flächen*, Math. Z. 52 (1950), 703–708. AS60 [♠ purist approach to uniformization via extremal problems, similar ideas in several papers by Grunsky not listed here, cf. his Coll. Papers ♠ the (Grenzkreis) uniformization appears also in Carathéodory 1928 [144]] ♡??
- [150] T. Carleman, *Über ein minimal Problem der mathematischen Physik*, Math. Z. 1 (1918), 208–212. G78 [♠ used in Gaier 1978 [260] and Alenycin 1981/82 [32] in connection with an extension of the (Bieberbach 1914) minimum area problem to multiply-connected regions] ♡??
- [151] T. Carleman, *Sur la représentation conforme des domaines multiples connexes*, C.R. Acad. Sci. Paris 168 (1919), 843–845. G78 [♠ another proof of KNP=Kreinsnormierungsprinzip, originally due to Koebe 1907/1920, if not (implicit in) Schottky 1877 [763]] ♡??
- [152] T. Carleman, *Über die Approximation analytischer Funktionen durch linear Aggregate von vorgegebenen Potenzen*, Arkiv för mat., astron. o. fys. 17 (1922). [♠ credited in Lehto 1949 [500, p. 8] for some work (independent of Bergman 1922 [75] and Bochner's 1922 [107]) inaugurating the usage of orthogonal systems in the theory of conformal mappings] ♡??
- [153] L. Carleson, *On bounded analytic functions and closure problems*, Ark. Mat. 2 (1952), 283–291. [♠]★★ ♡??
- [154] L. Carleson, *Interpolations by bounded analytic functions and the Corona problem*, Ann. of Math. (2) 76 (1962), 547–559. [♠ one of the super-famous problem solved by Carleson, and which received (thanks Alling 1964 [34] and others) an extension from the disc to any compact bordered Riemann surface via the Ahlfors circle map] ♡560
- [155] L. Carleson, *Selected problems on exceptional sets*, Van Nostrand, Princeton, 1967. [♠ p. 73–82 uniqueness of the Ahlfors extremal function [the one maximizing the derivative at a fixed point amongst functions bounded-by-one] for domains of infinite connectivity; similar work in Havinson 1961/64 [345] and simplifications in Fisher 1969 [238]] ♡??
- [156] L. Carleson, *Lars Ahlfors and the Painlevé problem*. In: *In the tradition of Ahlfors and Bers* (Stony Brook, NY, 1998), 5–10. Contemp. Math. 256, Amer. Math. Soc., Providence, RI, 2000. Nostrand, Princeton, 1967. [♠ survey of the theory of removable sets for bounded analytic functions (a.k.a. Painlevé null-sets) from Painlevé, Denjoy to G. David, via Ahlfors (analytic capacity), Garabedian and Melnikov (Menger curvature). Future research is suggested along the 3 axes: (i) develop a theory of periods for the conjugate of positive harmonic functions (ii) sharper study of the extremal function (and induced measure) that appear in Garabedian 1949 [276] (iii) to continue the the study of the Cauchy integrals in relation with Menger curvature and rectifiability] ♡??

- [157] F. Carlson, *Sur le module maximum d'une fonction analytique uniforme. I*, Ark. Mat. Astron. Fys. 26 (1938), 13 pp. G78 [♠ quoted (joint with Teichmüller 1939 [825] and Heins 1940 [356]) in Grunsky 1940 [317] as one of the precursors of the extremal problem for bounded analytic functions] ★★★ ♡??
- [158] A. L. Cauchy, *Mémoire sur les intégrales définies prises entre des limites imaginaires*, De Bure Frères, Paris, 1825. Reprint Œuvres de Cauchy, Série II, tome XV, 41–89. [♠] ♡??
- [159] A. L. Cauchy, *Considérations nouvelles sur les intégrales définies qui s'étendent à tous les points d'une courbe fermée, et sur celles qui sont prises entre des limites imaginaires*, C.R.A.S. 23 (1846), 689. [♠] ♡??
- [160] F. Cecioni, *Sulla rappresentazione conforme delle aree piane pluriconnesse su un piano in cui siano eseguiti dei tagli paralleli*, Rend. Circ. Mat. Palermo 25 (1908), 1–19. G78 [♠ another derivation of the parallel-slit map of Schottky 1877 [763], via several citation to Picard's book for the foundational aspects ♠ as Schottky's proof depends on a heuristic moduli count, this paper of Cecioni may well be regarded as the first rigorous existence proof of PSM (cf., e.g., Grunsky 1978 [322, p. 185])] ♡??
- [161] F. Cecioni, *Sulla rappresentazione conforme delle aree pluriconnesse appartenenti a superficie di Riemann*, Annali delle Università Toscane 12, nuova serie (1928), 27–88. [♠ cited via Matildi 1948 [536]; WARNING: this entry looks much like the next item, yet differs in the pagination] ★★ ♡??
- [162] F. Cecioni, *Sulla rappresentazione conforme delle aree pluri-connesse appartenenti a superficie di Riemann*, Rend. Accad. d. L. Roma (6) 9 (1929), 149–153. AS60 [♠ cited via Ahlfors-Sario 1960 [22]] ★★ ♡??
- [163] F. Cecioni, *Osservazioni sopra alcuni tipi aree e sulle loro curve caratteristiche nella teoria della rappresentazione conforme*, Rend. Palermo 57 (1933), 101–122. [♠ la parole “curve catteristiche” means the Schottky(-Klein) double ♠ contains several nice remarks about the Klein correspondence when particularized to orthosymmetric curve tolerating a direct-conformal involution which is sense reversing on the ovals] ♡??
- [164] F. Cecioni, *Un teorema su alcune funzioni analitiche, relative ai campi piani pluriconnessi, usate nella teoria della rappresentazione conforme*, Ann. Pisa (2) 4 (1935), 1–14. G78 ♡??
- [165] M. Černe, J. Globevnik, *On holomorphic embedding of planar domains into \mathbb{C}^2* , J. Anal. Math. 81 (2000), 269–282. A50 [♠ Koebe's Kreisnormierungsprinzip is combined with the Ahlfors function to show that every bounded, finitely connected domain of \mathbb{C} without isolated boundary points embeds properly holomorphically into \mathbb{C}^2 ♠ of course, those are not the sole ingredients for otherwise the method would probably extend to positive genus surfaces in view of Ahlfors 1950 [17], and positive genus extensions of KNP due to Haas 1984 [329]/Maskit 1989 [534]] ♡4?
- [166] M. Černe, F. Forstnerič, *Embedding some bordered Riemann surfaces in the affine plane*, Math. Research Lett. 9 (2002), 683–696. A50 [♠ Ahlfors 1950 is cited at several places ♠ p. 684: “On each smoothly bounded domain $\Omega \Subset \mathbb{C}$ with m boundary components there exists an inner function f with $\deg(f) = m$ [Ahl](=Ahlfors 1950 [17])²². The map $F(x) = (f(x), x) \in \mathbb{C}^2$ for $x \in \overline{\Omega}$ satisfies the hypothesis of Theorem 1.2 and hence Ω embeds in \mathbb{C}^2 . This is the theorem of Globevnik and Stensønes [GS](=1995).” ♠ p. 684: “We shall call a bordered Riemann surface \mathcal{R} hyperelliptic if its double is hyperelliptic. Such [an] \mathcal{R} has either one or two boundary components²³ and it admits a pair of inner functions (f, g) which embed $\text{int}\mathcal{R}$ in the polydisc U^2 such that $b\mathcal{R}$ is mapped to the torus $(bU)^2$; moreover, one of the two functions has degree $2g_{\mathcal{R}} + m$ and the other one has degree 2 (see [Ru1](=Rudin 1969 [723]) and sect. 2 in [Gou](=Gouma 1998 [297])). Thus \mathcal{R} is of class \mathcal{F} and we get:—**Corollary 1.3** *If \mathcal{R} is a hyperelliptic bordered Riemann surface then $\text{int}\mathcal{R}$ admits a proper holomorphic embedding in \mathbb{C}^2 . In particular, each torus with one hole embeds properly holomorphically into \mathbb{C}^2 .* ♠ p. 686: “**Comments regarding class \mathcal{F}** . It is proved in [Ahl, pp. 124–126](=Ahlfors 1950 [17]) that on every bordered Riemann surface \mathcal{R} of genus $g_{\mathcal{R}}$ with m boundary components there is an inner function f with multiplicity $2g_{\mathcal{R}} + m$ (although the so-called Ahlfors functions may have smaller multiplicity). A generic choice of $g \in A^1(\mathcal{R})$ gives an immersion

²²Of course for this purpose it would have been enough to cite Bieberbach 1925 [97].

²³This is true modulo the possibility of the planar case (i.e. Harnack maximal Schottky double).

- $F = (f, g): \mathcal{R} \rightarrow \overline{U} \times \mathbb{C}$ with at most finitely many double points (normal crossings). The main difficulty is to find g such that $F = (f, g)$ is injective on \mathcal{R} . We do not know whether such g always exists as Oka's principle does not apply in this situation (Proposition 2.2). ♠ Ahlfors 1950 is cited once more on p. 687 during the proof of Theorem 1.1 stating that there is no topological obstruction to holomorphic embeddability in \mathbb{C}^2 , in the following sense (p. 683) “**Theorem 1.1** *On each bordered surface \mathcal{R} there exists a complex structure such that the interior $\text{int}\mathcal{R} = \mathcal{R} \setminus \partial\mathcal{R}$ admits a proper holomorphic embedding in \mathbb{C}^2 .* ♠ p. 693: “**Remark.** As already mentioned, Ahlfors [Ahl](=1950) constructed inner functions of multiplicity $2g_{\mathcal{R}} + m$ on any bordered Riemann surface. Proposition 4.1 shows that such functions are stable under small perturbations of the complex structure. On the other hand this need not be true for the Ahlfors function f_p which maximizes the derivative at a given point $p \in \mathcal{R}$ since the degree of f_p may depend on p .”
- ◇ [28.09.12] maybe there is a somewhat more elementary approach to the main result (no topological obstruction) by looking at some real algebraic models in \mathbb{P}^2 or $\mathbb{P}^1 \times \mathbb{P}^1$, for instance taking a saturated pencil on the Gürtelkurve (cf. Gabard 2006 [255]) and removing an imaginary line of this pencil one gets an embedding of the bordered surface (half of the real quartic C_4) into \mathbb{C}^2 ♡13
- [167] M. Černe, *Nonlinear Riemann-Hilbert problem for bordered Riemann surfaces*, Amer. J. Math. 126 (2004), 65–87. A50 ♠ ♡??
- [168] M. Černe, M. Flores, *Generalized Ahlfors functions*, Trans. Amer. Math. Soc. 359 (2007), 671–686. [♠ a promising generalization of the Ahlfors function is given where the (static) unit-circle is replaced by a dynamical family $\{\gamma_z\}_{z \in \partial F}$ of Jordan curves enclosing the origin parametrized by the boundary of the bordered surface F] ♡5
- [169] S.S. Chern, P. Hartman, A. Wintner, *On isothermic coordinates*, Comment. Math. Helv. 28 (1954), 301–309. ♠ ♡??
- [170] E. Christoffel, *Ueber die Abbildung einer n -blättrigen einfach zusammenhängender ebenen Fläche auf einen Kreise*, Gött. Nachr. (1870), 359–369. [♠ the so-called Schwarz-Christoffel formula effecting the (one-to-one) conformal representation of a polygon upon the disc ♠ more precisely Schwarz 1869 [768] stated that the formula is easily generalized to the case of a multi-sheeted domain bounded by straight lines and containing branch points, and Christoffel considers here this generalization in some detail ♠ [07.10.12] can we connect the Schwarz-Christoffel theory with that of the Ahlfors map? try perhaps Kühnau 1967 [484]] ♡??
- [171] Y.-B. Chung, *The Ahlfors mapping function and an extremal problem in the plane*, Houston J. Math. 263 (1993), 263–273. ♠★ ♡??
- [172] Y.-B. Chung, *The Bergman kernel function and the Ahlfors mapping in the plane*, Indiana Univ. Math. J. 42 (1993), 1339–1348. ♠ Ahlfors mapping, Bergman kernel, etc.] ♡??
- [173] Y.-B. Chung, *Higher order extremal problem and proper holomorphic mapping*, Houston Math. J. 27 (2001), 707–718. A50 ♠ Ahlfors extremal problem (in the domain-case) with multiplicity (i.e. some first derivatives are imposed to be 0 at some base-point a)★★★[MR-OK] ♡??
- [174] Y.-B. Chung, *The Bergman kernel function and the Szegő kernel function*, J. Korean Math. Soc. 43 (2006), 199–213. ♠ the “Ahlfors map” of a smoothly bounded domain in the plane occurs several times through the paper] ♡0
- [175] C. Ciliberto, C. Pedrini, *Real abelian varieties and real algebraic curves*. In: Lectures in Real Geometry, F. Broglia (ed.), de Gruyter Exp. in Math. 23 (1996), 167–256. ♠ a modernized (neoclassical) account of the theories of Klein, Weichold and Comessatti] ♡??
- [176] K. Clancey, *Representing measures on multiply connected planar domains*, Illinois J. Math. 35 (1991), 286–311. ♠ what about Riemann surface? try Alpay-Vinnikov 200 [41], and also Nash 1974 [582]] ♡??
- [177] A. Clebsch, *Ueber diejenigen ebenen Curven, deren Coordinaten rationale Functionen eines Parameters sind*, J. Reine Angew. Math. 64 (1865), 43–65. ♠ coins the nomenclature genus, conceptually put in the limelight by Riemann (plus maybe Abel in some algebraic disguise)] ♡??
- [178] A. Clebsch, *Zur Theorie der Riemann'schen Flächen*, Math. Ann. 6 (1872), 216–230. AS60 [CHECK date for Ahlfors-Sario 1960, it is 1873?] ♡??

- [179] W.K. Clifford, *On the canonical form and dissection of a Riemann's surface*, Proc. London Math. Soc. 8 (1877), 292–304. [♠ not cited in Ahlfors-Sario 1960!] ♡??
- [180] R. Coifman, G. Weiss, *A kernel associated with certain multiply connected domains and its application to factorization theorems*, Studia Math. 28 (1966), 31–68. G78 [♠ p. 31: “Our main result is a generalization of the classical factorization theorem for function in the Nevanlinna class of the unit disc.”] ♡17
- [181] H. Comessatti, *Sulle varietà abeliane reali, I, II*, Ann. Mat. Pura Appl. 2 (1924), 67–106; 4 (1926), 27–71. ♡??
- [182] M. Coppens, G. Martens, *Linear pencils on real algebraic curves*, J. Pure Appl. Algebra 214 (2010), 841–849. A50 [♣ Ahlfors 1950 [17] is cited in the following fashion (p. 843): “Let X be a real curve of genus g with $s \geq 1$ real components and g_d^1 be a base point free pencil on X . Since $X(\mathbb{R}) \neq \emptyset$ the image curve X' of the morphism φ induced by the pencil is the rational real curve $\mathbb{P}_{\mathbb{R}}^1$. Assume that the fibre of φ at every real point of X' consists entirely of real points of X (or, what is the same, that φ separates conjugate points of $X_{\mathbb{C}}$: $\varphi(\sigma P) \neq \varphi(P)$ for any non-real point $P \in X_{\mathbb{C}}$); we call such a g_d^1 *totally real*. Then φ is a ramified covering of bordered real surfaces (in the topological sense, cf. [7, part 3](=Geyer-Martens 1977 [290])), and the induced covering $X(\mathbb{R}) \rightarrow X'(\mathbb{R}) \cong S^1$ is unramified. In particular, $s \leq d$. Since $X' = (\mathbb{P}_{\mathbb{C}}^1 \text{ mod conjugation})$, a half-sphere with boundary, is an orientable real surface it follows that also the Klein surface [of]²⁴ X must be orientable which implies $s \not\equiv g \pmod{2}$ (cf. [7, part. 2](=Geyer-Martens 1977 [290]))²⁵. Hence the assumed property that every divisor of X in the g_d^1 is entirely made up by real points puts severe restrictions on X . So we cannot expect to find such a pencil on every real curve. More precisely, by a result of Ahlfors [10](=1950 [17]) there is a totally real pencil of degree $g + 1$ on X iff the Klein surface X is orientable thus giving an interesting algebraic characterization of a topological property.”] ♡3
- [183] M. Coppens, *The separating gonality of a separating real curve*, arXiv (2011); or Monatsh. Math. 2012. [♣ the spectacular result is proven that all intermediate gonality compatible with Gabard's bound ($\leq r + p$) are realized by some compact bordered Riemann surface ♠ the work is written in the language of real algebraic geometry, especially dividing (or separating) curve and is a tour de force involving several techniques: Kodaira-Spencer deformation theory, Meis' bound and its phagocytose into modernized Brill-Noether theory, stable curves à la Deligne-Mumford (1969), geometric Riemann-Roch, Hilbert scheme, etc.] ♡0
- [184] A. F. Costa, M. Izquierdo, *On the connectedness of the locus of real Riemann surfaces*, Ann. Acad. Sci. Fenn. Math. 27 (2002), 341–356. [♠ a new proof is offered of a result due Buser-Seppälä-Silhol 1995 [130], stating the connectedness of the projection of the real moduli down to the complex one (upon forgetting the antiholomorphic involution) ♠ intuitively this means that any symmetric Riemann surface can be deformed so as to create a new symmetry and one can explore the full real moduli space (doing some jump when one switch the symmetry)] ♡??
- [185] R. Courant, *Über die Anwendung des Dirichletschen Prinzipes auf die Probleme der konformen Abbildung*, Math. Ann. 71 (1912), 141–183. G78 [♠ Diese Arbeit ist bis auf einige redaktionelle Änderungen ein Abdruck meiner Inauguraldissertation, Göttingen 1910.] ♡??
- [186] R. Courant, *Über eine Eigenschaft der Abbildungsfunktion[en] [sic!?] bei konformer Abbildung*, Gött. Nachr. (1914), 101–109. G78 [♠ this work is regarded by Gaier 1978 [260, p. 43] (and probably many others) as the first apparition of the length-area principle, which will be largely exploited by Grötzsch (Flächenstreifenmethode) and Ahlfors-Beurling (extremal length), etc., and which in the long run should obviously constitutes one of the key to the resolution of the Gromov filling conjecture ♠ uses also the area integral $\int \int |f'(z)|^2 dx dy$ like Bieberbach 1914 [92]] ♡??
- [187] R. Courant, *Über konforme Abbildung von Bereichen, welche nicht durch alle Rückkehrschnitte zerstückelt werden, auf schlichte Normalbereiche*, Math. Z. 3 (1919), 114–122. AS60 ♡??

²⁴Addition of Gabard, otherwise seems an abuse of notation.

²⁵This argument looks all right, yet it seems to the writer than one can easily dispense of the concept of orientability, by just using the separation effected by the existence of the map induced on imaginary loci, i.e. $X(\mathbb{C}) - X(\mathbb{R}) \rightarrow \mathbb{P}^1(\mathbb{C}) - \mathbb{P}^1(\mathbb{R})$.

- [188] R. Courant, D. Hilbert, *Methoden der mathematischen Physik. I*, Springer-Verlag, Berlin, 193X. (Reedited 1968) [♠ in connection cited e.g. in Simha 1975 [790] for an explicit formula for Jacobi theta function, the latter being involved in an explicit description of the Ahlfors map and the Carathéodory metric] ♡??
- [189] R. Courant, *Plateau's problem and Dirichlet's principle*, Ann. of Math. 38 (1937), 679–725. ♡??
- [190] R. Courant, *Remarks on Plateau's and Douglas' problem*, Proc. Nat. Acad. Sci. U.S.A. 24 (1938), 519–522. [♣ this is first place where the theorem of Bieberbach-Grunsky is reproved via Plateau, yet without citing them ♠ a more detailed proof is given in the next entry (Courant 1939 [191])] ♡??
- [191] R. Courant, *Conformal mapping of multiply-connected domains*, Duke Math. J. 5 (1939), 814–823. AS60, G78 [♣ the Bieberbach-Grunsky theorem is re-proved à la Plateau; now Bieberbach 1925 [97] and Grunsky 1937 [315] are cited as well as Riemann (as an oral tradition)] ♡??
- [192] R. Courant, *The existence of minimal surfaces of given topological structure under prescribed boundary condition*, Acta Math. 72 (1940), 51–98. [♠ specializing to the case of ambient dimension 2 might perhaps reprove a theorem like the Ahlfors circle map ♠ recall however that Tromba 1983 [837] seems to express doubts about the validity of Courant's proof, compare also Jost 1985 [402]] ♡??
- [193] R. Courant, M. Manel, M. Shiffman, *A general theorem on conformal mapping of multiply connected domains*, Proc. Nat. Acad. Sci. U.S.A. 26 (1940), 503–507. G78 [¶Result generalized in Schramm's thesis ca. 1990, cf. arXiv] ♡??
- [194] R. Courant, *The conformal mapping of Riemann surfaces not of genus zero*, Univ. Nac. Tucumán Revista A. 2 (1941), 141–149. AS60 [♠ detected only the 13.06.2012, via Ahlfors-Sario 1960 [22] ♠ alas Gabard could not find a copy of this article, and it seems unlikely that the article contains material not overlapping with previous and subsequent work by Courant, especially it is unlikely that the paper contains an existence of circle maps à la Ahlfors] ★ ♡??
- [195] R. Courant, *Dirichlet's principle, Conformal Mapping, and Minimal Surfaces*, with an appendix by M. Schiffer. Pure and appl. math. 3, New York, Interscience Publishers, 1950. AS60, G78 [♣ overlap much with the previous ref., but somehow hard to read due to its large content and mutatis mutandis type proof, in particular it is not clear if p. 183 contains another proof of the circle map of Ahlfors ♠ p. 169 contains a proof of the Kreisnormierung in finite connectivity] ♡??
- [196] R. Courant, *Flow patterns and conformal mapping of domains of higher topological structure*. In: *Construction and Applications of Conformal Maps*, Proc. of a Sympos. held on June 22–25 1949, Applied Math. Series 18, 1952, 7–14. ♡??
- [197] D. Crowdy, J. Marshall, *Green's functions for Laplace's equation in multiply connected domains*, IMA J. Appl. Math. (2007), 1–24. [♠ p. 13–14, contains beautiful pictures of the levels of the Green's function on some circular domains] ♡??
- [198] D. Crowdy, *Conformal mappings from annuli to canonical doubly connected Bell representations*, J. Math. Anal. Appl. 340 (2008), 669–674. [♠ p. 670, the Ahlfors map is briefly mentioned in connection with the work of Jeong-Oh-Taniguchi 2007 [398] on deciding when Bell's doubly-connected domain $A(r) = \{z \in \mathbb{C} : |z+z^{-1}| < r\}$ is conformally equivalent to the Kreisring $\Omega(\rho^2) = \{\zeta \in \mathbb{C} : \rho^2 < |\zeta| < 1\}$] ♡4
- [199] G. David, *Unrectifiable 1-sets have vanishing analytic capacity*, Rev. Mat. Iberoam. 14 (1998), 369–479. A47 [♠ p. 369: “**Abstract.** We complete the proof of a conjecture of Vitushkin that says that if E is a compact set in the plane with finite 1-dimensional Hausdorff measure, then E has vanishing analytic capacity iff E is purely unrectifiable (i.e., the intersection of E with any curve of finite length has zero 1-dimensional Hausdorff measure). [...]” ♠ [29.09.12] this is quite close to a solution of Painlevé's problem, but just not so due to the proviso $H^1(E) < \infty$, which cannot be relaxed for p. 370: “Actually Vitushkin's conjecture also said something about the case when $H^1(K) = +\infty$ ²⁶, but this part turned out to be false ([Ma1]=(Mattila 1986 [537]))”] ♡??
- [200] A. M. Davie, *Analytic capacity and approximation problems*, Trans. Amer. Math. Soc. 171 (1972), 409–414. [♠ a reduction is effected of the Denjoy conjecture (on removable sets lying on rectifiable curves) to the case where the supporting curve is C^1 , giving one of the ingredients toward the ultimate solution of Denjoy's conjecture

²⁶This is maybe a misprint and the “ K ” should be an E ?

- (compare Marshall [525]), where the last piece of the puzzle is the contribution of Calderón 1977 [131]] ♡??
- [201] A. M. Davie, B. Øksendal, *Analytic capacity and differentiability properties of finely harmonic functions*, Acta Math. 140 (1982), 127–152. [♠] ♡??
- [202] P. Davis, H. Pollak, *A theorem for kernel functions*, Proc. Amer. Math. Soc. 2 (1951), 686–690. [♠ parallel-slit mapping via Bergman kernel] G78 ♡??
- [203] K. de Leeuw, W. Rudin, *Extreme points and extremum problems in H_1* , Pacific J. Math. 8 (1958), 467–485. [♠ gives a characterization of the extreme points of the unit ball of the disc-algebra $H^1(\Delta)$, an analogue of which for the same algebra attached to a finite bordered Riemann surface will be given in Gamelin-Voichick 1968 [261] upon making use of the Ahlfors map or at least techniques closely allied to its existence-proof (as given by Ahlfors 1950 [17])] ♡??
- [204] A. Denjoy, ???, C. R. Acad. Sci. Paris 14? (1907), 258–260. AS60 [♠ yet another Denjoy conjecture (not to be confounded with that of the next entry) on the number of asymptotic values of entire functions of finite order ♠ formulated by Denjoy at age 21, it was solved by Ahlfors in 1928 (at age 21), 21 years after its formulation (arithmetical curiosity noticed by Denjoy)]★ ♡??
- [205] A. Denjoy, *Sur les fonctions analytiques uniformes à singularités discontinues*, C. R. Acad. Sci. Paris 149 (1909), 258–260. AS60 [♠ the following theorem is proved (or rather asserted since a gap was later located in proof) but Denjoy’s assertion turned out to be ultimately correct via Calderón 1977 [131] and Marshall [525]: “a closed set of positive length lying on a rectifiable arc is unremovable in the class of bounded analytic functions” ♠ this became the famous “Denjoy conjecture” ♠ partial positive results on it were obtained by Ahlfors-Beurling 1950 [18] in the case where the supporting arc is a segment (for this case they credits Denjoy himself) and then they extend the result to an analytic curve via conformal mapping ♠ Ivanov treated the case of curves slightly smoother than C^1 ♠ Davie 1972 [200] proved that it sufficed to assume the curve C^1 (i.e. the rectifiable case of Denjoy can be reduced to the C^1 case) ♠ then, Calderón 1977 [131] proved that the Cauchy integral operator, for C^1 curves, is bounded on L^p , $1 < p < \infty$ ♠ at this stage, Marshall [525] put the “touche finale” by writing a note explaining how Calderón implies Denjoy via classical results of Garabedian, Havinson and finishing the proof with Davie’s reduction to the C^1 -case, validating thereby Denjoy’s assertion announced ca. 7 decades earlier ♠ Calderón himself was first not aware of the relevance of his work to Denjoy’s (as I learned from Verdera 2004 [845, p. 29]), but in the acceptance speech for the Bôcher price (see Calderón 1979 [133]), Calderón mentions the solution to the Denjoy conjecture as one of the most significative application of his article]★ ♡??
- [206] H. Denneberg, *Konforme Abbildung einer Klasse unendlich-vielfach zusammenhängender schlichter Bereiche auf Kreisbereiche*, Ber. Verhd. Sächs. Akad. Wiss. Leipzig 84 (1932), 331–352. AS60, G78 [♠ a contribution to KNP]★ ♡??
- [207] J. Diller, *Green’s functions, electric networks, and the geometry of hyperbolic Riemann surfaces*, Illinois J. Math. 45 (2001), 453–485. [♠ p.456, Swiss cheese description of Hardt-Sullivan’s work (1989 [336]) on the Green’s function for a bordered Riemann surface given as a branched cover of the unit-disc ♠ so this Hardt-Sullivan work may possibly interact with the Ahlfors function] ♡1
- [208] P. G. Le Jeune Dirichlet, *Vorlesungen über die im umgekehrten Verhältniss des Quadrats der Entfernung wirkenden Kräfte*, herausgegeben von Dr. F. Grube, Leipzig, 1876. [♠ first version of DP available in print under (essentially) Dirichlet’s own pen, as Grube reproduced a Dirichlet Göttingen lecture (ca. 1856) ♠ alas Dirichlet’s formulation was a bit ill-posed, as came very apparent through the example of Prym 1871 [664] (compare also Elstrodt-Ullrich 1999 [222])]★ ♡??
- [209] J. Douglas, *Solution of the problem of Plateau*, Trans. Amer. Math. Soc. 33 (1931), 263–321. [♠ a new proof of RMT is given via Plateau, including the Osgood-Carathéodory refinement about the boundary behaviour of the Riemann map ♠ reduces the mapping problem to that of minimizing a functional (named after Douglas by now)] ♡??
- [210] J. Douglas, *Some new results in the problem of Plateau*, Amer. J. Math. 61 (1939), 590–608. ♡??
- [211] J. Douglas, *Minimal surfaces of higher topological structure*, Ann. of Math. (2) 40 (1939), 205–298. G78 ♡??

- [212] J. Douglas, *The most general form of the problem of Plateau*, Amer. J. Math. 61 (1939), 590–608. AS60 ♡??
- [213] R. G. Douglas, W. Rudin, *Approximation by inner functions*, Pacific J. Math. 31 (1969), 313–320. [p.314 the Ahlfors function (in the very trivial case of an annulus $D = \{z: r_1 < |z| < r_2\}$) is involved in the proof of the following theorem: the set of all quotients of inner functions is norm-dense in the set of unimodular functions] ♡??
- [214] B. Drinovec Drnovšek, *Proper discs in Stein manifolds avoiding complete pluripolar sets*, Math. Res. Lett. 11 (2004), 575–581. A50 [♠ Ahlfors 1950 [17] is cited] ♡??
- [215] B. Drinovec Drnovšek, F. Forstnerič, *Holomorphic curves in complex spaces*, Duke Math. J. 139 (2007), 203–252. [♠ Ahlfors 1950 [17] is cited in the bibliography, but apparently not within the text ♠ yet the connection with Ahlfors is evident in view of the following extract of the review of the paper: “Since the early 1990’s a series of papers, motivated mainly by works J. Globevnik and of Forstnerič, has been devoted to constructing holomorphic discs $f: \Delta \rightarrow M$ in complex manifolds that are proper. The article under review offers a culmination of the subject, lowering as much as possible the convexity assumptions, working on complex spaces with singularities, and “properizing” not only discs, but general open Riemann surfaces whose boundary consists of a finite number of closed Jordan curve. [...]”] ♡??
- [216] V. N. Dubinin, S. I. Kalmykov, *A majoration principle for meromorphic functions*, Sbornik Math. 198 (2007), 1737–1745. [p. 1740 a majoration principle is specialized to the Ahlfors function upon using the formula expressing the logarithm of the modulus of the Ahlfors function as a superposition of Green’s functions with poles at the zeros of the Ahlfors function] ♡??
- [217] B. A. Dubrovin, S. M. Natanzon, *Real two-zone solutions of the sine-Gordon equation*, Funct. Anal. Appl. 16 (1982), 21–33. [cited in Vinnikov 1993 [848] who gives simplified proof] ♡84
- [218] B. A. Dubrovin, *Matrix finite zone operators*, Contem. probl. math (Itogi Nauki i Techniki) 23 (1983), 33–78. [cited in Vinnikov 1993 [848, p. 478] for a proof of the rigid isotopy of any two smooth plane real curves having a deep nest (a result first established by Nuij [615])]★★★ ♡??
- [219] C. J. Earle, A. Marden, *On Poincaré series with application to H^p spaces on bordered Riemann surfaces*, Illinois J. Math. 13 (1969), 202–219. [♠ cited in Forelli 1979 [246], where the automorphic uniformization is employed to construct the Poisson kernel of a finite bordered Riemann surface, which in turn is involved in a new derivation of Ahlfors circle maps of controlled degree $\leq r + 2p$] ♡36
- [220] C. J. Earle, *On the moduli of closed Riemann surfaces with symmetries*, In: Advances in the theory of Riemann surfaces, Annals of Math. Studies 66, Princeton Univ. Press and Univ. of Tokyo Press, Princeton, NJ, 1971. [♠] ♡??
- [221] A. El Soufi, S. Ilias, *Le volume conforme et ses applications d’après Li et Yau*, Sémin. Théo. Spectrale Géom. (1983/84), 15pp. [♠ exploits the optimum $[(g+3)/2]$ gonality (Riemann-Brill-Noether-Meis) in the realm of spectral theory] ♡??
- [222] J. Elstrodt, P. Ullrich, *A real sheet of complex Riemannian function theory: a recently discovered sketch in Riemann’s own hand*, Historia Math. 26 (1999), 268–288. ♡??
- [223] *Encyclopedic Dictionary of Mathematics*, edited by Kiyosi Itô, Vol. II, Second Edition, English transl. (1987) of the third (Japanese) edition (1968) [sic!]. A50 [♠ on p. 1367 the result of Ahlfors 1950 [17] is quoted as follows (with exact source omitted but given on the next page p. 1368): “L. Ahlfors proved that a Riemann surface of genus g bounded by m contours can be mapped conformally to an at most $(2g + m)$ -sheeted unbounded covering surface of the unit disk.”] ♡??
- [224] F. Enriques, *Sul gruppo di monodromia delle funzioni algebriche, appartenenti ad una data superficie di Riemann*, Rom. Acc. L. Rend. 13 (1904), 382–384. AS60 [♠ just quoted to ponder a bit the severe diagnostic to be found in the next entry (i.e. Ahlfors was of course by no mean ignorant about the Italian algebro-geometric community)] ♡??
- [225] F. Enriques, O. Chisini, *Lezioni sulla Teoria Geometrica delle Equazioni e delle Funzioni Algebriche*, Zanichelli, Bologna, 1915–1918. [♠ appears to the writer as a clear-cut forerunner of both Bieberbach 1925 [93] and Wirtinger 1942 [891], as

- argued in Gabard 2006 [255, p.949] (cf. also Huisman 2001 [382] for a similar proof) ♠ actually Enriques-Chisini gives another derivation of Harnack’s bound (on the number of components of a real curve) via Riemann-Roch, but their argument supplies an immediate proof of the so-called *Bieberbach-Grunsky theorem* (cf. Bieberbach 1925 [97], Grunsky 1937 [315] and for instance A. Mori 1951 [570]), that is, the planar version of the Ahlfors map ♠ as far as I know this little anticipation of Enriques-Chisini over Bieberbach-Grunsky has never been noticed (or admitted?) by the function-theory community (say Bieberbach, Grunsky, Wirtinger, Ahlfors, A. Mori, Tsuji, . . .) showing an obvious instance of lack of communication between the analytic and geometric communities] ♡??
- [226] B. Epstein, *Some inequalities relating to conformal mapping upon canonical slit-domains*, Bull. Amer. Math. Soc. ?? (1947), ??-??. [♠] ♡5
- [227] B. Epstein, *The kernel function and conformal invariants*, J. Math. Mech. 7 (1958). [♠ quoted in Gustafsson 2008] ♡?? ★★★
- [228] G. Faber, *Neuer Beweis eines Koebe-Bieberbachschen Satzes über konforme Abbildung*, Sitz.-Ber. math.-phys. Kl. Bayer. Akad. Wiss. (1916), 39–42. [♠ related to the so-called area principle of Gronwall 1914/15 [307], Bieberbach 1916 [95]] ♡?? ★★★
- [229] G. Faber, *Über den Hauptsatz aus der Theorie der konformen Abbildung*, Sitz.-Ber. math.-phys. Kl. Bayer. Akad. Wiss. (1922), 91–100. G78 [♠ must be another proof of RMT ♠ regarded in Schiffer 1950 [751, p.313] as one of the originator of the method of *extremal length* (jointly with Grötzsch (1928) and Rengel 1932/33 [681]), cf. also the introductory remarks of Bieberbach 1957 [100] ♠ maybe another origin is Courant 1914 [186] (at least for the length-area principle), cf. e.g. Gaier 1978 [260]] ★★★ ♡??
- [230] H. M. Farkas, I. Kra, *Riemann surfaces*, Second Edition, Grad. Texts in Math. 71, Springer, 1992. (1st edition published in 1980) ♡??
- [231] P. Fatou, *Séries trigonométriques et séries de Taylor*, Acta Math. 30 (1906), 335–400. [♠ influenced by Lebesgue, and will in turn influence F. Riesz (so called Fischer-Riesz theorem)] ♡??
- [232] J. Fay, *Theta functions on Riemann surfaces*, Lecture Notes in Math. 352, Springer, 1973. A47, A50 [♠ cite Ahlfors 1950 [17] and write down explicit formulas for the Ahlfors function (at least in the planar case) ♠ gives perhaps another proof of Ahlfors 1950 (cf. Alpay-Vinnikov 2000 [41]) but this hope is probably not borne out (Fay probably recovers the Ahlfors circle map only in the planar case) ♠ Ahlfors 1950 [17] is cited thrice in this booklet ♠ on p.108 (just for the double) ♠ on p.116: “It has been proved in [3, p.126](=Ahlfors 1950 [17]) that there are always unitary functions with exactly $g + 1$ zeroes *all* in R ; and when R is a planar domain, it is shown in Prop.6.16 that $S_{0,\dots,0} \cap \Sigma_a$ is empty for $a \in R$ and that the unitary functions holomorphic on R with $g + 1$ zeroes are parametrized by the torus S_0 .” [Added by Gabard [10.09.12]: of course one can wonder how much of this is anticipated in Bieberbach 1925 [97]] ♠ p.129: “Using this result, a solution can be given to an extremal problem for bounded analytic functions as formulated in [3, p.123](=Ahlfors 1950):” where the Ahlfors function is expressed in terms of the theta function and the prime form, yet it should be noted that unfortunately at some stage Fay’s exposition is confined to the case of planar domains ♠ somewhat earlier in the text (in a portion not yet confined to the planar case) we read on p.114: “The spaces S_μ parametrize the generic unitary functions on C with the minimal $(g + 1)$ number of zeroes:”, maybe this claim of minimality is erroneous as it could be incompatible with Gabard 2006 [255], and even if the latter is incorrect there is basic experimental evidence violating this minimality claim on the bound $g + 1$, compare our remarks after Alpay-Vinnikov 2000 [41]] ♡853
- [233] S. I. Fedorov, *Harmonic analysis in a multiply connected domain, I*, Math. USSR Sb. 70 (1991), 263–296. [♠ credited by Alpay-Vinnikov 2000 [41, p.240] (and also Yakubovich 2006 [893]) for another existence-proof of the Ahlfors map (at least for planar domains), cf. p.271–275 ♠ on p.272 it is remarked that one cannot prescribe arbitrarily the n zeroes of a circle-map on an n -connected domain of minimum degree n as follows: “Unfortunately we cannot prescribe n points on Ω_+ arbitrarily in such a way that their union will be the set of zeros of an n -sheeted inner function θ of the form (3), since the zeros of an n -sheeted function θ must satisfy the rather opaque condition $\sum_{k=1}^n \omega_s(z_k)$, $s = 1, \dots, n - 1$, where ω_s is the harmonic measure of the boundary component Γ_s .” ♠ [26.09.12] it seems

- to the writer (Gabard) that this condition already occurs (at least) in A. Mori 1951 [570] ♣ it would be interesting to analyze carefully Fedorov's argument (or Mori's) to see if it can be extended to the positive genus case (this is perhaps already done in Mitzumoto 1960 [564]) ♠ p.272 desideratum of a constructive procedure for building all n -sheeted inner functions on an n -connected domain, which is answered on p.274 via "Theorem 1. Let z_1, \dots, z_n be arbitrary points with $z_k \in \Gamma_k$, $k = 1, \dots, n$. Then there exist positive numbers $\lambda_1, \dots, \lambda_n$ such that the function $w = \int_{z_\Gamma}^z \sum_{j=1}^n \lambda_j \nu_{z_j}$, $z_\Gamma \in \Gamma$, $z_\Gamma \neq z_j$, $j = 1, \dots, n$, is a single-valued n -sheeted function on $\hat{\Omega}$, real-valued on Γ , with positive imaginary part on Ω_+ . The function $\theta = \frac{w-i}{w+i}$ is an n -sheeted inner function." ♠ of course in substance (or essence) this is nothing but what Japaneses calls the Bieberbach-Grunsky theorem (cf. Mori 1951 [570] or Tsuji 1956 [840]) ♡??
- [234] J. L. Fernandez, *On the existence of Green's function in Riemannian manifolds*, Proc. Amer. Math. Soc. 96 (1986), 284–286. [♠] ♡??
- [235] T. Fiedler, *Eine Beschränkung für die Lage von reellen ebenen algebraischen Kurven*, Beiträge Algebra Geom. 11 (1981), 7–19. [♠ the eminent DDR student of Rohlin, who seems to have been the first to notice the simple fact the orientation preserving smoothings conserve the dividing character of curves] ♡??
- [236] S. D. Fisher, *Exposed points in spaces of bounded analytic functions*, Duke Math. J. 36 (1969), 479–484. A50 [♠ cite Ahlfors 1950 [17] and the following result is obtained: the exposed points of the algebras $A(\bar{R})$ (resp. $H^\infty(R)$) are uniformly dense in the unit sphere of the respective space] ★★★ ♡8
- [237] S. D. Fisher, *Another theorem on convex combination of unimodular functions*, Bull. Amer. Math. Soc. ?? (1969), 1037–1039. [♠ finite Riemann surfaces, inner functions and it is proved that the closed convex-hull of the inner functions is the unit ball (for the sup norm) of the algebra $A(R)$ of analytic functions continuous up to the border ♠ this is proved via an interpolation lemma due to Heins 1950 [358], which is closely allied to the Ahlfors function (plus maybe some Garabedian) ♠ this is stated as: "Lemma 1: Let z_1, \dots, z_N be distinct points of R (=a finite Riemann surface) and let h be an analytic function on R bounded by 1. Then there is an inner function f (i.e. of modulus one on the boundary ∂R) in $A(R)$ with $f(z_j) = h(z_j)$, $j = 1, \dots, N$." ♠ one can take $h \equiv 1$ then f looks strange for it maps inner points to the boundary point 1, yet still $f = 1$ works ♠ the question is of course whether this reproves Ahlfors 1950, but this looks unlikely especially as no control is supplied on the degree, but see Heins 1950 [358], which suitably modified should recover Ahlfors result by controlling appropriately the bound involved] ♡??
- [238] S. D. Fisher, *On Schwarz's lemma and inner functions*, Trans. Amer. Math. Soc. 138 (1969), 229–240. A47, G78 [♠ after Havinson 1961/64 [345] and Carleson 1967 [155], study the Ahlfors map for domains of infinite connectivity ♠ subsequent ramifications in Röding 1977 [709], Minda 1981 [556], Yamada 1983–92 [895, 896]] ♡24
- [239] S. D. Fisher, *The moduli of extremal functions*, Michigan Math. J. 19 (1972), 179–183. A47 [♠ the Ahlfors function of a domain (supporting nonconstant bounded analytic functions) is shown to be of unit modulus on the Šilov boundary of H^∞] ♡10
- [240] S. D. Fisher, *Non-linear extremal problems in H^∞* , Indiana Univ. Math. J. 22 (1973), 1183–1190. A50 [♠ p.1183/7 speaks of the "Ahlfors-Royden extremal problem" ♠ the author explains that in Ahlfors extremal problem the class of competing functions is convex, explaining uniqueness of the solution and studies a variant of the problem with a side-condition amounting to require "no other zeros" which leads to a non-convex problem lacking uniqueness ♠ p.1187/88, grasp of the geometric quintessence of Ahlfors' argument: "By a theorem of Ahlfors [A1; §4.2] there is a set of $r + 1$ points p_j in Γ such that if v_i is the period vector of a unit mass at p_j , then v_0, \dots, v_r form the vertices of a simplex in \mathbb{R}^r which contains the origin as an interior point."] ♡??
- [241] S. D. Fisher, *Function theory on planar domains*. A second course in complex analysis. Pure and Applied Mathematics (New York). A Wiley-Interscience Publication. John Wiley & Sons, Inc., New York, 1983. ♡179
- [242] S. D. Fisher, D. Khavinson, *Extreme Pick-Nevalinna interpolants*, Canad. J. Math. 51 (1999), 977–995. [♠ Ahlfors function (in the domain case only), its connection with Blaschke products and the Green's functions, Pick bodies (jargon of Cole, Lewis, Wermer) and interpolation] ♡??

- [243] H. Florack, *Reguläre und meromorphe Funktionen auf nicht geschlossenen Riemannschen Flächen*, Schr. Math. Inst. Univ. Münster no. 1 (1948), 34 pp. AS60 [♠ cited also in Royden 1962 [716] (yet not within the text?) and briefly summarized in a ICM talk ca. 1954 of Behnke]★★★ ♡??
- [244] F. Forelli, *Bounded holomorphic functions and projections*, Illinois J. Math. 10 (1966), 367–380. [♠ the universal covering method is employed to derive another proof of the corona theorem for interiors of compact bordered Riemann surfaces, relativizing thereby the ubiquitousness of the Ahlfors function given in Alling 1964 [34] ♠ Forelli’s proof uses the following tools: • (p.368) “measure and Hilbert space theory, and the harmonic analysis that goes with the Hilbert space H^2 ” • (p.373, 374) existence of analytic differentials with prescribed periods on the Schottky double (via Pfluger 1957 [640]) • Beurling’s invariant subspace theorem (p.366), but this can be dispensed in the compact bordered case by appealing to a holomorphic function continuous up to the border “whose zeros are the critical point of the Green’s function with pole at $t(0)$ ” (p.377)] ♡45
- [245] F. Forelli, *Extreme points in $H^1(R)$* , Canad. J. Math. 19 (1967), 312–320. [♠]★★ ♡??
- [246] F. Forelli, *The extreme points of some classes of holomorphic functions*, Duke Math. J. 46 (1979), 763–772. [♠ study of the extreme points of the family of analytic functions with positive real part on a given finite Riemann surface normalized to take the value 1 at a given point ♠ the paper Heins 1985 [363] supplements the results of Forelli by precise characterizing results for the case where the genus of S is positive ♣ [11.10.12] in fact this Forelli paper is a jewel (that I was only able to read today=[11.10.12], shame on me!) ♣ despite presenting itself too humbly as a modest appendix to Heins 1950 [358], its main result (Theorem 3.2, p.766) gives the chain of inclusions $N_q(W, \zeta) \subset \partial N(W, \zeta) \subset \bigcup_q^{2p+q} N_k(W, \zeta)$, which readily implies a new proof of circle maps of degree $\leq 2p + q$ (like Ahlfors 1950 [17]). To understand this point, first recall Forelli’s notation: \overline{W} is a compact bordered Riemann surface of genus p with q contours, W is of course its interior; $N(W, \zeta)$ is the class of holomorphic functions f on W with positive²⁷ real part ($\operatorname{Re} f > 0$) normalized by $f(\zeta) = 1$ at some fixed $\zeta \in W$ (it is easily verified that $N(W, \zeta)$ is convex and compact in the compact-open topology) [notion due to Arens/Fox, if I remember well???]; the symbol ∂ used above refers *not* to the boundary but to the set of all extreme points of a convex body, i.e. those points of the body not expressible as convex (=barycentric) combination $tx + (1 - t)y$ ($t \in [0, 1]$) of two (distinct) points x, y of the body. This is also the smallest subset of the body permitting its complete reconstruction via the convex-hull operation; finally $N_k(W, \zeta)$, for $k > 0$ a positive integer, is the subclass of $N(W, \zeta)$ consisting of functions that cover the right half-plane k times. ♣ having explained notation, it is plain to deduce Ahlfors’ result. Indeed from the cited properties of convexity and compactness for $N(W, \zeta)$ one deduces (via Krein-Milman) existence of extreme points, i.e. $\partial N(W, \zeta) \neq \emptyset$ (this issue is not explicit in Forelli’s paper, but so evident that it is tacit, cf. e.g., Heins’ commentary in 1985 [364, p.758]: “My paper [7](=Heins 1950 [358]) showed the existence of minimal positive harmonic functions on Riemann surfaces using elementary standard normal family results without the intervention of the Krein-Milman theorem²⁸ and gave applications to qualitative aspects of Pick-Nevalinna interpolation on Riemann surfaces with finite topological characteristics and nonpointlike boundary components.” ♣ Now Forelli’s second inclusion implies immediately the desideratum (existence of circle maps of degree d such that $q \leq d \leq 2p + q$) ♠ note of course that the first set of the string, that is $N_q(W, \zeta)$, can frequently be empty. Consider e.g. \overline{W} be one-half of Klein’s Gürtelkurve²⁹, that is any real plane smooth quartic, $C_4 \subset \mathbb{P}^2$, with two nested ovals, then $q = 2$ but quartics and more generally smooth plane curves of order m are known to be $(m - 1)$ -gonal). For an even simpler example, consider any bordered surface W with only one contour ($q = 1$) and of positive genus

²⁷Of course the notation P instead of N could have been more appealing, yet Forelli had obviously to reserve the letter P for “probability measures”, to enter soon the arena! So imagine the “ N ” standing for non-negative real parts (which is incidentally more correct if we let penetrate the boundary behavior in the game).

²⁸Of course behind both techniques there is the paradigm of compactness in suitable function spaces, first occurring as a such in the related Hilbert’s investigation on the Dirichlet principle (add maybe Arzelà-Vitali to be fair, cf. e.g. Zaremba 1910 [908]). So everything started to be solid after Hilbert 1900, and Montel 1907, etc.

²⁹This is German for belt (=ceinture) in French.

$p > 0$, then there cannot be a circle-map of degree $d = q = 1$ for a such would be an isomorphism (by the evident branched covering features of analytic maps), violating the topological complexity prompted by $p > 0$ ♠ several questions arise naturally from Forelli's work. A first one is the perpetual question about knowing if the method can recover the sharper bound $p + q$ ($\approx r + p$) of Gabard 2006 [255]. (Here and below \approx refers to notational conversion from Forelli's notation to the one used in the present paper). Again it is our belief that the ultimate convex geometry reduction of the problem (already explicit in Ahlfors) could be slightly improved so as to do this (compare below for more details). Another problem is to understand the distribution of degrees corresponding to extreme points of Forelli's convex body $\partial N(W, \zeta)$ (maybe call it the Carathéodory-Heins-Forelli body to reflect better the historical roots of the technique, brilliantly discussed in Heins 1985 [364]). For instance is the least degree half-plane map (equivalently circle map) always an extreme point, as the nebulous principle of economy (\approx least effort) could suggest? (Nature always tries to relax itself along an equilibrium position necessitating the minimum existential stress-tensor!?) Finally one would like to see the connection between Ahlfors extremals and the extreme points of Heins-Forelli. Of course there is a little tormenting routine to switch from the one to the others via a Möbius-Cayley transformation from the disc to the half-plane. Yet loosely it seems that Ahlfors functions are a subclass of the extreme points, for they former depend on less parameters. For instance as noted by Forelli in the special planar case $p = 0$, the above chain of inclusions collapses to give the clear-cut equation $\partial N(W, \zeta) = N_q(W, \zeta)$ characterizing the set of extreme points in, essentially, purely topological terms. Yet the Bieberbach-Grunsky theorem (1925 [97], or A. Mori [570]) tell us that circle maps are in this case ($p = 0$) fairly flexible insofar that we can preassign one point on each contour and find a circle map (of degree q) taking those points over the same boundary point³⁰. Hence for large values of q such minimal degree circle maps depends on essentially q real parameters, whereas for Ahlfors maps we can only specify the basepoint undergoing maximum distortion (hence just 2 real free parameters). ♣ Finally some words about Forelli's method of proof: It uses some "functional analysis" in the form of measure theory. Specifically Radon measures are mentioned, and a proposition permitting to express extreme points of a body B specified by n linear integral conditions as combination of $(n + 1)$ extreme probability measures (cf. Prop. 2.1 for the exact statement identified as dating back to Rosenbloom 1952 [?], [but in geometric substance a similar lemma is already employed in Heins 1950 [358], as well as in Ahlfors 1950 [17]]). This is then specialized to the case where the space X is the boundary of the bordered surface ∂W ³¹, and the n conditions amounts essentially to ask the vanishing of the periods along representatives of a homology basis of \overline{W} , consisting of $n := 2p + (r - 1)$ cycles. The crucial potential theory is done via the Poisson integral inducing a bijective map $\#: P(\partial W) \rightarrow h_+(W, \zeta)$ between probability measures on the boundary and positive harmonic functions normalized by taking ζ to 1. It is defined by $\mu^\#(w) = \int_{\partial W} Q(w, y) d\mu(y)$, where $Q(w, y)$ is the Poisson kernel of W ($w \in W, y \in \partial W$). Now to find and describe (extreme) half-plane maps in $\partial N(W, \zeta)$, we are reduced via the above correspondence to a special set B of measure verifying n integral equations. On applying (Rosenbloom's) proposition, the measure μ defined by $\mu^\# = \text{Ref}$ where $f \in N(W, \zeta)$ is decomposed as a convex sum (i.e. with positive coefficient t_k) of Dirac measures $\mu = \sum_1^m t_k \delta_k$ concentrated at some boundary points $y_k \in \partial W$, where $m \leq n + 1$. It follows by calculation (Poisson+Dirac's trick) that $\text{Ref}(z) = \sum_1^m t_k Q(w, y_k)$ (because integrating a function against the Dirac measure concentrated at some point just amounts evaluating the function at that point). Of course notice at this stage that the Poisson function $Q(w, y)$ is nothing else than the Green function with pole pushed to the boundary (so the object that we manipulated during our attempt to decipher Ahlfors' proof). At this stage the proof is essentially finished. ♠ as a matter of details Forelli further discuss the construction of the Poisson kernel taking inspiration from techniques of Earle-Marden 1969 [219], using primarily the uniformization of Poincaré-Koebe. To sum up Forelli's is able to reprove existence of circle maps but needs uniformization, admittedly in a simple finitistic context. Of course Ahlfors proof seems to avoid this dependance, which is anyway perhaps

³⁰This is indeed quite trivial to see, if we know the Riemann(-Roch) inequality, cf. e.g. Gabard 2006 [255].

³¹Of course any geometric topologist (or reasonable being) could find the writing $\partial \overline{W}$ semantically more precise, yet we follow Forelli's alleged notation.

not so dramatic. ♠ The latter issue should of course not detract us from the geometrical main aspect of the proof. First Forelli's proof uses heavily a little yoga between measures and harmonic functions converting the one to the others via the Poisson integral. This technique involves so Poisson, then Stieltjes and finally the so-called Herglotz-Riesz (1911 [371]) (representation) theorem, a special incarnation of Fischer-Riesz (1907). Of course the yoga in question boils down to the Dirichlet principle when the measure has continuous density so that Herglotz-Riesz is just the Dirichlet problem enhanced by Lebesgue integration. Of course all this is beautiful, yet probably not fully intrinsic to the problematic of half-plane (or the allied circle) maps, which can probably be arrived upon via more classical integration theories (and in particular the classical Dirichlet problem, plus the allied potential functions, Green's, Poisson's or whatever you like to call them). I personally used the term Red's function (somewhere in this text) as colorful contrast to evergreens tree, honoring George Green, but of course Poisson's function might be historically more accurate. (After all, human beings descend from fishes rather than vegetables, and Green himself quotes of course Poisson, and Dirichlet was a Poisson student). ♣ but now the key issue would be to penetrate even deeper in the geometry of Forelli's proof. Again the hearth of the problem is the possibility of expressing a certain point as convex combination of *at most* $(n + 1)$ points; in Forelli's treatment cf. Prop. 2.1, where however the "at most" proviso is not explicit but implicitly used later in the proof of Theorem 3.2. Like in our attempt to push Ahlfors proof down to recover Gabard's bound, we believe that a better inspection of this convex geometry could corroborate the possibility of locating half-plane maps of lower degree. The situation we have in mind is the following (to which we were reduced by reading carefully Ahlfors 1950 [17]): suppose we are given in $\mathbb{R}^n (n \approx g)$ a collection of $q \approx r$ curves forming a balanced configuration (all \approx signs just amounts to conversion from Forelli's notation to the one used in the present text), in the sense that the convex hull encloses the origin, then it is of course possible to express the origin as convex sum of $\leq n + 1 \approx g + 1$ point (recovering thereby Ahlfors' result). However it must be also possible to be more economical by using a more special, lower-dimensional simplex, able to cover the origin with a smaller quantity of points. We hope that this is a problem of pure (Euclid/convex/Minkowski) geometry (perhaps involving some topological tricks like in the Borsuk-Ulam (ham-sandwich) theorem, which can concomitantly be proved via more simple center of masses considerations, cf. e.g. Fulton's book on "topology"). Alas I can only try to convince the reader by looking at the (very special) case where $n \approx g = 2$ coming (via $g = 2p + (r - 1)$) from the values $p = 1, r = 1$. Then we have one balanced circle in the plane \mathbb{R}^2 . If we follow Ahlfors, we just have the plain remark that there is $g + 1 = r + 2p = 1 + 2 \cdot 1 = 3$ points spanning a simplex covering the origin (which is trivial for dimensional reason), however it is evident that a more special and lucky constellation (Stonehenge alinement) of two points situated on the topological circle (Jordan curve) corresponding to the contour of the bordered surface, suffice to cover the origin with a 1-simplex, giving existence of a circle map of degree 2, like the $r + p$ bound predicted in Gabard 2006 [255] ♠ of course all we are saying does not detract the possibility that the extreme points studied by Forelli always contain an element landing in the highest possible degree $2p + q \approx 2p + r = g + 1$ ♣4

[247] F. Forstnerič, E. F. Wold, *Bordered Riemann surfaces in \mathbb{C}^2* , J. Math. Pures Appl. 91 (2009), 100–114. [♠ reduction of the big problem of embedding open Riemann surface in the affine plane to that of embedding compact bordered surfaces, which looks tractable, yet apparently completely out of reach] ♣9

[248] W. F. Fox, *Harmonic functions with arbitrary singularity*, Pacific J. Math. (1961), 153–164. [♠ discusses and rederives old results of Schwarz 1870, Koebe while pointing out to the developments made by Sario ♠ p. 153 probably corroborates the intuition that the solvability of the Dirichlet principle on a compact bordered Riemann surface was first treated by Schwarz 1870] ♣??

[249] A. Fraser, R. Schoen, *The first Steklov eigenvalue, conformal geometry, and minimal surfaces*, Adv. in Math. 226 (2011), 4011–4030. A50 [♣ applies Ahlfors 1950 [17] (and even Gabard 2006 [255]) to spectral theory, especially first Steklov eigenvalue. For higher eigenvalues, cf. Girouard-Polterovich 2012 [291], and for Dirichlet-Neumann eigenvalues, cf. Gabard 2011 [256].] ♣14

[250] I. Fredholm, *Sur une classe d'équations fonctionnelles*, Acta Math. 27 (1903), 365–390. [♠ early influence of Abel (1823), then Neumann's approach to the Dirich-

- let problem and Volterra (1896) where Neumann’s method was successfully applied to an integral equation] ♡285
- [251] G. Fubini, *Il Principio di minimo e teoremi di esistenza per i problemi al contorno relativi alle equazioni alle derivate parziali di ordini pari*, Rend. Circ. Mat. Palermo (1907). [♠ cited in Zaremba 1910 [908] as another extension (beside Beppo Levi 1906 [505] and Lebesgue 1907 [499]) of Hilbert’s resurrection of the Dirichlet principle] ♡??
- [252] B. Fuchs, *Sur la fonction minimale d’un domaine, I, II*, Mat. Sbornik N. S. 16 (58) (1945); 18 (60) (1946). [♠ quoted in Lehto 1949 [500] and consider the problem of least momentum, i.e. minimizing $\iint_B |f(z)|^2 d\omega$ under the side-condition $f(t) = 1$ at some interior point] ★★★[part I OK, part II still not found] ♡14
- [253] A. Gabard, *Topologie des courbes algébriques réelles: une question de Felix Klein*, L’Enseign. Math. 46 (2000), 139–161. [♠ furnish a complete answer to a question raised by Klein as a footnote to his Coll. Papers, using an inequality due to Rohlin 1978 [706]. Previous (unpublished) work on the same question due to Kharlamov-Viro in the Leningrad seminar of topology supervised by V. A. Rohlin. Confirms incidentally a desideratum of Gross-Harris 1981 [308].] ♡1
- [254] A. Gabard, *Sur la topologie et la géométrie des courbes algébriques réelles*, Thèse, Genève, 2004. A50 [♣ includes the improved bound $r+p$ upon the degree of a circle map of a membrane of genus p with r contours. Up to minor redactional change this is the same as the next entry Gabard 2006 [255]] ♡1
- [255] A. Gabard, *Sur la représentation conforme des surfaces de Riemann à bord et une caractérisation des courbes séparantes*, Comment. Math. Helv. 81 (2006), 945–964. A50 (This result also appeared previously in the Ph. D. Thesis of the author published in 2004, cf. the previous item.) [♣ proposes an improved bound upon Ahlfors 1950 [17], as discussed in the previous item ♠ for an update regarding the question about the sharpness of the bound so obtained see Coppens 2011 [183] ♠ [03.10.12] all this is fairly good yet a certain discrepancy with Ahlfors viewpoint is annoying and much remains to be clarified ♠ [03.10.12] further one can wonder if there is not a Teichmüller-theoretic proof of the existence of such circle maps, paralleling that of Meis 1960 [541] in the case of closed surfaces, and conversely one can of course wonder if Meis cannot be proved via the topological method used in the present entry (Gabard 2006 [255])] ♡6
- [256] A. Gabard, *Compact bordered Riemannian surfaces as vibrating membranes: an estimate à la Hersch-Yang-Yau-Fraser-Schoen*, arXiv 2011. A50 [♣ inspired by Fraser-Schoen 2011 [249], this adapts Hersch 1970 [372] (isoperimetric property of spherical vibrating membranes) to configurations of higher topological structure using the Ahlfors circle map with the bound of Gabard 2006 [255] ♠ notice an obvious (but superficial) connection with Gromov’s filling area conjecture (FAC) (1983 [305]) positing the minimality of the hemisphere among non-shortening membranes, hence it would be fine that conformal geometry/transplantation—enhanced perhaps by Weyl’s asymptotic law for the high vibratory modes (out of which we can ‘hear’ the area of the drum)—affords a proof, either geometric or acoustic, of FAC. This would maybe be a spectacular application of the Ahlfors map, or maybe some allied conformal maps, e.g. that of Witt-Martens [892], [526], for non-orientable membranes. Recall indeed Gromov’s trick of cross-capping (à la von Dyck) the boundary contour of the membrane reduces the filling area problem (in genus zero) to Pu’s systolic inequality for the projective plane] ♡0
- [257] D. Gaier, *Konforme Abbildung mehrfach zusammenhängender Gebiete durch direkte Lösung von Extremalproblemen*, Math. Z. 82 (1963), 413–419. G78 [♠ what sort of maps via which (extremal) method? Essentially the PSM via the Ritz-Ansatz (ca. 1908), à la Bieberbach-Bergman (1914/22), plus Nehari’s 1949 integral representation of such slit mappings] ♡??
- [258] D. Gaier, *Konstruktive Methoden der konformen Abbildung*, Ergebnisse d. Angew. Math. 3, Springer, Berlin, 1964. G78 [♠ Chap. III discusses in details the extremal properties of the Riemann mapping for a plane simply-connected region (distinct of \mathbb{C}), namely that the range of the map normalized by $f'(z_0) = 1$ has minimal area (first in Bieberbach 1914 [92]) or that the boundary of the range has minimal length (probably first in Szegő 1921 [818]) ♠ this material was also presented (in book format) by Julia 1931 [406]]★ ♡283
- [259] D. Gaier, *Über ein Flächeninhaltsproblem und konforme Selbstabbildungen*, Rev. Roumaine Math. Pures Appl. 22 (1977), 1101–1105. [♠ cited for the same reasons

as the next item and complement some details of it (especially in the sharpness of cross-references)] ♡2

- [260] D. Gaier, *Konforme Abbildung mehrfach zusammenhängender Gebiete*, Jber. d. Dt. Math.-Verein. 81 (1978), 25–44. [♠ p. 34–35, §C, brilliant proof (of a fact discovered and briefly handled by Grötzsch 1931 [alas no precise cross-ref.]) via his *Flächenstreifenmethode* that “the” (non-unique!) map minimizing the area integral $\int \int |f'(z)|^2 d\omega$ (à la Bieberbach 1914 [92]–Bergman[n] 1922 [75], but extended to the multiply-connected setting) under the schlichtness proviso (and the normalizations $f(z_0) = 0, f'(z_0) = 1$) maps the domain upon a circular slitted disc (with concentric circular slits centered about the origin) ♠ Gaier’s proof is based upon a Carleman isoperimetric property of rings relating the modulus to the area enclosed by the inner contour, plus Bieberbach 1914 [92] (first area theorem) to the effect that a schlicht normed map ($f'(a) = 1$) from the disc inflates area, unless it is the identity ♣ a natural (naive?) question of the writer ([13.07.12]) is what happens if we relax schlichtness of the map? Do we recover an Ahlfors circle map? Try maybe to get the answer from the entry Garabedian-Schiffer 1949 [275]] ♡??
- [261] T. W. Gamelin, M. Voichick, *Extreme points in spaces of analytic functions*, Canad. J. Math. 20 (1968), 919–928. A50 [♠ Ahlfors 1950 [17] is quoted several times through the paper, the most relevant being ♣ p. 926: “According to [1, § 4.2], there exist $r + 1$ ($r = g$ in our notation) points w_1, \dots, w_{r+1} on bR such that if B_j is the period vector of the singular function T_j corresponding to a unit point mass at w_j , then B_1, \dots, B_{r+1} are the vertices of a simplex in \mathbb{R}^T which contains 0 as an interior point.” ♣ This is indeed the geometric heart of Ahlfors’ existence proof of a circle map of degree $\leq g + 1 = r + 2p$ ♠ [28.09.12] the obvious game is whether one can lower the number of w_j to recover the degree predicted in Gabard 2006 [255] ♠ as to the content of this entry, it is involved with an extension of the de Leeuw-Rudin (1958 [203]) characterization of the extreme points of the unit ball of the disc-algebra $H^1(\Delta)$ as the outer functions of norm 1, and as usual this is obtained upon appealing to the Ahlfors map, or techniques closely allied to its existence-proof] ♡14
- [262] T. W. Gamelin, *Embedding Riemann surfaces in maximal ideal spaces*, J. Funct. Anal. 2 (1968), 123–146. [♠ p. 130: “Let R be a finite bordered Riemann surface with boundary Γ . Let A be the algebra of functions continuous on $R \cup \Gamma$ and analytic on R . Let φ be the evaluation at some point z_0 of R . Then the harmonic measure for z_0 on Γ is a unique Arens-Singer measure for ϕ on Γ . The spaces N_c consists of the boundary values along Γ of the analytic differentials on the doubled surface of R , the so-called Schottky differentials of R . The space N_c is finite-dimensional.” ♠ p. 133: “Since P admits a finite-sheeted covering map over $\{|\lambda| < 1\}$, P must be one-dimensional.” ♠ it is not clear (to Gabard) if this Gamelin argument makes tacit use of the Ahlfors map] ♡??
- [263] T. W. Gamelin, *Uniform algebras*, Prentice Hall, 1969. [♠ p. 195–200, analytic capacity as the first coefficient in the Laurent expansion of the Ahlfors function ♠ p. 197, existence and uniqueness of the Ahlfors function for a general open set in the plane ♠ p. 198, proof of the following convergence property of the Ahlfors function f_E of a compact plane set E (meaning the one, centered at ∞ , of the outer component of E , i.e. the component of the complement of E containing ∞): if E_n is decreasing sequence of compacta with intersection E , and f_n be the Ahlfors functions of E_n , then f_n converge to f uniformly on compact subsets of the outer component of E , and the corresponding analytic capacities converge $\gamma(E_n) \rightarrow \gamma(E)$ ♠ [21.09.12] this reminds perhaps one the famous conjecture (e.g. of Bing) about knowing if a descending sequence of plane (topological) discs must necessarily converge to a compactum satisfying the fixed-point property, even when the latter has the ugliest possible ‘dendrite’ shape ♠ one may wonder if function theory, especially boosted version of RMT, could crack the problem (this is of course just a naive challenge)]★ ♡??
- [264] T. W. Gamelin, *Localization of the corona problem*, Pacific J. Math. 34 (1970), 73–81. G78 ♡55
- [265] T. W. Gamelin, J. Garnett, *Distinguished homomorphisms and fiber algebras*, Amer. J. Math. ?? (1970), 455–474. [♠ p. 474 Ahlfors function mentioned as follows: “It is more difficult to relate the Shilov boundary of $H^\infty(D)$ to the Shilov boundaries of the fiber algebras. The problem is to decide whether the distinguished homomorphisms ϕ_λ lie in the Shilov boundary of $H^\infty(D)$. This question

- was resolved negatively by Zalcman [11](=1969 [904]) for the domains he considered, because in this case the Ahlfors function of D could be seen to have unit modulus on the Shilov boundary of $H^\infty(D)$.” ♡??
- [266] T. W. Gamelin, *The algebra of bounded analytic functions*, Bull. Amer. Math. Soc. 79 (1973), 1095–1108. A47, A50, G78 [♠ p.1104: “The Ahlfors function tries hard to be unimodular on the boundary of an arbitrary domain.” The following result of Fisher is quoted (and reproved) “The Ahlfors function for a bounded domain D in \mathbb{C} has unit modulus on the Šilov boundary of $H^\infty(D)$.” ♠ circa 12 occurrences of “Ahlfors function” throughout the paper ♠ p.1104: “Incidentally, the preceding proof [via the Šilov boundary] also establishes the uniqueness of the Ahlfors function.” ♠ p.1104: “Combined with cluster value theory, Fisher’s theorem yields information on the Ahlfors function which is already sharper than that which had been obtained by classical means.” p.1106–07: “if the harmonic measure for D is carried by the union of an at most countable number of boundary components of D , then the Ahlfors function G for D is inner; that is, the composition $G \circ \pi$ with the universal covering map $\pi: \Delta \rightarrow D$ has radial boundary values of unit modulus a.e. ($d\theta$). Without the hypothesis on the harmonic measure, the Ahlfors function needs not be inner, and an example is given in [17](=Gamelin, to appear) of a domain D with Ahlfors function G satisfying $|G \circ \pi| < 1$ a.e. ($d\theta$) on $\partial\Delta$.” ♣ the paper Ahlfors 1950 [17] is quoted in the following brief connection: “For dual extremal problems on Riemann surfaces, see [2](=Ahlfors 1950) and [36](=Royden 1962).” ♡3
- [267] T. W. Gamelin, *Extremal problems in arbitrary domains*, Michigan Math. J. 20 (1973), 3–11. A50, G78 [♠ quoted in Hayashi 1987 [351] for the issue that the following property: “the natural map of a Riemann surface R into its maximal ideal space $\mathfrak{M}(R)$ (this is an embedding if we assume that the algebra $H^\infty(R)$ of bounded analytic functions separates points) is a homeomorphism onto an open subset of $\mathfrak{M}(R)$ ” has some application to the uniqueness of the Ahlfors function, as well as to its existence via Hayashi 1987 [351] ♠ Royden 1962 [716] is cited instead of the original work Ahlfors 1950 [17] for the treatment of extremal problems on finite bordered Riemann surfaces] ♡12
- [268] T. W. Gamelin, *Extremal problems in arbitrary domains, II*, Michigan Math. J. 21 (1974), 297–307. G78 [♠ p.297, Ahlfors function is quoted as follows: “Hejhal proof’s depends on the methods developed by Havinson 1961/64 [345], who proved the uniqueness of the Ahlfors function of arbitrary domains. Now there is in [4](=Gamelin 1973 [267]) an economical proof of Havinson’s theorem that depends on function-algebraic techniques (see also [3](=Gamelin 1972, La Plata Notas) and [5](=Gamelin 1973 [266]))” ♡2
- [269] T. W. Gamelin, *The Shilov boundary of $H^\infty(U)$* , Amer. J. Math. 96 (1974), 79–103. [♠ p.79, the Ahlfors function is cited and the author finds a bounded domain in the plane whose Ahlfors function fails to be inner (violating thereby a guess formulated, e.g. in Rubel 1971 [718]) ♠ let us quote the text (p.79): “Let U be a bounded domain in the plane, and let $H^\infty(U)$ be the algebra of bounded analytic functions on U , and $\mathfrak{M}(U)$ be its maximal ideal space. Our object here is to study the Shilov boundary $S(U)$ of $H^\infty(U)$. It will be shown that $S(U)$ is extremely disconnected, and that every positive continuous function on $S(U)$ is the modulus of a function in $H^\infty(U)$. Fisher [7](=1972 [239]) has shown that there exist nonconstant functions in $H^\infty(U)$ with unit modulus on $S(U)$. In fact, he proves that the Ahlfors function for U is unimodular. We will show that there is an abundant supply of unimodular functions in $H^\infty(U)$, sufficiently many to separate $S(U)$ from the points of $\mathfrak{M}(U) \setminus S(U)$ which are adherent to U . In the negative direction, we show that the property of having unit modulus on the Shilov boundary of $H^\infty(U)$ does not yield a great deal of information concerning the classical boundary values of functions in $H^\infty(U)$. In fact, an example is given of a reasonably well-behaved domain U with the following property: If f is any nonconstant function in $H^\infty(U)$ such that $\|f\| \leq 1$, then the lift of f to the open unit disc via the universal covering map has radial boundary values of modulus < 1 a.e. ($d\theta$).” ♠ the latter assertion specialized to an Ahlfors function (at some center) shows that the latter can fail to be inner (indeed not even hypo-inner in the sense of Rubel)] ♡11
- [270] T. W. Gamelin, J. B. Garnett, L. A. Rubel, A. L. Shields, *On badly approximable functions*, J. Approx. Theory 17 (1976), 280–296. [♠ if F is a finite bordered Riemann surface, let $A(F)$ be the algebra of functions, analytic in the interior

with continuous extension to the boundary $\Gamma := \partial F$. The boundary value map $A(F) \rightarrow C(\Gamma)$ is injective (upon splitting into real/imaginary parts and applying the uniqueness of the Dirichlet problem). The algebra $C(\Gamma)$ (complex-valued functions on the boundary Γ) is endowed with the sup-norm $\|\varphi\| = \sup_{z \in \Gamma} |\varphi(z)|$. Now given any $\varphi \in C(\Gamma)$ there must be a best analytic approximant $f \in A(F)$, that is minimizing $\|\varphi - f\|$. The authors (following Poreda 1972) call $\varphi \in C(\Gamma)$ *badly approximable* if its distance $d(\varphi, A(D))$ to the space $A(D)$ is equal to the norm $\|\varphi\|$. This amounts saying that the best analytic approximant of φ is 0 (zero function). ♠ [01.10.12] of course such badly approximable function are the opposite extreme of the boundary-values of an Ahlfors function (or of a circle map), since the latter coincide with their best analytic approximant. Despite this contrast, badly approximable functions are shown to have constant modulus along the boundary (Theorem 1.2, p. 281) sharing a distinctive feature of circle maps, but deviates from them by having a small index (=winding number), namely $\text{ind}(\varphi) < 2p + (r - 1)$, where p is the genus and r the contour number of F . Precisely Theorem 8.1 (p. 294) states: “If $\varphi \in C(\Gamma)$ is badly approximable, then φ has nonzero constant modulus, and $\text{ind}(\varphi) < 2p + (r - 1)$.” The proof involves the theory of Toeplitz operators and reduces ultimately to the theory of Schottky differentials (forming a real vector space of dimension equal to the genus g of the double which is precisely the upper bound involved above). Hence the connection with Ahlfors 1950 [17] is evident (at least at some subconscious level), and accentuated by the numerous citations to the allied paper Royden 1962 [716]. ♠ finally, let us maybe observe that the converse of the above statement (Theorem 8.1) can be foiled as follows: via Gabard 2006 [255] there is always a circle map f of degree $d \leq r + p$. Its boundary restriction $\partial f =: \varphi$ has index equal to this degree $\text{ind}(\varphi) = d \leq r + p < 2p + (r - 1)$, provided $p > 1$. Yet the map φ is not badly approximable, for by construction it admits a perfect analytic approximant.] ♡17

[271] T. W. Gamelin, *Cluster values of bounded analytic functions*, Trans. Amer. Math. Soc. 225 (1977), 295–306. [♠ several aspects of the Ahlfors function are discussed, and some new property (extending a result of Havinson) is given. To be more precise, we quote some extracts ♠ p.296: Recall that the Ahlfors function G of D , depending on the point $z_0 \in D$, is the extremal function for the problem of maximizing $|f'(z_0)|$ among all $f \in H^\infty(D)$ satisfying $|f| \leq 1$; G is normalized so that $G'(z_0) > 0$, and then G is unique. If ζ is an essential boundary point of D , then $|G| = 1$ on III_ζ (Šilov boundary). Furthermore, either $\lim_{D \ni z \rightarrow \zeta} |G(z)| = 1$ or $\text{Cl}(G, \zeta) = \overline{\Delta}$ (=closed unit disc). S. Ya. Havinson [7, Theorem 28] has proved that G assumes all values in Δ , with the possible exception of a subset of Δ of zero analytic capacity. ♠ p.297: we conclude the following sharper version of Havinson’s Theorem. **1.2 Corollary.** Let G be the Ahlfors function of D , and let ζ be an essential boundary point of D such that $\text{Cl}(G, \zeta) = \overline{\Delta}$. Then values in Δ are assumed infinitely often by G in every neighborhood of ζ , with the exception of those lying in a set of zero analytic capacity.] ♡4

[272] T. W. Gamelin, *Wolff’s proof of the corona theorem*, Israel J. Math. ?? (1980), ??–??. [♠ “Abstract. An expository account is given of T. Wolff’s recent elementary proof of Carleson’s Corona Theorem (1962). The Corona Theorem answers affirmatively a question raised by S. Kakutani (1957) as to whether the open unit disc in the complex plane is dense in the ...”] ♡27

[273] T. W. Gamelin, M. Hayashi, *The algebra of the bounded analytic functions on a Riemann surface*, J. Reine Angew. Math. 382 (1987), 49–73. [♠ p.72 some sophisticated (but lucid) questions about the Grunsky-Ahlfors (abridged Grahl=Graal=Sangreal) extremal problem of maximizing the derivative $f'(p)$ among functions bounded-by-one $|f| \leq 1$ (where p is a given point and the derivative is taken w.r.t. a fixed local coordinates). The following questions are posed under the proviso that $H^\infty(R)$ separates points. **Problem 1.** For a fixed $p \in R$, is there an $f \in H^\infty(R)$ such that $f'(p) \neq 0$? If such an f exists, then any extremal function for the Grahl-problem normalized so that $f'(p) > 0$ is termed an *Ahlfors function* corresponding to p . **Problem 2.** For fixed $p \in R$, assume the Grahl-extremal problem is non-trivial. Is the Ahlfors function unique? Does it have unit modulus on the Shilov boundary of $H^\infty(R)$? ♠ the writer (Gabard) is not aware of any update on those questions, yet it may be emphasized that partial answers are sketched in Hayashi 1987 [351], namely that under the assumption that the natural map of R to its maximal ideal space $\mathfrak{M}(R)$ takes R homeomorphically

- onto an open set of $\mathfrak{M}(R)$, then existence and uniqueness of the Ahlfors function is ensured] ♡5
- [274] M. Gander, G. Wanner, *From Euler, Ritz and Galerkin to modern computing*, (2012), 49–73. [♠ a historical survey about Galileo, Bernoulli, Euler, Lagrange, Chladni, . . . , Ritz, Galerkin and their influence upon modern computing] ♡??
- [275] P. R. Garabedian, M. M. Schiffer, *Identities in the theory of conformal mapping*, Trans. Amer. Math. Soc. 65 (1949), 187–238. AS60, G78 [♠ p. 201, the problem of least area is considered (i.e. minimization of $\iint |f'(z)|^2 d\omega$) among *all* (not necessarily schlicht) mappings f normed by $f(a) = 0, f'(a) = 1$ defined on an n -connected domain ♠ it should be emphasized that the solution of this problem was stated (without proof) by Grunsky 1932 [314, p. 140]; Grunsky’s influence is recognized in the introduction (p. 188), yet not made explicit at the relevant passage (p. 201, Problem I.) for the specific result of the least area map ♠ assert (without detailed proof) that the solution is at most n -valent ♠ alas it is not asserted that those least-area maps are circle maps (which looks a natural conjecture)] ♡50
- [276] P. R. Garabedian, *Schwarz’s lemma and the Szegő kernel function*, Trans. Amer. Math. Soc. 67 (1949), 1–35. AS60, G78 [♠ includes the formula $f'(t) = 2\pi k(t, t)$ for the derivative of the Ahlfors function in terms of Szegő’s kernel function, other expositions of the same result in Bergman 1950 [84], Garabedian-Schiffer 1950 [279] and Nehari 1952 [594] ♠ at several crucial stage this paper makes use of topological arguments (hence a possible connection with Gabaredian 2006 [255] remains to be elucidated)] ♡104
- [277] P. R. Garabedian, *The sharp form of the principle of hyperbolic measure*, Ann. of Math. 51 (1950), 360–379. AS60, G78 [♣ claims to recover Ahlfors 1950 [17], but the detailed execution is limited to the planar case, and only the same bound as Ahlfors 1950 [17] is obtained] ♡??
- [278] P. R. Garabedian, *The class L_p and conformal mapping*, Trans. Amer. Math. Soc. 69 (1950), 392–415. [♣] ♡16
- [279] P. R. Garabedian, M. M. Schiffer, *On existence theorems of potential theory and conformal mapping*, Ann. of Math. (2) 52 (1950), 164–187. G78 [♠ reprove RMT via the Bergman kernel (for smooth boundary, p. 164), but the general case follows by topological approximation (exhaustion), ♠ p. 182 points out that circle maps lie somewhat deeper than slit mappings ♠ p. 181 recover the circle map for domains ♠ recover also the parallel-slit mappings and cite Lehto 1949 [500] for equivalent work ♠ p. 182 coins the designation “circle mapping”, to which we adhered in this survey.] ♡??
- [280] P. R. Garabedian, *A new proof of the Riemann mapping theorem*. In: *Construction and Applications of Conformal Maps*, Proc. of a Sympos. held on June 22–25 1949, Applied Math. Series 18, 1952, 207–213. [♠ consider a (strange) least area problem yet without making very explicit the range of the geometry of the extremal function] ♡??
- [281] P. R. Garabedian, *Univalent functions and the Riemann mapping theorem*, Proc. Amer. Math. Soc. 61 (1976), 242–244. [♠ yet another new proof of RMT via an extremal problem and normal families ♠ also cited for the reasons annotated after de Possel 1939 [662], namely the issue of avoiding the use of RMT in the extremal proof of PSM] ♡0?
- [282] L. Gårding, *The Dirichlet problem*, Math. Intelligencer 2 (1979/80), 43–53. [♠ historical survey of the Dirichlet problem with Poisson, Gauss 1839 [287], its influence upon Thomson 1847 [828], Stokes (credited for the maximum principle!?), Dirichlet, Riemann, Weierstrass, Schwarz, Neumann, Poincaré (balayage) and its modern ramification by Perron [635] and Radó-Riesz 1925 [671], up to Frostman, Beurling-Deny] ♡??
- [283] J. Garnett, *Positive length but zero analytic capacity*, Proc. Amer. Math. Soc. 24 (1970), 696–699. [♠ simplifies the example of Vitushkin 1957 [854] by taking advantage of the homogeneity of the compactum which is a simple planar Cantor set obtained by keeping only the 4 corner squares of a subdivision of the unit-square in 4×4 congruent subsquares, and iterating ad infinitum ♠ compare Murai 1987 [574] for another direct strategy (via Garabedian instead of Ahlfors) which is supposed to give more insight about the general problem] ♡40
- [284] J. Garnett, *Analytic capacity and measures*, Lecture Notes in Math. 297, Springer, Berlin, 1972, 138 pp. [♠ p. 18, Ahlfors function ♠ p. 36, Denjoy conjecture (cf. for its resolution Marshall [525] via Calderón mostly)] G78 ♡40

- [285] J. B. Garnett, *Bounded analytic functions*, Pure and Appl. Math. 96, Academic Press, New York, 1981. [♠ includes proofs of the corona theorem] ♡3019
- [286] C. F. Gauss, Allgemeine Auflösung der Aufgabe: die Theile einer gegebenen Fläche auf einer andern gegebenen Fläche so abzubilden, dass die Abbildung dem Abgebildeten in den kleinsten Theilen ähnlich wird. Als Beantwortung der von der königlichen Societät der Wissenschaften in Copenhagen für 1822 aufgegebenen Preisfrage, in: *Schumacher's Astronomische Abhandlungen*, Drittes Heft, pp. 1–30, Altona 1825. (Also in: Werke, Bd. 4, 189–216.) [♠ This is probably the only record in print which may be regarded as a weak (very local) forerunner of the RMT. This text was of course known to Riemann, and adumbrates the conformal plasticity of 2D-mappings] ♡??
- [287] C. F. Gauss, *Allgemeine Lehrsätze in Beziehung auf die im verkehrten Verhältnisse des Quadrates der Entfernung wirkenden Anziehungs- und Abstossungs-Kräfte*, Magnetischer Verein (1839). Werke vol. 5, 195–242. [♠ a forerunner of the Dirichlet principle. This text was known to Riemann ♠ this Gauss work is supposed to lack in rigor, yet encompass the substance of the all potential theory (compare BreLOT 1952 [115] for a modern appreciation)] ♡46
- [288] P. M. Gauthier, M. Goldstein, *From local to global properties of subharmonic functions on Green spaces*, J. London Math. Soc. (2) 16 (1977), 458–466. [♠ p. 465, includes the following application of the Ahlfors function. Let $\bar{\Omega}$ be a compact bordered Riemann surface with interior Ω and contour $C = \partial\bar{\Omega}$. Given $f: C \rightarrow \bar{\mathbb{R}} = [-\infty, +\infty]$ an extended real-valued continuous function, one says that f is Dirichlet soluble if it continuously extends to $\bar{\Omega}$ so that its restriction to the interior Ω is harmonic. In this case, $f^{-1}(+\infty)$ is a closed set of HMZ (=harmonic measure zero). Now the authors shows the converse statement. Indeed, given $E \subset C$ closed and of HMZ, its image under an Ahlfors function (cf. Ahlfors 1950 [17]) $F: \bar{\Omega} \rightarrow \bar{\Delta}$ is a subset of the circumference $S^1 = \partial\bar{\Delta}$ of measure zero (Sard required?). According to Fatou 1906 [231] any null-set of the circle occurs as $u_1^{-1}(\infty)$ for a continuous function $u_1: \bar{\Delta} \rightarrow \bar{\mathbb{R}}$ harmonic in the interior. The composed map $u_1 \circ F$ has the desired properties ♠ note however that the trick of the Ahlfors function seems not well suited for reducing the Dirichlet problem (even with non-extended boundary values) on a compact bordered Riemann surface to the case of the disc where it is soluble via the Poisson integral (albeit this may have been a partial intention in Bieberbach 1925 [93])] ♡1
- [289] W.-D. Geyer, *Ein algebraischer Beweis des Satzes von Weichold über reelle algebraische Funktionenkörper*, In: *Algebraische Zahlentheorie* (Ber. Tagung Math. Forschungsinst. Oberwolfach, 1964), 83–98. [♠ includes a new proof of the theorem of Witt 1934 [892]] ♡??
- [290] W.-D. Geyer, G. Martens, *Überlagerungen berandeter Kleinscher Flächen*, Math. Ann. 228 (1977), 101–111. A50 [♣ after Alling-Greenleaf 1969 [38], also interprets Ahlfors 1950 [17], in terms of Klein's orthosymmetric real curves, specifically p. 106: "Gewissermaßen als Umkehrung von a) ist das resultat von Ahlfors ([1], §4) anzusehen, wonach jede Kleinsche Fläche vom Typ $+(g, r)$ mit $r > 0$ eine $(g+1)$ -blättrige verzweigte Überlagerung der zur reellen projectiven Geraden \mathbb{P}_1 gehörenden Kleinschen Fläche $\bar{\mathbb{C}}/\sigma$ (=Riemannsche Zahlenhalbkugel) ist." ♠ "Seit Klein [6, 12] zieht man zum Studium reeller algebraischer Funktionenkörper F einer Variablen mit Erfolg die zur Komplexifizierung von F gehörige Riemannsche Fläche, versehen mit einer antiholomorphen Involution a , heran, oder auch die Kleinsche Fläche ..."] ♡3/4
- [291] A. Girouard, I. Polterovich, *Steklov eigenvalues*, arXiv (2012). A50 [♣ extension of Fraser-Schoen 2011 [249] to higher eigenvalues] ♡0?
- [292] A. M. Gleason, *Function algebras*, Seminar on analytic functions, Institute for Advanced Study, Princeton, N. J., 1957. [♣ where the Gleason parts are defined as the equivalence classes of the following relation ♠ for an arbitrary function algebra A on a compact metrizable space X , let M be its maximal ideal space and S its Shilov boundary. Realizing A as a function algebra on M , two points $m_1, m_2 \in M$ are (Gleason) equivalent if $\sup\{|f(m_1)| : f(m_2) = 0, \|f\| \leq 1\} < 1$. ♠ for a connection with the Ahlfors map cf. e.g. O'Neill-Wermer 1968 [618]] ♡??
- [293] G. M. Golusin, *Auflösung einiger ebener Grundaufgaben der mathematischen Physik im Fall der Laplaceschen Gleichung und mehrfach zusammenhängender Gebiete, die durch Kreise begrenzt sind*, (Russian, German Summary) Mat. Sb. 41 (1934), 246–276. G78 [♣ Seidel's summary: a harmonic function U of two real

variables is sought exterior to the circles C_1, \dots, C_n , with $U(\infty)$ finite, which on C_k assumes preassigned continuous values f_k . The problem is reduced to the solution of a finite system of functional equations which are solved by successive approximations. The method is applied to solve Neumann's problem and other similar problems for Laplace's equation and for regions of the above type. The Green's functions of such regions and the functions which map them on slit planes are determined]★ ♡??

- [294] G. M. Golusin, *Sur la représentation conforme*, (French, Russian Summary) Mat. Sb.=Rec. Math. 1 (43) (1936), 273–282. G78 [♣ p. 273, Lemme 1 gives another proof of a basic lemma about areas of rings under conformal maps ♠ Pólya-Szegő 1925 are cited, but it should go back to Carleman 1918 [150] ♠ for the relevance of this lemma to the least area problem of multi-connected under schlicht maps see Gaier 1977 [259] where a dissection process shows that a solution (non-unique!) to this problem effects a representation upon a circular slit disc ♠ incidentally the proof of Thm 1, p. 274 looks very akin to Gaier's argument of 1977 [259]] ♡4?
- [295] G. M. Golusin, *Iterationsprozesse für konforme Abbildungen mehrfach zusammenhängender Bereiche*, (Russian, German Summary) Mat. Sb. N. S. 6 (48) (1939), 377–382. G78 [♣ Iterative methods are established by means of which a schlicht conformal map of regions of finite connectivity on some canonical domains is reduced to a sequence of conformal maps of simply connected regions]★ ♡4?
- [296] G. M. Golusin, *Geometrische Funktionentheorie*, Übersetzung aus dem Russischen. Hochschulbücher f. Math. Bd. 31, Berlin, VEB Deutscher Verlag d. Wiss., 1957. English transl.: *Geometric theory of functions of a complex variable*, 1969. (Russian original published in 1952.) AS60, G78 [♠ p. 240–4, proof of a circle map in the schlicht(artig) case following Grunsky 1937–41 (potential theoretic) ♠ p. 412–8, the extremal approach is presented (Ahlfors 1947 [16] is cited, and ref. to Grunsky 1940–42 [317, 318] where added by the German editors (probably Grunsky himself) ♠ p. 200–217 present a proof of Koebe's KNP via the continuity method (approached via Brouwer's invariance of the domain)] ♡194(German)/1274(English)
- [297] T. Gouma, *Ahlfors functions on non-planar Riemann surfaces whose double are hyperelliptic*, J. Math. Soc. Japan 50 (1998), 685–695. A50 [♣ detailed study of the degrees of the Ahlfors map in the hyperelliptic case ♣ a complement (tour de force) is to be found in Yamada 2001 [897] ♠ for an application to proper holomorphic embeddings in \mathbb{C}^2 , cf. Černe-Forstnerič 2002 [166] ♠ Köditz's summary (MathReviews): “Let R be a finite bounded [=bordered] Riemann surface with genus p and q contours and let P be a point in R . The author studies the set of Ahlfors functions on R . These functions are the extremal functions obtained by maximizing the derivative $|f'(P)|$ (in some local parameter at P) in the class of holomorphic functions on R bounded by one. Each Ahlfors function has modulus 1 on the boundary of R and gives a complete³² covering of the unit disk. It is known that the degree N of any Ahlfors function satisfies $q \leq N \leq 2p + q$ (Ahlfors, 1950=[17]). The set of degrees $N(R)$ of Ahlfors functions on a given Riemann surface R is not well known. In this paper, the author deals with Ahlfors functions on non-planar Riemann surfaces whose doubles are hyperelliptic. Among others, examples for such Riemann surfaces with $N(R) = \{2, 2p + q\}$ are constructed.”] ♡5
- [298] W. H. Gottschalk, *Conformal mapping of abstract Riemann surfaces*, Published by the author, Univ. of Pennsylvania, Philadelphia, 1949, 77p. ★ AS60 ♡??
- [299] L. B. Graifer, S. Ja. Gusman, V. V. Dumkin, *An extremal problem for forms with singularities on Riemannian manifolds*, Perm. Gos. Univ. Učen. Zap. 218 (1969), 47–52. [♠ from MathReview (by Kiremidjian): “In 1950, Ahlfors showed that a number of extremal problems on compact subregions of open Riemann surfaces could be solved by studying the class of Schottky differentials [Ahlfors 1950 [17]; errata, MR 13, p. 1138]. In recent years, certain aspects of Ahlfors' work were investigated in the case of n -dimensional orientable differentiable manifolds [the second author, 1966]. In the present paper, the authors study the class of Schottky-Ahlfors forms with singularities.” ♠ so those cited works constitute a rare but foolhardy attempt to extend Ahlfors' theory to higher dimensions ♠ perhaps one is prompted by the (naive!) question if one could formulate a theory able to (re)prove

³²Jargon of Ahlfors-Sario 1960 [22, p. 42], implying that the map covers each point the same number of times (counting properly by multiplicity); but of course inspired by Stilow's book 1938 [800].

the famous 3D-conjecture of Poincaré-Perelman in its bordered incarnation: any compact bordered 3-manifold is topologically equivalent to the 3-ball, provided it is contractible or simply-connected and bounded by the 2-sphere (of course the modest antecedent being the fact that one can prove the Schoenflies theorem via RMT thanks to Osgood/Carathéodory) ♠ the Ahlfors function $W^3 \rightarrow \Delta^3$ has then perhaps to be a harmonic map with maximal distortion at some base point, and if the contours are surfaces distinct from the sphere then there is no chance to have a covering along the boundary, but otherwise e.g. for W^3 the interspace of two concentric spheres it is not difficult to visualize a 3D-avatar of the Ahlfors map (just by taking the revolution of a map from an annulus to the disc, cf. our Fig. 9)] ♡??

- [300] J. Gray, *On the history of the Riemann mapping theorem*, Rend. Circ. Mat. Palermo (2) 34 (1994), 47–94. [♠ from Riemann to Koebe’s area, through Osgood, etc.] ♡13
- [301] J. Gray, M. Micallef, *The work of Jesse Douglas on minimal surfaces*, Bull. Amer. Math. Soc. (N.S.) 45 (2008), 293–302. [♠ contains several critics (mostly raised by Tromba 1983 [837]) about the rigor of the work of Douglas/Courant on the Plateau problem, especially when it comes to higher topological structure] ♡??
- [302] G. Green, *An essay on the application of mathematical analysis to the theories of electricity and magnetism*. Printed for the Author by Whellhouse T. Nottingham, 1828, 72 pp. Also in: *Mathematical Papers of George Green*, Chelsea Publishing Co., 1970, 1–115; and reprinted in three parts in *J. Reine Angew. Math.* 39 (1850), 73–89; 44 (1852), 356–374; 47 (1854), 161–221. [♠ this Crelle reprint was organized by W. Thomson ♠ contains a form of the Dirichlet principle, presumably the first ever put in print ♠ as to the connection with our problem of the Ahlfors map, the connection is evident and implicit in Ahlfors 1950 paper [17], albeit the latter employs a variant of the Green’s function with “dipole” singularity placed at a boundary point] ♡121
- [303] P. Griffiths, J. Harris, *Principles of Algebraic Geometry*. Wiley, 1978; Wiley Classic Library edition, 1994. [♠ contains both an heuristic and formal proof of the $\lfloor (g+3)/2 \rfloor$ gonality of closed Riemann surfaces of genus g , a result predicted since Riemann 1857 [687] but only firmly validated in the modern era through the work of Meis 1960 [541] ♠ see especially p. 358, (special linear systems) and the proof presented is presumably quite close (??) to that of Kempf 1971 [422]] ♡5802
- [304] P. Griffiths, J. Harris, *On the variety of special linear systems on a general algebraic curve*, *Duke Math. J.* 47 (1980), 233–272. [♠ p. 236/7 gives a parameter count argument (via Riemann-Hurwitz and Riemann’s $3g-3$ moduli) to show that “a general curve C of genus $g \geq 2$ cannot be expressed as a multiple cover of any curve C' of genus $g' \geq 1$.” ♠ this can be employed to show that the avatar of the Ahlfors map with range not a disc but a membrane of higher topological complexity fails generally to share the property of the usual circle-valued Ahlfors map of taking the boundary to the boundary] ♡??
- [305] M. Gromov, *Filling Riemannian manifolds*, *J. Differential Geom.* 18 (1983), 1–147. [♠ present a modernized proof of the Loewner-Pu isosystolic inequality, by quoting Jenkins, hence indirectly Grötzsch, so back to Koebe-Poincaré, genealogically. Of course the uniformization required for Loewner (torus) and Pu (projective plane) are of a simpler nature, (Abel and Riemann, Schwarz resp.).] ♡513
- [306] M. Gromov, *Spaces and questions*, Preprint (1999).
- [307] T. H. Gronwall, *Some remarks on conformal representation*, *Ann. of Math.* (2) (1914/15), 72–76. [♠ probably one of the first usage of the area-principle, cf. also Bieberbach 1914 [92], Bieberbach 1916 [95] and Faber 1916 [228]] ♡??
- [308] B. H. Gross, J. Harris, *Real algebraic curves*, *Ann. Scient. Éc. Norm. Sup.* (4) 14 (1981), 157–182. [♠ modern account of Klein’s theory of real curves with many innovative ideas and viewpoints ♠ the question posed on p. 177 about the number of ovals for dividing plane smooth curves easily follows from the ideas of Rohlin³³ 1974/75 [705], 1978 [706], compare Gabard 2000 [253] for a detailed discussion] ♡147

³³Some specialists from Grenoble (especially Emmanuel Ferrand) told me (ca. 1999/00) that the idea of filling the membrane by the insides of the ovals truly goes back to Arnold, which is probably essentially correct, yet Rohlin’s credit in effecting the lovely perturbation and counting things properly is probably not at all affected.

- [309] A. Grothendieck, *Techniques de construction en géométrie analytique*, Sémin. H. Cartan 1960/61, Exp.7, 9–17, Paris, 1962. [♠ Teichmüller theory à la Grothendieck] ♥??
- [310] A. Grothendieck, *Esquisse d'un programme*, 1984; reproduced in: L. Schneps and P. Lochak (eds), *Geometric Galois Actions I. Around Grothendieck's Esquisse d'un programme*, London Math. Soc. Lecture Note Ser. 242, Cambridge Univ. Press, 1997, 5–48. [♠ Teichmüller, Thurston, legos, etc. plus the Belyi-Grothendieck theorem that a closed Riemann surface is defined over $\overline{\mathbb{Q}}$ iff it has only 3 ramifications over the sphere] ♥??
- [311] H. Grötzsch, *Über einige Extremalprobleme der konformen Abbildung*, Ber. Verh. Sächs. Akad. Wiss. Leipzig 80 (1928), 497–502. AS60, G78 [♠ credited by Nehari 1953 [595] for the solution of maximizing the derivative (distortion) at a given point of a multi-connected domain among schlicht functions bounded-by-one (extremals mapping upon a circular slit disc)] ♥??
- [312] H. Grötzsch, *Über konforme Abbildung unendlich vielfach zusammenhängender schlichter Bereiche mit endlich vielen Häufungsrandkomponenten*, Ber. Verh. Sächs. Akad. Wiss. Leipzig (1929), 51–86. AS60, G78 [♠ first proof of the circular slit disc mapping in infinite connectivity, see also Reich-Warschawski 1960 [677] for more subsequent references] ♥??
- [313] H. Grötzsch, *Das Kreisbogenschlitztheorem der konformen Abbildung schlichter Bereiche*, Ber. Verh. Sächs. Akad. Wiss. Leipzig (1931), 238–253. AS60, G78 [♠ another proof of the circular slit disc mapping in infinite connectivity, compare Grötzsch 1929 [312]] ♥17
- [314] H. Grunsky, *Neue Abschätzungen zur konformen Abbildung ein- und mehrfach zusammenhängender Bereiche*, (Diss.) Schriften Math. Semin., Inst. angew. Math. Univ. Berlin 1 (1932), 95–140. [♠ [26.07.12] p.140, Grunsky announces (without proofs) the result that a suitable combination $c(\mathfrak{x}(\zeta; z) - \eta(\zeta; z))$ of the horizontal \mathfrak{x} (resp. vertical η) [those being the fraktur letters for x resp. y !] slit-maps affords the solution to the problem of least area among all analytic functions normed by $f'(z) = 1$ ♠ on reading the rest of the paper it seems that that the image might fail to be a disc, compare esp. p.135 where a similar least area problem is handled ♠ this topic is addressed again in Garabedian-Schiffer 1949 [275] and Nehari 1952 [594]] AS60, G78 ♥??
- [315] H. Grunsky, *Über die konforme Abbildung mehrfach zusammenhängender Bereiche auf mehrblättrige Kreise*, Sitzungsber. Preuß. Akad. (1937), 40–46. AS60, G78 [♣ new potential-theoretic proof of the circle map for domains] ♥??
- [316] H. Grunsky, *Über die konforme Abbildung mehrfach zusammenhängender Bereiche auf mehrblättrige Kreise, II*, Abh. Preuß. Akad. Wiss. Math.-nat. Kl. 11 (1941), 1–8. AS60, G78 [♣ idem as the previous item] ♥??
- [317] H. Grunsky, *Eindeutige beschränkte Funktionen in mehrfach zusammenhängenden Gebieten I*, Jahresb. d. Deutsch. Math.-ver. 50 (1940), 230–255. G78 [♣ extremal-problem description of circle maps for domains] ♥??
- [318] H. Grunsky, *Eindeutige beschränkte Funktionen in mehrfach zusammenhängenden Gebieten II*, Jahresb. d. Deutsch. Math.-ver. 52 (1942), 118–132. G78 [♣ sequel of the previous item] ♥??
- [319] H. Grunsky, *Zur Funktionentheorie in mehrfach zusammenhängenden Gebieten*, Ber. Mathematikertagung Tübingen (1946), 68–69; in Coll. Papers, 245–6. G78 ♥??
- [320] H. Grunsky, *Nachtrag zu meinen Arbeiten über "Eindeutige beschränkte Funktionen in mehrfach zusammenhängenden Gebieten"*, Math. Z. 52 (1950), 852. G78 ♥17
- [321] H. Grunsky, *Über die Fortsetzung eines auf einer berandeten Riemannschen Fläche erklärten meromorphen Differentials*, Math. Nachr. 39 (1969), 87–96. [♣ one of the rare work by Grunsky concerned with bordered surfaces, yet it does not seem to reprove the existence of a circle map à la Ahlfors] ♥??
- [322] H. Grunsky, *Lectures on Theory of Functions in Multiply Connected Domains*, Studia Mathematica, Skript 4, Vandenhoeck and Ruprecht in Göttingen, 1978. [♣ all inclusive account but focusing to the case of domains (no Riemann surfaces)] ♥34/36

- [323] D. A. Gudkov, *The topology of real projective algebraic varieties*, Russian Math. Surveys 29 (1974), 1–79. [♠ contain an extensive bibliography of early real algebraic geometry (in Germany, Italy and Russia), mostly in the spirit of Hilbert (by contrast to Klein’s more Riemannian approach)] ♡??
- [324] R. C. Gunning, *Lectures on Riemann surfaces*. Princeton Acad. Press, Princeton, 1966. ★ ♡??
- [325] R. C. Gunning, R. Narasimhan, *Immersion of open Riemann surfaces*, Math. Ann. 174 (1967), 103–108. [♠ no directly visible connection with Ahlfors 1950, but there must be some link in the long run] ♡??
- [326] R. C. Gunning, *Lectures on Riemann surfaces: Jacobi varieties*, Princeton Univ. Press, Princeton, N. J., 1972. [♠ new (essentially topological?) proof of Meis’ result upon the gonality of complex curves (=closed Riemann surfaces) ♠ [21.06.12] the following extract of H. H. Martens’s review in MathReviews is capital for it brings the hope to gain a Teichmüller theoretic approach to the existence of circle maps with the best possible bounds (hence hinting how to recover Ahlfors and even Gabard 2006 [255] by an analytic (or rather geometric!) approach competing seriously with the naive topological proof of the writer): “A pièce de résistance is served in the appendix in the form of a proof of the existence of functions of order $\leq [\frac{1}{2}(g+3)]$ on any closed Riemann surface. This result was previously obtained by T. Meis 1960 [541] using Teichmüller space techniques, and it is a special case of the more general results of Kleiman-Laksov 1972 [428] and Kempf 1971 [422].”] ★★★ ♡556
- [327] B. Gustafsson, *Quadrature identities and the Schottky double*, Acta Appl. Math. 1 (1983), 209–240. [♠ [13.10.12] can the theory be extended to non-planar domains?] ♡??
- [328] B. Gustafsson, *Applications of half-order differentials on Riemann surfaces to quadrature identities for arc-length*, J. Anal. Math. 49 (1987), 54–89. [♠] ♡??
- [329] A. Haas, *Linearization and mappings onto pseudocircle domains*, Trans. Amer. Math. Soc. 282 (1984), 415–429. [♠ Koebe’s Kreisnormierungsprinzip for positive genus, uniqueness complement in Maskit 1989 [534]] ♡??
- [330] J. Hadamard, *Sur le principe de Dirichlet*, Bull. Soc Math. France (1906). [♠ p.135 an example is given of a continuous function on the boundary of a domain such that none functions satisfying the boundary prescription has finite Dirichlet integral ♠ a similar example was given in Prym 1871 [664], where a continuous function is given on the circle such that the harmonic function matching this boundary data (whose existence is derived by another procedure, e.g. the Poisson integral) has infinite Dirichlet integral ♠ of course, heuristically any Prym’s boundary data must be of the Hadamard type (precisely by virtue of the just corrupted Dirichlet principle!): if the harmonic solution explodes any vulgar solution (hence less economical) must explode as well] ♡??
- [331] J. Hadamard, *Mémoire sur le problème d’analyse relatif à l’équilibre de plaques élastiques encastrées*, Mémoires présentés par divers savants à l’Académie des Sciences 33 (1908), 128 pp. [♠ Discussion of the famous method, named after Hadamard, of variation of domains ♠ further developed by Schiffer especially] ♡??
- [332] R. S. Hamilton, *The Ricci flow on surfaces*, In: Mathematics and General Relativity (Santa Cruz, CA, 1986). Contemporary Mathematics 71, Amer. Math. Soc., Providence, 1988, 237–262. [♠ uniformization of surfaces via the 2D-Ricci flow (at least in the compact case)] ★★★ ♡??
- [333] M. Hara, M. Nakai, *Corona theorem with bounds for finitely sheeted disks*, Tôhoku Math. J. 37 (1985), 225–240. A50 [♣ applies Ahlfors mapping in a quantitative fashion (making use of its degree in contrast to Alling 1964 [34]) ♣ naive question (ca. Sept. 2011) can we improve the bounds by appealing instead to Gabard 2006 [255]] ♡5
- [334] A. Harnack, *Ueber die Vieltheiligkeit der ebenen algebraischen Curven*, Math. Ann. 10 (1876), 189–198. [♠ a proof is given (via Bézout’s theorem) that a smooth plane real curve of degree m posses at most $g+1 = \frac{(m-1)(m-1)}{2} + 1$ components and such (Harnack) maximal curves are construction for each degree via a method of small perturbation ♠ as everybody knows a more intrinsic proof was given by Klein 1876 [432] by simply appealing to Riemann’s definition of the genus as maximum number of retrosections not cutting the surface ♠ another more exotic derivation of the Harnack bound (using Riemann-Roch) is to be found in Enriques-Chisini

- 1915 [225], whose argument actually supplies a proof of the so-called Bieberbach-Grunsky theorem (cf. Bieberbach 1925 [97], Grunsky 1937 [315] and for instance A. Mori 1951 [570]) which is the planar version of the Ahlfors map] ♡171
- [335] A. Harnack, *Die Grundlagen der Theorie des logarithmischen Potentials, und der eindeutigen Potentialfunktionen in der Ebene*, Teubner, Leipzig, 1887. ♡20
- [336] R. Hardt, D. Sullivan, *Variation of the Green function on Riemann surfaces and Whitney's holomorphic stratification conjecture*, Publ. Math. I.H.E.S. (1989), 115–138. ♠ [10.08.12] the starting point of the paper (p. 115) is a representation of a Riemann surface as a k -sheeted branched covering of the unit disc (denoted B) with branch point a_1, \dots, a_l in $B_{1/2}$ (ball of radius one-half) ♠ this situation resembles sufficiently to Ahlfors 1950 [17] to ask if a precise connection can be made ♠ of course one may notice that a map of the type required (by Hardt-Sullivan) exists for any interior of a compact bordered Riemann surface: indeed take a Ahlfors map or just a circle map (existence ensured by Ahlfors 1950 [17], or other sources, e.g. Gabard 2006 [255]) and then upon post-composing by a power-map $z \mapsto z^n$ we may contract the modulus of the branch points to make them as small as we please upon choosing k large enough ♠ perhaps the dual game of looking at largest possible winding points should relate to the problem of finding the circle maps of lowest possible degrees ♠; at least one should be able to define a conformal invariant of a bordered surface F by looking at the largest possible modulus of a branch point of a circle map (of course composing with a disc-automorphism, the branch point can be made very close to 1, so one requires a normalization, e.g. mapping a base-point of F to 0) ♠ this defines a $[0, 1]$ -valued numerical invariant of a marked compact bordered Riemann surface (F, b) ; how does it depends on b when the latter is dragged through the (fixed) surface and does this invariant takes the value 0 only for when F is the disc ♠ as another variant without marking, we may always assume that 0 is nor ramified, and we may look for the largest radius free of ramification, this defines another numerical invariant taking values in $]0, 1]$; obviously it takes the value one only when F is topologically a disc (Riemann mapping theorem maybe in the variant firmly established by Schwarz) ♠ maybe in the spirit of Bloch there is an absolute (strictly) positive lower bound on this “schlicht radius” at least for prescribed topological characteristic (i.e. the invariant p and r counting the genus and the contours) ♠ call this constant $B_{p,r}$: how does it depend on p, r asymptotically (maybe convergence to 0 if $p, r \rightarrow \infty$); further is the infimum achieved by some surfaces, if so can we describe the extremal surfaces (naive guess the ramification is then cyclotomic); compare maybe work of Minda ca. 1983 for related questions] ♡??
- [337] G. H. Hardy, *On the mean modulus of an analytic function*, Proc. London Math. Soc. 14 (1915), 269–277. [♠] ♡??
- [338] A. N. Harrington, *Conformal mappings onto domains with arbitrarily specified boundary shapes*, J. d'Anal. Math. 41 (1982), 39–53. [♠ extension of Koebe's KNP; similar result in Brandt 1980 [113] ♠ method: potential theory and (algorithmic) Brouwer's fixed point ♠ variant of proof in Schramm 1996 [766]] ♡??
- [339] M. Hasumi, *Invariant subspaces for finite Riemann surfaces*, Canad. J. Math. 18 (1966), 240–255. [♠ extension of Beurling's theorem (1949 [89]) for the disc to the case of finite bordered Riemann surface, yet without using the Ahlfors map, but cite Royden 1962 [716] which is closely allied] ♡27
- [340] O. Haupt, *Ein Satz über die Abelschen Integrale 1. Gattung*, Math. Z. 6 (1920), 219–237. [♠ only cited for the Riemann parallelogram method, which bears (perhaps?) some resemblances with Gabard 2006 [255]] ♡??
- [341] S. Ya. Havinson, *On an extremal problem in the theory of analytic functions*, (Russian) Uspekhi Mat. Nauk. 4 (1949), 158–159. [♠]★ ♡7
- [342] S. Ya. Havinson, *On extremal properties of functions mapping a region on a multi-sheeted circle*, Doklady Akad. Nauk. SSSR (N.S.) 88 (1953), 957–959. (Russian.) AS60 ★ ♡??
- [343] S. Ya. Havinson, *Extremal problems for certain classes of analytic functions in finitely connected regions*, Mat. Sb. (N.S.) 36 (78) (1955), 445–478; Amer. Math. Soc. Transl. 5 (1957), 1–33. G78 [♠ generalized linear extremal problems (finite connectivity), i.e. maximization of the modulus of the derivative replaced by an arbitrary linear functional]★ ♡??
- [344] S. Ya. Havinson, G. C. Tumarkin, *Existence of a single-valued function in a given class with a given modulus of its boundary values in multiply connected domains*,

- (Russian), *Izv. Akad. Nauk SSSR Ser. Mat.* 22 (1958), 543–562. [♠ quoted in Khavinson 1984 [425, p.378], and the same problem of prescribing the boundary modulus had been already treated by Grunsky 1942 [318]]★ ♡??
- [345] S. Ya. Havinson, *Analytic capacity of sets, joint nontriviality of various classes of analytic functions and the Schwarz lemma in arbitrary domains*, *Mat. Sb.* 54 (96) (1961), 3–50; English transl., *Amer. Math. Soc. Transl. (2)* 43 (1964), 215–266. A47, A50, G78 [♠ uniqueness of the (Ahlfors) extremal function for domains of infinite connectivity (similar work in Carleson 1967 [155]); but Khavinson’s work goes deeper (according to Hejhal 1972 [365]) into the study of the behavior of the extremal function] ♡14
- [346] S. Ya. Havinson, *Factorization theory for single-valued analytic functions on compact Riemann surfaces with boundary*, *Uspekhi Math. Nauk.* 44 (1989), 155–189; English transl., *Russian Math. Surveys* 44 (1989), 113–156. [♠ p. 117 explains the usual trick of annihilating the $2p + (h - 1)$ periods along essential cycles on a finite Riemann surface, for which we may take any $r - 1$ of the boundary contours, as well as meridians and parallels taken along each handle ♠ so this is quite close to our naive attempt to reprove Ahlfors’ theorem, compare Section 20] ♡??
- [347] S. Ya. Havinson, *Duality relations in the theory of analytic capacity*, *St. Petersburg Math. J.* 15 (2004), 1–40. (Russian version published in 2003.) [♠ Ahlfors function appears on pp. 2, 11, 13, 20 ♠ the terminology “analytic capacity” (or “Ahlfors capacity”) is credited to V. D. Erokhin’s: “In accordance with V. D. Erokhin’s proposal (1958), the quantity $\gamma(F)$ has been called the *analytic capacity* or the *Ahlfors capacity* since that time.”] ♡0
- [348] N. S. Hawley, M. Schiffer, *Half-order differentials on Riemann surfaces*, *Acta Math.* 115 (1966), 199–236. [♠] ♡96
- [349] N. S. Hawley, M. Schiffer, *Riemann surfaces which are double of plane domains*, *Pacific J. Math.* 20 (1967), 217–222. G78 [♠] ♡low 2
- [350] N. S. Hawley, *Weierstrass points of plane domains*, *Pacific J. Math.* 22 (1967), 251–256. G78 [♠ addresses the question of the distribution of Weierstrass points upon the Schottky double of a plane domain. Precisely, for a planar membrane with hyperelliptic double, all W-points are located on the boundary. The author gives an example, derived from a real quartic with 4 ovals, whose W-points are not confined to the boundary. Such questions make good sense over positive genus membranes and are perhaps worth investigating further. Probably updates are already known, and one would like to explicit any possible relation between W-points and the degree of the Ahlfors function. Compare for this issue, Yamada 1978 [894]] ♡1
- [351] M. Hayashi, *The maximal ideal space of the bounded analytic functions on a Riemann surface*, *J. Math. Soc. Japan* 39 (1987), 337–344. [♠ the following property: “the natural map of a Riemann surface R into its maximal ideal space $\mathfrak{M}(R)$ (this is an embedding if we assume that the algebra $H^\infty(R)$ of bounded analytic functions separates points) is a homeomorphism onto an open subset of $\mathfrak{M}(R)$ ” has some application to the uniqueness of the Ahlfors function (cf. Gamelin 1973 [267]), as well as to its existence ♠ the bulk of this paper consists in giving examples where this property fails answering thereby a question of Gamelin 1973] ♡11
- [352] Z.-X. He, *Solving Beltrami equation by circle packing*, *Trans. Amer. Math. Soc.* 322 (1990), 657–670. [♠ includes another proof of GKN (generalized Kreisnormierung) where a compact bordered Riemann surface is conformally mapped upon a circular domain in a space form (=constant curvature) [of the same genus?] ♠ similar statement obtained by Haas 1984 [329] and Maskit 1989 [534] (curiously non-cited here)—maybe also Jost 1985 [402] ♠ perhaps the “syntax” of the main result (Thm 5.1, p. 669) must be slightly corrected, probably by assuming the contours of $\partial\bar{\Omega}$ to bounds discs in the surface M (equivalently to be null-homotopic)] ♡24
- [353] Z.-X. He, O. Schramm, *Fixed points, Koebe uniformization and circle packings*, *Ann. of Math. (2)* 137 (1993), 369–406. [♠ the deepest advance upon the KNP=Kreisnormierungsprinzip (raised by Koebe 1908 UbaK3 [452]), which is established for countably many boundary components ♠ The general case is still unsettled today (2012), and maybe undecidable within ZFC? (just a joke, of course)] ♡87
- [354] Z.-X. He, O. Schramm, *On the convergence of circle packings to the Riemann map*, *Invent. Math.* 125 (1996), 285–305. [♠ improvement and generalization of the

- Rodin-Sullivan proof (1987 [703]), making it logically independent of RMT (thus reproving it via the technology of circle packings) ♠ [08.10.12] what about the same game for the Ahlfors map? ♡41
- [355] E. Heine, *Ueber trigonometrische Reihen*, J. Reine Angew. Math. 71 (1870), 353–365. [♠ the role of uniform convergence is emphasized (i.e. Weierstrass’ notion, yet first only familiar to his direct circle of students)] ♡37
- [356] M.H. Heins, *Extremal problems for functions analytic and single-valued in a doubly connected region*, Amer. J. Math. 62 (1940), 91–106. G78 [♠ quoted (joint with Carlson 1938 [157] and Teichmüller 1939 [824]) in Grunsky 1940 [317] as one of the forerunners of the extremal problem for bounded analytic functions (alias Ahlfors map, subsequently)] ♡17
- [357] M. Heins, *On the iteration of functions which are analytic and single valued in a given multiply connected region*, Amer. J. Math. 63 (1941), 461–480. G78 [♠ regarded by Minda 1979 [554, p.421] as the proper originator of the *annulus theorem* (i.e., an analytic self-map of an annulus can take the generator of the fundamental group only upon a 0 or ± 1 multiple of itself, and the ± 1 case forces the map to be a conformal automorphism)] ♡37
- [358] M. Heins, *A lemma on positive harmonic functions*, Ann. of Math. (2) 52 (1950), 568–573. AS60, G78 [♠ may contain another proof of the existence of the Ahlfors function (at least a circle map), yet not very clear which degree Heins’ argument supplies ♣ in fact since the quantity m appearing on p.571 for a generating system of the fundamental group is easily found to be $m = 2p + (r - 1)$ (where p is the genus and r the number of contours) it is quite likely (albeit the writer has no certitude!) that Heins’s method may reproduce (by specialisation) exactly Ahlfors upper bound upon the degree of a circle map ♠ [06.10.12] for a possible corroboration of this intuition, check also the subsequent paper Heins 1985 [363] which truly seems to get again the $r + 2p$ bound of Ahlfors (1950) ♠ treats Pick-Nevalinna interpolation for a bordered surface (extending the work of Garabedian 1949 [276])] ♡23
- [359] M. Heins, *Symmetric Riemann surfaces and boundary problems*, Proc. London Math. Soc. (3) 14A (1965), 129–143. [♠ looks closely allied to Ahlfors 1950 [17], which is not cited, but so are some direct descendants, Read 1958 [676] and Royden 1962 [716] ♠ enters into the category of “transplanting papers” where some result for the disc is lifted to a compact bordered surface (=membrane) ♠ in the present case M. Riesz’s theorem on the conjugate Fourier series, and the unique decomposition of $f \in L^p$ into interior/exterior Fatou boundary functions of functions in H_p] ♡6
- [360] M. Heins, *Hardy classes on Riemann surfaces*, Lecture Notes in Mathematics 98, Springer, 1969. [♠ p.59–65 contains a re-exposition of Heins 1950 [358], yielding probably an alternate proof of the Ahlfors circle maps]★★★ ♡77
- [361] M. Heins, *Nonpersistence of the Grenzkreis phenomenon for Pick-Nevalinna interpolation on annuli*, Ann. Acad. Sci. Fenn. Ser. A. 596 (1975), 1–21. A50, G78 [♠ cited in Jenkins-Suita 1979 [393] ♠ from MathReviews: “Let A be a subset of the open unit disc Δ . Consider the family of functions f regular in Δ such that $|f| \leq 1$ on Δ and at each point of A , a specified initial Taylor section is assigned. For $b \in \Delta$, let $W(b)$ denote the set of values assumed by the functions of the family at b . [As Heins explains in the original article “ $W(b)$ is termed the *Wertevorrat* of the family at b .”] The Pick-Nevalinna-Grenzkreis phenomenon asserts that if there is more than one function in the family and $b \in \Delta - A$, then the set $W(b)$ is a closed circular disc of positive radius. The author constructs a counter example to show that this is no longer true for multiply connected domains. Let Ω be the annulus $r < |z| < r^{-1}$ and let $B(c)$ denote the set of functions f , analytic in Ω , such that $|f| \leq 1$, $f(-1) = 0$ and $f'(-1) = c$, where c is small and positive. The author shows that in this case $W(b)$, $b \neq -1$, is a set with nonempty interior but is not a circle.—A result of Garabedian 1949 [276] asserts that if Ω is a domain of finite connectivity such that no boundary component reduces to a point and if the values of the function are assigned at a finite number of points, then the unique extremal function which takes at b a given value on $\text{Fr}W(b)$ maps Ω onto Δ with constant valency. The author shows that this remains true for his example although the initial Taylor section assigned is of order one at $z = -1$. There is also a general discussion of the problem in the general setting of Riemann surfaces with finite topological characteristics.” ♠ [07.10.12] as a modest task one may wonder if Heins’ paper

reproves Ahlfors' existence of circle maps of degree $\leq r+2p$. As a pessimistic remark it seems that there is a wide variety of extremal problems, somehow reflecting our mankind capitalistic/competitive aberration, making it unclear what the God given problem is, especially the one capturing circle maps of lowest possible degree ♠ more optimistically it is clear that there is a fascinating body of knowledge among such problems (interpolation by prescribed Taylor section). Given a finite Riemann surface \overline{F} (bordered), choose a finite set A each point being decorated by a Taylor section (w.r.t. a local uniformizer), look at all functions bounded-by-one matching the Taylor data. For any $b \in F - A$, define $W(b) \subset \Delta$ as the set of values assumed at b by functions of the family. ♠ as above we look at the function $f_{b,w}$ taking at b a given value w of the frontier of $W(b)$. Q1. Is then Garabedian's result on the constant valency of $f_{b,w}: F \rightarrow \Delta$ true in this non-planar setting? If yes what is the degree of the corresponding circle map (Q2). Of course the case where $A = \{a\}$ is a singleton with Taylor section $f(a) = 0$ ($b \neq a$) and w chosen so as to maximize the modulus in the set $W(b)$ gives exactly the Ahlfors map $f_{a,b}$ studied in Ahlfors 1950 [17]. This induces (via the assignment $\overline{F} \mapsto |f_{a,b}(b)|$) a real-valued function $M_{r,p} \rightarrow]0, 1[$ on the moduli space of surfaces with two marked points. One can dream about understanding the Morse theory of this function. ♠ The answer to our two naive questions (Q1, Q2) is apparently already in Heins' paper, for Jenkins-Suita 1979 [393, p. 83] write: "Quite recently Heins [10](=1975 [361]) proved uniqueness of the extremal function f_0 which maximizes $\operatorname{Re}(e^{i\theta} f(z_0))$ among the class of analytic functions f bounded by unity and with given Taylor sections [...] on a compact bordered Riemann surface Ω . He also proved the extremal f_0 maps Ω onto a finite sheeted covering of the unit disc and gave a bound on the number of sheets called the *Garabedian bound*." ♠ [07.10.12] as a micro-objection the terming "Garabedian bound" is probably slightly unfair for Ahlfors as the latter probably knew it (in the case of a single interpolating point) without Garabedian's helping hand (at least for circle maps, yet arguably not for the Ahlfors' extremals) (cf. of course the acknowledgments to be found in Ahlfors 1950 [17], but see also Nehari 1950 [591] where the Ahlfors upper bound $r + 2p$ is credited back to Ahlfors' Harvard lectures in Spring 1948) ♣ [12.10.12] Heins' statement is as follows (p. 18): "(3) *The Garabedian bound*. We consider a determinate Pick-Nevalinna problem relative to Ω with a finite set of data and denote the solution by f . [...] For an interpolation point b we let $\nu(b)$ denote the order of interpolation at b augmented by one. We let ν denote the sum of the $\nu(b)$ taken over the interpolation points b . The Euler characteristic of Ω will be denoted by χ . We shall show—**Theorem 8.2** *f has at most $\nu + \chi$ zeros counted by multiplicity.* ♣ this statement subsumes the upper estimate of Garabedian, but also that of Ahlfors: indeed Ahlfors extremal problem is the case where there is a single interpolating point of order zero. So $\nu = 0 + 1 = 1$. Now given a bordered surface Ω of genus p with r contours, we have $\chi(\Omega) = 2 - 2p - r$ [beware that Heins seems to work with the old convention about the sign of the Euler characteristic, hence just change his formula to $\nu - \chi$]. So we get $\deg f \leq \nu - \chi = \nu - 2 + 2p + r \approx r + 2p$ (note a little arithmetical discrepancy from Ahlfors, surely easily explained) ♣ Heins' proof uses the following tools: • basic facts concerning Hardy classes on Riemann surfaces for which one is referred to Heins 1969 [360] • a variational formula of F. Riesz 1920 [691] • the theorem of Cauchy-Read (cf. Read 1958 [676]) • the Fatou boundary function, • the Green's function • the qualitative Harnack inequality ♠ a slightly different proof of a much related result (on "Garabedian bound") is given as Theorem 3 of Jenkins-Suita 1979 [393], which uses maybe less machinery (?), an instead of Read the closely allied paper Royden 1962 [716]. Yet Jenkins-Suita's proof depend on Heins' proof when it comes to the "interpolation divisor" ♡5

[362] M. Heins, *Carathéodory bodies*, Comm. in honorem Rolf Nevanlinna LXXX annos nato, Ann. Acad. Sci. Fenn. Ser. A.I, Math. 2 (1976), 203–232. [♠ extension to the setting of finite Riemann surfaces of Carathéodory's theory on the "Variabilitätsbereich" (1907 [135], 1911 [136]) of coefficient of analytic functions with positive real part (bringing together Minkowski's theory of convex sets with complex function theory), while encompassing interpolation problems subsuming those of Pick-Nevalinna type] ★ ♡3

[363] M. Heins, *Extreme normalized analytic functions with positive real parts*, Ann. Acad. Sci. Fenn. Ser. A. I. Math. 10 (1985), 239–245. A50 [♠ localized via Bell 2009/11 [74] ♠ also quoted in Khavinson 1984 [425, p. 377] for another proof of the Bieberbach-Grunsky theorem ♠ Heins handles the more general non-planar case recovering probably the Ahlfors circle maps of 1950, and so seems indeed to be the

case according to MathReviews (translated from Hervé’s review in Zentralblatt): “Let P be the family of holomorphic functions f on a given Riemann surface S satisfying $\operatorname{Re} f > 0$ on S and $f(a) = 1$ for a given point $a \in S$. If S is the unit circle, the extremal elements of P are the functions $z \rightarrow (\eta + z)/(\eta - z)$, $|\eta| = 1$. If S is a bounded open plane region whose boundary consists of c analytic Jordan curve $\Gamma_1, \dots, \Gamma_c$, the author associates the extremal elements f_ζ of P with the system $\zeta = (\zeta_1, \dots, \zeta_c) \in \Gamma_1 \times \dots \times \Gamma_c$; $\operatorname{Re} f_\zeta$ is an appropriate linear combination of minimal harmonic functions > 0 on S with poles ζ_k , $k = 1, \dots, c$. This results extends to the case in which S is an open region of a compact Riemann surface of genus g , but here the real parts of the extremal element of P are linear combination of [AT MOST]³⁴ $2g + c$ minimal positive harmonic functions on S .” ♠ [06.10.12] so it seems that this new work of Heins, albeit quite close to Heins 1950 [358], may be a bit more explicit and truly include the existence of (Ahlfors) circle map with the bound $r + 2p$ like Ahlfors 1950 [17] ♠ [06.10.12] it would be of course of primary importance to study if Heins’ methods is susceptible of recovering the sharper $r + p$ bound asserted in Gabard 2006 [255] ♠ [12.10.12] after reading the original text, it must alas recognize that Heins’ proof is not perfectly satisfactory, for when it comes to the case of positive genus, he writes simply (p. 243): “the corresponding developments of Section 3 [=planar case] may be paraphrased.” ♠ hence the pedestrian reader will not find it easy to recover even Ahlfors basic (but deep) result from Heins’ account. So let me try once to degage the substance of the argument, while trying to locate “en passant” those critical steps which in our opinion is not made explicit in Heins’ exposition. (I shall use my notation hopefully for convenience of the reader.) We start as usual with \overline{F} a compact bordered Riemann surface of genus p and with r contours. Let $a \in F$ be some fixed interior point. Heins considers P the set of analytic functions f on F with $\operatorname{Re} f > 0$ and $f(a) = 1$. (The family P is convex and compact, hence admits extreme points by Krein-Milman. Actually we shall probably not need this, albeit being an interesting viewpoint.) Let $g := 2p + (r - 1)$ and $\gamma_1, \dots, \gamma_g$ be representatives of the homology group $H_1(F)$. For u harmonic on F , let $\pi(u)$ be the period vector given by $\pi(u) = (\int_{\gamma_1} \delta u, \dots, \int_{\gamma_g} \delta u)$, where δu is a certain abelian differential given by some local recipe. In fact it is perhaps more natural (and equivalent?) to define δu as the conjugate differential $(du)^*$. For $\zeta \in \partial F$, Heins considers (p. 241) u_ζ the minimal positive harmonic function on F vanishing on $\partial F - \{\zeta\}$ and normalized by $u_\zeta(a) = 1$. [Maybe here Heins still relies subconsciously on Martin 1941 [529], yet arguably this is nothing else that the Green’s function with pole pushed to the boundary, what I called a Red’s function, but perhaps calls it a Poisson function, as may suggest the paper Forelli 1979 [246].] We seek to construct a half-plane map f by taking a combination $u = \sum_{k=1}^d \mu_k u_{\zeta_k}$ of such elementary potentials, with $\mu_k > 0$ while trying to arrange the free parameters (e.g. the $\zeta_k \in \partial F$) so as to kill all periods of $(du)^*$. If this can be achieved for some d , then $f = u + iu^*$ (where u^* is defined by integrating the differential $(du)^*$) supplies a half-plane map of degree d . (Recall indeed that u vanishes continuously on the boundary ∂F , except at the ζ_k which are catapulted to ∞ . Hence the map is boundary preserving and has therefore constant valency, here d .) To kill all periods, we may look at the map $\varphi: \partial F \xrightarrow{u} h(F) \xrightarrow{\pi} \mathbb{R}^g$, where $u(\zeta) = u_\zeta$ and $h(F)$ denotes the space of harmonic functions. At this stage it must be explained that the image $\varphi(\partial F)$ is “balanced”, i.e. not situated in a half space of \mathbb{R}^g . [I am not sure that Heins explains this in details.] If so then it is plain that there is a collection of $d \leq g + 1$ points (assume $d = g + 1$ if you want) on $\varphi(\partial F)$ spanning a simplex containing 0. This is just the principle that in Euclidean space of some dimension, a collection of one more points than the given dimension span a top-dimensional simplex with optimum occupation property of the territory (=Euclid space). Thus expressing the origin as convex combination of those $g + 1$ points we find scalars $\mu_k > 0$, which injected in the formula defining u , gives us an u meeting the requirement. This reproves Ahlfors 1950, but alas I still do not have a simple explanation for the balancing condition. Next the challenge, is of course to improve the geometry by remarking that clever placements of points may span a lower dimensional simplex yet still covering the origin. Hopefully one may reprove the $r + p$ upper bound of Gabard 2006 [255], along this path (which is essentially Ahlfors’ original approach). ♣

[364] M. Heins, *Extreme Pick-Nevanlinna interpolating function*, J. Math. Kyoto Univ. 25–4 (1985), 757–766. [♠ p. 758: “It is appropriate to cite instances of convexity

³⁴Gabard’s addition

considerations related to the present paper. The pioneer work of Carathéodory [2](=1907 [135]),[3](=1911 [136]) on coefficient problems for analytic functions with positive real part is, as far I am aware, the first bringing together of the Minkowski theory of convex sets and complex function theory. Extreme points are present in the fundamental work of R. S. Martin [12](=1941 [529]) on the representation of positive harmonic functions as normalized minimal positive harmonic functions. My paper [7](=Heins 1950 [358]) showed the existence of minimal positive harmonic functions on Riemann surfaces using elementary standard normal families results without the intervention of the Krein-Milman theorem and gave application to qualitative aspects of Pick-Nevalinna interpolation on Riemann surfaces with finite topological characteristics and nonpointlike boundary components. Such Riemann surfaces will be termed *finite* Riemann surfaces henceforth. In [8](=Heins 1976 [362]) the Carathéodory theory cited above was extended to the setting of finite Riemann surfaces for interpolation problems subsuming those of Pick-Nevalinna type. Forelli [5](=1979 [246]) has studied the extreme points of the family of analytic functions with positive real part on a given finite Riemann surface S normalized to take the value 1 at a given point of S . In my paper [9](=Heins 1985 [363]) the results of Forelli were supplemented by precise characterizing results for the case where the genus of S is positive.” ♡0

- [365] D. A. Hejhal, *Linear extremal problems for analytic functions*, Acta Math. 128 (1972), 91–122. A50, G78 [♠ generalized extremal problem, existence as usual via normal families, and so uniqueness is given “a reasonably complete answer” (p. 93) ♠ p.119 Royden 1962 [716] is cited for another treatment of Ahlfors’ extremal problem] ♡8
- [366] D. A. Hejhal, *Theta functions, kernel functions and Abelian integrals*, Memoirs Amer. Math. Soc. 129, 1972. [♠ quoted in Burbea 1978 [125], where like in Suita 1972 [813] an application of the Ahlfors function is given to an estimation of the analytic capacity] ★ ♡44
- [367] D. A. Hejhal, *Some remarks on kernel functions and Abelian differentials*, Arch. Rat. Mech. Anal. 52 (1973), 199–204. G78 ♡5
- [368] D. A. Hejhal, *Universal covering maps for variable regions*, Math. Z. 137 (1974), 7–20. G78 [♠ just quoted for the philosophical discussion on p.19, especially the issue that the (Koebe) Kreisnormierung (=circular mapping) [not to be confused with our circle maps!] is “*somewhat more involved* than the other canonical mappings, esp. the PSM] ♡35
- [369] D. A. Hejhal, *Linear extremal problems for analytic functions with interior side conditions*, Ann. Acad. Sci. Fenn. Ser. A 586 (1974), 1–36. G78 [♠ cited in Jenkins-Suita 1979 [393]]★ ♡??
- [370] K. Hensel, W. Landsberg, *Theorie der algebraischen Funktionen einer Variablen und ihre Anwendung auf algebraische Kurven und Abelsche Integrale*, Leipzig, 1902. [♠ contains the sharp estimate $[(g+3)/2]$ of Riemann-Brill-Noether upon the gonality of a closed surface, but the treatment is not considered as convincing (to contemporary scientists) until the work of Meis 1960 [541], compare e.g., H. H. Martens 1967 [528] and Kleiman-Laksov 1972 [428]] ♡28
- [371] G. Herglotz, *Über Potenzreihen mit positivem reellen Teil im Einheitskreis*, Ber. Verhandl. Sächs. Ges. Wiss. Leipzig 93 (1911), 501–511. [♠ yet another theorem in the disc susceptible (???) of a transplantation to finite bordered Riemann surface, try e.g Agler-Harland-Raphael 2008 [10] (multi-connected planar domains), or Heins 1985 [364] ♠ Herglotz’s representation theorem is concerned with the so-called Poisson-Stieltjes representation for analytic functions on the unit disc Δ with ≥ 0 real part (simultaneous work by F. Riesz), and cf. the above cited work of Heins for an application (of Herglotz-Riesz 1911) to a description of extreme points of a class I of analytic function arising from a Pick-Nevalinna interpolation problem involving functions $\Delta \rightarrow \{\text{Re}z > 0\}$: “Theorem 1. The extreme points of I [in the sense of convex geometry] are precisely the members of I having constant valence on $\{\text{Re}z > 0\}$, the value ν of the valence satisfying $1+n < \nu < 1+2n$.” [n being the number of interpolation points] ♠ such results are probably extensible to the situation where the source (=disc Δ) is replaced by a finite bordered Riemann surface, and the resulting theory probably interacts with the Ahlfors map ♠ [13.10.12] in fact the Poisson-Stieltjes-Herglotz-Riesz representation formula is rather involved in another proof of Ahlfors circle maps, see for this Forelli’s brilliant account (1979 [246])] ♡115

- [372] J. Hersch, *Quatres propriétés isopérimétriques de membranes sphériques homogènes*, C. R. Acad. Sc. Paris 270 (1970), 1645–1648. [♠ contains 4 spectral (eigenvalues) inequalities for disc-shaped membranes emphasizing the extremality of resp. the round sphere, the hemisphere, the quarter of sphere and of the octant of sphere ♠ the first inequality has been extended via conformal transplantation to closed surfaces of higher topological type by Yang-Yau 1980 [898] (who failed to take advantage of the well-known sharp gonality bound of Riemann-Meis (1960 [541]), but see El Soufi-Ilias 1983/84 [221]) ♠ the first inequality has been extended by Gabard 2011 [256] upon using the Ahlfors map ♠ [08.10.12] of course it would be also interesting trying to get extensions of the two remaining Hersch’s inequalities (involving the quarter of sphere and its octant resp.)] ♥141
- [373] M. Hervé, *Quelques propriétés des transformations intérieures d’un domaine borné*, Ann. sci. École norm. sup. (3) 68 (1951), 125–168. G78 [♠ Grunsky’s works, as well as Ahlfors 1947 [16] are cited, and it could be nice to look for extensions to bordered surfaces] ♥12
- [374] D. Hilbert, *Über das Dirichletsche Prinzip*, Jahresb. d. Deutsch. Math.-ver. 8 (1900), 184–188. [♠ [08.10.12] the technological breakthrough based upon the “direct method” in the calculus of variation, where one directly minimizes the integral (without transiting to its first variation, alias Euler-Lagrange equation) via the idea of minimizing sequences implying a topologization of the space of test functions while checking its compactness (=Fréchet’s jargon) of the resulting family ♠ the method also differs from its predecessors Schwarz-Neumann-Poincaré where the problem was first solved for the disc and combinatorial tricks permitted proliferation to higher topological complexity] AS60 ♥??
- [375] D. Hilbert, *Über das Dirichletsche Prinzip*, Math. Ann. 59 (1904), 161–186. (Abdruck aus der Festschrift zur Feier des 150jährigen Bestehens der Königl. Gesellschaft der Wissenschaften zu Göttingen 1901.) AS60 ♥?? [♠ p. 161 (Introd.): “Unter dem Dirichletschen Prinzip verstehen wir diejenige Schlußweise auf die Existenz einer Minimalfunktion, welche Gauss (1839)[= [287]], Thomson (1847)[= [828]], Dirichlet (1856)[=of course much earlier, at least as early as when Riemann studied in Berlin, ca. 1849–50!] und andere Mathematiker zur Lösung sogenannter Randwertaufgaben angewandt haben und deren Unzulässigkeit zuerst von Weierstrass erkannt worden ist. [...] Durch das Dirichletsche Prinzip hat insbesondere Riemann die Existenz der überall endlichen Integrale auf einer vorgelegten Riemannschen Fläche zu beweisen gesucht. Ich bediene mich im folgenden dieses klassischen Beispiels zur Darlegung meines strengen Beweisverfahrens.”] ♥84
- [376] D. Hilbert, *Über das Dirichletsche Prinzip*, J. Reine Angew. Math. 129 (1905), 63–67. (Abdruck eines Vortrages aus dem Jahresb. d. Deutsch. Math.-ver. 8 (1900), 184–188.) AS60 ♥??
- [377] D. Hilbert, *Zur Theorie der konformen Abbildung*, Gött. Nachr. (1909), 314–323; Ges. Abh. 3, 73–80. G78 [♠ parallel-slit mapping including positive genus (and infinite connectivity) ♠ influenced much Courant, and also Koebe 1910 [457]] ♥8
- [378] D. Hilbert, *Über die Gestalt einer Fläche vierter Ordnung*, Gött. Nachr. (1909), 308–313; Ges. Abh. 2, 449–453. [♠ contains a good picture for the construction of Harnack maximal sextic] ♥??
- [379] S. Hildebrandt, H. von der Mosel, *Conformal mapping of multiply connected Riemann domains by a variational approach*, Adv. Calc. Var. 2 (2009), 137–183. [♠ new proof of the Kreisnormierung for (planar) domains via Plateau-style method ♠ question: can we apply the same method for the (Ahlfors) circle map? (cf. Courant 1939 [191] for the planar case [$p = 0$]) ♠ “Abstract. We show with a new variational approach that any Riemannian metric on a multiply connected schlicht domain in \mathbb{R}^2 can be represented by globally conformal parameters. This yields a “Riemannian version” of Koebe’s mapping theorem.”] ♥6
- [380] S. Hildebrandt, *Plateau’s problem and Riemann’s mapping theorem*, Milan J. Math. (2011), 67–79. [♠ survey putting in perspective several recent developments, including the previous item] ♥0
- [381] K. Hoffman, *Banach spaces of analytic functions*, Prentice-Hall (Englewood Cliffs), 1962; Dover Reprint, 1988. ♥2566
- [382] J. Huisman, *On the geometry of algebraic curves having many real components*, Rev. Mat. Complut. 14 (2001), 83–92. [♠ p.87, Prop.3.2 contains an algebro-geometric proof of the so-called Bieberbach-Grunsky theorem (for antecedent along

- similar lines compare Enriques-Chisini 1915/18 [225], Bieberbach 1925 [97], and Wirtinger 1942 [891]) ♠ of course Huisman’s paper goes much deeper by exploring the properties of linear series on Harnack maximal curves (alias M -curves)] ♡17
- [383] A. Hurwitz, *Über die Perioden solcher eindeutiger, $2n$ -fach periodischer Funktionen, welche im Endlichen überall den Charakter rationaler Funktionen besitzen und reell sind für reelle Werte ihrer n Argumente*, J. Reine Angew. Math. 94 (1883), 1–20. (Math. Werke, Bd. I) [♠] ♡??
- [384] A. Hurwitz, *Über Riemannsche Flächen mit gegebenen Verzweigungspunkten*, Math. Ann. 39 (1891), 1–61. [♠ [13.10.12] if we fix a ramification divisor in the sphere of degree b and a mapping degree d there is finite number of Riemann surfaces F of Euler characteristic $\chi(F) = d\chi(S^2) - b$ having the prescribed topological behaviour (Hurwitz is able to make a fine study, using of course the monodromy and so to get upper bounds on the number of admissible maps). It seems evident that the game should extend in the bordered setting in the context of Ahlfors circle maps, which are truly (upon doubling) real maps of a special kind (totally real, saturated or separating) from Klein’s orthosymmetric real curves to the real projective line. Then one can try to adventure into similar group theoretical (combinatorial) games as did Hurwitz in the complex case (in fact Hurwitz himself give close attention to reality questions) ♠ a more modest question is whether a careful variation of branch points does not produce a quick “action-painting” or “sweeping out” proof of the existence of circle maps of lowest possible degree. ♠ as yet I was never able to proceed along this way, which looks yet a reasonable strategy for in the complex case such argument yield at least the right prediction about the gonality of complex curves as divinized by Riemann 1857 (cf. e.g. the heuristic count in Griffiths-Harris 1978 [303]). I remind clearly that this idea was suggested by Natanzon (Rennes ca. 2001), and in Rennes 2001/02 (Winter) Johan Huisman also presented to me a simple moduli parameter count somehow comforting the bound $r + p$ (when I suggested him the possibility of the sharpened $r + p$ bound); for the details of Huisman’s count cf.] ♡??
- [385] A. Hurwitz, *Algebraische Gebilde mit eindeutigen Transformationen in sich*, Math. Ann. 41 (1893), 403–442. [♠ it is proved that if a conformal self-map of a closed Riemann surface of genus > 1 induces the identity on the first homology group then the self-map is the identity. Historically, one may wonder how this formulation borrowed from Accola ca. 1966 is reliable for the language of homology was not yet “invented” at least in this precise context (recall Poincaré 1895, but of course a myriad of people used the term “homology” in different contexts, e.g. Jordan) ♠ despite this detail the assertion is correct] ♡??
- [386] A. Hurwitz, R. Courant, *Funktionentheorie*, Springer-Verlag, Berlin, 1922. (Another edition 1929) [♠ contains another proof of the KN(=Kreismormierung) in finite connectivity, according to Schiffer-Hawley [756], also quoted for this purpose in Stout 1965 [802] ♠ Ahlfors once said (recover the source!!) that it this in this book that he learned the length-area principle so fruitful in the theory of quasi-conformal maps (roughly the pendant of Grötzsch’s Flächenstreifenmethode)] ♡high?
- [387] C. Jacob, *Sur le problème de Dirichlet dans un domaine plan multiplement connexe et ses applications à l’hydrodynamique*, J. Math. Pures Appl. 18 (1939), 363–383. G78 [♠ cf. also the next entry] ♡1
- [388] C. Jacob, *Introduction mathématique à la mécanique des fluides*, 1959. (ca. 1286 pp.) [♠] ♡106
- [389] C. G. J. Jacobi, *Considerationes generales de transcendentibus Abelianis*, Crelle J. Reine Angew. Math. 9 (1832), 394–403. [♠ Jacobi inversion problem, and first place where jargon like Abelian integrals are employed] ♡??
- [390] S. Jacobson, *Pointwise bounded approximation and analytic capacity of open sets*, Trans. Amer. Math. Soc. 218 (1976), 261–283. [♠ the Ahlfors function appears on p.261, 272, 274 in the context of analytic capacity, which is examined from the angle of the semi-additivity question (Vitushkin) ♠ the latter aspect has meanwhile been settled in the seminal breakthrough of Tolsa 2003 [834] giving also a complete (geometric) solution to Painlevé’s problem] ♡1
- [391] P. Järvi, *On some function-theoretic extremal problems*, Complex Variables Theory Appl. 24 (1994), 267–270. [♠ related to the Ahlfors function]★ ♡1
- [392] J. A. Jenkins, *Some new canonical mappings for multiply-connected domains*, Ann. Math. (2) 65 (1957), 179–196. AS60, G78 [♠ new derivation of the parallel-

slit maps (and radial avatar) in the slightly extended context of rectangular multi-connected domains (resp. radioactive) domains bounded respectively by rectangles or by rectangles in polar coordinates ♠ technique: the classical continuity method à la Brouwer-Koebe, but augmented by some quasi-conformal technology (à la Grötzsch, etc.)] ♥4

- [393] J. A. Jenkins, N. Suita, *On the Pick-Nevalinna problem*, Kōdai Math. J. 2 (1979), 82–102. [♣ includes probably an extension and thus also a new derivation of the Ahlfors circle map, compare also Heins 1975 [361] who probably already achieves this goal] ♥0
- [394] J. A. Jenkins, N. Suita, *On analytic maps of plane domains*, Kōdai Math. J. 11 (1988), 38–43. [♣ for D a plane bordered surface, an analytic map $f: D \rightarrow \Delta$ to another bordered surface is called *boundary preserving* if it takes boundary to boundary. “A boundary preserving map $f: D \rightarrow \Delta$ covers the image domain finitely many times. It can also be extended to the doubles as $\hat{D} \rightarrow \hat{\Delta}$. Now the Seveli-deFranchis’ theorem³⁵ states finiteness for the number of nonconstant analytic maps between two closed Riemann surfaces of genres both > 1 , hence we get as a dividend finiteness for the above boundary preserving maps, as soon as the genus of the doubles are > 1 . ♠ p.40: “Since f is boundary preserving, f has no branch points on the boundary.”, this is completely akin to the Ahlfors map ♠ of course the problematic addressed by Jenkins-Suita extends directly to bordered surface of positive genus, and it could be nice to work out corresponding bounds] ♥0
- [395] M. Jeong, *The Szegő kernel and a special self-correspondence*, J. Korea Soc. Math. Educ. Ser. B: Pure Appl. Math. 5 (1998), 101–108. [♠ the Ahlfors map is briefly mentioned in the following connection: “Since the zeroes of the Szegő kernel are parts of the zeroes of the Ahlfors map and give rise to a particular basis for the Hardy space $H^2(b\Omega)$ (see [5]=Bell 1995 [67]), they can be the powerful tools for getting the properties of the mapping for planar domains.”] ♥0
- [396] M. Jeong, M. Taniguchi, *Bell representations of finitely connected planar domains*, Proc. Amer. Math. Soc. 131 (2002), 2325–2328. [♠ a problem posed by Bell (1999/2000) is given a positive answer, even in the following sharper form: “Theorem 1.2. Every non-degenerate n -connected planar domain with $n > 1$ is mapped biholomorphically onto a domain defined by $\{|z + \sum_{k=1}^{n-1} \frac{a_k}{z-b_k}| < 1\}$ with suitable complex numbers a_k and b_k .” ♠ the philosophy of such Bell’s domain is a sort of reverse engineering: instead of constructing the Ahlfors function of a given domain one first gives the function f and define the domain as $|f(z)| < 1$ ♠ p.2326, it is observed that Bell’s domains depend on $2n - 2$ complex parameters (so $4n - 4$ real parameters) exceeding the $3g - 3 = 3(n - 1) - 3 = 3n - 6$ real moduli predicted by Riemann-Schottky-Klein-Teichmüller ♠ this discrepancy is explained by the fact “that every Bell domain is actually associated with an n -sheeted branched covering of the unit disk”, for knowing the a_k, b_k we may construct the circle-map $f(z) = z + \sum_{k=1}^{n-1} \frac{a_k}{z-b_k}$ (call it the Bell representation) ♠ of course the question arise of describing the “Ahlfors locus” (within the Hurwitz space) of those parameters a_k, b_k such that the Bell representation is actually an Ahlfors extremal function ♠ this problem is reposed again in Taniguchi 2004 [822] ♠ from the more traditional point view, starting from an n -connected domain (with contours C_1, \dots, C_n) one can construct a circle map (of minimal degree n) by prescribing boundary points $p_i \in C_i$ mapping to $1 \in S^1$ (Bieberbach-Grunsky), thus roughly speaking circle maps depends over n parameters, whereas the Ahlfors functions f_a (or $f_{a,b}$) depend only on 2 real parameters (resp. 4) ♠ compare maybe Agler-Harland-Raphael [10] (and its MathReview summary) for a description of the Grunsky functions as the extreme points of the compact convex set of holomorphic functions with positive real parts normalized by $f(z_0) = 1$ for some fixed interior point] ♥12
- [397] M. Jeong, *The exact Bergman kernel and the extremal problem*, Kangweon-Kyungki Math. J. 13 (2005), 183–191. [♠ the Ahlfors map appears twice on p. 185–6] ♥0
- [398] M. Jeong, J.-W. Oh, M. Taniguchi, *Equivalence problem for annuli and Bell representations in the plane*, J. Math. Anal. Appl. 325 (2007), 1295–1305. [♠ the Ahlfors function is employed in the problem of determining the parameter for which a certain doubly connected domain of Bell, namely $|z + z^{-1}| < r$, is conformal to a circular (concentric) ring] ♥6

³⁵Severi perhaps? Try also Hurwitz??

- [399] P. W. Jones, D. E. Marshall, *Critical points of Green's function, harmonic measure, and the corona problem*, Ark. Mat. 23 (1985), 281–314. A47, A50 [♠ p. 293–4 the Ahlfors function enters into the dance as follows: “We mention one more method for solving the corona problem. The previous methods have the drawback that Green’s function does not ignore subsets of $\partial\mathcal{R}$ which have zero analytic capacity and positive logarithmic capacity. To avoid this we can use Ahlfors’ function, A , instead. Ahlfors’ function for a point $\zeta_0 \in \mathcal{R}$ is defined by $A'_{\zeta_0}(\zeta_0) = \sup\{\operatorname{Re}f'(z_0) : f \in H^\infty(\mathcal{R}), \|f\|_\infty \leq 1\}$. [...] Ahlfors [1](=1947), [2](=1950) has shown that for our “nice” Riemann surfaces $|A_{\zeta_0}(\zeta)| = \exp\{-\sum_{j=0}^{n-1} g(\zeta, \zeta_j)\}$ for some points $\zeta_1, \dots, \zeta_{n-1} \in \mathcal{R}$. [...] Then all of the results of this section hold for the critical points of Ahlfors’ function $\{w_{j,k}\}$ as well as for the critical points of G . One can easily construct Riemann surfaces where $\sum_k G(\zeta_k, \zeta') = \infty$, so that the methods using the critical points of G will not work, yet this method using Ahlfors’ function gives solution to the corona problem. [...] We remark that we chose the Ahlfors function here because of its natural association with $H^\infty(\mathcal{R})$, but we could have chosen any function $F \in H^\infty(\mathcal{U})$ with $-\log|F(z)| = \sum_{j=1}^m G(\pi(z), \alpha_j)$, $\alpha_j \in \mathcal{R}$.” ♠ p. 286: “If \mathcal{R} is a planar domain, then it is a simple consequence of the argument principle that $G(\zeta, \pi(0))$ has $N - 1$ critical points (counting multiplicity), where N is the number of closed boundary curves. See e.g. [33](=Nehari 1952 [594])³⁶ More generally, the number of critical points of G is the first Betti number, or the number of generators of the first singular homology group, of \mathcal{R} [46](=Widom 1971 [885]), and hence is finite. See Walsh [44, Chap. VII](=Walsh 1950 [868]) for more information concerning the location of the critical points.”] ♡36
- [400] P. W. Jones, T. Murai, *Positive analytic capacity but zero Buffon needle probability*, Pacific J. Math. 133 (1988), 99–114. [♠ self-explanatory, i.e. a counter-example to the Vitushkin conjecture (that a plane compactum is a Painlevé null-set iff it is invisible, i.e. a.e. projection of the set have zero length) ♠ note: the Buffon needle problem was solved by Crofton in 1868: if E is a compactum in the plane, let $|P_\theta(E)|$ be the Lebesgue measure of the orthogonal projection of E_θ on the line of angular slope θ and define the Crofton invariant as $CR(E) = \int_0^{2\pi} |P_\theta(E)| d\theta$. This quantity may be interpreted as the probability of the body E falling over a system of parallel lines equidistantly separated by the diameter of E] ♡36
- [401] C. Jordan, *Sur la déformation des surfaces*, J. Math Pures Appl. (2) 11 (1866), 105–109. [♠ after Möbius 1863 [565] in the closed case, discuss a classification of compact orientable bordered surfaces, by the genus and the number of contours ♠ quoted in Klein’s lectures 1892/93 [440, p. 150], and in Weichold 1883 [873, p. 330], who need the non-orientable case as well] ♡17
- [402] J. Jost, *Conformal mappings and the Plateau-Douglas problem in Riemannian manifolds*, J. Reine Angew. Math. 359 (1985), 37–54. [♠ reprove some results about conformal mapping (uniformization of real orthosymmetric curves) surely well-known since Koebe’s era (and conjectured by Klein) via the method of Plateau ♠ then attack and solve a very general case of Plateau’s problem in a generality unifying the desire of Douglas (positive genus) and Morrey (curvy ambient Riemannian manifold instead of flat Euclid) ♠ reports also some of Tromba’s critics over the solution of Courant to the Plateau-Douglas problem of higher genus ♣ it is not clear to the writer if such critics (of Tromba) affects as well the whole content of Courant’s book 1950 [195] especially regarding the varied type of conformal maps ♠ at any rate Jost propose a parade using techniques of Mumford and Schoen-Yau, but the “meandrousness” of the resulting proof is slightly criticized in Hildebrandt-von der Mosel 2009 [379]] ♡36
- [403] J. Jost, *Two-dimensional geometric variational problem*, Wiley, New York, 1991. [♠ from Sauvigny’s review in BAMS: “Chapter 3 deal with conformal representation of surfaces homeomorphic to the sphere S^2 , circular domains, and closed surfaces of higher genus. The proof is given by direct variational methods and not as usual by uniformization, completing a fragmentary proof of Morrey.”] ♡??
- [404] G. Julia, *Sur la représentation conforme des aires simplement connexes*, C. R. Acad. Sci. Paris 182 (1926), 1314–1316. [♠ another characterization of the (Riemann) mapping function by a minimum principle] ♡??
- [405] G. Julia, *Développement en série de polynômes ou de fonctions rationnelles de la fonction qui fournit la représentation conforme d’une aire simplement connexe sur un cercle*, Ann. Éc. Norm. Sup. 44 (1927), 289–316. [♠ Seidel’s summary: a

³⁶Try also Nevanlinna.

- determination of a sequence of polynomials is given which converges to the properly normed (Riemann) mapping function of a simply connected region] ♡??
- [406] G. Julia, *Leçon sur la représentation conforme des aires simplement connexes*, Gauthier-Villars, Paris, 1931. [♠ one among the early book format exposition of the extremal properties of the Riemann mapping for a plane simply-connected region (distinct of \mathbb{C}), namely that the range of the map normalized by $f'(z_0) = 1$ has minimal area (first in Bieberbach 1914 [92]) or that the boundary of the range has minimal length (probably first in Szegö 1921 [818]) ♠ for both those extremal principles see also the detailed treatment in the book Gaier 1964 [258]] ♡16
- [407] G. Julia, *Sur la représentation conforme des aires multiples connexes*, Ann. Sc. Norm. Sup. Pisa (2) 1 (1932), 113–138. G78 [♠ still in great admiration for Schottky 1877 [763] and use Klein’s jargon of orthosymmetry, yet confined to the case of domains ♠ however the main purpose is the study of a new sort of mapping introduced by de la Vallée Poussin (and which will in turn fascinate Walsh and Grunsky)] ♡??
- [408] G. Julia, *Reconstruction d’une surface de Riemann σ correspondant à une aire multiples connexe \mathcal{A}* , C.R. Acad. Sci. Paris 194 (1932), 423–425. AS60 ♡??
- [409] G. Julia, *Prolongement d’une surface de Riemann σ correspondant à une aire multiples connexe \mathcal{A}* , C.R. Acad. Sci. Paris 194 (1932), 580–583. AS60 ♡??
- [410] G. Julia, *Leçon sur la représentation conforme des aires multiples connexes*, Gauthier-Villars, Paris, 1934, 94 pp. AS60, G78 [♠] ♡20
- [411] G. Julia, *La représentation conforme des aires multiples connexes*, L’Enseign. Math. 33 (1935), 137–168. G78 [♠ survey from Riemann, Schottky 1877 [763] through Hilbert 1909 [377], Koebe, up to the extremal treatments by de Possel and Grötzsch (slit mappings in infinite connectivity)] ♡??
- [412] G. Julia, *Quelques applications fonctionnelles de la topologie*, Reale Accademia d’Italia Fondazione A. Volta, Att dei Convegni 9 (1939), Rome, 1943, 201–306. AS60 [♠ cited in Ahlfors-Sario 1960]★★★ ♡??
- [413] M. Juurchescu, *A maximal Riemann surface, ??? ? (1961?)*, 91–93. [♠ p. 91, a map between bordered Riemann surfaces taking boundary to boundary is termed *distinguished*] ♡3
- [414] S. Kakutani, *Rings of analytic functions*, Lectures on functions of a complex variable, 71–83, Univ. of Michigan Press, Ann Arbor, 1955. [♠]★ ♡??
- [415] L. V. Kantorovič, *FOUR ARTICLES IN FRENCH in the period 33–34 including multi-connected and potentially based upon Bieberbach’s method* ★★★ ♡??
- [416] L. V. Kantorovič, V. I. Krylov, *Methods for the approximate solution of partial differential equations*, Leningrad–Moscow, 1936, Russian. [♠ Chap. V is devoted to conformal mapping. § 1 is introductory. § 2 takes up the method of Bieberbach (1914 [92]) which reduces the problem of conformal mapping to a minimum principle (for the area). This is then solved by Ritz’s method. In § 3 a second extremal property for mapping functions is discussed and Ritz’s method is again applied § 4 takes up orthogonal polynomials of Szegö and Bochner-Bergman types and applies them to the above minimizing problems.]★★★ ♡??
- [417] M. V. Keldysh, M. A. Lavrentief, *Sur la représentation conforme des domaines limités par des courbes rectifiables*, Ann. Sci. Éc. Norm. Sup. 54 (1937), 1–38. [♠ only the case of simply-connected domains bounded by a rectifiable Jordan curve in the plane, but deep questions about the boundary behavior of the Riemann map φ as well as the Smirnov problem of deciding when the harmonic function $\log |\varphi'(w)|$ is representable in the unit-disc by the Poisson integral of its (limiting) values on the circumference] ♡??
- [418] M. V. Keldysh, *Sur la résolubilité et la stabilité du problème de Dirichlet*, C.R. Acad. Sci. URSS 18 (1938), ???–??? (French). [♠ quoted in Walsh-Sinclair 1965]★★★ ♡??
- [419] M. V. Keldysh, *Sur l’approximation en moyenne quadratique des fonctions analytiques*, Mat. Sb. (N.S.) 5 (1939), 391–401. [♠ quoted in Walsh-Sinclair 1965]★★★ ♡??
- [420] M. V. Keldysh, *Conformal mappings of multiply connected domains on canonical domains*, (Russian) Uspehi Mat. Nauk 6 (1939), 90–119. G78 [♠ a survey of the developments in the field, up to 1939] ♡??

- [421] O.D. Kellogg, *Foundations of potential theory*, Grundlehren der math. Wiss. 31, Springer, Berlin, 1929. [♠ “Introduction to fundamentals of potential functions covers: the force of gravity, fields of force, potentials, harmonic functions, electric images and Green’s function, sequences of harmonic functions, fundamental existence theorems, the logarithmic potential, and much more.”] ♡2284
- [422] G. Kempf, *Schubert methods with an application to algebraic curves*, Stichting wiskundig centrum, Amsterdam, 1971. [♠ the first (simultaneous with Kleiman-Laksov 1972 [428]) existence proof of special divisors in the general case, extending thereby the result of Meis 1960 [541]] ♡??
- [423] N. Kerzman, E. M. Stein, *The Cauchy kernel, the Szegő kernel, and the Riemann mapping function*, Math. Ann. 236 (1978), 85–93. [♠ quite influential, especially over Bell] ♡??
- [424] G. Khajalia, *Sur la représentation conforme des domaines doublement connexes*, (French) Mat. Sb. N. S. 8 (1940), 97–106. G78 [♠ Seidel’s summary: the problem of mapping a doubly connected finite region on a circular ring is reduced to minimizing an area integral for a certain class of functions. If the region is accessible from without, then a sequence of minimal rational fractions converges uniformly to the desired mapping function ♠ in fact the condition in question seems to ensure the least area map (minimizing $\int \int_B |f'(z)|^2 d\omega$) to be schlicht and maps it upon the concentric circular ring $1 < |w - w_0| < R$, thus the problem is different from that à la Bieberbach-Bergman handled in Kufareff 1935/37 [483] where the least area map is not univalent ♠ a naive question [05.08.12] is whether Khajalia’s method could perform the Kreisnormierung in higher connectivity] ♡??
- [425] D. Khavinson, *On removal of periods of conjugate functions in multiply connected domains*, Michigan Math. J. 31 (1984), 371–379. A50 [♠ p. 377 reproves the Bieberbach-Grunsky-Ahlfors theorem in the planar case while quoting Heins 1950 [358] and using the classical device of annihilating “the periods of the conjugate function”] ♡8
- [426] G. Kirchhoff, *Über das Gleichgewicht und die Bewegung einer elastischen Scheibe*, J. Reine Angew. Math. 40 (1850), 51–88. [♠ Riemann was aware of this ref. in connection to the Dirichlet principle (cf. Neuenschwander 1981 [598]), yet never mentions it in print ♠ the next big revolution is Ritz, see Gander-Wander 2012 [274] for a thorough “mise en perspective”] ♡464
- [427] S. Kirsch, *Transfinite diameter, Chebyshev constant and capacity*, in: Handbook of Complex Analysis, Elsevier, 2005. A50 [♠ extract from the web (whence no page): “Ahlfors generalized Garabedian’s result to regions on Riemann surfaces [2](=Ahlfors 1950 [17]); see Royden’s paper [159](=1962 [716]) for another treatment as well as further references to the literature.” ♠ compare (if you like) our (depressive) Section 22.2 for a complete list of “dissident” authors having apparently (like me) some pain to digest Ahlfors proof, and therefore cross-citing often Royden ♠ “Abstract. The aim of the present chapter is to survey alternate descriptions of the classical transfinite diameter due to Fekete and to review several generalizations of it. Here we lay emphasis mainly on the case of one complex variable. We shall generalize this notion. . .”]★★ ♡9
- [428] S. L. Kleiman, D. Laksov, *On the existence of special divisors*, Amer. J. Math. 94 (1972), 431–436. [♠ cite Riemann 1857 [687], Hensel-Landsberg 1902 [370] for linear series of dimension 1, and Brill-Noether 1874 [116], Severi 1921 [780] in the general case ♠ supplies an existence proof of its title via Schubert calculus, Poincaré’s formula, some EGA (=Grothendieck), and a bundle constructed in Kempf’s thesis ♠ compare Kempf 1971 [422] for a simultaneous solution of the same fundamental problem ♠ [08.10.12] since this Kempf-Kleiman-Laksov result includes as a special case the result of Meis 1960 [541], it enables one eradicating Teichmüller theory from the gonality problem (this is not so surprising for Poincaré’s formula is essentially “homology theory” (intersection theory) specialized to the Jacobian variety, and the theta-divisor, image the $(g - 1)$ -symmetric power $C^{(g-1)}$ of the curve into the Jacobian via the Abel map ♠ thus roughly speaking (and with some imagination) we are back to the method used in Gabard 2006 [255] ♠ for less arrogant looseness it would be nice to adapt the methods of Kempf/Kleiman-Laksov to the problem of the Ahlfors mapping with sharp bounds (i.e. like in Gabard 2006 [255] granting of course the latter to be correct, else)] ♡73
- [429] S. L. Kleiman, D. Laksov, *Another proof of the existence of special divisors*, Acta Math. 132 (1974), 163–176. [♠ cite Gunning’s work of 1972 [326] as an alternative

to Meis' (for linear series of dimension 1) ♠ novel proof via the theory of singularities of mappings (Thom polynomial, Porteous' formula, plus influence of Mattuck) ♠ [08.10.12] like in the previous entry, try again to specialize the Thom-Porteous technique to the context of real algebraic geometry (orthosymmetric curve à la Klein) so as to recover the circle maps of Ahlfors 1950 [17], optionally with the bound of Gabard 2006 [255] ♠ of course the view point of special divisors (=essentially those moving in linear systems g_d^r of dimensions higher than predicted by Riemann's inequality $\dim |D| \deg D - g$ (due to the g constraints imposed by Abelian differentials) seems to indicate that the theory of the Ahlfors map is just the top of a much larger iceberg, probably already partially explored by experts (Coppens, Huisman, Ballico, Martens, Monnier, etc.) ♡63

- [430] F. Klein, *Über eine neue Art der Riemannschen Flächen* (Erste Mitteilung), Math. Ann. 7 (1874), also in Ges. math. Abh. II, 89–98. [♠ first apparition of some “new” types of Riemann surface, which later will evolve to the concept of “Klein surfaces”, but at this stage this is merely a synthetic visualisation of the complex locus of a plane curve defined over the reals upon the real projective plane via the map assigning the unique real point of an imaginary line. Also this is not yet “*was ich den “echten” Riemann zu nennen pflege*” as Klein expresses himself in the Introd. to volume 2 of his Coll. Papers [443, p. 5] ♠ however it is obvious that this mode of representation is almost forgotten by now and perhaps it could be useful in the future (e.g., to reprove the Rohlin inequality saying that plane dividing curves have at least as many ovals than their half degree, cf., e.g., Gabard 2000 [253] for more details and the original refs.) ♡??
- [431] F. Klein, *Über den Verlauf der Abelschen Integrale bei den Kurven vierten Grades* (Erster Aufsatz), Math. Ann. 10 (1876); also in Ges. math. Abh. II, 99–135. ♡??
- [432] F. Klein, *Über eine neue Art von Riemannschen Flächen* (Zweite Mitteilung), Math. Ann. 10 (1876), also in Ges. math. Abh. II, 136–155. [♠ p. 154 the first place where the dichotomy of “dividing” curves appears, under the designation “Kurven der ersten Art/zweiten Art” depending upon whether its Riemann surface is divided or not by the real locus (this is from where derived the Russian terminology type I/II) [hopefully Klein came up later with the better terminology ortho- vs. diasymmetric!] ♠ p. 154 contains also the first intrinsic proof of the Harnack inequality (1876)] ♡28
- [433] F. Klein, *Ueber die conforme Abbildung von Flächen*, Math. Ann. 19 (1882), 159–160. [♠ a lovely announcement of the next item [434], showing a little influence of Schwarz (Ostern 1881). NB: item not reproduced in the Ges. math. Abh.] ♡??
- [434] F. Klein, *Über Riemann's Theorie der algebraischen Funktionen und ihrer Integrale* B. G. Teubner, Leipzig, 1882. AS60 [♠ a masterpiece where Klein's theory reaches full maturity ♠ long-distance influence upon Teichmüller 1939 [825] (moduli problems including the case of possibly non-orientable surfaces, alias Klein surfaces since Alling-Greenleaf), and Douglas 1936–39 [210, 212] and also Comessatti 1924/26 [181], Cecioni 1933 [163], etc. ♣ evident (albeit subconscious) connection with Ahlfors 1950 [17], yet first made explicit (in-print) only by Alling-Greenleaf 1969 [38] (to the best of the writer's knowledge)] ♡60
- [435] F. Klein, *Über eindeutige Funktionen mit linearen Transformationen in sich. Erste Mitteilung*. Math. Ann. 19 (1882); also in *Gesammelte mathematische Abhandlungen. Dritter Band*. 1923, Reprint Springer-Verlag, 1973, 622–626. ♡??
- [436] F. Klein, *Über eindeutige Funktionen mit linearen Transformationen in sich. Zweite Mitteilung*. Math. Ann. 20 (1882); also in *Gesammelte mathematische Abhandlungen. Dritter Band*. 1923, Reprint Springer-Verlag, 1973, 627–629. ♡??
- [437] F. Klein, *Neue Beiträge zur Riemannschen Funktionentheorie*, Math. Ann. 21 (1882/83); also in *Gesammelte mathematische Abhandlungen. Dritter Band*. 1923, Reprint Springer-Verlag, 1973, 630–710. ♡??
- [438] F. Klein, *Über Realitätsverhältnisse bei der einem beliebigen Geschlechte zugehörigen Normalkurve der φ* , Math. Ann. 42 (1892), 1–29. [♠ this means the canonical embedding by holomorphic differentials into \mathbb{P}^{g-1} , which is like the Gauss map of the Abel embedding normalized through translation within the Jacobi torus ♠ an incredible interplay between the intrinsic geometry of the symmetric Riemann surface (including its topological characteristics) and the real enumerative issues allied to the canonical embedding, compare Gross-Harris 1981 [308] as the most cited best modern counterpart] ♡??

- [439] F. Klein, *Riemannsche Flächen, I.* Vorlesung, gehalten während des Wintersemesters 1891–92, Göttingen 1892, Neuer unveränderter Abdruck, Teubner, Leipzig 1906. AS60 ♡??
- [440] F. Klein, *Riemannsche Flächen, II.* Vorlesung, gehalten während des Sommersemesters 1892, Göttingen 1893, Neuer unveränderter Abdruck, Teubner, Leipzig 1906. AS60 [♠ for those not overwhelmed by German prose and handwritings, these lecture notes gives a very exciting view over Klein’s lectures and a good supplement to his papers. NB: these 2 items are *not* reprinted in the Ges. math. Abh., and somewhat hard-to-find in Switzerland but well-known in Russia, cf. e.g. Gudkov [323] and Natanzon 1990 [585], plus also in some US references, of course] ♡??
- [441] F. Klein, et al. *Zu den Verhandlungen betreffend automorphe Funktionen, Karlsruhe am 27. September 1911. Vorträge und Referate von F. Klein, L. E. J. Brouwer, P. Koebe, L. Bieberbach und E. Hilb.* Jahresb. d. Deutsch. Math.-verein. 21 (1912), 153–166. [♠ an account of the dramatic events occurring in 1911, when Brouwer was able to re-crack the uniformization (of Poincaré-Koebe, at least in the reasonable near to compact context) via topological methods (viz. invariance of domain) implementing thereby the old dream of Klein-Poincaré (or vice versa if you prefer)] ♡??
- [442] F. Klein, *Gesammelte mathematische Abhandlungen. Zweiter Band.* 1922, Reprint Springer-Verlag, 1973. AS60 ♡??
- [443] F. Klein, *Gesammelte mathematische Abhandlungen. Dritter Band.* 1923, Reprint Springer-Verlag, 1973. AS60, G78 ♡??
- [444] F. Klein, *Vorlesungen über die Entwicklung der Mathematik im 19. Jahrhundert, Teil I.* Die Grundlehren der mathematischen Wissenschaften 24, Berlin, 1926. [♠ where according to the legend Arnold learned all his background about mathematics] ♡??
- [445] S. Kobayashi, N. Suita, *On analytic diameters and analytic centers of compact sets*, Trans. Amer. Math. Soc. 267 (1981), 219–228. A47, A50 [♠ Ahlfors function and the allied conceptions of Vitushkin (analytic diameter and center), plus negative answers to several of Minsker’s questions (cf. Minsker 1974 [558])] ♡1
- [446] S. Kobayashi, *On analytic centers of compact sets*, Kodai Math. J. 5 (1982), 318–328. A47, A50 [♠ second derivative variant of the Ahlfors function developed along conceptions of Vitushkin (analytic diameter and center) and Minsker] ♡??
- [447] P. Koebe, *Über konforme Abbildung mehrfach zusammenhängender ebener Bereiche, insbesondere solcher Bereiche, deren Begrenzung von Kreisen gebildet wird*, Jahresb. d. Deutsch. Math.-Ver. 15 (1906), 142–153. [♠ special cases of the KN=Kreismormierung] ♡??
- [448] P. Koebe, *Über konforme Abbildung mehrfach zusammenhängender ebener Bereiche*, Jahresb. d. Deutsch. Math.-Ver. 16 (1907), 116–130. [♠ special cases of the KN=Kreismormierung] ♡??
- [449] P. Koebe, *Über die Uniformisierung reeller algebraischer Kurven*, Gött. Nachr. (1907), 177–190. [♠ self-explanatory and relies heavily on Klein’s ortho- and di-symmetry] ♡??
- [450] P. Koebe, *Über die Uniformisierung beliebiger analytischer Kurven*, Gött. Nachr. (1907), 191–210. [♠ joint with Poincaré 1907 [653], the first acceptable and accepted proof of uniformization of open Riemann surfaces (alias analytical curves, by opposition to algebraic reflecting compactness, in the jargon of Fréchet) ♠ key ingredient the “Verzerrungssatz”, for which Koebe confess some little “coup de pouce” from the colleague Carathéodory] ♡??
- [451] P. Koebe, *Über die Uniformisierung beliebiger analytischer Kurven, (2. Mitt.)*, Gött. Nachr. (1907), 633–669. [♠ another proof of the general uniformization inspired by the reading of Poincaré’s account, and using methods of Schwarz (esp. the Gürtelförmigverschmelzung)] ♡??
- [452] P. Koebe, *Über die Uniformisierung beliebiger analytischer Kurven, (3. Mitt.)*, Gött. Nachr. (1908), 337–358. [♠ discusses other types of uniformizations, and put forward the KNP, which he is already able to prove (in finite connectivity, or even in infinite connectivity under special symmetry), but no detailed arguments] ♡??
- [453] P. Koebe, *Über die Uniformisierung der algebraischen Kurven durch automorphe Funktionen mit imaginärer Substitutionsgruppe*, Gött. Nachr. (1909), 68–76. [♠ announce other types of uniformization formulated by Klein] ♡??

- [454] P. Koebe, *Über die Uniformisierung beliebiger analytischer Kurven*, (4. Mitt.), Gött. Nachr. (1909), 324–361. ♡??
- [455] P. Koebe, *Ueber die Uniformisierung der algebraischen Kurven, I* Math. Ann. 67 (1909), 145–224. [♠ detailed proof] ♡??
- [456] P. Koebe, *Über die konforme Abbildung mehrfach zusammenhängender Bereiche* Jahresb. d. Deutsch. Math.-Ver. 19 (1910), 339–348. [♠ contains the general case of the KN in finite connectivity, via 2 methods: Überlagerungsfläche and the so-called Koebe iteration method ♠ again no complete proof but the convergence is ensured by the “Verzerrungssatz” ♠ full details only much latter in 1920–22? [468] (according, e.g., to Bieberbach 1968 [102])] ♡??
- [457] P. Koebe, *Über die Hilbertsche Uniformisierungsmethode*, Gött. Nachr. (1910), 59–74. ♡??
- [458] P. Koebe, *Ueber die Uniformisierung der algebraischen Kurven, II* Math. Ann. 69 (1910), 1–81. ♡??
- [459] P. Koebe, *Begründung der Kontinuitätsmethode im Gebiete der konformen Abbildung und Uniformisierung. (Voranzeige)*, Nachr. Königl. Ges. Wiss. Gött., Math.-phys. Kl. (1912), 879–886. [♠ self-explanatory, but compare the practically simultaneous work of Brouwer 1912 [118], plus the announcements in 1911 [441]]
- [460] P. Koebe, *Ueber eine neue Methode der konformen Abbildung und Uniformisierung*, Nachr. Königl. Ges. Wiss. Gött., Math.-phys. Kl. (1912), 844–848. [♠ introduction of the Schmiegunungsverfahren (osculation method?)] ♡??
- [461] P. Koebe, *Begründung der Kontinuitätsmethode*, Ber. Math. Math.-phys. Kl. Sächs. Akad. Wiss. Leipzig 64 (1912), 59–62. ♡??
- [462] P. Koebe, *Ränderzuordnung bei konformer Abbildung*, Gött. Nachr. (1913), 286–288. [♠ contests the heavy reliance upon Lebesgue’s measure theory in Carathéodory’s proof (1912) of the boundary behavior of the Riemann mapping for Jordan curves, by appealing to a device of Schwarz] ♡??
- [463] P. Koebe, *Ueber die Uniformisierung der algebraischen Kurven, IV (Zweiter Existenzbeweis der allgemeinen kanonischen uniformisierenden Variablen: Kontinuitätsmethode)*, Math. Ann. 75 (1914), 42–129. ♡??
- [464] P. Koebe, *Abhandlungen zur Theorie der konformen Abbildung, I, die Kreisabbildung des allgemeinsten einfach und zweifach zusammenhängenden schlichten Bereichs und die Ränderzuordnung bei konformer Abbildung*, J. Reine Angew. Math. 145 (1915), 177–223. [♠ uses the word “Kreisabbildung” which is perhaps first coined in Bieberbach 1914 [92]] ♡??
- [465] P. Koebe, *Abhandlungen zur Theorie der konformen Abbildung, IV*, Acta Math. 41 (1918), 305–344. [♠ first existence proof of the circular/radial slit maps for domains of finite connectivity (general case in Grötzsch 1931 [313]); subsequent proof in Reich-Warschawski 1960 [677]] ♡??
- [466] P. Koebe, *Über die Strömungspotentiale und die zugehörigen konformen Abbildungen Riemannscher Flächen*, Gött. Nachr. (1919), 1–46. ♡??
- [467] P. Koebe, *Abhandlungen zur Theorie der konformen Abbildung. VI. (Abbildung mehrfach zusammenhängender schlichter Bereiche auf Kreisbereiche. Uniformisierung hyperelliptischer Kurven. Iterationsmethoden)*, Math. Z. 7 (1920), 235–301. ♡??
- [468] P. Koebe, *Abbildung beliebiger mehrfach zusammenhängender schlichter Bereiche auf Kreisbereichen*, Math. Z. 7 (1922), 116–130. ♡??
- [469] P. Koebe, *Das Wesen der Kontinuitätsmethode*, Deutsche Math. 1 (1936), 859–879. G78 [♠ survey-like with many refs.] ★★★ ♡??
- [470] H. Köditz, St. Timmann, *Ranschlichte meromorphe Funktionen auf endlichen Riemannschen Flächen*, Math. Ann. 217 (1975), 157–159. G78 [♣ supply a proof of a circle map (without bound) using techniques of Behnke-Stein ♣ criticizes and demolishes an earlier argument of Tietz 1955 [830] intended to give another treatment of the Ahlfors circle map] ♡??
- [471] Y. Komatu, *Identities concerning canonical conformal mappings*, Kodai math. Sem. Rep. 3 (1953), 77–83. ♡??
- [472] W. Koppelman, *The Riemann-Hilbert problem for finite Riemannian surfaces*, Comm. Pure Appl. Math. 12 (1959), 13–35. [♠ work oft cited in the investigation

- of the Slovenian school, see e.g. Černe-Forstnerič 2002 [166] ♠ “The problem of finding a function, analytic in some domain D , for a given relation between the limiting values of its real and imaginary parts on the boundary of D was originally mentioned by Riemann in his dissertation [12]. Here we shall treat the special case where . . .”]★★★ ♡27
- [473] A. Korn, *Application de la méthode de la moyenne arithmétique aux surfaces de Riemann*, C. R. Acad. Sci. Paris 135 (1902), 94–95. AS60 [♠]★★★ ♡??
- [474] A. Korn, *Sur le problème de Dirichlet pour des domaines limités par plusieurs contours (ou surfaces)*, C. R. Acad. Sci. Paris 135 (1902), 231–232.★★★AS60 ♡??
- [475] A. Korn, *Über die erste und zweite Randwertaufgabe der Potentialtheorie*, Rend. Circ. Mat. Palermo 35 (1913), 317–323. [♠ application of the authors’s theory of the asymmetrical kernel to the first and second boundary value problem of potential theory and its resolution by the method of the arithmetical mean (C. Neumann, Robin) leading anew to the solution predicted by Poincaré 1896 [652], which the author first succeeded in 1901 after appealing to a result of Zaremba (1901)] ♡??
- [476] I. Kra, *Maximal ideals in the algebra of bounded analytic functions*, ??? 31 (1967), 83–88. A50 [♠ Ahlfors 1950 [17] is applied to a characterization of “point-like” maximal ideals in the function algebra ♠ more precisely Ahlfors is cited on p. 85 as follows (yet without precise control on the degree except for its finiteness): “Lemma 5. Let X be a finite domain of the Riemann surface W . Then for each discrete sequence $\{x_n\} \subset X$, there exists an $f \in B(X)$ [=the ring of bounded holomorphic functions, cf. p. 83] such that $\lim_{n \rightarrow \infty} f(x_n)$ does not exist.—*Proof*. Ahlfors [1](=1950 [17]) has shown that there exists a mapping p , analytic in a neighborhood of $\text{Cl}X$, that is an N -to-one covering of the closed unit disc, for some positive integer N . Moreover $p|X$ is an N -to-one covering of the interior of the closed unit disc, and $p|X - X$ is an N -to-one covering of the unit circle. Because $\text{Cl}X$ is compact we may assume (by choosing a subsequence) that $x_n \rightarrow x \in \text{Cl}X - X$. Then $p(x_n) \rightarrow 1$ [modulus missing??] and $|p(x_n)| < 1$. Again, we may choose a subsequence such that $p(x_n)$ is distinct [??] and infinite and constitutes an interpolating sequence (see Hoffman [6, pp. 194–204]). Choose a bounded analytic function f on the unit disc such that $f(p(x_{2n+1})) = 0$ and $f(p(x_{2n})) = 1$ for $n = 0, 1, 2, \dots$. Then $f \circ p \in B(X)$, and $\lim_{n \rightarrow \infty} (f \circ p)(x_n)$ does not exist. [q.e.d.]” ♠ p. 87: “Theorem 2 is a generalization of Theorem 1, because every boundary point of a finite domain is an essential singularity for some bounded holomorphic function. The unit disc certainly has this property. The general case is reduced to the unit disc *via* any Ahlfors maps. (See the proof of Lemma 5.)”] ♡0
- [477] S. G. Krantz, *The Carathéodory and Kobayashi metrics and applications in complex analysis*, Amer. Math. Monthly 115 (2008), 304–329. [♠ p. 311 brief mention of the Ahlfors function and as it is connected to the Carathéodory metric; for more on the Ahlfors function the reader is referred to Fisher 1983 [241] or the book Krantz (2006)] ♡??
- [478] D. Kraus, O. Roth, *Critical points, the Gauss curvature equation and Blaschke products*, arXiv (2011). A47, G78 [♠ p. 15 the Ahlfors map is mentioned] ♡??
- [479] V. Krylov, *Une application des équations intégrales à la démonstration de certains théorème de la théories des représentations conformes*, (Russian, French Summary) Rec. Math. de Moscou [Mat. Sb.] 4 (1938), 9–30. G78 [♠ Seidel’s summary: the problem of mapping conformally a region of connectivity n , bounded by n analytic contours, on various canonical domains is reduced to the problem of solving a system of simultaneous integral equations] ♡??
- [480] T. Kubo, *Bounded analytic functions in a doubly connected domain*, Mem. Coll. Sci. Univ. Kyoto, A. 26 (1951), 211–223. ♡??
- [481] T. Kubota, *Über konforme Abbildungen. I.*, Science Reports Tôhoku Imperial Univ. ser. I, 9 (1920), 473–490. [♠ quoted in Grunsky 1932 [314, p. 135] for the simply-connected case of an extension of Bieberbach’s first Flächensatz]★★ ♡4
- [482] T. Kubota, *Über konforme Abbildungen. II.*, Science Reports Tôhoku Imperial Univ. ser. I, 10 (1921). [♠]★ ♡??
- [483] P. Kufareff, *Über das zweifach zusammenhängende Minimalgebiet*, Bull. Inst. Math. et Mec. Univ. de Tomsk 1 (1935–37), 228–236. [♠ quoted in Lehto 1949 [500] and Bergman 1950 [84], and akin to the works of Zarankiewicz 1934 [905, 906] ♠ Seidel’s summary: a minimal problem is set up for functions analytic and single-valued in a circular ring and the mapping effected by the minimizing function is discussed] ★ ★★ ♡??

- [484] R. Kühnau, *Über die analytische Darstellung von Abbildungsfunktionen, insbesondere von Extremalfunktionen der Theorie der konformen Abbildung*, J. Reine Angew. Math. 228 (1967), 93–132. G78 [♠ p.95–96 proposes a contribution to a question raised by Garabedian-Schiffer 1949 [275] related to the representation of the so-called Schottky function (via *Normalabbildungsfunktionen*) ♠ Kühnau alludes to several (subsequent) work of Schottky where the circle maps should appear again? (no precise refs. hence requires some detective work)] ♡??
- [485] R. Kühnau, *Geometrisch-funktionentheoretische Lösung eines Extremalproblems der konformen Abbildung, I, II*, J. Reine Angew. Math. 229 (1967), 131–136; 237 (1969), 175–180. G78 [♠] ♡??
- [486] R. Kühnau, *Herbert Grötzsch zum Gedächtnis*, Jber. d. Dt. Math.-Verein. 99 (1997), 122–145. [♠ alas, cited merely for the matter of the “quasi-conformal” jargon, as occurring apparently first (the jargon, not the concept) in Carathéodory 1914 [141]] ♡??
- [487] Z. Kuramochi, *A remark on the bounded analytic function*, Osaka Math. J. 4 (1952), 185–190. A50, AS60 [♣ p.189 seems to reprove the result of Ahlfors 1950 [17] about the existence of a circle map of degree $\leq r + 2p$ by using the Green’s function (while generalizing a method of Nehari 1951 [593] for the case of plane domains) ♠ unfortunately Kuramochi’s paper is written in some mysterious tongue (the Nipponenglish), and despite its moderate size (of ca. 5 pages) it contains several dozens of misprints obstructing seriously its readability ♠ despite our critical comments this work is quoted in Ahlfors-Sario 1960 [22] so should probably be not completely science-fictional ♠ it would perhaps be desirable (in case this paper emerged from some solid underlying structure) to undertake a polishing of this Kuramochi paper to improve its readability] ♡??
- [488] Y. Kusunoki, *Über die hinreichenden Bedingungen dafür, dass eine Riemannsche Fläche nullberandet ist*, Mem. Coll. Sci. Univ. Kyoto 28 (1952), 99–108. AS60 [also cited in Sario-Nakai [740] CHECK ♠ an application of Ahlfors 1950 [17] (and the older predecessor Bieberbach 1925 [97]) is given to the type problem] ♡0
- [489] Y. Kusunoki, *Contributions to Riemann-Roch’s theorem*, Kyoto J. Math. ? (1958), ?–?. A50 [♠ Ahlfors 1950 [17] is cited] ♡15
- [490] Y. Kusunoki, *Square integrable normal differentials on Riemann surfaces*, J. Math. Kyoto Univ. 3 (1963), 59–69. A50 [♠ Ahlfors 1950 [17] is cited on p.64, in the following connection (as usual many “notatio”): “If R is a bordered surface with p contours, $\{A_n, B_n, C_\nu\}_{n=1, \dots, g; \nu=1, \dots, p-1}$ is admissible for $\Gamma_0 = \Gamma_{aS} = \Gamma_{AB} \oplus \Gamma_C$ and P_γ gives a one-to-one mapping of $\Gamma_0 = \Gamma'_0$ to $(2g + p - 1)$ -dimensional vector space by (II) (Ahlfors [1](=1950 [17])).”] ♡6
- [491] M. P. Kuvaev, P. P. Kufarev, *An equation of Löwner’s type for multiply connected regions*, Tomskii gos. Univ. Uč. Zap. Mat. Meh. 25 (1925), 19–34. G78 ★ ★ ★ ♡??
- [492] E. Landau, *Einige Bemerkungen über schlichte Abbildung*, Jahresb. Dt. Math.-Verein. 34 (1926), 239–243. [♠] ♡??
- [493] H. J. Landau, R. Osserman, *On analytic mappings of Riemann surfaces*, J. Anal. Math. (1960), 249–279. [♠ p.266 contains the basic lemma that an analytic map taking the boundary to the boundary is a (full) branched covering (this follows directly from the local behavior of such maps and bears a certain relevance to the Ahlfors circle map) ♠ however the paper does not seem to supply an existence proof of the Ahlfors map ♠ in fact it is worth reproducing the text faithfully (p.265): “We now turn to the problem of mapping one Riemann surface into another. We shall need a lemma which, in a special case, was proved by Radó [12](=Radó 1922 [665]). Let us recall that a sequence of points in a Riemann surface is said to tend to the boundary if the sequence has no limit points in R^{37} . We shall say that a map f of one Riemann surface R_1 into another, R_2 , takes the boundary into the boundary if for every sequence of points in R_1 which tends to the boundary, the image sequence tends to the boundary of R_2 . Let us note that if R_1 and R_2 are relatively compact regions on Riemann surfaces, the above definition coincides exactly with the usual notion of mapping the boundary into the boundary.—**Lemma 3.1:** *Let R_1 and R_2 be any two Riemann surfaces and f an analytic map of R_1 into R_2 which takes the boundary into the boundary. Then f maps R_1 onto R_2 , and every points of R_2 is covered the same number of times, counting multiplicities.*” ♠ for this basic lemma see also the treatments in Stoilow 1938 [800, Chap. VI] and Ahlfors-Sario 1960 [22, p.41, 21B.]] ♡25

³⁷Perhaps it would be better to say no accumulation point.

- [494] M. Lavrentieff, *On the theory of conformal mapping*, Trav. Inst. phys.-math. Stekloff 5 (1934), 159–245. [♠ cited in Schiffer 1950 [751]] ★★★ ♡??
- [495] P. D. Lax, *Reciprocal extremal problems in function theory*, Comm. Pure Appl. Math. 8 (1955), 437–453. G78 [♠ extract from Rogosinski’s review (MathReview): “This principle is dual to one used for similar problems by the reviewer and H. S. Shapiro (=Rogosinski-Shapiro 1953 [704]); both principles are easy interpretations of the Hahn-Banach extension theorem in the complex case. [...] This important paper is somewhat marred by numerous misprints and a rather loose presentation.”] ★ ♡10
- [496] R. F. Lax, *On the dimension of the varieties of special divisors*, Illinois J. Math. 19 (1975), 318–324. [♠ extract from H. H. Martens’s review (MathReview): “The proof is inspired by the methods of T. Meis 1960 [541], and the paper contains, in addition to the author’s results, a very useful review of Meis’s monograph, which is rather difficult to obtain.”] ★ ♡??
- [497] R. Le Vavasaur, *Sur la représentation conforme de deux aires planes à connexion multiple, d’après M. Schottky*, Ann. Fac. Sci. Toulouse (2) 4 (1902), 45–100. G78 [♠ re-expose the results of Schottky 1877 [763]] ♡??
- [498] H. Lebesgue, *Intégrale, Longueur, Aire*, Annali di Mat. 7 (1902), 231–358. [♠ Lebesgue’s thesis, where Lebesgue’s integration and the allied geometry is introduced (yet another descendant of Riemann) ♠ Fatou 1906 [231], F. Riesz 1907 and Carathéodory 1912 [138] are the best illustration of the role of measure theory in (complex) function theory, a role disputed by Koebe at least in the early steps (compare Gray’s fine analysis [300])] ♡??
- [499] H. Lebesgue, *Sur le principe de Dirichlet*, Rend. Circ. Mat. Palermo 24 (1907), 371–402. [♠ extension of Hilbert’s solution to the Dirichlet problem by allowing general boundaries, cf. also Zaremba 1910 [908] for possible simplifications and (Beppo Levi 1906 [505] and Fubini 1907 [251] for related contributions of the same period ♠ further (quasi-ultimate) simplifications in Perron 1923 [635], in turn simplified in Radó-Riesz 1925 [671])] ♡??
- [500] O. Lehto, *Anwendung orthogonaler Systeme auf gewisse funktionentheoretische Extremal- und Abbildungsprobleme*, Ann. Acad. Sci. Fenn. Ser. A. I. 59 (1949), 51 pp. [♠ new existence proof of parallel-slit mappings via the Bergman kernel (and so in particular of RMT, answering thereby the old desideratum of Bieberbach 1914 [92]-Bergman 1922 [75]-Bochner 1922 [107]); equivalent work in Garabedian-Schiffer 1950 [279] ♠ p. 48 reproves the identity $B(z) = 1/S(w(z) - w^*(z))$ (expressing the least area map as combination of the two Schlitzfunktionen w and w^*) announced by Grunsky 1932 [314] ♣ p. 41 seems to show that the least area map is a circle map] ♡15
- [501] O. Lehto, *On the life and work of Lars Ahlfors*, Math. Intelligencer (1998), 4–8. [♠ p. 7: “In this same paper (1953/54), Ahlfors also defined the notion which he called Teichmüller space.”] ♡XX
- [502] F. Leja, *Une méthode de construction de la fonction de Green appartenant à un domaine plan quelconque*, C. R. Acad. Sci. Paris 198 (1934), 231–234. [♠ Seidel’s summary: a method for constructing the Green’s function of an arbitrary region is given. The approximating functions are closely related to Lagrange polynomials] ♡??
- [503] F. Leja, *Construction de la fonction analytique effectuant la représentation conforme d’un domaine plan quelconque sur le cercle*, Math. Ann. 111 (1935), 501–504. [♠ Seidel’s summary: for a given bounded simply connected [sic!?] region in the plane (of the complex variable z), a sequence of elementary functions is constructed which tends to the [Riemann] mapping function of the region] ♡??
- [504] F. Leja, *Sur une suite de polynômes et la représentation conforme d’un domaine plan quelconque sur le cercle*, Annales Soc. Polonaise de Math. 14 (1936), 116–134. [♠ Seidel’s summary: a set of polynomials is obtained by means of which the mapping function of a region D , with $z = \infty$ as interior point, on $|w| > 1$ can be expressed. If D is simply simply connected, the map is one-to-one (schlicht) ♠ question (of Gabard) and if not, does it relates to the map of Riemann-Bieberbach-Grunsky-Ahlfors (cf. e.g. Bieberbach 1925 [97] and Ahlfors 1947 [16])]★★ ♡??
- [505] B. Levi, *Sul Principio di Dirichlet*, Rend. Circ. Mat. Palermo (1906). [♠ cited in Zaremba 1910 [908] an extension of Hilbert’s resurrection of the Dirichlet principle] ♡??

- [506] P. Li, S.-T. Yau, *A new conformal invariant and its application to the Willmore conjecture and the first eigenvalue of a compact surface*, Invent. Math. 69 (1982), 269–291. [♠ p. 272 claims a result along the line of the Witt-Martens mapping theorem for symmetric surfaces without fixed points, but the Li-Yau argument appears as sketchy, or maybe even invalid according to Ross 1997 [713]] ♡**high 250?**
- [507] J.-L. Lions, *Remarks on reproducing kernels and some function spaces*, In: Function Spaces, Interpolation Theory and Related topics, Proceedings, Lund, Sweden, 2000, Walter de Gruyter, 2002, 49–59. [♠ present the definition of the reproducing kernel in the general setting due to Aronszajn (p.50): “This definition is due to N. Aronszajn [1](=Aronszajn [50]) who studied general properties of reproducing kernels.—In particular cases, such notions have been introduced by S. Bergman [2](=1922 [75]), G. Szegő [11](=1921 [818]), M. Schiffer [9](=1946 [748]), S. Zarembo [12](=1908 [907]), where the corresponding reproducing kernels are computed and estimated; cf. N Aronszajn, loc. cit., and P. Garabedian [3](=1949 [276]).” ♠ p. 56: “All these kernels can be computed by the same strategy as above. But we have not been able to recover by this method the results of P. Garabedian [3](=1949 [276]), which give the connection between $S(x, b)$ and $B(x, b)$.”] ♡**2**
- [508] M. S. Li Chiavi, *Sulla rappresentazione conforme delle aree pluriconnesse appartenenti a superficie di Riemann su un’opportuna superficie di Riemann su cui siano eseguiti dei tagli paralleli*, Rend. Sem. Mat. Univ. Padova 3 (1932), 95–107. AS60 [♠ Maria Stella Li Chiavi is a student of Cecioni] ♡**low 0?**
- [509] L. Lichtenstein, *Randwertaufgaben der Theorie der linearen partiellen Differentialgleichungen zweiter Ordnung vom elliptischen Typus. II*, J. Reine Angew. Math. 143 (1913), 51–105. [♠ quoted in Nevanlinna 1939 [609] for Schwarz’s alternating procedure recasted as the solution of an integral equation through successive approximations] ♡**high?**
- [510] L. Lichtenstein, *Zur Theorie der konformen Abbildung nichtanalytischer, singularitätenfreier Flächenstücke auf ebene Gebieten*, Bull. Internat. Acad. Sci. Cracovie, Cl. Sci. Math. Nat. Ser. A. (1916), 192–217. AS60 [♠ an extension of Gauss 1825 [286] (local isothermic coordinates), simultaneous work by Korn] ★★★ ♡**high?**
- [511] L. Lichtenstein, *Zur konformen Abbildung einfach zusammenhängender schlichter Gebiete*, Archiv der Math. u. Physik 25 (1917), 179–180. [♠ Seidels’ summary: the problem of mapping conformally on a circle a simply connected region bounded by a simple closed curve with continuous curvature is reduced to the solution of a linear integral equation] ★★★ ♡**high?**
- [512] L. Lichtenstein, *Neuere Entwicklung der Potentialtheorie. Konforme Abbildung*, Encykl. d. math. Wiss. II, 3., 1. Hälfte, 177–377. Leipzig, B. G. Teubner, 1919. G78 [♠ should contain another proof of the Kreismormierung in finite connectivity, according to Hawley-Schiffer 1962 [756]] ★ ♡**43**
- [513] B. V. Limaye, *Blaschke products for finite Riemann surfaces*, Studia Math. 34 (1970), 169–176. [♠ the paper starts with a little manipulation amounting to annihilate the periods of a conjugate differential, hence quite in line with say Ahlfors 1950 [17], yet does not seem to reprove the existence result of a circle map] ♡**4**
- [514] B. V. Limaye, *Ahlfors function on triply connected domains*, J. Indian Math. Soc. 37 (1973), 125–135. G78 ★ ♡??
- [515] I. Lind, *An iterative method for conformal mappings of multiply-connected domains*, Ark. Mat. 4 (1963), 557–560. G78 [♠ another proof of PSM (due to Schottky 1877, Cecioni 1908 [160], Hilbert 1909 [377], Koebe, etc.) via iterative scheme à la Koebe (who uses rather this device for the harder Kreismormierung)] ♡??
- [516] E. Lindelöf, *Memoire sur la théorie des fonctions entières de genre fini*, 1902. [♠] ♡??
- [517] F. Lippich, *Untersuchungen über den Zusammenhang der Flächen im Sinne Riemann’s*, Math. Ann. 7 (1874), 212–230. AS60 [♠ topology of surfaces, overlaps slightly with Möbius and Jordan 1866 [401], but no cross-citations] ♡??
- [518] O. Lokki, *Über Existenzbeweise einiger mit Extremaleigenschaft versehenen analytischen Funktionen*, Ann. Acad. Sci. Fenn. Ser. A. I. 76 (1950), 15 pp. AS60, G78 ★ ♡??
- [519] B. Lund, *Subalgebras of finite codimension in the algebra of analytic functions on a Riemann surface*, Pacific J. Math. 51 (1974), 495–497. AS60 [♠ quotes Ahlfors’

- existence of a circle map (termed therein unimodular function) and cite also Royden's proof of 1962 [716] ♠ the paper itself is devoted to the following result: if a uniform subalgebra A of $A(R)$ the algebra of all analytic functions on the interior of a compact bordered Riemann surface \bar{R} and continuous up to its boundary included contains a circle map, then A has finite codimension in $A(R)$ ♠ question: what about the converse? If the codimension is zero this boils down to Ahlfors 1950 [17]] ♡2
- [520] J. Lüroth, *Note über Verzweigungsschnitte und Querschnitte in einer Riemann'schen Fläche*, Math. Ann. 3 (1871), 181–184. AS60 [♠ considered as sketchy by Clebsch 1872 [178], and consequently supplemented with more details] ♡??
- [521] A. J. Macintyre, W. W. Rogosinski, *Extremum problems in the theory of analytic functions*, Acta Math. 82 (1950), 275–325. [♠ this enters into our specialized picture as follows: this paper, joint with Rogosinski-Shapiro 1953 [704], and Rudin 1955 [721] constitutes a stream influencing the production of the paper of Read 1958 [676] and Royden 1962 [716], where a new existence-proof of the Ahlfors map is given via functional analytic tools (Hahn-Banach) ♠ challenge [30.09.12] upon assuming that Gabard 2006 [255] is true, prove it via Hahn-Banach (good luck!)] ★ ♡??
- [522] B. Manel, *Conformal mapping of multiply connected domains on the basis of Plateau's problem*, Revista Univ. Tucuman 3 (1942), 141–149. G78 [♠ title essentially self-explanatory modulo the question of knowing which types of mappings are handled: Kreisnormierung, circle map, or some slit mappings?] ★ ♡??
- [523] W. Mangler, *Die Klassen von topologischen Abbildungen einer geschlossenen Fläche auf sich*, Math. Z. 44 (1939), 541–554. [♠ oft quoted, e.g. by Teichmüller] ♡??
- [524] A. Marin, *Quelques remarques sur les courbes algébriques planes réelles*. In: Séminaire sur la géométrie algébrique réelle. Publ. Math. Univ. Paris VII, 1979, 51–58. [♠ where the writer (Gabard) learned about the Rohlin inequality, which does not appear in print by Rohlin. For more details, cf. Gabard 2000 [253] and the refs. therein] ♡??
- [525] D. E. Marshall, *Removable sets for bounded analytic functions*, In: *Linear and complex analysis problem book*. Lecture Notes in Mathematics 1043. Springer, Berlin, 1984, 2233–2234. CHECK PAGINATION incompatible with Murai 1990/91 [575] [♠ if I do not mistake this is the first place where it is explained why Calderón's achievement (Calderón 1977 [131] on the L^p -continuity of the singular integral operator with a Cauchy kernel on a smooth curve) implies the so-called Denjoy conjecture (Denjoy 1909 [205]) about the removability of a closed set lying on a rectifiable curve being equivalent to the vanishing of its length ♠ historical detail: Murai 1990/91 [575, p.904–905] seems to ascribe the Denjoy conjecture to Calderón-Havin-Marshall using the (cryptical) abbreviation CHM on p.905 (but quotes only the present text of Marshall) ♠ the Calderón-to-Denjoy implication is obtained by combining classical results of Garabedian, Havinson with Davie's reduction of the Denjoy conjecture to the C^1 -case, completing thereby the proof of Denjoy's conjecture ♠ in fact, Denjoy announced this as a theorem, but his proof turned out to be erroneous (compare Marshall [525] or Melnikov 1975/76 [543, p.691] or Verdera 2004 [845, p.29]) ♠ alas, people rarely say explicitly who located the gap in Denjoy's claim (this is a non-trivial historical quiz), but maybe Ahlfors-Beurling 1950 [18, p.122] are good candidates, yet they do not criticize directly Denjoy but rather establish the special case of Denjoy's conjecture for linear and then analytic curves] ♡??
- [526] G. Martens, *Minimale Blätterzahl bei Überlagerungen Kleinscher Flächen über der projectiven Ebene*, Archiv der Math. 30 (1978), 481–486. [♠ sharp bound upon the degree of the Witt mapping ♠ differential geometric application in Ross 1999 [713]] ♡4?
- [527] G. Martens, *Funktionen von vorgegebener Ordnung auf komplexen Kurven*, J. Reine Angew. Math. 320 (1980), 68–85.
- [528] H. H. Martens, *On the varieties of special divisors on a curve*, J. Reine Angew. Math. 227 (1967), 111–120. [♠ self-explanatory title, but do not prove the existence of special divisors] ♡??
- [529] R. S. Martin, *Minimal positive harmonic functions*, Trans. Amer. Math. Soc. 49 (1941), 137–172. AS60 [♠ plays a fundamental role in Heins 1950 [358], who seems

- to offer an alternative proof of the existence of a circle map as the one of Ahlfors 1950 [17]] ♡??
- [530] M. Maschler, *Minimal domains and their Bergman kernel function*, Pacific J. Math. 6 (1956), 501–516. [♠] ♡19
- [531] M. Maschler, *Classes of minimal and representative domains and their kernel functions*, Pacific J. Math. 9 (1959), 763–782. [♠ contain (according to entry Maschler 1959 [532, p. 173]) a description of the geometric shapes of minimal domains (i.e. essentially the range of the least area maps) in the case of doubly-connected domains] ♡8
- [532] M. Maschler, *Analytic functions of the classes L^2 and l^2 and their kernel functions*, Rend. Circ. Mat. Palermo (2) 8 (1959), 163–177. [♠ p. 173 seems to assert that the range of the least area maps are unknown for domains of connectivity higher than 2 ♠ still on p. 173 Kufarev 1935/37 [483] is credited for establishing that the least area map in the case of doubly-connected domains is not univalent, but schlicht upon a (two sheeted) Riemann surface] ♡1
- [533] B. Maskit, *The conformal group of a plane domain*, Amer. J. Math. 90 (1968), 718–722. G78 [♠ proves two results to the effect that any plane domain (resp. Riemann surface of [finite] genus g) conformally embeds into either the sphere or a closed Riemann surface of the same genus so that, under this embedding, every conformal automorphism of the original surface is the restriction of one of the compactified closed surface ♠ the proof proceeds (via exhaustion) by reduction to the case of finite Riemann surfaces, previously established by the author] ♡??
- [534] B. Maskit, *Canonical domains on Riemann surfaces*, Proc. Amer. Math. Soc. 106 (1989), 713–721. [♠ Kreisnormierung for surfaces supplementing the uniqueness lacking in the existence proof in Haas 1984 [329]] ♡??
- [535] J. Mateu, X. Tolsa, J. Verdera, *The planar Cantor sets of zero analytic capacity and the local $T(b)$ -theorem*, J. Amer. Math. Soc. 16 (2002), 19–28. [♠ a complete characterization of the sets in the title is given via a little incursion of the Ahlfors function (on p. 25) ♠ [23.09.12] since Vitushkin and especially Garnett 1970 [283] it is known that the $1/4$ -Cantor set has $\gamma = 0$ (zero analytic capacity), but positive length. More generally one may consider a λ -Cantor set $E(\lambda)$ for $0 < \lambda < 1/2$ (obtained by keeping only the four subsquares of length λ pushed to the 4 corners of the unit-square and iterating ad infinitum) and ask about the ‘critical temperature’, i.e. the smallest λ such that $\gamma(E(\lambda)) > 0$ ♠ the critical value λ is precisely $\lambda = 1/4$, as follows from Theorem 1 of the cited work, describing more generally the case of a Cantor set $E(\lambda)$ associated to a sequence $\lambda = (\lambda_n)_{n=1}^{\infty}$ with variable λ_n (in the range $]0, 1/2[$) ♠ naive question: in the case where λ is constant (self-similar Cantor set) can we describe the behavior of $\gamma(E(\lambda))$ as a function $]0, 1/2[\rightarrow [0, +\infty[$: is it monotone, bounded, analytic or at least derivable (especially at the critical value)? ♠ naive answers: monotone most probably, bounded also certainly namely by γ of the unit square corresponding to $E(1/2)$] ♡??
- [536] P. Matildi, *Sulla rappresentazione conforme di domini appartenenti a superficie di Riemann su di un tipo canonico assegnato*, Ann. Scuola Norm. Super. Pisa (2) 14 (1945), (1948), 81–90. AS60 [♣ this paper (read by writer only the 13.07.12) seems to establish the existence of a circle map (*cerchio multiplo*) for compact bordered Riemann surface having only *one* contour. Thus with some imagination this may be regarded as a precursor of the Ahlfors circle map. (Recall that Ahlfors was well aware of this paper at least subsequently for it is cited in Ahlfors-Sario 1960 [22], alas without detailed comment.) Matildi also proposes a bound on the degree of the mapping whose dependence upon the topology is, however, not made completely explicit. He proposes namely, the degree $\lambda \leq n(2n - 3)$, where n is the minimum degree of a projective-plane model for the Schottky-double of the given membrane. Perhaps it would be useful to estimate his bound purely in term of the topology (via basic algebraic geometry) ♣ an extension of Matildi’s work to the case of membranes having several contours is claimed in Andreotti 1950 [45], but it still hard to decide if ti really cover the Ahlfors theorem of 1950] ♡0
- [537] P. Mattila, *Smooth maps, null-sets for integralgeometric measure and analytic capacity*, Ann. of Math. (2) 123 (1986), 303–309. [♠ includes a counterexample to the original formulation of Vitushkin’s conjecture (E removable iff purely unrectifiable, i.e. the intersection with any curve of finite length has zero 1-dimensional Hausdorff measure H^1) ♠ Mattila’s counterexample has $H^1(E) = \infty$ (infinite length) ♠ for the validation of Vitushkin’s conjecture in the case $H^1(E) < \infty$, see G. David 1998 [199]] ♡??

- [538] P. Mattila, M. S. Melnikov, J. Verdera, *The Cauchy integral, analytic capacity and uniform rectifiability*, Ann. of Math. (2) 144 (1996), 127–136. A47 [♠ analytic capacity, Ahlfors function and a step forward in understanding Painlevé null-sets geometrically ♠ for the complete solution see Tolsa 2003 [834]] ♡133
- [539] R. Mazzeo, M. Taylor, *Curvature and uniformization*, Israel J. Math. 130 (2002), 323–346. [♠ uniformization via Liouville’s equation (Schwarz’s strategy, cf. also Bieberbach 1916 [94]), as we know since Koebe (Überlagerungsfläche) this gives then the Kreisnormierung, cf. e.g. Bergman 1946 [81]] ♡??
- [540] S. McCullough, *The trisecant identity and operator theory*, Integr. Equat. Oper. Theory 25 (1996), 104–127. [♠ pp.113–5: discussion of the Ahlfors function along the lines of Fay 1973 [232] and p. 125 mentions Bell’s result 1991 [65] that the zeros of Ahlfors function are distinct if the center a is chosen near enough the boundary ♠ [20.09.12] as we already observed once, it could be interesting to investigate if Bell’s result extends to bordered surfaces (compact) of positive genus $p > 0$. Of course in this case the degree of the Ahlfors map may jump from points to points (within the Ahlfors range $r \leq \deg \leq r + 2p$), and this phenomenology is probably connected with deep algebro-geometric or differential-geometric invariants of the surface (Weierstrass points, etc.), compare the work of Yamada 2001 [897] and Gouma 1998 [297] for the hyperelliptic context (phenomenology of the mutation of the Ahlfors maps and their fluctuating degree upon dragging the basepoint) ♠ maybe it could be also worth looking if Bell’s result is somehow connected to Solynin’s result (2007 [794]) about the confinement of the zeros of the Green’s function inside a compactum when the pole is dragged through the surface ♠ at first sight, this looks quite plausible in view of Ahlfors formula (cf. 1947 [16] and 1950 [17]) that if f is a circle map with zeros at t_1, \dots, t_d then $\log |f(z)|$ matches a superposition of Green’s functions with poles at the t_i , i.e. $\log |f(z)| = \sum_{i=1}^d G(z, t_i)$, since both functions vanish on the contours and present the same singularities at the t_i ♠ since it is not the critical points of the individual Green’s function, but those of the superposed Green’s functions which are responsible for the ramification of f , a direct application of Solynin looks hazardous ♠ still, one may wonder if the ramification of the Ahlfors map stay likewise trapped within a compactum upon dragging the center a of the Ahlfors map f_a through the membrane] ♡??
- [541] Th. Meis, *Die minimale Blätterzahl der Konkretisierung[en] einer kompakten Riemannschen Fläche*, Schriftenreihe des Math. Inst. der Univ. Münster, Heft 16 (1960). [♠ a much quoted—but hard-to-find—source where the gonality of a general closed Riemann surface of genus g is found to be the bound predicted by Riemann, Brill-Noether, etc., namely $\lfloor \frac{g+3}{2} \rfloor$ ♠ Meis belongs to the Münster school (Behnke–Stein, etc.) ♣ [04.10.12] it seems probable that the technique employed by Meis (which involves Teichmüller theory according to secondary sources, e.g. H. H. Martens’ MathReview of Gunning 1972 [326]) could be adapted to the context of bordered surfaces and thus lead to a new proof of the Ahlfors map, even perhaps with the sharp bound given in Gabard 2006 [255] ♠ this seems to us to be a task of primary importance, but lacking a copy of Meis article we were relegated to make some general speculations (cf. Section 1.4 which we summarize briefly) ♠ the basic idea is to develop a “relative” Teichmüller theory not for pairs of Riemann surfaces of the same topological type (hence relatable by a “möglichst konform” diffeomorphism effecting the minimum distortion upon infinitesimal circles), but for just one Riemann surface which we try to express as a branched cover of the sphere (or the disc) for a fixed mapping degree d , while exhibiting the (quasiconformal) map of least distortion. Measuring this least dilatation, we get instead of the usual Teichmüller metric (distance) on the moduli space, a Teichmüller temperature ε_d (or potential) whose vanishing amounts to the possibility of expressing the given surface as a (conformal!) branched cover of the disc (or the sphere), thereby resolving the Ahlfors mapping problem (or the Riemann–Meis problem) depending on the bordered or closed context. [As a matter of convention the distortion (eccentricity of infinitesimal ellipses is ≥ 1 and this is converted in values ≥ 0 upon taking the logarithm)] ♠ in fact upon looking at the gradient flow of the Teichmüller temperature (trajectories of steepest descent orthogonal to the isothermic hypersurfaces $\varepsilon_d = \text{const.}$) we get a flow on the moduli space (M_g , if closed or $M_{p,r}$, if bordered) with the net effect of improving the gonality of each individual surface during its evolution ♠ as the Teichmüller space is a cell one can hope to derive the existence of stagnation point of the flow by the usual Poincaré–Brouwer–Hopf index formula giving so an existence-proof of a conformal map. However this is a bit artificial for the existence of low degree maps is usually evident (looking at hyperelliptic

surfaces and their bordered avatars). Of course it must perhaps be ensured that the flow only stagnates when the temperature vanishes (i.e. no saddle points nor sinks of positive temperature) ♠ in such favorable circumstances any closed surface of genus g would flow toward a hyperelliptic model representing the smallest possible gonality (=two) ♠ likewise, in the bordered context one expects that any membrane of type (p, r) converges to a membrane of least possible gonality, that is r (excepted when $r = 1$ and $p > 0$ where the least topological degree is 2) ♠ admittedly, all this does not readily reprove Meis' gonality (nor that of Ahlfors-Gabard) but maybe it is a first step toward a solution along this path, which—we repeat—should be found in the work of Meis (which in substance is nothing else than a relative (or ramified) version of classical Teichmüller theory) ♠ perhaps the flow we are speaking about is not logically needed in Meis's proof but it can certainly enhance the game ♠ basically for each d the continuity of the temperature function shows that the set of d -gonal surfaces is closed in the moduli space M_g , and since the set is non-empty as soon as $d \geq 2$ (hyperelliptic models) it suffices to show that it is open when d is appropriately large. The expected value for d is $[(g+3)/2]$ (resp. $r+p$ in the bordered case of $M_{p,r}$), yet it is precisely here that some idea is required ♠ naively if the degree is high enough one disposes of enough free parameters to make variations exploring locally the full moduli space ♠ alternatively one can perhaps argue that the temperature function ε_d is real-analytic on M_g so that it would suffice to check its vanishing on a small parametric (open) ball consisting of Riemann surfaces with explicitly given equations (this resembles perhaps Meis's approach through the little I know of it via indirect sources, e.g. R. F. Lax 1975 [496])★ ♡30

- [542] M. S. Melnikov, *Structure of the Gleason part of the algebra $R(E)$* , Funkt. Anal. Prilozhen. 1 (1967), 97–100; English transl. (1968), 84–86. [♠ p.86, Ahlfors function via Vitushkin 1958 [853] ♠ the paper itself is devoted to giving another proof (via the apparatus of analytic capacity) of Wilken's theorem that the Gleason part of the algebra $R(E)$ (of uniform limits on a compactum $E \subset \mathbb{C}$ of the rational functions of the variable z) consists either of one point (and is then a peak point), or it has positive area] ♡??
- [543] M. S. Melnikov, S. O. Sinanyan, *Aspects of approximation theory for functions of one complex variable*, Itogi Nauki i Tekhniki 4 (1975), 143–250; English transl. in J. Soviet Math. 5 (1976), 688–752. [♠ Vitushkin's theory (i.e., uniform approximation by rational functions) and its relation to the Ahlfors function and the allied analytic capacity] ♡??
- [544] M. S. Melnikov, *Analytic capacity: discrete approach and curvature of measure*, Sb. Math. 186 (1995), 827–846. A47 [♠ analytic capacity (p.827), Ahlfors function (p.830, 838) and introduction of the concept of the curvature of a (positive Borel) measure in the plane [Menger curvature], which enables a new proof of Denjoy's conjecture (without using Calderón's L^2 -estimates for the singular Cauchy integral) ♠ this technique of Melnikov is also instrumental in Tolsa's solution (2003 [834]) of the (full) Painlevé problem] ♡103
- [545] M. S. Melnikov, J. Verdera *A geometric proof of the L^2 boundedness of the Cauchy integral on Lipschitz graphs*, Internat. Math. Research Notices 7 (1995), 325–331. [♠ another approach to Calderón 1977 [131]] ♡??
- [546] O. Mengoni, *Die konforme Abbildung, gewisser Polyeder auf die Kugel*, Monatsh. f. Math. u. Phys. 44 (1936), 159–185. [♠ Seidel's summary: the paper is a contribution to the problem of conformal mapping of simply connected closed polyhedra upon the sphere. According to H. A. Schwarz, this problem can be reduced to the determination of a number of constants from a set of transcendental equations. It is shown that the explicit solution can be determined in a number of cases not considered by Schwarz. The paper concludes with a discussion of the results from the viewpoint of numerical computations] ★ ♡??
- [547] S. N. Mergelyan, *Uniform approximations to functions of a complex variable*, Amer. Math. Soc. Transl. 1001 (1954). ♡high
- [548] H. Meschkowski, *Beziehungen zwischen den Normalabbildungsfunktionen der Theorie der konformen Abbildung*, Math. Z. 55 (1951), 114–124. G78 ♡1
- [549] H. Meschkowski, *Über die konforme Abbildung gewisser Bereiche von unendlich hohen Zusammenhang auf Vollkreisbereiche, I*, Math. Ann. 123 (1951), 392–405. AS60, G78 [♠ some infinite connectivity cases of KNP, via iterative methods à la Koebe and area estimates due to Rengel 1932/33 [681]] ♡??

- [550] H. Meschkowski, *Über die konforme Abbildung gewisser Bereiche von unendlich hohen Zusammenhang auf Vollkreisbereiche, II*, Math. Ann. 124 (1952), 178–181. AS60, G78 [♠ sequel of the previous paper, building again over a Rengel (1932/33 [681]) area estimate for 4-gons and using Grötzsch’s (1929 [312]) mapping of a domain of infinite connectivity upon a Kreisschlitzbereich, reducing therefore the general study to this special case] ♡??
- [551] H. Meschkowski, *Einige Extremalprobleme aus der Theorie der konformen Abbildung*, Ann. Acad. Sci. Fenn. Ser. A. I. 117 (1952), 12 pp. AS60, G78 [♠ which mappings?, essentially all types, but relies heavily on previous works of Garabedian-Schiffer and Nehari ♠ mention the issue that there is no known extremal problem yielding the Koebe Kreisnormierung, for an update on this question see several works of Schiffer via Fredholm eigenvalues] ♡??
- [552] H. Meschkowski, *Verzerrungssätze für mehrfach zusammenhängende Bereiche*, Compositio Math. 53 (1953), 44–59. G78 [♠ Kreisbogenschlitz map, and somewhat relevant to the point discussed in Gaier 1978 [260] ♠ more precisely shows that the Ahlfors-type problem of maximizing the derivative among *schlicht* function bounded-by-one gives a conformal map upon a Kreisschlitzbereich (=circular slit disc). See also Reich-Warschawski 1960 [677]] ♡0
- [553] I. P. Millin, *The method of areas for schlicht functions in finitely connected domains*, (Russian) Trudy Mat. Inst. Steklov 94 (1968), 90–121. G78 [♠ cited in Grunsky 1978 [322, p. 185], hence possibly relevant to the issue discussed in Gaier 1978 [260]] ★★★ ♡??
- [554] C. D. Minda, *The Aumann-Carathéodory rigidity constant for doubly connected regions*, Kodai Math. J. 2 (1979), 420–426. A47 [♠ p. 422 an elementary existence-proof of the Ahlfors function is given in the case of an annulus $A := \{z : 1/R < |z| < R\}$ conjointly with the fact that the map is uniquely prescribed by its two zeros a, b (up to rotation) subjected to the relation $|ab| = 1$ ♠ one can wonder if in this case the circle maps of minimum degree (here $r = 2$, i.e. two contours) coincide exactly with the Ahlfors map f_a maximizing the distortion at a (both depends upon 2 real parameters) ♠ p. 424, still in the annulus case an explicit expression of the Ahlfors function is given in terms of the theta function, in a way analogous to work of Robinson 1943 [696] and Abe 1958 [1] ([03.10.12] compare maybe also Golusin 1952/57 [296]) ♠ this is then applied to give an explicit formula for the Aumann-Carathéodory rigidity constant (1934 [52]) ♠ p. 420, another proof of the so-called annulus theorem is given (quoting the variety of proofs due to H. Huber 1951, Jenkins 1953, Kobayashi 1970, Landau-Osserman 59/60 [493], Reich 1966, Schiffer 1946), but emphasizing that the present proof is patterned along Heins 1941 [357] showing “that the annulus theorem should properly be traced back to Heins’ work”] ♡??
- [555] C. D. Minda, *The hyperbolic metric and coverings of Riemann surfaces*, Pacific J. Math. 84 (1979), 171–182. A50 [♠ Ahlfors 1947 [16] and 1950 [17] are cited as follows (p. 180): “A function \tilde{f} in $\mathcal{B}(X)$ which maximizes $|\tilde{f}'(p)|$ is called an Ahlfors function ([1](=1947), [2](=1950)) and $c_B(p) = \max\{|\tilde{f}'(p)| : \tilde{f} \in \mathcal{B}(X)\}$ is called the analytic capacity metric.” ♠ from the abstract (freely and perhaps loosely reproduced): given two Riemann surfaces X, Y endowed with their hyperbolic metrics, the principle of hyperbolic metric (aka Schwarz-Pick-Ahlfors lemma) says that any analytic map $f : X \rightarrow Y$ is a contraction. “Moreover, equality holds if and only if f is an (unbranched, unlimited) covering of X onto Y ” ♠ [04.10.12] the latter property is essentially topological so applies to any Ahlfors map (even in the extended sense of—what we call—circle maps). We could then lift the hyperbolic (Riemann-Poincaré) metric on the disc to the bordered surface. Alas the ramification creates singularities (in this metric attached to a circle map), so that we certainly do not recover the hyperbolic metric on the interior of the bordered surface. The other way around we may assume uniformization (recall that the interior of any bordered surface is hyperbolic) and try to investigate the metric properties of varied circle maps. In particular is there any special feature related to the circle maps of smallest degree (alias the separating gonality in Coppens 2011 [183])? Also, given a point $p \in F$ (in the interior) there is a unique Ahlfors map f_p from F to the disc maximizing the derivative and since f_p is “étale” at p we get the above mentioned capacity metric which is more negatively curved than the hyperbolic metric (cf. Suita and Burbea’s papers). Unfortunately the degree of the Ahlfors function is quite mysterious (being subjected to spontaneous quantum fluctuations), but since everything is encoded in the hyperbolic metric

there must be an algorithm which given the input of F with the marked point p computes the degree of f_p in terms of the intrinsic geometry of F ♠ Some very vague guesses: given p there is a homology basis consisting of loops all based at p , and by compactness a smallest “systolic-type” system of such curves of minimal total length probably individually consisting of geodesics; this gives a real number and [pure guess] its integer part is the degree of f_p . Variant: there is a compact bordered surface capturing all the homology (plus the given point p) whose finite volume(=area) ♠ Further once the hyperbolic metric is introduced on F any Ahlfors map at p gives a stretching factor at p which by the principle of contraction is ≤ 1 , and we get a (probably continuous) function $\delta: F \rightarrow]0, 1]$ of F measuring this distortion. Does the function extends to the boundary ∂F ? (and could it be harmonic??). Intuitively when the degree of f_p is low one may expect that the distortion is high. On the other hand there is largest schlicht disc centered at the origin where f_a is unramified, but beware that ramification may come from another point than p lying above the origin. So the right viewpoint is that there is a maximal disc centered at p which is ramificationless.] ♡10

[556] C. D. Minda, *The image of the Ahlfors function*, Proc. Amer. Math. Soc. 83 (1981), 751–756. [♠ Ahlfors function for domains of infinite connectivity ♠ p. 751: “Ahlfors [1](=1947 [16]) showed that $h(\Omega) = B$ [i.e. the Ahlfors function is surjective on the disc B] for regions Ω of finite connectivity that have no trivial boundary components. More precisely, he proved that that h expresses Ω as an n -sheeted branched covering of B , where n is the order of connectivity of Ω . In the general situation Havinson 1961/64 [345] and Fisher 1969 [238] demonstrated that $B \setminus h(\Omega)$ has analytic capacity zero; [...]. It is not difficult to give an example of a region Ω such that $B \setminus h(\Omega) \neq \emptyset$. For example, let K be a closed set of B which has analytic capacity zero and $\Omega = B \setminus K$. If $0 \in \Omega$, then the Ahlfors function h for Ω and 0 is the identity function, so $h(\Omega) = B \setminus K$. The question of the size of $B \setminus h(\Omega)$ becomes more interesting if it is required that Ω be a maximal region for bounded holomorphic functions in the sense of Rudin 1955 [720]. [→ Recall Rudin’s definition (p. 333): “A boundary point x of D [=domain in the Riemann sphere] is said to be *removable* if for every $f \in B(D)$ [=bounded analytic function] there exists a neighborhood V of x such that f can be extended to V . By an *essential* boundary point of D we mean one that is not removable. If every boundary point of D is essential, we say that D is *maximal*.”] For such a maximal region Ω , Fisher 1972 [239] raised the question of whether the Ahlfors function must map Ω onto B . Röding 1977 [709] answered this question in the negative by exhibiting a maximal region Ω and a point $p \in \Omega$ such that the Ahlfors function for Ω and p omitted two values in Ω . We shall extend Röding’s result by showing that an Ahlfors function for a maximal region can actually omit a fairly general discrete set of values in B .” ♠ p. 755: “Therefore, it is still an open question whether the Ahlfors function for a maximal region can actually omit an uncountable set of zero analytic capacity.” ♠ [05.10.12] an update (positive answer) is implied by Yamada 1992 [896] where an example is given where the omitted set of the Ahlfors function has positive logarithmic capacity (hence uncountable, because sets of logarithmic capacity zero are stable under countable unions, see e.g. Tsuji 1959 [841])] ♡2

[557] C. D. Minda, *Bloch constant for meromorphic functions*, Math. Z. ?? (1982), ??–??. [♠ “Our geometric approach to the construction of an upper bound is more elementary and clearly shows the analogy with the Ahlfors-Grunsky example. [...]. Let $XXXX$ be a compact bordered Riemann surface with genus g and m boundary components.”] ♡9

[558] S. Minsker, *Analytic centers and analytic diameters of planar continua*, Trans. Amer. Math. Soc. 191 (1974), 83–93. [♠ the Ahlfors function is mentioned twice on p. 91, 92 ♠ the paper itself contains results about analytic centers and analytic diameters (concepts arising in Vitushkin’s work on rational approximation)] ♡2

[559] I. P. Mitjuk, *The principle of symmetrization for multiply connected regions and certain of its applications*, (Russ.) Ukrain. Mat. Ž 17 (1965), 46–54; Amer. math. Soc. Transl. 73, 73–85. G78 ★ ♡??

[560] I. P. Mitjuk, *The inner radius of a region and various properties of it*, (Russ.) Ukrain. Mat. Ž 17 (1965), 117–122; Amer. math. Soc. Transl. ??, ??–??. [♠ a formula expressing the inner radius $r(G, 0)$ of a domain G containing the origin and bounded by n analytic Jordan curves is given in terms of the Ahlfors function $F_G(z, 0)$ (normalized as usual by $F_G(0, 0) = 0$ and $F'_G(0, 0) > 0$) and the Green’s function $g_G(z, 0)$ ♠ the formula reads $r(G, 0) = \frac{1}{F'_G(0, 0)} \exp(\sum_{k=1}^{n-1} g_G(0, z_k))$, where

- z_k are the $n - 1$ extra zeros of the Ahlfors function ♠ related material in Bandle-Flucher 1996 [57] ★★★ ♡??
- [561] I. P. Mitjuk, *Extremal properties of meromorphic functions in multiply connected domains*, Ukrain. Mat. Ž 20 (1968), 122–127; Amer. math. Soc. Transl. 76, 116–120. A47 [♠ Ahlfors’s function occurs thrice: twice on p.116 and once on p.117 and is applied to obtain a connection between the inner radius and the transfinite diameter] ♡??
- [562] Y. Miyahara, *On relations between conformal mappings and isomorphisms of spaces of analytic functions on Riemann surfaces*, J. Math. Soc. Japan 31 (1979), 373–389. A50 [♣ on p.375, Ahlfors 1950 [17] is cited for a result on the existence of a basis of analytic Schottky differentials whose periods along a canonical homology basis are calibrated to Kronecker’s delta. Hence the discussion is not directly relevant to the circle map, yet the general construction is quite akin (Green’s function, period of the conjugate differential, etc.) ♠ p.380, one reads: “Let g be a nonconstant function in $A(S')$ satisfying $|g| = 1$ on $\partial S'$. (This is a so-called inner function.)” ♠ the existence of a such a map follows (perhaps) from Ahlfors 1950, and if so the author perhaps fails to emphasize this issue adequately] ♡0
- [563] Y. Miyahara, *On local deformations of a Banach space of analytic functions on a Riemann surface*, J. Math. Soc. Japan 40 (1988), 425–443. A50 [♣ on p.436, Ahlfors 1950 [17] is cited in essentially the same context as for the previous entry, i.e. Miyahara 1979 [562]] ♡0
- [564] H. Mizumoto, *On conformal mapping of a Riemann surface onto a canonical covering surface*, Kōdai Math. Sem. Rep. 12 (1960), 57–69. A50, G78 [♣ an essentially topological proof of (Ahlfors) circle maps is given, recovering the same degree $r + 2p$ as Ahlfors 1950 [17] ♣ for a (possible) improvement to $r + p$, cf. Gabard 2006 [255] ♠ in case Mizumoto’s argument is solid, this seems to be a much underestimated paper as it is quoted by 0 according to the electronic counters, but it is in Grunsky 1978 [322]] ♡0
- [565] A. F. Möbius, *Theorie der elementaren Verwandtschaft*, Ber. Verhandl. Königl. Sächs. Gesell. d. Wiss., mat.-phys. Klasse 15 (1863), 18–57. (Möbius Werke II). [♠ a revolutionnary paper fixing the bases of “Morse theory” and classifying en passant the closed orientable surfaces, ♠ followed by Jordan 1866 [401], and vital to Klein’s theory of symmetric surfaces. Of course according to Klein (cf. 1892 [440]), this topological classification must have been known to Riemann] ♡??
- [566] A. F. Monna, *Dirichlet’s principle. A mathematical comedy of errors and its influence on the development of analysis*, Oosthoek, Scheltema, and Holkema, Utrecht, 1975. ★ ♡??
- [567] P. Montel, *Sur les suites infinies de fonctions*, Ann. École Norm. Sup. (3) 4 (1907), 233–304. [♠ Montel’s Thesis building over Arzelá, Vitali, Lebesgue, etc. leading to the concept of “normal families”, pivotal in the resolution of extremal problems involving bounded functions (e.g. the so-called Ahlfors function) ♠ the nomenclature “normal families” was coined afterwards in Montel 1913 [568] ♠ simultaneous related work appeared independently by Koebe ca. 1907 in relation with his distortion theorem, compare e.g. the historical analysis of Bieberbach 1968 [102, p.150–151] who writes: “Beim Beweis wird nun neben dem Viertelsatz ein allgemeiner Konvergenzsatz benutzt. Das ist nichts anderes als das, was man in Montels Theorie der Normalen Funktionenfamilien, heute kurz den *Vitalischen Reihensatz* nennt. Koebe hat ihn selbständig entdeckt [11](=Koebe 1908 UbaK3 [452]). Er leitet ihn aus der Wurzel ab, die auch den anderen Forschern die Anregung gab: Hilberts Arbeit über das Dirichletsche Prinzip (1901) und die vierte Mitteilung über Integralgleichung (1906) des gleichen Forschers. [...]” ♡??
- [568] P. Montel, ???, C. R. Acad. Sci. Paris 153 (1911), 996–998. [♠ where the nomenclature “normal families” appears first in the literature] ♡??
- [569] P. Montel, *Leçons sur les familles normales de fonctions analytiques et leurs applications*, Gauthier-Villars, Paris, 1927. [♠ Montel’s treatise on the subject which appeared 20 years after the subject began] ♡185
- [570] A. Mori, *Conformal representation of multiply connected domain on many-sheeted disc*, J. Math. Soc. Japan 2 (1951), 198–209. AS60, G78 [♣ reprove the circle map (ascribed to Bieberbach/Grunsky) via potential theory (Green’s function), plus a mixture of linear algebra and topology (homology) ♠ Lemma 1 gives also an “iff” condition for a group of points in the interior to be the fibre of a

- circle map (in terms of harmonic measure) (compare Fedorov 1991 [233] for a similar game) ♠ [26.09.12] it would be nice(?) to extend such a characterization to the positive genus case, and try to recover the Gabard bound $r + p$ by this procedure] ♡3
- [571] C. B. Morrey, *Multiple Integrals in the Calculus of Variations*, Grundlehren der math. Wissenschaften 130, Springer-Verlag, Berlin, 1966. [♠ includes a proof of Koebe's Kreismessung via a Plateau-style approach (extending thereby Douglas' derivation (1931 [209]) of the RMT) ♠ however some little gaps in the execution are noticed (but filled) by Jost 1985 [402], cf. also Hildebrandt-von der Mosel 2009 [379] ♠ [07.10.12] it is tempting to conjecture that the Plateau-style approach should also have something to say about the Ahlfors circle maps (cf. Courant 1939 [191] for the planar case, i.e. the Bieberbach-Grunsky theorem), however to (my knowledge) it was never attempted to tackle the case of positive genus ($p > 0$)] ♡??
- [572] M. Morse, M. Heins, *Topological methods in the theory of a function of a complex variable*, Bull. Amer. Math. Soc. ?? (1947), 1–14. [♠ p. 1: "The modern theory of meromorphic functions has distinguished itself by the fruitful use of the instruments of modern analysis and in particular by its use of the theories of integration. Its success along the latter line has perhaps diverted attention from some of the more finitary aspects of the theory which may be regarded as fundamental."] ♡65
- [573] M. Morse, *La construction topologique d'un réseau isotherme sur une surface ouverte*, J. Math. Pures Appl. (9) 35 (1956), 67–75. AS60 ★ ♡??
- [574] T. Murai, *Construction of H^1 functions concerning the estimate of analytic capacity*, Bull. London Math. Soc. 19 (1987), 154–160. [♠ p. 154 mentions the Ahlfors function (via Garnett's book 1972 [284, p. 18]) and its indirect role in Garnett's 1970 [283] exposition (of Vitushkin's 1959 example [854] of a set of positive length but vanishing analytic capacity), but then Murai prefers to switch to the so-called Garabedian function to derive a direct proof of the vanishing of the analytic capacity] ♡??
- [575] T. Murai, *Analytic capacity for arcs*, In: Proceedings of the International Congress of Mathematicians, Kyoto, Japan, 1990, 901–911, The Mathematical Soc. of Japan, 1991. A47 [♠ 3 occurrences of the Ahlfors function, on p. 902 (via Garnett 1970 [283, p. 24]), p. 904, p. 905 ♠ seems to ascribe the Denjoy conjecture to Calderón-Havin-Marshall using the (cryptical) abbreviation CHM on p. 905 (but quotes only Marshall [525])] ♡??
- [576] T. Murai, *The arc-length variation of analytic capacity and a conformal geometry*, Nagoya Math. J. 125 (1992), 151–216. A47 [♠ 4 occurrences of the Ahlfors function, on p. 152, 159, 191, 199 ♠ analytic capacity (of a compact plane set) and its variation under a small change of the compactum E (theory of Hadamard-Schiffer), with apparently a connection to Löwner's differential equation] ♡??
- [577] P. J. Myrberg, *Über die Existenz der Greenschen Funktionen auf einer gegebenen Riemannschen Fläche*, Acta Math. 61 (1933), 39–79. AS60 [♠] ♡??
- [578] S. Nagura, *Kernel functions on Riemann surfaces*, Kōdai Math. Sem. Rep. (9) 35 (1951), 73–76. AS60 [♠ theory of the Bergman kernel on a Riemann surface using an exhaustion by compact bordered subregions with analytic boundaries] ♡??
- [579] M. Nakai, *The corona problem on finitely sheeted covering surfaces*, Nagoya Math. J. 92 (1983), 163–173. A50 [♠ p. 164: "As is well known these surfaces [=finite open Riemann surfaces] are represented as unbounded finitely sheeted covering surfaces of the unit disk Δ (cf. e.g. Ahlfors [1](=1950 [17]))." ♠ comment of Gabard [12.09.12]: it may appear as a bit unfair that Alling's works are omitted in the bibliography of this work, and more specifically Gamelin's accreditation of the bordered corona on p. 164 looks historically erroneous in view of the earlier work of Alling 1964 [34], and Alling 1965 [35] (for full details)] ♡2
- [580] M. Nakai, 1985 see Hara-Nakai 1985 [333].
- [581] M. Nakai, *Valuations on meromorphic functions of bounded type*, Trans. Amer. Math. Soc. 309 (1988), 231–252. A50 [♠ Ahlfors 1950 [17] is cited in the following context (of valuation-theoretic stability) on p. 240: "The following is due to Frank Forelli [4](=private communication) to whom the author is very grateful for many valuable suggestions and information:—EXAMPLE 1. Any finitely sheeted disc is stable.—The result follows immediately from Theorem 1 [an unlimited finite covering surface is stable iff its base is] and Theorem 2 [the open unit disc is stable]. Plane regions bounded by finitely many mutually disjoint nondegenerate continua

are finitely sheeted disks by the Bieberbach-Grunsky theorem (cf. e.g. [16](=Tsuji 1959/75 [841])) or more generally finite open Riemann surfaces are finitely sheeted disks by the Ahlfors theorem [1](=Ahlfors 1950 [17]). Here a finite open Riemann surface is a surface obtained from a closed surface by removing a finite number of mutually disjoint nondegenerate continua. Hence as a special case of the above example we have—COROLLARY. *Finite open Riemann surfaces are stable.* ♠ the notion of stability involved is the following (p. 231): “Any valuation on the field $M(W)$ of single-valued meromorphic functions on a Riemann surface W is a point valuation (Iss’ssa 1966). What happens to valuations on subfields of $M(W)$? An especially interesting subfield in this context is the field $M^\infty(W)$ of meromorphic functions of bounded type on W (cf. [2](=Alling 1968)) ♠ the exact definition is given on p. 232: “A single-valued meromorphic function f on a Riemann surface W is said to be *of bounded type* if $f = \frac{g}{h}$ on W where g and h are bounded holomorphic functions on W with $h \neq 0$.” ♠ p. 232/4: “We say that a Riemann surface W is *stable* if $M^\infty(W)$ is nontrivial and any valuation on $M^\infty(W)$ is a point valuation.” ♠ [29.09.12] roughly it seems that this notion of stability leads to a theory quite parallel to that of the corona problem, for the above positive (finitistic) result of Nakai is quite parallel to that of Alling 1964 [34] in the “coronal realm” and further the open question are similar e.g. p. 241: “OPEN PROBLEM 2. *Is there any stable plane region of infinite connectivity?*” ♠ however in the Corona problem it is still an open problem whether any plane region satisfies the corona theorem, but here Nakai (p. 241) gives a nonstable plane region “obtained from the punctured open unit disc Δ_0 by removing a sequence of mutually disjoint closed disks with centers on the positive real axis that accumulates only at $z = 0$ (a [so-called] Zalcman L -domains [17](=Zalcman 1969 [904]))” ♡??

[582] D. Nash, *Representing measures and topological type of finite bordered Riemann surfaces*, Trans. Amer. Math. Soc. 192 (1974), 129–138. (Dissertation Berkeley, Advisor: Sarason) A50 ♠ cite Ahlfors 1950 [17], yet apparently not within the main-body of the text ♠ given \bar{R} a finite bordered surface, let A be the usual hypo-Dirichlet algebra consisting of functions continuous on the bordered surface and holomorphic on its interior R . For a point $a \in R$, let e_a be the corresponding evaluation. A *representing measure* for e_a is a positive Borel measure m of total mass one supported on ∂R such that $f(a) = \int_{\partial R} f dm$ for all $f \in A$. The collection of all such measures form a compact convex set \mathfrak{M}_a . The paper shows some connections between the topology and even the conformal type of the surface R and the geometry of the convex body \mathfrak{M}_a of representing measures. It is shown that if \mathfrak{M}_a has an isolated extreme point, then R must be a planar surface. ♠ let g be the genus of R and s the number of contours, Theorem 1.2 states: “If $g = 0$ and $s = 3$, then \mathfrak{M}_a has precisely four extreme points if a lies on one of three distinguished analytic arcs, and \mathfrak{M}_a is strictly convex if a lies off these arcs. If $g = s = 1$, then \mathfrak{M}_a is strictly convex for all $a \in R$.” ♠ [28.09.12] it seems evident that this article (using such concepts as harmonic measure, Green’s function, Schottky differentials, convex bodies, etc.) must bear some close connection with Ahlfors 1950 [17], and it would be nice if the degree of the Ahlfors map f_a (at a) could somehow be related to the geometry of the body \mathfrak{M}_a] ♡4

[583] S. M. Natanzon, *Moduli spaces of real curves*, Trans. Moscow Math. Soc. 37 (1980), 233–272. [♣]★★ ♡33

[584] S. M. Natanzon, *Prymians of real curves and their applications to the effectivization of Schrödinger operators*, Funct. Anal. Appl. 23 (1989), 33–45. [♣]★★ ♡??

[585] S. M. Natanzon, *Klein surfaces*, Uspekhi Mat. Nauk 45 (1990), 47–90; English transl. in: Russian Math. Surveys 45 (1990), 43–108. [♣ contains an extensive bibliography, through which—if I remember accurately—I discovered circa 2001 the papers Alling-Greenleaf 1969 [38] and Geyer-Martens 1977 [290] which pointed out to me the connection between Klein’s dividing curves and the Ahlfors map of Ahlfors 1950 [17] (i.e. circle maps) ♠ “The structure of a Klein surface is an analogue of the complex-analytic structure for surfaces with boundary and non-orientable surfaces. Similar to the way in which the theory of compact Riemann surfaces gives an adequate language for the description of complex . . .”] ♡42

[586] S. M. Natanzon, B. Shapiro, A. Vainshtein, *Topological classification of generic real rational functions*, arXiv (2001) and J. Knot Theory and Ramif. [♣ § 3.1, p. 7 (arXiv pagination) titled “On the space of branched covering of a hemisphere by a Riemann surface with boundary” should evidently bears some strong connection with Ahlfors theory. In fact the authors describes the “set $\mathcal{H}_{g,m}^k$ of all generic degree

m branched coverings of the form $f: P \rightarrow \Lambda^+$ where P is a topological surface of genus g with k contours and Λ^+ is the upper hemisphere $\{z \in \mathbb{C} : \text{Im}(z) \geq 0\}$. ♠ [21.10.12] this space is of course thought of as a Hurwitz space and it may be partitioned according to the varied multi-degrees of the restricted maps along the k contours, which are indexed by partitions (m_1, \dots, m_k) of m . The corresponding subspace of the Hurwitz space having fixed bordered degree (m_1, \dots, m_k) is shown to be connected (via an extension of the Lüroth-Clebsch theorem). ♠ alas, it is not clear to me (Gabard) if the article shows an Ahlfors-type existence result, amounting to the non-emptiness of $\mathcal{H}_{g,m}^k$ for m sufficiently large (cf. Ahlfors 1950 [17], or Gabard 2006 [255]). But note that the surface in here is only topological, so that the viewpoint is different! Yet perhaps compatible in case one lift the complex structure of the disk/hemisphere via all topological maps obtaining a “variable” Riemann surface with enough free moduli to realize them all, recovering so perhaps Ahlfors’ theorem via an Hurwitz-type strategy. (I clearly remember to have discussed this idea with Natanzon in a 2001 Rennes conference, but as yet never managed to get so an existence proof corroborating either Ahlfors 1950 or Gabard 2006.) The argument could start as follows: set \mathcal{H}_g^k the set of all branched covers of the disc (without specified degree). Lifting the complex structure, gives a map $\mathcal{H}_g^k \rightarrow M_{g,k}$ to the moduli space of bordered surfaces of type (g, k) (=genus, number of contours). The latter is probably continuous and one would like to show (by a topological argument akin to the continuity method made rigorous by Brouwer-Koebe) that the map is onto when restricted to the Hurwitz space of degree m , for some suitable value of m . Of course the lack of compactness of the moduli space may suggest to invoke a Deligne-Mumford compactification? Alternatively one can maybe avoid compactification via a clopen argument based on Brouwer’s invariance of the domain] ♡??

- [587] Z. Nehari [né Willi Weisbach], *Analytic functions possessing a positive real part*, Duke Math. J. 15 (1948), 165–178. G78 [♠ cites the result of Bieberbach 1925 [97], Grunsky 1937–41 [315, 316], Ahlfors 1947 [16], i.e. only planar domains via extremal methods] ♡10
- [588] Z. Nehari, *The kernel function and canonical conformal maps*, Duke Math. J. 16 (1949), 165–178. AS60, G78 [♠ integral representation of the varied slit-mappings (parallel/circular slits or circular holes) via the Bergman kernel]★★ ♡8
- [589] Z. Nehari, *The radius of univalence of an analytic function*, Amer. J. Math. 71 (1949), 845–852. G78 [♠ application of the Ahlfors function 1947 [16] and of Garabedian’s identity $2\pi F'(z) = K(z, z)$ (Szegő kernel) to the problem of determining the radius of univalence to some families of analytic functions on multi-connected domains, generalizing thereby sharp estimates of Landau for bounded functions in the unit-circle] ♡4
- [590] Z. Nehari, *On bounded analytic functions*, Proc. Amer. Math. Soc. 1 (1950), 268–275. AS60, G78 [♠ alternative (simplified, but lucky-guess type) derivation of Ahlfors 1947 [16] and Garabedian 1949 [276] results around the Schwarz’s lemma via potential theory (Green’s function) and the Szegő kernel] ♡12
- [591] Z. Nehari, *Conformal mapping of open Riemann surfaces*, Trans. Amer. Math. Soc. 68 (1950), 258–277. AS60, G78 [♣ the paper starts with the historically interesting fact that the main result in Ahlfors 1950 [17] was already presented in Spring 1948 at Harvard (multiply-covered circle with number of sheets not exceeding $(r + 2p)$) ♣ contains various type of slit mappings (parallel vs. circular or radial), where the first type is given an elementary proof whereas the second requires Jacobi inversion (cf. Ahlfors’ in MathReviews) [Incidentally one may wonder whether the first (parallel-slit) result is not already implicit in Hilbert 1909 [377]?] ♣ ♠ p. 267: “Representation of the Ahlfors mapping in terms of the kernel function.” ♠ NB: some part of this paper are criticized by Tietz 1955 [830], but himself is critiqued later so it is not clear who (and what) is right and how reliable those papers are ♣ the writer asserted in Gabard 2006 [255, p. 946], that Nehari and Tietz may have conjectured the improved bound $r + p$ upon the degree of a circle map, yet on more mature thought this assignment may be a bit cavalier. We leave the competent readers make their own opinion] ♡3
- [592] Z. Nehari, *Bounded analytic functions*, Bull. Amer. Math. Soc. 57 (1951), 354–366. A50, G78 [♣ an interesting survey of the Ahlfors’ extremal function (the name appears on p. 357) emphasizing its relation to other domain functions such as the kernel functions and the Green’s function] ♡6

- [593] Z. Nehari, *Extremal problems in the theory of bounded analytic functions*, Amer. J. Math. 73 (1951), 78–106. G78 [♠ only multiply-connected domains, but the methodology is extended to the positive genus case by Kuramochi 1952 [487], which seems to recover Ahlfors’s 1950 result [17] with the same upper-bound] ♥??
- [594] Z. Nehari, *Conformal Mapping*, Mac Graw-Hill, New York, 1952. (Dover reprint 1975.) AS60, G78 [♠ only the planar case (domains)] ♥1431
- [595] Z. Nehari, *Some inequalities in the theory of functions*, Trans. Amer. Math. Soc. 75 (1953), 256–286. G78 [♠ p. 264–65 another derivation of the fact (ascribed to Grötzsch 1928 [311] and Grunsky 1932 [314]) that the mapping maximizing the derivative at some inner point of a multi-connected domain amongst schlicht functions bounded-by-one (i.e. $|f| \leq 1$) is a circular slit mapping] ♥??
- [596] Z. Nehari, *An integral equation associated with a function-theoretic extremal problems*, J. Anal. Math. 4 (1955), 29–48. [not quoted in AS60 nor in G78] [♠ p. 36 cite Bieberbach 1925 [97] (i.e. existence of a circle map of degree equal to the number of contours for a planar domain) and find a brilliant application of it to bound the the number of linearly independent solutions of a certain extremal problem. It seems realist to expect that this Nehari argument could be widely generalized by using Ahlfors 1950 [17] (and optionally Gabard 2006 [255]) in place of Bieberbach 1925 (*loc. cit.*). However the writer [Gabard, 30.07.12] does not understand why the inequality advanced by Nehari on p. 36 ought to be strict (as the integration is taking place within the contours where the modulus of the Bieberbach(-Ahlfors) function is unity! Hence try to locate the bug... ♠ in fact helped by an article of Leung 2007 (On an isoperimetric . . .) it seems that Nehari’s argument is hygienical modulo correcting the misprint on p. 29 that C_1 should be a subset of the (open) domain D (instead of the asserted contour C) [this is in agreement with the reviews generated by MR and ZB] ♠ then everything looks more plausible, and there is some hope to extend Nehari’s arguments to the more general setting of bordered surfaces—compare our treatment in Section 8.6] ♥1
- [597] E. Neuenschwander, *Lettres de Bernhard Riemann à sa famille*, Cahiers du sémin. hist. math. 2 (1981), 85–131. ♥??
- [598] E. Neuenschwander, *Über die Wechselwirkungen zwischen der französischen Schule, Riemann und Weierstraß. Eine Übersicht mit zwei Quellenstudien*, Arch. History Exact Sci. 24 (1981), 221–255. ♥??
- [599] C. Neumann, *Das Dirichletsche Prinzip in seiner Anwendung auf die Riemannschen Flächen*, Leipzig bei B. G. Teubner, 1865. ★ [♠ probably—together with the next item—one of the first place where the jargon “Riemann surface” is used in history] ♥??
- [600] C. Neumann, *Vorlesungen über Riemanns Theorie der Abelschen Integrale*, Leipzig bei B. G. Teubner, 1865. [♠ (For the Zweite Auflage, cf. 1884 [602].] ♥??
- [601] C. Neumann, *Neumann’s Untersuchungen über das Logarithmische und Newton’sche Potential*, (Referat des Verfasser). Math. Ann. 13 (1878), 255–300. ♥??
- [602] C. Neumann, *Vorlesungen über Riemanns Theorie der Abelschen Integrale*, Zweite Auflage, 1884, 472 pp. AS60 ★ [♠ contains, e.g., the first purely topological proof of the (so-called) Riemann-Hurwitz relation, according to Laugel’s French translation of Riemann’s Werke, p. 164.] ♥??
- [603] C. Neumann, *Über die Methode des arithmetischen Mittels insbesondere über die Vervollkommnungen, welche die betreffende Poincaré’schen Untersuchungen in letzter Zeit durch die Arbeiten von A. Korn und E. R. Neumann erhalten haben*, Math. Ann. 54 (1900), 1–48. AS60 ★ ♥??
- [604] R. Nevanlinna, *Ueber beschränkte analytische Funktionen, die in gegebenen Punkten vorgeschriebene Werte annehmen*, Ann. Acad. Sci. Fenn. BXV (1919), 71 pp. [♠ Nevanlinna’s first paper on the so-called Pick-Nevanlinna interpolation ♠ for a connection with the Ahlfors map (or generalization thereof) cf. e.g. Jenkins-Suita 1979 [393] ♠ as to Pick’s work cf. Pick 1916 [646]] ♥??
- [605] R. Nevanlinna, *Ueber beschränkte analytische Funktionen*, Comm. in honorem Ernesti Leonardi Lindelöf, Ann. Acad. Sci. Fenn. A XXXII (1929), 75 pp. [♠ Nevanlinna’s second paper on the so-called Pick-Nevanlinna interpolation ♠ same comment as for the previous entry [604]] ♥??
- [606] R. Nevanlinna, *Das harmonische Mass von Punktmengen und seine Anwendung in der Funktionentheorie*, C. R. Huitième Congr. Math. Scand., Stockholm, 1934,

- 116–133. AS60 ★ ♠ presumably the first place where the name “harmonic measure” appears, the concept going back at least to H. A. Schwarz (compare, e.g. Sario-Nakai 1970 [740]) ♡??
- [607] R. Nevanlinna, *Eindeutige analytische Funktionen*, 1936. AS60 [♠]★★ ♡??
- [608] R. Nevanlinna, *Über die Lösbarkeit des Dirichletschen Problems für eine Riemannsche Fläche*, Nachr. zu Gött. 1 (1939), 181–193. [♠ cited in BreLOT-Choquet 1951 [114], but the case of open Riemann surfaces]★★[ZB OK] ♡??
- [609] R. Nevanlinna, *Über das alternierende Verfahren von Schwarz*, J. Reine Angew. Math. 180 (1939), 121–128. [♠ Seidel’s summary: the convergence of the alternating procedure of Schwarz is proved under more general conditions on the boundary of the region than those considered by Schwarz and the problem is reformulated as a method of successive approximation applied to a certain integral equation] ♡??
- [610] R. Nevanlinna, *Quadratisch integrierbare Differentiale auf einer Riemannschen Mannigfaltigkeit*, Ann. Acad. Sci. Fenn. Ser. A. I. 1 (1941), 34 pp. AS60 [♠ an indispensable prerequisite to understand Kusunoki 1952 [488]: application of the Ahlfors mapping to the type problem.]
- [611] R. Nevanlinna, *Über die Neumannsche Methode zur Konstruktion von Abelschen Integralen*, Comment. Math. Helv. 22 (1949), 302–316. AS60
- [612] R. Nevanlinna, *Uniformisierung*, Zweite Auflage, Grundlehren der math. Wiss. 64, Springer, 1953, 391 pp. (The Second edition to which we refer, published in 1967) AS60 [♠ p.148–150, contains a very illuminating implementation of Schwarz’s alternating method applied to the problem of constructing harmonic functions with prescribed singular behavior, in particular the Green’s function of a compact bordered surface] ♡??
- [613] D. J. Newman, ???, Trans. Amer. Math. Soc. 92 (1959), 501–507. [♠ like the very deep corona problem, Newman’s characterization of interpolating sequence (also studied by Carleson, cf. e.g. Hoffman 1962 [381] for more historical details) is yet another paradigm which can be lifted from the disc to more general finite bordered Riemann surface via appeal to the Ahlfors map, as shown by Stout, cf. e.g. his second implementation in Stout 1967 [804]] ♡??
- [614] T. Nishino, *L’existence d’une fonction analytique sur une variété analytique complexe à deux dimensions*, Publ. RIMS, Kyoto Univ. 18 (1982), 387–419. A50 [♠ applies Ahlfors 1950 [17] to complex surfaces (4 real dimensions), and specifically the existence of an analytic function under a suitable assumption ♠ Nishino’s result was quickly extended by himself to arbitrary dimensions, yet during the process it seems that the relevance of Ahlfors 1950 [17] disappeared] ♡4
- [615] W. Nuij, *A note on hyperbolic polynomials*, Math. Scand. 23 (1968), 69–72. [♠ proof that two smooth plane curves with a deep nest are rigidly isotopic in the space of all algebraic curves ♠ cited in Vinnikov 1993 [848], who point out also the proof of Dubrovin 1983 [218]] ♡??
- [616] B. G. Oh, *A short proof of Hara and Nakai’s theorem*, Proc. Amer. Math. Soc. 136 (2008), 4385–4388. A50 [♠ Ahlfors 1950’s result on circle maps is used in a quantitative version of the corona ♠ question of the writer (since Sept. 2011): is it possible to exploit the improved bound of Gabard 2004/06 [255] in this sort of game ♠ p.4387, Ahlfors 1950 [17] is cited as follows: “**Theorem 3** (Ahlfors [1](=Ahlfors 1950 [17])). *Suppose R is a finitely³⁸ bordered Riemann surface with $g(R) = g$ and $b(R) = b$. Then there exists an m -sheeted branched covering map $f: R \rightarrow \mathbb{D}$, called the Ahlfors map, such that $b \leq m \leq 2g + b$.”] ♡0*
- [617] M. Ohtsuka, *Dirichlet problems on Riemann surfaces and conformal mappings*, Nagoya Math. J. 3 (1951), 91–137. AS60 [♠] ♡??
- [618] B. V. O’Neill, Jr., J. Wermer *Parts as finite-sheeted coverings of the disk*, Amer. J. Math. 90 (1968), 98–107. A50 [♠ p.98, the paper is started by citing Ahlfors 1950 [17] and mentions the alternative proof of Royden 1962 [716] ♠ the Ahlfors’s function is given an application to Gleason parts (certain analytic discs in the maximal ideal space) extending thereby a previous disc-result of Wermer 1964 ♠ p.98, it is emphasized that E. Bishop 196 5 [104] gave an abstract version of Ahlfors’ extremal problem in the context of function algebra on a compact space X (i.e. an algebra of complex-valued continuous functions containing the constants, separating the points, and closed under uniform convergence)] ♡2/3

³⁸Read “finite” to be more conventional.

- [619] D. Orth, *On holomorphic families of holomorphic maps*, Nagoya Math. J. 39 (1970), 29–37. [♠ p. 33, Ahlfors 1950 is cited as follows: “Ahlfors [1](=1950 [17]) has shown the existence of a holomorphic map f from a bordered Riemann surface with finite genus and a finite number of boundary components onto a full covering surface $S \xrightarrow{\pi} D$ of the unit disk. N. Alling [2] has shown that $\pi \circ f|U$ is a covering map of D near ∂D for some open neighborhood U of ∂X . Theorem 2.–4. can be thought of as concerning holomorphic families of such maps.”] ♡0
- [620] B. Osgood, *Notes on the Ahlfors mapping of a multiply connected domain*, Unpublished (?) manuscript (available from the web), undated (estimated date in the range 1993/2005). [♠ pleasant re-exposition of the neo-expressionist sort of the Ahlfors-Garabedian theory (inspired by Bell, Kerzman-Stein, etc.), in particular the formula for the Ahlfors function as the ratio of the Szegő kernel divided by the Garabedian kernel] ♡??
- [621] W. F. Osgood, *On the existence of the Green’s function for the most general simply connected plane region*, Trans. Amer. Math. Soc. 1 (1900), 310–314. AS60 ♡??
- [622] W. F. Osgood, *Jordan curve of positive area*, Trans. Amer. Math. Soc. 4 (1903), 107–112. [♠ shows how pathological Jordan curve can be] ♡??
- [623] W. F. Osgood, E. H. Taylor, *Conformal transformations on the boundary of their regions of definition*, Trans. Amer. Math. Soc. 14 (1913), 277–???. ♡??
- [624] W. F. Osgood, *Existenzbeweis betreffend Funktionen, welche zu einer eigentlichen diskontinuierlichen automorphen Gruppe gehören*, Palermo Rend. 35 (1913), 103–106. AS60 ♡??
- [625] R. Osserman, *A hyperbolic surface in 3-space*, Proc. Amer. Math. Soc. 7 (1956), 54–58. AS60 [♠ example of a function $\mathbb{R}^2 \rightarrow \mathbb{R}$, whose graph (endowed with the Euclidean metric) defines a surface of hyperbolic type, i.e. conformally equivalent to the disc, answering thereby a question of Ch. Loewner, reported by L. Bers in 1951 on the occasion of the 100th Birthday of Riemann’s thesis] ♡??
- [626] A. Ostrowski, *Mathematische Miscellen XV. Zur konformen Abbildung einfach zusammenhängender Gebiete*, Jahresb. Deutsch. Math.-Ver. 38 (1929), 168–182. [♣ omitted in both AS60 and G78; however this (joint with Carathéodory 1928 [144]) is the simply-connected version of the Ahlfors map] ♡??
- [627] K. Ott, *Über die Konstruktion monogener analytischer Funktionen mit vorgegebenen Unstetigkeitsstellen auf der Riemann’schen Fläche*, Monatsh. Math. 4 (1893), 367–375. AS60 ★ ♡??
- [628] M. P. Ovchintsev, *Optimal recovery of functions of class E_p , $1 \leq p \leq \infty$, in multiply connected domains*, Siberian Math. J. 37 (1996), 288–307. [♣ p. 293, three occurrences of “Ahlfors function” for m -connected domains; in particular Prop. 1 asserts the existence of neighborhoods of the boundary contours such that if z_0 lies in one of these neighborhood then the extra zeros of the Ahlfors function lie one-by-one in the other domains; in particular it seems likely that such neighborhoods can be chosen pairwise disjoint, in which case we recover a result of Bell 1991 [65]] ♡??
- [629] M. Ozawa, *On bounded analytic functions and conformal mapping, I*, Kōdai Math. J. (1950), 33–36. G78 ♡??
- [630] M. Ozawa, *A supplement to “Szegő kernel function on some domains of infinite connectivity”*, Kōdai Math. J. 13 (1961), 215–218. G78 [♠ p. 215: “Let D be an n -ply connected analytic domain and $\mathfrak{B}(D)$ be the class of regular functions in D whose moduli are bounded by the value 1. In $\mathfrak{B}(D)$ there exists, up to rotation, a unique extremal function by which the maximum $\max_{\mathfrak{B}(D)} |f'(z_0)|$ for a fixed point is attained. This extremal function $F(z, z_0)$ maps D onto the n times covered unit disc [1](=Ahlfors 1947 [16]), [3](=Garabedian 1949 [276]), [4](=Garabedian-Schiffer 1950 [279]), [9](=Nehari 1950 [590]), [11](=Schiffer 1950 [750]). In $\mathfrak{B}(D)$ there exists an infinite number of essentially different functions which map D onto the n times covered unit disc [2](=Bieberbach 1925 [97]), [5](=Grunsky 1937 [315]), [8](=Mori 1951 [570]).”] ♡??
- [631] P. Painlevé, *Sur les lignes singulières des fonctions analytiques*, Ann. Fac. Sci. Toulouse 2 (1888), 130 pp. G78 [♠ the classical Painlevé problem, interest revived through the work of Ahlfors 1947 [16] and complete solution in Tolsa 2003 [834]] ♡??
- [632] P. Painlevé, *Sur la théorie de la représentation conforme*, C. R. Acad. Sci. Paris 112 (1891), 653–657. [♠ one of the first study of the boundary behavior of the

- Riemann mapping for a domain bounded by a smooth Jordan curve ♠ same holds true for a general (topological) Jordan domain, cf. Osgood and Carathéodory] ♡??
- [633] H. Pajot, *Analytic capacity, rectifiability, Menger curvature and the Cauchy integral*, Lecture Notes in Math. ???, Springer-Verlag. [♠]★ ♡??
- [634] M. Parreau, *Sur les moyennes des fonctions harmoniques et analytiques et la classification des surfaces de Riemann*, Ann. Inst. Fourier (Grenoble) 3 (1951), 103–197. A50 [♠ Ahlfors 1950 [17] is briefly cited in two footnotes ♠ the work also contains a study of Hardy classes on Riemann surfaces extending the classical Hardy-Riesz’s brothers theory for the disc, and some overlap is to be found with the (subsequent) work of Rudin 1955 [721]]★ ♡153
- [635] O. Perron, *Eine neue Behandlung der ersten Randwertaufgabe für $\Delta u = 0$* , Math. Z. 18 (1923), 42–54. AS60 [♠ a new solution to the Dirichlet problem (using Poisson and Lebesgue’s integration) yielding the result in the same generality on the boundary (cf. p. 53–54) as those obtained by Lebesgue 1907 [499], Courant 1914 [186] and Lichtenstein (1916), but further very much simplified in Radó-Riesz 1925 [671] (according to e.g., Carathéodory 1937 [146, p. 710]) ♠ the paper is concluded by the simple remark (already made by Zaremba 1910 [908]) that the Dirichlet problem does not permit isolated boundary component (reducing to an isolated point), e.g. the punctured disc with boundary prescription 1 on the circumference and 0 at the center does not admit a harmonic extension, since otherwise the mean value property would be violated (intuitively a punktförmig radiator is too insignificant to induce a heat flow equilibrium) ♠ on the other hand this paper tolerates non-schlicht surfaces covering multiply the plane and therefore may be regarded as a suitable treatment of the Dirichlet problem on a compact bordered Riemann surface (given abstractly à la (Riemann-Prym-Klein)-Weyl-Radó), compare for this well-known affiliation the following ref. given backwardly in time: Radó 1925 [670], Weyl 1913 [881], and Klein 1882 [434]]★ ♡??
- [636] I. Petrowsky, *On the topology of real plane algebraic curves*, Ann. of Math. (2) 39 (1938), 189–209. (in English of course.) [♠ where the jargon M -curve is coined] ♡??
- [637] P. del Pezzo, *Sulle superficie di Riemann relative alle curve algebrice*, Palermo Rend. 6 (1892), 115–126. AS60 [♠ presumably one among the first reaction (outside the direct circle of Klein’s student: Harnack, Hurwitz, Weichold) to the reality works of F. Klein] ♡??
- [638] J. Plemelj, *Ein Ergänzungssatz zur Cauchy’schen Integraldarstellung analytischer Funktionen, Randwerte betreffend*, Monats. f. Math. u. Phys. 19 (1908), 205–210. [♠ quoted in Nehari 1955 [596]] ♡??
- [639] A. Pfluger, *Ein alternierendes Verfahren auf Riemannschen Flächen*, Comment. Math. Helv. 30 (1956), 265–274. AS60 [♠] ♡??
- [640] A. Pfluger, *Theorie der Riemannschen Flächen*, Grundlehren der math. Wiss. 89, Springer, Berlin, 1957, 248 pp. A50, AS60, G78 [♠ quotes the article Ahlfors 1950 [17] at several places (p. 126, 181, 185, 202) yet never in close connection with the circle map paradigm ♠ of course the book itself is a masterpiece of Swiss-German architecture and we do not attempt to summarize its broad content] ♡??
- [641] E. Picard, *Sur une propriété des fonctions entières*, C. R. Acad. Sci. Paris 88 (1879), 1024–1027. [♠ where the famous Picard theorem appears first (a nonconstant entire function (on \mathbb{C}) omits at most one value, for otherwise lifting to the universal covering Δ of $S^2 - \{3\text{rmpts}\}$ we get $\mathbb{C} \rightarrow \Delta$ a bounded analytic function violating Liouville’s theorem) ♠ widespread influence over Borel 1896, Schottky, Landau 1904, Lindelöf 1902 [516], Phragmén, Iversen, Montel, Bloch, Littlewood, Nevanlinna 1923, Ahlfors, Sario, etc. ♠ [07.10.12] since \mathbb{C} is the punctured sphere and Liouville’s theorem may be interpreted as Riemann’s removable singularity for bounded analytic function, one can also state that any analytic function defined on a punctured closed Riemann surface omits at most 3 values, but this is completely wrong for the monodromy principle does not apply anymore] ♡??
- [642] E. Picard, *De l’équation $\Delta u = ke^u$ sur une surface de Riemann fermée*, J. Math. Pures Appl. (4) 9 (1893), 273–291. AS60 [♠ supply an attempt to uniformize via the so-called Liouville equation, such a strategy seems to follow a problem suggested by H. A. Schwarz; for a modern execution of this programme cf. Mazzeo-Taylor 2002 [539] (and also a related work of Bieberbach 1916 [94])] ♡??
- [643] E. Picard, *Traité d’analyse, Vol. II, Fonctions harmoniques et fonctions analytiques. Introduction à la théorie des équations différentielles, intégrales abéliennes*

- et surfaces de Riemann*, Gauthier-Villars, Paris 1892. Reedited 1926, 624 pp. AS60 [♠ contains a treatment of Schottky's theory of 1877 (cited e.g. in Le Vavasieur 1902 [497], Cecioni 1908 [160] and Schiffer-Spencer 1954 [753])] ♡??
- [644] E. Picard, *Sur la représentation conforme des aires multiples connexes*, Ann. École Norm. (3) 30 (1913), 483–488. G78 [♠ a brilliant re-exposition of Schottky 1877 [763], which was much appreciated by Julia 1932 [407]] ♡??
- [645] E. Picard, ?????, Ann. École Norm. (3) 30 (1915), 483–488. [♠ yet another brilliant re-exposition of the Riemann mapping theorem via the Green's function] ♡??
- [646] G. Pick, *Ueber die Beschränkungen analytischen Funktionen, welche durch vorgegebene Funktionswerte bewirkt werden*, Math. Ann. 77 (1916), 7–23. [♠ the beginning of so-called Pick-Nevanlinna interpolation, and see Heins 1975 [361] or Jenkins-Suita 1979 [393] for an extension to finite bordered Riemann surface offering an overlap (indeed an extension) of the Ahlfors map] ♡??
- [647] U. Pirl, *Über isotherme Kurvenscharen vorgegebenen topologischen Verlaufs und ein zugehöriges Extremalproblem der konformen Abbildung*, Math. Ann. 133 (1957), 91–117. G78 [♠] (another well-known student of Herbert Grötzsch) ♡??
- [648] H. Poincaré, *Mémoire sur les fonctions fuchsienues*, Acta Math. 1 (1882), 193–294. AS60 ♡??
- [649] H. Poincaré, *Sur un théorème général de la théorie des fonctions*, Bull. Soc. Math. France 11 (1883), 112–125. G78 [♠ proposes (and succeeds partially) to uniformize not only algebraic, but also analytic curves (=open, a priori highly transcendental, Riemann surfaces). Programm completed in Poincaré 1907 [653], independently Koebe 1907 [450].] ♡??
- [650] H. Poincaré, *Sur les équations aux dérivées partielles de la physique mathématique*, Amer. J. Math. 12 (1890), 211–294. [♠ where the *méthode du balayage* is first introduced] ♡??
- [651] H. Poincaré, *Sur la méthode de Neumann et le problème de Dirichlet*, C. R. Acad. Sci. Paris 120 (1895), 347–352. AS60 ♠ ♡??
- [652] H. Poincaré, *La méthode de Neumann et le problème de Dirichlet*, Acta Math. 20 (1896), 59–142. AS60 [♠ it seems that the method in question, may in turn go back to Gauss 1839 [287]] ♠ ♡??
- [653] H. Poincaré, *Sur l'uniformisation des fonctions analytiques*, Acta Math. 31 (1907), 1–63. AS60, G78 [♠ simultaneously with Koebe 1907 [450] uniformize arbitrary complex analytic curves (equivalently open Riemann surfaces), completing the 1883 desideratum of Poincaré in [649], revived in Hilbert's 22th problem] ♡??
- [654] Ch. Pommerenke, *Über die analytische Kapazität*, Archiv der Math. 11 (1960), 270–277. [♠ some estimates of the analytic capacity (defined as in Ahlfors 1947 [16]) and its connection to Schiffer's span 1943 [747] ♠ uses heavily Ahlfors-Beurling 1950 [18] and Nehari 1952 [594]] ♡??
- [655] H. Poritsky, *Some industrial applications of conformal mapping*. In: *Construction and Applications of Conformal Maps*, Proc. of a Sympos. held on June 22–25 1949, Applied Math. Series 18, 1952, 207–213. [♠ quoted for a joke about free-hand drawings] ♡??
- [656] R. de Possel, *Sur le prolongement des surfaces de Riemann*, C. R. Acad. Sci. Paris 186 (1928), 1092–1095. AS60 [♠ problem of deciding when an (open) Riemann surface can be continued to a larger one ♠ relates to work of Radó 1924 [669], and Bochner 1927 [108]] ♡??
- [657] R. de Possel, *Sur le prolongement des surfaces de Riemann*, C. R. Acad. Sci. Paris 187 (1929), 98–100. AS60 [continuation of the previous work in the spirit of Radó and Bochner] ♡??
- [658] R. de Possel, *Zum Parallelschlitztheorem unendlich-vielfach zusammenhängender Gebiete*, Gött. Nachr. (1931), 199–202. AS60, G78 [♠ proof of the parallel-slit mapping à la Schottky 1877 [763]-Cecioni 1908 [160]-Hilbert 1909 [377]-Koebe 1910 [457]-Courant 1910/12 [185], via an extremal problem (method analogous to Carathéodory 1928 [144], but uses also the Flächensatz of Bieberbach) ♠ of course Schottky-Cecioni are not cited as they only treats the case of finite connectivity ♠ it is noteworthy that the similar problem for the Kreisnormierung is still unsolved in full generality. This supports once more the philosophy advanced by Garabedian-Schiffer 1950 [279] that parallel-slit mappings are easier than circle maps]

- [659] R. de Possel, *Quelques problèmes de représentation conforme*, J. École Polytech. (2) 30 (1932), 1–98. AS60, G78 [♠ parallel (as well as radial) slit maps in the case of domains via an extremal problem ♠ some little details of it seem to be criticized in Ahlfors-Beurling 1950 [18]] ♡??
- [660] R. de Possel, *Sur quelques propriétés de la représentation conforme des domaines multiplement connexes, en relation avec le théorème des fentes parallèles*, Math. Ann. 107 (1932), 496–504. AS60, G78 [♠ again parallel-slits via an extremal problem, overlap with work by Grötzsch] ♡??
- [661] R. de Possel, *Sur les ensembles de type maximum, et le prolongement des surfaces de Riemann*, C. R. Acad. Sci. Paris 194 (1932), 98–100. AS60 [♠ still relates to work of Radó, and Bochner and reports some mistakes in the previous notes] ♡??
- [662] R. de Possel, *Sur la représentation conforme d'un domaine à connexion infinie sur un domaine à fentes parallèles*, J. Math. Pures Appl. (9) 18 (1939), 285–290. AS60, G78 [♠ as noted in Burckel 1979 [128], this de Possel paper affords a trick to circumvent the reliance upon RMT in his 1931 proof of the PSM through an extremum problem, similar trick in Garabedian 1976 [281]] ★★★ ♡??
- [663] W. Pranger, *Extreme points in the Hardy class H^1 of a Riemann surface*, Canad. J. Math. 23 (1971), 969–976. A50 [♠ Ahlfors 1950 [17] is quoted twice: on p.975 for certain decompositions and on p.976: “On a compact bordered surface R the periods of the conjugate of a function which is harmonic on R and continuous on its closure may be specified arbitrarily (see [1, p. 110]=Ahlfors 1950 [17, p. 110])] ♡0
- [664] F. E. Prym, *Zur Integration der Differentialgleichung $\frac{\partial^2 u}{\partial x^2} + \frac{\partial^2 u}{\partial y^2} = 0$* , J. Reine Angew. Math. 73 (1871), 340–364. [♠ p.361–364, an example is given of a continuous function on the unit-circle whose harmonic extension to the disc has infinite Dirichlet integral! (The existence of such an extension is established directly in the first part of the paper, independently of Schwarz’s 1870 [770] solution based upon Poisson’s integral.) This Prym’s example is nothing less than a counterexample to the Dirichlet principle (as formulated, e.g., in Grube’s text [208]=redaction of Dirichlet’s lectures). Compare Elstrodt-Ulrich 1999 [222, p. 285]. Prym emphasizes at the end of his paper (p.364) that Riemann himself never committed such a “basic” mistake, but (still on p.364) Prym formulates an implicit critic to all contemporary attempts to rescue the Dirichlet principle based on the tacit assumption of finiteness of the Dirichlet integral, presumably including the one of Weber 1870 [872] (who is however not directly attacked for diplomatique reasons) ♠ a related example (where any continuous function matching the boundary data has infinite Dirichlet integral) is due to Hadamard 1906 [330] ♠ such counter-example affects directly the Dirichlet-Riemann argument of minimizing the Dirichlet integral, and seems to destroy as well H. Weber’s attempt (1870 [872]) to consolidate Riemann’s proof \diamond student of Riemann, who played a pivotal role as well in explaining to Klein, that Riemann himself did not confined his attention to surfaces spread over the plane but included a more organical mode leading to the “abstract” Riemann surfaces, compare Klein 1882 [434]] ♡??
- [665] T. Radó, *Zur Theorie der mehrdeutigen konformen Abbildung*, Acta Szeged 1 (1922), 55–64. G78 [♠ quoted in Landau-Osserman 1960 [493], who ascribe to Radó the basic fact that an analytic map taking boundary to boundary is a full covering surface taking each value a constant number of times ♠ hence this Radó bears an obvious connection to the Ahlfors map, albeit it does not reprove its existence when the target surface is the disc] ♡14
- [666] T. Radó, *Über die Fundamentalabbildung schlichter Gebiete*, Acta Sci. Math. Szeged 1 (1922/23), 240–251; cf. also Fejér’s Ges. Arb. 2, 841–842. G78 [♣ supplies in print an argument of Fejér-Riesz proving RMT via an extremal problem (maximization of the derivative), perfected in Carathéodory 1928 [144] and Ostroski 1929 [626] ♣ this constitutes the underlying background for the extremal methods used by Grunsky and Ahlfors, leading ultimately to Ahlfors 1950 [17]] ♡??
- [667] T. Radó, *Bemerkung zu einem Unitätssatz der konformen Abbildung*, Acta litt. ac. scient. Univ. Hung. 1 (1923), 101–103. G78 ♡??
- [668] T. Radó, *Über die konforme Abbildung schlichter Gebiete*, Acta litt. ac. scient. Univ. Hung. 2 (1924), 47–60. G78 ♡??
- [669] T. Radó, *Über eine nicht fortsetzbare Riemannsche Mannigfaltigkeit*, Math. Z. 20 (1924), 1–6. AS60 ♡high?

- [670] T. Radó, *Über den Begriff der Riemannschen Fläche*, Acta Szeged 2 (1925), 101–121. AS60 [¶: aside from Weyl 1913 [881] (“sheaf” theoretic) this is the first definition of an “abstract” Riemann surface, modulo Klein who anticipated the “atlas” idea quite explicitly in [439] (“Dachziegelige Überdeckung”) CHECK. Klein knew it essentially since Prym indicated him how Riemann saw the story, as reported, e.g., in the introduction of Klein 1882 [434].] ♡high?
- [671] T. Radó, F. Riesz, *Über die erste Randwertaufgabe für $\Delta u = 0$* , Math. Z. 22 (1925), 41–44. [♠ supplies drastic simplifications over Perron’s method (Perron 1923 [635]) according to Carathéodory 1937 [146, p. 710]] ♡high?
- [672] T. Radó, *Subharmonic functions*, Berlin, 1937. ♡??
- [673] H. E. Rauch, *Weierstrass points, branch points, and the moduli of Riemann surfaces*, Comm. Pure Appl. Math. 12 (1959), 543–560. [♠]★ ♡high?
- [674] H. E. Rauch, *A transcendental view of the spaces of algebraic Riemann surfaces*, Bull. Amer. Math. Soc. 71 (1965), 1–39. [♠ the cream of the theory (Riemann, Teichmüller, Ahlfors, etc. revisited)] ♡??
- [675] A. H. Read, *Conjugate extremal problems of class $p = 1$* , Ann. Acad. Sci. Fenn., A.I., 250/28 (1958), 8 pp. AS60, G78 ♡??
- [676] A. H. Read, *A converse to Cauchy’s theorem and applications to extremal problems*, Acta Math. 100 (1958), 1–22. A50, G78 [♣ an alternative proof of Ahlfors 1950 [17] is given via Hahn-Banach ♣ subsequent work via a similar approach in Royden 1962 [716] ◇ we probably do not need to recall that both Royden and Read were students of Ahlfors] ♡22
- [677] E. Reich, S. E. Warschawski, *On canonical conformal maps of regions of arbitrary connectivity*, Pacific J. Math. 10 (1960), 965–985. G78 [♠ like Meschkowski 1953 [552] (which is not cited!) shows that the Ahlfors-type problem of maximizing the derivative among *schlicht* function bounded-by-one gives a conformal map upon a Kreisschlitzbereich (=circular slit disc). This analysis is also based upon Rengel’s inequality, or a variant thereof closer to Grunsky’s Thesis 1932] ♡28
- [678] H. J. Reiffen, *Die differentialgeometrischen Eigenschaften der invarianten Distanzfunktion von Carathéodory*, Schrift Math. Inst. Univ. Münster 26 (1963). [♠ quoted e.g. in Burbea 1977 [123]]★ ♡??
- [679] R. Remmert, *Funktionentheorie 2*, Grundwissen Mathematik 6, Springer-Lehrbuch, 1991. (1. unveränderter Nachdruck 1992 der 1. Auflage.) ♡??
- [680] R. Remmert, *From Riemann surfaces to complex spaces*, Séminaire et Congrès 3, Société Math. de France, 1998, 203–241. ♡??
- [681] E. Rengel, *Über einige Schlitztheoreme der konformen Abbildung*. (Diss.), Schriften math. Semin., Inst. angew. Math. d. Univ. Berlin 1 (1932/33), 140–162. AS60, G78 ★ ♡??
- [682] E. Rengel, *Existenzbeweise für schlichte Abbildungen mehrfach zusammenhängender Bereiche auf gewisse Normalbereiche*, J.-Ber. Deutsche Math.-verein. 44 (1934), 51–55. AS60, G78 [♠ via the extremal problem method in vogue at the time obtain the existence of the circular/radial slit maps for domain of finite connectivity (cf. also de Possel, and Grötzsch) ♠ the terminology “Normalbereiche” goes back to Weierstrass, compare Schottky’s Thesis 1877 [763] ♠ this paper shows the existence of a *schlicht* mapping of a finitely-connected domain upon a circular slit disk ♠ antecedent in Koebe 1918, see also Reich-Warschawski 1960 [677]] ♡18
- [683] H. Renggli, *Zur konformen Abbildung auf Normalgebiete*, (Diss. ETH Zürich) Comment. Math. Helv. 31 (1956), 5–40 AS60, G78 [♠ limited to plane domains, where the various slit mappings are reproved via an extremal problem involving the extremal length, Montel’s normal families are used] ♡??
- [684] M. von Renteln, *Friedrich Prym (1841–1915) and his investigations on the Dirichlet problem*, Suppl. Rend. Circ. Mat. Palermo 44 (1996), 43–55 [♠ detailed discussion of Prym’s counterexample to the (naive) Dirichlet principle (compare Prym 1871 [664])]★★★ ♡4
- [685] S. Richardson, *Hele-Shaw flows with time-dependent free boundaries involving a multiply-connected fluid region*, European J. Appl. Math. 12 (2001), 571–599 [♠] ♡??
- [686] B. Riemann, *Grundlagen für eine allgemeine Theorie der Functionen einer veränderlichen complexen Grösse*. Inauguraldissertation Göttingen, 1851. In: Ges.

- math. Werke [690]. [♣ first proof of RMT, some bad tongues claim that the proof is dubious (even abstraction made of the difficulty allied to the Dirichlet principle), whereupon Riemann reacted with [688]] ♡??
- [687] B. Riemann, *Theorie der Abel'schen Functionen*, Crelle J. Reine Angew. Math. 54 (1857), ?-?. In: Ges. math. Werke [690, 88–142]. [♠ contains in particular the statement that any (or at least one with general moduli?) closed Riemann surface of genus g maps conformally to the sphere with $\leq [\frac{g+3}{2}]$ sheets ♠ this assertion not accepted by modern geometers until Meis 1960 [541] ♣ p. 116, some historical hints given by Riemann shows an involvement with conformal maps of multiply-connected regions (maybe even surfaces) as early as Fall 1851 (up to Begin 1852), but then he was sidetracked to another topic] ♡??
- [688] B. Riemann, *Bestimmung einer Function einer veränderlichen complexen Grösse durch Grenz- und Unstetigkeitsbedingungen*, Crelle J. Reine Angew. Math. 54 (1857), 111–114. [♣ after Riemann 1851 [686] the second (more solid, but less romantic) proof of RMT, of course in retrospect not sound until Hilbert's resurrection of the Dirichlet principle] ♡??
- [689] B. Riemann, *Gleichgewicht der Electricität auf Cylindern mit Kreisförmigem Querschnitt und parallelen Axen. Conforme Abbildung von durch Kreise begrenzten Figuren* (Nachlass XXVI). In: Ges. math. Werke [690, p. 472–476]. G78 [♣ the first version of the “Ahlfors map” in the planar case (perhaps confined to the case of circular domains) ♠ for subsequent works see primarily Schottky 1875/77 [763], Bieberbach 1925 [97], Grunsky 1937–41/40–42, Ahlfors 1947–50 [17]] ♡??
- [690] B. Riemann, *Gesammelte mathematische Werke, wissenschaftlicher Nachlass und Nachträge*, Nach der Ausgabe von H. Weber und R. Dedekind, Teubner, Leipzig, 1876; neu herausgegeben von R. Narasimhan, Springer-Verlag, Berlin, 1990. AS60 ♡??
- [691] F. Riesz, *Ueber Potenzreihen mit vorgeschriebenen Anfangsgliedern*, Math. Z. 18 (1923), 87–95. [♠ cited in Heins 1975 [361], who employs a Riesz variational formula to derive another proof of Ahlfors' circle maps with upper control upon the degree ♠ in fact the cited variational formula of F. Riesz, was given by him for the case $p = 1$ (Hardy classes index) and for the disc Δ . However it is available suitably modified for any (finite) bordered Riemann surface and all possible Hardy classes indexes $1 \leq p < \infty$. (source=p. 20 of the just cited Heins work, where for details one must probably browse Heins 1969 [360])] ♡??
- [692] F. Riesz, *Über die Randwerte einer analytische Funktion*, Math. Z. 18 (1923), 87–95. [♠] ♡??
- [693] F. Riesz, *Sur les fonctions subharmoniques et leur rapport à la théorie du potentiel*, Acta Math. 54 (1930), 321–360. [♠] ♡??
- [694] ?? Robertson, *On the theory of univalent functions*, Ann. of Math. 37 (1936), 374–408. [♠ contains a simple derivation of the Bieberbach conjecture $|a_n| \leq n|a_1|$ for starlike regions via the Schwarz-Christoffel formula] ♡330
- [695] G. Robin, *Sur la distribution de l'électricité à la surface des conducteurs fermés et des conducteurs ouverts*, Ann. Sci. École Norm. Sup. 3 (1886), 3–58. [♠] ♡??
- [696] R. M. Robinson, *Analytic functions in circular rings*, Duke Math. J. 10 (1943), 341–354. G78 [♠ quoted in Minda 1979 [554] in connection with the theta function expression of the Ahlfors function of an annulus ♠ for this see also Golusin 1952/57 [296] ♠ also quoted in Jenkins-Suita 1979 [393]] ♡??
- [697] R. M. Robinson, *Hadamard's three circles theorem*, Bull. Amer. Math. Soc. 50 (1944), 795–802. G78 [♠]★★ ♡??
- [698] G. Roch, *Ueber die Anzahl der willkürlichen Constanten in algebraischen Functionen*, Crelle J. Reine Angew. Math. 64 (1865), 372–376. ♡??
- [699] R. Rochberg, *Almost isometries of Banach spaces and moduli of Riemann surfaces*, Duke Math. J. ?? (1973), ??-??. [♠ compact bordered Riemann surfaces] ♡11
- [700] R. Rochberg, *Deformation of uniform algebras on Riemann surfaces*, Pacific J. Math. 121 (1986), 135–181. A50 [♠ on p. 142 Ahlfors 1950 [17] is cited as follows: Ahlfors has shown that given S in \mathcal{S} [the set of all connected finite bordered Riemann surfaces, cf. p. 135] and x, y in $S \setminus \partial S$ there is a function $F = F_{x,y}$ in $A(S)$ which has $|F| = 1$ identically on ∂S , $F(x) = 0$, $F(y) \neq 0$, and F maps S onto the closed unit disk in an m to one manner (counting multiplicity). Furthermore,

if g denotes the genus of S and c the number of components of ∂S , then F can be selected so that m satisfies $c \leq m \leq 2g + c$. ♠ on the same page the Ahlfors' bound ($r + 2p$ in our notation) is applied to a problem a bit too technical to be summarized here, and naively one could ask if the improved bound $r + p$ of Gabard 2006 [255] could be applied to Rochberg's work. This is not evident because a lowest possible degree map does not a priori separates two points prescribed in advance (hence we have not pursued the issue further) ♡9

- [701] B. Rodin, L. Sario, *Principal functions*, Princeton, van Nostrand, 1968. G78 ★★
- [702] B. Rodin, *The method of extremal length*, Bull. Amer. Math. Soc. 80 (1974), 587–606. G78 [♠ p. 590 Teichmüller listed (without reference!) amongst the contributor to the Löwner-Pu systolic inequality? ♠ if this is true it would be nice to localize the precise source] ♡28
- [703] B. Rodin, D. Sullivan *The convergence of circle packings to the Riemann mapping*, J. Differ. Geom. 26 (1987), 349–360. [♠ building over work of Koebe 1936 (not cited), Andreev 1970 and Thurston 1985, develop a convergence proof of (finitistic) approximation by circle packings of the Riemann mapping ♣ an obvious desideratum would be to implement a similar proof for the case of the Ahlfors function on compact bordered Riemann surface] ♡??
- [704] W. W. Rogosinski, H. S. Shapiro, *On certain extremum problems for analytic functions*, Acta Math. 90 (1953), 287–318. [♠ this article pertains to our topic (of the Ahlfors map) inasmuch as it may have influenced some new generation existence-proof (of “abstract” functional analytic character) of the Ahlfors map (where Hahn-Banach takes over the role of Euler-Lagrange), like those of Read 1958 [676], and the popular version of Royden 1962 [716]] ♡??
- [705] V. A. Rohlin, *Complex orientations of real algebraic curves*, Funkt. Anal. Prilozhen. 8 (1974), 71–75; translation: Funct. Anal. Appl. 8 (1974), 331–334. [♠ present a general method of closing one half of dividing real plane curve by pieces of real disc to construct a closed membrane whose (fundamental) homology class, yields via intersection theory a certain numerical relation known as Rohlin formula. The latter implies the striking fact that a dividing curve exhibits at least as many ovals as the half value of its degree. This answers a question of Klein, made more explicit in Gross-Harris 1981 [308]. Compare Gabard 2000 [253] for more details. NB: In this seminal Rohlin's paper only the case of M -curve(=Harnack maximal) is treated (the general formula being written down in the next item Rohlin 1978 [706]), but the proof is easy to adapt.] ♡??
- [706] V. A. Rohlin, *Complex topological characteristics of real algebraic curves*, Uspekhi Mat. Nauk. 33 (1978), 77–89; translation: Russian Math. Surveys 33 (1978), 85–98. [♠ shows strikingly that Rohlin discovered Klein's work at a very late stage (despite the fact that Klein is generously quoted e.g. in Gudkov 1974 [323]), but with great happiness apparently (p. 85): “As I learned recently, more than hundred years ago, the problems of this article occupied Klein, who succeeded in coping with curves of degree $m \leq 4$ (see [4](=Klein 1922 [442]), p. 155).” ♠ p. 93–94 prove the result that a real plane curve with a nest of maximal depth is dividing, via an argument which (in our opinion) can be slightly simplified as follows ♠ given $C_m \subset \mathbb{P}^2$ a nonsingular curve of degree m with a deep nest then projecting the curve from any point chosen in the innermost oval gives a morphism $C_m \rightarrow \mathbb{P}^1$ whose fibers over real points are totally real. Hence there is an induced map between the imaginary loci $C_m(\mathbb{C}) - C_m(\mathbb{R}) \rightarrow \mathbb{P}^1(\mathbb{C}) - \mathbb{P}^1(\mathbb{R})$ and it follows that C_m is dividing (just by using the fact that the image of a connected set is connected). q.e.d. (this argument avoids the consideration of the canonical fibering pr: $\mathbb{C}P^2 - \mathbb{R}P^2 \rightarrow S^2$ envisaged by Rohlin)] ♡??
- [707] E. Rödning, *Konforme Abbildung endlicher Riemannscher Flächen auf kanonische Überlagerungsflächen der Zahlenkugel*, Diss. Würzburg, 1972, 71 S. G78 [♠ this entry is cited on the “critical” page 198 of Grunsky 1978 [322], according to which it gives a generalization to Riemann surfaces of the Bieberbach-Grunsky theorem (i.e. circle map in the planar case) ♠ in particular, it could be the case that Rödning reproves the existence of an Ahlfors circle map, yet probably this is not the case ♠ perhaps this aspect has been subsequently published in Rödning 1977 [710]] ★ ♡??
- [708] E. Rödning, *Nichtschlichte konforme Abbildung[en] unendlich vielfach zusammenhängender Teilgebiete der Ebene*, Arch. d. Math. 26 (1975), 391–397. G78 [♠ infinite connectivity analog of the “Riemann-Bieberbach” mapping theorem.] ♡??

- [709] E. Rödning, *Über die Wertannahme der Ahlforsfunktion in beliebigen Gebieten*, Manuscr. Math. 20 (1977), 133–140. G78 ♡??
- [710] E. Rödning, *Über meromorphe Funktionen auf endlichen Riemannschen Flächen vom Betrag eins auf den Randlinien*, Math. Nachr. 78 (1977), 309–318. G78 ♡??
- [711] H. Röhrl, *Unbounded coverings of Riemann surfaces and extensions of rings of meromorphic functions*, Trans. Amer. Math. Soc. 107 (1963), 320–346. [♠ cited in Alling 1965 [35], and one may wonder about a connection with Ahlfors 1950, i.e. the “unbounded covering” in question (cf. definition on p. 328) are probably related to circle maps, at least extended versions thereof where the target is not necessarily the unit disc of course Röhrl’s notion is quite standard, albeit the terminology is far from uniformized, cf. e.g. Ahlfors-Sario’s “complete covering surfaces” (in 1960=[22, p. 42] themselves patterned after Stoilow’s “total coverings” ♠ alas, it does not seem that Röhrl reproves Ahlfors result (which would have been pleasant in view of Röhrl great familiarity with Meis’s work 1960 [541])] ♡??
- [712] P. C. Rosenbloom, *Quelques classes de problèmes extrémaux*, Bull. Soc. Math. France 80 (1952), 183–215. [♠ this worked is cited in Forelli 1979 [246], where it is employed to derive another existence-proof of circle-maps with the same control upon the degree as in Ahlfors 1950 [17]] ♡??
- [713] M. Ross, *The second variation of nonorientable minimal submanifolds*, Trans. Amer. Math. Soc. 349 (1997), 3093–3104. [♠ p. 3097 criticizes the argument of Li-Yau 1982 [506] for the Witt-Martens mapping ♠ gives differential geometric application of it to (non-orientable) minimal surfaces] ♡??
- [714] H. L. Royden, *Harmonic functions on open Riemann surfaces*, Trans. Amer. Math. Soc. 73 (1952), 40–94. A50 [♣ this is, in substance, the author’s thesis [Harvard University, 1951] (under Ahlfors) ♠ it contains very deep material “sufficient condition for the hyperbolic type in term of a triangulation of the surface” (causing a great admiration by Pfluger, etc.), yet from our finitistic perspective the paper seems to contain little about the Ahlfors map, for this issue see rather the subsequent paper Royden 1962 [716]] ♡??
- [715] H. L. Royden, *Rings of meromorphic functions*, Proc. Amer. Math. Soc. 9 (1958), 959–965. [♣ this article is often credited by Alling to be the first employment of Ahlfors map as a technique to lift truths from the disc to more general finite bordered surfaces, e.g. in the Acknowledgements of Alling 1965 [35] or in Alling’s review of Stout 1965 [802] one reads: “The third technique is dependent on the existence of the Ahlfors map P (=1950 [17]), which maps a compact bordered Riemann surface \bar{R} , finite-to-one, onto \bar{U} . This gives rise to the algebraic approach, for the adjoint of P is an isomorphism of $H_\infty(U)$ into $H_\infty(R)$, the extension being finite and very tractable. This approach was apparently first used by Royden 1958 [=this entry=[715]]. Later it was utilized extensively by the reviewer, who working independently of the author [=Stout], announced his extension of Carleson’s corona result to R [...]”]★★ ♡??
- [716] H. L. Royden, *The boundary values of analytic and harmonic functions*, Math. Z. 78 (1962), 1–24. [♣ re-prove the existence and properties of the Ahlfors function via Hahn-Banach, along the path of Read 1958 [676]] ♡57/62
- [717] L. A. Rubel, J. V. Ryff, *The bounded weak-star topology and the bounded analytic functions*, J. Funct. Anal. 5 (1970), 167–183. A47, A50 [♣]★★★NY(only-MR) ♡29
- [718] L. A. Rubel, *Bounded convergence of analytic functions*, Bull. Amer. Math. Soc. 77 (1971), 13–24. A47, A50 [♣ p. 18 the two works of Ahlfors 1947 [16], 1950 [17] are quoted in connection with the following problem about inner functions: “In the case of the general region G [supposed (cf. p. 17) to support nonconstant bounded analytic functions and to enclose no removable singularities for all bounded analytic functions], one would guess that the solution, known to exist, of any of several extremal problems would be inner, and consequently hypo-inner. For example, choose a point $z_0 \in G$ and consider $f \in B_H(G)$ [i.e. the space of bounded analytic function] so that $\|f\|_\infty \leq 1$ and $f(z_0) = 0$, and maximize $|f'(z_0)|$. The extremal function is the so-called Ahlfors function, and in case G is finitely connected, it is known [2](=Ahlfors 1947 [16]), [3](=Ahlfors 1950 [17]) to be inner.” ♠ let us recall definitions (cf. p. 17–18): a bounded analytic function on the disc $F \in B_H(D)$ is *inner* if $\|F\|_\infty \leq 1$ and if its Fatou radial limit function $F^*(e^{i\theta}) = \lim_{r \rightarrow 1} F(re^{i\theta})$ has unit modulus for almost all θ (w.r.t. usual arc length). It is said to be *hypo-inner* if the Fatou limit has unit modulus for a set of θ of positive measure. For a function on a general domain G , $f \in B_H(G)$, the notions of inner and hypo-inner

- are transposed via precomposition with the universal covering map $D \rightarrow G$. ♠ now as to Rubel's guess, it seems to be answered in the negative in Gamelin 1973 [266, p.1107], with details to be found in Gamelin 1974 [269]] ♡13/6
- [719] L. A. Rubel, *Some research problems about algebraic differential equations*, Trans. Amer. Math. Soc. 280 (1983), 43–52. [♣ p.47 the Ahlfors function is mentioned as follows: “To prepare the way for the next problem, we shall define the *Ahlfors function*. If G is a (presumably multiply connected) region and z_0 is a point in G , we define the Ahlfors function α_{z_0} with *base point* z_0 as the (unique)solution of the following extremal problem: (i) $\alpha(z_0) = 0$, (ii) $|\alpha(z)| \leq 1$ for all $z \in G$, (iii) $\alpha'(z_0)$ is as large as it can be for the class of functions satisfying (i) and (ii). In case G is simply connected, α_{z_0} becomes the Riemann map of G onto D that takes z_0 to 0, with positive derivative there. *Problem 11. Suppose α_{z_0} is hypotranscendental, and let $z_1 \in G$ be another base point. Must α_{z_1} be hypotranscendental too?* ♡??
- [720] W. Rudin, *Some theorems on bounded analytic functions*, Trans. Amer. Math. Soc. 78 (1955), 333–342. A47, G78 [♠ new (simpler) proof of an (unpublished) theorem of Chevalley-Kakutani stating that a plane domain B such that for each of its boundary-point p there is a bounded analytic function on B possessing at p a singularity is determined (modulo a conformal transformation) by the ring of all bounded analytic functions on B ♠ the proof makes uses of general results of Ahlfors 1947 [16], yet apparently no use is made of the Ahlfors function] ♡??
- [721] W. Rudin, *Analytic functions of class H^p* , Trans. Amer. Math. Soc. 78 (1955), 46–66. A47 [♠] ♡149
- [722] W. Rudin, *The closed ideals in an algebra of continuous functions*, Canad. J. Math. 9 (1957), 426–434. [♠ proof of an unpublished result of Beurling describing the ideal theory of the algebra $A(\overline{\Delta})$ of continuous function on the closed disc analytic on its interior ♠ for extensions of this Beurling-Rudin result to compact bordered surfaces, cf. Voichick 1964 [857], Limaye's Thesis 1968 and Stanton 1971 [797] (who makes use of the Ahlfors map) ♠ for an extension to non-orientable Klein surfaces (where no Ahlfors map are available!), see Alling-Limaye 1972 [40]] ♡??
- [723] W. Rudin, *Pairs of inner functions on finite Riemann surfaces*, Trans. Amer. Math. Soc. 140 (1969), 423–434. [♠ inner function as a synonym of the (Ahlfors) circle maps] ♡??
- [724] W. Rudin, *Real and complex analysis*, McGraw-Hill. [♠] ♡8982
- [725] S. Saitoh, *The kernel functions of Szegő type on Riemann surface*, Kodai Math. Sem. Rep. 24 (1972), 410–421. [♠ Bergman kernel on compact bordered Riemann surfaces] ♡??
- [726] S. Saitoh, *The exact Bergman kernel and the kernels of Szegő*, Pacific J. Math. 71 (1977), 545–557. [♠ Bergman kernel on compact bordered Riemann surfaces] ♡??
- [727] S. Saitoh, *The Bergman norm and the Szegő norm*, Trans. Amer. Math. Soc. 249 (1979), 261–279. [♠ Bergman kernel on compact bordered Riemann surfaces] ♡??
- [728] S. Saitoh, *A characterization of the adjoint L -kernel of Szegő type*, Pacific J. Math. 96 (1981), 489–493. [♠ compact bordered Riemann surfaces, Green's function and reproducing kernel] ♡0
- [729] S. Saitoh, *Theory of reproducing kernels and its applications*, Pitman Res. Notes in Math Series 189, 1988. x+157 pp. [♠ reproducing kernel in the abstract united exposition of Aronszajn 1950 [50], followed by a specialization to the case of multiply connected plane domains (esp. Garabedian's L -kernel as the solution to an extremal problem for the Dirichlet integral)] ♡386
- [730] S. Saitoh, *Theory of reproducing kernels; applications to approximate solutions of bounded linear operator equations on Hilbert spaces*, Amer. Math. Soc. Transl., 2010. [♠ mentions the “Ahlfors function”] ♡4
- [731] M. Sakai, *On constants in extremal problems of analytic functions*, Kodai Math. Sem. Report 21 (1969), 223–225. [♠ p.223 seems to consider the problem of minimizing the Dirichlet integral $D[f] = \int \int_W df \cdot \overline{df^*}$ among the analytic functions f on a Riemann surface W normalized by $f(t) = 0$ and $f'(t) = 1$ (w.r.t. some local uniformizer) [see also Schiffer-Spencer 1954 [753]] ♠ alas nothing seems to be asserted about the range of the least area mapping (in particular we still wonder if it is a circle map as looks plausible in view of the simply connected case treated in Bieberbach 1914 [92])] ♡??

- [732] T. Salvemini, *Sulla rappresentazione conforme delle aree piane pluriconnesse su una superficie di Riemann di genere zero in cui sono siano eseguiti dei tagli paralleli*, Ann. Scuola Norm. Super. Pisa (1) 16 (1930), 1–34. [♠ just cited to mention that Schottky’s proof of PSM relied on a parameter count not completely justified at his time] ♥0
- [733] M. V. Samo[k]hin, *On some questions connected with the problem of existence of automorphic analytic functions with given modulus of boundary values*, Mat. Sb. 111 (1980); English transl.: Math. USSR Sbornik 39 (1981), 501–518. [♠ p.505 occurrence of the Ahlfors function as an example of non-constant function in H^∞ whose Gelfand transform is unity on the Šilov boundary of H^∞ , p.509: “We used an Ahlfors function to “knock down” the growth of the function...”, p.512: another occurrence of the Ahlfors function] ♥??
- [734] M. V. Samokhin, *Cauchy’s integral formula in domains of arbitrary connectivity*, Sb. Math. 191 (2000), 1215–1231. [♠ From the Abstract: An example of a simply-connected domain with boundary of infinite length is constructed such that for fairly general functionals on H^∞ no extremal function (including the Ahlfors function) can be represented as a Cauchy potential] ♥??
- [735] D. Sarason, *Representing measures for $R(X)$ and their Green’s functions*, J. Funct. Anal. 7 (1971), 359–385. [♠ some questions asked in the paper are answered in Nash 1974 [582]] ♥??
- [736] L. Sario, *A linear operator method on arbitrary Riemann surfaces*, Trans. Amer. Math. Soc. 72 (1952), 281–295. A50 [♠ perhaps first a general remark about Sario: to the best of my knowledge none of Sario’s papers (or books) works out a reproof of Ahlfors circle maps, albeit he is often gravitating around closely related or even more grandiose (i.e. foundational) paradigms. Quite ironically, much of the impulse and modernity along the Nevanlinna-Sario tradition finds its starting point in the Schwarz alternating method (which seemed outdated after Hilbert 1900 [374] “direct” resolution (=resuscitation) of the Dirichlet principle) ♠ Ahlfors 1950 [17] is cited in the bibliography yet apparently not within the text] ♥??
- [737] L. Sario, *Extremal problems and harmonic interpolation on open Riemann surfaces*, Trans. Amer. Math. Soc. 79 (1955), 362–377. A50 [♠ Ahlfors 1950 [17] is cited on p.364 as follows: “Concerning extremal problems for differentials, the reader is referred to the comprehensive study [1](=1950 [17]) by Ahlfors.” ♠ “The ultimate purpose of the present paper is to study interpolation of harmonic and analytic functions on open Riemann surfaces W . We shall, however, first take a less restricted viewpoint and consider, in general, extremal problems on Riemann surfaces.” ♠ the bulk of the paper is a reduction of a certain extremal problem over very general open Riemann surfaces to the special case of compact bordered surface (with analytic contours) via the usual exhaustion trick] ♥6
- [738] L. Sario, *Strong and weak boundary components*, J. Anal. Math. 5 (1956/57), 389–398. [♠ quoted in Reich-Warschawski 1960 [677] for another proof of Grötzsch’s extension to infinite connectivity of the Kreisbogenschlitztheorem] ♥18
- [739] L. Sario, K. Oikawa, *Capacity Functions*, Grundlehren d. math. Wiss. 149, Springer, Berlin, 1969. A47, A50, G78 [♠ Ahlfors 1950 [17] is cited at three places: pp.46, 110, 175, where this last citation come closest to our interest (but the discussion seems to be confined to plane regions W , cf. p.175 (top)). ♠ We cite the relevant extract (p.175): “Concerning the quantity c_B , Schwarz’s lemma give us the unique function minimizing $M[F]$ if W is simply connected. The problem has not been solved completely for an arbitrary region W . However, Carleson [1](=1968 [155]) established the uniqueness of the minimizing function if $c_B > 0$. For a regular region W (in which case $c_B > 0$), further results have been obtained by Ahlfors [1](=1947 [16]), [2](=1950 [17]), Garabedian [1](=1949 [276]), and Nehari [2](=1951 [592]), [3](=1952 [594]). For the function minimizing $M[F]$, they obtained a characterization which in particular implies that the function maps W onto an n -sheeted disk of radius $1/c_B$, where n is the connectivity of W ; note that this property does not in turn characterize the minimizing function. Garabedian and Nehari further derived a relationship with Szegő’s kernel function (Szegő [1](=1921 [818]), Schiffer [5](=1950 [750])). However, we shall not go into a more detailed discussion of these interesting results.”] ♥102
- [740] L. Sario, M. Nakai, *Classification Theory of Riemann Surfaces*, Grundlehren d. math. Wiss. 164, Springer, Berlin, 1970. A47, A50, G78 [♠ cite the work Ahlfors 1950 [17] in the bibliography (p.412), but not in the main body of the text (sauf

- erreur!) ♠ p.452, the article by Kusunoki 1952 [488] (where the Ahlfors map of a bordered surface is applied to the so-called “type problem”) is cited (and as far as I know this is the *unique* citation of Kusunoki’s work throughout the world literature). Alas, Kusunoki’s work does not seem to be quoted inside the main body of the text. ♠ p.332: “The concept of harmonic measure was introduced by Schwarz [1](=Ges. math. Abh. 1890) and effectively used by Beurling [1](=1935 [88]). Nevanlinna [1](=1934 [606]) coined the phrase “harmonic measure” and introduced the class of “nullbounded” surfaces characterized by the vanishing of the harmonic measure. That this class coincides with the class O_G of “parabolic” surfaces was shown by Myrberg [2](=1933 [577]) for surfaces of finite genus.” ♡??
- [741] S. Scheinberg, *Hardy spaces and boundary problems in one complex variables*, Ph.D. Thesis, Princeton University, 1963. [♠ includes a proof of the corona theorem on annuli, cf. also Stout 1965 [802]]★ ♡??
- [742] E. Schmidt, *Entwicklung willkürlicher Funktionen nach Systemen vorgeschriebener ???*, Math. Ann. 63 (1907), 433–476. [♠ quoted in Nehari 1955 [596]] ♡??
- [743] E. Schmidt, *Zur Theorie der linearen und nichtlinearen Integralgleichungen*, Math. Ann. 64 (1907), 161–174. [♠ quoted in Bergman 1950 [84]] ♡??
- [744] M. Schiffer, *Sur les domaines minima dans la théorie des transformations pseudo-conformes*, C.R. Acad. Sci. Paris 207 (1938), 112–115. [♠ quoted in Maschler 1956 [530, p.506] for the issue that minimal domains satisfy the mean value property; thus perhaps if ranges of least area maps are minimal domains we may hope that by virtue of a theorem of XXX-Schiffer (cited in the introd. of Aharonov-Shapiro 1976 [11]) the least area map is a circle map [02.08.12] ♠ also quoted in Bergman 1947 [82, p.32] for the issue that for a proof of the partial result that for starlike domains the least area map effects the Riemann mapping upon the circle]★★★ ♡??
- [745] M. Schiffer, *Sur un théorème de la représentation conforme*, C.R. Acad. Sci. Paris 207 (1938), 520–522. AS60, G78 [♠ located via Reich-Warschawski 1960 [677], who cite the paper for another proof of Grötzsch’s extension 1929–1931 [313] to infinite connectivity of the Kreisschlitzbereich mapping of Koebe 1918 [465] ♠ contains indeed a proof based upon an extremal problem of the circular slit map, yet the argument seems to depend upon the longer paper Schiffer 1937/38 [746]] ♡3
- [746] M. Schiffer, *A method of variation within the family of simple functions*, Proc. London Math. Soc. (2) 44 (1937/38), 432–449. AS60, G78 [♠ principle of areas (Flächensatz) of Bieberbach-Faber ♠ quotes Grötzsch 1930 and extends a result of Marty 1934] ♡145
- [747] M. Schiffer, *The span of multiply connected domains*, Duke Math. J. 10 (1943), 209–216. AS60, G78 ★ ♡??
- [748] M. Schiffer, *The kernel function of an orthonormal system*, Duke Math. J. 13 (1946), 529–540. G78 ★ ★★ [♠ establish for domains an identity relating the Bergman kernel to the Green’s function] ♡??
- [749] M. Schiffer, *An application of orthonormal functions in the theory of conformal mapping*, Amer. J. Math. 70 (1948), 147–156. AS60, G78 [♠ new derivation via the Bergman kernel of inequalities of Grunsky’s Thesis 1932, which were previously derived by variational methods] ♡??
- [750] M. Schiffer, *Various types of orthogonalization*, Duke Math. J. 17 (1950), 329–366. ★★★ ♡??
- [751] M. Schiffer, *Some recent developments in the theory of conformal mapping*, Appendix to R. Courant, 1950 [195], 249–324. [♠ an extremely readable survey of several trends in potential theory, including the Green-Dirichlet yoga, the kernel method and some of the allied extremal problems, plus the method of extremal length and schlicht functions] ♡??
- [752] M. Schiffer, *Variational methods in the theory of conformal mapping*, Proc. Internat. Congr. Math., Cambridge, Mass., 1950, (1952), 233–240. G78 [♠ survey of variational methods] ♡??
- [753] M. Schiffer, D.C. Spencer, *Functionals of Finite Riemann Surfaces*, Princeton Mathematical Series, Princeton University Press, 1954. [♣ [noticed the 26.07.12] on p.135 the authors consider the problem of the least-area map (normed at a point q) for a compact bordered Riemann surface ♣ it would be extremely desirable to

- know if the extremal map is a circle map, and if it relates to the Ahlfors function described in Ahlfors 1950 [17]] ♡282
- [754] M. Schiffer, *Extremum problems and variational methods in conformal mapping*, Proc. Internat. Congr. Math., Stockholm, 1958, 211–231. G78 [♠ p.229 suggest a new proof (via Fredholm) of Schottky’s famous circular mapping (i.e. Kreisnormierung): details to be found in the next voluminous paper] ♡??
- [755] M. Schiffer, *Fredholm eigenvalues of multiply connected domains*, Pacific J. Math. 9 (1959), 211–269. G78 [♠ includes a new proof (via an extremum problem involving the Fredholm determinant) of the Schottky-Koebe Kreisnormierung; for yet another proof cf. the next item [756]] ♡??
- [756] M. Schiffer, N. S. Hawley, *Connections and conformal mapping*, Acta Math. 107 (1962), 175–274. G78 [♠ p.183–189 includes yet another proof of the Schottky-Koebe Kreisnormierung (finite-connectivity) via an extremum problem of the Dirichlet type] ♡47
- [757] M. Schiffer, *Fredholm eigenvalues and conformal mapping*, Rend. Mat. e Appl. (5) 22 (1963), 447–468. G78 [♠ which mappings? the method must be the same as the previous item] ♡??
- [758] M. Schiffer, G. Springer, *Fredholm eigenvalues and conformal mapping of multiply connected domains*, J. Anal. Math. 14 (1965), 337–378. G78 ♡??
- [759] M. Schiffer, *Half-order differentials on Riemann surfaces*, J. SIAM Appl. Math. 14 (1966), 922–934. AS60, G78 [♠ summary of research joint with Hawley, ♠ immediate generalization for the Bergman kernel for any closed Riemann surface to be found in Schiffer-Spencer 1954 [753] ♠ contour integration introduced by Riemann himself] ♡4
- [760] M. Schiffman, *The Plateau problem for non-relative minima*, Ann. of Math. (2) 40 (1939), 834–854. [♠ Seidel’s summary: the problem of mapping a region bounded by a simple closed curve with a continuously turning tangent is reduced to that of minimizing a functional, somewhat similar to that of Douglas (cf. Douglas 1931 [209]). This functional has an electrostatic interpretation which may provide an effective mechanical method for the determination of conformal maps] ♡??
- [761] M. Schiffman, *Uniqueness theorems for conformal mapping of multiply connected domain*, Proc. Nat. Acad. Sci. U.S.A. 27 (1941), 137–139. G78 [♠ quoted in Bergman 1950 [84]] ♡??
- [762] A. Schönflies, *Über gewisse geradlinig begrenzte Stücke Riemann’scher Flächen*, Nachr. Akad. Wiss. Göttingen (1892), 257–267. ★ [♠ detected via AS60.]
- [763] F. Schottky, *Ueber die conforme Abbildung mehrfach zusammenhängender ebener Flächen*, (Diss. Berlin 1875) Crelle J. für die Math. 83 (1877), 300–351. AS60, G78 [♣ after Riemann 1857/58 [689], the first existence proof of the Ahlfors map in the planar case ♠ contains in germ all type of mapping like the Circle mapping, the Kreisnormierung plus the parallel-slit maps ♠ the only drawback is a certain confinement to planar regions, but this will be quickly relaxed in Klein 1882 [434] ♠ regarding the rigor of proofs, the appreciation are rather random, compare Cecioni 1908 [160] and Grunsky 1978 who ascribes the first rigorous proof of the PSM to Cecioni] ♡??
- [764] F. Schottky, *Ueber eindeutige Functionen mit linearen Transformationen in sich.* (Auszug aus einem Schreiben an Herrn F. Klein.) Math. Ann. 19 (1882), ?–?. ♡??
- [765] F. Schottky, *Ueber eindeutige Functionen mit linearen Transformationen in sich*, Math. Ann. 20 (1882), 293–300. AS60 ★ ♡??
- [766] O. Schramm, *Conformal uniformization and packings*, Israel J. Math. 93 (1996), 399–428. [♠ new proof of the Brandt-Harrington (1980 [113] and 1982 [338]) generalization of Koebe’s KNP via a topological method (mapping degree), plus the PSM (parallel slit maps) and some other gadgets] ♡??
- [767] K. Schüffler, *Zur Fredholmtheorie des Riemann-Hilbert-Operator*, Arch. Math. 47 (1986), 359–366. [♠ p.359: “Ausgehend von dem bekannten klassischen Riemann-Hilbert Randwertproblem [8,S.181 ff](=Vekua 1963 [846]) betrachten wir den Operator $RH: A^m(\Omega) \rightarrow H^{m-1/2}(\partial\Omega, \mathbb{R})$, $RH(f) := \operatorname{Re}(\lambda f)|_{\partial\Omega}$. [...] das Symbol “ A^m ” bezeichne den Sobolevraum $H^{m,2}$ der auf Ω holomorphen Funktionen, $m \geq 2$; die komplexwertige Funktion λ sei nullstellenfrei (auf $\partial\Omega$) und o. E. glatt.— Es ist bekannt, daß der Operator RH für glattberandete, endliche Riemannsche Flächen ein Fredholmoperator ist. Sien Index hängt sowohl von der Topologie von

- Ω (Anzahl der Randkomponenten und Geschlecht) als vom “geometrischen Index, dem Argumentzuwachs $\kappa(\lambda) = \Delta \arg(\lambda)/2\pi \in \mathbb{Z}$ von λ beim positiven Durchlaufen von $\partial\Omega$ ab (siehe [8, S. 189]=Vekua 1963 [846])” ♠ [17.10.12] this seems connected to the Ahlfors map, by taking λ its boundary restriction] ♡2
- [768] H. A. Schwarz, *Ueber einige Abbildungsaufgaben*, Crelle J. für die Math. 70 (1869), 105–120. [♠ introduces the principle of symmetry ♣ solves special case of the RMT by hand] ♡??
- [769] H. A. Schwarz, *Zur Theorie der Abbildung*, Züricher Vierteljahrsschrift (1869/70); also (theilweise umgearbeitet ca. 1890) in Ges. Abh. II, 108–132. ♡??
- [770] H. A. Schwarz, *Ueber die Integration der partiellen Differentialgleichung $\frac{\partial^2 u}{\partial x^2} + \frac{\partial^2 u}{\partial y^2} = 0$ für die Fläche eines Kreises*, Züricher Vierteljahrsschrift (1870), 113–128; reprinted (or rather integrated) in the longer paper Schwarz 1872 [773]. [♠ this entry is the first rigorous solution to the Dirichlet problem to have appeared in print (for the very special case of the disc) and via usage of the Poisson integral (occurring in several publications dated 1820–23–27–29–31–35) ♠ see also Prym 1871 [664] for an essentially simultaneous resolution (which however turned out to have less impact on the future events)] ♡??
- [771] H. A. Schwarz, *Ueber einen Grenzübergang durch alternirendes Verfahren*, Züricher Vierteljahrsschrift (1870), 272–286; also in Ges. Abh. II, 133–143. ♡??
- [772] H. A. Schwarz, *Ueber die Integration der partiellen Differentialgleichung $\frac{\partial^2 u}{\partial x^2} + \frac{\partial^2 u}{\partial y^2} = 0$ unter vorgeschriebenen Grenz- und Unstetigkeitsbedingungen*, Berliner Monatsb. (1870), 767–795; or Ges. Abh. Bd. II, 144–171 [♠ p. 167–170 uniqueness of the conformal structure on the 2-sphere] ♡??
- [773] H. A. Schwarz, *Zur Integration der partiellen Differentialgleichung $\frac{\partial^2 u}{\partial x^2} + \frac{\partial^2 u}{\partial y^2} = 0$* , Crelle J. für die Math. 74 (1872), 218–253; or Ges. Abh. II, 175–210.
- [774] A. Sebbar, Th. Falliero, *Equilibrium points of Green’s function for the annulus and Eisenstein series*, Proc. Amer. Math. Soc. 135 (2007), 313–328. [♠ p. 314: “By the classical Hopf’s lemma, the normal derivative of the Green’s function is positive on the boundary [of a multi-connected domain], and one may ask if there is a compact set [in the domain], independent of the pole, containing all the equilibrium points of the Green’s function.” ♠ a positive answer to this problem is supplied by Solynin 2007 [794]] ♡4
- [775] B. Segre, *Sui moduli delle curve poligonali, e sopra un complemento al teorema di esistenza di Riemann*, Math. Ann. 100 (1928), 537–551. ♡??
- [776] W. Seidel, *Bibliography of numerical methods in conformal mapping*. In: *Construction and Applications of Conformal Maps*, Proc. of a Sympos. held on June 22–25 1949, Applied Math. Series 18, 1952, 269–280. [♠ a useful compilation of (old) conformal maps literature emphasizing the numerical methods, and out of which we borrowed several summaries] ♡??
- [777] H. L. Selberg, *Ein Satz über beschränkte endlichvieldeutige analytische Funktionen*, Comment. Math. Helv. 9 (1937), 104–108. [♠ quoted in Hayashi-Nakai 1988]★★★[CHECK] ♡??
- [778] M. Seppälä, *Teichmüller spaces of Klein surfaces*, Ann. Acad. Sci. Fenn. Ser. A I Math. Dissertationes 15 (1978), 1–37. [♠] ♡??
- [779] M. Seppälä, R. Silhol, *Moduli spaces for real algebraic curves and real abelian varieties*, Math. Z. ?? (1989), ??–??. [♠ modernization of Klein’s resp. Comessatti’s theories] ♡45
- [780] F. Severi, *Vorlesungen über algebraische Geometrie*, Leipzig, Teubner, 1921. [♠ p. 159 re-proves the upper bound for the gonality of a complex curve (according to Segre 1928 [775]), but for the “modern standards” the first accepted proof is that of Meis 1960 [541]] ♡??
- [781] F. Severi, *Sul teorema di esistenza di Riemann*, Rend. Circ. Mat. Palermo 46 (1922), 105–116. ♡??
- [782] G. B. Shabat, V. A. Voevodsky, *Equilateral triangulations of Riemann surfaces and curves over algebraic number fields*, Doklady SSSR 304 (1989), 265–268; Soviet Math. Dokl. 39 (1989), 38–41. [♠ geometric translation of Belyi-Grothendieck’s theorem that a curve is defined over $\overline{\mathbb{Q}}$ iff it ramifies only over 3 points of the sphere. Question: can one extend this to Ahlfors maps in the bordered case cf.

Section 19.12 for a pessimist answer, yet probably all real curves are to be integrated. So what about real Riemann surfaces with an equilateral triangulation invariant under complex conjugation. So the vertices occurs as \mathbb{Q} -ratioanl points? etc.]★ ♡??

- [783] G. B. Shabat, V. A. Voevodsky, *Drawing curves over number fields*, in: Grothendieck Festschrift, Birkhäuser. ♡??
- [784] G. E. Shilov, *On rings of functions with uniform convergence*, Ukrain. Mat. Ž. 3 (1951), 404–411. [♠]★ ♡??
- [785] R. J. Sibner, *Uniformization of symmetric Riemann surfaces by Schottky groups*, (Diss.) Trans. Amer. Math. Soc. 116 (1965), 79–85. G78 [♣ new proofs of the Rückkehrstheorem (retrosection theorem) and the Kreisnormierung=KNP via quasiconformal mappings techniques (Ahlfors-Bers)=Teichmüller modernized] ♡??
- [786] R. J. Sibner, *Remarks on the Koebe Kreisnormierungsproblem*, Comment. Math. Helv. 43 (1968), 289–295. G78 [♣ quasiconformal reduction of KNP: can every plane domain be deformed quasiconformally onto a circle domain? (still open today June 2012)] ♡??
- [787] R. J. Sibner, *An elementary proof of a theorem concerning infinitely connected domains*, Proc. Amer. Math. Soc. 37 (1973), 459–461. G78 [♠ simplifies by circumventing the usage of quasi-conformal techniques (normal family proof instead) an earlier proof of the fact that any domain of infinite connectivity admits a conformally equivalent model bounded by analytic contours (Jordan curves) ♠ as probably just a matter of nomenclature it is not perfectly clear (to the writer) if this is obtained for all domains (as stated e.g. in Grunsky’s review (1978) [322, p.196] of this work) or if the assertion is only established in the case of countably many boundary components (cf. the parenthetical proviso on p.459 of *opera cit.*) ♠ of course the real dream of Koebe (Kreisnormierung) would be that all these Jordan contours are ultimately circles!] ♡??
- [788] L. Siebenmann, *The Osgood-Schoenflies theorem revisited*, Russian Math. Surveys 60 (2005), 645–672. See also the online version available in the Hopf archive: <http://hopf.math.purdue.edu/cgi-bin/generate?/Siebenmann/Schoen-02Sept2005> (from which a number of the editors misprints have been removed.)[♠ contains a brilliant historical discussion of the contribution due to the complex analytic community (Osgood, Carathéodory) upon the the so-called Schoenflies theorem about the bounding disc property of plane Jordan curves] ♡16
- [789] J.-C. Sikorav, *Proof that every torus with one hole can be properly holomorphically embedded in \mathbb{C}^2* , preprint, October 1997 (unpublished). [♠ self-explanatory title, and see Černe-Forstnerič for an extension of Sikorav’s result]★ ♡??
- [790] R. R. Simha, *The Carathéodory metric of the annulus*, Proc. Amer. Math. Soc. 50 (1975), 162–166. A50, G78 [♠ write down everything (Ahlfors function, Cathéodory metric) in the case of an annulus] ♡13
- [791] S. O. Sinanjan, *Approximation by polynomials in the mean with respect to area*, Mat. Sbornik 82 (1970); English transl.: Math USSR Sbornik 11 (1970), 411–421. [♠ p.416: “Let $\phi(z)$ be an Ahlfors p -function of the set E : $\gamma_p(E, \phi) = \gamma_p(E)$, $\phi \in A_E^p$. Such a function exists due to the compactness of the set A_E^p .” ♠ p.420 one further occurrence of the Ahlfors function] ♡??
- [792] V. Singh, *An integral equation associated with the Szegő kernel function*, Proc. London Math. Soc. (3) 10 (1960), 376–394. G78 [♠]★★★ ♡??
- [793] E. P. Smith, *The Garabedian function of an arbitrary compact set*, Pacific J. Math. 51 (1974), 289–300. G78 [♠ Ahlfors function is mentioned in its usual connection with the analytic capacity (p.289, 290) ♠ Gamelin’s summary in 1973 [266]: “Recently E. Smith [43](=the present entry Smith 1974 [793]) settled a problem left open by S. Ya. Havinson [26](=Havinson 1961/64 [345]), proving that if domains D_n with analytic boundaries increase to an arbitrary domain D , then the Garabedian functions of the D_n converge normally. The limiting function depends only on D and on the point z_0 , and it is accordingly called the Garabedian function of D . In order to study the subadditivity problem for analytic capacity, Smith had been led to investigate the dependence of the Szegő kernel on certain perturbations of domains with analytic boundaries. The result on the Garabedian function dropped out as a special dividend. There is now the problem of simplifying Smith’s proof, and of freeing the result from Hilbert space considerations, in order

to extend the theorem to more general extremal problems. ADDED IN PROOF. A simple proof, which still depends on Hilbert space considerations, has been given by N. Suita 1973 (= [814])” ♡??

- [794] A. Yu. Solynin, *A note on equilibrium points of Green function*, Proc. Amer. Math. Soc. 136 (2008), 1019–1021. [♠ given a finitely connected planar domain, it is shown that there is a “universal” compactum (inside the domain) containing all critical points of the Green’s functions $G(z, t)$ whatever the location of the pole t is (answering thereby a question of Sebbar-Falliero 2007 [774]) ♣ question (Gabard [11.08.12]): does this fantastic result extends to (compact) bordered surfaces ♠ further there must be a minimum Solynin’s compactum K , what can be said about its shape, area, etc. ♠ considering the example of a ring (annulus, say circular to simplify) it seems evident that upon dragging the pole around the hole the unique critical point of Green will rotate (being roughly located at the “antipode”), thus it seems that Solynin’s compactum will be a sub-annulus in this case ♠ maybe in general the inclusion of K into the domain is a homotopy equivalence] ♡??
- [795] A. Speiser, *Über symmetrische analytische Funktionen*, Comment. Math. Helv. 16 (1944), 105–114. AS60 [♠ not symmetric in the “reality” sense of Felix Klein, so a priori no link with Ahlfors 1950 [17]] ♡??
- [796] G. Springer, *Introduction to Riemann surfaces*, Addison-Wesley, Reading, MA, 1957. [♠ contains a discussion of the Schottky double, the Prüfer surface, etc.] ♡??
- [797] Ch. M. Stanton, *The closed ideals in a function algebra*, Trans. Amer. Math. Soc. 154 (1971), 289–300. A50 [♠ a clear-cut application of the Ahlfors function (mapping) is given to a “bordered surface” extension of a “disc result” of Beurling (unpublished)—Rudin (1957) (telling that—in the function algebra $A(W)$ of functions analytic in the interior and continuous up to the boundary—*every closed ideal is the closure of a principal ideal*) ♠ this extension was actually first derived by Voichick 1964 [857], via the more complicated universal covering whose uniformizing map presents rather complicated boundary behavior ♠ p.293, as Royden’s student, the author points out that Ahlfors result is re-proved in Royden 1962 [716] (this is not an isolated attitude, cf. Section 22.2 for an exhaustive list) ♠ p.289, the author remarks that similar use of Ahlfors’ theorem was initiated by Alling 1965 [35] and Stout (in the corona realm) ♠ naive question of the writer [08.08.12]: is it reasonable to expect that the same Ahlfors-Alling lifting procedure conducts to an extension of Fatou’s theorem about existence of radial limits a.e. from the disc to a bordered surface: the notion of radiality is simple to define (orthogonality to the boundary), yet a function on the bordered surface does not descend to one on the disc via the Ahlfors branched covering (thus rather a method of localization is required, and the problem is surely well treated by several authors (e.g. Heins, Voichick 1964, Gamelin (localization of the corona), etc.) UPDATE [12.09.12]: see also Alling 1966 [36, p.345], who claims that Fatou is trivial to extend upon appealing to the Ahlfors map ♠ [08.08.12] in the same vein it should be noted that the Ahlfors function shows some weakness for instance in the problem of solving the Dirichlet problem which in the disc-case can be cracked via the Poisson formula (H. A. Schwarz’s coinage) and one could hope to lift the solution to the bordered surface via the Ahlfors map. Alas, for given boundary values along the contours of the bordered surface there is no naturally defined procedure to descend the data along the boundary of the disc (implying a failure of the naive lifting trick). Consequently, the Dirichlet problem (for a bordered surface) lies somewhat deeper than the Ahlfors function, since it is probably well-known that the Ahlfors function may be derived from Dirichlet (or its close avatar the Green’s functions), see our Section 19 where we shall attempt to redirect to the first-hand sources implementations (Grunsky (planar case), Ahlfors, maybe Cecioni’s students, and Heins 1950 [358]).] ♡5
- [798] Ch. M. Stanton, *Bounded analytic functions on a class of open Riemann surfaces*, Pacific J. Math. 59 (1975), 557–565. [♠ p.559 uses the terminology Myrberg surface for a concept closely allied to the Ahlfors function in the sense of our circle maps] ♡??
- [799] K. Stein, *Topics on holomorphic correspondences*, Rocky Mountain J. Math. 2 (1972), 443–463. [♠ Ahlfors 1950 [17] is cited on p.457: “By a theorem of Ahlfors [1](=1950 [17]) there is always a meromorphic function $\varphi: \widehat{R}_0 \rightarrow \overline{\mathbb{C}}$ [from the double of a bordered surface to the sphere] such that $R_0 = \{\xi \in \widehat{R}_0 : |\varphi(\xi)| < 1\}$; hence R_0 is a distinguished polyhedral domain in \widehat{R}_0 .”] ♡20

- [800] S. Stoilow, *Leçons sur les principes topologiques de la théorie des fonctions analytiques*, Gauthier-Villars, Paris 1938. (Second edition in 1956.; Russian translation 1964.) [♠ includes in particular a notion of “total Riemann covering”, defined by asking that any sequence tending to the boundary has an image tending to the boundary. This topological behaviour subsumes of course those of Ahlfors circle maps. ♠ of course Stoilow’s concept is also implicit in Radó 1922 [665], as one sees e.g. from Landau-Osserman’s account (1960 [493]) ♠ from Grunsky’s Review (JFM): “in die Definition der Mannigfaltigkeit wird dabei kein Abzählbarkeitsaxiom aufgenommen; es folgt der Beweis des Brouwerschen Satzes von der Invarianz des inneren Punktes nach *Lebesgue-Sperner*. [...] Zur Verdeutlichung dienen Beispiele nicht orientierbarer Fläche sowie ein von *Prüfer* stammendes Beispiel einer nicht triangulieren zweidimensionalen Mannigfaltigkeit (in der Formel Zeile 11 v. u. S. 72 findet sich ein störender Druckfehler: [...]).” ♠ In fact most relevant to our purpose (of the Ahlfors map) is Chap. VI of the book, which Grunsky (loc. cit.) summarizes as follows: “Ferner werden innere Abbildungen einer Riemannschen Fläche R auf eine andere, S , betrachtet. Eine solche heißt eine totale Überdeckung von S durch R , wenn jede Punktfolge aus R , die keine kompakte Teilfolge enthält (die “gegen den Rand strebt”) in eine ebensolche übergeht. Die Überdeckung ist dann auch vollständig, d. h. *jeder* Punkt von S wird überdeckt, und außerdem auch jeder gleich oft.” ♡??
- [801] S. Stoilow, *Einiges über topologische Funktionentheorie auf nicht orientierbaren Flächen*, Rev. Roumaine Math. Pures Appl. 19 (1974), 503–506. [♠] ♡??
- [802] E. L. Stout, *Bounded holomorphic functions on finite Riemann surfaces*, Trans. Amer. Math. Soc. 120 (1965), 255–285. A50 [♠ on p. 263 (and 272), Ahlfors 1950 [17] is quoted as follows (without precise bound): “In order to establish our result, we shall need to make use of a result of Ahlfors [1](=Ahlfors 1950 [17]). For an alternative proof, one may consult Royden [15](=Royden 1962 [716]). Theorem 3.1 *There exists a function P holomorphic on a neighborhood of \bar{R} which maps R onto the open unit disc in an one-to-one manner for some n and which satisfies $|P| = 1$ on ∂R .* ♠ first it is evident that “one-to-one” is a misprint that should be read as “ n -to-one” ♠ the paper addresses primarily the corona problem (overlapping with Alling 1964 [34]) and the allied interpolation, notably an extension of the celebrated results of Carleson and Newman on interpolation sets for the disc (i.e. those subsets enjoying the property that every bounded complex-valued function on E can be extended to a bounded analytic function on the disc)] ♡37
- [803] E. L. Stout, *On some algebras of analytic functions on finite open Riemann surfaces*, Math. Z. 92 (1966), 366–379; with Corrections in: Math. Z. 95 (1967), 403–404. A50 [♠ cite Ahlfors 1950 [17] twice, on p. 366: “Let R be a finite open Riemann surface whose boundary Γ consists of N analytic, pairwise disjoint, simple closed curves. Let η be an analytic mapping from R onto U , the open unit disc which is holomorphic on a neighborhood of \bar{R} and which is of modulus one on Γ . That such functions exists was first established by Ahlfors [1](=Ahlfors 1950 [17]); another proof of their existence is in the paper [12](=Royden 1962 [716]).” Then on p. 375: “Ahlfors [1] has shown that if z_0, z_1 are distinct points of R (neither in Γ), then any solution of the extremal problem $\sup\{|f(z_0)| : f \text{ in } H_\infty[R], f(z_1) = 0, \|f\| \leq 1\}$ is an inner function in $A[R]$. Thus inner functions separate points on R” ♠ quoted by Fedorov, for using “inner function” as a synonym of “circle map”] ♡23
- [804] E. L. Stout, *Interpolation on finite open Riemann surfaces*, Proc. Amer. Math. Soc. 18 (1967), 274–278. A50 [♠ p. 274, Ahlfors 1950 is quoted as follows: “It is convenient to make use of an *Ahlfors map* for R , i.e., a function continuous on \bar{R} and holomorphic in R which is constantly of modulus one on Γ . The existence of such function was established by Ahlfors in [1](=Ahlfors 1950 [17]); an alternative proof of their existence is in [4](=Royden 1962 [716])” ♠ The Ahlfors map (and the machinery of uniformization) are again utilized to lift the characterization of interpolating sets for the disc (available from the celebrated results of Carleson, Newman, cf. also Hoffman 1962 [381]). The main theorem states that a subset $E \subset R$ of a finite open Riemann surface is an interpolating set for R iff $\inf_{z \in E} d_R(z, E) > 0$, where $d_R(z, E) := \sup\{|f(z)| : f \in H_\infty(R), f|_{E-\{z\}} = 0, \|f\|_R \leq 1\}$. For convenience, recall that the subset E is called an interpolation set for R if every bounded complex-valued function on E can be extended to a bounded analytic function on R .] ♡2

- [805] E. L. Stout, *Inner functions, doubles and special analytic polyhedra*, Amer. J. Math. 94 (1972), 343–365. A50 [♠ p. 345 credits Heins 1950 [358] for another (beside Ahlfors’s 1950 [17]) elegant [sic] construction of inner functions on compact bordered surfaces] ♥0!
- [806] E. Study, W. Blaschke, *Vorlesungen über ausgewählten Gegenstände der Geometrie*, vol. 2, Konforme Abbildung einfach zusammenhängender Bereiche, Teubner, Leipzig, 1912. [♠ closely related to Carathéodory’s seminal study of the boundary behaviour of the Riemann map along an arbitrary Jordan curve and the more general theory of prime ends] ♥??
- [807] A. Stray, *Approximation by analytic functions which are uniformly continuous on a subset of their domain of definition*, Amer. J. Math. 99 (1977), 787–800. [♠ p. 797 brief apparition of the Ahlfors function via cross-reference to Gamelin 1969 [263]] ♥0
- [808] K. Strebel, *Über das Kreisnormierungsproblem der konformen Abbildung*, Ann. Acad. Sci. Fenn. Ser. A. I. 101 (1951), 22 pp. A560, G78 [◇ Kurt Strebel is a student of R. Nevanlinna (who taught frequently in Zürich)] ★ ♥??
- [809] K. Strebel, *Über die konforme Abbildung von Gebieten unendlich hohen Zusammenhangs, (I. Teil)*, Comment. Math. Helv. 27 (1952), 101–127 G78 [♣ partial results on the Kreisnormierung in infinite connectivity] ♥??
- [810] K. Strebel, *Ein Klassifizierungsproblem für Riemannsche Fläche vom Geschlecht 1*, Arch. Math. 48 (1987), 77–81. [♣ p. 77: “Herr K. Schöffler benötigt in seiner Arbeit [2] zur Theorie der Minimalflächen vom Geschlecht 1 den Satz, daß jeder p -fach gelochte Torus auf einen ebensolchen mit kreisförmigen Löchern konform abgebildet werden kann, und daß eine solche Abbildung durch diese geometrische Forderung im wesentlichen eindeutig bestimmt ist. Dabei wird der Torus durch die komplexe Ebene \mathbb{C} modulo einer Translationsgruppe dargestellt, und die Kreisförmigkeit der Löcher ist ebenfalls in \mathbb{C} gemeint.” ♠ [17.10.12] one naturally wonders about higher genres than one (where one must probably interpret the Kreisförmigkeit within the hyperbolic plane/disc), and it seems that such positive genus instances of the Kreisnormierung are also handled in Haas 1984 [329]] ♥7
- [811] T. Sugawa, *Unified approach to conformally invariant metrics on Riemann surfaces*, Proc. of the Second ISAAC Congress, Vol. 2 (Fukuoka, 1999), 1117–1127, Int. Soc. Anal. Appl. Comput., 8, Kluwer Acad. Publ., Dordrecht, 2000. [♠ the Ahlfors function is mentioned on p. 5: “The quantity $c_R(p)$ is sometimes called the analytic capacity. An extremal function $f: R \rightarrow \mathbb{D}$ satisfying $|df|(p) = c_R(p)$ is usually called the *Ahlfors function* at p and known to be unique up to unimodular constants (see [4](=Fisher 1983 [241])). We remark that the condition $c_R(p) = 0$ at some point p need not imply that $c_R(p) = 0$ at every point p in the case that R is non-planar. A counterexample was constructed by Virtanen [13](=Virtanen 1952 [852]) (see also [10,X. 2K]=Sario-Oikawa 1969 [739]).” ♠ the article as whole present an unified framework to the interplay between conformally invariant metrics and extremal problems emphasizing the contractive property of holomorphic maps (à la Schwarz-Pick-Ahlfors) ♠ more precisely several metrics are presented culminating to their comparison as

$$a \leq s \stackrel{\text{AB50S69}}{\leq} c \leq \left\{ \begin{array}{l} \leq r \stackrel{\text{Bu79}}{\leq} k \\ \leq b \leq q \end{array} \right\} \leq h,$$

where a stands for Ahlfors-Beurling 1950 [18], s for span (or Schiffer!), c for Carathéodory(-Reiffen) (or for analytic capacity), r for Robin (or logarithmic capacity), k for Kobayashi, b for Bergman, q for quadratic differentials (Grötzsch-Teichmüller!), h for Hahn ♠ the inequality AB50S69 is due to Ahlfors-Beurling 1950 [18] for the planar case and in general to Sakai 1969/70 [731] ♠ inequality Bu79 is due to Burbea 1979 [126] ♠ inequality HeSu72 is due to Hejhal 1972 [366, p. 106] (case of finite bordered surface) and Suita 1972 [813] in general] ♥??

- [812] T. Sugawa, *An explicit bound for uniform perfectness of the Julia sets of rational maps*, Math. Z. 238 (2001), 317–333. [♠ the Ahlfors map is briefly mentioned as follows: “In fact, for a finitely connected planar domain U whose boundary consists of Jordan curves, it is known that there exists a branched holomorphic covering map from U onto the unit disk (e.g. the Ahlfors map). Thus L_U cannot be estimated from below by only the data of W (in this case $L_W = +\infty$).”] ♥2

- [813] N. Suita, *Capacities and kernels on Riemann surfaces*, Arch. Rat. Mech. Anal. 46 (1972), 212–217. [♠] ♥??
- [814] N. Suita, *On a metric induced by analytic capacity*, Kodai Math. Sem. Report 25 (1973), 215–218. G78 [♠ Ahlfors function à la Havinson 1961/64 [345], i.e. for domains $D \notin O_{AB}$ (i.e. supporting nonconstant bounded analytic functions), analytic capacity and conformal metrics ♠ the metric in question is also known as the Carathéodory metric (cf. e.g., Grunsky 1940 [317])] ♥17
- [815] N. Suita, *On a class of analytic functions*, Proc. Amer. Math. Soc. 43 (1974), 249–250. G78 [♠ p. 249, the Ahlfors function is discussed as follows: “If $\Omega \notin O_{AB}$ [i.e. Ω is a plane region having a nonconstant bounded analytic function], there exist the extremal functions $A(z)$ which maximize $|f'(z_0)|$ in \mathfrak{B}_0 [the class of analytic functions f such that $f(z_0) = 0$ and $|f(z)| \leq 1$]. Those functions are called the *Ahlfors functions* which are unique save for rotations [3](=Havinson 1961/64 [345]).” ♠ the note includes a counterexample to an (erroneous) claim made by Ahlfors-Beurling 1950 [18] about the compactness of the class \mathfrak{E}_0 of those analytic functions in a plane region $\Omega \notin O_{AB}$ vanishing at $z_0 \in \Omega$ and such that $1/f$ omits a set of values of area $\geq \pi$] ♥??
- [816] N. Suita, *On a metric induced by analytic capacity, II*, Kodai Math. Sem. Report 27 (1976), 159–162. A47 [♠ the Ahlfors function appears on p. 160 and 161 ♠ for a plane region $\Omega \notin O_{AB}$ (i.e. supporting nonconstant bounded analytic functions) it was known (Suita 1973 [814] via “making use of a supporting metric due to Ahlfors 1938”) that the curvature $\kappa(\zeta)$ of the metric $ds_B = c_B(\zeta)|d\zeta|$ induced by analytic capacity $c_B(\zeta) = \sup |f'(\zeta)|$ in the class of functions bounded-by-one (=stretching factor of the Ahlfors function at ζ) is ≤ -4 ♠ the present article rederives this estimate ($\kappa \leq -4$) by a limiting/exhaustion argument reducing to the case of a regularly bounded finitely connected domain which is analyzed via Bergman’s method of minimal integrals, but making also extensive use of Garabedian’s sharp analysis (our opinion!) ♠ the novelty of the present article is that the ‘Bergman-Garabedian method’ gives the “more precise estimation $\kappa(\zeta) < -4$ ” for regions with more than one contour ♠ paraphrase (p. 161): “the equality $\kappa(\zeta) = -4$ at one point $\zeta \in \Omega$ implies that Ω is conformally equivalent to the unit disc.” ♠ [23.09.12] maybe it would be worth looking if Suita’s work extends to finite bordered surfaces (the problem being that quantity $|f'(\zeta)|$ depends on a local uniformizer), yet it seems that the theory is extensible (cf. e.g. Sugawa 1999/00 [811])] ♥??
- [817] N. Suita, A. Yamada, *On the Lu Qi-keng conjecture*, Proc. Amer. Math. Soc. 59 (1976), 222–224. [♠ “We shall give a complete answer to the Lu Qi-keng conjecture for finite Riemann surfaces. Our result is that every finite Riemann surface which is not simply-connected is never a Lu Qi-keng domain, i.e. the Bergman kernel $K(z, t)$ of it has zeros for suitable t ’s.”] ♥28
- [818] G. Szegő, *Über orthogonale Polynome, die zu einer gegebenen Kurve der komplexen Ebene gehören*, Math. Z. 9 (1921), 218–270 G78 [♠ Szegő kernel representation of the Riemann mapping (p. 245) ♠ like Bergmann 1922 [75] or Bochner 1922 [107] it is confessed (p. 249) that the method does not duplicate a new existence proof of the Riemann mapping (this had to wait upon Garabedian and Lehto 1949 [500]) ♠ what is the geometric interpretation (i.e. the allied extremal problem): answer of course it is just that of minimizing the integral $\int_C |f(z)|^2 ds$, where integration is taken along the contour C of the domain (and ds is its Bogenelement)] ♥high?
- [819] G. Szegő, *Über die Randwerte einer analytischer Funktion*, Math. Ann. 84 (1921), 232–244 [♠] ♥??
- [820] G. Szegő, *Verallgemeinerung des ersten Bieberbachschen Flächensatzes auf mehrfach zusammenhängende Gebiete*, Sitz.-Ber. Preuß. Akad. d. Wiss., math.-phys. Kl. (1928), 477–481 G78 [♠ can we do the same on a Riemann surface? and relate this to a Bergman-style proof of the Ahlfors map?] ★★★ ♥??
- [821] J. Tagamlizki, *Zum allgemeinen Kreisnormierungsprinzip der konformen Abbildung*, Ber. Verhandl. Sächs. Akad. Wiss., math.-phys. Kl. 95 (1943), 111–132. G78 ★ ♥??
- [822] M. Taniguchi, *Bell’s result on, and representations of finitely connected planar domains*, Some Japanese fonts 1352 (2004), 47–53. [♠ survey of several results of Bell on the Ahlfors function and concludes by some questions about Bell representations, i.e. a certain family of canonical domains admitting an evident proper holomorphic map to the disc] ★ ♥??

- [823] T. J. Tegtmeier, A. D. Thomas, *The Ahlfors map and Szegő kernel for an annulus*, Rocky Mountain J. Math. 29 (1999), 709–723. [♠ contains some lovely pictures of Ahlfors function in the case of an annulus] ♡??
- [824] O. Teichmüller, *Eine Verschärfung des Dreikreisesatzes*, Deutsche Math. 4 (1939), 16–22. G78 [♠ quoted (joint with Carlson 1938 [157]) in Grunsky 1940 [317] as a forerunner of the extremal problem for bounded analytic functions ◇ Oswald Teichmüller (1913–1943) is formally a student of Hasse, but his interest shifted to function theory (presumably due to lectures held in Göttingen ca. 1935 by R. Nevanlinna) and then joined ca. 1937 Berlin where Bieberbach was located] ♡??
- [825] O. Teichmüller, *Extremale quasikonforme Abbildungen und quadratische Differentialformale*, Abh. Preuß. Akad. Wiss. math.-naturw. Kl. 22 (1939), 1–197; also in the Collected Papers, 335–531. AS60, G78 [♠ discusses in details the Klein dictionary between symmetric surfaces and bordered Riemann surfaces through the *Verdoppelung* (=Schottky-Klein double) ♠ discusses moduli in a way quite anticipated in Klein 1882 [434], modulo of course the usual Riemann-style heuristics] ♡193
- [826] O. Teichmüller, *Über Extremalprobleme der konformen Geometrie*, Deutsche Math. 6 (1941), 50–77; also in Collected Papers, 554–581. AS60, G78 [♣ a mention is made (without proof and a cryptical unreferenced allusion to Klein) of a statement which could be interpreted as a forerunner of the Ahlfors map ♠ despite long search the writer (Gabard) was not able to follow conclusively this path, compare Section 7.1 for more tergiversation(s) ♠ the original Teichmüller text reads as follows (p.554–5): “Wir beschäftigen uns nur mit **orientierten endlichen Riemannschen Mannigfaltigkeiten**. Diese können als Gebiete auf geschlossenen orientierten Riemannschen Flächen erklärt werden, die von endlich vielen geschlossenen, stückweise analytischen Kurven begrenzt werden. Sie sind entweder geschlossen, also selbst geschlossene orientierte Riemannsche Flächen, die man sich endlichvielblättrig über eine z -Kugel ausgebreitet vorstellen darf, oder berandet. Im letzteren Falle, kann man sie nach Klein³⁹ durch konforme Abbildung auf folgende Normalform bringen: ein endlichvielblättriges Flächenstück über der oberen z -Halbebene mit endlich vielen Windungspunkten, das durch Spiegelung an der reellen Achse eine symmetrische geschlossene Riemannsche Fläche ergibt; [...] —(So läßt sich z. B. jedes Ringgebiet, d. h. jede schlichtartige endliche Riemannsche Mannigfaltigkeit mit zwei Randkurven, konform auf eine zweiblättrige Überlagerung der oberen Halbebene mit zwei Verzweigungspunkte abbilden.)”] ♡??
- [827] O. Teichmüller, *Gesammelte Abhandlungen, Collected Papers*, Herausgegeben von L. V. Ahlfors und F. W. Gehring, Springer Verlag, Berlin, 1982. ♡??
- [828] W. Thomson (later Lord Kelvin), *Sur une équation aux différences partielles qui se présente dans plusieurs questions de physique mathématique*, J. Math. Pures Appl. 12 (1847), 493–496. [♠ one of the early apparition of the Dirichlet principle, cf. also Green 1928 [302], Gauss 1839 [287], Kirchhoff 1850 [426], Riemann 1851–57–57 [686, 687, 688] and Dirichlet as edited by Grube 1876 [208]] ♡??
- [829] W. Thurston, *The geometry and topology of 3-manifolds*, Princeton University Notes, Princeton, N. J., 1979. [♠ circle packing theorem, cf. precise citations e.g. in He 1990 [352], i.e. especially Corollary 13.6.2 and Theorem 13.7.1 (circle packing theorem)] ♡high 800?
- [830] H. Tietz, *Eine Normalform berandeter Riemannscher Flächen*, Math. Ann. 129 (1955), 44–49. A50, AS60, G78 [♣ cite Ahlfors 1950 [17] and Nehari 1950 [591], then criticizes the arguments of the latter ♣ seems to reprove a sort of circle map for bordered surfaces inspired by Ahlfors (but with the desideratum of schlichtness along the boundary), alas Tietz’s argument is criticized (and apparently destroyed) in Köditz-Timmann 1975 [470] ♠ Grunsky 1978 [322, p. 198] also seems to approve the Köditz-Timmann critique for he cites the (present) paper Tietz 1955 [830], but right after add the parenthetical proviso “(cf. [266])”, that is Köditz-Timmann ♠ despite those defects the prose of the introduction is brilliant and worth quoting (especially as it emphasizes the historical role of

³⁹Big challenge: find where? Possibly this is not to be found in Klein and Teichmüller (probably lacking a good library during the war time) loosely extrapolated slightly what he remembered from his Klein reading. Another little puzzle would be to know if this text had a little influence over Ahlfors subsequent findings. Maybe yet it should in no case discredit the originality of Ahlfors achievement which looks substantially sharper especially since a control on the degree of the map is given.

Ahlfors 1950 [17], note however that Tietz seems to neglect both the Italian works as well as the cryptical allusion in Teichmüller 1941 [826]): “Die Existenz eindeutiger analytischer Funktionen auf Riemannschen Flächen⁴⁰ bedeutet, daß jede Klasse konformäquivalenter Riemannscher Flächen “realisiert” werden kann durch Überlagerungsflächen der Zahlenebene. Damit stellt sich die Frage nach besonders einfachen Realisierungen oder Normalformen⁴¹.—Das wichtigste Ergebnis zu dieser Frage ist der Riemannsche Abbildungssatz, der sie für einfach-zusammenhängende Riemannsche Flächen beantwortet⁴². Einen Schritt weiter gehen die Schlitztheoreme, die von den topologischen Voraussetzungen des Riemannschen Abbildungssatzes nur die Schlichtartigkeit der Riemannschen Fläche beibehalten. Hierher gehört auch der Satz, daß jede berandete schlichtartige Riemannsche Fläche einem mehrfach überdeckten Kreis mit geeigneten Verzweigungsschnitten, die den Rand nicht treffen, konformäquivalent ist⁴³.—Die Frage nach kanonischen Riemannschen Flächen im Falle höheren Geschlechtes ist erst in letzter Zeit von Herrn AHLFORS [1](=1950 [17]) angeschnitten und von Herrn NEHARI [2](=1950 [591]) systematisch behandelt worden:—Herr AHLFORS zeigt, daß jede berandete Riemannsche Fläche realisiert werden kann als mehrfach überdeckter Einheitskreis, während Herr NEHARI die Schlitztheoreme auf diesen Fall überträgt⁴⁴. [...]—Es erscheint wünschenswert, eine Normalform für berandete Riemannschen Flächen zu besitzen, die—im Gegensatz zur AHLFORSschen—sicherstellt, daß das Bild jeder einzelnen Randkurve schlicht über die Linie des Einheitskreises liegt. [...]” ♣ Tietz concludes his paper (p.49) as follows: “Die selben Überlegungen, die zu unserem Abbildungssatz führten, ermöglichen auch einen neuen Existenzbeweis für die Ahlforsche Normalform, wiederum jedoch ohne eine Schranke für die Anzahl der benötigten Blätter zu ergeben.” so this would be another (weak) version of Ahlfors, alas it seems that Tietz’s arguments were the object of critics, cf. Köditz-Timmann 1975 [470]] ♥3

- [831] H. Tietz, *Zur Realisierung Riemannscher Flächen*, Math. Ann. 128 (1955), 453–458. AS60 [♠ with corrections in the next entry [832]] ♥??
- [832] H. Tietz, *Berechtigung der Arbeit “Zur Realisierung Riemannscher Flächen”*, Math. Ann. 129 (1955), 453–458. AS60 ♥??
- [833] St. Timmann, *Kompakte berandete Riemannsche Flächen*, Diss. Hannover, 1969, 56 S. G78 [♠ this entry is cited on the “critical” page 198 of Grunsky 1978 [322], according to which it gives a generalization to Riemann surfaces of the Bieberbach-Grunsky theorem (i.e. circle map in the planar case) ♠ in particular, it could be the case that Timmann’s reproves the existence of an Ahlfors circle map, yet probably this is not the case] ★ ♥??
- [834] X. Tolsa, *Painlevé’s problem and the semiadditivity of analytic capacity*, Acta Math. 190 (2003), 105–149. A47 [♠ complete solutions of both problems of the title are given, the first being usually regarded as implicitly posed in Painlevé 1888 [631] (albeit nobody was ever able to locate the precise place, see e.g. Rubel 1971 [718] or Verdera 2004 [845] for why) and the second emanated from Vitushkin’s advanced studies in the 1960’s ♠ the introduction contain a historical sketch, from Ahlfors 1947 [16], Vitushkin 1950’s to Murai 1988 [574], Melnikov 1995 [544] (curvature of measures), G. David 1998 [199] (solution of Vitushkin’s conjecture), etc.] ♥164
- [835] G. Toumarkine, S. Havinson, *Propriétés qualitatives des solutions des problèmes extrémaux de certains types*, In: Fonctions d’une variable complexe. Problèmes contemporains. Paris 1962, p. 73. [♠ survey containing a quite complete bibliography] ♥??
- [836] S. Treil, *Estimates in the corona theorem and ideals of H^∞ : a problem of T. Wolff*, J. Anal. Math. 87 (2002), 481–495. [♠ improved lower estimates for the solution of the corona problem, but with still a large gap up the upper bound of Uchiyama 1980 (cf. esp. p.494)] ♥8
- [837] A. Tromba, *On Plateau’s problem for minimal surfaces of higher genus in \mathbb{R}^n* , SFB 72-Preprint 580, Bonn, 1983. [♠ doubts expressed about the validity of Dou-

⁴⁰If the surface is open this the non-trivial result of Behnke-Stein 1947/49 [?].

⁴¹This jargon goes back to Weierstrass (vgl. etwa Schottky 1877 [763]).

⁴²Maybe here one can pinpoint about a confusion with the uniformization of Klein-Poincaré-Koebe.

⁴³This is essentially the theorem of Bieberbach-Grunsky (with antecedent by Riemann and Schottky).

⁴⁴Compare maybe also Hilbert and Courant for similar works

- glas and Courant for the Plateau problem in the case of higher topological structure, compare Jost 1985 [402]] ★★★ ♡??
- [838] A. Tromba, *Dirichlet's energy on Teichmüller's moduli space and the Nielsen realization problem*, Math. Z. 222 (1996), 451–464. [♠] ★★ ♡??
- [839] V. V. Tsanov, *On hyperelliptic Riemann surfaces and doubly generated function algebras*, C. R. Acad. Bulgare Sci. 31 (1978), 1249–1252. [♠ quoted in Černe-Forstnerič 2002 [166]]★★ ♡??
- [840] M. Tsuji, *A simple proof of Bieberbach-Grunsky's theorem*, Comment. math. Univ. St. Paul 4 (1956), 29–32. G78 [♠ Nehari's review (in MR): “A new proof of the classical result that there exists a $(1, n)$ conformal mapping of a plane domain D of connectivity n onto the unit circle which carries a given point on each of the boundary components of D into the same point of the unit circumference.”] ★ ♡??
- [841] M. Tsuji, *Potential theory in modern function theory*, Tokyo, Maruzen, 1959. (Chelsea edition 1975.) ★ G78 [♠ contains apparently yet another proof of the Bieberbach-Grunsky theorem, perhaps the same as in the previous item]★ ♡high?
- [842] G. Tumarkin, see Toumarkine.
- [843] N. X. Uy, *On Riesz transforms of bounded functions of compact support*, Michigan Math. J. 24 (1977), 169–175. [♠ p.170 the Ahlfors function (referenced via Gamelin's book 1969 [263]) is involved in a theorem involving the Riesz transform] ♡??
- [844] Ch. de la Vallée Poussin, *Sur la représentation conforme des aires multiplement connexes*, Ann. École Norm. (3) 47 (1930), 267–309 G78 ♡??
- [845] J. Verdera, *Ensembles effaçables, ensembles invisibles et le problème du voyageur de commerce, ou comment l'analyse réelle aide l'analyse complexe*, Gazette des Math. 101 (2004), 21–49 A47 [♠ a thorough survey about Painlevé null-sets including the following points: ♠ Painlevé's problem about searching a geometric characterization of null-sets (nobody ever found an explicit formulation in Painlevé's writings, but Ahlfors 1947 [16] may be considered as the father of the modern era (introduction of the analytic capacity and insistence upon pure geometric conditions) ♠ Tolsa's resolution (ca. February 2003) of Painlevé's problem (via bilipchitzian invariance of analytic capacity) is mentioned ♠ p.29: the Denjoy conjecture (i.e., a compactum of a rectifiable curve is a (Painlevé) null-set iff its length is zero). This conjecture was cracked by the seminal work of Calderón 1977 [131] as was made explicit in a note of Marshall ♠ the (Vitushkin)-Garnett 1970 [283] example of the $1/4$ -Cantor set is discussed: this has positive length (because a certain projection is a full segment) but is a null-set (removable) ♠ this is used to motivate Besicovitch's notion of “invisible sets”, i.e. those projecting to sets of zero-length along almost every angular direction ♠ Vitushkin's conjecture: a compactum of the plane is a null-set iff it is invisible (alas, there is counter-examples of Mattila, and Jones-Murai 1988 [400]), yet the direct sense is true if finite length (as follows from the Denjoy conjecture solved since Calderón), hence ♠ weak Vitushkin conjecture (1967): among compacta of finite length, the null-sets coincide with the invisible sets. This was completed in G. David 1998 [199] upon combining a chain of contributions: Christ 1990, Mattila-Melnikov-Verdera 1996 [538] and Jones 1990] ♡1
- [846] I. N. Vekua, *Verallgemeinerte analytische Funktionen*, Berlin 1963 [♠ Riemann-Hilbert problem on finite bordered Riemann surfaces (and the allied Fredholm theory), cf. also Koppelman 1959 [472] Schüffler 1986 [767]] ♡??
- [847] H. Villat, *Le problème de Dirichlet dans une aire annulaire*, Rend. Circ. Mat. Palermo 33 (1912), 149 [♠ a brief proof of Villat's formula in Komatu (1945)] ♡??
- [848] V. Vinnikov, *Self-adjoint determinantal representations of real plane curves*, Math. Ann. 296 (1993), 453–479. [♠ a brilliant presentation of the theory of Klein-Weichold of real curves and simplified proof of results of Dubrovin-Natanzon, discusses complex orientations (à la Rohlin) ♠ mentions the result that a real plane curve with a nest of maximal depth is dividing (via Rohlin 1978 [706, p.93]), whose argument can (in our opinion) can be slightly simplified as follows ♠ given $C_m \subset \mathbb{P}^2$ a nonsingular curve of degree m with a deep nest then projecting the curve from any point chosen in the innermost oval gives a morphism $C_m \rightarrow \mathbb{P}^1$ whose fibers over real points are totally real, hence there is an induced map between the imaginary loci and it follows that C_m is dividing (just by using the

fact that the image of a connected set is connected). q.e.d. (N.B.: this is exactly Rohlin's argument except that we avoid the consideration of the canonical fibering $\text{pr}: \mathbb{C}P^2 - \mathbb{R}P^2 \rightarrow S^2$ envisaged by Rohlin) ♠ p.478 mentions the result of Nuij 1968 [615]: "any two real smooth plane curves of degree n having a nest of ovals of maximal depth are *rigidly isotopic* (i.e. belongs to the same component in the space of all real smooth plane curves of degree n)" ♠ [30.09.12] I vaguely remember of a sharper question (result?) asking if the space of deeply nested curves is not even a (contractible) cell ♠ [02.10.12] probably this question was rather asked for ovalless real curves, yet the idea (coming to me only today) is that the π_1 (fundamental group) of any chamber (=component of the complement of the discriminant hypersurface $D \subset |\mathcal{O}_{\mathbb{P}^2}(m)| = |mH|$ consisting of all singular curves) must act on the set of ovals of any fixed plane curves. Hence when there is no oval or a nest (not necessarily of maximal depth) then the induced (monodromy) permutation must be trivial and consequently there is no obstruction to the chamber having a simple topology. More generally this applies when there are several nests of different depths (then again nothing can be permuted). In contrast when there is collection of non-nested ovals (or two nests of the same depth) then there is no obstruction to there permutability (e.g. imagine a quartic with 4 ovals resulting from the smoothing of two conics then by rotating the plane we can achieve a transitive permutation of cyclic type). But probably the monodromy group of this quartic is bigger. How large exactly? ♠ a problem would be to count the number of component of $|mH| - D$ and if possible to describe the complex encoding the adjacency relation between the different chambers ♠ of course in the general question of describing the monodromy of a given curve, one can exploit Rohlin's idea of the complex orientation in the case where the curve is dividing, as the latter must probably be conserved during an isotopy-loop (up to reversion). If so then for the 4 ovals quartic we get an obstruction to there complete permutability, and the monodromy group is not the full symmetric group \mathfrak{S}_4 . Naively two ovals gyrate clock-wise and two anti-clock-wise (draw the complex orientations by doing sense preserving smoothings), yet since $\mathbb{R}P^2$ is nonorientable nothing is secure (i.e. the clockwise can continuously mutate in the anti-clock-wise)? (of course all this must be described somewhere with more care!) ♠ as in Nuij's result one can ask when the real scheme (Rohlin's jargon) determine unambiguously the isotopy type (or what is the same a unique chamber). A naive (probably wrong) guess is that if the monodromy is trivial, then the chamber is unique] ♡73

- [849] V. Vinnikov, *Commuting operators and function theory on a Riemann surface*, In: Holomorphic spaces (Berkeley 1995), MSRI Publications 33, 1998. A50 [♠ p.468, Ahlfors 1950 is briefly cited as a mapping onto the upper half-plane, and is applied to problems of operator theory and maybe as well to a generalization of the Riesz-Nevanlinna-Smirnov factorization ♠ compare optionally Havinson 1989/89[346] where a similar desideratum was found to be difficult (and unsolved?) ♠ from the abstract: "In the late 70's M. S. Livsic has discovered that a pair of commuting nonselfadjoint operators in a Hilbert space, with finite nonhermitian ranks, satisfy a polynomial equation with constant (real) coefficients; ...", whence the link with real curves (à la Klein) and therefore with Ahlfors] ♡16
- [850] O. Viro, *Progress in the topology of real algebraic varieties over the last six years*, Russian Math. Surveys (1986). [♠ "Contents. Introduction 55 §1. Real algebraic curves as complex objects 57 §2. Numerical characteristics and encoding of schemes of curves 59 §3. Old restrictions on schemes of curves 60 §4. New restrictions on schemes of curves 63 §5. Klein's assertion 67 §6. ..."] ♡106
- [851] K. I. Virtanen, *Über die Existenz von beschränkten harmonischen Funktionen auf offenen Riemannschen Flächen*, Ann. Acad. Sci. Fenn. Ser. A. I. 75 (1950), 8 pp. A50, A560 [cite Ahlfors 1950 [17] in a footnote (p.6) as follows: "Zusatz b.d. Korr.: Die Extremalfunktion η_n findet sich auch bei Ahlfors 1950 (= [17])." ♠ yet this function is only a harmonic function, hence not the (analytic) Ahlfors map we are focused upon. In particular Virtanen's paper does not reproves the existence of the Ahlfors maps, its main purpose being rather to establish the inclusion $O_{HB} \subset O_{HD}$ in the so-called classification theory of open Riemann surfaces] ♡??
- [852] K. I. Virtanen, *Über Extremalfunktionen auf offenen Riemannschen Flächen*, Ann. Acad. Sci. Fenn. Ser. A. I. 141 (1952), 7 pp. A560 [Ahlfors 1950 [17] is cited maybe?] ♡??

- [853] A. G. Vitushkin, *Analytic capacity of sets and some of its properties*, Dokl. Akad. Nauk SSSR 123 (1958), ?–?. (Russian) [♠ cited in Melnikov 1967 [542] for the definition of the Ahlfors function] ♡??
- [854] A. G. Vitushkin, *Example of a set of positive length but zero analytic capacity*, Dokl. Akad. Nauk SSSR 127 (1959), 246–249. (Russian) [♠ compare also the (simplified) construction in Garnett 1970 [283], who warns us that Vitushkin’s paper contains many typographical errors ♠ the basic implication “zero analytic capacity whenever zero linear measure” is a classical theorem of Painlevé (cf. e.g. Ahlfors 1947 [16, p. 2], a simple application of Cauchy’s formula)] ♡??
- [855] A. G. Vitushkin, *Analytic capacity of sets in problems of approximation theory*, Russian Math. Surveys 22 (1967), 139–200. A47 [♠ Ahlfors function appears on p. 142 ♠ formulation of the problem of the semi-additivity of analytic capacity solved (jointly with the older Painlevé problem on the geometric characterization of removable singularities) in Tolsa 2003 [834]] ♡219
- [856] Vo Dang Thao, *Über einige Flächeninhaltsformeln bei schlichtkonformer Abbildung von Kreisbogenschlitzgebieten*, Math. Nachr. 74 (1976), 253–261. [♠ cited in Alenicyñ 1981/82 [32]] ★★★ ♡low 4
- [857] M. Voichick, *Ideals and invariant subspaces of analytic functions*, Trans. Amer. Math. Soc. 111 (1964), 493–512. [♠ bounded analytic functions, nontangential boundary values (almost everywhere), inner function, Beurling’s invariant subspace theorem extended to finite Riemann surfaces (tools: Harnack’s principle, Fatou’s theorem, plus Read 1958 [676] and Royden 1962 [716] (both direct descendants of Ahlfors 1950 [17]), but the link if any is masked behind “une propice brume d’analyse fonctionnelle”) ♠ similar work by Hasumi 1966 [339] ♠ Voichick’s work also contains a “bordered” extension of the Beurling-Rudin description of closed ideals in the disc algebra, for which result Stanton 1971 [797] proposes another route hinging on the use of the Ahlfors map] ♡39/55
- [858] M. Voichick, L. Zalcman, *Inner and outer functions on Riemann surfaces*, Proc. Amer. Math. Soc. 16 (1965), 1200–1204. [♠ factorization theory in the Hardy classes H^p for finite bordered Riemann surfaces extending the classical theory (Hardy and the Riesz brothers) on the disc (antecedent by Parreau, Rudin 1955 [721], and Royden 1962 [716]), inner function, Blaschke product, Green’s function, etc. ♠ naively speaking one could hope that the Ahlfors function alone is a sufficient tool to lift the truth from the disc to the bordered surface, yet the implementation usually diverge slightly (here by using the universal covering to effect the reduction to the classical disc case)] ♡39
- [859] M. Voichick, *Extreme points of bounded analytic functions of infinitely connected regions*, Proc. Amer. Math. Soc. 11 (1966), 83–86. A50, G78 [♠ p. 1369, cite Ahlfors 1950 [17] for the existence of a negative harmonic function whose harmonic conjugate has prescribed periods ♠ this page contains an acrobatical implementation of the usual yoga attempting to annihilate periods to ensure single-valuedness (hence quite close to Ahlfors’ existence-proof of a circle map) ♠ p. 1367: “It should be noted that Gamelin in [2](=to appear=and seems to have appeared under extended coauthoring, namely Gamelin-Voichick 1968 [261]) characterized the extreme points of the unit ball of $H^\infty(R)$ when R is a finite bordered Riemann surface.”] ♡8
- [860] M. Voichick, *Invariant subspaces on Riemann surfaces*, Canad. J. Math. 18 (1966), 399–403. [♠]★★ ♡8
- [861] V. Volterra, *Sul Principio di Dirichlet*, Palermo Rend. 11 (1897), 83–86. AS60 [♠] ♡??
- [862] B. L. van der Waerden, *Topologie und Uniformisierung der Riemannschen Flächen*, Ber. Verh. Sächs. Akad. Wiss. Leipzig Math.-Phys. Kl. 93 (1941), 147–160. AS60 [♠ cf. also Carathéodory 1950 [149] and ref. therein, esp. to Reichardt.] ★ ♡??
- [863] J. L. Walsh, *The approximation of harmonic functions by harmonic polynomials and by harmonic rational functions*, Bull. Amer. Math. Soc. 35 (1929), 499–544. [♠ quoted via Axler’s review (BAMS) of Fisher’s book, for the harmonic conjugate as generally multiple-valued with periods]★★★ ♡??
- [864] J. L. Walsh, *Interpolation and functions analytic interior to the unit circle*, Trans. Amer. Math. Soc. 34 (1932), 523–556. [♠ Pick-Nevanlinna like still in the disc but see Heins 1975 [361] for an extension subsuming (in principle) the theory of the Ahlfors map]★ ♡??

- [865] J. L. Walsh, *Approximation by polynomials in the complex domain*, Mémorial des Sci. Math. 73 (1935), 1–72. [♠ formulates a general formalism of best approximation which encloses as special cases the least area interpretation of the Riemann mapping of Bieberbach 1914 [92], as well as generalizations of Julia, and many other workers including Kubota, Wirtinger, Kakey, F. Riesz (cf. esp. p. 61) ♠ further on p. 64 it is emphasized that (at time) virtually nothing was known for multiply-connected regions (this had to wait over Grunsky, Ahlfors, etc.)] ♡??
- [866] J. L. Walsh, *On the shape of level curves of Green's function*, Amer. Math. Monthly 44 (1937), 202–213. [♠]★★★ ♡??
- [867] J. L. Walsh, *The critical points of linear combinations of harmonic functions*, Bull. Amer. Math. Soc. ?? (1948), 196–205. A47 [♠ p. 196: “In various extremal problems of function theory the critical points of linear combinations of Green's functions and harmonic measures are of significance (See for instance M. Schiffer 1946; L. V. Ahlfors 1947 [16].) ♠ p. 205: “In connection with the methods we are using, a remark due to Bôcher (1904) is appropriate: “The proofs of the theorems which we have here deduced from mechanical intuition can readily be thrown, without essentially modifying their character, into purely algebraic form. The mechanical problem must nevertheless be regarded as valuable, for it suggests not only the theorems but also the method of proof.” ”] ♡??
- [868] J. L. Walsh, *The location of critical points*, Amer. Math. Soc. Colloq. Publ. 34, 1950. [♠ Chap. VII is quoted in Jones-Marshall 1985 [399] “for more information on the location of the critical points” [of the Green's function]] ♡??
- [869] J. L. Walsh, *Note on least-square approximation to an analytic function by polynomials, as measured by a surface integral*, Proc. Amer. Math. Soc. 10 (1959), 273–279. ♡??
- [870] J. L. Walsh, *History of the Riemann mapping theorem*, Amer. Math. Monthly 80 (1973), 270–276. [♠ a brilliant essay, which on p. 273 mentions briefly the counterexamples to the “naive” Dirichlet principle cooked by Prym 1871 and Hadamard 1906 (the precise links are not given but are Prym 1871 [664] and Hadamard 1906 [330])] ♡??
- [871] S. Warschawsky, *Über einige Konvergenzsätze aus der Theorie der konformen Abbildung*, Nachr. Ges. Wiss. Göttingen (1930), 344–369. AS60 ★ ♡??
- [872] H. Weber, *Note zu[m] Riemann's Beweis des Dirichlet'schen Prinzips*, J. Reine Angew. Math. 71 (1870), 29–39. AS60 [♠ an attempt is made to complete the reasoning of Riemann to establish the Dirichlet principle ♠ this work is quoted in Ahlfors-Sario's masterpiece [22], but Weber's work seems to be subjected to serious objections (according to Zaremba 1910 [908]) including the basic one of Weierstrass about the existence of a minimum value for the Dirichlet integral ♠ further [as our attempt to make Zaremba's objections more explicit] on p. 30 (line 4) Weber makes the tacit assumption that he can find a function u matching the boundary values and of *finite* Dirichlet integral: this is however violently attacked by the Hadamard 1906 [330] counterexample of a boundary data all of whose matching functions explode to infinite Dirichlet integral ♠ a weaker result of this type was already obtained by Prym 1871 [664] who gave a continuous function on the unit-circle whose harmonic extension to the disc (existence via e.g. Poisson) has infinite Dirichlet integral ♠ can we characterize such exploding functions? Maybe in terms of wild oscillations (can a such be differentiable (probably recall the wild functions à la Köpcke–Denjoy, etc.), C^1 (=continuously derivable), etc.)
◇ H. Weber albeit not a direct student of Riemann, was regarded as one of the efficient successor (e.g. by Thieme, compare Elstrodt-Ulrich [222]). Weber played a pivotal role (joint with Dedekind) in editing Riemann's Werke (including the Nachlass [689]), and replaced Clebsch who desisted from this task due to health problems] ♡??
- [873] G. Weichold, *Ueber symmetrischen Riemann'sche Flächen und die Periodizitätsmoduln der zugehörigen Abel'schen Normalintegrale erster Gattung*, Z. Math. Phys. 28 (1883), 321–351. [♠ exposes the theory of Klein's symmetric surfaces in full detail (basing the topological study upon the Möbius-Jordan classification [401]), and do some more subtle things with period matrices ♠ this latter object is re-treated in Klein 1892 [438], and will influence the work of Comessatti 1924/26 [181] ◇ Guido Weichold was a student of Klein, who seems to have been strongly attracted to the topic of symmetric Riemann surfaces through Klein's lectures. Apparently, Weichold did not pursued his research on this topic] ♡high??

- [874] K. Weierstrass, *Über das sogenannte Dirichletsche Princip.* In: Werke vol. 2, Mayer & Müller, 49–54, 1895. gelesen in der Königl. Akademie der Wissenschaften am 14. Juli 1870. [♠ a little objection to the Dirichlet principle, yet with disastrous repercussions ♠ resurrection by Hilbert 1900, etc. [374] ◇ Karl Weierstrass needs not to be introduced. Formally a student of Gudermann, he came across the problem of Jacobi inversion, but unfortunately never published his solution (probably being slightly devanced by Riemann 1857 in this respect). Of course as the whole Riemann approach was for a long time subjected to critics, it would have been of prior interest to know what can be achieved through the pure Weierstrass conceptions collapsing to a sort of arithmetics of power series] ♡**high?**
- [875] G. G. Weill, *Reproducing kernels and orthogonal kernels for analytic differentials on Riemann surfaces*, Pacific J. Math. 12 (1962), 729–767. [♠ refers to Ahlfors-Sario 1960 [22] for the Bergman kernel on Riemann surfaces, other source includes Schiffer-Spencer 1954 [753] ◇ Weill is a student of Sario (Ph.D.) ca. 1962] ♡**7**
- [876] G. Weiss, *Complex methods in harmonic analysis*, Amer. Math. Monthly 77 (1970), 465–474. [♠]★★★ ♡??
- [877] J. Wermer, *Function rings and Riemann surfaces*, Ann. of Math. (2) 67 (1958), 45–71. [♠]★★★ ♡??
- [878] J. Wermer, *Rings of analytic functions*, Ann. of Math. (2) 68 (1958), 550–561. [♠]★★★ ♡??
- [879] J. Wermer, *Analytic disks in maximal ideal spaces*, Amer. J. Math. 86 (1964), 161–170. [♠]★★★ ♡??
- [880] H. Weyl. *Das asymptotische Verteilungsgesetz der Eigenwerte linearer partieller Differentialgleichungen*, Math. Ann. 71 (1912), 441–479. [♠ the so-called Weyl’s (asymptotic) law asserting that one can hear the area of a drum ♠ naive conjecture [ca. Mai 2011] can this Weyl’s law be employed as tool to prove the Gromov filling area conjecture (eventually in conjunction with an Ahlfors map to make the usual conformal transplantation of vibratory modes, cf. e.g. Fraser-Schoen 2011 [249] for the first implementation of Ahlfors’ circle maps in spectral theory)] ♡**high?**
- [881] H. Weyl. *Die Idee der Riemannschen Fläche*, B. G. Teubner, Leipzig und Berlin 1913. ♡**high?**
- [882] H. Weyl. *Ueber das Pick-Nevanlinnasche Interpolationsproblem und sein infinitesimales Analogon*, Ann. of Math. (2) 36 (1935), 230–254. [♠] ♡??
- [883] H. Weyl. *The method of orthogonal projection in potential theory*, Duke Math. J. 7 (1940), 411–440. AS60 ★ ♡??
- [884] H. Widom. *Extremal polynomials associated with a system of curves in the complex plane*, Adv. Math. 3 (1969), 127–232. [♠]★★ ♡??
- [885] H. Widom, *H_p sections of vector bundles over Riemann surfaces*, Ann. of Math. (2) 94 (1971), 304–324. AS60 [♠ the geometric quintessence of the paper seems to be Lemma 6 (p. 320), created with apparently some helping hand from Royden, and amounting to prescribe (modulo 2π) the periods of the conjugate differential of a superposition of (modified) Green’s functions ♠ albeit Ahlfors 1950 [17] is not directly cited, a certain technological “air de famille” transpires throughout the execution ♠ alas, Widom’s argument (pp. 320–1) seems to give only a poor control upon the number of poles ζ_k required, and is therefore unlikely to reprove Ahlfors 1950 [17] by specializing to the trivial line bundle case ♠ but of course, Widom do something quite grandiose and so the real depth of the work cannot be appreciated by focused comparison with Ahlfors 1950 [17] ♠ in particular Widom (re)discover a certain class of open Riemann surfaces (alias of Parreau-Widom) type which are characterized by a moderate growth of the Betti number during the cytoplasmic expansion generated by levels of the Green’s function, which turns out to be a very distinguished class of Riemann surfaces where paradigms like the corona, etc. extends reasonably] ♡**35**
- [886] R. J. Wille, *Sur la transformation intérieure d’une surface non orientable dans le plan projectif*, Indagationes Math. 56 (1953), 63–65. [♠ probably a nonorientable avatar of Stoilow’s work, and maybe related to Witt 1934 [892]]★★★ ♡??
- [887] J. Winkelmann, *Non-degenerate maps and sets*, Math. Z. (2005), 783–795. A50 [♠ [27.09.12] Ahlfors 1950 [17] is cited, yet not within the main-body of the text, but its companion Bell 1992 [66] is cited for the same purpose. In fact Winkelmann’s article only uses the planar case of the Ahlfors function, hence citing Ahlfors 1947

[16] may have been more appropriate (yet recall that the latter article contains a little gap fixed in Ahlfors 1950 [17, p.123, footnote]) ♠ the author gives the following lovely application of the Ahlfors map of a plane bounded domain ♠ call a holomorphic map *dominant* if it has dense image, and a complex manifold *universally dominant* (UDO) if it admits a dominant map to any irreducible complex space. The author shows first that the unit disc Δ is UDO (Cor. 3, p.786), and via the Ahlfors function this implies more generally that any complex manifold admitting a nonconstant bounded analytic function (BAF) is UDO. Here are the details. ♠ first if the complex manifold is UDO, then it dominates the unit disc Δ , and so it carries a nonconstant BAF. Conversely, let $f: X \rightarrow \mathbb{C}$ be a nonconstant BAF then $f(X)$ is a bounded domain. (It is crucial here to assume X connected, for X the disjoint union of say two Riemann spheres carries a nonconstant BAF, yet fails to be UDO.) Now observe the following fact. **Lemma.** *The Ahlfors map f_a at a of the bounded domain $G \ni a$ is dominant.*—*Proof.* If not, then the map $f_a: G \rightarrow \Delta$ misses a little disc $D \subset \Delta$ not overlapping the origin (recall that $f_a(a) = 0$). Since the identity map restricted to the ring $\Delta - \overline{D}$ is bounded-by-one (hence admissible in the extremal problem), it follows that the Ahlfors map for the ring centered at 0, say g_0 , has a derivative with modulus strictly larger than unity, i.e. $|g'_0(0)| > |(id)'(0)| = 1$. But then the composed map $(g_0 \circ f_a)$ effects the stretching $|(g_0 \circ f_a)'(a)| = |(g'_0(f_a(a)) \cdot f'_a(a)| = |g'_0(0) \cdot f'_a(a)| > |f'_a(a)|$, violating the extremal property of f_a . q.e.d.—♠ At this stage it may be observed that the Ahlfors map of a bounded domain needs not be surjective. Consider indeed the unit disc Δ punctured at say $1/2$, then the Ahlfors function of $\Delta - \{1/2\}$ centered at 0, denoted f_0 , is the identity (up to a rotation). Indeed, since a (pointlike) puncture is a removable singularity for BAF any function admitted in the extremal problem extends analytically across the whole unpunctured disc. More generally, the Ahlfors map is insensitive to the puncturing of a removable singularity (alias Painlevé null sets), e.g. Cantor's $1/4$ -set described in Garnett 1970 [283] ♠ back to Winkelmann's argument, the above lemma applied to $G := f(X)$ gives a dominant map f_a to the disc, hence a dominant map $X \rightarrow f(X) \rightarrow \Delta$. Summarizing: *any complex manifold X supporting a nonconstant BAF dominates the disc.* ♠ Perhaps one could try to improve this by using the surjectivity of the Ahlfors map for a domain of finite connectivity (without pointlike boundaries), assuming e.g. that X has a finitely generated fundamental group π_1 . Alas, this does not seem to imply automatically that $\pi_1(f(X))$ is of finite generation and we need of course to control the shape of the image $f(X)$, which has to be a finite region bounded by Jordan curves ♠ finally since the disc Δ dominates any irreducible complex space Y (of course the definition of the latter must be calibrated so as to avoid non-metric complex manifolds of Calabi-Rosenlicht of the Prüfer type, at least those specimens which are not separable), the composition $X \rightarrow f(X) \rightarrow \Delta \rightarrow Y$ yields the desired dominant map showing that X is UDO. This completes Winkelmann's proof.] ♡5

[888] W. Wirtinger, *Algebraische Funktionen und ihre Integrale*, Enzykl. d. math. Wiss. 2₂ (1902), 115–175. AS60 ♡??

[889] W. Wirtinger, *Über die konforme Abbildung der Riemannschen Flächen durch Abelsche Integrale besonders bei $p = 1, 2$* , Denkschr. Wien (1909), 22 pp. AS60 ♡??

[890] W. Wirtinger, *Über eine Minimalaufgabe im Gebiete der analytischen Funktionen*, Monatsh. Math. u. Phys. 39 (1932), 377–384. [♣ quoted p. 269 of Schiffer 1950 [751] for a the first notice of a certain reproducing kernel property, also quoted in Bergman 1950 [84] ♠ poses (and solves via the Green's function) the problem of the best analytic approximation f in L^2 -norm $\int \int_B |f - \Phi|^2 d\omega$ of a given continuous function Φ] ♡4

[891] W. Wirtinger, *Zur Theorie der konformen Abbildung mehrfach zusammenhängender ebener Flächen*, Abh. Preuß. Akad. Wiss. math.-nat. Kl. 4 (1942), 1–9. AS60, G78 [♣ reproves the theorem of Riemann-Schottky-Bieberbach-Grunsky (=RSBG), i.e. the schlicht(artig) case of the Ahlfors map, via algebraic functions (i.e. Riemann-(Roch) essentially)] ♡low 0

[892] E. Witt, *Zerlegung reeller algebraischer Funktionen in Quadrate*, J. Reine Angew. Math. 171 (1934), 4–11. [♣ contains a sort of non-orientable version of the Riemann/Ahlfors map. Subsequent developments in Geyer 1964/67 [289] and Martens 1978 [526]] ♡??

[893] D. V. Yakubovich, *Real separated algebraic curves, quadrature domains, Ahlfors type functions and operator theory*, J. Funct. Anal. 236 (2006), 25–58. A50 [♣ con-

- tains also (after Alling-Greenleaf [38]) a clear-cut formulation of the Klein-Ahlfors correspondence: i.e. a curve is dividing/separating iff it maps to the line in a totally real fashion (i.e. real fibres are entirely real) ♡2?
- [894] A. Yamada, *On the linear transformations of Ahlfors functions*, Kōdai Math. J. 1 (1978), 159–169. A50 [♣ evaluate the degree of the Ahlfors function at the Weierstrass points of a non-planar hyperelliptic membrane as taking the maximum value permissible, i.e. $r + 2p = g + 1$] ♡3
- [895] A. Yamada, *A remark on the image of the Ahlfors function*, Proc. Amer. Math. Soc. 88 (1983), 639–642. [♠ domains of infinite connectivity ♠ p. 639 (abstract extract): “By an example we show that the complement in the unit disc of the image of the Ahlfors function for Ω and p can be a fairly general set of logarithmic capacity zero.”] ♡1
- [896] A. Yamada, *Ahlfors functions on Denjoy domains*, Proc. Amer. Math. Soc. 115 (1992), 757–763. [♠ domains of infinite connectivity ♠ p. 757: “The main result of our paper gives a necessary and sufficient condition for a subset of the unit disc to be the omitted set of the Ahlfors function F for some maximal Denjoy domain and ∞ such that F is a covering onto its image. As a corollary we give examples of omitted sets of Ahlfors functions that have positive logarithmic capacity.” ♠ [05.10.12] if I don’t mistake Yamada’s example thus answers a question by Minda 1981 [556, p. 755] about knowing if the Ahlfors function can “omit an uncountable set”. (Recall indeed that sets of zero logarithmic capacity are stable under countable unions, cf. p. 762, where Yamada refers to Tsuji 1959 [841, p. 57].)] ♡??
- [897] A. Yamada, *Ahlfors functions on compact bordered Riemann surfaces*, J. Math. Soc. Japan 53 (2001), 261–283. A50 [♣ establish a conjecture of Gouma 1998 [297] to the effect that the Ahlfors degree of a hyperelliptic membrane centered outside the Weierstrass points always degenerates to the minimum value 2] ♡1
- [898] P. C. Yang, S.-T. Yau, *Eigenvalues of the Laplacian of compact Riemann surfaces and minimal submanifolds*, Ann. Sc. Norm. Sup. di Pisa (4) 7 (1980), 55–63. [♠ applies conformal branched covering of *closed* Riemann surfaces to the sphere and the trick of conformal transplantation to generate test functions yielding an estimate of the first three Laplace eigenvalues of a closed Riemann surface considered as a vibrating membrane. Inspiration Szëgo, Hersch 1970 [372], but goes somewhat deeper as there is no fear of multi-sheetedness ♠ for an adaptation of Yang-Yau’s method to bordered surfaces via the Ahlfors map see Fraser-Schoen 2011 [249], or some derived products like Gabard 2011 [256] or Girouard-Polterovich 2012 [291]] ♡250?
- [899] O. Yavuz, *Invariant subspaces for Banach space operators with a multiply connected spectrum*, Integr. Equ. Oper. Theory 58 (2007), 433–446. [♠ p. 439–440, the Ahlfors function (via Fisher’s book 1983 [241]) is employed to extend a result on the existence of invariant subspaces for operators with a multiply-connected spectrum (previously known when the spectrum contained the unit-circle)] ♡??
- [900] O. Yavuz, *A reflexivity result concerning Banach space operators with a multiply connected spectrum*, Integr. Equ. Oper. Theory 68 (2010), 473–485. [♠ p. 475–6, Ahlfors function via Fisher’s book 1983 [241]] ♡??
- [901] N. X. Yu, *On Riesz transforms of bounded function of compact support*, Michigan Math. J. 24 (1977), 169–175. [♠ p. 170, Ahlfors function via Carleson’s book 1967 [155, Chapter VIII]] ♡??
- [902] L. Zalcman, *Analytic capacity and rational approximation*, Lecture Notes in Math. 50, Springer-Verlag, Berlin–New York, 1968. A50 [♠] ♡116
- [903] L. Zalcman, *Analytic functions and Jordan arcs*, Proc. Amer. Math. Soc. 19 (1968), 508. [♠] ♡??
- [904] L. Zalcman, *Bounded analytic functions on domains of infinite connectivity*, Trans. Amer. Math. Soc. 144 (1969), 241–270. [♠] ♡56
- [905] K. Zarankiewicz, *Sur la représentation conforme d’un domaine doublement connexe sur un anneau circulaire*, C.R. Acad. Sci. Paris 198 (1934), 1347–1349. [♠ Seidel’s summary: method for the effective construction of the conformal mapping of a doubly connected domain upon a circular ring, via orthogonal systems (Bergman kernel) ♠ consider (with Bergman [no precise cross-ref.]) the problem of maximizing the modulus of $f(t)$ among functions with L^2 -norm bounded by 1: $\int \int_B |f(z)|^2 \leq 1$] ♡??

- [906] K. Zarankiewicz, *Über ein numerisches Verfahren zur konformen Abbildung zweifach zusammenhängender Gebiete*, Zeitschr. f. angew. Math. u. Mech. 14 (1934), 97–104. [♠ Seidel’s summary: a detailed account is given of the method indicated in Zarankiewicz 1934 [905], i.e. Bergman kernel style numerical device to compute the conformal map of a doubly connected domain ♠ oft quoted e.g. in Lehto 1949 [500], Bergman 1950 [84]]★★★ ♡??
- [907] S. Zaremba, *Sur le calcul numérique des fonctions demandées dans le problème de Dirichlet et le problème hydrodynamique*, Bull. Inst. Acad. Sci. Cracovie (1908), 125–195. [♠ quoted (e.g.) in Lions 2000/02 [507] as one of the very early apparition of the notion of reproducing kernel] ♡??
- [908] S. Zaremba, *Sur le principe de Dirichlet*, Acta Math. ? (1910), 293–316. [♠ Hadamard’s 1906 [330] counterexample to the Dirichlet principle is cited (but not the earlier one of Prym 1871 [664]) and further (p.294) asserts that Weber’s 1869/70 [872] attempt to consolidate Riemann’s proof is subjected to serious objections ♠ unfortunately, Zaremba does not make explicit any objection, but it is implicit that he has in mind the Weierstrass critic (of a functional not achieving a minimum) and further Weber’s tacit assumption that the Dirichlet integral is finite is violently attacked by the Hadamard 1906 [330] counterexample of a boundary data all of whose matching functions have infinite Dirichlet integral (of course, Prym 1871 [664] is a sufficient torpedo to destroy completely Weber’s argumentation) ♠ notice that Arzelà 1897 [51] has to be counted as a forerunner of Hilbert’s triumph of all the difficulty of the question (in certain particular cases), and mentions the remarkable extensions due to B. Levi 1906 [505], Fubini 1907 [251] and Lebesgue 1907 [499], while proposing to recover those results through a simpler method without loosing anything essential to their generality] ♡??
- [909] H. G. Zeuthen, *Sur les formes différentes des courbes du quatrième ordre*, Math. Ann. 7 (1874), 410–432. (+Tafel I, II, Fig. 1,2,3,4,5) [♠ a work who inspired much of Klein investigation ♠ cite von Staudt (Geometrie der Lage) ♠ uses the term “ovale” ♠ p.411: “Une courbe du quatrième ordre (*quartique*) a, au plus, quatre branches externes l’une à l’autre, ou deux branches dont l’une se trouve dans la partie du plan interne à l’autre, et dans ce dernier cas la branche interne ne peut avoir des tangentes doubles ou d’inflexion.—Car s’il en était autrement on pourrait construire des coniques rencontrant la courbe en plus de 8 points, ou des droites la rencontrant en plus de 4 points.” (This is the sort of Bézout-type argument out of which will emerge the Harnack inequality 1876 [334]), yet the full intrinsic grasp (especially the interpretation via Riemann surfaces) will be effected through Klein’s work 1876 [432] ♠ p.412: “Nous appelons ici réelle toute courbe dont l’équation ne contient que des coefficients réels.”] ♡??
- [910] M. Zhang, Y. Li, W. Zeng, X. Gu, *Canonical conformal mapping for high genus surfaces with boundaries*, Computers Graphics 36 (2012), 417–426. [♠ completely in line with our present topic, and use high powered machinery like Koebe’s iteration and (Yau-Hamilton’s) Ricci flow for conformal theoretic purposes ♠ can we adapt such algorithms to the (Ahlfors) circle map] ♡??
- [911] V. A. Zmorovič, *The generalization of the Schwarz formula for multiply connected domains*, (Ukrainian) Dokl. Akad. Nauk Ukrain. SSR 7 (1962), 853–856. [♠ quoted in Khavinson 1984 [425]]★★ ♡??

Alexandre Gabard
 Université de Genève
 Section de Mathématiques
 2-4 rue du Lièvre, CP 64
 CH-1211 Genève 4
 Switzerland
 alexandregabard@hotmail.com

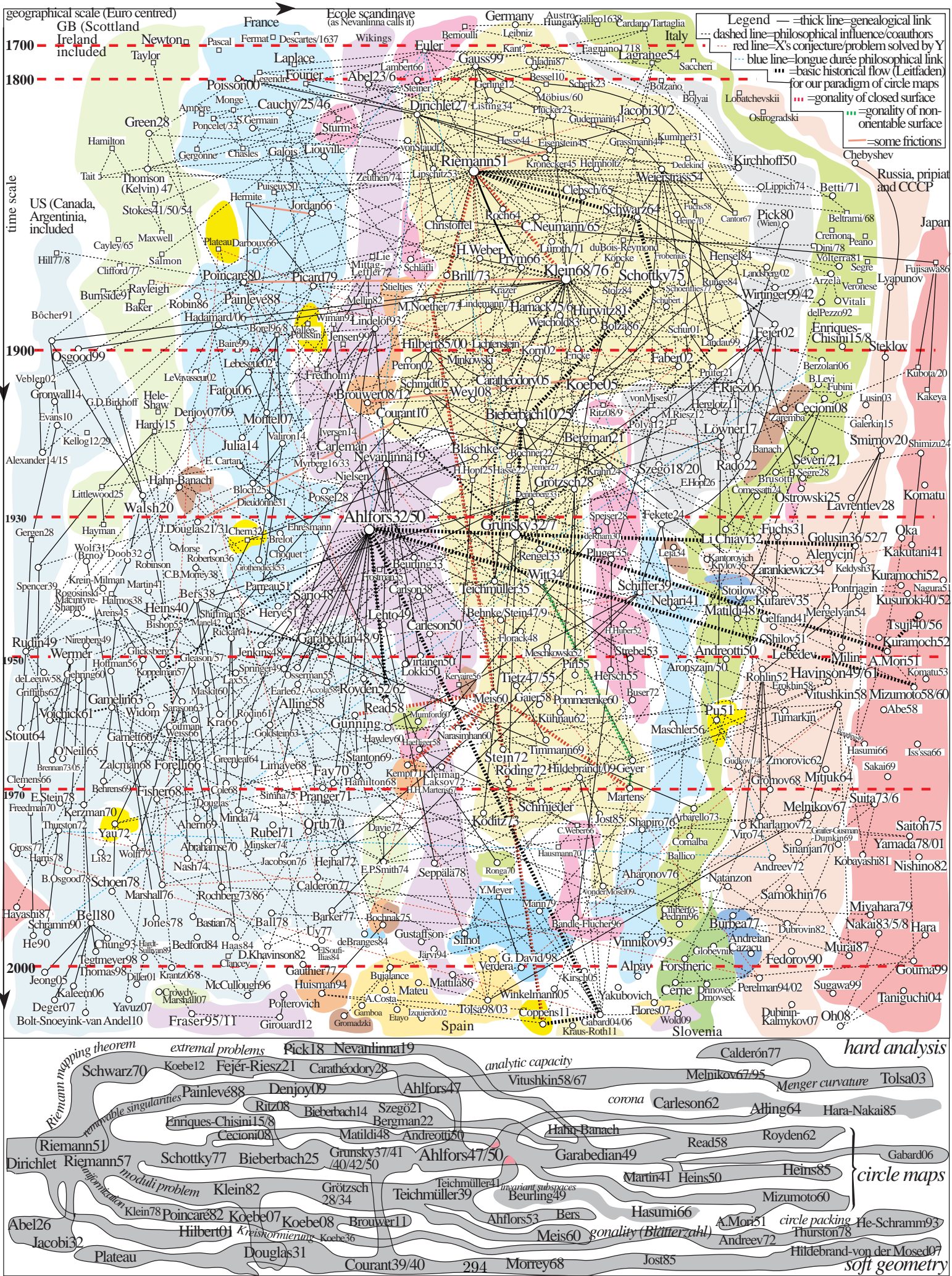

Figure 60: The authors involved in this bibliography (and genealogy)