

Contribution to the special issue: Statistical Mechanics and Social Sciences edited by Sidney Redner.

## Non-consensus opinion models on complex networks

Qian Li<sup>1,\*</sup>, Lidia A. Braunstein<sup>2,1</sup>, Huijuan Wang<sup>3,1</sup>,  
Jia Shao<sup>1</sup>, H. Eugene Stanley<sup>1</sup>, and Shlomo Havlin<sup>4</sup>

<sup>1</sup>*Department of Physics and Center for Polymer Studies,  
Boston University, Boston, MA 02215, USA*

<sup>2</sup>*Instituto de Investigaciones Físicas de Mar del Plata (IFIMAR)-Departamento de Física,  
Facultad de Ciencias Exactas y Naturales,  
Universidad Nacional de Mar del Plata-CONICET,  
Funes 3350, (7600) Mar del Plata, Argentina.*

<sup>3</sup>*Delft University of Technology, Faculty of Electrical Engineering,  
Mathematics and Computer Science, 2628 CD, Delft, The Netherlands*

<sup>4</sup>*Department of Physics, Bar Ilan University, Ramat Gan, Israel*

(Dated: 10 September 2012 — lbwssh10sep.tex)

## Abstract

Social dynamic opinion models have been widely studied to understand how interactions among individuals cause opinions to evolve. Most opinion models that utilize spin interaction models usually produce a consensus steady state in which only one opinion exists. Because in reality different opinions usually coexist, we focus on non-consensus opinion models in which above a certain threshold two opinions coexist in a stable relationship. We revisit and extend the non-consensus opinion (NCO) model introduced by Shao *et al.*[1]. The NCO model in random networks displays a second order phase transition that belongs to regular mean field percolation and is characterized by the appearance (above a certain threshold) of a large spanning cluster of the minority opinion. We generalize the NCO model by adding a weight factor  $W$  to individual's own opinion when determining its future opinion (NCOW model). We find that as  $W$  increases the minority opinion holders tend to form stable clusters with a smaller initial minority fraction compared to the NCO model. We also revisit another non-consensus opinion model based on the NCO model, the inflexible contrarian opinion (ICO) model [2], which introduces inflexible contrarians to model a competition between two opinions in the steady state. Inflexible contrarians are individuals that never change their own opinion but may influence opinions of others. To place the inflexible contrarians in the ICO model we use two different strategies, random placement and one in which high-degree nodes are targeted. In both strategies, the inflexible contrarians effectively decrease the size of the largest cluster of the rival opinion but the effect is more pronounced under the targeted method. All of the above models have previously been explored in terms of a single network. However human communities are rarely isolated, instead are usually interconnected. Because opinions propagate not only within single networks but also between networks, and because the rules of opinion formation within a network may differ from those between networks, we study here the opinion dynamics in coupled networks. Each network represents a social group or community and the interdependent links joining individuals from different networks may be social ties that are unusually strong, e.g., married couples. We apply the non-consensus opinion (NCO) rule on each individual network and the global majority rule on interdependent pairs such that two interdependent agents with different opinions will, due to the influence of mass media, follow the majority opinion of the entire population. The opinion interactions within each network and the interdependent links across networks interlace periodically until a steady state is reached. We find that the interdependent links effectively force the system from a second order phase transition,

which is characteristic of the NCO model on a single network, to a hybrid phase transition, i.e., a mix of second-order and abrupt jump-like transitions that ultimately becomes, as we increase the percentage of interdependent agents, a pure abrupt transition. We conclude that for the NCO model on coupled networks, interactions through interdependent links could push the non-consensus opinion type model to a consensus opinion type model, which mimics the reality that increased mass communication causes people to hold opinions that are increasingly similar. We also find that the effect of interdependent links is more pronounced in interdependent scale free networks than in interdependent Erdős Rényi networks.

PACS numbers:

---

\*Electronic address: liqian@bu.edu

## I. INTRODUCTION

Statistical physics methods have been successfully applied to understand the cooperative behavior of complex interactions between microscopic entities at a macroscopic level. In recent decades many research fields, such as biology, ecology, economics, and sociology, have used concepts and tools from statistical mechanics to better understand the collective behavior of different systems either in individual scientific fields or in some combination of interdisciplinary fields. Recently the application of statistical physics to social phenomena, and opinion dynamics in particular, has attracted the attention of an increasing number of physicists. Statistical physics can be used to explore an important question in opinion dynamics: how can interactions between individuals create order in a situation that is initially disordered? Order in this social science context means agreement, and disorder means disagreement. The transition from a disordered state to a macroscopic ordered state is a familiar territory in traditional statistical physics, and tools such as Ising spin models are often used to explore this kind of transition. Another significant aspect present in social dynamics is the topology of the substrate in which a process evolves. This topology describes the relationships between individuals by identifying, e.g., friendship pairs and interaction frequencies. Researchers have mapped the topology of social connections onto complex networks in which the nodes represent agents and the links represent the interactions between agents [3–15]. Various versions of opinion models based on spin models have been proposed and studied, such as the Sznajd model [16], the voter model [17, 18], the majority rule model [19, 20], and the social impact model [21, 22].

Almost all spin-like opinion models mentioned above are based on short-range interactions that reach an ordered steady state, with a consensus opinion that can be described as a consensus opinion model. However, in real life different opinions are mostly present and coexist. In a presidential election in a country with two political parties in which each party has its own candidate, for example, a majority opinion and a minority opinion coexist. The opinions among the voters differ, with one fraction of the voters supporting one candidate and the rest supporting the other, and rarely will the two opinions reach consensus. This reality has motivated scientists to explore opinion models that are more realistic, ones in which two opinions can stably coexist. Shao *et al.* [1] proposed a nonconsensus opinion (NCO) model that achieves a steady state with two opinions coexisting. Unlike the majority

rule model and the voter model in which the dynamic of an agent’s opinion is not influenced by the agent’s own current opinion but only by its neighbors, the NCO model assumes that during the opinion formation process an agent’s opinion is influenced by *both* its own current opinion and the opinions of friends, modeled as nearest-neighbors in a network. This NCO model begins with a disordered state with a fraction  $f$  of  $\sigma_+$  opinion and a fraction  $1 - f$  of  $\sigma_-$  opinion distributed randomly on the nodes of a network. Through interactions the two opinions compete and reach a non-consensus stable state with clusters of  $\sigma_+$  and  $\sigma_-$  opinions. In the NCO model, at each time step each node adopts the majority opinion of its “neighborhood”, which consists of the node’s nearest neighbors and itself. When there is a tie, the node does not change its opinion. The NCO model takes each node’s own current opinion into consideration, and this is a critical condition for reaching a nonconsensus steady state. Beginning with a random initial condition, this novel nontrivial stable state in which both majority and minority opinions coexist is achieved after a relatively short sequence of time steps in the dynamic process. The NCO model has a smooth phase transition with the control parameter  $f$ . Below a critical threshold  $f_c$ , only the majority opinion exists. Above  $f_c$ , minorities can form large spanning clusters across the total population of size  $N$ . Using simulations, Shao *et al.* [1] suggested that the smooth phase transition in the NCO model in random networks is of the same universality class as regular mean field (MF) percolation. But simulations of the NCO model in Euclidean lattices suggest that the process might belong to the universality class of invasion percolation with trapping (TIP) [1, 23]. Apparently this is the first time, to the best of our knowledge, that a social dynamic model has been mapped to percolation, an important tool in statistical physics. However, the nature of this percolation on  $2D$  lattice is still under debate [23, 24]. Exact solutions of the NCO model in one dimension and in a Cayley tree have been developed by Ben-Avraham [25].

Here we present simulations suggesting that the behavior of the NCO model, in which two opinions coexist, disappears when the average network degree increases. When the average degree of a network is high, the agent’s own opinion becomes less effective and the NCO model converges to the majority voter model. This was argued analytically by Roca [26] and claimed also by Sattari *et al* [24]. In the present paper, we also generalize the NCO model and create a nonconsensus opinion model by adding a weight (NCOW model) to an agent’s own opinion. The weight  $W \geq 1$  represents the strength of an individual’s own

opinion. Note that in the NCO model  $W$  is assumed to be 1 like the weight of its neighbors opinion. We find that the NCOW model inherits all the features of the NCO model, except that the critical threshold  $f_c$  of the NCOW model with  $W > 1$  decreases when  $W$  increases. This means that strengthening one's own opinion helps smaller minority opinion groups to survive.

The NCO model reaches a steady state in which the two opinions coexist. This is only partially realistic. In real life, two opinions do not simply coexist—they continue to compete. Real-world examples include the decades-long competition between the Windows and Macintosh operating systems and between Republicans and Democrats in US presidential politics. All the participants in these competitions have the same goal: winning. In order to increase their prospects of winning, they need as many supporters (or customers) as possible. Thus, it is interesting to study how two opinions continue to compete after they have reached a steady state. In order to consider both aspects, the nonconsensus steady state and the competition, Li *et al.* [2] proposed an inflexible contrarian opinion (ICO) model in which a fraction  $\phi$  of inflexible contrarians are introduced into the final steady state of the NCO model and two different competition strategies are then applied. The concepts of inflexible agents and contrarian agents were introduced by Galam [27, 28] in his work on opinion models. In the ICO model, an inflexible contrarian is an agent that holds an opinion contrary to that held by the majority of its surrounding group and its opinion is not influenced by its surrounding group—it never changes. Inflexible contrarians have one goal: to change the opinion of the current supporters in the rival group. We see this strategy when, for example, companies send a free product to potential customers in order to convince them to adopt the product and influence their friends to do the same. We study the ICO model in order to determine, for example, whether these free products actually do help to win the competition, how many free products are needed to be sent, and who are the best candidates to receive the free product. Reference [2] presents two strategies for introducing inflexible contrarians into the steady state of the  $\sigma_+$  opinion groups: (i) the random strategy and (ii) the targeted (high degree) strategy. Using these strategies, we find that the relative size of the largest cluster in state  $\sigma_+$  undergoes a second-order phase transition at a critical fraction of inflexible contrarians  $\phi_c$  below which the two opinions can coexist and above which only  $\sigma_-$  exists. Thus the ICO also belongs to the type of nonconsensus opinion models. The results also indicate that the largest cluster in state  $\sigma_+$  undergoes a

second order phase transition that can be mapped into MF percolation similar to the NCO model.

All opinion models described above have been studied on a single network. However, in real social opinion dynamics, individuals belonging to different social communities can as well communicate. In a traditional agrarian village, for example, two separate working relationship networks often form. Men work in the fields with other men and women work in their homes with other women. Marriages between men and women in this setting create interdependencies between the two working relationship networks. As far as we know, there has been no model study of how this kind of strong social connection between two such different groups influences the exchange of opinions. In studying the opinion dynamics across different groups we utilize a concept that has recently gained wide attention: the resilience of interdependent networks to cascading failures [29–36]. Connecting two networks together with interdependent links allows individuals to exchange opinions between networks. In our model, two nodes from different networks that are connected by interdependent links represent a pair of nodes that have strong social relations. In interdependent networks we usually distinguish between the connectivity links between agents within each network or community and interdependent links between agents from different networks.

To study the effect of interdependent links on opinion dynamics, we propose a non-consensus opinion (NCO) model on coupled networks in which we assume different opinion formation rules for internal connectivity and interdependent links. We assume that during the dynamic process of opinion formation the agents that are connected with interdependent links will have the same opinion, this being the case because their social relationship is strong. In our model, the NCO rules are applied in each individual network. For the coupled pairs the following rule is applied: if two interdependent nodes have the same opinion, they will keep this opinion, but if they have different opinions, they will follow the majority opinion of the interdependent network system (global majority rule). Many other possible rules could be tested for the interdependent pairs, but we adopt here, for simplicity, the majority rule. When an opinion is shared by two interdependent individuals, such as a married couple, because their social relationship is strong and close, they will tend to maintain their opinion against outside influence. If their opinions differ initially, they tend to eventually resolve their differences and share the same opinion. In the process of resolving their differences, however, they can be significantly influenced by outside forces, e.g., mass

media, and thus we assume that they often end up sharing the majority opinion. When we increase the number of interdependent links between the coupled networks, the transition changes from a pure second order phase transition to a hybrid phase transition and finally to a seemingly abrupt transition. The hybrid transition contains both a second order and an abrupt transition. The model type of the NCO model on coupled networks also changes as the number of interdependent links increases, and thus the system goes from being a kind of nonconsensus opinion model to being a kind of consensus opinion model. This suggests that strong interactions between different social groups is pushing our world in the direction of becoming more uniform in their opinions.

The paper is organized as follows, in Sec. II we revisit some important concepts on the topology of opinion clusters and percolation. We then present the results and discussions on NCO and NCOW model in Sec. III, on ICO model in Sec. IV and on NCO model on coupled networks in Sec. V. Finally, we present our summary in Sec. VI.

## II. TOPOLOGY OF OPINION CLUSTERS AND PERCOLATION

In recent decades, many researchers have studied how network topology affects the processes that evolve in them. Examples of such processes are the spreading of rumors, opinions, diseases, and percolation [4–6, 13, 37–43]. Classical percolation processes deal with the random failure of nodes (or links) and present a geometrical second order phase transition with a control parameter  $p$  that represents the fraction of nodes (or links) remaining after a random failure of a fraction  $1 - p$  of nodes (or links).

There exists a critical probability  $p_c$  above which a “giant component” (GC) appears. The number of nodes in the GC,  $S_1$ , is called the order parameter of the phase transition. Below criticality there is no GC and only finite clusters exist. For  $p < p_c$  the size distribution of the clusters is  $n_s \sim s^{-\tau}$  with a cutoff that diverges when approaching  $p_c$ . At criticality, in the thermodynamic limit, the size of the second largest component  $S_2$  diverges at  $p_c$  as  $S_2 \sim |p - p_c|^{-\gamma}$  just as the susceptibility with the distance to the critical temperature. For large networks ( $N \rightarrow \infty$ ),  $p_c = 1/(\kappa - 1)$ , where  $\kappa$  is the branching factor given by  $\kappa = \langle k^2 \rangle / \langle k \rangle$ , where  $\langle k \rangle$  and  $\langle k^2 \rangle$  are the first and second moments of the degree distribution  $P(k)$  of the network respectively [11]. We perform all our simulations on both Erdős-Rényi (ER) networks [7–9] and scale-free (SF) networks [10]. ER networks are characterized by



a Poisson degree distribution,  $P(k) = e^{-\langle k \rangle} \langle k \rangle^k / k!$ . In SF networks the degree distribution is given by a power law,  $P(k) \sim k^{-\lambda}$ , for  $k_{\min} \leq k \leq k_{\max}$ , where  $k_{\min}$  is the lowest degree of the network and  $k_{\max}$  is the highest degree of the network. For random SF networks  $k_{\max} \sim N^{1/(\lambda-1)}$  is the degree cutoff [11], where  $N$  is the system size and  $\lambda$  is the broadness of the distribution.

We begin by examining percolation in ER networks. At criticality, percolation in ER networks is equivalent to percolation on a Cayley tree or percolation at the upper critical dimension  $d_c = 6$  where all the exponents have mean field (MF) values with  $\tau = 5/2$  and  $\gamma = 1$ . Note that in the ER case, the mass of the incipient infinite cluster  $S_1$  scales as  $N^{2/3}$  at criticality. We can understand this result by using the framework of percolation theory for the upper critical dimension  $d_c = 6$ . Since  $S_1 \sim R^{d_f}$  and  $N \sim R^d$  (where  $d$  is the dimension of the initial lattice,  $d_f$  the fractal dimension, and  $R$  the spatial diameter of the cluster), it follows that  $S_1 \sim N^{d_f/d_c}$  and since  $d_c = 6$  and  $d_f = 4$  we obtain  $S_1 \sim N^{2/3}$  [41].

For SF networks, the GC at criticality is  $S_1 \sim N^{2/3}$  for  $\lambda > 4$ , and  $S_1 \sim N^{(\lambda-2)/(\lambda-1)}$  for  $3 < \lambda \leq 4$  [44]. For SF networks, with  $\lambda < 3$ ,  $\langle k^2 \rangle \rightarrow \infty$  when  $N \rightarrow \infty$  because  $k_{\max} \rightarrow \infty$  and thus  $p_c = 0$ , making these networks extremely robust against random failures [11].

However if we decrease  $k_{\max}$  by targeting and removing the highest degree nodes (hubs),  $p_c$  is finite [45] and we recover a second order phase transition with MF exponents as for ER networks. We will show below that this is also true for our model here. A similar MF behavior in SF networks with  $\lambda < 3$  was found also by Valdez *et al.* [46] for the percolation of susceptible clusters during the spread of an epidemic. In our simulations we always choose  $k_{\min} = 2$  for SF networks in order to ensure that they are almost fully connected [11].

### III. THE NCO MODEL

In the NCO model [1] on a single network with  $N$  nodes, opinion  $\sigma_+$  and  $\sigma_-$  are initially randomly assigned to each node with a fraction of  $f$  and  $1 - f$  respectively. The basic assumption of the NCO model is that the opinion of an agent is influenced by both its own opinion and the opinions of its nearest neighbors (the agent's friends). The opinion formation rule states that at each time step, each node adopts the majority opinion, which includes *both* the opinions of its neighbors and itself. If there is a tie, the node's opinion will remain unchanged. Using this rule, each node is tested at each simulation step to see

whether its opinion has changed. All these updates are performed simultaneously and in parallel until no more changes occur and a steady state is reached.

Figure 1 demonstrates the dynamic behavior of the NCO model on a small network with nine nodes. At time  $t = 0$ , five nodes are randomly assigned opinion  $\sigma_+$  (empty circle), and the remaining four, opinion  $\sigma_-$  (solid circle). After checking the status of each node, we find that only node A belongs to a local minority with opinion  $\sigma_+$ , so at the end of this time step, node A changes its opinion to  $\sigma_-$ . At time  $t=1$  only node B belongs to a local minority, so at the end of this time step, the opinion of node B will be updated to  $\sigma_-$ . At time  $t=3$ , every node has the same opinion as its local majority, where the final nonconsensus steady state is reached.

### A. Simulation Results

In the steady state  $s_1 = S_1/N$  is the normalized size of the largest opinion  $\sigma_+$  cluster,  $s_2 = S_2/N$  is the normalized size of the second largest opinion  $\sigma_+$  cluster, and  $F$  is the normalized fraction of opinion  $\sigma_+$  nodes. Figure 2 shows plots of  $s_1$ ,  $s_2$ , and  $F$  as a function of the initial fraction  $f$  of the opinion  $\sigma_+$  nodes for both ER and SF networks. We find that due to the symmetrical status of both opinions,  $F$  is a monotonically increasing function of  $f$  with symmetry around  $f = 0.5$ . Figure 2 also shows the emergence of a second order phase transition. Note that there is a critical threshold  $f_c$ , which is characterized by the sharp peak of  $s_2$ . Below  $f_c$ ,  $s_1$  approaches zero, where only the majority opinion can form steady clusters, and above  $f_c$ ,  $s_1$  increases as  $f$  increases and a state with stable coexistence of both majority and minority opinion clusters appears. Although for both ER and SF networks  $f_c < 0.5$  as expected, ER networks have smaller values of  $f_c$  than SF networks for the same average degree  $\langle k \rangle$ . For example for SF networks with  $k_{\min} = 2$  and  $\lambda = 2.5$  where  $\langle k \rangle \approx 5.5$ ,  $f_c \approx 0.45$ , while for the same average degree  $\langle k \rangle = 5.5$ , for ER networks,  $f_c \approx 0.4$ . These differences in  $f_c$  indicate that the minorities in SF networks need more initial supports to form final steady state clusters, than minorities in ER networks. This might be understood due to the high degree nodes (hubs) of a SF network. In the NCO model a hub, because of its large number of connections, is strongly influenced by its neighbors which are with high probability of the majority opinion, and puts the minority opinion at a disadvantage. Reference [1] presents also studies of the NCO model in a two-dimensional Euclidean lattice

and of the NCO model on real-world networks.

We next present numerical simulations indicating that the phase transition observed in the NCO model is in the same universality class as regular MF percolation. Percolation in random networks (e.g., ER and SF networks with  $\lambda > 4$  for random failures or all  $\lambda$  for targeted attacks) [13, 42, 43] is obtained by MF theory, which predicts that at criticality the cluster size distribution is  $n_s \sim s^{-\tau}$  with  $\tau = 2.5$  and  $S_1 \sim N^\theta$ , where  $\theta = d_f/d_c$  with  $d_f = 4$  and  $d_c = 6$  represent the fractal and the upper critical dimension of percolation respectively and thus  $\theta = 2/3$  (See Sec. II). Figure 3(a) shows the finite cluster size distribution  $n_s$  of the  $\sigma_+$  opinion cluster as a function of  $s$  at criticality ( $f = f_c$ ). Figure 3(b) show  $S_1$  at criticality  $f_c$  as a function of  $N$  for ER and SF networks with  $\langle k \rangle = 4$  and  $\lambda = 2.5$ , respectively. Note that in both networks  $\tau \approx 2.5$  and  $\theta \approx 2/3$ . These two exponents strongly indicate that the NCO model in random networks behaves like a second order phase transition that belongs to the same universality class as regular MF percolation.

In our above results we focus on networks that have a relatively low average degree  $\langle k \rangle$ . We test the model for networks with higher average degrees. In SF networks we increase  $\langle k \rangle$  by increasing the value of  $k_{\min}$ . Figure 4 shows  $s_1$  and  $s_2$  as a function of  $f$  for different values of  $\langle k \rangle$  for ER networks and SF networks. As the values of  $\langle k \rangle$  increase, i.e., as the network becomes increasingly condensed and the number of interactions between agents increases, a sharper change of  $s_1$  at a critical threshold is observed. This may suggest (but can not be proved by simulations) the existence of a critical value  $\langle k \rangle = k_c$  that is strongly affected by the topology of the network. Below  $k_c$ , as  $\langle k \rangle$  increases,  $f_c$  shifts to the right, as can be seen from the shift of the peak of  $s_2$ . Above  $f_c$  two opinions can continue to coexist and remain stable. Above  $k_c$  the smooth second order phase transition is replaced by a sharp jump of  $s_1$  at approximately  $f = 0.5$  that is accompanied by the disappearance of the peaks of  $s_2$ . Note also that as the values of  $\langle k \rangle$  increase, the region in which two opinions coexist becomes increasingly smaller and approach zero for very large values of  $\langle k \rangle$  possibly above  $k_c$ . In terms of the NCO model, as the number of connections between individuals increase, the opinion of each individual becomes less important and each individual becomes increasingly susceptible to the influence of the majority opinion across the entire system. Thus the majority opinion can easily overwhelm the minority opinion, causing the critical behavior of the NCO model, the second-order phase transition, to disappear at large  $\langle k \rangle$  and the NCO model to converge to the majority voter model yielding a possible global consensus

throughout the system. Note that analytical arguments for an abrupt transition of the NCO model at large  $\langle k \rangle$  are given in Ref. [26].

How can one help the minority opinions to survive? As we have seen, as the number of friends of an agent increases, the importance of the agent's own opinion decreases. In this way the majority opinion gradually eliminates the minority opinion. If we generalize the NCO model by adding a weight value  $W$  to each agent's own opinion, as  $W$  of an agent increases, the influence of the opinion of the agent's neighbors decreases. We call this generalization of the NCO model the NCOW model. As in the NCO model, in the NCOW model we change an agent's opinion if he is in a local minority but we also weight the agent's own opinion  $W$  times more than its nearest neighbors. The NCO model is actually a special case of the NCOW model in which  $W = 1$ . Figure 5 shows plots of  $s_1$  and  $s_2$  as a function of  $f$  for both  $W = 1$  and  $W = 4$ . Note that as  $W$  increases, the second-order phase transition becomes flatter and the peak of the  $s_2$  shifts to the left, which indicates a smaller critical threshold  $f_c$ . The smaller value of  $f_c$  for larger values of  $W$  means that from the minority point of view, it needs fewer initial supporters to form and maintain stable finite clusters. When weight is added to the agents own opinion (indicating stubbornness) they become less susceptible to outside influence. Thus in the NCOW model the majority is aided when the agents make more friends, but the minority in turn is aided when the agents treat their own opinion as more important than their friends' opinions.

#### IV. THE ICO MODEL

The initial configuration of the inflexible contrarian opinion (ICO) model corresponds to the final steady state of the NCO model in which two opinions  $\sigma_+$  and  $\sigma_-$  coexist. At  $t = 0$  a fraction  $\phi$  of inflexible contrarians of opinion  $\sigma_-$  are introduced into clusters of  $\sigma_+$  by replacing nodes of  $\sigma_+$ . The inflexible contrarians are agents that hold a strong and unchangeable  $\sigma_-$  opinion, that theoretically could influence the  $\sigma_+$  opinion of their neighbors as the system evolves with NCO dynamics. Because the opinion held by the inflexible contrarians is unchanging, they function as a quenched noise in the network. The system evolves according to NCO dynamics until a new steady state is reached. In this steady state the agents form clusters of two different opinions above a new threshold  $f_c \equiv f_c(\phi)$ . Because the contrarians hold the  $\sigma_-$  opinion, the size of the  $\sigma_+$  clusters decreases as  $\phi$  increases.

Figure 6 demonstrates the dynamic of the ICO model. We use two different strategies to introduce a fraction  $\phi$  of inflexible contrarians. In strategy I we chose the fraction  $\phi$  of nodes with  $\sigma_+$  opinion at random. In strategy II the inflexible contrarians are chosen from the agents with  $\sigma_+$  opinion in decreasing order of their connectivity. Strategy II is thus a targeted strategy.

### A. Simulation Results

We present our simulation results for ER networks with  $\langle k \rangle = 4$  and  $N = 10^5$ . For simulation results of ICO model for SF networks see Ref. [2]. Figure 7 shows plots of  $s_1$  and  $s_2$  as a function of  $f$  for different values of  $\phi$  for strategies I and II, respectively. Note that the ICO model inherits some of the properties of the NCO model. This is the case because there is a smooth phase transition with a critical threshold  $f_c$ , where  $f_c$  is characterized by the sharp peak of  $s_2$ . However, for the ICO model,  $f_c$  is also a function of  $\phi$ . Thus we denote the new  $f_c$  in the ICO model by  $f_c(\phi)$ . We find that, as  $\phi$  increases, the critical value  $f_c(\phi)$  increases, which means that the largest cluster composed of  $\sigma_+$  agents becomes less robust due to the increase in the number of inflexible contrarians of opinion  $\sigma_-$ . Note also that for  $f > f_c(\phi)$ ,  $s_1$  decreases as  $\phi$  increases. Thus, we conclude that inflexible contrarians with opinion  $\sigma_-$  have two effects: (i) they increase the value of  $f_c(\phi)$  and thus the  $\sigma_+$  opinion needs more initial support in order to survive, and (ii) they decrease the size of the largest  $\sigma_+$  opinion cluster at  $f > f_c(\phi)$ . Note also that in the ICO model when  $\phi$  is large the largest  $\sigma_+$  cluster is fully destroyed and the second-order phase transition is lost. This is probably due to the fact that when  $\phi$  is large, minority groups do not have high degree nodes and thus their average connectivity becomes smaller than 1 and, as a consequence, will no longer be able to form stable clusters [7]. As expected (see Fig. 7) strategy II is more efficient in destroying the largest minority component. This is plausible because, when selecting the initial fraction  $\phi$  of inflexible contrarians using a targeted strategy, almost all the inflexible contrarians will be in the largest initial  $\sigma_+$  cluster since this cluster includes most of the high degree nodes. Figure 8 test this hypothesis and shows at the final stage of the NCO the ratio  $F(k)$ , which is the number of nodes within the GC of  $\sigma_+$  opinion with degree  $k$  divided by the total number of nodes of opinion  $\sigma_+$  with degree  $k$  in the entire network system, for different values of  $f$ . We find that for large values of  $k$ ,  $F(k) \rightarrow 1$ . These results support

our previous hypothesis that almost all the high degree nodes belong to the largest cluster, and this explains why strategy II is more efficient than strategy I.

We next test whether the ICO model undergoes a phase transition as a function of  $\phi$  and what its type. Figures 9(a) and 9(c) show plots of  $s_1$  as a function of  $\phi$  for different values of  $f$  for strategy I and strategy II, respectively. Figures 9(b)(top) and 9(d)(top) show plots of  $s_2$  as a function of  $\phi$  for different values of  $f$  for strategy I and strategy II, respectively. We can see that in both strategies  $s_2$  has a peak at  $\phi = \phi_c(f)$ , which is a characteristic of a second-order phase transition. Figures 9(b)(bottom) and 9(d)(bottom) further support the presence of a second order phase transition by showing plots of the derivative of  $s_1$  with respect to  $\phi$  for different values of  $f$ . Note that there is an abrupt change with  $\phi$  in  $\Delta s_1/\Delta\phi$  at the same position of the peak of  $s_2$ , suggesting that the transition is of second order. We next show that the second order phase transition has the same exponents as MF percolation. Figure 10 plots the finite cluster size distribution of  $\sigma_+$  agents,  $n_s$  as a function of  $s$  at  $f = f_c(\phi)$ , from where we obtain  $\tau = 5/2$ . From  $s_2$  we also compute the exponent  $\gamma$  and obtain  $\gamma \approx 1$  (not shown). These two exponents indicate that the ICO model on random graphs belongs to the same universality class as MF percolation.

## V. THE NCO ON COUPLED NETWORKS MODEL

Figure 11 demonstrates the dynamics of the NCO model on coupled networks. In coupled networks, the two networks represent two groups of people. The links within each network denote the relationships between nodes. For simplicity, we assume that the two networks have the same number of nodes  $N$  and the same degree distribution. We also assign these two networks the same initial opinion condition, i.e., in both networks there is initially a fraction  $f$  of nodes holding the  $\sigma_+$  opinion, and a fraction  $1 - f$  holding the  $\sigma_-$  opinion. To represent the strong social coupling between the two groups, we randomly choose a fraction  $q$  of the nodes from both networks to form  $qN$  pairs of one-to-one interdependent pairs regardless of their original opinions. At time  $t=0$ , in both networks we apply the same opinion formation rule, the NCO model, to decide whether an agent will change its opinion regardless of the interdependent links. This means that at this stage opinions propagate in each single network independently—as though the other network does not exist. All opinion updates are made simultaneously and in parallel. At  $t=1$ , if two nodes with an interdependent link

have the same opinion they keep that opinion. If they do not, they follow the majority opinion of the coupled networks (global majority rule). All interdependent agents update their opinions simultaneously at the end of this time step. We repeat these two steps until the system reaches a steady state.

### A. Simulation Results

We perform simulations of the NCO on coupled networks where both of the interdependent networks are either ER networks with  $\langle k \rangle = 4$  or SF networks with  $k_{\min} = 2$  and  $\lambda = 2.5$ . For an initial fraction  $f$  of opinion  $\sigma_+$  and a fraction  $q$  of interdependent links, the NCO on coupled networks is simulated on  $10^4$  network realizations to explore how interdependent links affect opinion dynamics.

#### 1. NCO on Coupled ER Networks

We first investigate  $s_1$  as a function of  $f$  for different values of  $q$ . Figure 12(a) shows that when  $q = 0$ , which corresponds to the NCO model on a single network, the system undergoes a second order phase transition with a critical threshold  $f_c$  [1]. When  $q > 0$ , there are two regions  $0 < q \leq 0.5$  and  $q > 0.5$ . For the region  $0 < q \leq 0.5$ , as in the NCO model on a single network, the second order phase transition still exists, but the critical value  $f \equiv f_c(q)$  is increasing with  $q$ . The value of  $f_c(q)$  can be determined by the location of the peak of  $s_2$ , which is shown in Fig. 12(b), where we plot  $s_2$  as a function of  $f$  for different values of  $q$ . The inset of Fig. 12(a) shows a plot of  $f_c(q)$  as a function of  $q$ . We find that the peak of  $s_2$  shifts to the right for  $q \leq 0.5$  as  $q$  increases, which means that  $f_c(q)$  increases as  $q$  increases. This suggests that if we add more interdependent links between the two networks, the minority opinion will need a larger initial fraction in order to exist. In the region  $0 < q \leq 0.5$  we also find that, unlike the NCO model on a single ER network, there is an abrupt change of  $s_1$  at  $f = 0.5$ , indicating that in addition to the smooth second order phase transition at  $f_c(q)$ , there may also be a discontinuous transition at  $f = 0.5$ . Our results suggest that when  $0 < q \leq 0.5$  the system may undergo a hybrid phase transition [47], which is a mixture of both an abrupt and a second order phase transition. We also find that as  $q$  increases the discontinuity around  $f = 0.5$  becomes more pronounced. Although the system possesses a

seemingly discontinuous phase transition for  $0 < q \leq 0.5$ , the model itself is still a non-consensus model, i.e., when  $f$  is above the critical value  $f_c(q)$  the two opinions coexist in a steady state. When  $q > 0.5$  the smooth second order phase transition of  $s_1$  disappears and is replaced by an abrupt transition at  $f = 0.5$ . When  $q > 0.5$  the peak of  $s_2$  disappears, supporting the loss of the second order phase transition [see Fig. 12(b)], and the system undergoes a pure abrupt transition. This suggests that when interactions between networks are sufficiently strong the hybrid phase transition is replaced by a pure abrupt transition. For all values of  $q$ , the region where two opinions can coexist decreases as  $q$  increases, and the NCO coupled networks model moves at large  $q$  toward the consensus type opinion model. To further support our finding of the existence of a discontinuous transition when  $q > 0$ , in Fig. 12(c) and its inset we plot respectively the jump of  $S_1$ ,  $\Delta S_1 = S_1(0.51) - S_1(0.49)$ , and  $\Delta S_1/N$ , around  $f = 0.5$  as a function of the system size  $N$  for different values of  $q$ . The linear relationship between  $\Delta S_1$  and  $N$  supports our assumption of the existence of a discontinuous transition around  $f = 0.5$  for all values of  $q > 0$ . Note that, as the value of  $q$  increases, the value of  $\Delta S_1$  increases, which means that as we increase the value of  $q$  the abrupt transition becomes more pronounced.

To further support our conclusions, we investigate the number of iterations (NOI), which is the number of time steps needed to reach the steady state, as a function of  $f$  for different values of  $q$ . Figure 12(d) shows a plot of the NOI as a function of  $f$  for different values of  $q$ . As described in Ref. [48], in a pure first order phase transition due to cascading failures the location of the peak of the NOI determines the critical threshold of the transition, which is the case for  $q > 0.5$  in our model. Figure 12(d) shows that there is only one peak for the NOI curves for  $q > 0.5$  at  $f = 0.5$ , which is the position of the critical threshold of the abrupt transition. In the hybrid phase transition for  $q \leq 0.5$ , the relation between the peak of the NOI and the critical threshold is unclear because there are two critical thresholds, one for the discontinuous transition at  $f = 0.5$  and the other for the second order phase transition at  $f_c(q)$ . Figure 12(d) shows that when  $q < 0.5$  the NOI exhibits two symmetric peaks. The inset of Fig. 12(d) shows a plot of the location of the left peaks of the NOI as a function of  $q$ . Comparing the insets in Fig. 12(a) and Fig. 12(d), we find that the curve of the peak locations of the NOI is always above the  $f_c(q)$  curve, which suggests that for a hybrid phase transition the peak of the NOI is located between the critical thresholds of the second order phase transition and the abrupt transition.



Figure 13 shows a log-log plot of the NOI at  $f = 0.5$  as a function of the system size  $N$  for different values of  $q$ , and the inset of Fig. 13 shows the same in a log-linear plot. The accuracy of the simulations is such that we cannot distinguish the relationship between exponential and logarithmic. However, the increase of NOI with system size indicates that there is a real jump at approximately  $f = 0.5$  rather than a finite size effect. This supports our previous conjecture that for all values of  $q > 0$ , the NCO on coupled networks exhibits an abrupt transition at  $f = 0.5$ .

We next present results indicating that, when  $q \leq 0.5$  and when  $f$  is close to  $f_c(q)$ , our model is in the same universality class as regular MF percolation, even though a discontinuity appears at larger  $f$ . For regular percolation on random graphs at criticality, the cluster sizes follow a power law distribution,  $n_s \sim s^{-\tau}$  with  $\tau = 2.5$  [13, 42, 43]. Figure 14 shows a plot of  $n_s$  as a function of  $s$  for finite  $\sigma_+$  clusters at criticality,  $f_c(q)$ . We see that for  $q \leq 0.5$ ,  $\tau \approx 2.5$ , and for  $q > 0.5$ , the power law no longer holds. The exponent values we obtain strongly indicate that, for small value of  $q$ , the NCO model on coupled ER networks close to  $f_c$  is in the same universality class as mean field percolation in random networks. The power law for the cluster size distribution at  $q > 0.5$  disappears, so we conclude that the NCO coupled networks model changes the phase transition type as  $q$  increases from  $q \leq 0.5$  to  $q > 0.5$ .

## 2. NCO on Coupled SF Networks

Empirical studies show that many real-world social networks are not ER. They instead exhibit a SF degree distribution [10] in which  $P(k) \sim k^{-\lambda}$  and  $\lambda$  characterize the broadness of the distribution. A feature of SF is the existence of hubs, i.e., very high degree nodes. These large hubs make the opinion dynamic processes in SF networks much more efficient than in ER networks [49–54].

Because of its large number of connections, a hub in the NCO model tends to follow the opinion of the majority and effectively influence the opinions of its neighbors. In a SF network the hubs help the majority dominate the minority, and thus the NCO model on a single SF network has a larger  $f_c$  and exhibits a much sharper jump around  $f_c$  than in ER networks with the same average degree [1]. This is also the case in interdependent SF networks. Figures 15(a), 15(b), and 15(c) depict  $s_1$ ,  $s_2$ , and NOI as a functions of  $f$  for

different values of  $q$ , respectively. The results of the NCO model on coupled SF networks are similar to those of coupled ER networks, except that the region of the hybrid phase transition is much smaller in coupled SF networks. This is confirmed by the fact that the peak of  $s_2$  drops much faster for small  $q$  values and that the single peak of NOI shows up at smaller  $q$  values for coupled SF networks in contrast to the case of coupled ER networks. This indicates that the pure abrupt phase transition occurs at smaller  $q$  values in coupled SF networks compared to coupled ER networks, which suggests that in coupled SF networks a smaller number of interdependent agents are needed to achieve a consensus state compared to coupled ER networks. Figure 16 shows a plot of  $n_s$  as a function of  $s$  for finite  $\sigma_+$  clusters at criticality. Note that in SF networks when  $q \leq 0.1$  the  $n_s$  decays as a power law with  $\tau = 2.5$ , and when  $q > 0.1$  the power law decay of  $n_s$  no longer holds. This suggests that only for small values of  $q$  our NCO model on coupled SF networks is in the same universality class as regular MF percolation. Comparing Fig. 16 with Fig. 14, we find that the power law decay disappears at smaller  $q$  values in coupled SF networks compared to coupled ER networks. This supports our hypothesis that interdependent links push the entire system to an abrupt phase transition more effectively in coupled SF networks than in coupled ER networks.

In both coupled ER and SF networks, our non-consensus opinion second order phase transition model is transformed into a consensus opinion type abrupt transition model when the number of interdependent links is increased. This suggests that increasing the interactions between different groups in our world will push humanity to become increasingly homogeneous, i.e., interdependent pairs in the NCO coupled networks model helps the majority opinions supporters to eliminate the minority opinion, making uniformity (consensus) a possible final result.

## VI. SUMMARY

In this paper we revisit and extended the non-consensus opinion (NCO) model, introduced by Shao et al. [1]. We introduce the NCOW model in which each node's opinion is given a weight  $W$  to represent the nodes' resistance to opinion changes. We find that in both the NCO and the NCOW models the size of the largest minority cluster with  $\sigma_+$  opinion undergoes a second order MF percolation transition in which the control parameter is  $f$ . The

NCOW model is more robust than the NCO model because the weighted nodes reinforce the largest  $\sigma_+$  minority cluster, and shift the critical value  $f_c$  to values lower than those found in the NCO model. We also show that when the average network degree  $\langle k \rangle$  in the NCO model is increased, the second order phase transition is replaced by an abrupt transition, making the NCO model converge to a consensus type opinion model. We also review another non-consensus opinion model, the ICO model [2], which introduces into the system, using both random and targeted strategies, a fraction  $\phi$  of inflexible contrarians (which act as quenched noise). As  $\phi$  increases, both random and targeted strategies reduce the size of the largest  $\sigma_+$  cluster and, above a critical threshold  $\phi = \phi_c$ , the largest  $\sigma_+$  cluster disappears and the second order phase transition is also lost. The targeted strategy is more efficient in eliminating the largest  $\sigma_+$  cluster or decreasing its size. This is due to the fact that the contrarians are introduced (targeted) mainly into the largest cluster, which contains most of the high degree nodes. Thus a smaller  $\phi_c$  value is needed to eliminate the largest cluster of minority in the targeted strategy compared to the random strategy. We also study an opinion model in which two interdependent networks are coupled by a fraction  $q$  of interdependent links. The internal dynamics within each network obey the NCO rules, but the cross-network interdependent nodes, when their opinions differ, obey the global majority rule. These interdependent links force the system from a second order phase transition, characteristic of the NCO model on a single network, to a hybrid phase transition, i.e., a mix of a second order transition and an abrupt transition. As the fraction of interdependent links increases, the system evolves to a pure abrupt phase transition. Above a certain value of  $q$ , which is strongly dependent on network topology, the interdependent link interactions push the non-consensus opinion model to a consensus opinion model. Because scale free networks have large hubs, the effect of interdependent links is more pronounced in interdependent scale free networks than in interdependent Erdős Rényi networks. We are investigating whether the same effect appears in other opinion models of interdependent networks. The results will be presented in a future paper.

We acknowledge support from the DTRA, ONR, NSF CDI program, the European EPI-WORK, LINC and MULTIPLEX projects, the Israel Science Foundation, the PICT 0293/00

and UNMdP, NGI and CONGAS.

---

- [1] J. Shao *et al.*, Phys. Rev. Lett. **103**, 01870 (2009).
- [2] Q. Li *et al.*, Phys. Rev. E. **84**, 066101 (2011).
- [3] C. Castellano, S. Fortunato, and V. Loreto, Rev. Mod. Phys. **81**, 591 (2009).
- [4] S. Boccaletti, V. Latora, Y. Moreno, M. Chavez, and D. Hwang, Physics Reports **424**, 175 (2006).
- [5] S. N. Dorogovtsev and J. F. F. Mendes, *Evolution of Networks* (Oxford University Press, Oxford, 2003).
- [6] R. Pastor-Satorras and A. Vespignani, *Evolution and Structure of the Internet: A Statistical Approach* (Cambridge University Press, Cambridge, 2004).
- [7] P. Erdős and A. Rényi, Publications of the Mathematical Institute of the Hungarian Academy of Science **5**, 17 (1960).
- [8] P. Erdős and A. Rényi, A. I. Publ. Math. **6**, 290 (1959).
- [9] B. Bollobás, *Random Graphs* (Academic Press, London, 1985).
- [10] R. Albert and A.-L. Barabási, Reviews of Modern Physics **74**, 47–97 (2002).
- [11] R. Cohen *et al.*, Phys. Rev. Lett. **85**, 4626 (2000).
- [12] A.-L. Barabási and R. Albert, Science **286**, 509 (1999).
- [13] R. Cohen and S. Havlin, *Complex Networks: Structure, Robustness and Function* (Cambridge University Press, Cambridge, 2010).
- [14] M. Newman, *Networks: An Introduction* (Oxford University Press, Oxford, 2010).
- [15] S. Galam, Europhys. Lett. **70**, 705 (2005).
- [16] K. Sznajd-Weron and J. Sznajd, Int. J. Mod. Phys. C **11**, 1157 (2000).
- [17] T. M. Liggett, *Stochastic Interacting Systems: Contact Voter, and Exclusion Processes* (Springer, Berlin, 1999).
- [18] R. Lambiotte and S. Redner, Europhys. Lett. **82**, 18007 (2008).
- [19] S. Galam, Eur. Phys. J. B **25**, 403 (2002).
- [20] P. L. Krapivsky and S. Redner, Phys. Rev. Lett. **90**, 238701 (2003).
- [21] B. Latané, Am. Psychol **36**, 343 (1981).
- [22] A. Nowak *et al.*, Psychol. Rev. **97**, 362 (1990).

- [23] J. Shao, S. Havlin, and H. E. Stanley, Phys. Rev. Lett. **109**, 079802 (2012).
- [24] A. Sattari, M. Paczuski, and P. Grassberger, Phys. Rev. Lett. **109**, 079801 (2012).
- [25] D. ben-Avraham, Phys. Rev. E. **83**, 050101 (2011).
- [26] C. P. Roca, M. Draief, and D. Helbing, arXiv:1101.0775v1 (2011).
- [27] S. Galam, arXiv:0803.2453v1 (2008).
- [28] S. Galam, Physica A **333** 453–460 (2004).
- [29] S. V. Buldyrev, R. Parshani, G. Paul, H. E. Stanley, and S. Havlin, Nature **464**, 1025 (2010).
- [30] R. Parshani, S. V. Buldyrev, and S. Havlin, Phys. Rev. Lett. **105**, 048701 (2010).
- [31] J. Gao, S. V. Buldyrev, S. Havlin, and H. E. Stanley, Phys. Rev. Lett. **107**, 195701 (2011).
- [32] J. Gao, S. V. Buldyrev, H. E. Stanley, and S. Havlin, Nature Physics **8**, 40–48 (2012).
- [33] W. Li, A. Bashan, S. V. Buldyrev, H. E. Stanley, and S. Havlin, Phys. Rev. Lett. **108**, 228702 (2012).
- [34] A. Bashan *et al.*, arXiv:1206.2062v1 (2012).
- [35] E. A. Leicht and R. M. D’Souza, arXiv:0907.0894v1 (2009).
- [36] C. D. Brummitt, R. M. D’Souza and E. A. Leicht, Proc. Natl. Acad. Sci. USA **109**, 680 (2012).
- [37] R. Paster-Satorras and A. Vespignani, Phys. Rev. Lett. **86**, 3200–3203 (2001).
- [38] O. Givan, N. Schwartz, A. Cygelberg and L. Stone, Journal of Theoretical Biology **288**, 21–28 (2011).
- [39] M. Kitsak, L. K. Gallos, S. Havlin, F. Liljeros, L. Muchnik, H. E. Stanley, and H. A. Makse, Nature Physics **6**, 888–893 (2010).
- [40] R. Cohen, S. Havlin and D. ben-Avraham, Phys. Rev. Lett. **91**, 247901 (2003).
- [41] L. A. Braunstein, S. V. Buldyrev, R. Cohen, S. Havlin, and H. E. Stanley, Phys. Rev. Lett. **91**, 168701 (2003).
- [42] A. Bunde and S. Havlin, *Fractals and Disordered Systems* (Springer-Verlag, Berlin, 1994).
- [43] D. Stauffer and A. Aharony, *Introduction to Percolation Theory* (Taylor & Francis, New York, 2003).
- [44] R. Cohen, D. Ben-Avraham, and S. Havlin, Phys. Rev. E. **66**, 036113 (2002).
- [45] R. Cohen, K. Erez, D. ben-Avraham, and S. Havlin, Phys. Rev. Lett. **86**, 3682 (2001).
- [46] L. D. Valdez, P. A. Macri, and L. A. Braunstein, Phys. Rev. E **85**, 036108 (2012).
- [47] G. J. Baxter, S. N. Dorogovtsev, A. V. Goltsev, and J. F. F. Mendes, Phys. Rev. E **82**, 011103 (2010).

- [48] R. Parshani, S. V. Buldyrev, and S. Havlin, Proc. Natl. Acad. Sci. USA **108** 1007–1010 (2011).
- [49] R. Pastor-Satorras and A. Vespignani, Phys. Rev. Lett. **86**, 3200 (2001).
- [50] E. López *et al.*, Phys. Rev. Lett. **94**, 248701 (2005).
- [51] Z. Wu *et al.*, Phys. Rev. E **71**, 045101(R) (2005).
- [52] A. E. Motter, Phys. Rev. Lett. **93**, 098701 (2004).
- [53] G. Korniss, Phys. Rev. E **75**, 051121 (2007).
- [54] M. Boguñá and D. Krioukov, Phys. Rev. Lett. **102**, 058701 (2009).

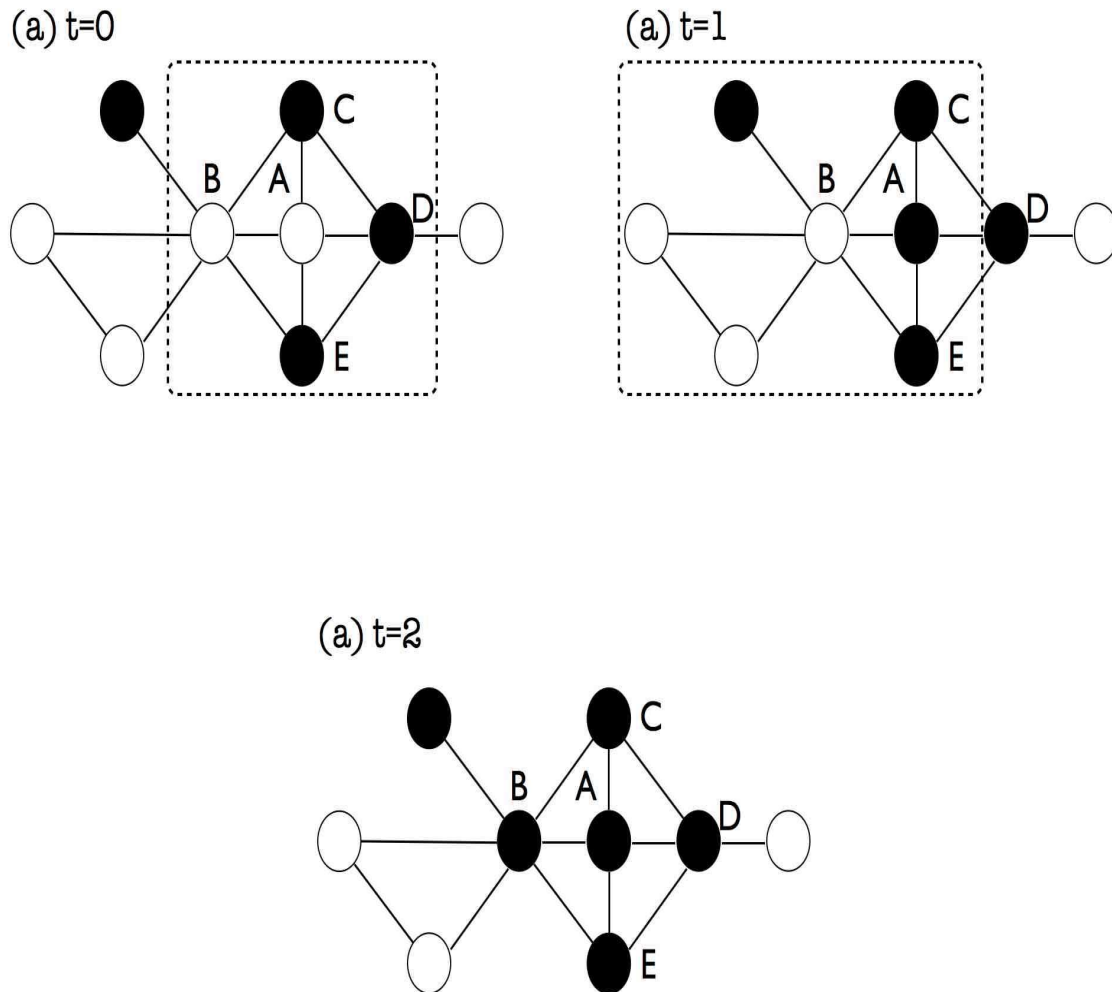

FIG. 1: Dynamics of the NCO model showing the approach to a stable state on a network with  $N = 9$  nodes. (a) At  $t=0$ , five nodes are randomly assigned to be  $\sigma_+$  (empty circle), and the remaining four nodes are assigned with  $\sigma_-$  (solid circle). In the set comprising of node  $A$  and its 4 neighbors (dashed box), node  $A$  is in a local minority opinion, while the remaining nodes are not. Thus at the end of this simulation step, node  $A$  is converted into  $\sigma_-$  opinion. (b) At  $t=1$ , in the set of nodes comprising node  $B$  and its 6 neighbors (dashed box), node  $B$  becomes in a local minority opinion, while the remaining nodes are not. Thus, node  $B$  is converted into  $\sigma_-$  at the end of simulation step  $t = 1$ . (c) At,  $t = 2$ , the nine nodes system reaches a stable state.

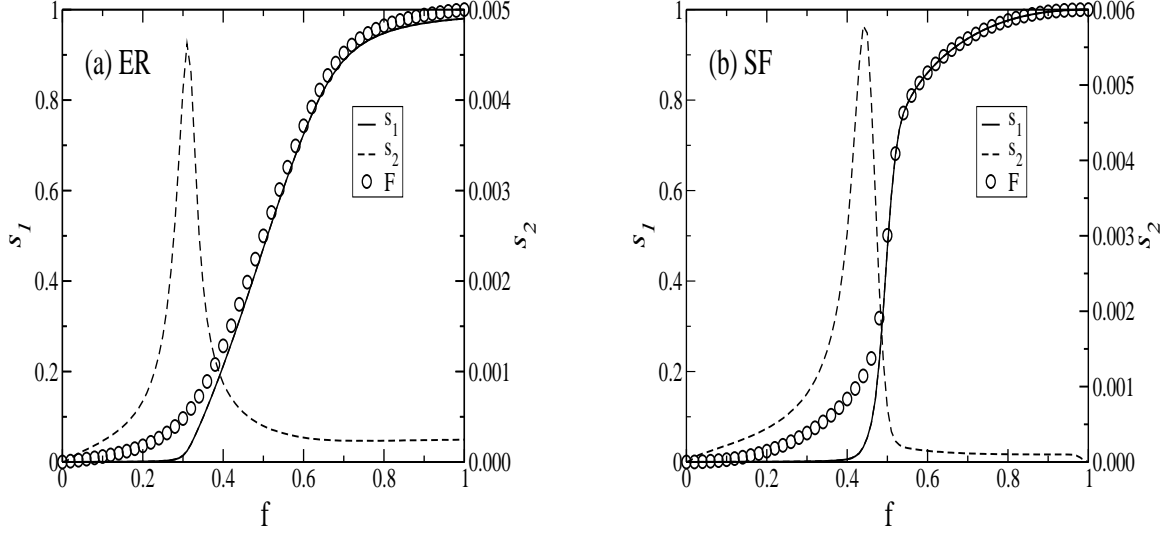

FIG. 2: Plots of  $s_1$ ,  $s_2$  and  $F$  of opinion  $\sigma_+$  as a function of  $f$  with network size  $N = 10000$ , for (a) ER networks with  $\langle k \rangle = 4$  and (b) SF networks with  $\lambda = 2.5$  and  $k_{\min} = 2$ . All simulations were done for  $10^4$  networks realizations.



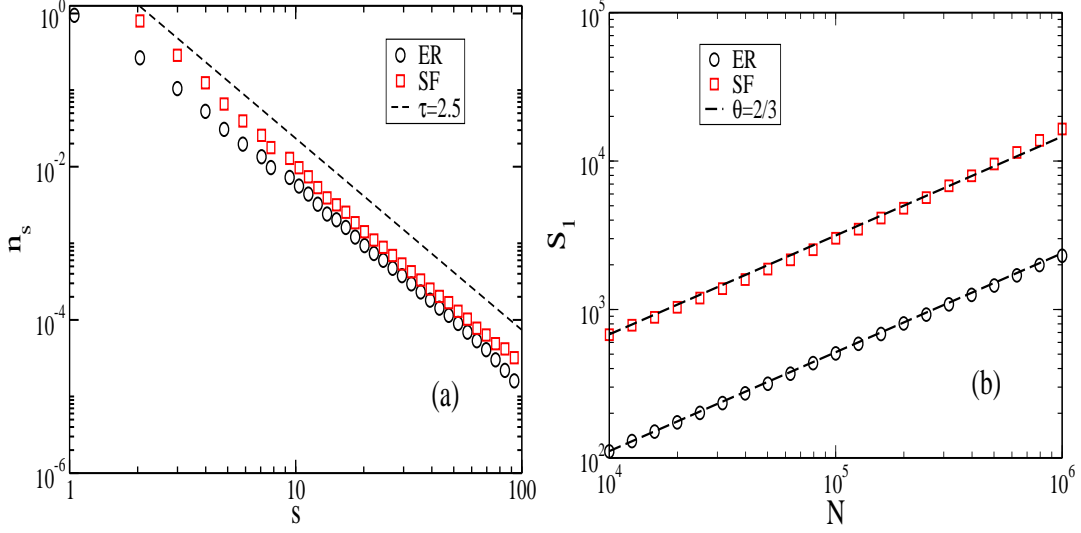

FIG. 3: (a) Plots of  $n_s$  as a function of  $s$  at criticality for ER networks with  $\langle k \rangle = 4$  and SF networks with  $\lambda = 2.5$  and  $k_{\min} = 2$ . The dashed line is a guide to show that the slope obtained is  $\tau = 2.5$ . (b) Plots of  $S_1$  as a function of  $N$  at criticality for ER networks with  $\langle k \rangle = 4$  and SF networks with  $\lambda = 2.5$  and  $k_{\min} = 2$ . The dashed lines are guides to show that the slope obtained is  $\theta \approx 2/3$ . All simulations were done for  $N = 10000$  and over  $10^4$  networks realizations.

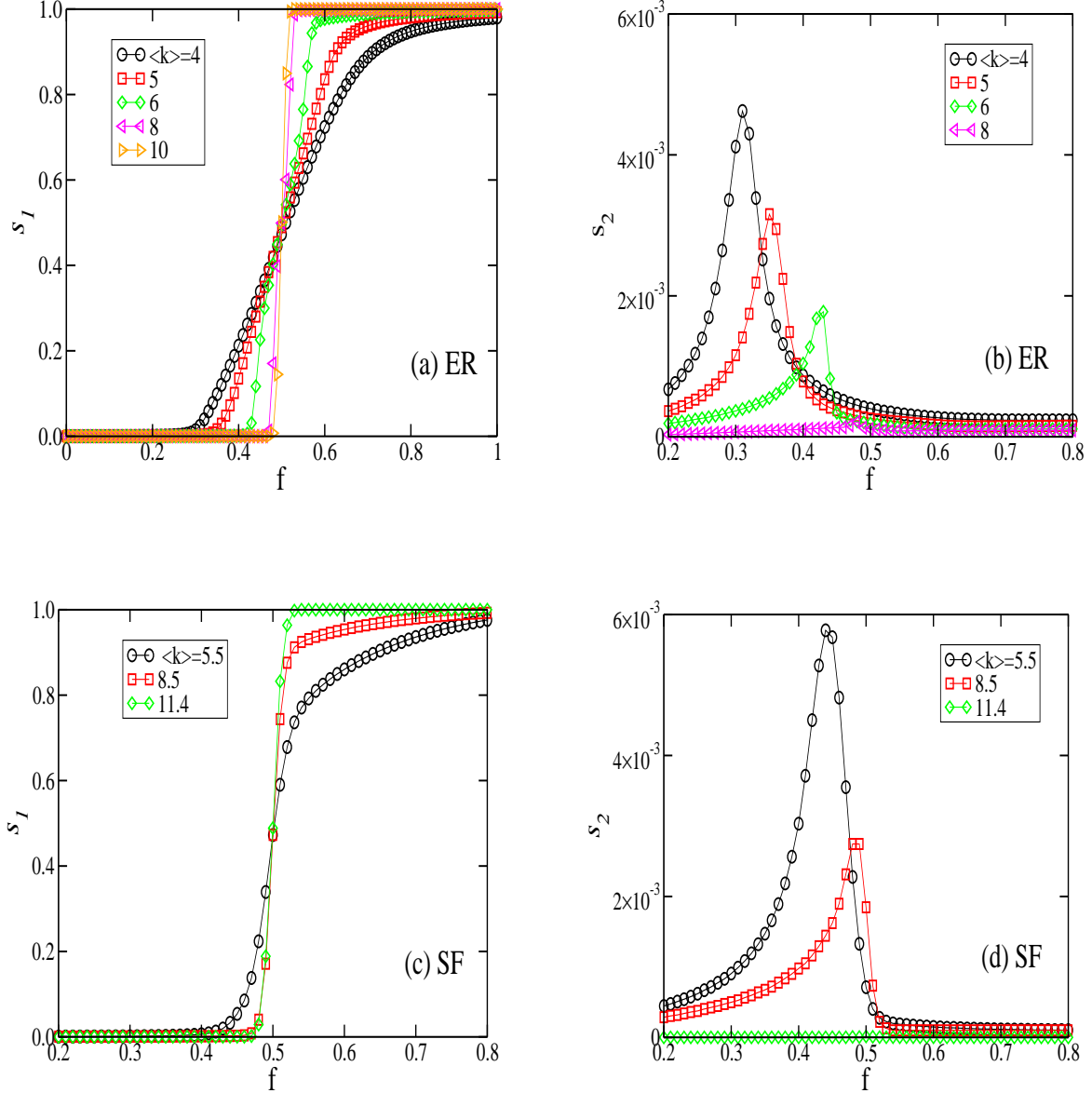

FIG. 4: Plots of (a)  $s_1$  and (b)  $s_2$  of opinion  $\sigma_+$  as a function of  $f$  for ER networks with different values of  $\langle k \rangle$  for  $N = 10000$ . (c)  $s_1$  and (d)  $s_2$  of opinion  $\sigma_+$  as a function of  $f$  for SF networks with different values of  $\langle k \rangle$  for  $N = 10000$  and  $\lambda = 2.5$ . The solid lines are guides for the eyes. All simulations were done for  $10^4$  networks realizations.

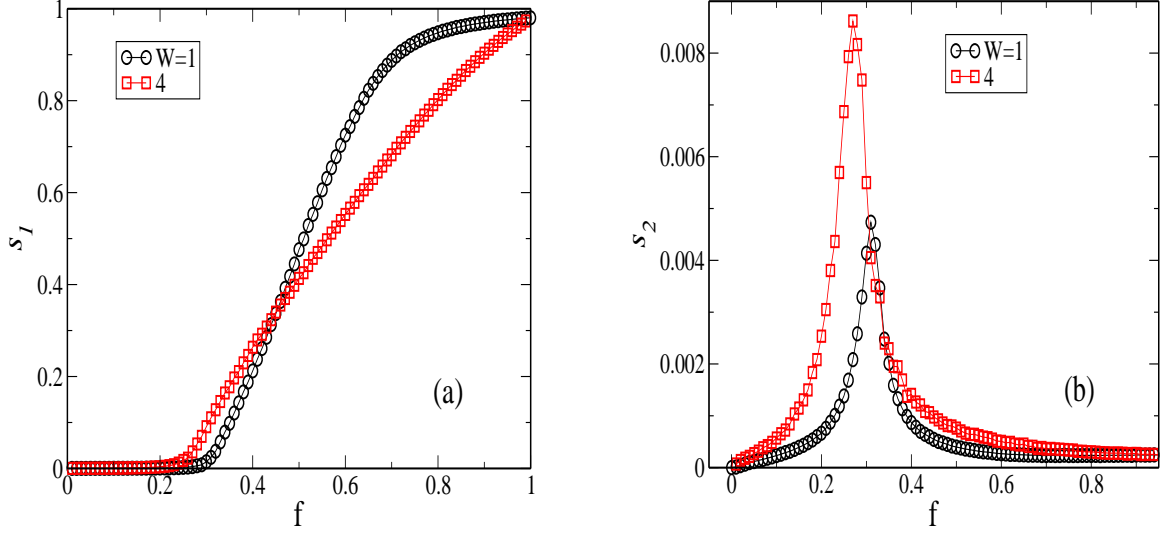

FIG. 5: Plots of (a)  $s_1$  and (b)  $s_2$  of opinion  $\sigma_+$  as a function of  $f$ , for ER networks with different values of  $W$  for  $\langle k \rangle = 4$ . The solid lines are guides for the eyes. All simulations were done with  $N = 10000$  and for  $10^4$  networks realizations.

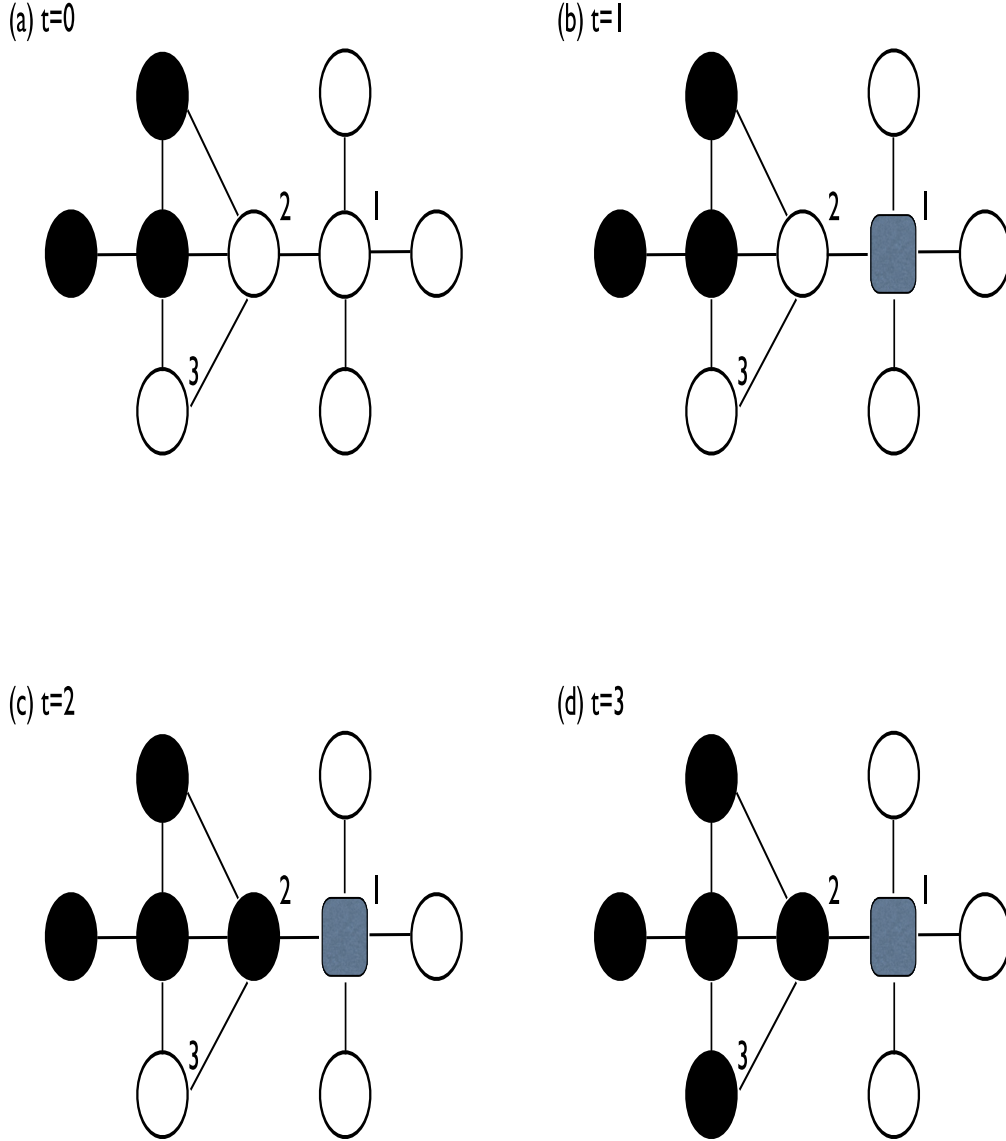

FIG. 6: Schematic plot of the dynamics of the ICO model showing the approach to a stable state on a network with  $N = 9$  nodes. (a) At  $t = 0$ , we have a stable state where opinion  $\sigma_+$  (open circle) and opinion  $\sigma_-$  (filled circle) coexist. (b) At  $t = 1$ , we change node 1 into a inflexible contrarian (filled square), which will hold  $\sigma_-$  opinion. Node 2 is now in a local minority opinion while the remaining nodes are not. Notice that node 1 is an inflexible contrarian and even if he is in the local minority he will not change his opinion. At the end of this simulation step, node 2 is converted into  $\sigma_-$  opinion. (c) At  $t = 2$ , node 3 is in a local minority opinion and therefore will be converted into  $\sigma_-$  opinion. (d) At  $t = 3$ , the system reaches a stable state where the system breaks into four disconnected clusters, one of them composed of six  $\sigma_-$  nodes and the other three with one  $\sigma_+$  node.

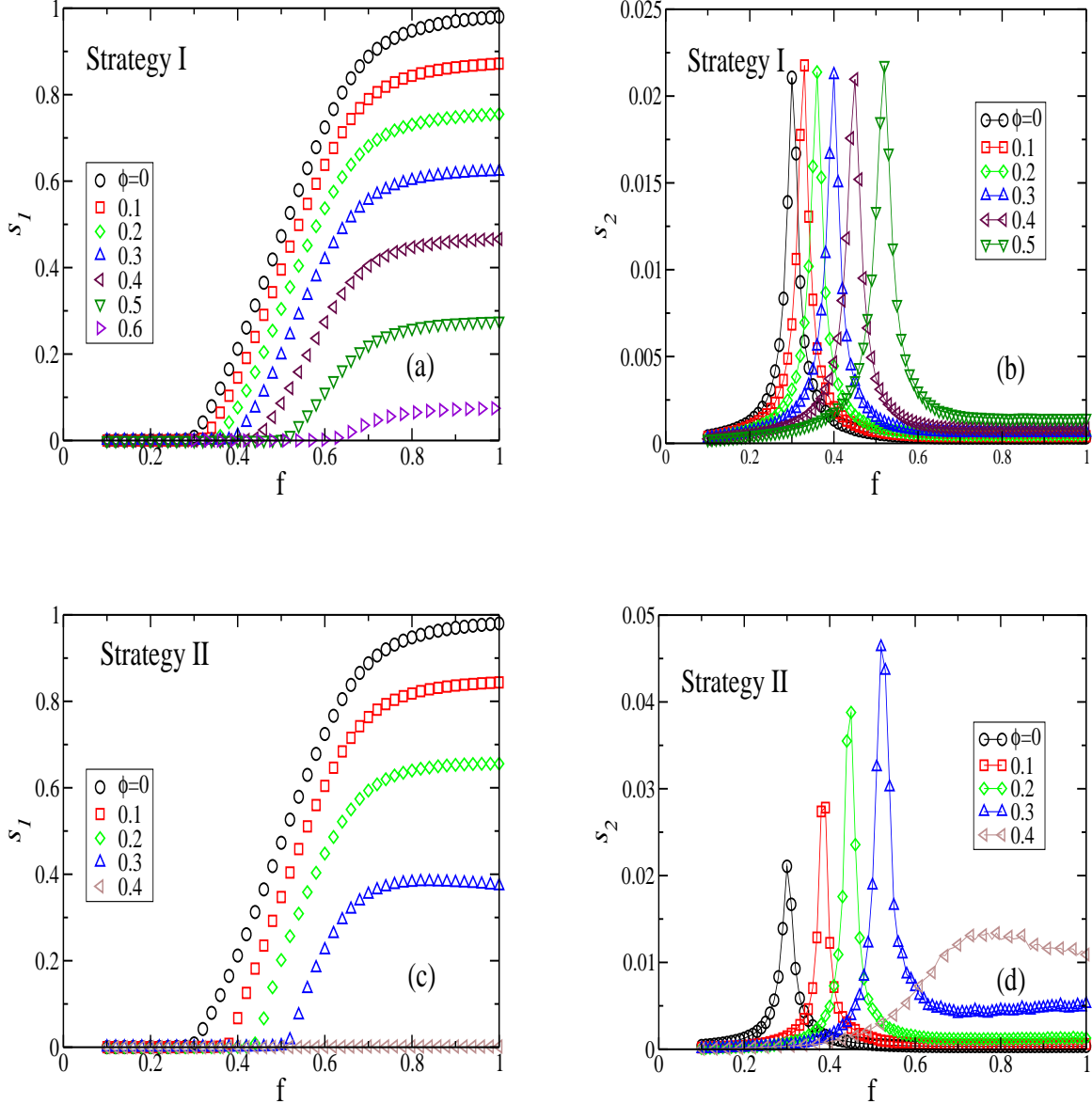

FIG. 7: For ER networks with  $\langle k \rangle = 4$ , plots of (a)  $s_1$  and (b)  $s_2$  as a function of  $f$  for different values of  $\phi$  under strategy I. Plots of (c)  $s_1$  and (d)  $s_2$  as a function for  $f$  for different values of  $\phi$  under strategy II. The solid lines in  $s_2$  are guides for the eyes. All simulations were done with  $N = 10000$  and  $10^4$  network realizations.

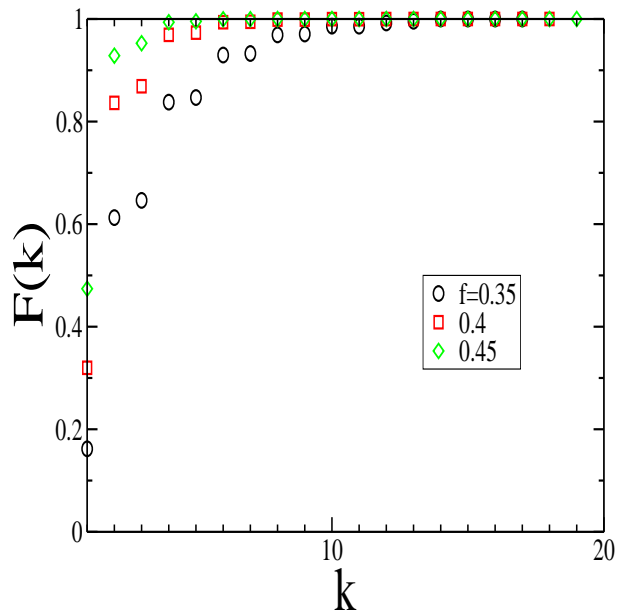

FIG. 8:  $F(k)$  as a function of  $k$  for different values of  $f$  for ER networks with  $\langle k \rangle = 4$ . We can see that as  $f$  increases  $F(k) \rightarrow 1$  for smaller values of  $k$ . All simulations were done with  $N = 10000$  and  $10^4$  network realizations.

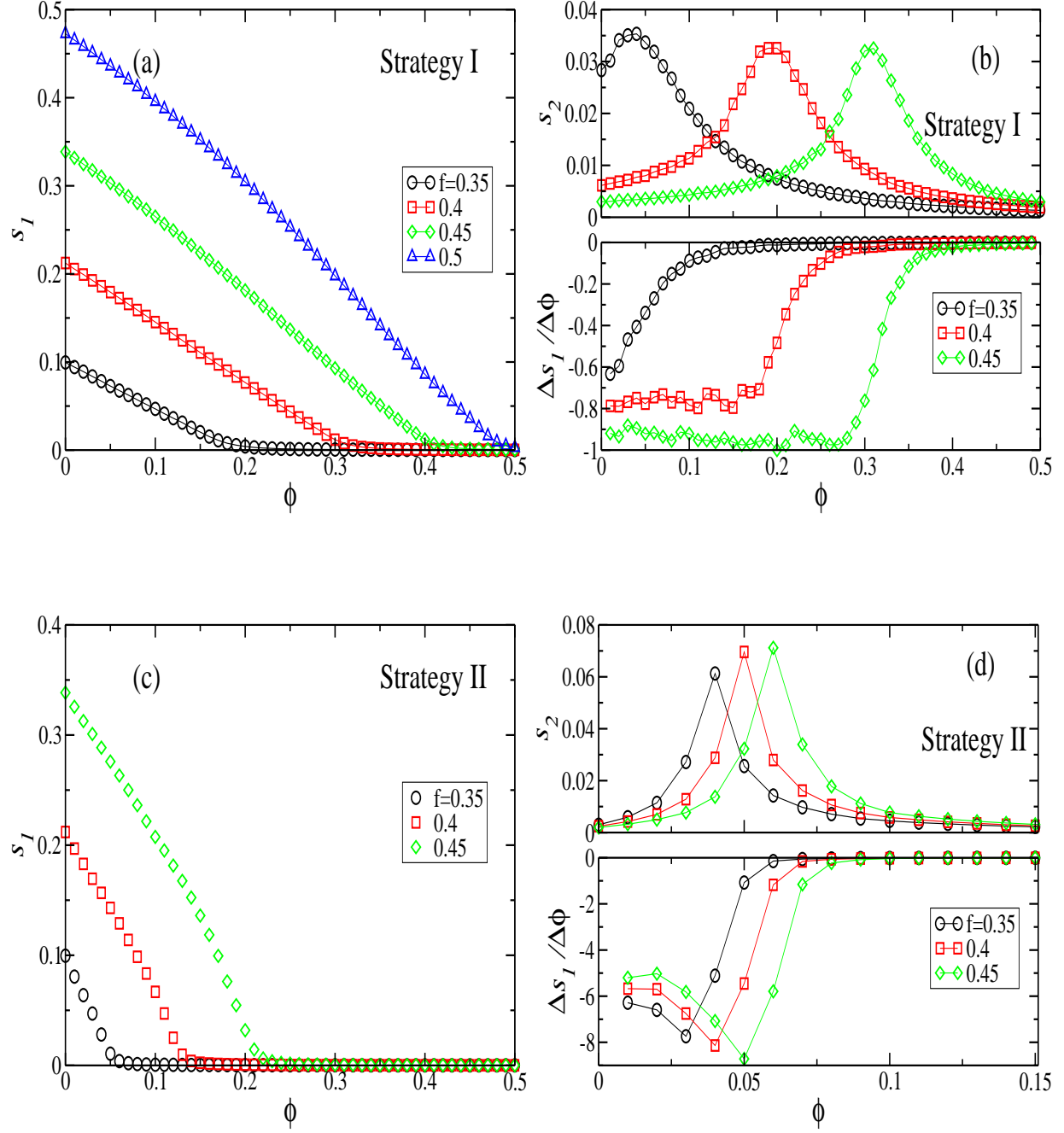

FIG. 9: For ER networks with  $\langle k \rangle = 4$ , plots of (a)  $s_1$  (b)(top)  $s_2$  and (b)(bottom)  $\Delta s_1 / \Delta \phi$  as a function of  $\phi$  for different values of  $f$  under strategy I. Plot of (c)  $s_1$ , (d)(top)  $s_2$  and (d)(bottom)  $\Delta s_1 / \Delta \phi$  as a function of  $\phi$  for different values of  $f$  under strategy II. The solid lines in  $s_2$  and  $\Delta s_1 / \Delta \phi$  are guides for the eyes. All simulations were done with  $N = 10000$  and  $10^4$  network realizations.

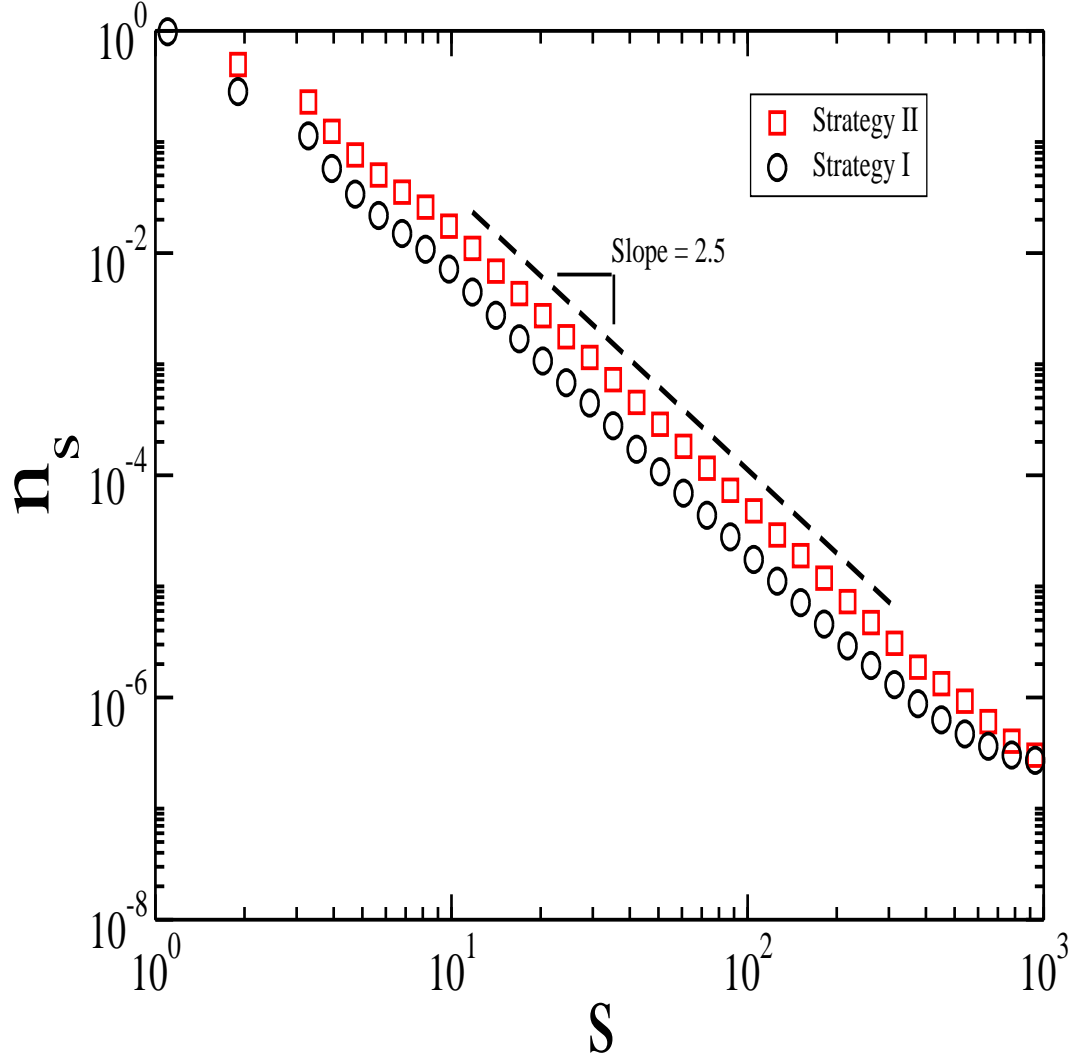

FIG. 10: Plots of  $n_s$  as a function of  $s$  for both strategies at  $f_c(\phi)$ . For the random strategy,  $f_c(\phi) = 0.36$  and for the targeted strategy,  $f_c(\phi) = 0.45$  when  $\phi = 0.2$ . The dashed line is a guide to show that the slope obtained is  $\tau \approx 5/2$ . All simulations were done with  $N = 10000$  and  $10^4$  network realizations.



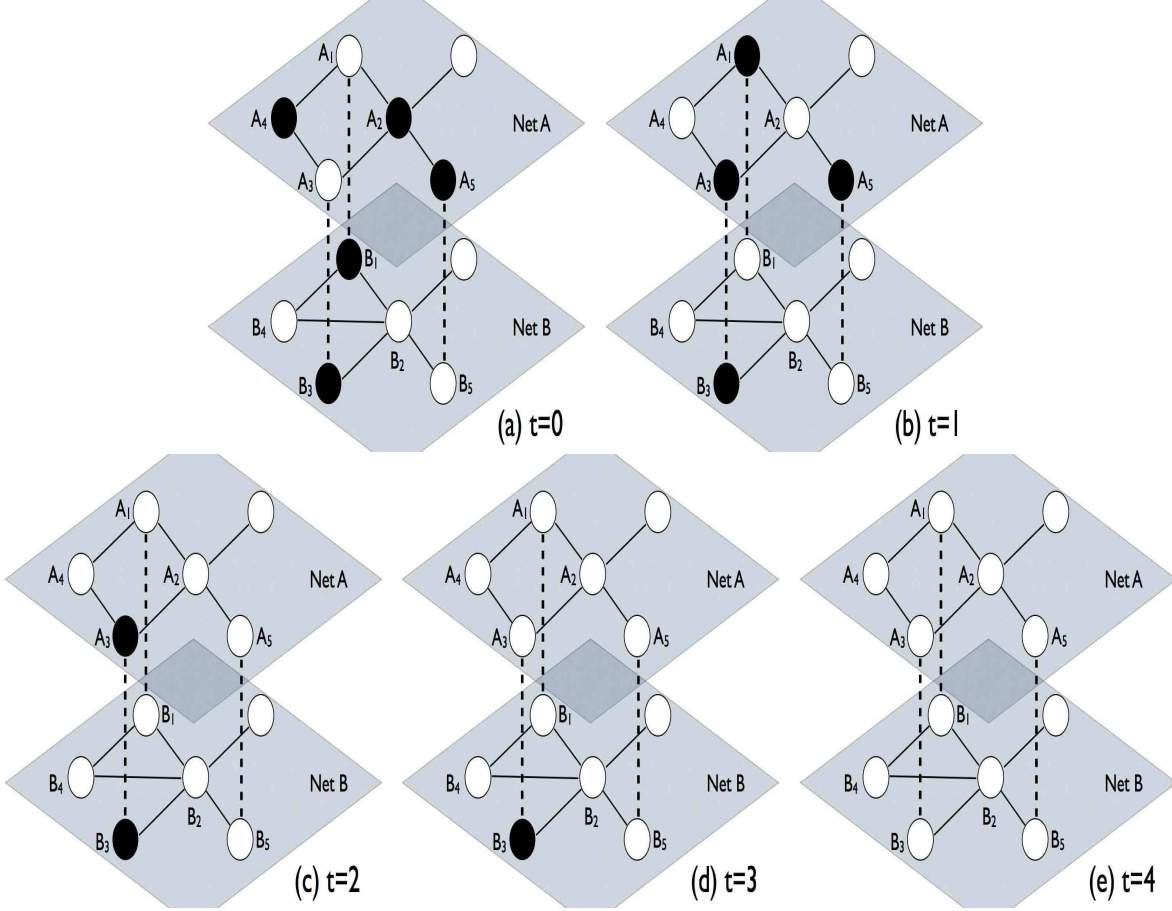

FIG. 11: (Color online) Schematic plot of the dynamics of the NCO on coupled networks showing the approach to a stable state on a system of interdependent networks  $A$  and  $B$  with  $N = 6$  nodes in each network. Open circles represent opinion  $\sigma_+$  and solid circles represent opinion  $\sigma_-$ . The solid lines connecting nodes in each network are connectivity links within the networks, and the dashed lines connecting nodes from two networks are interdependent links. In the initial state, each node is randomly assigned with opinion  $\sigma_+$  or  $\sigma_-$ . (a) At  $t=0$ , opinion dynamics evolve within each single network. In networks  $A$  and  $B$ , nodes  $A_1, A_2, A_3, A_4$  and  $B_1$  are in a local minority opinion within their network, so at the end of this time step these nodes will change their opinions. The remaining nodes will keep their opinions. (b) At  $t=1$ , the two networks interact through the interdependent links. Notice that the global majority opinion is  $\sigma_+$  now. Thus, the pairs  $A_1 - B_1$  and  $A_5 - B_5$  where two nodes have different opinions, will follow the global majority opinion. So at the end of this time step nodes  $A_1$  and  $A_5$  will change their opinions. The pair  $A_3 - B_3$ , remains as  $\sigma_-$  since both nodes share the same opinion. (c) At  $t=2$ , in network  $A$ , node  $A_3$  is in a local minority, so at the end of the time step it will change opinion. (d) At  $t=3$ , the two networks interact through the interdependent links. Notice that the global majority opinion is still  $\sigma_+$ , the only pair with different opinion is  $A_3 - B_3$ , so at the end of this time step,  $B_3$  will change its opinion. (e) At  $t=4$ , the interdependent networks reach a stable state and no more changes will

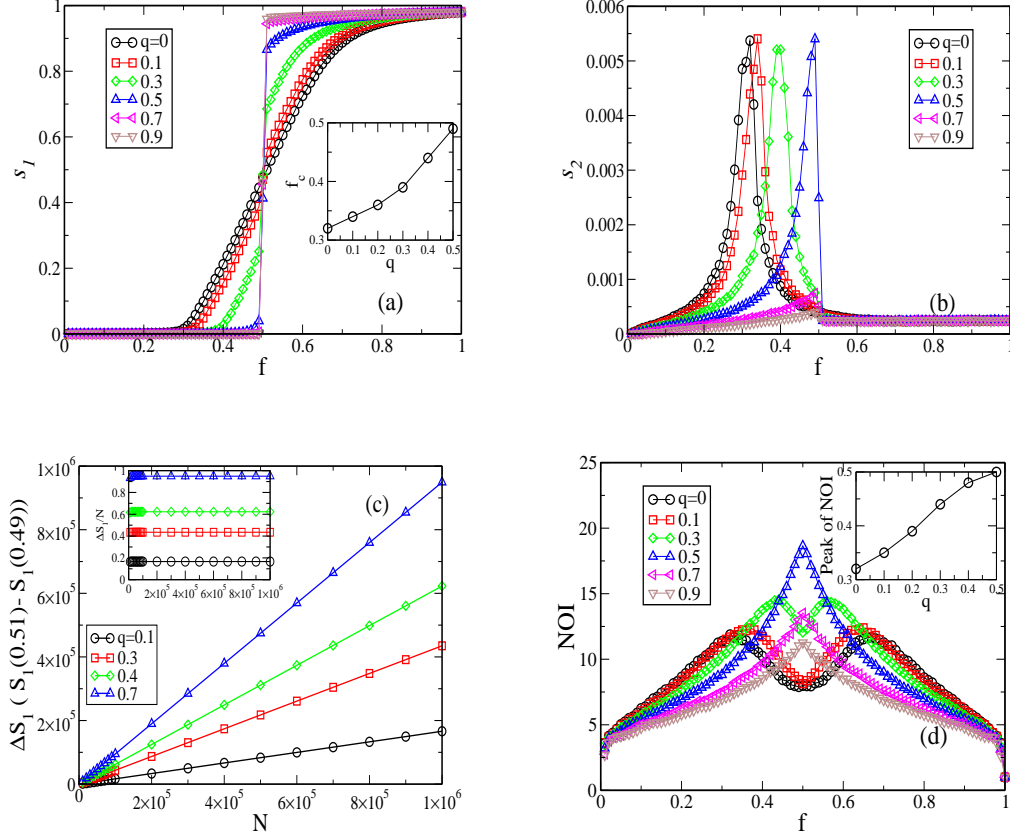

FIG. 12: Plots of NCO on coupled ER networks, with  $\langle k_A \rangle = \langle k_B \rangle = 4$  and for each network  $N = 10000$ . (a) Plot of  $s_1$  of opinion  $\sigma_+$  as a function of  $f$  for several values of  $q$ . As seen, when  $q = 0$ , the system undergoes a smooth second order phase transition (regular NCO model). As  $q$  increases until  $q = 0.5$ , it becomes a hybrid phase transition, which contains both a smooth second order type and a seemingly abrupt jump, *i.e.*,  $s_1$  changes smoothly close to  $f_c(q)$  and followed by a sharp jump at  $f = 0.5$ . When  $q$  is further increased ( $q > 0.5$ ), the smooth phase transition disappears, the system undergoes a pure abrupt phase transition. In the inset of (a) we plot  $f_c$  as a function of  $q$ . (b) Plot of  $s_2$  as a function of  $f$  for different values of  $q$ . As seen, when  $q$  increases, the peaks of the  $s_2$ , which characterize the critical threshold value of the second order phase transition, shift to the right. We can see that beyond  $q = 0.5$ , the peak of  $s_2$  disappears, which indicates that there is no second order phase transition. (c) Plot of the change of  $S_1$  around  $f = 0.5$ ,  $\Delta S_1$ , as a function of system size  $N$  for different values of  $q > 0$ . In the inset of (c), we plot  $\Delta S_1/N$  as a function of  $N$  for different values of  $q$ . The linear relationship between  $\Delta S_1$  and  $N$  suggests that for  $q > 0$ , around  $f = 0.5$ , there exists a discontinuous transition. (d) Plot of the number of cascading steps (NOI) of the networks as a function of  $f$  for different values of  $q$ . As seen there are two peaks for each  $q$  value for  $q < 0.5$ , and for  $q \geq 0.5$  there is only one peak at  $f = 0.5$ . In the inset of (d), plot of the location of NOI peak as a function of  $q$ . The solid lines are guides for the eyes.

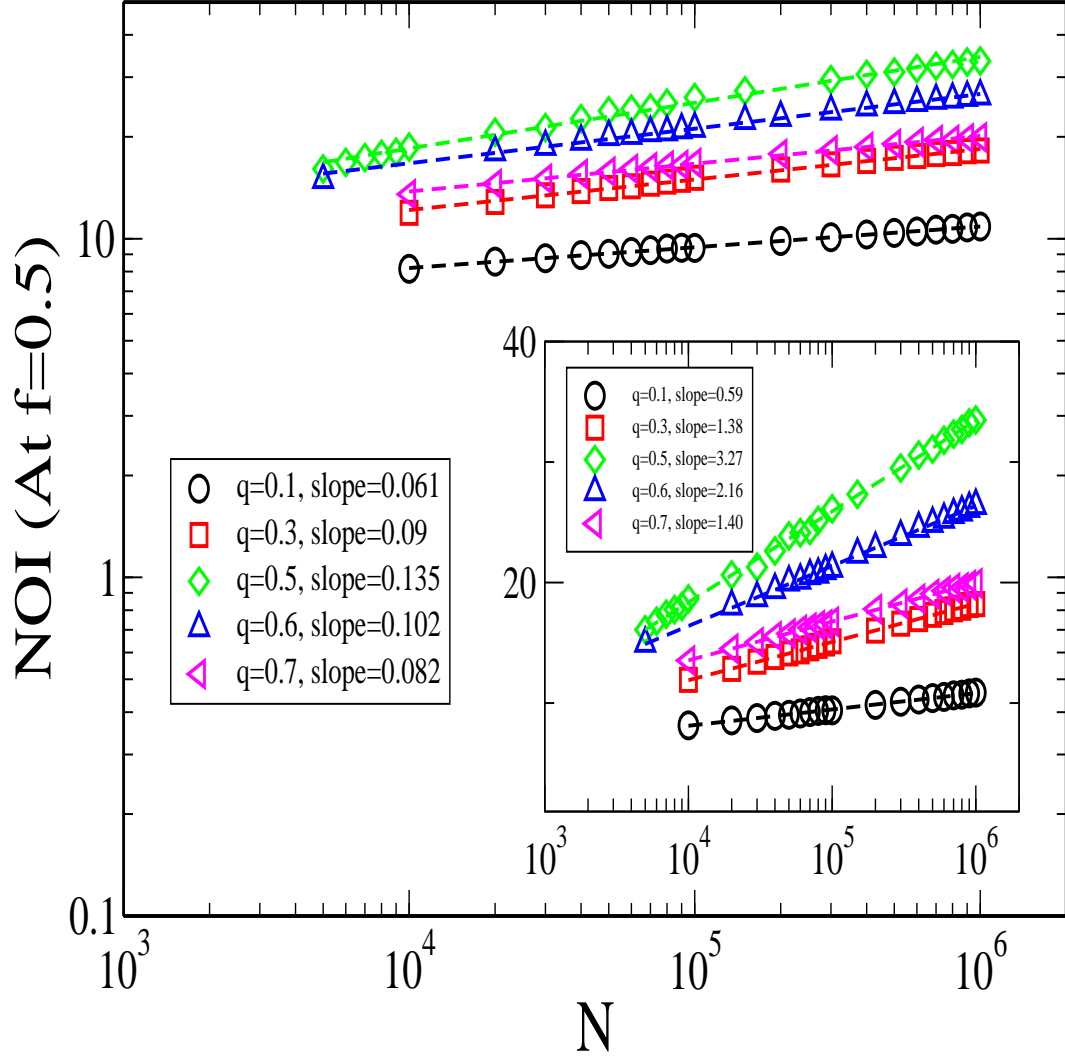

FIG. 13: Plot of the number of cascading steps between the networks (ER with  $\langle k_A \rangle = \langle k_B \rangle = \langle k \rangle = 4$ ) at  $f = 0.5$  as a function of system size for different values of  $q$  in log-log scale and in log-linear scale in the inset respectively. The dashed lines are the power law and logarithmic fittings respectively.

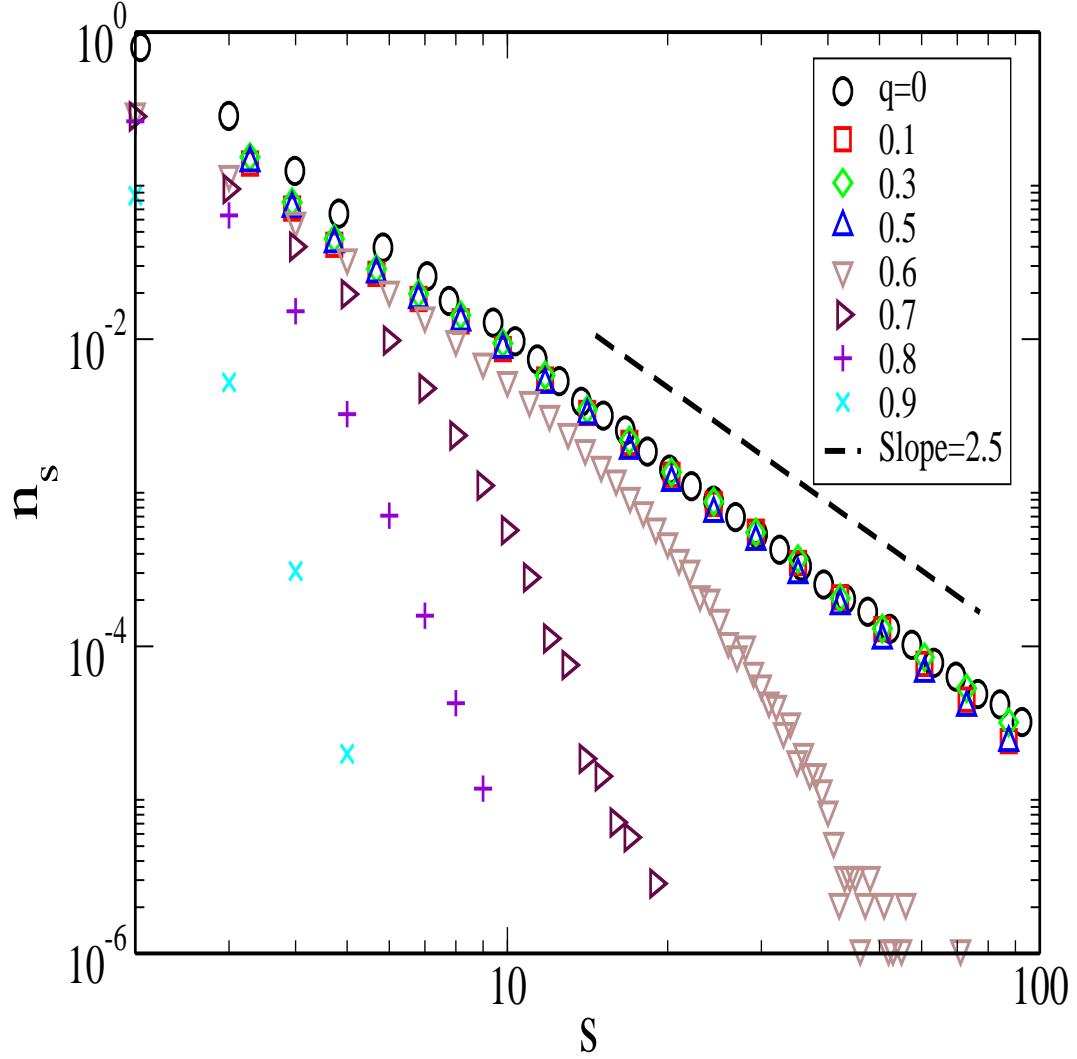

FIG. 14: Plot of  $n_s$  as a function of  $s$  at criticality,  $f_c$ , for different values of  $q$  for the NCO model on coupled ER networks, with  $\langle k_A \rangle = \langle k_B \rangle = \langle k \rangle = 4$  and  $N = 10000$ . For each network the results are averaged over  $10^4$  realizations. As  $q$  increases,  $n_s$  loses the power law shape indicating that the second order phase transition is lost. The dashed line is a guide to show the slope  $\tau = 2.5$ .

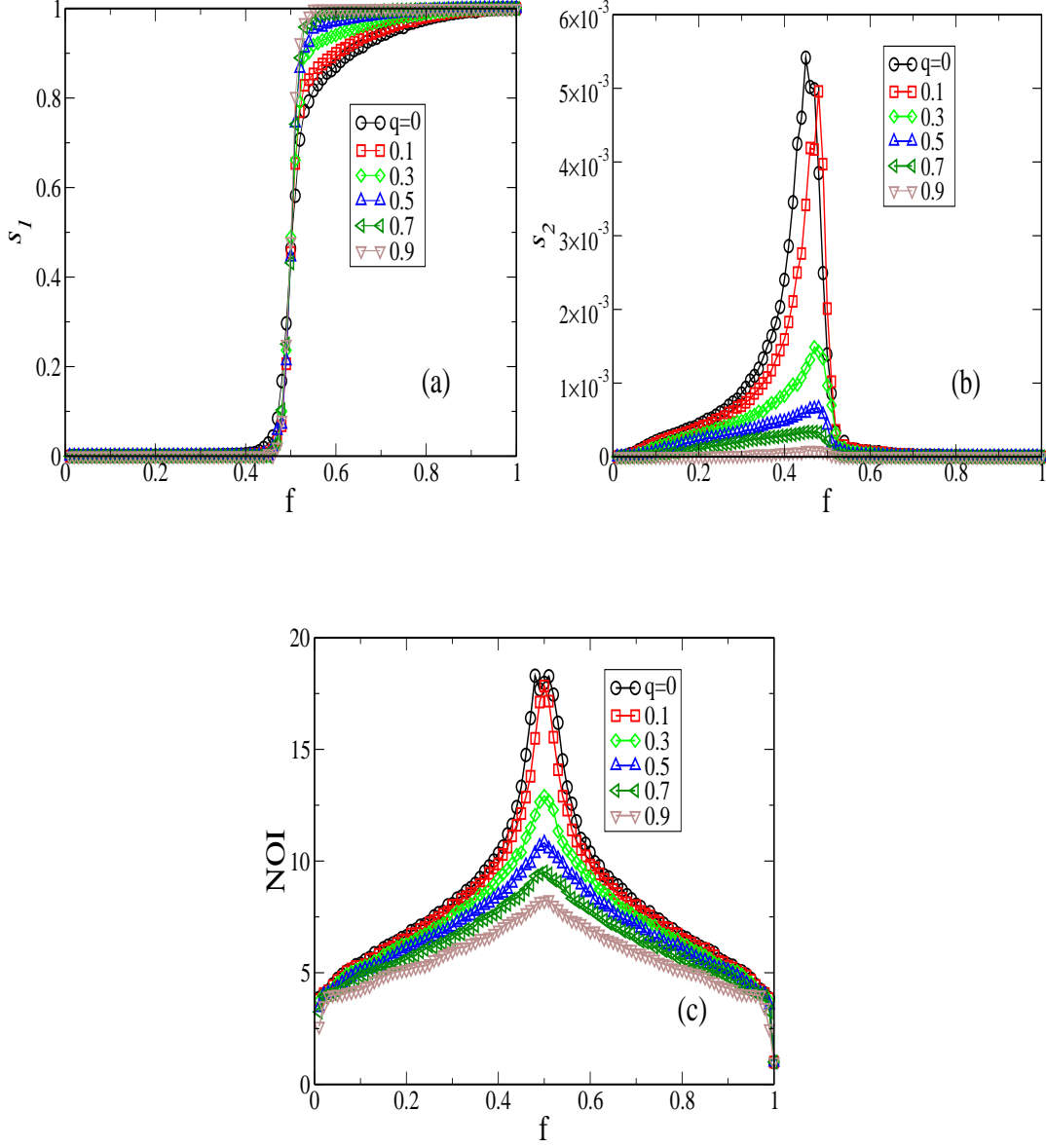

FIG. 15: Study of NCO model on coupled SF networks, with  $k_{\min} = 2$ ,  $\lambda = 2.5$  and  $N = 10000$  for each network. (a) Plot of  $s_1$  of opinion  $\sigma_+$  as a function  $f$  for different values of  $q$ . (b) Plot of  $s_2$  as a function of  $f$  for different values of  $q$ . (c) Plot of the number of cascading steps, NOI, of the coupled networks as a function of  $f$  for different values of  $q$ . The solid lines are guides for the eyes.

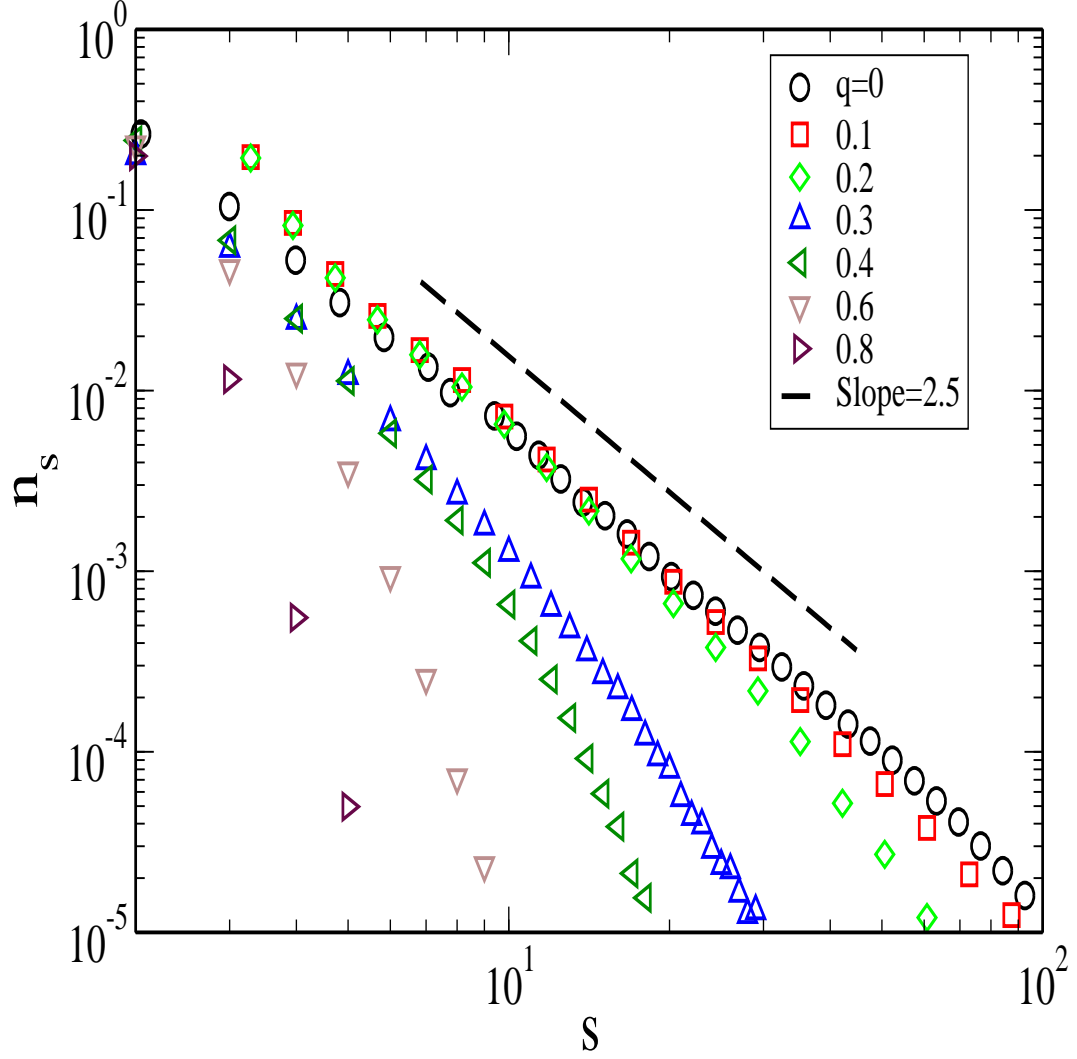

FIG. 16: Plot of  $n_s$  as a function of  $s$  at criticality for different value of  $q$  for the NCO model on coupled SF networks, with  $k_{\min} = 2$ ,  $\lambda = 2.5$  and  $N = 10000$ . For each case the results are averaged over  $10^4$  realizations. As  $q$  increases,  $n_s$  losses the power law shape indicating that the second order phase transition is lost. The dashed line is a guide to show the slope  $\tau = 2.5$ .