

Designing Information Revelation and Intervention with an Application to Flow Control

**Luca Canzian[◇], Yuanzhang Xiao[§], William Zame⁺, Michele Zorzi[◇],
Mihaela van der Schaar[§]**

[◇]DEI, University of Padova, via Gradenigo 6/B, 35131 Padova, Italy

[§]Department of Electrical Engineering, UCLA, Los Angeles CA 90095, USA

⁺Department of Economics, UCLA, Los Angeles CA 90095, USA

Abstract

There are many familiar situations in which a manager seeks to design a system in which users share a resource, but outcomes depend on the information held and actions taken by users. If communication is possible, the manager can ask users to report their private information and then, using this information, instruct them on what actions they should take. If the users are compliant, this reduces the manager's optimization problem to a well-studied problem of optimal control. However, if the users are self-interested and not compliant, the problem is much more complicated: when asked to report their private information, the users might lie; upon receiving instructions, the users might disobey. Here we ask whether the manager can design the system to get around both of these difficulties. To do so, the manager must provide for the users the incentives to report truthfully and to follow the instructions, despite the fact that the users are self-interested. For a class of environments that includes many resource allocation games in communication networks, we provide tools for the manager to design an efficient system. In addition to reports and recommendations, the design we employ allows the manager to intervene in the system after the users take actions. In an abstracted environment, we find conditions under which the manager can achieve the same outcome it could if users were compliant, and conditions under which it does not. We then apply our framework and results to design a flow control management system.

Index Terms

Game Theory, Mechanism Design, Intervention, Resource Allocation, Flow Control

I. INTRODUCTION

There are many situations in which a manager seeks to design a system for users to share a resource, optimizing it according to some given benevolent or selfish criterion. If the manager has full information and users cannot act independently of the manager, the manager's problem is one of optimal control and is well-studied. If the users have information the manager does not have and act independently of the manager, but communication between the users and the manager is possible and users are compliant, the manager's problem is only slightly more complicated: the manager can simply ask the users to report their private information and then provide instructions on how it wishes them to behave. Because the users are compliant, they will report truthfully and obey instructions, so, whatever the manager's objective, this again reduces to a known problem in optimal control. However, if the users are *self-interested* and *strategic*, two difficulties arise. The first is that the users might lie about their private information – if it is in their individual interests to do so; the second is that the users might disobey the instructions of the manager – if it is in their individual interests to do so. The manager's problem in this setting is to design a system to maximize its objective function, given the self-interested and strategic nature of the users. A case of particular interest is that of a benevolent manager, who seeks to allocate resources efficiently or fairly according to some measure of social welfare. Efficient resource allocation is crucial to make the system accessible to many users and provide each of them with good service. However, the problem faced by a benevolent manager may be no easier than the problem faced by a selfish manager, who maximizes some measure of its own personal welfare, because the strategic interests of the individual users will be different from the interests of the group of users as a whole, and hence may still lead individual users to lie and to disobey.¹

In the economics literature, such problems are formalized in terms of *mechanism design* [11]–[16]. The usual approach is to design a system in which the users make reports to the manager on the basis of their private information, the manager provides instructions to the users based on these reports, and the users then take actions that maximize their own welfare. A version of the *revelation principle* [16] implies that such systems can always be designed so that the users find

¹Even in the absence of private information, the strategic interests of the individual users usually lead to the over-use of resources and to substantial inefficiencies [1], [2].

it in their own self-interest to report truthfully and act obediently. We merge such an approach with the innovation introduced by [17], and applied to situations of medium access control [5], [18], and power control [4], by allowing for *intervention* by the manager.² That is, we allow the manager, in addition to designing a system of reports and instructions, to deploy an *intervention device* that intervenes after the users take actions. The action of this intervention device depends on the reports and the actions of the users, and it follows an *intervention rule* designed by the manager. The intervention device adds to the manager’s ability to provide incentives for the users to report truthfully and obey instructions by threatening *punishments* if users lie and/or disobey.

In this paper we explore the manager’s problem in a class of abstract environments that exhibit some features common to many resource sharing situations in communication networks, including power control [3], [4], medium access control (MAC), [5], [6], and flow control [6]–[10]. We will characterize a *coordination mechanism*, i.e., a system of reports, recommendation and intervention, that is optimal (from the point of view of the manager) among all mechanisms. We provide conditions on the environment under which it is *possible* for the manager to achieve its benchmark optimum – the outcome it could achieve if users were compliant – and conditions under which it is *impossible* for the manager to achieve its benchmark optimum. Although we can characterize the optimal mechanism, other mechanisms are also of interest, for several reasons. The optimal mechanism may be very difficult to compute, and hence to execute. It is therefore of some interest to consider mechanisms that are sub-optimal but easy to compute, and we provide a simple algorithm that converges to such a mechanism. Moreover, in some situations, it may not be possible for the users to communicate with the manager, so it is natural to consider intervention schemes that do not require the users to make reports. Finally, we apply these results in the context of flow control. Computations show, among other things, that the considered schemes can considerably increase the efficiency of the system.

There is by now a substantial communication engineering literature that addresses the problem of providing incentives for strategic users to obey a particular resource allocation scheme. Some of this literature adopts pricing schemes that charge users for their resource usage. Pricing schemes can be divided into two categories: *pricing for strategic users* [19]–[22] and *pricing for distributed*

²A packet-dropping scheme that follows the same philosophy as intervention was proposed for flow control games in [7].

algorithms [3], [23], [24]. The former is used for scenarios where the users are self-interested and strategic, as in our scenario. Such users are required to pay *real* money for their resource usage. If the manager knows how a payment affects the utility of a user, it can give the incentives to the user to adopt a particular resource allocation scheme by setting the right prices. Such pricing schemes may achieve the goal of optimal levels of resource usage, but suffer from the following drawbacks: (1) the users are forced, “by contract”, to pay depending on their resource usage and on the state of the system³; (2) the manager has to know the users’ monetary valuation for the service; (3) a secure infrastructure to collect the money is needed. Pricing for distributed algorithms is used for scenarios where the users are compliant and game theory is used as a tool to obtain an efficient distributed algorithm.⁴ In this case the users accept passively the utilities imposed by the manager, that incorporate a term that represents a cost, even though the payments do not actually need to be carried out. The distributed algorithm is obtained forcing the users to act as selfish agents that maximize such utilities, using for example a best response dynamic. Game theory allows to foresee the outcome of this interaction, and the manager has to design the users’ utilities to obtain a desired outcome.

A different literature, including [4], [5], [17], [18], adopts the intervention schemes considered here. Intervention differs from pricing⁵ in that it operates *inside* the system while pricing operates *outside* the system: both schemes provide the manager with a tool to alter the utility of users, but intervention affects resource usage – and hence utility – directly, while pricing affects utility indirectly, through payments. Thus, intervention is more robust than pricing: users cannot evade intervention but they might be able to evade monetary charges, moreover, the manager does not need to know the users’ monetary valuation for the service in intervention schemes.

So far, both intervention and pricing schemes have mainly been applied in communication engineering games with complete information, i.e., assuming that the manager knows the relevant information held by the users. There are few works that address the problem of extracting the

³Current communication networks use different business models.

⁴This is not the scenario considered in this paper, but we want to complete the discussion on pricing schemes to remark that they might be applied to two different scenarios and to avoid misunderstandings.

⁵Since in this paper we consider self-interested and strategic users, we implicitly refer to the first category of pricing schemes.

| | Knowledge of users' monetary valuations for the service | Users' behaviors in reporting information | Users' behaviors in taking actions |
|---|--|--|---|
| This work (intervention + mechanism design) | not needed | Truthful communication enforced by intervention | Actions enforced by intervention |
| Intervention | not needed | Compliant users | Actions enforced by intervention |
| Pricing for strategic users | needed | Compliant users | Actions enforced by payments \ contract |
| Pricing for distributed algorithms | not needed | Compliant users | Compliant users |
| Conventional mechanism design (e.g., auctions) | This is the information the users are asked to report | Truthful communication enforced by the scheme | Actions enforced by payments \ contract |

TABLE I

COMPARISON OF DIFFERENT INCENTIVE SCHEMES EXPLOITED IN COMMUNICATION ENGINEERING LITERATURE.

relevant information from the users. Such works (e.g., [25]–[27]) apply the ideas of mechanism design for auctions, creating schemes that ask the users to reveal their monetary valuation for the service and, depending on it, to pay for their resource usage. These schemes suffer from the same defects as the previously cited pricing schemes: the users are forced to pay depending on their resource usage and a secure infrastructure to collect the money is needed. Table I summarizes the main differences between the above described incentive schemes used in communication engineering literature and our approach.

The remainder of this paper is organized as follows. In Section II, we introduce the coordination mechanism model, using Myerson's framework [16] as the reference. In Section III, we study the properties of the optimal mechanism. In Section IV, we consider two suboptimal mechanisms which, under some assumptions, are easier to compute with respect to the optimal mechanism. In Section V, we analyze and we show the results for the flow control game, both in the complete and incomplete information frameworks, and with and without intervention. Section VI concludes with some remarks.

II. A GENERALIZED COORDINATION MECHANISM FOR PRIVATE INFORMATION PROBLEMS

We consider a manager that wants to design a system whose resources will be used by n users, $\mathcal{N} = \{1, 2, \dots, n\}$ denoting the set of users. Each user might have private information that the manager cannot observe and might take an action that the manager cannot directly control. We denote by $T_i = \{\tau_{i,1}, \tau_{i,2}, \dots, \tau_{i,m_i}\} \subset \mathbb{R}$, $m_i \in \mathbb{N}$, the finite set of user i 's private information, in which the elements are labeled in increasing order, i.e., $\tau_{i,1} < \tau_{i,2} < \dots < \tau_{i,m_i}$. We denote by $D_i = [d_i^{\min}, d_i^{\max}] \subset \mathbb{R}$ the set of user i 's possible actions. We refer to $t_i \in T_i$ and to $d_i \in D_i$ as the type and the action of user i . As an example, each action d_i may represent user i 's level of resource usage, while each type t_i may represent i 's personal valuation for the resource. We denote by $D = \times_{j \in \mathcal{N}} D_j$ and $T = \times_{j \in \mathcal{N}} T_j$ the set of joint action profiles and the set of joint type profiles, i.e., all the possible combinations of users' actions and users' types; and by $D_{-i} = \times_{j \in \mathcal{N} \setminus \{i\}} D_j$ and $T_{-i} = \times_{j \in \mathcal{N} \setminus \{i\}} T_j$ all the possible combinations of users' actions and users' types except for user i . Thus, the symbols $t \in T$, $d \in D$, $t_{-i} \in T_{-i}$ and $d_{-i} \in D_{-i}$ represent vectors.

We assume that the manager can instruct a device, which we refer to as the *intervention device*, that will interact with the users in the system. The aim of the manager is to design the intervention device so that the outcome of the system maximizes the manager's objective. The intervention device has three features: 1) it can communicate with users; 2) it can monitor users' actions; 3) it can take an action of its own, which we interpret following [17] as an *intervention*. We define the *intervention rule* $f : D \rightarrow D_0 = [d_0^{\min}, d_0^{\max}]$ as a function that maps an action profile to an action of the intervention device, and we denote by \mathcal{F} the finite set of intervention rules that the intervention device can implement. For the moment (the role of the intervention device for incomplete information scenarios will be clear in Section II-C), we assume that the intervention device takes an action following the randomized intervention rule π designed by the manager, such that $\pi(f) \geq 0$, $\forall f \in \mathcal{F}$, and $\sum_{f \in \mathcal{F}} \pi(f) = 1$. The randomized intervention rule is communicated to all users before they select their actions. After observing users' actions d , the intervention device picks an intervention rule f following the probability distribution π and intervenes with an action $f(d)$. We refer to the couple (D_0, \mathcal{F}) as the intervention capability. Finally, we denote by $U_0 : \mathcal{F} \times D \times \mathcal{T} \rightarrow \mathbb{R}$ the manager's utility function, and by $U_i : \mathcal{F} \times D \times \mathcal{T} \rightarrow \mathbb{R}$ user i 's

utility function, where $\mathcal{T} = \times_{i \in \mathcal{N}} \mathcal{T}_i$, $\mathcal{T}_i = [\tau_{i,1}, \tau_{i,m_i}]$.⁶

A. Assumptions on utilities

We assume that the manager's utility satisfies the following assumptions, $\forall d \in D$ and $\forall t \in \mathcal{T}$,

A1: There exists $d_0^* \in D_0$ such that $U_0(d_0^*, d, t) > U_0(d_0, d, t)$, $\forall d_0 \in D_0$, $d_0 \neq d_0^*$

A2: $d^*(t) = \operatorname{argmax}_d U_0(d_0^*, d, t)$ is unique

A3: $d_i^*(t)$ is differentiable with respect to t_i and $\frac{\partial d_i^*(t)}{\partial t_i} > 0$

Assumption **A1** states that d_0^* is the most preferred action of the manager, regardless of users' actions and type profile. In games where the intervention device drives users' actions by threatening punishments, the intervention can be interpreted as the level of punishment and d_0^* as the absence of intervention.

By assumption **A2**, for every type profile $t \in \mathcal{T}$ and for every user $i \in \mathcal{N}$, the users' joint action profile that maximizes the intervention device's utility is unique, and by assumption **A3**, each component in $d^*(t)$ is continuous and increasing in the type of that user. If actions represent the level of resource usage and types represent resource valuations, assumption **A3** asserts that the higher i 's valuation the higher should be i 's level of resource usage.

For each type profile $t \in \mathcal{T}$, we define the game

$$\Gamma_t^0 = (\mathcal{N}, D, \{U_i(d_0^*, \cdot, t)\}_{i=1}^n) \quad (1)$$

Γ_t^0 is the complete information game (i.e., users know everything about the structure of the game, in particular, they know the types of the other users) that models the interaction between strategic users having types t when the intervention device adopts the action d_0^* independently of users' actions. It can be thought as the complete information game that models users' interaction in the absence of an intervention device.

We denote by $d^{NE^0}(t) = (d_1^{NE^0}(t), \dots, d_n^{NE^0}(t))$ a Nash Equilibrium (*NE*) of the game Γ_t^0 , which is an action profile so that each user obtains its maximum utility given the actions of the

⁶We require the manager's utility to be defined over the continuous interval $\mathcal{T} \subset \mathbb{R}^p$, that includes the finite type set T , because the property **A3** needs a set in which the differentiation operation is defined. However, the results in the rest of the paper are obtained under the condition that each user i 's type belongs to the finite set T_i .

other users, i.e.,

$$U_i \left(d_0^*, d^{NE^0}(t), t \right) \geq U_i \left(d_0^*, d_i, d_{-i}^{NE^0}(t), t \right) \quad , \quad \forall d_i \in D_i \quad , \quad \forall i \in \mathcal{N} \quad (2)$$

Notice that we have a different game Γ_t^0 , and therefore a different *NE* action profile, for each possible type profile $t \in T$. For this reason $d^{NE^0}(t)$ is represented as a function of t .

We assume that users' utilities $U_i(d_0^*, d, t)$ are twice differentiable with respect to d and, $\forall d \in D$, $\forall t \in T$, $\forall i, j \in \mathcal{N}$, $i \neq j$,

A4: $U_i(d_0^*, d, t)$ is quasi-concave in d_i and there exists a unique best response function $d_i^{BR}(d_{-i}, t) = \operatorname{argmax}_{d_i} U_i(d_0^*, d, t)$

A5: $\frac{\partial^2 U_i(d_0^*, d, t)}{\partial d_i \partial d_j} \leq 0$

A6: There exists $d^{NE^0}(t)$ such that $d^{NE^0}(t) \geq d^*(t)$ ⁷ and $d_k^{NE^0}(\tau_k, t_{-k}) > d_k^*(\tau_k, t_{-k})$ for some users $k \in \mathcal{N}$ and type $\tau_k \in T_k$

Assumption **A4** states that Γ_t^0 is a quasi-concave game and the best response function $d_i^{BR}(d_{-i}, t)$ that maximizes $U_i(d_0^*, d, t)$ is unique. Hence, either i 's utility is monotonic with respect to d_i , or it increases with d_i until it reaches a maximum for $d_i^{BR}(d_{-i}, t)$, and decreases for higher values. As a consequence, a NE $d^{NE^0}(t)$ of Γ_t^0 exists. In fact, the best response function $d^{BR}(d, t) = (d_1^{BR}(d_{-1}, t), \dots, d_n^{BR}(d_{-n}, t))$ is a continuous function from the convex and compact set D to D itself, therefore Brouwer's fixed point theorem assures that a fixed point exists.

Assumption **A5** asserts that Γ_t^0 is a submodular game and it ensures that $d_i^{BR}(d_{-i}, t)$ is a non increasing function of d_j . Interpreting d_i as i 's level of resource usage, this situation reflects resource allocation games where it is in the interest of a user not to increase its resource usage if the total level of use of the other users increases, in order to avoid an excessive use of the resource. Nevertheless, assumption **A6** says that strategic users use the resources more heavily compared to the optimal (from the manager's point of view) usage level.

The class of games satisfying assumptions **A4-A6** includes the linearly coupled games [6] and many resource allocation games in communication networks, such as the MAC [5], [6], power control [3], [4] and flow control [6]–[10] games. Moreover, if the manager's utility is increasing in the users' utilities (e.g., sum-utilities or geometric mean) and the intervention represents a

⁷Throughout the paper, inequalities between vectors are intended component-wise.

punishment, also assumptions **A1-A3** are satisfied in these games and the absence of intervention represents the intervention device's preferred action d_0^* .

B. Actions enforcement for the complete information game

We first introduce the framework to design incentives to enforce users' actions in the complete information scenario, though the main focus of this paper is the design of a system for an incomplete information setting, dealing both with information revelation and action enforcement. The notations and concepts introduced in the following will become useful later, when we study the incomplete information scenario. In fact, some properties of the incomplete information game (i.e., the game where users do not know the types of the other users) are linked to the properties of the complete information game defined in this Subsection.

Given a randomized intervention rule π , we define the complete information game

$$\Gamma_t = (\mathcal{N}, D, \{\bar{U}_i(\cdot, t)\}_{i=1}^n) \quad (3)$$

that models the interaction between strategic users having types t . The utility functions $\bar{U}_i(\cdot, t)$ are the expectations, over the randomized intervention rule, of the original utilities:

$$\bar{U}_i(d, t) = \mathbb{E}_f [U_i(f, d, t)] = \sum_{f \in \mathcal{F}} \pi(f | t) U_i(f, d, t) \quad (4)$$

where $\pi(f | t)$ denotes the probability that the intervention device adopts the intervention rule $f \in \mathcal{F}$ given that the type profile is t , and $\mathbb{E}_x[\cdot]$ is the expectation operator with respect to the random variable x .⁸

Analogously, we denote by \bar{U}_0 the manager's expected utility

$$\bar{U}_0(d, t) = \mathbb{E}_f [U_0(f, d, t)] = \sum_{f \in \mathcal{F}} \pi(f | t) U_0(f, d, t) \quad (5)$$

According to assumptions **A1-A2**, the manager's expected utility is maximized when users adopt action profile $d^*(t)$ and the intervention device adopts action d_0^* . However, in a strategic scenario the users adopt the actions that maximize their own utilities, and the possible outcomes are

⁸There is some abuse of notation in using the same symbol to indicate a random variable and a particular realization, but this will not lead to confusion.

represented by the *NEs*. The *NEs* of the game Γ_t depend on the randomized intervention rule selected by the manager because it affects the utilities of the users. Thus, the manager has to design the randomized intervention rule so that there exists a *NE* of the game Γ_t that gives it the highest utility among what is achievable with all possible *NEs*.

Definition 1. A randomized intervention rule π is said to sustain an action profile $d \in D$ in Γ_t if d is a *NE* of the game Γ_t , i.e., if

$$\bar{U}_i(d, t) \geq \bar{U}_i(\hat{d}_i, d_{-i}, t) \quad , \quad \forall i \in \mathcal{N} \quad , \quad \forall \hat{d}_i \in D_i \quad (6)$$

If such π exists, we say that d is sustainable.

A randomized intervention rule π sustains an action profile $d \in D$ in Γ_t without intervention if π sustains d and $f(d) = d_0^*$ for every intervention rule f such that $\pi(f | t) > 0$.⁹ If such π exists, we say that d is sustainable without intervention.

Interpreting d_0^* as the absence of intervention, the expression *sustainable without intervention* is here used to indicate that in the equilibrium the intervention action is not executed. We denote by $\mathcal{F}^{d,t}$ the set of all randomized intervention rules, obtainable starting from the intervention rule set \mathcal{F} , that sustain d in Γ_t without intervention. The possibility of the manager to design a randomized intervention rule capable of sustaining an action profile depends on the intervention capability, namely, the action space D_0 of the intervention device and the class of intervention rules \mathcal{F} the intervention device is able to implement. If we expand these sets, the manager has more degrees of freedom in designing intervention rules capable of sustaining action profiles.

Definition 2. (D_0, \mathcal{F}) is an optimal intervention capability with respect to the complete information game Γ_t if the maximum utility that the intervention device can obtain considering all the sustainable action profiles cannot be improved by expanding D_0 and \mathcal{F} .

C. Coordination mechanism formulation for the incomplete information game

In this paper we consider the scenario where each user has private information, which is synthesized in its type. Following Harsanyi's approach [28], we study the incomplete information

⁹These definition can be easily extended for *pure* intervention rule: \hat{f} sustains d in Γ_t (without intervention) if π sustains d in Γ_t (without intervention), where $\pi(f | t) = 1$ if $f = \hat{f}$, 0 otherwise.

scenario assuming that each user acts based on the beliefs it has about the types of the other users. In particular, we denote by $P_t(\cdot)$ the joint probability distribution of the type profile over the type profile set T . We assume that each type profile has a positive probability to occur, i.e., $P_t(\tau) > 0, \forall \tau \in T$. We denote by $P_{t_{-i}}(\tau_{-i})$ the joint probability distribution of the type profile of all the users except for user i over the set T_{-i} (notice that user i knows its own type, t_i). We assume that, for each user i , $P_{t_{-i}}(\tau_{-i})$ is consistent with $P_t(\cdot)$, i.e., $P_{t_{-i}}(\tau_{-i}) = P_t(t_i, \tau_{-i} | t_i)$.

To reach its objective, the manager may program the intervention device to elicit information from users and to spread information into the system (notice that users' behaviors, and therefore the outcome of the system, depend on the information they have). We denote by R_i the set of all reports that user i can transmit to the intervention device and by M_i the set of all messages the intervention device can send to user i . As usual, we denote by $r_i \in R_i$ the report sent by i , by $r \in R = \times_{i \in \mathcal{N}} R_i$ the report profile, by $m_i \in M_i$ the message sent to user i and by $m \in M = \times_{i \in \mathcal{N}} M_i$ the message profile. The messages sent and the randomized intervention rule adopted by the intervention device may depend on the reports sent by users. Hence, given the report profile r , we denote by $m^S(r) = (m_1^S(r), \dots, m_n^S(r))$, $m_i^S : R \rightarrow M_i$, the messages sent by the intervention device and by $\pi(f | r)$ the probability that the intervention rule $f \in \mathcal{F}$ is adopted. Following Myerson's terminology [16], we refer to (R, M, m^S, π) as the *coordination mechanism* implemented by the intervention device.

The manager has to design the coordination mechanism to drive the outcome of the system towards its objective. In doing so, it has to consider that users might both send reports and adopt actions strategically, i.e., both information revelation and action enforcement issues must be addressed at the same time. Once the coordination mechanism is established, the interaction between users can be modeled as a Bayesian game

$$\Gamma = (\mathcal{N}, \Phi, \Delta, T, P_t, \{\bar{U}_i(\cdot, \cdot, t)\}_{i=1}^n) \quad (7)$$

In this context, a strategic user i selects its report $r_i \in R_i$ and its action $d_i \in D_i$ in order to maximize its expected utility given the information and the beliefs it has. Precisely, a strategy for user i consists of a couple of functions (ϕ_i, δ_i) . $\phi_i : T_i \rightarrow R_i$ represents the report of user i which may depend on its type. $\delta_i : M_i \times T_i \rightarrow D_i$ represents the action of user i which may depend on its type and on the message received; in fact the received message can carry information about

the types of the other users, that can be exploited by i to select the most appropriate action. We denote by $\phi = \{\phi_i\}_{i \in \mathcal{N}} \in \Phi$ the reporting strategy profile and by $\delta = \{\delta_i\}_{i \in \mathcal{N}} \in \Delta$ the action strategy profile.

Fig. 1 represents the different stages of the interaction between the users and the intervention device, which are summarized in the following.

- Stage 1:** the intervention device announces the coordination mechanism (R, M, m^S, π) ¹⁰
- Stage 2:** each user i sends a report $\phi_i(t)$ to the intervention device
- Stage 3:** the intervention device sends a message $m_i = m_i^S(\phi_i(t))$ to each user i
- Stage 4:** each user i takes an action $d_i = \delta_i(m_i, t_i)$
- Stage 5:** the intervention device monitors the users' action profile d , picks an intervention rule f following the distribution $\pi(\cdot | \phi(t))$, and adopts the action $f(d)$

The utility \bar{U}_i of each user is the expectation over the randomized intervention rule of the original utilities, therefore, given the strategy profiles (ϕ, δ) ,

$$\bar{U}_i(\phi, \delta, t) = \mathbb{E}_f [U_i(f, \delta(m^S(\phi(t)), t), t)] = \sum_{f \in \mathcal{F}} \pi(f | \phi(t)) U_i(f, \delta(m^S(\phi(t)), t), t) \quad (8)$$

In a Bayesian game a user selects its strategy in order to maximize the expectation of its utility with respect to the initial beliefs about the types of the other players. The expected utility of a user i having type t_i is

$$V_i(\phi, \delta, t_i) = \mathbb{E}_{t_{-i}|t_i} [\bar{U}_i(\phi, \delta, t)] = \sum_{t_{-i} \in T_{-i}} \sum_{f \in \mathcal{F}} P_t(t | t_i) \pi(f | \phi(t)) U_i(f, \delta(m^S(\phi(t)), t), t) \quad (9)$$

The strategy profiles (ϕ, δ) is a Bayesian Nash Equilibrium (BNE) of the game if, for each user $i \in \mathcal{N}$, for every type $t_i \in T_i$ and for every alternative strategy $(\tilde{\phi}_i, \tilde{\delta}_i)$ for i ,

$$V_i(\phi, \delta, t_i) \geq V_i(\tilde{\phi}_i, \phi_{-i}, \tilde{\delta}_i, \delta_{-i}, t_i) \quad (10)$$

¹⁰We remark the importance of communicating the mechanism and committing to it. If the intervention device could deviate from the mechanism and select an action to maximize the manager's utility, then, since **A1** is satisfied, the intervention device would adopt d_0^* independently of users' actions. The users, foreseeing this behavior, would ignore the threat of the intervention device and would play as if the intervention device were not present in the system. Conversely, forcing the intervention device to follow the mechanism and communicating it to users, allows the manager to design credible threats and obtain better outcomes.

Finally, the aim of the manager is to design an optimal coordination mechanism (R, M, m^S, π) , such that there is a *BNE* (ϕ, δ) that gives the manager the highest possible expected utility

$$V_0(\phi, \delta) = \mathbb{E}_t [\mathbb{E}_f [U_0(f, \delta(m^S(\phi(t)), t), t)]] = \sum_{t \in T} \sum_{f \in \mathcal{F}} P_t(t) \pi(f | \phi(t)) U_0(f, \delta(m^S(\phi(t)), t), t) \quad (11)$$

This formulation is rather abstract, so it may be worth to use a simple illustrative example to remark our goal. Assume the manager has to assign a resource to 2 users. From a social point of view, the best choice might be to assign the resource to the user having the higher valuation for that resource. Using a conventional MD scheme, the manager might implement a *Vickrey auction* to obtain the users' valuations and to select the user with the higher valuation. However, if a user could avoid the payment such method would fail its objective because that user could bid more than what it is really willing to pay. Moreover, nothing would prevent the user that has lost the auction from trying to access the resource. That is, conventional mechanism design relies on other systems (e.g., a reliable infrastructure to collect money and punishments for the users that do not respect the agreements) to be effective. Here we want to design a scheme that does not rely on external systems. As an example, the intervention device might be a device that asks the users to report their valuations and, based on that, proposes how to share the resource. If the users do not respect such sharing the intervention device might jam their communication. The mechanism used by the intervention device to propose the resource sharing and to jam users' communication must be designed to provide the incentive for both the users to report their true valuations and to accept the proposed resource sharing.

III. OPTIMAL INCENTIVE COMPATIBLE DIRECT MECHANISMS

The design of an optimal coordination mechanism seems to be intractable since there are no constraints on the sets M_i and R_i . Fortunately, the revelation principle [16] allows us to restrict the attention to the class of *incentive compatible direct mechanisms*, among which the optimal mechanism is also optimal in the class of all coordination mechanisms. In a direct mechanism users report their types to the intervention device, and the intervention device sends them a suggested action profile, i.e., $R_i = T_i$ and $M_i = D_i$, $\forall i \in \mathcal{N}$. We denote by $d^S(r) = (d_1^S(r), \dots, d_n^S(r))$, $d_i^S : T \rightarrow D_i$, the suggested action profile given the reported type profile t . We say that user i is

honest and obedient if it reports its real type and adopts the suggested action, i.e., if $\phi_i(t_i) = t_i$ and $\delta_i(d_i, t_i) = d_i$, for every type $t_i \in T_i$ and suggested action $d_i \in D_i$. Finally, a direct mechanism is incentive compatible if the honest and obedient strategy profile is a *BNE*, i.e., if it provides incentives for users to behave honestly and obediently.

The Optimal Incentive Compatible Direct Mechanism (**OICDM**) can be computed solving

$$\mathbf{OICDM} \quad \operatorname{argmax}_{d^S, \pi} \sum_{t \in T} \sum_{f \in \mathcal{F}} P_t(t) \pi(f | t) U_0(f, d^S(t), t)$$

subject to:

$$\pi(f | t) \geq 0, \quad \sum_{x \in \mathcal{F}} \pi(x | t) = 1, \quad \forall f \in \mathcal{F}, \forall t \in T$$

$$\sum_{t_{-i} \in T_{-i}} \sum_{f \in \mathcal{F}} P_t(t | \tau_i) \pi(f | t) U_i(f, d^S(t), t) \geq$$

$$\geq \sum_{t_{-i} \in T_{-i}} \sum_{f \in \mathcal{F}} P_t(t | \tau_i) \pi(f | t_{-i}, \hat{\tau}_i) U_i(f, d_{-i}^S(\hat{\tau}_i, t_{-i}), \hat{\delta}_i(d_i^S(t_{-i}, \hat{\tau}_i)), t)$$

$$\forall i \in \{1, \dots, n\}, \quad \forall \tau_i \in T_i, \quad \forall \hat{\tau}_i \in T_i, \quad \forall \hat{\delta}_i : D_i \rightarrow D_i$$

The second set of constraints of **OICDM** represents the incentive compatible condition. It asserts that when i 's type is τ_i , i does at least as well by being honest and obedient as by reporting $\hat{\tau}_i$ and then adopting $\hat{\delta}_i(d_i^S(t_{-i}, \hat{\tau}_i))$ when told to adopt $d_i^S(t_{-i}, \hat{\tau}_i)$, assuming that the other users are honest and obedient. If users were compliant to the manager's instructions, the mechanism could be thought as a way to retrieve the relevant information, compute the optimal policy and recommend actions to users. In this scenario the optimal mechanism could be computed solving **OICDM** without the second set of constraints. The design of a system that is robust against self-interested strategic users translates mathematically in additional constraints to satisfy, which represent the incentives given to users to follow the instructions. For this reason, the maximum utility the manager can obtain with self-interested strategic users is never higher than the maximum utility it can achieve with compliant users. We denote by V_0^{ME} the maximum expected utility that the manager can obtain when users are compliant, i.e.,

$$V_0^{ME} = \sum_{t \in T} P_t(t) U_0(d_0^*, d^*(t), t) \quad (12)$$

We say that a direct mechanism is a maximum efficiency incentive compatible direct mechanism if it is a solution of **OICDM** and the expected utility that the manager can achieve is equal to the maximum efficiency utility.

Finally, we define the concept of optimal intervention capability also for the incomplete information game Γ .

Definition 3. (D_0, \mathcal{F}) is an optimal intervention capability with respect to the incomplete information game Γ if the solution of **OICDM** cannot be improved expanding D_0 and \mathcal{F} .

A. Properties of a maximum efficiency incentive compatible direct mechanism

In this Subsection we address the problem of the existence and the computation of a maximum efficiency incentive compatible direct mechanism.

The first result we derive asserts that a maximum efficiency incentive compatible direct mechanism exists if and only if, for every type profile t , the optimal action profile $d^*(t)$ is sustainable in the game with complete information Γ_t , and users have incentives to reveal their real type given that they will adopt $d^*(t)$ and the intervention device does not intervene. If this is the case, we are also able to characterize all maximum efficiency incentive compatible direct mechanisms.

Proposition 1. (T, D, d^S, π) is a maximum efficiency incentive compatible direct mechanism if and only if, $\forall t \in T$,

- 1: the optimal action profile $d^*(t)$ of the game Γ_t is sustainable without intervention in Γ_t ;
- 2: each user has incentives to report its real type, when other users do it and everybody is adopting the optimal action profile $d^*(t)$ and the intervention device never intervenes, i.e.,

$$\sum_{t_{-i} \in T_{-i}} P_t(t | \tau_i) U_i(d_0^*, d^*(t), t) \geq \sum_{t_{-i} \in T_{-i}} P_t(t | \tau_i) U_i(d_0^*, d^*(\hat{\tau}_i, t_{-i}), t)$$

$$\forall i \in \mathcal{N}, \quad \forall \tau_i \in T_i, \quad \forall \hat{\tau}_i \in T_i, \quad (13)$$

- 3: the suggested action profile is the optimal action profile of game Γ_t , i.e., $d^S(t) = d^*(t)$;
- 4: the randomized intervention rule sustains without intervention $d^*(t)$ in Γ_t , i.e., $\pi(\cdot | t) \in \mathcal{F}^{d^*(t), t}$.

Proof: See Appendix A ■

Conditions **1-2** are related to the structure of the game without intervention device, while conditions **3-4** say how to obtain a maximum efficiency direct mechanism once **1-2** are satisfied.

In the second result we combine condition **2** of Proposition 1 with assumptions **A3-A6** to derive a sufficient condition on users' type set structures under which a maximum efficiency incentive compatible direct mechanism does not exist. We define the bin size β_k of user k 's type set, T_k , as the maximum distance between two consecutive elements of T_k : $\beta_k = \max_{s \in \{1, \dots, m_k - 1\}} (\tau_{k,s+1} - \tau_{k,s})$. We define the bin size β as the maximum between the bin sizes of all users: $\beta = \max_{k \in \mathcal{N}} \beta_k$.

Proposition 2. *There exists a threshold bin size $\zeta > 0$ so that if $\beta \leq \zeta$ then a maximum efficiency incentive compatible direct mechanism does not exist.*

Proof: Let $k \in \mathcal{N}$ and $\tau_k \in T_k$ be such that $d_k^{NE^0}(\tau_k, t_{-i}) > d_k^*(\tau_k, t_{-i})$, $\forall t_{-i} \in T_{-i}$. We rewrite condition **2** of Proposition 1 for users k and type τ_k :

$$\sum_{t_{-k} \in T_{-k}} P_t(t \mid \tau_k) U_i(d_0^*, d^*(t), t) \geq \sum_{t_{-k} \in T_{-k}} P_t(t \mid \tau_k) U_i(d_0^*, d^*(\hat{\tau}_k, t_{-k}), t) \quad , \quad \forall \hat{\tau}_k \in T_k, \quad (14)$$

We have $d_k^{BR}(d_{-k}^*, t_{-k}, \tau_k) \geq d_k^{BR}(d_{-k}^{NE^0}, t_{-k}, \tau_k) = d_k^{NE^0}(t_{-k}, \tau_k) > d_k^*(t_{-k}, \tau_k)$, where the first inequality is valid for the submodularity.

Let $\tilde{\tau}_k(t_{-k})$ be the type τ so that $d^*(\tau, t_{-k}) = d_k^{BR}(d_{-k}^*, t_{-k}, \tau_k)$ if it exists (in this case **A3** guarantees it is greater than τ_k) and it is lower than \bar{t}_k , and $\tilde{\tau}_k(t_{-k}) = \bar{t}_k$ otherwise. Let $\hat{\tau}_k = \min_{t_{-k}} \tilde{\tau}_k(t_{-k})$. If $(\tau_k, \hat{\tau}_k] \cap T_k \neq \emptyset$ (in particular, this is true if $\beta \leq \hat{\tau}_k - \tau_k = \zeta$), $\forall \tau_m \in (\tau_k, \hat{\tau}_k] \cap T_k$ we obtain

$$U_k(d_0^*, d^*(t_{-k}, \tau_m), t_{-k}, \tau_k) > U_k(d_0^*, d^*(t_{-k}, \tau_k), t_{-k}, \tau_k) \quad , \quad \forall t_{-k} \in T_{-k} \quad (15)$$

contradicting Eq. (14). ■

Interpretation: when user k 's type is τ_k , k 's resource usage that maximizes the manager's utility, $d_k^*(\tau_k, t_{-k})$, is lower than the one that maximizes k 's utility, $d_k^{BR}(d_{-k}^*, \tau_k, t_{-k})$, $\forall t_{-k} \in T_{-k}$. If k reports a type τ_m slightly higher than τ_k , then the intervention device suggests a slightly higher resource usage, allowing k to obtain a higher utility. Hence, k has an incentive to cheat and resources are not allocated as efficiently as possible. To avoid this situation, the intervention device might decrease the resources given to a type τ_m . In this case the loss of efficiency occurs when the real type of k is τ_m and it does not receive the resources it would deserve. There is

no way to avoid the loss of efficiency associated to both case $t_k = \tau_k$ and case $t_k = \tau_m$, both occurring with positive probability.

It is worth noting that we consider finite type sets and a finite intervention rule set mainly to simplify the logical exposition. However, all results might be derived also with infinite and continuous sets.¹¹ In particular, if type sets are continuous Proposition 2 implies that a maximum efficiency incentive compatible direct mechanism never exists.

B. Properties of optimal incentive compatible direct mechanisms

If a maximum efficiency incentive compatible direct mechanism exists, the optimal incentive compatible direct mechanisms set coincides with the maximum efficiency incentive compatible direct mechanisms set, that is characterized in Proposition 1. However, finding an optimal incentive compatible direct mechanism in the general case, solving **OICDM**, may be computationally hard. In this Subsection we consider some additional conditions to simplify the problem. First we assume that the manager's utility is a function of the users' utilities. Moreover, we suppose that the intervention capability (D_0, \mathcal{F}) is such that, for each type profile $t \in T$, every action profile $d \in D$ lower than the *NE* action profile of the game Γ_t^0 is sustainable without intervention in Γ_t (i.e., $d \leq d^{NE^0}(t)$ implies $\mathcal{F}^{d,t}$ non empty). Finally, we assume that, for each type profile $t \in T$ and for every action profile $d \in D$, the utility of a user i adopting the lowest action d_i^{min} is equal to 0, i.e., $U_i(d_0^*, d_i^{min}, d_{-i}, t) = 0$. Interpreting d_i^{min} as no resource usage, this means that, independently of types and other users' actions, a user that does not use resources obtains no utility.

Lemma 3. *The utility of user i is non increasing in the actions of the other users.*

Proof:

$$\begin{aligned}
 U_i(d_0^*, d, t) &= U_i(d_0^*, 0, d_{-i}, t) + \int_0^{d_i} \frac{\partial U_i(d_0^*, x, d, t)}{\partial x} \partial x = \int_0^{d_i} \frac{\partial U_i(d_0^*, x, d, t)}{\partial x} \partial x \\
 \frac{\partial U_i(d_0^*, d, t)}{\partial d_j} &= \int_0^{d_i} \frac{\partial^2 U_i(d_0^*, x, d, t)}{\partial x \partial d_j} \partial x \leq 0
 \end{aligned} \tag{16}$$

¹¹For the continuous case, probability distributions and sums must be substituted with probability density functions and integrals.

where the inequality is valid for the submodularity. ■

The following result allows the manager to further restrict the class of mechanisms to take into consideration.

Lemma 4. *There exists an optimal incentive compatible direct mechanisms such that, $\forall t \in T$, the randomized intervention rule sustains the suggested action profile without intervention in Γ_t .*

Proof: See Appendix B ■

Lemma 4 suggests the idea to decouple the original problem, **OICDM**, into two sub-problems. First we can calculate the optimal suggested action profile $d^S(t)$ under the constraint that users adopting that action profile have incentives to report their real type. Finally, it is sufficient to identify an intervention rule able to sustain $d^S(t)$ without intervention in Γ_t . This is formalized in the following.

Consider the mechanism $(T, D, \bar{d}^S, \bar{\pi})$, where

$$\bar{d}^S = \operatorname{argmax}_{d^S} \sum_{t \in T} P_t(t) U_0(d_0^*, d^S(t), t)$$

subject to:

$$\sum_{t_{-i} \in T_{-i}} P_t(t | \tau_i) U_i(d_0^*, d^S(t_{-i}, \tau_i), t) \geq \sum_{t_{-i} \in T_{-i}} P_t(t | \tau_i) U_i(d_0^*, d_{-i}^S(t_{-i}, \hat{\tau}_i), \hat{\delta}_i(d_i^S(t_{-i}, \hat{\tau}_i)), t)$$

$$\forall i \in \{1, \dots, n\}, \quad \forall \tau_i \in T_i, \quad \forall \hat{\tau}_i \in T_i, \quad \forall \hat{\delta}_i : D_i \rightarrow D_i \quad (17)$$

and, $\forall t \in T$,

$$\bar{\pi}(\cdot | t) \in \mathcal{F}^{\bar{d}^S, t} \quad (18)$$

Proposition 5. *The mechanism $(T, D, \bar{d}^S, \bar{\pi})$ is an optimal incentive compatible direct mechanism.*

Proof: Eq. (18) says that we are looking for a mechanism where, $\forall t \in T$, the randomized intervention rule sustains the suggested action profile without intervention in Γ_t . Moreover, the constraint of Eq. (17) says that the users have the incentive to reveal their true types if they adopt the suggested action profile. Lemma 4 states that such a class of mechanisms is optimal, hence, the solution of Eqs. (17)-(18) gives an optimal incentive compatible direct mechanism. ■

Corollary 6. *The intervention capability (D_0, \mathcal{F}) is optimal with respect to Γ .*

IV. SUB-OPTIMAL INCENTIVE COMPATIBLE DIRECT MECHANISMS

In this Section we provide practical tools for the manager to design efficient coordination mechanisms. Although we have characterized the optimal mechanism, other schemes are also of interest, for several reasons. First of all, the optimal intervention scheme may be very difficult to compute, even in the decoupled version of Eqs. (17)-(18). It is therefore of some interest to consider intervention schemes that are sub-optimal but easy to compute. Moreover, in some situations, it may not be possible for the users to communicate with the manager, so it is natural to consider intervention schemes that do not require the users to make reports. In the following, we address both issues. In Subsection IV-A we describe an algorithm that converges to an incentive compatible direct mechanism where the recommended actions are as close as possible to the optimal ones. In Subsection IV-B we consider a mechanism that is independent of users' reports.

A. Algorithm that converges to an incentive compatible direct mechanism

In this Section we propose a general algorithm (see Algorithm 1) that converges to an incentive compatible direct mechanism. Such algorithm is run by the intervention device at the beginning of the interaction with the users in order to obtain the mechanism to adopt. After that, the interaction between the intervention device and the users is as usual: the intervention device communicates the mechanism, the users report their type, the intervention device suggests the actions to adopt, the users take actions, and finally the intervention device monitors users' actions and intervenes. This algorithm can be applied when the suggested action profile, for every type profile t and at each step of the algorithm, is sustainable without intervention in Γ_t . The suggested action profile will never be lower than the optimal action profile $d^*(t)$ and higher than the NE action profile $d^{NE^0}(t)$ of Γ_t^0 , so it is sufficient that $\mathcal{F}^{d,t}$ is non empty $\forall t \in T$ and $\forall d \in D$ so that $d^*(t) \leq d \leq d^{NE^0}(t)$.

We denote by $W_i(t_i, \hat{t}_i)$ the expected utility that user i , with type t_i , obtains reporting type \hat{t}_i and adopting the suggested action, assuming that the other users are honest and obedient, i.e.,

$$W_i(t_i, \hat{t}_i) = \sum_{t_{-i} \in T_{-i}} \sum_{f \in \mathcal{F}} P_t(t | t_i) \pi(f | \hat{t}) U_i(f, d^S(\hat{t}), t) \quad (19)$$

where we used the notation $\hat{t} = (t_1, \dots, t_{i-1}, \hat{t}_i, t_{i+1}, \dots, t_n)$.

The algorithm has been designed with the idea to minimize the distance between the optimal action profile $d^*(t)$ and the suggested action profile $d^S(t)$, for each possible type profile t . To explain the idea behind the algorithm we use Fig. 2, where i 's utility is plotted with respect to i 's action, for a fixed type profile t and assuming the other users adopt the suggested actions $d_{-i}^S(t)$.

The algorithm initializes the suggested action profile $d^S(t)$ equal to the optimal action profile $d^*(t)$ and selects a randomized intervention rule $\pi(\cdot | t)$ that sustains it without intervention, for every type profile $t \in T$. This situation is represented by the upper-left Fig. 2. Also the NE and i 's best response action are represented, $d^{NE^0}(t)$ and $d^{BR}(d_{-i}^S(t))$. By assumption **A6** $d^*(t) \leq d^{NE^0}(t)$ and by assumption **A5** $d^{NE^0}(t) \leq d^{BR}(d_{-i}^S(t))$, because $d_{-i}^S(t) \leq d_{-i}^{NE^0}(t)$. If $W_i(t_i, t_i) \geq W_i(t_i, \hat{t}_i)$, for every alternative i 's reported type \hat{t}_i , then user i has an incentive to report its true type t_i . If, at a certain iteration of the algorithm, this is valid for all users and for all types they may have, then the algorithm stops and an incentive compatible direct mechanism is obtained.¹²

Conversely, suppose there exists a user i and types t_i and \hat{t}_i such that $W_i(t_i, t_i) < W_i(t_i, \hat{t}_i)$, i.e., user i has the incentive to report \hat{t}_i when its type is t_i . Then the suggested action $d_i^S(t)$ is increased by a quantity equal to ϵ_i , moving it in the direction of the best response function $d_i^{BR}(d_{-i}^S(t))$, for every possible combination of types t_{-i} of the other users, and updates the randomized intervention rule $\pi(\cdot | t)$ in order to sustain without intervention the new suggested action profile. This has the effect, as represented by upper-right Fig. 2, to increase $U_i(d_i^S, d^S(t), t)$, $\forall t_{-i} \in T_{-i}$, and therefore also the expected utility of i when it has type t_i and it is honest, $W(t_i, t_i)$. This procedure is repeated as long as $W_i(t_i, t_i) < W_i(t_i, \hat{t}_i)$ and $d_i^S(t) \leq d_i^{NE^0}(t)$. In case i 's suggested action $d_i^S(t)$ reaches $d_i^{NE^0}(t)$ and still $W_i(t_i, t_i) < W_i(t_i, \hat{t}_i)$, then the suggested action of user k , $d_k^S(t)$, is increased by a quantity equal to ϵ_k , $\forall k \in \mathcal{N}$, $k \neq i$, $\forall t_{-i} \in T_{-i}$. As we can see from lower-left Fig. 2, this means to move the best response function $d_i^{BR}(d_{-i}^S(t))$ in the direction of the suggested action $d_i^S(t)$. If $d_k^S(t)$ reaches $d_k^{NE^0}(t)$ as well, $\forall k \in \mathcal{N}$, then $d_{-i}^S(t)$ coincides with the

¹²Notice that, if a maximum efficiency incentive compatible direct mechanism exists, since it must satisfy the conditions of Proposition 1, then the initialization of the algorithm corresponds to a maximum efficiency incentive compatible direct mechanism and the algorithm stops after the first iteration.

best response function $d^{BR}(d_{-i}^S(t))$, as represented in the lower-right Fig. 2. In fact, by definition, the NE is the action profile such that every user is playing its best response action against the actions of the other users. Since $d_i^S(t)$ coincides with $d^{BR}(d_{-i}^S(t))$, $\forall t_{-i} \in T_{-i}$, user i is told to play its best action for every possible combination of the types of the other users. Hence, user i cannot increase its utility reporting a different type \hat{t}_i , therefore the mechanism is incentive compatible.

The algorithm stops the first time each user has the incentive to declare its real type. Since at each iteration the suggested action profiles are increased by a fixed amount, the algorithm converges after a finite number of iterations. The higher the steps ϵ_i , $i \in \mathcal{N}$, the lower the convergence time of the algorithm. On the other hand, the lower the steps, the closer the suggested action profile to the optimal one.¹³

Algorithm 1 General algorithm.

- 1: **Initialization:** $\forall t \in T$, $d^S(t) = d^*(t)$, $\pi(\cdot | t) \in \mathcal{F}^{d^S, t}$.
 - 2: **For** each user $i \in \mathcal{N}$ and each couple of states $t_i, \hat{t}_i \in T_i$
 - 3: **If** $W_i(t_i, t_i) < W_i(t_i, \hat{t}_i)$
 - 4: **If** $d_i^S(t_i, t_{-i}) < d_i^{NE^0}(t_i, t_{-i})$ for some $t_{-i} \in T_{-i}$
 - 5: $d_i^S(t_i, t_{-i}) \leftarrow \min \left\{ d_i^S(t_i, t_{-i}) + \epsilon_i, d_i^{NE^0}(t_i, t_{-i}) \right\}$, $\pi(\cdot | t) \in \mathcal{F}^{d^S, t}$, $\forall t_{-i} \in T_{-i}$
 - 6: **Else**
 - 7: $d_k^S(t_i, t_{-i}) \leftarrow \min \left\{ d_k^S(t_i, t_{-i}) + \epsilon_k, d_k^{NE^0}(t_i, t_{-i}) \right\}$, $\pi(\cdot | t) \in \mathcal{F}^{d^S, t}$, $\forall k \in \mathcal{N}$, $k \neq i$,
 $\forall t_{-i} \in T_{-i}$
 - 8: **Repeat** from 2 until 3 is unsatisfied $\forall i, t_i, t_{-i}$
-

B. A priori direct mechanism

In this Subsection we consider a new type of mechanism, namely an *a priori mechanism*, where users' reports do not play any role for the final outcome. This is particularly useful in

¹³Notice that, since no assumption such as convexity is made for the manager's expected utility V_0 , an action profile closer to the optimal one does not necessarily imply a better outcome for the manager.

situations where it is not possible for the users to communicate with the manager. However, also for scenarios where users can send reports, an a priori mechanism might represent a good sub-optimal mechanism that is efficient and easy to compute.

Definition 4. (T, D, d^S, π) is an a priori direct mechanism if it is a direct mechanism and the suggested action profile d^S and the selected randomized intervention rule π do not depend on users' reports. (T, D, d^S, π) is an a priori incentive compatible direct mechanism if it is an a priori direct mechanism and it is incentive compatible.

In an a priori direct mechanism stages **1-3** described in Subsection II-C can be compressed in only one stage in which the intervention device communicates to the users the suggested action profile d^S and the randomized intervention rule π . In an a priori incentive compatible direct mechanism the incentive compatibility condition must be checked only for users' actions and **OICDM** simplifies in¹⁴

$$\begin{aligned} & \operatorname{argmax}_{d^S, \pi} \sum_{t \in T} \sum_{f \in \mathcal{F}} P_t(t) \pi(f) U_0(f, d^S, t) \\ & \text{subject to:} \\ & \pi(f) \geq 0, \quad \sum_{x \in \mathcal{F}} \pi(x | t) = 1, \quad \forall f \in \mathcal{F} \\ & \sum_{t_{-i} \in T_{-i}} \sum_{f \in \mathcal{F}} P_t(t | \tau_i) \pi(f) U_i(f, d^S, t) \geq \sum_{t_{-i} \in T_{-i}} \sum_{f \in \mathcal{F}} P_t(t | \tau_i) \pi(f) U_i\left(f, d_{-i}^S, \hat{\delta}_i(d_{-i}^S), t\right) \\ & \forall i \in \{1, \dots, n\}, \quad \forall \tau_i \in T_i, \quad \forall \hat{\delta}_i : D_i \rightarrow D_i \end{aligned} \quad (20)$$

Definition 5. A randomized intervention rule π sustains an action profile $d \in D$ in Γ if d is a BNE of the game Γ , i.e., if, $\forall i \in \mathcal{N}$, $\forall \tau_i \in T_i$, $\forall \tilde{d}_i \in D_i$,

$$\sum_{t_{-i} \in T_{-i}} \sum_{f \in \mathcal{F}} P_t(t | \tau_i) \pi(f | t) U_i(f, d, t) \geq \sum_{t_{-i} \in T_{-i}} \sum_{f \in \mathcal{F}} P_t(t | \tau_i) \pi(f | t) U_i\left(f, \tilde{d}_i, d_{-i}, t\right) \quad (21)$$

¹⁴Notice that the optimal a priori incentive compatible direct mechanism attainable solving (20) is in general suboptimal compared to the optimal a priori direct mechanism. In fact, the revelation principle does not hold for a priori mechanisms since we are adding an additional constraint, forcing the mechanism to be independent of users' reports.

A randomized intervention rule π sustains an action profile $d \in D$ in Γ_t without intervention if π sustains d and $f(d) = d_0^*$ for every intervention rule f such that $\pi(f | t) > 0$. If such π exists, we say that d is sustainable without intervention.

If any action profile is sustainable without intervention in Γ , then (20) can be decoupled and an optimal a priori incentive compatible direct mechanism can be computed as a solution to the following unconstrained optimization problem:

$$\bar{d}^S = \operatorname{argmax}_{d^S} \sum_{t \in T} P_t(t) U_0(d_0^*, d^S, t) \quad (22)$$

and $\bar{\pi}(f)$ sustains \bar{d}^S in Γ without intervention.

V. APPLICATION TO FLOW CONTROL

In this Section we apply the results derived in Sections III and IV for the abstract framework to a concrete scenario: the design of a flow control management system.

A. Formulation of the flow control problem

We consider n Poisson streams of packets with arrival rates d_1, d_2, \dots, d_n that are serviced by a single server with exponentially distributed service times with mean $\frac{1}{\mu}$. Since we assume that all packets have the same length, we will talk interchangeably of arrival rate ($\frac{pkt}{s}$) and transmission rate ($Mbps$), and μ can be seen as the channel capacity, in $\frac{pkt}{s}$, after the server.¹⁵ We refer to each stream of packets as a user. We assume that each user i can control its own traffic (e.g., by adjusting the coding quality of its communication), i.e., it can select its transmission rate $d_i \in D_i = [0, \mu]$. As represented by Fig. 4, the system is an M/M/1 queue with an input arrival rate $\lambda = \sum_{i=1}^n d_i$.

In most cases a user is faced with two conflicting objectives, i.e., to maximize its throughput¹⁶ and to minimize its average delay. The conflict between throughput and delay is obvious since as

¹⁵We consider packets of the same length to keep a simple notation and because the qualitative results are not affected by this hypothesis. However, the model and the analysis can be easily extended to take into account packets of different lengths.

¹⁶Here the throughput refers to the traffic the server is able to service, i.e., the transmission rate available to the user, and does not take into account the packets lost due to physical layer transmission errors.

more traffic enters the server queue the delays become larger. In order to incorporate these two measures in a single performance metric, the concept of power has been proposed in [29] and later extended in [30]. It is defined as the ratio between the throughput and the average delay, where the exponent of the throughput is a positive constant. We can therefore write i 's utility as

$$U_i(d, t_i) = d_i^{t_i} (\mu - \lambda) = d_i^{t_i} \left(\mu - \sum_{i=1}^n d_i \right) \quad (23)$$

where $d = (d_1, \dots, d_n)$ denotes the transmission rate profile and the parameter $t_i > 0$ represents user i 's type.

The value of t_i may depend, for example, on the quality of service of the application corresponding to the i -th stream of packets. As we will see in Eqs. (25) and (29), both considering compliant users and strategic users, the rate adopted by a user is increasing in its type. This consideration suggests the idea that the higher the type of a user, the higher the importance of the rate, with respect to the delay, for that user. As an example, streams of packets associated to delay dependent applications should have a low type while streams of packets associated to delay tolerant applications should have a high type.

In general, the applications a server has to deal with may change over time. For this reason it is useful to define a common type set $T_i = \{\tau_1, \tau_2, \dots, \tau_m\}$, $m \in \mathbb{N}$, $\tau_k \in \mathbb{R}$, $\tau_1 < \tau_2 < \dots < \tau_m$, $\forall i \in \mathcal{N} = \{1, 2, \dots, n\}$, whose elements represent all the possible types of users a server has to deal with. Suppose that at the beginning of the communication a user does not know the types of the other users and the intervention device itself does not know the types of the users. We assume that a common probability distribution exists and that user types are independent and identically distributed (i.i.d.) with $P(t_i)$ denoting the probability that a user has type t_i , $t_i \in T_i$, and $P_t(t) = \prod_{i=1}^n P(t_i)$ the probability that the type profile is t , $t \in T = T_i^n$. $P(t_i)$ can be thought as the average fraction of applications having type t_i that require services to the server.

The network must be designed to operate efficiently following the manager's objective, which can be quantified by a utility function. We assume that the manager's utility is the geometric mean of the users' utilities:

$$U_0(d, t) = \sqrt[n]{\prod_{i=1}^n U_i^+(d, t_i)} = (\mu - \lambda)^+ \prod_{i=1}^n d_i^{\frac{t_i}{n}} \quad (24)$$

where $(x)^+ = \max\{x, 0\}$.¹⁷ This choice allows to maintain a balance between two competing interests a benevolent manager might have: to maximize the social welfare of the network (defined as the sum utility) and to allocate resources fairly, giving to users similar utilities. Notice that maximizing $U_0(d, t)$ with respect to users' actions is equivalent to maximizing a proportional fairness of users' utilities, i.e., $\sum_{i=1}^n \ln U_i^+(d, t_i)$, and the optimal solution $d^* = \{d_i^*\}_{i=1}^n$ is given by (see [6])

$$d_i^*(t) = \frac{t_i \mu}{n + \sum_{k=1}^n t_k} \quad (25)$$

We denote by $V_i(d(t), t_i)$ and $V_0(d(t))$ the expected (with respect to the types) utilities of user i having type t_i and of the manager, where $d(t)$ represents the action adopted by the users when the type profile is t , i.e.,

$$V_i(d(t), t_i) = \sum_{t_{-i} \in T_{-i}} P_t(t | t_i) U_i(d(t), t) \quad (26)$$

$$V_0(d(t)) = \sum_{t \in T} P_t(t) U_0(d(t), t) \quad (27)$$

Hence, the maximum expected utility that the manager can obtain when users are compliant is $V_0^{ME} = V_0(d^*(t))$.

B. The flow control games

In this Subsection we compute the outcome of a flow control problem considering self-interested and strategic users, for both the complete and the incomplete information scenarios. Moreover, we quantify the loss of efficiency of the manager's utility with respect to the maximum efficiency utility.

¹⁷ We consider U_i^+ instead of U_i for mathematical reasons, because utilities as defined in Eq. (31) may also be negative, and the geometric mean would lose meaning with negative quantities. Anyway, notice that it is in the self interest of both the users and the manager to have $\lambda \leq \mu$, i.e., working in the sub-space of the original domain such that $U_i^+ = U_i$.

1) *The complete information game* Γ_t^0 : We define the complete information game

$$\Gamma_t^0 = \left(\mathcal{N}, D, \{U_i(\cdot, t)\}_{i=1}^N \right) \quad (28)$$

where each user i selects its action $d_i(t)$ strategically, knowing the types t of all the users.

The unique *NE* $d_i^{NE^0}(t)$ of Γ_t^0 is, $\forall i \in \mathcal{N}$, (see [6])

$$d_i^{NE^0}(t) = \frac{t_i \mu}{1 + \sum_{k=1}^n t_k} \quad (29)$$

Notice that strategic users use the resources more heavily with respect to compliant users, i.e., $d_i^{NE^0}(t) > d_i^*(t)$, $\forall i \in \mathcal{N}$ and $\forall t \in T$ (excluding the trivial case $n = 1$).

The manager's expected utility in the complete information scenario is equal to $V_0(d^{NE^0}(t))$.

2) *The Bayesian game* Γ^0 : We define the incomplete information game

$$\Gamma^0 = (\mathcal{N}, D, T, P_t, \{U_i(\cdot, t)\}_{i=1}^n) \quad (30)$$

where each user i selects its action $d_i(t_i)$ strategically, knowing its own type t_i and the probability distribution over the types of the other users, P_t .

Proposition 7. *There exists a unique Bayesian Nash Equilibrium $d^{BNE}(t)$ of Γ^0 which can be obtained by solving a linear system $\mathbf{A}d^{BNE} = b$. In addition, the inverse of \mathbf{A} , \mathbf{A}^{-1} , can be computed analytically.*¹⁸

Proof: See Appendix C. ■

The manager's expected utility in the incomplete information scenario is equal to $V_0(d^{BNE}(t))$.

3) *Results:* Fig. 4 shows the manager's expected utility with respect to the number of users, considering $\mu = 5 \text{ Mbps}$ and a type set $T_i = \{0.1, 1\}$ with uniformly distributed types. The upper curve represents the maximum efficiency utility, attainable when users are compliant to the manager, while the dashed and the dotted lines represent the manager's utility when users are strategic in the complete and incomplete information cases respectively. The manager's utility when users act strategically, both for the complete and incomplete information scenarios, is far below compared to the maximum efficiency utility. Notice that the manager can obtain a higher utility in the incomplete information scenario with respect to the complete information scenario,

¹⁸The expressions of b , \mathbf{A} and \mathbf{A}^{-1} can be found in Appendix C.

at least when there are more than three users in the system. This agrees with the results of [31], [32] where, in a strategic setting, the less closely related the agents' goals the lower the quantity of information they prefer to exchange. In our case, the objective of the manager becomes less closely related to the objective of a single user as the number of total users increases. In fact, the manager's objective is to increase the utility of all users in a fair way, while the goal of a user is to improve only its own utility, at the cost of the utility of all the other users. Hence, as the number of users increases, the selfishness of a single user has a higher negative impact on the manager's objective.

C. The flow control games with intervention

Fig. 4 shows that the manager's expected utility in strategic settings is much lower than the manager's expected utility in cooperative settings, when users are compliant. Here we ask whether the manager can design the system in order to make it robust against self-interest strategic users, filling, at least partially, the gap between the maximum efficiency utility and the manager's expected utility in strategic settings.

Using the same notations as in Section II, we consider an intervention device that transmits a stream of packets to the server with a rate $d_0 \in D_0 = [0, d_0^M]$, following an intervention rule $f : D \rightarrow D_0$. d_0^M represents the maximum rate the intervention device is able to transmit. The framework introduced in Subsection V-A can be easily modified to take into account the effect of the intervention device, that increases the incoming traffic of the server $\lambda = \sum_{i=1}^n d_i + f(d)$. The users' and the manager's utilities change accordingly:

$$\begin{aligned}
 U_i(f, d, t_i) &= d_i^{t_i} (\mu - \lambda) = d_i^{t_i} \left(\mu - \sum_{i=1}^n d_i - f(d) \right) \\
 U_0(f, d, t) &= \sqrt[n]{\prod_{i=1}^n U_i^+(f, d, t_i)} = (\mu - \lambda)^+ \prod_{i=1}^n d_i^{\frac{t_i}{n}}
 \end{aligned} \tag{31}$$

It is straightforward to check that the users' and the manager's utilities satisfy assumptions **A1-A6**. In particular, the manager's preferred action is $d_0 = 0$ (i.e., no intervention), and the game Γ_t^0 defined in Subsection II-A coincides with the game Γ_t^0 defined in Subsection V-B2.

In the following we define a simple class of intervention rules, the class of affine intervention rules, where the intervention level increases linearly with the users' actions. We limit the design of

intervention rules to affine intervention rules, i.e., \mathcal{F} coincides with the class of affine intervention rules. It may seem restrictive to constrain the intervention device to such a simple class of intervention rules. However, under certain conditions, the class of affine intervention rules will turn out to be optimal, i.e., it is not possible to increase the manager's utility by expanding the intervention rule set \mathcal{F} .

Definition 6. $f : D \rightarrow D_0$ is an affine intervention rule if

$$f(d) = \left[\sum_{i=1}^n c_i (d_i - \tilde{d}_i) \right]_0^{d_0^M} \quad (32)$$

for certain parameters $\tilde{d}_i \geq 0$ and $c_i \geq 0$, where $[\cdot]_a^b = \min \{ \max \{ a, \cdot \}, b \}$.

In an affine intervention rule, \tilde{d}_i represents a target action for user i while c_i represents the rate of increase of the intervention level due to an increase of i 's action. If the action profile d is lower than or equal to the target action profile $\tilde{d} = (\tilde{d}_1, \dots, \tilde{d}_n)$, then the intervention level is equal to 0. If the intervention level is higher than 0, then some user is adopting an action higher than the target one. In this case, an increase by an amount ϵ of i 's action causes an increase in the intervention level by an amount $c_i \epsilon$.

Fig. 5 shows how an affine intervention rule changes the relation between i 's utility and i 's action. The utility of user i is plotted for three cases: assuming that the intervention device never intervenes and assuming that the intervention device adopts a linear intervention rule, for two different values of the parameter c_i . We consider that the other users adopt the target action profile. For an action d_i lower than the target action \tilde{d}_i , i 's utility is as if the intervention device did not exist. However, for an action d_i higher than the target action \tilde{d}_i , i 's utility is lower compared to the utility it would have obtained without intervention device, and the gap increases as c_i increases.

In the following, we provide the tools for the manager to design the intervention rule, for both the complete and the incomplete information scenarios.

1) *The complete information game Γ_t* : This is the scenario considered in Subsection II-B, where the users adopt actions strategically, knowing the type of the other users and the intervention rule. The interaction between users is modeled with the game Γ_t ,

$$\Gamma_t = (\mathcal{N}, D, \{U_i(f, \cdot, t_i)\}_{i=1}^n), \quad (33)$$

where the utilities U_i , $i \in \mathcal{N}$, are calculated as in Eq. (31). The outcome of such interaction is represented by the NE .

The manager faces the problem of designing a randomized intervention rule so that there exists a NE of the game Γ_t that gives it the highest utility among what is achievable with all possible NEs . We will see that it can reach this objective considering only *pure* intervention rules, which are simpler to implement than randomized intervention rules.

Lemma 8. *Consider the affine intervention rule f such that, for every user $i \in \mathcal{N}$,*

$$c_i \geq \frac{t_i \left(\mu - \sum_{k=1}^n \tilde{d}_k \right) - \tilde{d}_i}{\tilde{d}_i}, \quad d_0^M \geq \frac{c_i \left[t_i \left(\mu - \sum_{k=1}^n \tilde{d}_k \right) - \tilde{d}_i \right]}{1 + t_i(1 + c_i)} \quad (34)$$

If $\tilde{d} \leq d^{NE^0}$, then f sustains \tilde{d} in Γ_t without intervention.

Proof: See Appendix D ■

Interpretation: Selecting a c_i high enough and if the intervention device is able to transmit with a large enough transmission rate, the threat of punishment discourages the users from adopting actions higher than the target. This situation is shown in Fig. 5 for $c_i = 2$. Hence, if the utility of user i is increasing before the target action \tilde{d}_i (in particular, this is valid if $\tilde{d}_i \leq d_i^{NE^0}$), as in Fig. 5, the target action \tilde{d}_i becomes the best response action for user i .

Proposition 9. *If $d_0^M \geq \frac{\mu}{1 + \tau_1}$, then the optimal strategy profile $d^*(t)$, $\forall t \in T$, is sustainable without intervention using an affine intervention rule f with $\tilde{d} = d^*(t)$ and $c_i \geq n - 1$.*

If $d_0^M \geq \mu$, then every strategy profile $d \leq d^{NE^0}(t)$, $\forall t \in T$, is sustainable without intervention using an affine intervention rule f with a high enough c_i , $i \in \mathcal{N}$.

Proof: First, consider the second affirmation. The condition of Eq. (34) on d_0^M is automatically satisfied if the right hand side is lower than 0. Moreover, if it is higher than 0, the right hand side is increasing in c_i . In fact, the function $g(c_i) = \frac{ac_i}{b+dc_i}$, with $a, b \geq 0$, is increasing in c_i , because $g'(c_i) = \frac{ab}{(b+dc_i)^2} > 0$. Thus, the condition of Eq. (34) on d_0^M becomes stricter as c_i increases. Taking the limit for $c_i \rightarrow +\infty$ we can find the following stricter condition on d_0^M that does not

depend on c_i :

$$d_0^M \geq \frac{t_i \left(\mu - \sum_{k=1}^n \tilde{d}_k \right) - \tilde{d}_i}{t_i} = \mu - \sum_{k=1}^n \tilde{d}_k - \frac{\tilde{d}_i (t_i + 1)}{t_i} \quad (35)$$

In order to obtain conditions that are independent of users' types and action profiles to sustain, we can consider the following stricter conditions:

$$d_0^M \geq \mu - \sum_{k=1}^n \tilde{d}_k - \frac{\tilde{d}_i (\tau_m + 1)}{\tau_m}, \quad d_0^M \geq \mu \quad (36)$$

As for c_i , we can find a stricter condition independent of users' types substituting t_i with τ_m . Thus, once the action profile to sustain is fixed, it is sufficient to select a c_i satisfying

$$c_i \geq \frac{\tau_m \left(\mu - \sum_{k=1}^n \tilde{d}_k \right) - \tilde{d}_i}{\tilde{d}_i} \quad (37)$$

Now consider the first affirmation. Substituting $d^*(t)$ into Eq. (34) we obtain

$$c_i \geq \frac{t_i \left(\mu - \sum_{k=1}^n \tilde{d}_k \right)}{\tilde{d}_i} - 1 = n + \sum_{k=1}^n t_k - \frac{t_i \mu \sum_{k=1}^n t_k}{t_i \mu} - 1 = n - 1 \quad (38)$$

As to d_0^M , substituting $d^*(t)$ into the first condition of Eq. (36) we obtain

$$d_0^M \geq \mu - \mu \frac{\sum_{k=1}^n t_k}{n + \sum_{k=1}^n t_k} = \frac{n\mu}{n + \sum_{k=1}^n t_k} \quad (39)$$

Finally, since the right hand side is decreasing in $\sum_{k=1}^n t_k$, a stricter condition can be obtained substituting $t_k = \tau_1, \forall k \in \mathcal{N}$, obtaining

$$d_0^M \geq \frac{\mu}{1 + \tau_1} \quad (40)$$

■

If the intervention device is able to transmit a stream of packets with a rate higher than a certain threshold (that is upper-bounded by μ), the manager can extract the maximum utility from the game Γ_t adopting *pure* affine intervention rules. The following corollary is an implication of this consideration.

Corollary 10. *If $d_0^M \geq \frac{\mu}{1 + \tau_1}$, then the class of affine intervention rules is optimal with respect to Γ_t .*

Finally, the manager's expected utility for the complete information scenario with intervention device, considering affine intervention rules and assuming the condition on d_0^M is satisfied, is equal to the maximum efficiency utility $V_0(d^*(t))$.

2) *The Bayesian game Γ* : This is the scenario considered in Subsection II-C, where the users adopt actions strategically, knowing their own type and the probability distribution over the types of the other users. The manager faces the problem of designing a direct mechanism (T, D, d^S, π) so that the outcome of the system maximizes its own utility. The interaction between users is modeled with the game Γ defined by Eq. (7). Since assumptions **A1-A6** are satisfied, we exploit the results obtained in Section III for the abstract framework.

- Existence and calculation of a maximum efficiency incentive compatible direct mechanism. We wonder if there are some conditions under which the manager can design a mechanism to obtain the same utility it would achieve with compliant users. The following result provides an answer to this question.

Proposition 11. *If $\forall \tau_i \in T_i$ and $\forall t_{-i} \in T_{-i}$,*

$$\left(\frac{n + \sum_{j \neq i} t_j + \tau_{i+1}}{n + \sum_{j \neq i} t_j + \tau_i} \right)^{\tau_{i+1}} \left(\frac{\tau_i}{\tau_{i+1}} \right)^{\tau_i} \geq 1 \quad (41)$$

then the mechanism $(T, D, \bar{d}^S, \bar{\pi})$ where, $\forall t \in T$,

$$\begin{aligned} \bar{d}^S(t) &= d^*(t) \\ \bar{\pi}(\cdot | t) &\in \mathcal{F}^{\bar{d}^S, t} \end{aligned} \quad (42)$$

is a maximum efficiency incentive compatible direct mechanism.

Proof: See Appendix E ■

- Characterization of the optimal incentive compatible direct mechanism.

In case a maximum efficiency incentive compatible direct mechanism does not exist, the manager faces the problem of designing a mechanism such that it obtains a utility as close as possible to the maximum efficiency utility. If $d_0^M \geq \mu$, all additional assumptions made in Subsection III-B are satisfied. Hence, according to Proposition 5, there exists an optimal incentive compatible direct mechanism such that the intervention device adopts a randomized intervention rule that sustains

without intervention the suggested action profile. Such a mechanism can be calculated by solving independently Eqs. (17) and (18), and (18) can be solved considering *pure* affine intervention rules that are simpler to implement than randomized intervention rules. Moreover, according to Corollary 6, the class of affine intervention rules is optimal with respect to Γ . Unfortunately, the solution of Eq. (17) is hard to compute. For this reason, in the following we consider the suboptimal mechanisms proposed in Section IV.

- Algorithm that converges to an incentive compatible direct mechanism.

As for the abstract framework in Subsection IV-A, we consider an algorithm (see Algorithm 2), optimized for the flow control scenario, that converges to an incentive compatible direct mechanism.

Algorithm 2 Flow control algorithm.

- 1: **Initialization:** $\forall t \in T$, $d^S(t) = d^*(t)$, $\pi(\tilde{f} | t) = 1$ for a certain $\tilde{f} \in \mathcal{F}^{d^S, t}$ and $\pi(f | t) = 0$ for $f \neq \tilde{f}$.
 - 2: **For** $s = 1 : m$
 - 3: **For** $l = 1 : m$
 - 4: **If** $W_i(\tau_s, \tau_s) < W_i(\tau_s, \tau_l)$
 - 5: $d_i^S(\tau_l, t_{-i}) \leftarrow \min \left\{ d_i^S(\tau_l, t_{-i}) + \epsilon_i, d_i^{NE^0}(\tau_l, t_{-i}) \right\}$, $\pi(\tilde{f} | t) \leftarrow 1$ for a certain $\tilde{f} \in \mathcal{F}^{d^S, t}$ and $\pi(f | t) = 0$ for $f \neq \tilde{f}$, $\forall t_{-i} \in T_{-i}$
 - 6: Repeat from 2 until 4 is unsatisfied $\forall s$ and l
-

- A priori mechanism.

Consider the a priori mechanism where the intervention device, independently of users' types, suggests action profile \bar{d} and adopts the affine intervention rule \bar{f} ,

$$\bar{d} = \underset{d}{\operatorname{argmin}} - \ln \left(\mu - \sum_{i=1}^n d_i \right) \mathbb{E}_t \left[\prod_{i=1}^n d_i^{\frac{t_i}{n}} \right]$$

$$d_i \geq 0 \quad , \quad d_i \leq \mu \quad , \quad \forall i \in \mathcal{N} \quad (43)$$

Proposition 12. *Eq. (43) defines a convex problem if $\tau_m \leq n$. Moreover, if the randomized intervention rule π sustains \bar{d} without intervention in Γ , then (T, D, \bar{d}, π) is an optimal a priori*

incentive compatible mechanism and the manager's expected utility is $V_0(\bar{d})$.

Proof: See Appendix F ■

D. Results

In the following we are going to quantify the manager's expected utility and the expected throughput and delay for each type of user in different scenarios. We consider $\mu = 5 \text{ Mbps}$ and a common type set $T_i = \{0.1, 1\}$. Except for Fig. 7, we assume that the types are uniformly distributed, i.e., $P(0.1) = P(1) = 0.5$, and we plot the results varying the number of users from 2 to 16.

We first look at how the manager's expected utility varies increasing the number of users, in the complete and incomplete information scenarios. The left side of Fig. 6 refers to the complete information scenario. The overlapped upper lines represent the manager's expected utility when users are compliant and when they are strategic with an intervention device that adopts the optimal intervention rule derived in Subsection V-C1. The manager's expected utility is decreasing in the number of users because, as the number of users increases, the total congestion experienced by every user increases as well. However, it is remarkable that with the intervention scheme the manager can completely fill the gap between the maximum efficiency utility and its expected utility when the users are strategic but no incentive scheme is adopted (dotted line). The right side of Fig. 6 refers to the incomplete information scenario. In this scenario the manager is guaranteed to achieve the maximum efficiency utility using the mechanism derived from the algorithm (dashed line) if the number of users is sufficiently small. In fact, for a number of users less than or equal to 3, it is straightforward to check that the sufficient condition (41) is satisfied, hence, a maximum efficiency mechanism exists and the algorithm converges to it. For a larger number of users, there is no guarantee of optimality, and in fact the results of Fig. 4 show that in this case the manager's expected utility is lower than what could be obtained with compliant users. However, the manager can still considerably increase its expected utility compared to the case of strategic users and no incentive scheme (dotted line), by adopting the mechanism derived from the algorithm for a number of users lower than 8 and the a priori mechanism (dash-dot line) for a number of users greater than or equal to 8 (\bar{f} defined in (??) turns out to sustain the solution of

(43) without intervention in Γ). It is not surprising that the a priori mechanism is able to obtain good performance for a high number of users, in fact in this situation the manager is able to foresee more accurately the fraction of users of a certain type, hence the information about users' types becomes less important.

Now we investigate how the results depend on the type probability distribution for the incomplete information scenario. In Fig. 7 we fix the number of users to 4 and we vary the probability of the low type, $P(0.1)$, from 0 to 1, which is equivalent to varying $P(1)$ from 1 to 0. We can see that the gap between the maximum efficiency utility and the manager's expected utility achievable with the mechanism derived from the algorithm is not strongly dependent on the type probability distribution. In fact, such a mechanism provides incentives for each type of user to be honest and obedient, even though some user types occur rarely. On the contrary, the a priori mechanism is strongly dependent on the probability distribution of user types. In fact, the recommended and enforced action profile depends exclusively on the type probability distribution. As an example, if the low type occurs rarely, the intervention device will suggest to the users to adopt an action profile that is close to the objective of the users with high type, that will probably be the majority of the users in the network. In the extreme case, if low type users are for sure not present in the network (i.e., $P(0.1) = 0$), then the adopted action profile will maximize the interests of the users having high type and the a priori mechanism is able to achieve the maximum efficiency utility. Notice that in this situation the manager has no uncertainty about the types of the users in the network, which is the reason why it is able to extract the maximum utility. In some sense, the uniform probability distribution represents the worst case for the a priori mechanism because the manager has the highest uncertainty over the types of the users in the network.

So far we have only considered the utility as performance indicator. However, the utility includes the two real performance metrics, the throughput and the delay. Now we investigate the expected throughput and delay achievable with the considered schemes in the complete and incomplete information scenarios, for each type of user.¹⁹ Fig. 8 shows the expected throughput (left-side)

¹⁹Notice that all users in the network experience the same delay. However, such delay depends on the type profile: the higher the number of high type users with respect to the number of low type users, the higher the delay. Thus, the expected delay for a low type user is lower than the expected delay for a high type user.

and delay (right-side) for the complete information scenario. Continuous lines refer to the high type users, while dashed lines refer to the low type users. Notice that the high type users obtain a higher expected throughput and a higher expected delay compared to the low type users (this will be true also for the incomplete information scenario), confirming that the higher the type the higher the user's preference for throughput with respect to delay. In both pictures, the upper (continuous and dashed) lines refer to the strategic scenario without intervention device, in which the users adopt the NE action profile, while the overlapped lower (continuous and dashed) lines represent the optimal action policy, obtainable with compliant users or with strategic users subject to the intervention rule derived in Subsection V-C1. With no incentive scheme, strategic users tend to overuse the resources of the network, transmitting with higher rates compared to the optimal ones. This translates into much higher delays, that increase quickly as the number of users increases. Conversely, the optimal transmission policy is such that the expected delay is almost constant with respect to the number of users. This means that also the aggregate throughput is almost constant, and the rate of each user scales as $\frac{1}{n}$.

Fig. 9 shows the expected throughput (left-side) and delay (right-side) for the incomplete information scenario. Continuous lines refer to the high type users, while dashed lines refer to the low type users, with the exception of the performance obtainable adopting the a priori mechanism, represented by the dash-dot line, in which different types of users adopt the same action and experience the same throughput and delay. In both pictures, the upper (continuous and dashed) lines refer to the strategic scenario without intervention device, in which the users adopt the BNE action profile, while the lower (continuous and dashed) lines represent the optimal action policy. The performance obtainable adopting the mechanism derived from the algorithm lies between them. The lines that represent the expected delay for the BNE action profile are truncated for a number of users equal to 3 and 5 because the system might become unstable. In fact, in the BNE the expected utility of a user is maximized, given that the other users adopt the BNE . However, for some type profile instances, the utility might be equal to 0, i.e., the delay might diverge. Thus, the expected delay diverges as well. In words, there is a positive probability that the network becomes congested. The mechanism derived from the algorithm allows to improve this situation, limiting the delay experienced by each user. However, such a delay increases almost

linearly as the number of users increases. This is the reason why the a priori mechanism, at a certain point, even though it is not able to differentiate the service given to different classes of traffic, is able to obtain a better performance (from the manager's utility point of view) than the mechanism derived from the algorithm. In the a priori mechanism each user, independently of its type, adopts a rate which is between the optimal rates adopted by the low type users and the high type users, and this situation reflects in the expected delay. This allows to keep a very low and constant delay with respect to the number of users.

VI. CONCLUSION

In this paper we extend the intervention framework introduced by [17] to take into account situations in which users hold relevant information that the manager cannot observe. To design a system that is efficient and robust to self-interested strategic users, the manager must provide the incentives for the users to report truthfully and to follow the recommendations. For a class of environments that includes many resource allocation games in communication networks, we provide conditions under which it is possible for the manager to achieve its benchmark optimum and conditions under which it is impossible for the manager to achieve its benchmark optimum. In both cases, we are able to characterize the optimal coordination mechanism the manager should adopt. Although we can characterize the optimal mechanism, we also describe a suboptimal mechanism that is easy to compute and a suboptimal mechanism that does not rely on the communication between the users and the intervention device. Finally, we apply our framework and results to the design of a flow control management system. Computations show that the considered schemes can considerably improve the manager's utility.

APPENDIX A

PROOF OF PROPOSITION 1

Proof:

⇒

We prove the result by contradiction.

(T, D, d^S, π) is a maximum efficiency incentive compatible direct mechanism. Suppose that $\exists \hat{t}$ such that $d^S(\hat{t}) \neq d^*(\hat{t})$, then

$$\begin{aligned} \operatorname{argmax}_{d^S, \pi} V_0(\phi^*, \delta^*) &= \operatorname{argmax}_{d^S, \pi} \sum_{t \in T} \sum_{f \in \mathcal{F}} P_t(t) \pi(f | t) U_0(f, d^S(t), t) < \\ &< \operatorname{argmax}_{d^S, \pi} \sum_{t \in T, t \neq \hat{t}} \sum_{f \in \mathcal{F}} P_t(t) \pi(f | t) U_0(f, d^S(t), t) + P_{\hat{t}}(\hat{t}) U_0(d_0^*, d^*(\hat{t}), \hat{t}) \leq V_0^{ME} \end{aligned} \quad (44)$$

Now suppose that $\exists \hat{t}$ such that $\pi(\cdot | \hat{t}) \notin \mathcal{F}^{d^*(\hat{t}), \hat{t}}$. If $\pi(\cdot | \hat{t})$ sustains $d^*(\hat{t})$ but $\exists \hat{f}$ such that $\pi(\hat{f} | \hat{t}) > 0$ and $\hat{f}(d^*(\hat{t})) \neq d_0^*$, then

$$\begin{aligned} \operatorname{argmax}_{d^S, \pi} V_0(\phi^*, \delta^*) &= \operatorname{argmax}_{d^S, \pi} \sum_{t \in T} \sum_{f \in \mathcal{F}} P_t(t) \pi(f | t) U_0(f, d^S, t) \leq \\ &\leq \sum_{t \in T, t \neq \hat{t}} P_t(t) U_0(d_0^*, d^*(t), t) + (1 - \pi(\hat{f} | \hat{t})) U_0(d_0^*, d^*(\hat{t}), \hat{t}) + \pi(\hat{f} | \hat{t}) U_0(\hat{f}, d^S(\hat{t}), \hat{t}) < \\ &< \sum_{t \in T, t \neq \hat{t}} P_t(t) U_0(d_0^*, d^*(t), t) + (1 - \pi(\hat{f} | \hat{t})) U_0(d_0^*, d^*(\hat{t}), \hat{t}) + \pi(\hat{f} | \hat{t}) U_0(d_0^*, d^*(\hat{t}), \hat{t}) = V_0^{ME} \end{aligned} \quad (45)$$

If $\pi(\cdot | \hat{t})$ does not sustain $d^*(\hat{t})$, then $\exists i$ and \hat{d}_i such that $\bar{U}_i(d^*(\hat{t}), t) < \bar{U}_i(\hat{d}_i, d_{-i}^*(\hat{t}), t)$. In this case the intervention device is not able to provide incentive to user i to adopt optimal strategy $d_i^*(\hat{t})$ when the type profile is \hat{t} , therefore the mechanism is not incentive compatible.

Finally, **2** is a particular case of the incentive-compatibility constraints of **OICDM**, therefore it must be satisfied.

\Leftarrow

It is straightforward to verify that a mechanism satisfying **1** – **4** is incentive compatible and the utility of the intervention device is equal to Eq. (12). ■

APPENDIX B

PROOF OF LEMMA 4

Proof:

Let (T, D, d^S, π) be an optimal incentive compatible direct mechanism.

Given a type profile t , we use the notations

$$D_i^S = \left[d_i^{\min}, \min \left\{ d_i^S(t), d_i^{NE^0}(t) \right\} \right] \quad , \quad D^S = D_1^S \times \cdots \times D_n^S \quad , \quad D_{-i}^S = D^S \setminus D_i^S$$

$$a_i(t) = \mathbb{E}_f \left[U_i(f, d^S(t), t) \right] \quad (46)$$

We define the function $g_i(d_{-i})$ in the domain D_{-i}^S as follows:

$$g_i(d_{-i}) = \left\{ d_i \in D_i^S \text{ such that } U_i(d_0^*, d, t) = a_i \right\} \quad (47)$$

The function g_i is a non-empty set-valued function from D_{-i}^S to the power set of D_{-i}^S . In fact, $\forall t \in T$ and $d_{-i} \in D_{-i}^S$,

$$U_i(d_0^*, d_i^{\min}, d_{-i}, t) = 0 \leq a_i \leq U_i(d_0^*, d_i^S(t), d_{-i}^S(t), t) \leq U_i(d_0^*, d_i^S(t), d_{-i}, t) \quad (48)$$

The second inequality of Eq. (48) is valid because i 's utility is non increasing with respect to the intervention level, i.e., $U_i(f, d^S(t), t) \leq U_i(d_0^*, d^S(t), t), \forall f$, which implies that $\mathbb{E}_f [U_i(f, d^S(t), t)] \leq U_i(d_0^*, d^S(t), t)$. The last inequality of Eq. (48) is valid because i 's utility is non increasing in the actions of the other users and, from the definition of the set D_i^S , $d_{-i}^S(t) \geq d_{-i}, \forall d_{-i} \in D_{-i}^S$. Eq. (48) and the continuity of i 's utility imply that an action $\hat{d}_i \in D_i^S$ satisfying $U_i(d_0^*, \hat{d}_i, d_{-i}, t) = a_i$ exists, $\forall d_{-i} \in D_{-i}^S$. Moreover, by definition g_i has a closed graph (i.e., the graph of g_i is a closed subset of $D_{-i}^S \times D_i^S$) and, since i 's utility is non decreasing in $\left[d_i^{\min}, d_i^{NE^0}(t) \right]$, $g_i(d_{-i})$ is convex, $\forall d_{-i} \in D_{-i}^S$.

We define the function $g(d) = (g_1(d_{-1}), \dots, g_n(d_{-n}))$, $\forall d \in D^S$. g is defined from the non-empty, compact and convex set D^S to the power set of D^S . Thanks to the properties of g_i , g has a closed graph and $g(d)$ is non-empty and convex. Therefore we can apply Kakutani fixed-point theorem [33] to affirm that a fixed point exists, i.e., there exists an action profile $\hat{d} \in D^S$ such that $U_i(d_0^*, \hat{d}, t) = a_i, \forall i \in \mathcal{N}$. For each type profile $t \in T$ there exists a different fixed point, hence, we use the notation $\hat{d}(t)$. Notice that $\hat{d}(t) < d^{NE^0}(t)$, therefore the intervention device is able to sustain $\hat{d}(t)$ without intervention.

Finally, the original optimal mechanism can be substituted by a mechanism where, $\forall t \in T$, the intervention device suggests $\hat{d}(t)$ and adopts a randomized intervention rule able to sustain it without intervention. In the new mechanism, the users are obedient because the intervention rule sustains $\hat{d}(t)$ and they are honest because the utilities they obtain for each combination

of reports are the same as in the original incentive compatible mechanism. The utility of the intervention device, which depends only on the users' utilities, is the same as in the original mechanism. Therefore we have obtained an optimal incentive compatible direct mechanism where the intervention device adopts a randomized intervention rule that sustains without intervention the suggested action profile. ■

APPENDIX C

PROOF OF PROPOSITION 7

Proof:

$$V_i(d, t_i) = \mathbb{E}_{t_{-i}} [U_i(d, t_i)] = d_i(t_i)^{t_i} \mathbb{E}_{t_{-i}} [(\mu - \lambda)] = d_i(t_i)^{t_i} \left[\left(\mu - d_i(t_i) - \sum_{j=1, j \neq i}^n \mathbb{E}_{t_j} [d_j(t_j)] \right) \right]$$

$$\frac{\partial \ln V_i(d, t_i)}{\partial d_i(t_i)} = \frac{t_i}{d_i(t_i)} - \frac{1}{\mu - d_i(t_i) - \sum_{j=1, j \neq i}^n \mathbb{E}_{t_j} [d_j(t_j)]}$$

$$\frac{\partial^2 \ln V_i(d, t_i)}{\partial d_i^2(t_i)} = -\frac{t_i}{d_i^2(t_i)} - \frac{1}{\left(\mu - d_i(t_i) - \sum_{j=1, j \neq i}^n \mathbb{E}_{t_j} [d_j(t_j)] \right)^2} < 0 \quad (49)$$

Imposing that the first derivative is equal to 0, we obtain that the Bayesian Nash Equilibrium d^{BNE} must satisfy, $\forall i \in \mathcal{N}$ and $\forall l = 1, \dots, m$,

$$(1 + \tau_l) d_i^{BNE}(\tau_l) + \tau_l \sum_{j=1, j \neq i}^n \sum_{k=1}^m P(\tau_k) d_j^{BNE}(\tau_k) = \mu \tau_l \quad (50)$$

The system of equations defined by (50) can be written as a matrix equation of the form

$$\mathbf{A} d^{BNE} = b \quad (51)$$

where

$$d^{BNE} = \begin{bmatrix} d_1^{BNE} \\ \vdots \\ d_n^{BNE} \end{bmatrix}, \quad d_i^{BNE} = \begin{bmatrix} d_i^{BNE}(\tau_1) \\ \vdots \\ d_i^{BNE}(\tau_m) \end{bmatrix}, \quad b = \begin{bmatrix} \hat{b} \\ \vdots \\ \hat{b} \end{bmatrix}, \quad \hat{b} = \begin{bmatrix} \mu \tau_1 \\ \vdots \\ \mu \tau_m \end{bmatrix}, \quad (52)$$

$$\mathbf{A} = \begin{bmatrix} \mathbf{\Lambda} & \tau \cdot \mathbf{P} & \cdots & \tau \cdot \mathbf{P} \\ \tau \cdot \mathbf{P} & \mathbf{\Lambda} & \cdots & \tau \cdot \mathbf{P} \\ \vdots & \vdots & \ddots & \vdots \\ \tau \cdot \mathbf{P} & \tau \cdot \mathbf{P} & \cdots & \mathbf{\Lambda} \end{bmatrix}, \quad (53)$$

$$\mathbf{\Lambda} = \text{diag}(1 + \tau_1, \dots, 1 + \tau_m), \quad \tau = \begin{bmatrix} \tau_1 \\ \vdots \\ \tau_m \end{bmatrix}, \quad \mathbf{P} = \begin{bmatrix} P(\tau_1) & \cdots & P(\tau_m) \end{bmatrix}. \quad (54)$$

We want to compute the inverse of the matrix \mathbf{A} . We can write \mathbf{A} as

$$\mathbf{A} = \begin{bmatrix} \mathbf{\Lambda} - \tau \cdot \mathbf{P} & & \\ & \ddots & \\ & & \mathbf{\Lambda} - \tau \cdot \mathbf{P} \end{bmatrix} + \begin{bmatrix} \mathbf{I} \\ \vdots \\ \mathbf{I} \end{bmatrix} \cdot \begin{bmatrix} \tau \cdot \mathbf{P} & \cdots & \tau \cdot \mathbf{P} \end{bmatrix} \quad (55)$$

where \mathbf{I} is the identity matrix in $\mathbb{R}^{m \times m}$.

The matrix inversion Lemma states that

$$(\mathbf{E} + \mathbf{BCD})^{-1} = \mathbf{E}^{-1} - \mathbf{E}^{-1}\mathbf{B}(\mathbf{C}^{-1} + \mathbf{DE}^{-1}\mathbf{B})^{-1}\mathbf{DE}^{-1} \quad (56)$$

Applying the matrix inversion Lemma to \mathbf{A}^{-1} we obtain

$$\mathbf{A}^{-1} = \begin{bmatrix} \mathbf{\Lambda} - \tau \cdot \mathbf{P} & & \\ & \ddots & \\ & & \mathbf{\Lambda} - \tau \cdot \mathbf{P} \end{bmatrix}^{-1} - \begin{bmatrix} \mathbf{\Lambda} - \tau \cdot \mathbf{P} & & \\ & \ddots & \\ & & \mathbf{\Lambda} - \tau \cdot \mathbf{P} \end{bmatrix}^{-1} \cdot \begin{bmatrix} \mathbf{I} \\ \vdots \\ \mathbf{I} \end{bmatrix} \cdot \left(\underbrace{\mathbf{I}^{-1} + \begin{bmatrix} \tau \cdot \mathbf{P} & \cdots & \tau \cdot \mathbf{P} \end{bmatrix} \cdot \begin{bmatrix} \mathbf{\Lambda} - \tau \cdot \mathbf{P} & & \\ & \ddots & \\ & & \mathbf{\Lambda} - \tau \cdot \mathbf{P} \end{bmatrix}^{-1} \begin{bmatrix} \mathbf{I} \\ \vdots \\ \mathbf{I} \end{bmatrix}}_{\mathbf{Y}} \right)^{-1} \cdot \begin{bmatrix} \tau \cdot \mathbf{P} & \cdots & \tau \cdot \mathbf{P} \end{bmatrix} \cdot \begin{bmatrix} \mathbf{\Lambda} - \tau \cdot \mathbf{P} & & \\ & \ddots & \\ & & \mathbf{\Lambda} - \tau \cdot \mathbf{P} \end{bmatrix}^{-1} \quad (57)$$

First, we calculate

$$\begin{aligned}
(\Lambda - \tau \cdot \mathbf{P})^{-1} &= \Lambda^{-1} - \Lambda^{-1} \cdot \tau \cdot (-1 + \mathbf{P} \cdot \Lambda^{-1} \cdot \tau)^{-1} \cdot \mathbf{P} \cdot \Lambda^{-1} \\
&= \Lambda^{-1} - \Lambda^{-1} \cdot \tau \cdot \frac{1}{-1 + \sum_{i=1}^m P(\tau_i) \frac{\tau_i}{1+\tau_i}} \cdot \mathbf{P} \cdot \Lambda^{-1} \\
&= \Lambda^{-1} - \Lambda^{-1} \cdot \tau \cdot \beta \cdot \mathbf{P} \cdot \Lambda^{-1}
\end{aligned} \tag{58}$$

where $\beta = \frac{1}{-1 + \sum_{i=1}^m P(\tau_i) \frac{\tau_i}{1+\tau_i}}$.

Now we calculate \mathbf{Y}^{-1} . We rewrite \mathbf{Y} as

$$\begin{aligned}
\mathbf{Y} &= \mathbf{I} + \begin{bmatrix} \tau \cdot \mathbf{P} & \dots & \tau \cdot \mathbf{P} \end{bmatrix} \cdot \begin{bmatrix} \Lambda - \tau \cdot \mathbf{P} & & \\ & \ddots & \\ & & \Lambda - \tau \cdot \mathbf{P} \end{bmatrix}^{-1} \begin{bmatrix} \mathbf{I} \\ \vdots \\ \mathbf{I} \end{bmatrix} \\
&= \mathbf{I} + \begin{bmatrix} \tau \cdot \mathbf{P} & \dots & \tau \cdot \mathbf{P} \end{bmatrix} \cdot \begin{bmatrix} \Lambda^{-1} - \beta \Lambda^{-1} \tau \mathbf{P} \Lambda^{-1} & & \\ & \ddots & \\ & & \Lambda^{-1} - \beta \Lambda^{-1} \tau \mathbf{P} \Lambda^{-1} \end{bmatrix} \cdot \begin{bmatrix} \mathbf{I} \\ \vdots \\ \mathbf{I} \end{bmatrix} \\
&= \mathbf{I} + n \cdot \tau \cdot \mathbf{P} \cdot (\Lambda^{-1} - \beta \Lambda^{-1} \tau \mathbf{P} \Lambda^{-1}) = \mathbf{I} + \tau \cdot [n \cdot (1 - \mathbf{P} \Lambda^{-1} \tau \beta)] \cdot \mathbf{P} \Lambda^{-1} \\
&= \mathbf{I} + \tau \cdot \frac{n}{1 - \sum_{i=1}^m P(\tau_i) \frac{\tau_i}{1+\tau_i}} \cdot \mathbf{P} \Lambda^{-1}
\end{aligned} \tag{59}$$

Applying the matrix inversion Lemma to \mathbf{Y}^{-1} we obtain

$$\begin{aligned}
\mathbf{Y}^{-1} &= \mathbf{I}^{-1} - \mathbf{I}^{-1} \tau \cdot \left(\frac{1 - \sum_{i=1}^m P(\tau_i) \frac{\tau_i}{1+\tau_i}}{n} + \mathbf{P} \cdot \Lambda^{-1} \cdot \mathbf{I}^{-1} \cdot \tau \right)^{-1} \cdot \mathbf{P} \cdot \Lambda^{-1} \cdot \mathbf{I}^{-1} \\
&= \mathbf{I} - \tau \cdot \left(\frac{1}{\frac{1 - \sum_{i=1}^m P(\tau_i) \frac{\tau_i}{1+\tau_i}}{n} + \sum_{i=1}^m P(\tau_i) \frac{\tau_i}{1+\tau_i}} \right) \cdot \mathbf{P} \cdot \Lambda^{-1} \\
&= \mathbf{I} - \frac{n}{1 + (n-1) \sum_{i=1}^m P(\tau_i) \frac{\tau_i}{1+\tau_i}} \cdot \tau \mathbf{P} \Lambda^{-1}
\end{aligned} \tag{60}$$

Finally, we can calculate \mathbf{A}^{-1} as

$$\begin{aligned}
\mathbf{A}^{-1} &= \begin{bmatrix} \mathbf{\Lambda} - \tau \cdot \mathbf{P} & & \\ & \ddots & \\ & & \mathbf{\Lambda} - \tau \cdot \mathbf{P} \end{bmatrix}^{-1} - \begin{bmatrix} \mathbf{\Lambda} - \tau \cdot \mathbf{P} & & \\ & \ddots & \\ & & \mathbf{\Lambda} - \tau \cdot \mathbf{P} \end{bmatrix}^{-1} \cdot \begin{bmatrix} \mathbf{I} \\ \vdots \\ \mathbf{I} \end{bmatrix} \\
&= \left(\mathbf{I} - \frac{n}{1 + (n-1) \sum_{i=1}^m P(\tau_i) \frac{\tau_i}{1+\tau_i}} \cdot \tau \mathbf{P} \mathbf{\Lambda}^{-1} \right) \cdot \begin{bmatrix} \tau \cdot \mathbf{P} & \dots & \tau \cdot \mathbf{P} \end{bmatrix} \\
&\quad \begin{bmatrix} \mathbf{\Lambda} - \tau \cdot \mathbf{P} & & \\ & \ddots & \\ & & \mathbf{\Lambda} - \tau \cdot \mathbf{P} \end{bmatrix}^{-1} = \begin{bmatrix} \mathbf{B} & & \\ & \ddots & \\ & & \mathbf{B} \end{bmatrix} - \begin{bmatrix} \mathbf{C} & \dots & \mathbf{C} \\ \vdots & \ddots & \vdots \\ \mathbf{C} & \dots & \mathbf{C} \end{bmatrix} \quad (61)
\end{aligned}$$

where

$$\mathbf{B} = \mathbf{\Lambda}^{-1} - \beta \mathbf{\Lambda}^{-1} \tau \mathbf{P} \mathbf{\Lambda}^{-1}$$

$$\mathbf{C} = (\mathbf{\Lambda}^{-1} - \beta \mathbf{\Lambda}^{-1} \tau \mathbf{P} \mathbf{\Lambda}^{-1}) \cdot \left(\mathbf{I} - \frac{n}{1 + (n-1) \sum_{i=1}^m P(\tau_i) \frac{\tau_i}{1+\tau_i}} \cdot \tau \mathbf{P} \mathbf{\Lambda}^{-1} \right) \cdot \tau \mathbf{P} \cdot (\mathbf{\Lambda}^{-1} - \beta \mathbf{\Lambda}^{-1} \tau \mathbf{P} \mathbf{\Lambda}^{-1})$$

Hence, the BNE can be analytically computed:

$$d^{BNE} = \mathbf{A}^{-1} b \quad (62)$$

■

APPENDIX D

PROOF OF LEMMA 8

Proof:

We study the sign of the derivative of i 's utility with respect to i ' action

$$\frac{\partial \ln U_i(f, d_i, \tilde{d}_{-i}, t)}{\partial d_i} = \begin{cases} \frac{t_i}{d_i} - \frac{1}{\mu - \sum_{k \neq i} \tilde{d}_k - d_i} & d_i < \tilde{d}_i \\ \frac{t_i}{d_i} - \frac{1 + c_i}{\mu - \sum_{k \neq i} \tilde{d}_k - d_i - c_i(d_i - \tilde{d}_i)} & \tilde{d}_i < d_i < \tilde{d}_i + \frac{d_0^M}{c_i} \\ \frac{t_i}{d_i} - \frac{1}{\mu - \sum_{k \neq i} \tilde{d}_k - d_i - d_0^M} & d_i > \tilde{d}_i + \frac{d_0^M}{c_i} \end{cases}$$

We denote by $d_i^{BR}(d_{-i})$ the best response function of user i , i.e., i 's action that maximizes i 's utility when the action vector of the other users is d_{-i} . Since the users' utilities satisfy the

assumptions **A4-A6**, $\frac{\partial U_i(f, d_i, \tilde{d}_{-i}, t)}{\partial d_i} \geq 0$ for $d_i < \tilde{d}_i$. In fact $U_i(f, d, t_i)$ is increasing with respect to d_i in $\left[0, d_i^{BR}(\tilde{d}_{-i})\right)$ and $\tilde{d}_i \leq d_i^{NE^0} = d_i^{BR}(d_{-i}^{NE^0}) \leq d_i^{BR}(\tilde{d}_{-i})$, where the first inequality is an hypothesis of the Lemma and the last inequality is valid because of the submodularity of the game.

Imposing the condition $\frac{\partial U_i(f, d_i, \tilde{d}_{-i}, t)}{\partial d_i} \leq 0$ in $\tilde{d}_i < d_i < \tilde{d}_i + \frac{d_0^M}{c_i}$, we find

$$c_i \geq \frac{t_i \left(\mu - \sum_{k=1, k \neq i}^n \tilde{d}_k - d_i \right) - d_i}{t_i \left(d_i - \tilde{d}_i \right) + d_i} \quad (63)$$

The right hand side term of 63 is decreasing in d_i , therefore the condition is valid in $\tilde{d}_i < d_i < \tilde{d}_i + \frac{d_0^M}{c_i}$ if and only if it is valid in \tilde{d}_i , obtaining

$$c_i \geq \frac{t_i \left(\mu - \sum_{k=1}^n \tilde{d}_k \right) - \tilde{d}_i}{\tilde{d}_i} \quad (64)$$

Notice that the condition on c_i is a necessary condition for \tilde{d}_i to be a *NE*. In fact if it is not satisfied then $U_i(f, d_i, \tilde{d}_{-i}, t)$ is strictly increasing in \tilde{d}_i and, for the continuity of $U_i(f, d_i, \tilde{d}_{-i}, t)$ with respect to d_i , we can find an action $\hat{d}_i > \tilde{d}_i$ such that $U_i(f, \hat{d}_i, \tilde{d}_{-i}, t) > U_i(f, \tilde{d}_i, \tilde{d}_{-i}, t)$.

Finally, imposing the condition $\frac{\partial U_i(f, d_i, \tilde{d}_{-i}, t)}{\partial d_i} \leq 0$ in $d_i > \tilde{d}_i + \frac{d_0^M}{c_i}$, we find

$$d_0^M \geq \frac{c_i \left[t_i \left(\mu - \sum_{k=1}^n \tilde{d}_k \right) - \tilde{d}_i \right]}{1 + t_i(1 + c_i)} \quad (65)$$

Notice that, given the condition on c_i , this last condition is sufficient for \tilde{d}_i to be a global maximizer. In fact in this way $U_i(f, d_i, \tilde{d}_{-i}, t)$ becomes quasi-concave in d_i : increasing for $d_i < \tilde{d}_i$ and decreasing for $d_i > \tilde{d}_i$. ■

APPENDIX E

PROOF OF PROPOSITION 11

Proof:

Condition **1**, **3** and **4** of 1 are satisfied (we implicitly assume that $d_0^M \geq \frac{\mu}{1 + \tau_1}$). It remains to verify that **2** is satisfied, i.e., $\forall \tau_i, \hat{\tau}_i \in T_i$,

$$\sum_{t_{-i} \in T_{-i}} P(t_{-i}) d_i^{T_i} \left(\mu - \sum_{k=1}^n d_k \right) \geq \sum_{t_{-i} \in T_{-i}} P(t_{-i}) \hat{d}_i^{T_i} \left(\mu - \sum_{k=1}^n \hat{d}_k \right) \quad (66)$$

where, $\forall j \neq i$,

$$d_i = \frac{\tau_i \mu}{n + \sum_{k \neq i} t_k + \tau_i}, \quad d_j = \frac{t_j \mu}{n + \sum_{k \neq i} t_k + \tau_i}, \quad \hat{d}_i = \frac{\hat{\tau}_i \mu}{n + \sum_{k \neq i} t_k + \hat{\tau}_i}, \quad \hat{d}_j = \frac{t_j \mu}{n + \sum_{k \neq i} t_k + \hat{\tau}_i} \quad (67)$$

In particular, Eq. (66) is valid if, $\forall t_{-i} \in T_{-i}$,

$$d_i^{T_i} \left(\mu - \sum_{k=1}^n d_k \right) \geq \hat{d}_i^{T_i} \left(\mu - \sum_{k=1}^n \hat{d}_k \right) \quad (68)$$

Substituting Eq. (67) into Eq. (68) we obtain:

$$\left(\frac{n + \sum_{k \neq i} t_k + \hat{\tau}_i}{n + \sum_{k \neq i} t_k + \tau_i} \right)^{\tau_i + 1} \left(\frac{\tau_i}{\hat{\tau}_i} \right)^{\tau_i} \geq 1 \quad (69)$$

We use the notation $a = n + \sum_{k \neq i} t_k$, and $x = \frac{\hat{\tau}_i}{\tau_i}$. We want to find the condition on τ_i and x such that

$$f(x) = \left(\frac{a + \tau_i x}{a + \tau_i} \right)^{\tau_i + 1} x^{-\tau_i} \geq 1 \quad (70)$$

Notice that $f(1) = 1$. We take the derivative of f with respect to x

$$f'(x) = (\tau_i + 1) \left(\frac{a + \tau_i x}{a + \tau_i} \right)^{\tau_i + 1} \frac{\tau_i}{a + \tau_i} x^{-\tau_i} - \left(\frac{a + \tau_i x}{a + \tau_i} \right)^{\tau_i + 1} \tau_i x^{-\tau_i - 1} = \tau_i x^{-\tau_i - 1} \left(\frac{a + \tau_i x}{a + \tau_i} \right)^{\tau_i} \left(\frac{x - a}{a + \tau_i} \right) \quad (71)$$

$$f'(x) \geq 0 \Leftrightarrow x \geq a \Leftrightarrow \frac{\hat{\tau}_i}{\tau_i} \geq n + \sum_{k \neq i} t_k.$$

$f(\frac{\hat{\tau}_i}{\tau_i})$ is decreasing in $\hat{\tau}_i$ until $\hat{\tau}_i = \tau_i \left(n + \sum_{k \neq i} t_k \right)$, then it is increasing. This implies that for $\hat{\tau}_i < \tau_i$ Eq. (68) is satisfied, i.e., user i has no incentive to report a lower type. However, if $\hat{\tau}_i \rightarrow \tau_i^+$, since $f'(1) < 0$, then user i has an incentive to communicate a higher type (this result is linked to 2). In fact Eq. (68) is unsatisfied $\forall t_{-i} \in T_{-i}$, and therefore Eq. (67) is unsatisfied. Since the function $f(\frac{\hat{\tau}_i}{\tau_i})$ increases for $\hat{\tau}_i > \tau_i \left(n + \sum_{k \neq i} t_k \right)$, the only way for Eq. (68) to be satisfied is that the function $f(x)$ will eventually reach the value 1 for a value $x^{th} = \frac{\tau_i^{th}}{\tau_i}$ and all the types higher than τ_i are higher than the threshold value τ_i^{th} . Notice that it is sufficient that

this condition is verified by the type that follows τ_i , i.e., τ_{i+1} . Substituting $\hat{\tau}_i$ with τ_{i+1} into Eq. (69) we obtain Eq. (41). ■

APPENDIX F

PROOF OF PROPOSITION 12

Proof:

First, we demonstrate that Eq. (43) describes a convex problem if $\tau_m \leq n$. The constraints describe a convex set. We can rewrite the objective function in the following way

$$\begin{aligned} f(d) &= -\ln \left[\left(\mu - \sum_{i=1}^n d_i \right) \sum_{t \in \mathcal{T}} P_t(t) \prod_{i=1}^n d_i^{\frac{t_i}{n}} \right] = -\ln \left[\left(\mu - \sum_{i=1}^n d_i \right) \prod_{i=1}^n \sum_{l=1}^m P(\tau_l) d_i^{\frac{\tau_l}{n}} \right] = \\ &= -\ln \left(\mu - \sum_{i=1}^n d_i \right) - \sum_{i=1}^n \ln \sum_{l=1}^m P(\tau_l) d_i^{\frac{\tau_l}{n}} \end{aligned} \quad (72)$$

We calculate the partial derivatives of $f(d)$

$$\begin{aligned} \frac{\partial f(d)}{\partial d_j} &= \frac{1}{\mu - \sum_{i=1}^n d_i} - \frac{\sum_{l=1}^m P(\tau_l) \frac{\tau_l}{n} d_i^{\frac{\tau_l}{n}-1}}{\sum_{l=1}^m P(\tau_l) d_i^{\frac{\tau_l}{n}}} \\ \frac{\partial^2 f(d)}{\partial d_j^2} &= \frac{1}{(\mu - \sum_{i=1}^n d_i)^2} - \frac{\left(\sum_{l=1}^m P(\tau_l) \frac{\tau_l}{n} \left(\frac{\tau_l}{n} - 1 \right) d_i^{\frac{\tau_l}{n}-2} \right) \left(\sum_{l=1}^m P(\tau_l) d_i^{\frac{\tau_l}{n}} \right) - \left(\sum_{l=1}^m P(\tau_l) \frac{\tau_l}{n} d_i^{\frac{\tau_l}{n}-1} \right)^2}{\left(\sum_{l=1}^m P(\tau_l) d_i^{\frac{\tau_l}{n}} \right)^2} \\ \frac{\partial^2 f(d)}{\partial d_j \partial d_k} &= \frac{1}{(\mu - \sum_{i=1}^n d_i)^2} \end{aligned} \quad (73)$$

We have $\frac{\partial^2 f(d)}{\partial d_j^2} \geq \frac{\partial^2 f(d)}{\partial d_j \partial d_k} \geq 0$, where the first inequality is valid if $\tau_m \leq n$.

Before concluding, we state and prove the following Lemma.

Lemma 13. *The matrix*

$$H = \begin{bmatrix} \alpha_1 & \beta & \dots & \beta \\ \beta & \alpha_2 & \dots & \beta \\ \vdots & & \ddots & \vdots \\ \beta & \beta & \dots & \alpha_n \end{bmatrix} \quad (74)$$

where $\alpha_i \geq \beta \geq 0, \forall i = \{1, 2, \dots, n\}$, is positive semidefinite. If the first inequality is strict, it is also positive definite.

Proof:

$$H = \beta \begin{bmatrix} 1 & 1 & \dots & 1 \\ 1 & 1 & \dots & 1 \\ \vdots & & \ddots & \vdots \\ 1 & 1 & \dots & 1 \end{bmatrix} + \begin{bmatrix} \alpha_1 - \beta & 0 & \dots & 0 \\ 0 & \alpha_2 - \beta & \dots & 0 \\ \vdots & & \ddots & \vdots \\ 0 & 0 & \dots & \alpha_n - \beta \end{bmatrix} \quad (75)$$

Therefore

$$v^T \cdot H \cdot v = (\alpha_1 - \beta) v_1^2 + \dots + (\alpha_n - \beta) v_n^2 + \beta \left(\sum_{i=1}^n v_i \right)^2 \quad (76)$$

$v^T \cdot H \cdot v \geq 0 \forall v$ if $\alpha_i \geq \beta \geq 0 \forall i$. $v^T \cdot H \cdot v > 0 \forall v \neq 0$ if $\alpha_i > \beta \geq 0 \forall i$. ■

Applying Lemma 13 to the Hessian of the function $f(d)$ we obtain that the Hessian is positive semidefinite, therefore the function $f(d)$ is convex.

As for the optimality of the a priori incentive compatible mechanism (T, D, \bar{d}, π) , for every a priori incentive compatible mechanism we have

$$\begin{aligned} \max_{\pi, d} V_0(d) &= \max_{\pi, d} \mathbb{E}_t \left[\mathbb{E}_f \left[\sqrt[n]{\prod_{i=1}^n U_i^+(f, d, t)} \right] \right] \leq \max_d \mathbb{E}_t \left[\sqrt[n]{\prod_{i=1}^n U_i^+(d_0^*, d, t)} \right] = \\ &= \max_d \left(\mu - \sum_{i=1}^n d_i \right)^+ \mathbb{E}_t \left[\sqrt[n]{\prod_{i=1}^n d_i^{t_i}} \right] = \max_d \left(\mu - \sum_{i=1}^n d_i \right) \mathbb{E}_t \left[\prod_{i=1}^n d_i^{\frac{t_i}{n}} \right] \end{aligned} \quad (77)$$

Thus if a randomized intervention rule π sustains without intervention \bar{d} , the mechanism (T, D, \bar{d}, π) is an optimal a priori incentive compatible direct mechanism. ■

REFERENCES

- [1] G. Tan and J. Guttag, "The 802.11 MAC protocol leads to inefficient equilibria," in *Proc. IEEE INFOCOM*, vol. 1, 2005, pp. 1–11.
- [2] R. T. B. Ma, V. Misra, and D. Rubenstein, "Modeling and analysis of generalized slotted-aloha MAC protocols in cooperative, competitive and adversarial environments," in *Proc. IEEE ICDCS*, 2006.
- [3] J. Huang, R. A. Berry, and M. L. Honig, "Distributed interference compensation for wireless networks," *IEEE J. Sel. Areas Commun.*, vol. 24, no. 5, pp. 1074–1084, 2006.

- [4] Y. Xiao, J. Park, and M. van der Schaar, "Intervention in power control games with selfish users," *IEEE J. Sel. Topics Signal Process., Special issue on Game Theory in Signal Processing*, vol. 6, pp. 165–179, 2012.
- [5] J. Park and M. van der Schaar, "Stackelberg contention games in multiuser networks," *EURASIP Journal on Advances in Signal Processing*, pp. 1–15, 2009.
- [6] Y. Su and M. van der Schaar, "Linearly coupled communication games," *IEEE Trans. Commun.*, vol. 59, pp. 2543–2553, 2011.
- [7] Y. Gai, H. Liu, and B. Krishnamachari, "A packet dropping-based incentive mechanism for M/M/1 queues with selfish users," in *Proc. IEEE INFOCOM*, 2011, pp. 2687–2695.
- [8] K. Bharath-Kumar and J. M. Jaffe, "A new approach to performance-oriented flow control," *IEEE Trans. Commun.*, vol. 29, pp. 427–435, 1981.
- [9] C. Douligeris and R. Mazumdar, "A game theoretic perspective to flow control in telecommunication networks," *Journal of the Franklin Institute*, vol. 329, no. 2, pp. 383–402, 1992.
- [10] Z. Zhang and C. Douligeris, "Convergence of synchronous and asynchronous greedy algorithm in a multiclass telecommunication environment," *IEEE Trans. Commun.*, vol. 40, no. 8, pp. 1277–1281, 1992.
- [11] L. Hurwicz, "Game theory," *Decision and Organization: a Volume in Honor of Jacob Marshak*, pp. 297–336, 1972.
- [12] P. Dasgupta, P. Hammond, and E. Maskin, "The implementation of social choice rules: some results on incentive compatibility," *Review of Economic Studies*, vol. 46, pp. 185–216, 1979.
- [13] B. Holmstrom, "Moral hazard and observability," *Bell Journal of Economics*, vol. 10, pp. 74–91, 1979.
- [14] R. B. Myerson, "Incentive-compatibility and the bargaining problem," *Econometrica*, vol. 47, pp. 61–73, 1979.
- [15] —, "Optimal auction design," *Mathematics of Operations Research*, vol. 6, pp. 58–73, 1981.
- [16] —, "Optimal coordination mechanism in generalized principal-agent problems," *Journal of Mathematical Economics*, vol. 10, pp. 67–81, 1982.
- [17] J. Park and M. van der Schaar, "The theory of intervention games for resource sharing in wireless communications," *IEEE J. Sel. Areas Commun.*, vol. 30, no. 1, pp. 165–175, 2012.
- [18] —, "Designing incentive schemes based on intervention: The case of imperfect monitoring," in *Proc. GameNets*, 2011.
- [19] D. Wang, C. Comaniciu, and U. Tureli, "Cooperation and fairness for slotted aloha," *Wireless Personal Communications*, vol. 43, no. 1, pp. 13–27, 2007.
- [20] L. Yang, H. Kim, J. Zhang, M. Chiang, and C. W. Tan, "Pricing-based spectrum access control in cognitive radio networks with random access," in *Proc. IEEE INFOCOM*, 2011, pp. 2228–2236.
- [21] T. Basar and R. Srikant, "Revenue-maximizing pricing and capacity expansion in a many-users regime," in *Proc. IEEE INFOCOM*, 2002, pp. 1556–1563.
- [22] H. Shen and T. Basar, "Optimal nonlinear pricing for a monopolistic network service provider with complete and incomplete information," *IEEE J. Sel. Areas Commun.*, vol. 25, pp. 1216–1223, 2007.
- [23] D. A. Schmidt, C. Shi, R. A. Berry, M. L. Honig, and W. Utschick, "Distributed resource allocation schemes," *IEEE Signal Processing Magazine*, vol. 26, no. 5, pp. 53–63, 2009.
- [24] T. Alpcan, T. Basar, R. Srikant, and E. Altman, "CDMA uplink power control as a noncooperative game," *Wireless Networks*, vol. 8, pp. 659–670, 2002.
- [25] J. Huang, R. A. Berry, and M. L. Honig, "Auction-based spectrum sharing," *Mobile Networks and Applications*, vol. 11, pp. 405–418, 2006.

- [26] T. Alpcan, H. Boche, and S. Naik, "A unified mechanism design framework for networked systems," *CoRR*, vol. abs/1009.0377, 2010.
- [27] P. Nuggehalli, J. Price, and T. Javidi, "Pricing and QoS in wireless random access networks," in *Proc. IEEE GLOBECOM*, 2008, pp. 1–5.
- [28] J. C. Harsanyi, "Games with incomplete information played by 'bayesian' players," *Management Science*, vol. 14, no. 5, pp. 320–334, 1968.
- [29] A. Giessler, J. Hanle, A. Konig, and E. Pade, "Free buffer allocation - an investigation by simulation," *Comput. Networks*, vol. 1, pp. 199–204, 1978.
- [30] L. Kleinrock, "Power and deterministic rules of thumb for probabilistic problems in computer communications," *Conference Record, International Conference on Communications*, vol. 2, no. 4, pp. 43.1.1–43.1.10, 1979.
- [31] B. Holmstrom, "On the theory of delegation," Northwestern University, Center for Mathematical Studies in Economics and Management Science, Discussion Papers 438, Jun. 1980. [Online]. Available: <http://ideas.repec.org/p/nwu/cmsems/438.html>
- [32] V. P. Crawford and J. Sobel, "Strategic information transmission," *Econometrica*, vol. 50, no. 6, pp. 1431–1451, 1982.
- [33] S. Kakutani, "A generalization of Brouwer's fixed point theorem," *Duke Mathematical Journal*, vol. 8, no. 3, pp. 457–459, 1941.

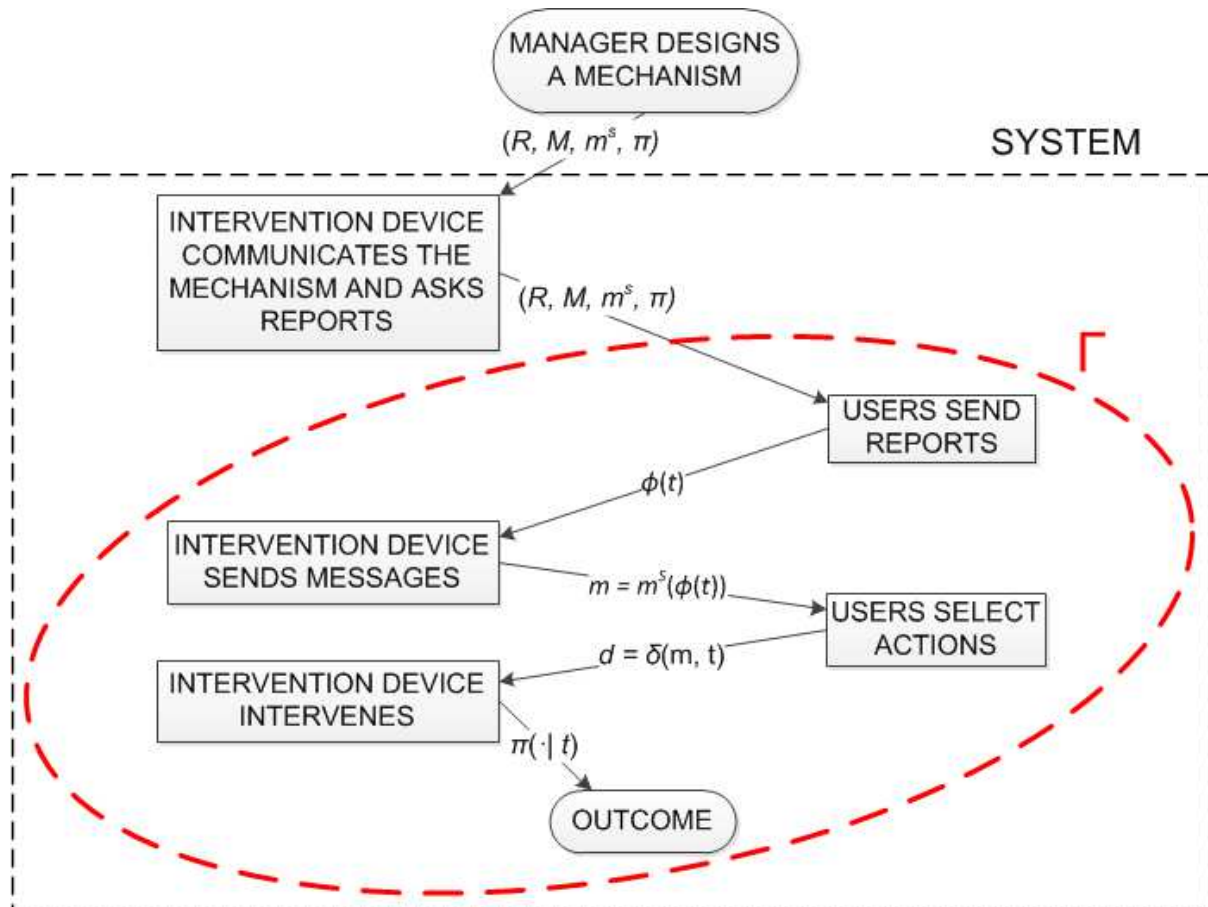

Fig. 1. Interaction between the users and the intervention device

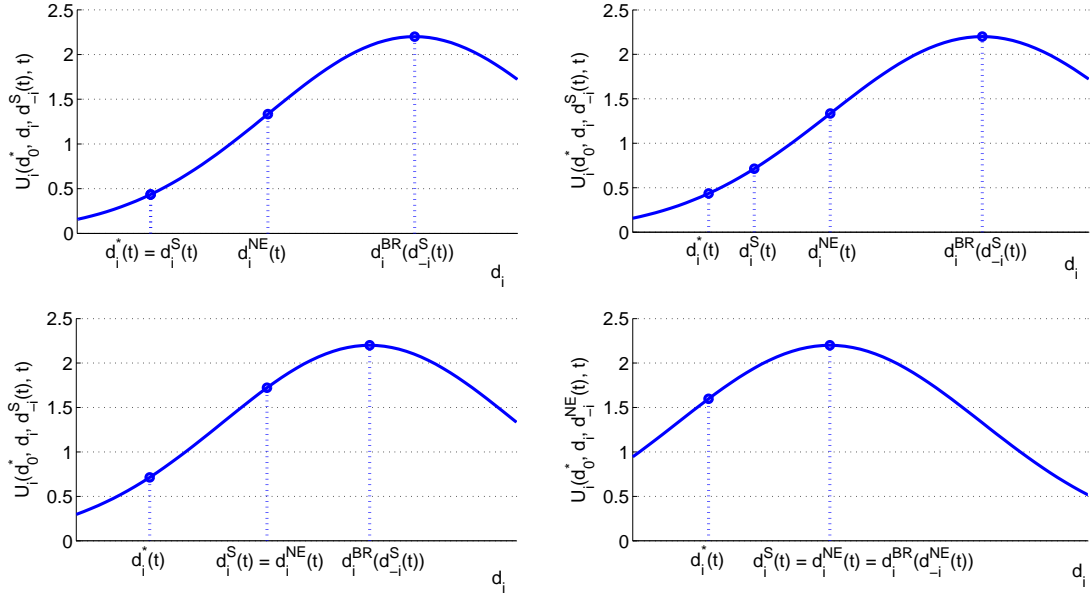

Fig. 2. User i 's utility vs. user i 's action, for different suggested actions

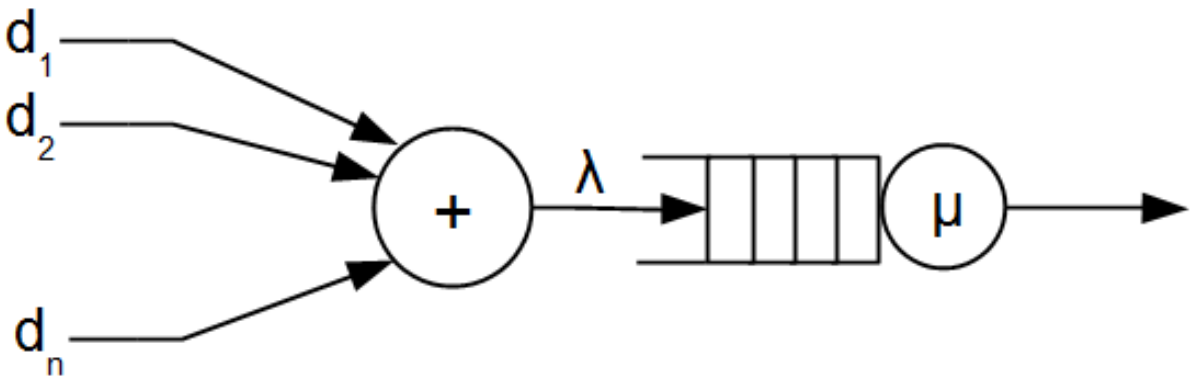

Fig. 3. Representation of a flow control application as a M/M/1 queue

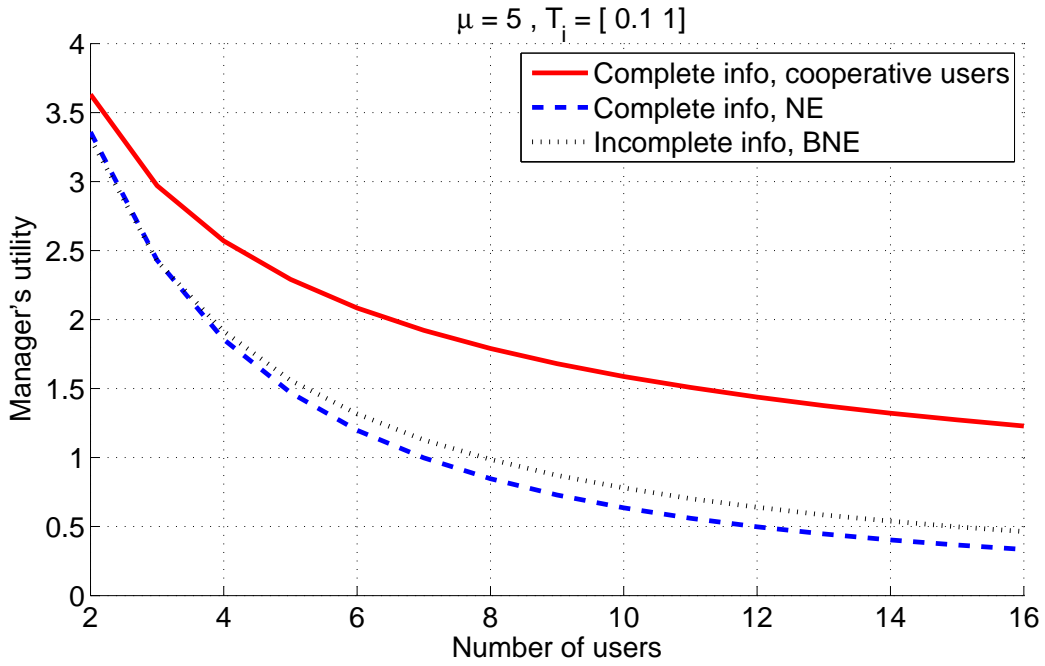

Fig. 4. Manager's utility as a function of the number of users

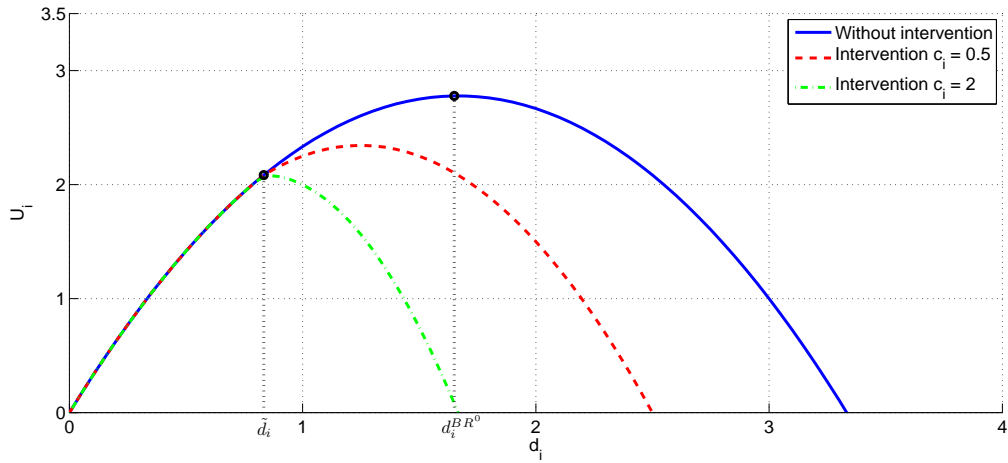

Fig. 5. User i 's utility as a function of user i 's action for different intervention rules

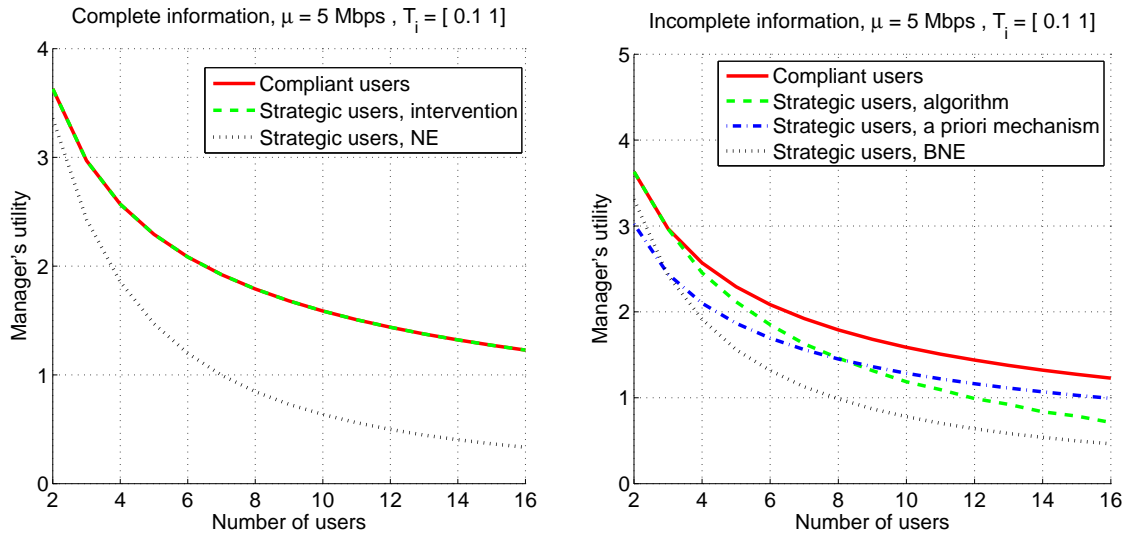

Fig. 6. Manager's expected utility vs. number of users for the complete and incomplete information scenarios

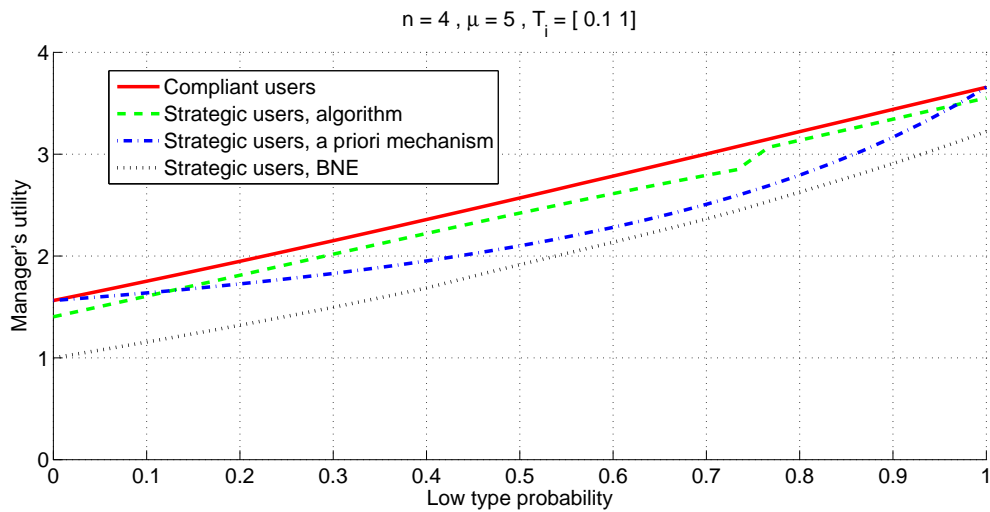

Fig. 7. Manager's expected utility vs. low type probability for the incomplete information scenario

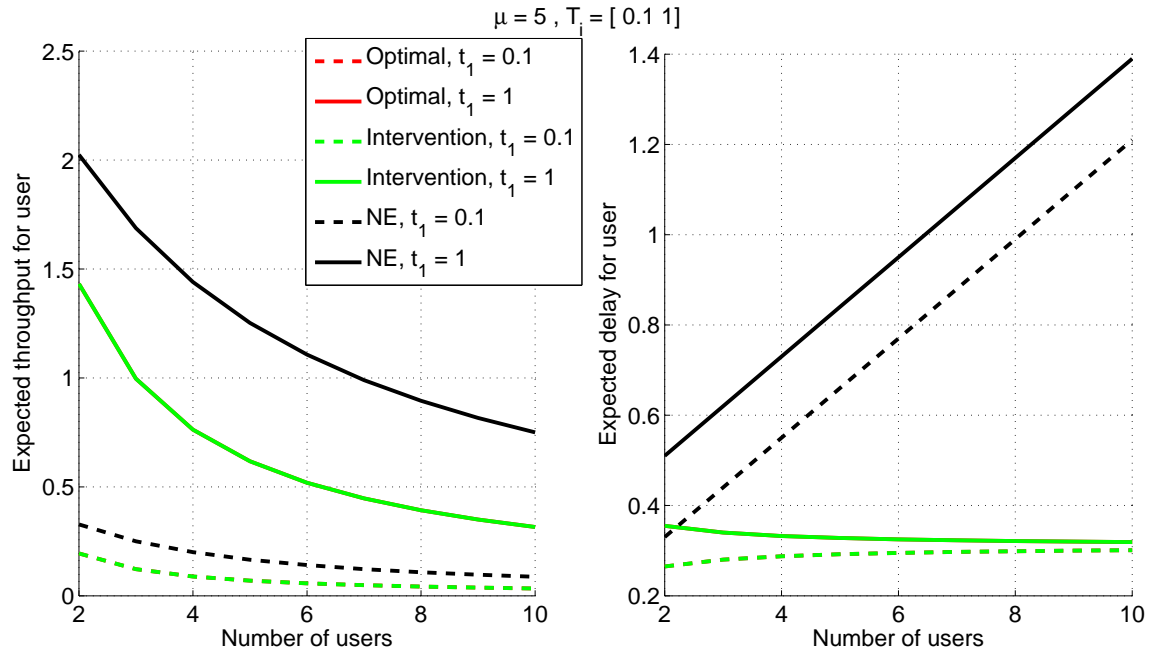

Fig. 8. Total expected throughput and delay vs. number of users for the complete information scenarios

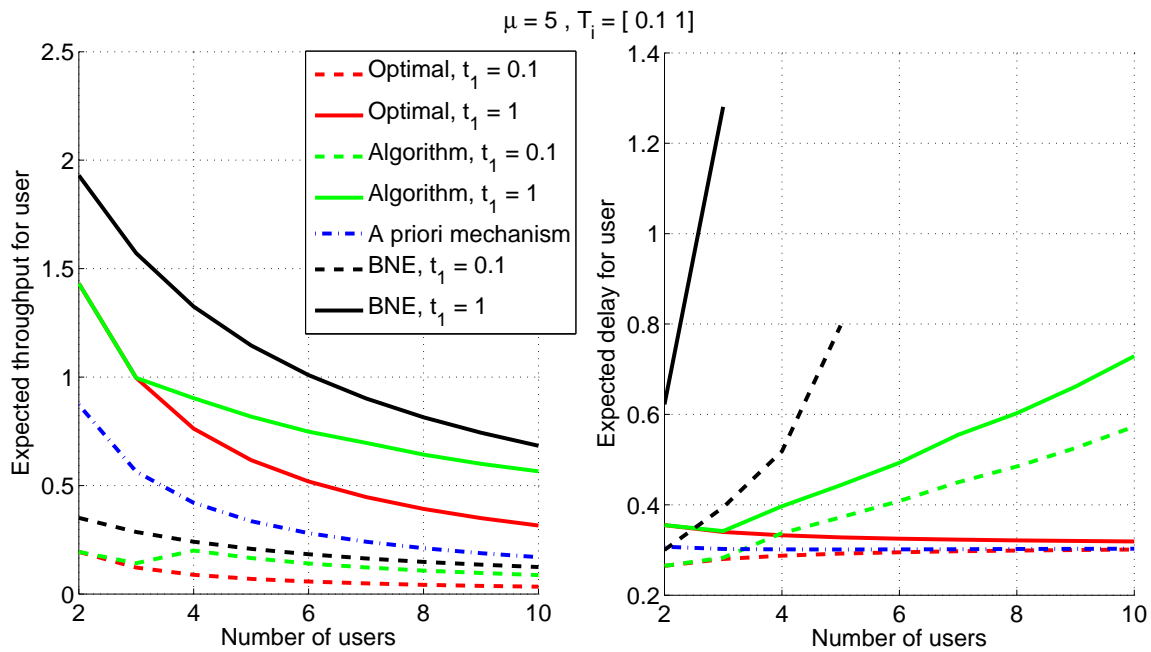

Fig. 9. Expected throughput and delay for user vs. number of users for the incomplete information scenarios