

## ON THE PLANAR ALGEBRA OF OCNEANU'S ASYMPTOTIC INCLUSION

STEPHEN CURRAN<sup>†</sup>

ABSTRACT. In recent joint work with V. Jones and D. Shlyakhtenko, we have given a diagrammatic description of Popa's symmetric enveloping inclusion for planar algebra subfactors. In this paper we give a diagrammatic construction of the associated Jones tower, in the case that the planar algebra is finite-depth. We then use this construction to describe the planar algebra of the symmetric enveloping inclusion, which is known to be isomorphic to the planar algebra of Ocneanu's asymptotic inclusion by a result of Popa. As an application we give a planar algebraic computation of the (reduced) fusion algebra of the asymptotic inclusion, recovering some well-known results of Ocneanu and Evans-Kawahigashi.

## INTRODUCTION

Let  $M_0 \subset M_1$  be a finite-index inclusion of AFD  $II_1$  factors, and let  $M_0 \subset M_1 \subset M_2 \subset \dots \subset M_\infty$  be the associated Jones tower [12]. The *asymptotic inclusion* is the subfactor  $M_1 \vee (M_1' \cap M_\infty) \subset M_\infty$ , which has finite index if and only if  $M_0 \subset M_1$  has finite depth. This construction was introduced by Ocneanu [18], who argued that the asymptotic inclusion could be viewed as the subfactor analogue of Drinfeld's quantum double construction. This connection has since been clarified by a number of authors, including Evans-Kawahigashi [4], Izumi [10, 11] and Müger [17]. A related construction for type  $III$  factors has been developed by Longo and Rehren [16].

In [19], Popa introduced the *symmetric enveloping algebra* associated to a finite index inclusion  $M_0 \subset M_1$  of arbitrary  $II_1$  factors. This is the (unique)  $II_1$  factor  $M_1 \boxtimes_{e_0} M_1^{op}$  which is generated by a copy of  $M_1 \otimes M_1^{op}$  and a projection  $e_0$  which is simultaneously the Jones projection for both  $M_0 \subset M_1$  and  $M_0^{op} \subset M_1^{op}$ . In the case that  $M_0 \subset M_1$  is a finite-depth inclusion of AFD  $II_1$  factors, Popa proved that the *symmetric enveloping inclusion*  $M_1 \otimes M_1^{op} \subset M_1 \boxtimes_{e_0} M_1^{op}$  is conjugate to Ocneanu's asymptotic inclusion. In the infinite-depth case, Popa [21] used this inclusion to analyze a number of important analytic properties of the original subfactor  $M_0 \subset M_1$ .

Planar algebras were introduced by Jones [13] in the late 90s. Any finite-index subfactor gives rise to a planar algebra as its *standard invariant*. By a fundamental result of Popa [20], any planar algebra satisfying suitable positivity conditions arises in this way. With inspiration from random matrix theory and Voiculescu's free probability, Guionnet, Jones and Shlyakhtenko [9] have recently given a diagrammatic construction of a tower of subfactors  $M_0 \subset M_1 \subset \dots$ , starting from a planar algebra  $\mathcal{P}$ . In subsequent work [8], they proved that if  $\mathcal{P}$  is finite-depth then  $M_k$  is an interpolated free group factor  $L\mathbb{F}_{r_k}$ , where  $r_k$  is computed in terms of the index  $\delta^2 = [M_1 : M_0]$  and the *global index*  $I = [M_1 \boxtimes_{e_0} M_1^{op} : M_1 \otimes M_1^{op}]$ . In joint work with Jones and Shlyakhtenko [1], we have given a diagrammatic construction of the symmetric enveloping algebra associated to these planar algebra subfactors (see also [22]). As an application of our construction, we computed a certain free entropy dimension type quantity which provides some intuition for the formula for  $r_k$ .

In this paper, we give a diagrammatic construction of the Jones tower of the symmetric enveloping inclusion for planar algebra subfactors, in the case that  $\mathcal{P}$  is finite-depth. We then use this construction to derive a complete description of the planar algebra of the asymptotic inclusion in terms of the original planar algebra  $\mathcal{P}$ . As an application, we compute the fusion rules for bimodules arising from the asymptotic inclusion, recovering some well-known results of Ocneanu and

<sup>†</sup>: Research supported by an NSF postdoctoral fellowship, NSF grant DMS-0900776 and DARPA Award 0011-11-0001.

Evans-Kawahigashi [4]. In particular, we show that the (reduced) fusion algebra of  $M_1 \boxtimes_{e_0} M_1^{op}$  bimodules is described in terms of the affine category [6], which is closely related to Ocneanu’s tube algebra [4] and Jones’ annular category [15]. The relationship between the Drinfeld center of a fusion category and the annular/affine category is well-known in the TQFT community (see e.g. [5]). In the planar algebra setting, it was very recently shown by Das, Ghosh and Gupta [3] that the category of affine Hilbert representations of a finite-depth planar algebra  $\mathcal{P}$  is equivalent to the Drinfeld center of the fusion category associated to  $\mathcal{P}$ .

The paper is organized as follows. In Section 1 we briefly recall the constructions from [9], [1]. In Section 2 we study two canonical elements appearing in any finite-depth planar algebra, and establish a number of useful “skein” relations which these satisfy. In Section 3 we construct the Jones tower for the symmetric enveloping inclusion and compute the higher relative commutants. Section 4 contains our main result: a description of the planar algebra of the asymptotic inclusion. In Section 5 we use this description to compute the fusion rules for the asymptotic inclusion.

**Acknowledgements.** I am grateful to Dimitri Shlyakhtenko for suggesting this problem, and for many useful discussions while completing this project. I would also like to thank Dietmar Bisch and Vaughan Jones for several helpful conversations.

## 1. BACKGROUND AND PRELIMINARIES

In this section we briefly recall the constructions from [9], [1].

**Planar algebra subfactors:** Let  $\mathcal{P} = (P_k)_{k \geq 0}$  be a subfactor planar algebra. For  $n, k \geq 0$  let  $P_{n,k}$  be a copy of  $P_{n+k}$ . Elements of  $P_{n,k}$  will be represented by diagrams

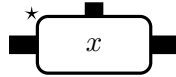

where the thick lines to the left and right represent  $k$  strings, and the thick line at top represents  $2n$  strings. We will typically suppress the marked point  $\star$ , and take the convention that it occurs at the top-left corner which is adjacent to an unshaded region.

Define a product  $\wedge_k : P_{n,k} \times P_{m,k} \rightarrow P_{n+m,k}$  by

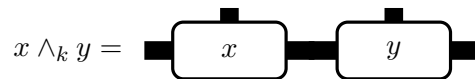

The involution  $\dagger : P_{n,k} \rightarrow P_{n,k}$  is given by

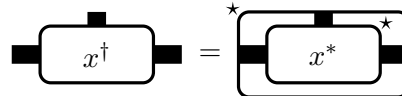

The Voiculescu trace  $\tau_k : P_{n,k} \rightarrow \mathbb{C}$  is defined by

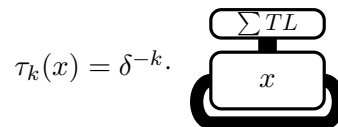

where  $\sum TL$  denotes the sum over all loopless Temperley-Lieb diagram with  $2n$  boundary points. Let  $Gr_k(\mathcal{P}) = \bigoplus_{n \geq 0} P_{n,k}$ , and observe that the formulas above give  $Gr_k(\mathcal{P})$  the structure of a graded  $*$ -algebra with trace  $\tau_k$ . The unit of  $Gr_k(\mathcal{P})$  is the element of  $P_{0,k}$  consisting of  $k$  parallel lines.



Observe also that  $Gr_k(\mathcal{P}) \boxtimes Gr_k(\mathcal{P})$  contains a copy of  $Gr_k(\mathcal{P}) \otimes Gr_k(\mathcal{P})^{op}$  as follows:

$$x \otimes y^{op} \mapsto \begin{array}{c} \star \\ \begin{array}{|c|} \hline \star \\ \hline \end{array} \\ \begin{array}{|c|} \hline x \\ \hline \end{array} \\ \begin{array}{|c|} \hline y \\ \hline \end{array} \\ \begin{array}{|c|} \hline \star \\ \hline \end{array} \\ \star \end{array}$$

Let  $\mathbf{f}_k \in Gr_k \boxtimes Gr_k$  be the projection

$$\mathbf{f}_k = \delta^{-1} \cdot \begin{array}{|c|} \hline (k-1) \\ \hline \end{array}$$

Note that  $\mathbf{f}_k$  implements the Jones projections for both  $M_{k-1} \subset M_k$  and  $M_{k-1}^{op} \subset M_k^{op}$ .

We have proved the following result in [1]:

**Theorem 1.2.** *For  $k \geq 0$ ,  $\tau_k \boxtimes \tau_k$  is a faithful, tracial state on  $Gr_k(\mathcal{P}) \boxtimes Gr_k(\mathcal{P})$ , and its GNS completion is a  $II_1$  factor  $M_k \boxtimes M_k$  as long as  $\delta > 1$ . The inclusion  $Gr_k(\mathcal{P}) \otimes Gr_k(\mathcal{P}) \subset Gr_k \boxtimes Gr_k$  extends to  $M_k \otimes M_k \subset M_k \boxtimes M_k$ . Moreover, for  $k \geq 1$  we have that  $M_k \otimes M_k^{op} \subset M_k \boxtimes M_k^{op}$  is isomorphic to Popa's symmetric enveloping inclusion  $M_k \otimes M_k^{op} \subset M_k \boxtimes_{\mathbf{f}_{k-1}} M_k$ .  $\square$*

## 2. SKEIN RELATIONS

In this section we introduce two canonical elements  $p$  and  $q$  appearing in any finite-depth planar algebra, and describe a number of diagrammatic relations which they satisfy.

Throughout the paper  $\mathcal{P} = (P_k)_{k \geq 0}$  will be a subfactor planar algebra. Let  $\Gamma$  denote the principal graph of  $\mathcal{P}$  (see e.g. [7]), and let  $\Gamma_+$  denote the collection of even vertices. Associated to each  $v \in \Gamma_+$  is an irreducible  $M_0 - M_0$  bimodule  $X_v$ . We let  $*$  denote the distinguished vertex, corresponding to the bimodule  $X_* = L^2(M_0)$ .

We will assume that  $\Gamma_+$  is finite (i.e.  $\mathcal{P}$  is finite-depth), and throughout the paper we fix  $k$  such that  $d(*, v) \leq 2k$  for all  $v \in \Gamma_+$ . It follows that we have

$${}_{M_0}L^2(M_k)_{M_0} \simeq \bigoplus_{v \in \Gamma_+} X_v \otimes \mathcal{H}_v,$$

where  $\mathcal{H}_v$  are auxiliary finite-dimensional Hilbert spaces, whose dimensions we denote by  $n_v$ .

It follows that

$${}_{M_0 \otimes M_0^{op}}L^2(M_k \otimes M_k^{op})_{M_0 \otimes M_0^{op}} \simeq \bigoplus_{v, w \in \Gamma_+} X_v \otimes \overline{X_w} \otimes (\mathcal{H}_v \otimes \overline{\mathcal{H}_w}),$$

where  $\overline{X_w}$  is the contragredient bimodule and  $\overline{\mathcal{H}_w}$  is the conjugate Hilbert space. Let  $1_v \in \mathcal{H}_v \otimes \overline{\mathcal{H}_v}$  be the unit under the natural identification with  $\text{Hom}_{\mathbb{C}}(\mathcal{H}_v)$ , and define  $p_v$  to be the projection from  $L^2(M_k \otimes M_k^{op})$  onto  $X_v \otimes \overline{X_v} \otimes 1_v$ . Then define

$$p = \sum_{v \in \Gamma_+} p_v.$$

Recall that  $P_{2k}$  can be identified with  $\text{Hom}_{M_0, M_0}(L^2(M_k))$ , in particular the central projections of  $P_{2k}$  are indexed by  $v \in \Gamma_+$ . By an abuse of notation we will use  $v$  to denote the central projection corresponding to the vertex  $v$ . Let  $(\mu_v)_{v \in \Gamma}$  be the Perron-Frobenius eigenvector of the adjacency matrix for  $\Gamma$ , normalized by  $\mu(*) = 1$ . Then the trace of a minimal projection in the central component of  $P_{2k}$  corresponding to  $v \in \Gamma_+$  is  $\text{tr}_{P_{2k}}(v) = \delta^{-2k} \mu_v$ .

Note that if  $\{e_{ij}(v) : 1 \leq i, j \leq n_v\}$  are matrix units for the central component of  $P_{2k}$  corresponding to  $v \in \Gamma_+$ , then we have

$$p_v = \frac{1}{n_v} \sum_{1 \leq i, j \leq n_v} e_{ij}(v) \otimes e_{ji}(v)^{op}.$$

Graphically, we will represent  $p_v$  using a Sweedler type convention as follows:

$$p_v = \begin{array}{c} \star \\ \text{---} \boxed{p_v^{(1)}} \text{---} \\ \text{---} \boxed{p_v^{(2)}} \text{---} \\ \star \end{array}$$

The projection  $p_v$  satisfies the following key skein relation:

**Lemma 2.1.** *Let  $x, y \in P_{2k}$  and  $v \in \Gamma_+$ , then we have*

$$\begin{array}{c} \star \quad \star \\ \text{---} \boxed{p_v^{(1)}} \text{---} \boxed{x} \text{---} \\ \text{---} \boxed{p_v^{(2)}} \text{---} \boxed{y} \text{---} \\ \star \quad \star \end{array} = \frac{\mu_v}{n_v} \cdot \begin{array}{c} \star \\ \text{---} \boxed{x} \text{---} \boxed{v} \text{---} \\ \text{---} \boxed{y} \text{---} \\ \star \end{array}$$

*Proof.* The left hand side is equal to

$$\frac{\delta^{4k}}{n_v} \sum_{1 \leq i, j \leq n_v} \text{tr}(e_{ij}(v)x) \cdot \text{tr}(ye_{ji}(v)) = \frac{\delta^{4k}}{n_v} \cdot \delta^{-2k} \mu_v \cdot \text{tr}(xy \cdot v),$$

which is equal to the right hand side.  $\square$

We will now derive a number of ‘skein’ relations for the projection  $p$ . First we recall the following well known relation:

**Lemma 2.2.** *For  $x, y \in P_k$  we have*

$$\begin{array}{c} \star \\ \boxed{x} \\ \boxed{v} \star \\ \boxed{y} \\ \star \end{array} = \delta_{v, \star} \begin{array}{c} \star \\ \boxed{x} \\ \text{---} \\ \boxed{y} \\ \star \end{array}$$

$\square$

**Proposition 2.3.**  *$p$  satisfies the following skein relations:*

(1) *Trace:  $\text{tr}_{P_{2k}}(p) = \delta^{-4k} I$ , i.e.*

$$\begin{array}{c} \star \\ \text{---} \boxed{p^{(1)}} \text{---} \\ \text{---} \boxed{p^{(2)}} \text{---} \\ \star \end{array} = I$$

(2) *Rotational invariance:*

$$\begin{array}{c} \star \quad \star \\ \text{---} \boxed{p^{(1)}} \text{---} \\ \text{---} \boxed{p^{(2)}} \text{---} \\ \star \quad \star \end{array} = \begin{array}{c} \star \\ \text{---} \boxed{p^{(1)}} \text{---} \\ \text{---} \boxed{p^{(2)}} \text{---} \\ \star \end{array}$$

(3) *Capping:*

$$\begin{array}{c} \text{---} p_1^{(1)} \text{---} \\ \text{---} p_1^{(2)} \text{---} \end{array} = \frac{\delta^k}{n_*} \cdot \begin{array}{c} \text{---} * \text{---} \end{array}$$

(4) *Multiplication:* We have

$$\begin{array}{c} \text{---} p_1^{(1)} \text{---} \\ \text{---} p_1^{(2)} \text{---} \end{array} = \text{---}$$

*Proof.* For (1), we have

$$\text{tr}_{P_{2k}}(p) = \sum_{v \in \Gamma_+} n_v^{-1} \sum_{1 \leq i, j \leq n_v} \text{tr}_{P_{2k}(v)}(e_{ij}(v))^2 = \sum_{v \in \Gamma_+} \delta^{-4k} \mu_v^2 = \delta^{-4k} I.$$

(2) follows easily from Lemma 2.1, and the fact that

$$\begin{array}{c} \text{---} v \text{---} \\ \text{---} \bar{v} \text{---} \end{array}$$

where  $\bar{v}$  is the vertex corresponding to the conjugate bimodule  $\overline{X_v}$ .

By Lemma 2.1 we have

$$\begin{array}{c} \text{---} p_1^{(1)} \text{---} x \text{---} \\ \text{---} p_1^{(2)} \text{---} y \text{---} \end{array} = \sum_{v \in \Gamma_+} \frac{\mu_v}{n_v} \cdot \begin{array}{c} \text{---} v \text{---} \\ \text{---} x \text{---} \\ \text{---} y \text{---} \end{array}$$

for any  $x, y \in P_k$ . (3) then follows from Lemma 2.2.

For (4), the left hand side is equal to

$$\sum_{v \in \Gamma_+} \frac{1}{n_v} \sum_{1 \leq i, j \leq n_v} e_{ij}(v) e_{ji}(v) = \sum_{v \in \Gamma_+} v = 1.$$

□

We now introduce an element  $q \in P_{3k}$ , which will be central to our constructions.

**Proposition 2.4.** *Fix  $v, w, z \in \Gamma_+$ . Then there is a unique element  $q_{v,w,z} \in P_{3k} \otimes P_{3k}^{op}$ , which we represent in Sweedler notation as  $q_{v,w,z} = q_{v,w,z}^{(1)} \otimes q_{v,w,z}^{(2)}$ , with the property that for any  $x, y \in P_{3k}$  we have*

$$\begin{array}{c} \text{---} q_{v,w,z}^{(1)} \text{---} x \text{---} \\ \text{---} q_{v,w,z}^{(2)} \text{---} y \text{---} \end{array} = I^{-1/2} \cdot \left( \frac{\mu_v \mu_w \mu_z}{n_v n_w n_z} \right)^{1/2} \cdot \begin{array}{c} \text{---} x \text{---} \\ \text{---} z \text{---} \\ \text{---} y \text{---} \\ \text{---} w \text{---} \\ \text{---} v \text{---} \end{array}$$

*Proof.* With the obvious unital embedding of  $P_{3k} \otimes P_{3k}^{op}$  into  $P_{6k}$ , we have

$$q_{v,w,z} = I^{-1/2} \left( \frac{\mu_v \mu_w \mu_z}{n_v n_w n_z} \right)^{1/2} E_{P_{3k} \otimes P_{3k}^{op}} \left[ \begin{array}{c} \text{Diagram: A rectangular box with two vertical strands on the left and two on the right. Each strand has a small circle with a star on it. The strands are connected by two horizontal arcs, one at the top and one at the bottom, forming a central region with two small circles labeled v, w, z. The top arc is labeled v, the middle w, and the bottom z. The entire diagram is enclosed in large square brackets. \end{array} \right]$$

□

Define

$$q = \sum_{v,w,z \in \Gamma_+} q_{v,w,z}.$$

**Proposition 2.5.** *q satisfies the following skein relations:*

(1) *Compatibility with p:*

$$\begin{array}{c} \text{Diagram: Two strands, top labeled } q^{(1)} \text{ and } p^{(1)}, \text{ bottom labeled } q^{(2)} \text{ and } p^{(2)}. \end{array} = \begin{array}{c} \text{Diagram: Two strands, top labeled } q^{(1)}, \text{ bottom labeled } q^{(2)}. \end{array} \quad \text{and} \quad \begin{array}{c} \text{Diagram: Two strands, top labeled } p^{(1)} \text{ and } q^{(1)}, \text{ bottom labeled } p^{(2)} \text{ and } q^{(2)}. \end{array} = \begin{array}{c} \text{Diagram: Two strands, top labeled } q^{(1)}, \text{ bottom labeled } q^{(2)}. \end{array}$$

(2) *Rotation:*

$$\begin{array}{c} \text{Diagram: Two strands, top labeled } q^{(1)}, \text{ bottom labeled } q^{(2)}. \end{array} = \begin{array}{c} \text{Diagram: Two strands, top labeled } q^{(1)}, \text{ bottom labeled } q^{(2)}. \end{array}$$

(3) *Capping: If  $x, y \in P_k$  then*

$$\begin{array}{c} \text{Diagram: Two strands, top labeled } q^{(1)}, \text{ bottom labeled } q^{(2)}. \text{ Top strand has a cap labeled } x, \text{ bottom strand has a cap labeled } y. \end{array} = I^{-1/2} n_*^{-1/2} \cdot \begin{array}{c} \text{Diagram: Two strands, top labeled } p^{(1)}, \text{ bottom labeled } p^{(2)}. \text{ Top strand has a cap labeled } x, \text{ bottom strand has a cap labeled } y. \end{array}$$

(4) *Double capping:*

$$\begin{array}{c} \text{Diagram: Two strands, top labeled } q^{(1)}, \text{ bottom labeled } q^{(2)}. \text{ Top strand has a cap labeled } x, \text{ bottom strand has a cap labeled } y. \end{array} = I^{-1/2} n_*^{-1/2} \cdot \begin{array}{c} \text{Diagram: Two strands, top labeled } p^{(1)}, \text{ bottom labeled } p^{(2)}. \text{ Top strand has a cap labeled } x, \text{ bottom strand has a cap labeled } y. \end{array}$$

(5) *Connecting:*

$$\begin{array}{c} \text{Diagram: Two strands, top labeled } q^{(1)}, \text{ bottom labeled } q^{(2)}. \text{ Top strand has a cap labeled } x, \text{ bottom strand has a cap labeled } y. \end{array} = I^{-1/2} n_*^{1/2} \cdot \begin{array}{c} \text{Diagram: Two strands, top labeled } p^{(1)}, \text{ bottom labeled } p^{(2)}. \end{array}$$

*Proof.* (1) and (2) follow easily from Proposition 2.4. (3) follows from Proposition 2.4 and Lemma 2.1. (4) follows from (2) and (3), and then (5) clearly follows from (4). □

The finite-depth assumption has not been essential so far, but the following consequence will be crucial in the remainder of the paper.

**Proposition 2.6.** *Let  $m \geq k$ , then  $P_{2m}$  is spanned by elements of the form*

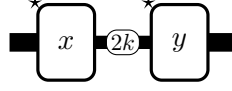

for  $x, y \in P_{m+k}$ .

*Proof.* Since the depth of  $\mathcal{P}$  is less than or equal to  $2k$ , we have that  $P_{2k+1}$  is equal to the basic construction of  $P_{2k-1} \subset P_{2k}$ . So  $P_{2k+1}$  is generated by  $P_{2k}$  and the Jones projection  $e_{2k-1}$ . Iterating, we see that  $P_{2m}$  is generated by  $P_{2k}$  and  $e_{2k-1}, \dots, e_{2m-2}$ , from which the result easily follows.  $\square$

**Proposition 2.7.** *Fix  $w, z \in \Gamma_+$ , then we have*

$$\sum_{v \in \Gamma_+} \left( \frac{\mu_v}{n_v} \right)^{1/2} \cdot \begin{array}{c} \star \\ \text{\scriptsize } q_{v,w,z}^{(1)} \\ \text{\scriptsize } q_{v,w,z}^{(2)} \\ \star \end{array} = I^{-1/2} \left( \frac{\mu_w \mu_z}{n_w n_z} \right)^{1/2} \cdot \begin{array}{c} \star \\ w \\ \star \\ \star \\ z \\ \star \end{array}$$

*Proof.* By Proposition 2.6, it suffices to show that

$$\sum_{v \in \Gamma_+} \left( \frac{\mu_v}{n_v} \right)^{1/2} \cdot \begin{array}{c} \star \\ \text{\scriptsize } q_{v,w,z}^{(1)} \quad x \\ \text{\scriptsize } q_{v,w,z}^{(2)} \quad y \\ \star \end{array} = I^{-1/2} \left( \frac{\mu_w \mu_z}{n_w n_z} \right)^{1/2} \begin{array}{c} \star \\ x \\ \star \\ w \quad z \\ \star \\ y \\ \star \end{array}$$

for any  $x, y \in P_{3k}$ .

Now by Lemma 2.1, the left hand side of the above equation is equal to

$$\sum_{v \in \Gamma_+} \left( \frac{\mu_v}{n_v} \right)^{1/2} \cdot \frac{n_v}{\mu_v} \cdot \begin{array}{c} \star \\ \text{\scriptsize } p_v^{(1)} \quad \text{\scriptsize } q_{v,w,z}^{(1)} \quad x \\ \text{\scriptsize } p_v^{(2)} \quad \text{\scriptsize } q_{v,w,z}^{(2)} \quad y \\ \star \end{array}$$

By Proposition 2.4 this is equal to

$$\sum_{v \in \Gamma_+} \left( \frac{\mu_v}{n_v} \right)^{1/2} \cdot \frac{n_v}{\mu_v} \cdot I^{-1/2} \cdot \left( \frac{\mu_v \mu_w \mu_z}{n_v n_w n_z} \right)^{1/2} \begin{array}{c} \star \\ \text{\scriptsize } p_v^{(1)} \quad x \\ \text{\scriptsize } p_v^{(2)} \quad w \quad z \\ \star \\ y \\ \star \end{array}$$

The result then follows from (4) of Proposition 2.3.  $\square$



**Corollary 2.8.** Fix  $v_1, v_2, z_1, z_2 \in \Gamma_+$ . Then if  $x, y \in P_{4k}$  we have

$$\sum_{z \in \Gamma_+} \begin{array}{c} \text{---} x \text{---} \\ \text{---} q_{v_1, w_1, z}^{(1)} \text{---} q_{z, w_2, v_2}^{(1)} \text{---} \\ \text{---} q_{v_1, w_1, z}^{(2)} \text{---} q_{z, w_2, v_2}^{(2)} \text{---} \\ \text{---} y \text{---} \end{array} = I^{-1} \cdot \left( \frac{\mu_{v_1} \mu_{v_2} \mu_{w_1} \mu_{w_2}}{n_{v_1} n_{v_2} n_{w_1} n_{w_2}} \right)^{1/2} \cdot \begin{array}{c} \text{---} x \text{---} \\ \text{---} v_1 \text{---} w_1 \text{---} w_2 \text{---} v_2 \text{---} \\ \text{---} y \text{---} \end{array}$$

*Proof.* By Proposition 2.4, the left hand side of the equation in the statement of the proposition is equal to

$$\sum_{z \in \Gamma_+} I^{-1/2} \left( \frac{\mu_{v_1} \mu_{w_1} \mu_z}{n_{v_1} n_{w_1} n_z} \right)^{1/2} \cdot \begin{array}{c} \text{---} x \text{---} \\ \text{---} v_1 \text{---} w_1 \text{---} \\ \text{---} q_{z, w_2, v_2}^{(1)} \text{---} \\ \text{---} q_{z, w_2, v_2}^{(2)} \text{---} \\ \text{---} y \text{---} \end{array}$$

and the result then follows from Proposition 2.7. □

**Corollary 2.9.** Let  $q_1 = q_1^{(1)} \otimes q_1^{(2)}$  and  $q_2 = q_2^{(1)} \otimes q_2^{(2)}$  be copies of  $q$ . Then

$$\begin{array}{c} \text{---} q_1^{(1)} \text{---} q_2^{(1)} \text{---} \\ \text{---} q_1^{(2)} \text{---} q_2^{(2)} \text{---} \end{array} = \begin{array}{c} \text{---} q_2^{(1)} \text{---} \\ \text{---} q_1^{(1)} \text{---} \\ \text{---} q_1^{(2)} \text{---} \\ \text{---} q_2^{(2)} \text{---} \end{array}$$

*Proof.* It follows from Corollary 2.8 and Proposition 2.7 that

$$\begin{array}{c} \text{---} q_1^{(1)} \text{---} q_2^{(1)} \text{---} \\ \text{---} q_1^{(2)} \text{---} q_2^{(2)} \text{---} \end{array} = \begin{array}{c} \text{---} q_2^{(1)} \text{---} \\ \text{---} q_1^{(1)} \text{---} \\ \text{---} q_1^{(2)} \text{---} \\ \text{---} q_2^{(2)} \text{---} \end{array}$$

The result then follows from (2) of Proposition 2.5. □

**Corollary 2.10.** Let  $q_1, q_2$  be copies of  $q$ . Then we have

$$\begin{array}{c} \text{---} q_1^{(1)} \text{---} q_2^{(1)} \text{---} \\ \text{---} q_1^{(2)} \text{---} q_2^{(2)} \text{---} \end{array} = \begin{array}{c} \text{---} p^{(1)} \text{---} \\ \text{---} p^{(2)} \text{---} \end{array}$$

*Proof.* By Corollary 2.9 and (3) of Proposition 2.5, we have

$$= I^{-1/2} n_*^{-1/2}.$$

The result follows by applying (4) of Proposition 2.5 and (1) of Proposition 2.3. □

### 3. THE JONES TOWER

In this section we compute the Jones tower for the inclusion  $M_0 \otimes M_0^{op} \subset M_0 \boxtimes M_0^{op}$ . Our construction is easily modified to obtain the Jones tower for the symmetric enveloping inclusion  $M_1 \otimes M_1^{op} \subset M_1 \boxtimes M_1^{op}$ . However, we prefer to work with  $M_0 \otimes M_0^{op}$  as it simplifies the diagrams. As discussed in Remark 4.7 in the following section, this is sufficient to compute the planar algebra of the asymptotic inclusion.

As above, we will assume that  $\mathcal{P}$  is a finite-depth planar algebra and that  $depth(\mathcal{P}) \leq 2k$ .

Fix  $n \geq 0$ . Recall from Section 1 that we have a graphical representation of  $P_{s,(2n+1)k} \otimes P_{t,(2n+1)k}$  as the span of elements of the form

$$x \otimes y = \begin{array}{c} \star \\ \star \\ \boxed{x} \\ \star \\ \star \\ \boxed{y} \\ \star \\ \star \end{array}$$

for  $x \in P_{s,(2n+1)k}$  and  $y \in P_{t,(2n+1)k}$ .

For  $s, t \geq 0$  let  $\mathcal{V}_{2n+1}(s, t)$  be the subspace of  $P_{s,(2n+1)k} \otimes P_{t,(2n+1)k}$  spanned by

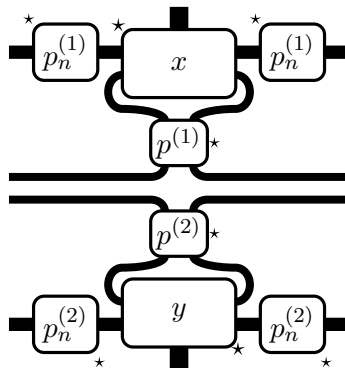



Finally set

$$1_{\mathcal{A}_{2n+1}} = \begin{array}{c} \star \\ \boxed{p_n^{(1)}} \\ \text{---} \\ \boxed{q^{(1)}} \star \\ \text{---} \\ \boxed{q^{(2)}} \star \\ \text{---} \\ \boxed{p_n^{(2)}} \star \end{array} = I^{1/2} n_*^{-1/2} \cdot \begin{array}{c} \star \\ \boxed{p_n^{(1)}} \\ \text{---} \\ \boxed{\star} \star \\ \text{---} \\ \boxed{p_n^{(2)}} \star \end{array}$$

Now define  $\Psi_n : \mathcal{V}_{2n+1}(s, t) \rightarrow \mathcal{V}_{2nk}(s, t)$  to be the linear map determined by

$$\Psi_n(x \otimes y) = I^{-1/2} \sum_{v \in \Gamma_+} \left( \frac{\mu_v}{n_v} \right)^{1/2} \cdot \begin{array}{c} \star \\ \boxed{x} \\ \text{---} \\ \boxed{v} \star \\ \text{---} \\ \boxed{y} \star \end{array}$$

**Proposition 3.1.**  $\Psi_n$  is an isomorphism of  $(\mathcal{A}_{2n+1}, \star_q)$  onto  $p_n(Gr_{2nk} \boxtimes Gr_{2nk}^{op})p_n$ . We have  $\Psi_n(1_{\mathcal{A}_{2n+1}}) = p_n$ , and

$$\delta^{4nk} I^{-n} (\tau_{2nk} \boxtimes \tau_{2nk}) \circ \Psi_n = \varphi_{2n+1}.$$

*Proof.* The fact that  $\Psi_0$  is injective was proved in [1] (note that our  $\Psi_0$  was denoted by  $\Psi_k$  there, and had a different scaling factor). The argument given there extends easily to  $\Psi_n$  for  $n > 0$ . It is clear that  $\Psi_n$  respects the involutions on  $\mathcal{A}_{2n+1}$  and  $Gr_{2nk} \boxtimes Gr_{2nk}^{op}$ . That  $\Psi_n(1_{\mathcal{A}_{2n+1}}) = p_n$  and that  $\delta^{4nk} I^{-n} (\tau_{2nk} \boxtimes \tau_{2nk}) \circ \Psi_n = \varphi_{2n+1}$  are clear from the definitions and Lemma 2.2. Surjectivity follows from Lemma 2.6.

It remains only to show that  $\Psi_n$  is a homomorphism. We have

$$\Psi_n((x_1 \otimes y_1) \star_q (x_2 \otimes y_2)) = I^{-1/2} \sum_{v \in \Gamma_+} \left( \frac{\mu_v}{n_v} \right)^{1/2} \begin{array}{c} \star \quad \star \\ \boxed{x_1} \quad \boxed{2nk} \quad \boxed{x_2} \\ \text{---} \\ \boxed{q^{(1)}} \\ \text{---} \\ \boxed{v} \star \\ \text{---} \\ \boxed{q^{(2)}} \\ \text{---} \\ \boxed{y_1} \quad \boxed{2nk} \quad \boxed{y_2} \star \end{array}$$

which by Proposition 2.7 is equal to

$$I^{-1} \sum_{w, z \in \Gamma_+} \left( \frac{\mu_w \mu_z}{n_w n_z} \right)^{1/2} \begin{array}{c} \star \quad \star \\ \boxed{x_1} \quad \boxed{2nk} \quad \boxed{x_2} \\ \text{---} \\ \boxed{w} \star \\ \text{---} \\ \boxed{y_1} \quad \boxed{2nk} \quad \boxed{y_2} \star \\ \text{---} \\ \boxed{z} \star \end{array}$$



*Proof.* We have

$$\langle i_{2n}(a \otimes b), x \otimes y \rangle = I^{-\frac{2n+1}{2}} n_*^{-1/2} .$$

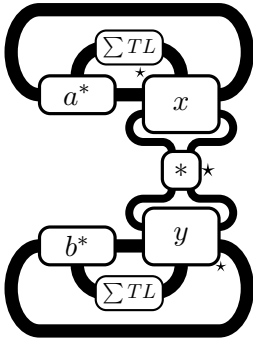
 $= \langle a \otimes b, E_{\mathcal{M}_{2n}}(x \otimes y) \rangle$

from which the result follows. □

Now define inclusions  $i_{2n+1} : \mathcal{A}_{2n+1} \rightarrow \mathcal{A}_{2n+2}$  by

$$i_{2n+1}(x \otimes y) =$$

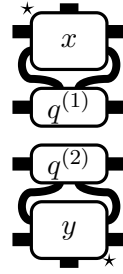

**Proposition 3.5.**  $i_{2n+1}$  extends to a unital, trace preserving embedding of  $\mathcal{M}_{2n+1}$  into  $\mathcal{M}_{2n+2}$ . Moreover, the following diagram commutes:

$$\begin{array}{ccc} \mathcal{M}_{2n} & \xrightarrow{i_{2n+1} \circ i_{2n}} & \mathcal{M}_{2n+2} \\ \simeq \downarrow & & \downarrow \simeq \\ p_n(M_{2nk} \otimes M_{2nk}^{op})p_n & \longrightarrow & p_{n+1}(M_{(2n+2)k} \otimes M_{(2n+2)k}^{op})p_{n+1} \end{array}$$

where the arrow on the bottom row is the obvious inclusion.

*Proof.* This follows from combining (3) and (4) of Proposition 2.5 and (1) of Proposition 2.3. □

Now define  $E_{\mathcal{M}_{2n+1}} : \mathcal{A}_{2n+2} \rightarrow \mathcal{A}_{2n+1}$  by

$$E_{\mathcal{M}_{2n+1}}(x \otimes y) =$$

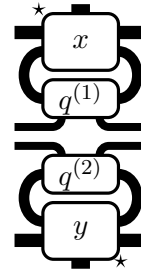

**Proposition 3.6.**  $E_{\mathcal{M}_{2n+1}}$  extends to the unique  $\varphi_{2n+2}$ -preserving conditional expectation of  $\mathcal{M}_{2n+2}$  onto  $\mathcal{M}_{2n+1}$ .

*Proof.* Draw the picture and apply Proposition 2.5 (5) to see that

$$\langle a \otimes b, E_{\mathcal{M}_{2n+1}}(x \otimes y) \rangle = \langle i_{2n+1}(a \otimes b), x \otimes y \rangle,$$

from which the result follows. □

Now define  $\mathbf{e}_{2n} \in \mathcal{A}_{2n+2}$  by

$$\mathbf{e}_{2n} = I^{-1} \cdot \left[ \begin{array}{c} \text{---} p_n^{(1)} \text{---} \\ \text{---} q_1^{(1)} \text{---} \text{---} q_2^{(1)} \text{---} \\ \text{---} q_1^{(2)} \text{---} \text{---} q_2^{(2)} \text{---} \\ \text{---} p_n^{(2)} \text{---} \end{array} \right] = n_*^{-1} \cdot \left[ \begin{array}{c} \text{---} p_n^{(1)} \text{---} \\ \text{---} * \text{---} * \text{---} \\ \text{---} p_n^{(2)} \text{---} \end{array} \right]$$

where the second equality follows from Proposition 2.5 (4).

Also define  $\mathbf{e}_{2n+1} \in \mathcal{A}_{2n+3}$  by

$$\mathbf{e}_{2n+1} = \left[ \begin{array}{c} \text{---} p_n^{(1)} \text{---} \\ \text{---} q^{(1)} \text{---} \\ \text{---} q^{(2)} \text{---} \\ \text{---} p_n^{(2)} \text{---} \end{array} \right]$$

**Theorem 3.7.**  $(\mathcal{M}_n, I^{-1/2} \mathbf{e}_n)$  is the Jones tower for the subfactor  $\mathcal{M}_0 \subset \mathcal{M}_1$ .

*Proof.* It follows from Propositions 3.4 and 3.6 that  $\mathbf{e}_n$  is the Jones projection for  $\mathcal{M}_n \subset \mathcal{M}_{n+1}$ . So it remains to show that  $\mathcal{M}_{n+2}$  is the basic construction for  $\mathcal{M}_n \subset \mathcal{M}_{n+1}$  for all  $n \geq 0$ .

We first prove that  $\mathcal{M}_{2n+2}$  is the basic construction of  $\mathcal{M}_{2n} \subset \mathcal{M}_{2n+1}$ . Indeed, by a standard result in subfactor theory we have that the subalgebra  $\langle \mathcal{M}_{2n+1}, \mathbf{e}_{2n} \rangle$  of  $\mathcal{M}_{2n+2}$  which is generated by  $\mathcal{M}_{2n+1}$  and  $\mathbf{e}_{2n}$  is isomorphic to the basic construction of  $\mathcal{M}_{2n} \subset \mathcal{M}_{2n+1}$ . Note that by Proposition 3.3 we have

$$\begin{aligned} [\mathcal{M}_{2n+1} : \mathcal{M}_{2n}] &= [p_n(M_{2nk} \boxtimes M_{2nk}^{op})p_n : p_n(M_{2nk} \otimes M_{2nk}^{op})p_n] \\ &= [M_{2nk} \boxtimes M_{2nk} : M_{2nk} \otimes M_{2nk}^{op}] = I. \end{aligned}$$

It follows that  $[\langle \mathcal{M}_{2n+1}, \mathbf{e}_{2n} \rangle : \mathcal{M}_{2n}] = I^2$ . By Proposition 3.5 we have

$$\begin{aligned} [\mathcal{M}_{2n+2} : \mathcal{M}_{2n}] &= [p_{n+1}(M_{2(n+1)k} \otimes M_{2(n+1)k}^{op})p_{n+1} : p_n(M_{2nk} \otimes M_{2nk}^{op})p_n] \\ &= \left( \frac{(\tau_{2(n+1)k} \otimes \tau_{2(n+1)k})(p_{n+1})}{(\tau_{2nk} \otimes \tau_{2nk})(p_n)} \right)^2 \cdot [M_{2(n+1)k} \otimes M_{2(n+1)k} : M_{2nk} \otimes M_{2nk}] \\ &= \delta^{-8k} I^2 \cdot \delta^{8k} \\ &= [\langle \mathcal{M}_{2n+1}, \mathbf{e}_{2n} \rangle : \mathcal{M}_{2n}], \end{aligned}$$

which implies that  $\mathcal{M}_{2n+2} = \langle \mathcal{M}_{2n+1}, \mathbf{e}_{2n} \rangle$  is the Jones basic construction as claimed.

It now follows that  $\mathcal{M}_{2n+3}$  is the basic construction for  $\mathcal{M}_{2n+1} \subset \mathcal{M}_{2n+2}$ . Indeed, we have  $\langle \mathcal{M}_{2n+2}, \mathbf{e}_{2n+1} \rangle \subset \mathcal{M}_{2n+3}$ . But since we have shown that  $\mathcal{M}_{2n+4}$  is the basic construction of  $\mathcal{M}_{2n+2} \subset \mathcal{M}_{2n+3}$ , we have

$$[\mathcal{M}_{2n+3} : \mathcal{M}_{2n+2}] = [\mathcal{M}_{2n+4} : \mathcal{M}_{2n+2}]^{1/2} = I = [\langle \mathcal{M}_{2n+2}, \mathbf{e}_{2n+1} \rangle : \mathcal{M}_{2n+2}],$$

so that  $\mathcal{M}_{2n+3} = \langle \mathcal{M}_{2n+2}, \mathbf{e}_{2n+1} \rangle$  as desired. □

It follows that the planar algebra  $\mathcal{P}(\mathcal{M}_0 \subset \mathcal{M}_1)$  is isomorphic to  $\mathcal{P}(M_0 \otimes M_0^{op} \subset M_0 \boxtimes M_0^{op})$ . We will now compute the higher relative commutants  $\mathcal{M}'_i \cap \mathcal{M}_n$  for  $i = 0, 1$ , we compute the action of planar tangles in the next section.

**Proposition 3.8.** *The higher relative commutants are as follows:*

(1) For  $n \geq 0$ ,  $\mathcal{M}'_0 \cap \mathcal{M}_{2n}$  is spanned by elements of the form:

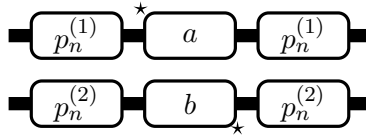

(2) For  $n \geq 0$ ,  $\mathcal{M}'_0 \cap \mathcal{M}_{2n+1}$  is spanned by elements of the form:

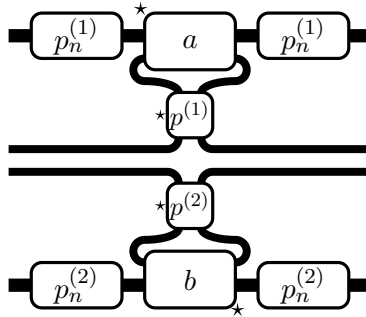

(3) For  $n \geq 1$ ,  $\mathcal{M}'_1 \cap \mathcal{M}_{2n}$  is spanned by elements of the form:

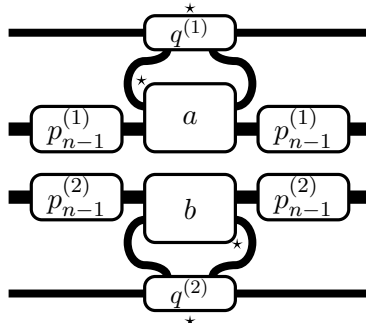



(4) For  $n \geq 1$ ,  $\mathcal{M}'_1 \cap \mathcal{M}_{2n+1}$  is spanned by elements of the form:

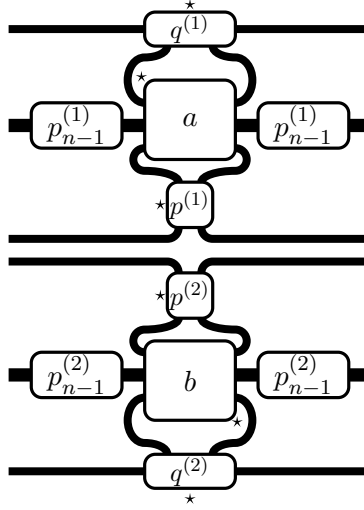

*Proof.* Since  $\mathcal{M}_0 \subset \mathcal{M}_{2n}$  is identified with the inclusion  $M_0 \otimes M_0^{op} \subset p_n(M_{2nk} \otimes M_{2nk}^{op})p_n$ , we have  $\mathcal{M}'_0 \cap \mathcal{M}_{2n} = p_n(P_{2nk} \otimes P_{2nk}^{op})p_n$ . This proves (1).

For (3), suppose that  $x \in \mathcal{M}'_1 \cap \mathcal{M}_{2n}$ . By (1),  $x \in p_n(P_{2nk} \otimes P_{2nk}^{op})p_n$ . Since  $x$  commutes with  $\mathcal{M}_1$ , we have

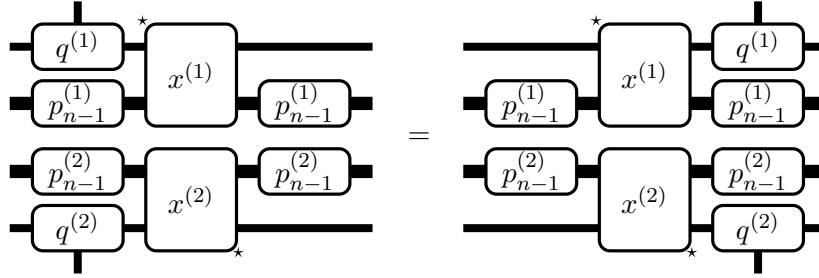

where we are using Sweedler notation  $x = x^{(1)} \otimes x^{(2)}$ . It follows that

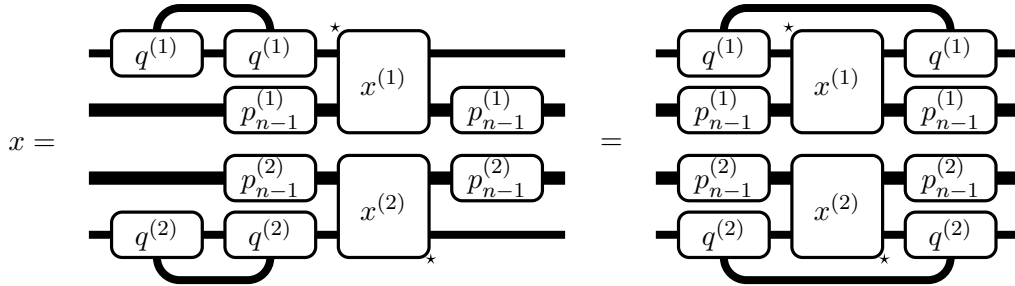

where we have applied Corollary 2.10 for the first equality. Applying Corollary 2.9 shows that  $x$  is of the desired form, which proves (3).

Finally, since  $\mathcal{M}'_i \cap \mathcal{M}_{2n+1} = E_{\mathcal{M}_{2n+1}}(\mathcal{M}'_i \cap \mathcal{M}_{2n+2})$  for  $i = 0, 1$ , (2) and (4) then follow from (1) and (3) by Proposition 3.6.  $\square$

As a corollary we can compute the conditional expectation  $E_{\mathcal{M}'_1}(x)$  for  $x$  in  $\mathcal{M}'_0 \cap \mathcal{M}_n$ . The proof is a straightforward diagrammatic argument and is left to the reader.

**Corollary 3.9.** *If  $x = x^{(1)} \otimes x^{(2)} \in \mathcal{M}'_0 \cap \mathcal{M}_{2n}$ , then*

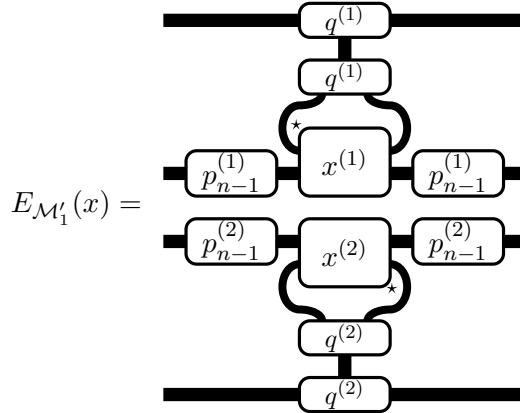

*Likewise, if  $x = x^{(1)} \otimes x^{(2)} \in \mathcal{M}'_0 \cap \mathcal{M}_{2n+1}$  then*

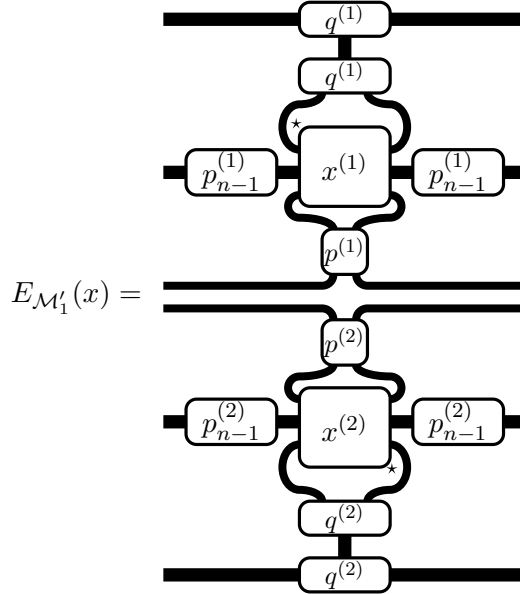

□

#### 4. THE PLANAR ALGEBRA

In this section we construct the planar algebra  $Sym(\mathcal{P})$  of the subfactor  $\mathcal{M}_0 \subset \mathcal{M}_1$ . By Theorem 3.2, this is isomorphic to the planar algebra of  $M_0 \otimes M_0^{op} \subset M_0 \boxtimes M_0^{op}$ . We explain how to recover the planar algebra of the asymptotic inclusion in Remark 4.7 at the end of this section.

It will be convenient to express this in terms of the planar algebra of the inclusion  $M_0 \otimes M_0^{op} \subset M_k \otimes M_k^{op}$ , which we will now describe.

First we construct the planar algebra of  $M_0^{op} \subset M_1^{op}$ . For  $n \geq 1$  let  $R_n$  be the following tangle:



where there are  $n$  strings on the top and bottom of the input box, and the region adjacent to the left side of the outer box is unshaded. Let  $R_n^*$  be the same tangle, but with the region adjacent to



*Proof.* By applying relation (4) to the second and third  $q$  from left, we see that the left hand side is equal to

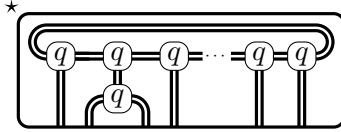

Now if  $n = 3$  then the statement follows from relation (3) above, otherwise it follows from induction on  $n$ .  $\square$

Define  $Sym(\mathcal{P})_n \subset \mathcal{C}_k(\mathcal{P} \otimes \mathcal{P}^{rev})_n$  to be the range of the partially labelled tangle

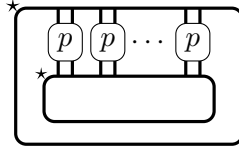

By Proposition 3.8, we have an identification of  $Sym(\mathcal{P})_n$  with  $\mathcal{M}'_0 \cap \mathcal{M}_n$  (as vector spaces).

For  $n \geq 1$  define partially labelled tangles  $F_n$  and  $C_n$  by

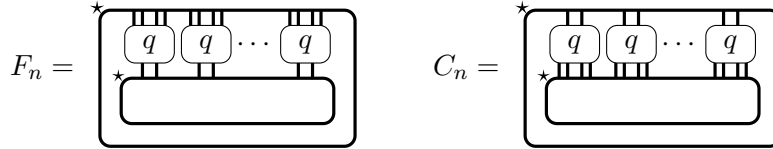

where the number of  $q$ 's in each tangle is  $n$ . By relation (2) above, the linear maps associated to  $F_n$  and  $C_n$  restrict to maps  $Z_{F_n} : Sym(\mathcal{P})_n \rightarrow Sym(\mathcal{P})_{2n}$  and  $Z_{C_n} : Sym(\mathcal{P})_{2n} \rightarrow Sym(\mathcal{P})_n$ . Note that  $Z_{C_n} \circ Z_{F_n}$  restricts to the identity on  $Sym(\mathcal{P})_n$  by (3) of Proposition 4.1.

Now let  $T$  be a planar tangle with  $2n$  marked points on the boundary of its outer disc, and with input discs  $D_1, \dots, D_m$  such that  $D_i$  has  $2n_i$  marked points on its boundary. We define a ‘‘spin factor’’ (cf. [14])  $\sigma(T)$  as follows. First isotope  $T$  so that the output and input rectangles each have as many marked points on the top as on the bottom (with no marked points on the sides), and such that the left side is the distinguished interval.  $\sigma(T)$  is then defined to be the product over all local extrema of all the strings of  $I^{\pm 1/4}$ , where the sign is taken to be positive if the convex region adjacent to the extreme point is unshaded, and negative if it is shaded. If  $n = 0$ , we also multiply by  $I^{-1}$  if the region adjacent to the boundary is shaded.

Let  $\tilde{T}$  be the tangle obtained by doubling the strings of  $T$ . We then define a linear map

$$Z_T^{Sym} : Sym(\mathcal{P})_{n_1} \otimes \cdots \otimes Sym(\mathcal{P})_{n_m} \rightarrow Sym(\mathcal{P})_n$$

by

$$Z_T^{Sym}(x_1 \otimes \cdots \otimes x_m) = \sigma(T) \cdot Z_{C_n}(Z_{\tilde{T}}(Z_{F_{n_1}}(x_1) \otimes \cdots \otimes Z_{F_{n_m}}(x_m))).$$

In other words,  $Z_T^{Sym}$  is equal to  $\sigma(T) \cdot Z_{f(T)}$ , where  $f(T)$  is the partially labelled tangle obtained from  $T$  by doubling the number of strings and composing with the tangles  $C_n$  and  $F_{n_i}$  in the appropriate manner.

Let us now compute this action explicitly for several important classes of tangles.

**Example 4.3.** In  $Sym(\mathcal{P})$ , we have the following:

(1) Identity: If  $n$  is even we have





following condition is satisfied: for each  $q$  appearing in  $T$ , there is another one such that strings 1 and 2 of the first are connected to strings 4 and 3 of the second, respectively. Suppose that  $T$  contains a subtangle of the following form:

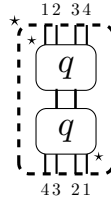

Let  $T'$  be the tangle obtained from  $T$  by removing this subtangle and replacing it with the following:

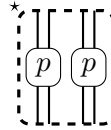

Then in the planar algebra  $\mathcal{C}_k(\mathcal{P} \otimes \mathcal{P}^{rev})$ , we have  $Z_T = Z_{T'}$ .

*Proof.* We may assume without loss of generality that  $T$  is connected. Indeed, suppose there were some connected component consisting of internal discs and strings. If the subtangle in question is contained in this, then we may restrict to this connected component. Otherwise we may remove this component, which for fixed inputs will contribute the same multiplicative factor to both  $Z_T$  and  $Z_{T'}$ .

Label the upper and lower  $q$ 's appearing in the diagram by  $q_t$  and  $q_b$ , respectively. Now consider following strings 1 and 2 of the  $q_b$ : by assumption we will arrive at strings 4 and 3 of another  $q$ . Following strings 1 and 2 of this new  $q$  we would arrive at strings 4 and 3 of another  $q$ , and so on. Eventually we must arrive back at strings 4 and 3 of  $q_b$ . There are two cases to consider, depending on whether this path meets  $q_t$  or not. First suppose that it does not. Then the winding number of this path around  $q_t$  is either 0 or 1. We may assume without loss of generality that it is equal to 0. Indeed, if it is equal to 1, then consider the path obtained by starting at strings 1 and 2 of the  $q_t$  and following the same procedure. Then this path does not meet  $q_b$ , and it is easy to see that the winding number around  $q_b$  must be equal to 0 by planarity. We may then rotate the picture by 180 degrees, reversing the roles of  $q_t$  and  $q_b$ .

We may now isotope the diagram to obtain the following picture:

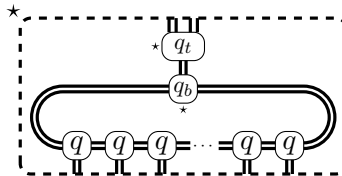

Note that we are using the assumption that  $T$  is connected here, otherwise there could be something appearing in the region adjacent to the marked interval of  $q_b$ . By applying relation (4) of Proposition 4.1, we may modify  $T$  as follows (without effecting  $Z_T$ ):

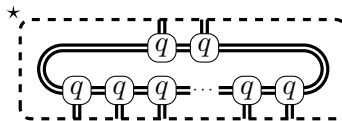

The result then follows from an application of Lemma 4.2 (or Proposition 4.1 (3) if there are only 2  $q$ 's appearing).

Now consider the second case, where the path constructed above contains  $q_t$  as well as  $q_b$ . Consider the part of the path which begins at string 1 of  $q_b$  and ends at string 4 of  $q_t$ . Suppose

that we extend this downward to connect back to  $q_b$  to obtain a closed path. Then the winding number of this path around any point in region adjacent to the marked interval of  $q_b$  is either 0 or 1. As above, by reversing the roles of  $q_b$  and  $q_t$  if necessary, we may assume that it is equal to 1.

After isotoping, we may then arrange the diagram as follows:

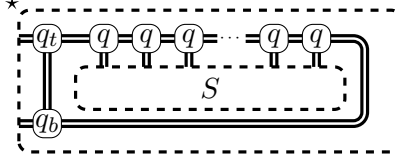

where  $S$  is a subangle of  $T$ . Apply relation (4) of Proposition 4.1 to obtain the following:

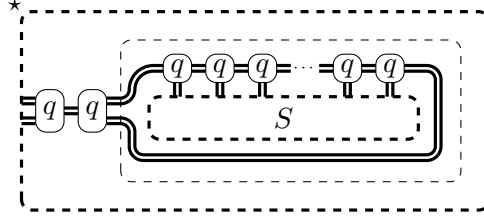

The result then follows from (5) of Proposition 4.1.  $\square$

*Remark 4.5.* Note that the tangle  $T'$  obtained from  $T$  as above still satisfies the hypotheses of the Lemma (modulo an application of Proposition 4.1 (2) if necessary). So by iterating this procedure, we may make this replacement for every occurrence of the subdiagram which appeared in the statement of the lemma.

Note that if  $T$  is fully labelled by  $q$ 's and satisfies the hypotheses of the Lemma, then by iterating this procedure and applying Proposition 4.1 we can compute the partition function  $Z_T$ . In particular, we see that in the (unshaded) planar algebra generated by  $q$  in the unshaded 2-cabling of  $\mathcal{C}_k(\mathcal{P} \otimes \mathcal{P}^{rev})$  we have the relation

$$\begin{array}{c} \star \\ \text{---} \boxed{q} \text{---} \boxed{q} \text{---} \\ \star \end{array} = \text{---} \text{---}$$

which together with the rotational invariance of  $q$  and the loop parameter  $I$  determines the partition function.

**Theorem 4.6.** *Sym(P) is a spherical  $C^*$ -planar algebra, and the identification of  $Sym(\mathcal{P})_n$  with  $\mathcal{M}'_0 \cap \mathcal{M}_n$  is an isomorphism between  $Sym(\mathcal{P})$  and the planar algebra of the inclusion  $M_0 \otimes M_0^{op} \subset M_0 \boxtimes M_0^{op}$ .*

*Proof.* Since  $\mathcal{C}_k(\mathcal{P} \otimes \mathcal{P}^{rev})$  is a planar algebra, it is clear that the action  $Z_T^{Sym}$  depends only on the isotopy class of  $T$ . We must show that the action is compatible with the gluing of tangles. So suppose that we have two tangles  $T$  and  $S$ , such that the  $i$ -th input disc of  $T$  and the output disc of  $S$  both have the same number of marked points  $2n$ . Now we have  $Z_{T \circ_i S}^{Sym} = \sigma(T \circ_i S) Z_{f(T \circ_i S)}$  while  $Z_T^{Sym} \circ_i Z_S^{Sym} = \sigma(T) \sigma(S) Z_{f(T)} \circ Z_{f(S)} = \sigma(T) \sigma(S) Z_{f(T) \circ_i f(S)}$ . It is clear that  $\sigma(T \circ_i S) = \sigma(T) \sigma(S)$ , so it remains to show that  $Z_{f(T) \circ_i f(S)} = Z_{f(T \circ_i S)}$ .

Now in  $f(T) \circ_i f(S)$  there are  $n$  copies of the diagram from the statement of Lemma 4.4 which are arranged around the former boundary of the  $i$ -th input disc of  $\tilde{T}$ . Since  $T \circ_i S$  is a shaded tangle, it is not hard to see that  $f(T) \circ_i f(S)$  satisfies the conditions of that lemma, and so we may make the indicated replacements. After applying (2) of Proposition 4.1 if needed, the resulting tangle is then clearly isotopic to  $f(T \circ_i S)$ , and hence we have  $Z_{f(T \circ_i S)} = Z_{f(T) \circ_i f(S)}$  as desired. This proves that  $Sym(\mathcal{P})$  is a planar algebra.



The remaining properties of a spherical  $C^*$ -planar algebra follow easily from the corresponding properties of  $\mathcal{C}_k(\mathcal{P} \otimes \mathcal{P}^{rev})$  (note that one has to be careful about the spin factors when checking sphericity).

Now in Example 4.3, we have shown that the identification of  $Sym(\mathcal{P})_n$  with  $\mathcal{M}'_0 \cap \mathcal{M}_n$  is compatible with the action of several classes of tangles. But it is a well-known result of Jones (see [13, Theorem 4.2.1]) that the planar algebra structure on  $(\mathcal{M}'_0 \cap \mathcal{M}_n)_{n \geq 0}$  is uniquely determined by the action of these tangles. So it follows that this identification gives an isomorphism of planar algebras between  $Sym(\mathcal{P})$  and  $\mathcal{P}(\mathcal{M}_0 \subset \mathcal{M}_1)$ , which completes the proof.  $\square$

*Remark 4.7.* We have worked with the inclusion  $M_0 \otimes M_0^{op} \subset M_0 \boxtimes M_0^{op}$  instead of the symmetric enveloping inclusion  $M_1 \otimes M_1^{op} \subset M_1 \boxtimes M_1^{op}$  for simplicity. However, we can now recover the planar algebra of the symmetric enveloping inclusion (or asymptotic inclusion) as follows. Since  $M_0 \otimes M_0^{op} \subset M_0 \boxtimes M_0^{op}$  is isomorphic to the compression by  $e_0 \otimes e_0^{op}$  of the inclusion  $M_2 \otimes M_2^{op} \subset M_2 \boxtimes M_2^{op}$ , it follows that these inclusions have the same planar algebra. The latter subfactor is isomorphic to the symmetric enveloping inclusion for  $M_1 \subset M_2$  by [1]. The planar algebra of  $M_1 \subset M_2$  is  $\mathcal{P}^{op}$ , the dual planar algebra of  $\mathcal{P}$  in which the shadings are reversed [13]. As discussed by Popa [19], the planar algebra of the symmetric enveloping inclusion of a subfactor depends only on the planar algebra of that subfactor. By duality, it now follows that the planar algebra of the symmetric enveloping inclusion  $M_1 \otimes M_1^{op} \subset M_1 \boxtimes M_1^{op}$  is isomorphic to  $Sym(\mathcal{P}^{op})$ .

## 5. FUSION RULES AND THE AFFINE CATEGORY

In this section we compute the fusion rules for the asymptotic inclusion, recovering some results of Ocneanu and Evans-Kawahigashi [4]. In particular, we show that the fusion rules for  $\mathcal{M}_1 - \mathcal{M}_1$ -bimodules are described by the affine category of  $\mathcal{P}$ . We remark that it has recently been shown by Das, Ghosh and Gupta [3] that the category of affine Hilbert representations is equivalent to the Drinfeld center of the fusion category associated to  $\mathcal{P}$  (see also [2]).

**The affine category:** We briefly recall the definition of the *affine category* of a planar algebra  $\mathcal{P}$ , for further details see [15], [6].

**Definition 5.1.** An *affine  $(n, m)$ -tangle*  $T$  is a planar tangle with outer box equal to  $\{(x, y) \in \mathbb{R}^2 : \max(|x|, |y|) = 2\}$ , a distinguished inner box equal to  $\{(x, y) \in \mathbb{R}^2 : \max(|x|, |y|) = 1\}$ , with marked points  $\{(-2, \frac{2i}{n}) : -n \leq i < n\}$  (resp.  $\{(-1, \frac{i}{m}) : -m \leq k < m\}$ ) on the boundary of the outer box (resp. distinguished inner box) and with distinguished intervals occurring at the top of the outer box and distinguished inner box.

Typically one must specify the shading near the boundary of the outer (resp. distinguished inner box) when  $n = 0$  (resp.  $m = 0$ ). Here we will only be concerned with the ‘positive’ part of the affine category, where these regions are assumed to be unshaded.

If  $\mathcal{P}$  is a planar algebra we say that an affine  $(n, m)$ -tangle  $T$  is  $\mathcal{P}$ -labelled if we have an assignment of elements of  $\mathcal{P}$  to each input box of  $T$ , except for the distinguished one. Note that  $T$  then determines a linear map  $P_m \rightarrow P_n$  by assigning the element of  $P_m$  to the distinguished input box and applying  $Z_T$ .

Define the (positive) affine category  $Aff^+(\mathcal{P})$  to have one object for each  $k \geq 0$ , and with morphisms equal to isotopy classes of  $\mathcal{P}$ -labelled affine tangles, where the isotopies are required to fix the outer and distinguished inner boxes. If  $T$  (resp.  $S$ ) is an affine  $(n, k)$  (resp.  $(k, m)$ ) tangle, the composition  $TS$  is the affine  $(n, m)$ -tangle obtained by scaling  $S$  by a factor of  $1/2$ , composing the resulting diagram with  $T$  and then rescaling the resulting tangle. Let  $FA^+(\mathcal{P})$  be the linearization of this category, i.e. the objects are the same but the morphisms are vector spaces with bases given by isotopy classes of affine tangles.

*Remark 5.2.* The distinction between the affine category and the *annular category* of [15] is that annular tangles are taken up to isotopies which are not required to fix the outer and distinguished inner boxes.

For  $k \geq 0$  we have a natural map  $\psi_k$  from (isotopy classes of) labelled planar  $(n+m+2k)$ -tangles to (isotopy classes of) affine  $(n,m)$ -tangles given by:

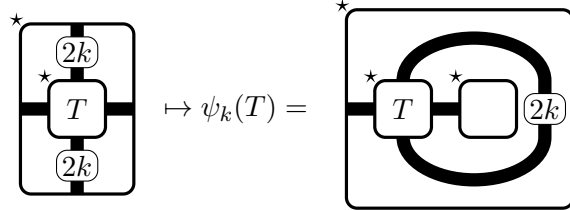

It is easy to see that every isotopy class of affine  $(n,m)$ -tangles is in the range of  $\psi_k$  for  $k$  sufficiently large.

Define  $\mathcal{R} \subset FA^+(\mathcal{P})$  by

$$\mathcal{R} = \text{span} \left\{ \sum \psi_k(T_i) : T_i \text{ are } \mathcal{P}\text{-labelled } (n+m+2k)\text{-tangles such that } \sum Z_{T_i} = 0 \right\}.$$

**Definition 5.3.** The (positive) *affine algebraoid*  $\mathcal{A}^+(\mathcal{P}) = \{\mathcal{A}(\mathcal{P})_{n,m} : n, m \geq 0\}$  is the quotient of  $FA^+(\mathcal{P})$  by  $\mathcal{R}$ .

In other words,  $\mathcal{A}^+(\mathcal{P})$  is the quotient of the universal affine algebraoid of  $\mathcal{P}$  by all relations which hold in a contractible disc. It is easy to see that composition of affine tangles passes to  $\mathcal{A}^+(\mathcal{P})$ . It is clear from the definitions that  $\psi_k$  gives a well-defined linear map  $P_{n+m+2k} \rightarrow \mathcal{A}(\mathcal{P})_{n,m}$ . Moreover, we have the following description of the kernel.

**Lemma 5.4.** *The kernel of  $\psi_k : P_{n+m+2k} \rightarrow \mathcal{A}(\mathcal{P})_{n,m}$  is spanned by elements of the form*

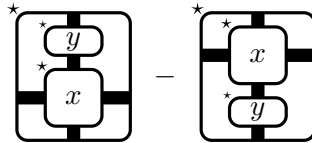

for  $x \in P_{2n+k}$  and  $y \in P_{2k}$ .

*Proof.* We prove this first for the universal planar algebra  $\mathcal{P}(L)$  with labelling set  $L = P$  (cf. [13]). In this case  $P_{n+m+2k}$  is replaced by the vector space with basis given by isotopy classes of  $\mathcal{P}$ -labelled  $n+m+2k$ -tangles, and  $\mathcal{A}(\mathcal{P})_{n,m}$  is replaced by the vector space with basis given by isotopy classes of  $\mathcal{P}$ -labelled affine  $(n,m)$ -tangles. Since  $\psi_k$  maps basis elements to basis elements, its kernel is spanned by elements of the form  $T_1 - T_2$ , where  $T_1, T_2$  are  $\mathcal{P}$ -labelled planar  $n+m+2k$  tangles such that  $\psi_k(T_1)$  is isotopic to  $\psi_k(T_2)$ . By a standard topological argument it follows that the kernel is spanned by elements of the form appearing in the statement of the lemma, where  $x$  is a labelled  $n+2k$ -tangle and  $y$  is a labelled  $2k$ -tangle. Now taking the quotient by the kernel of the partition function  $Z : \mathcal{P}(L) \rightarrow \mathcal{P}$ , we see that the result holds for  $\mathcal{P}$  as well.  $\square$

Note that by Proposition 2.6, if  $\mathcal{P}$  is finite-depth then  $\psi_k$  is surjective if  $2k \geq \text{depth}(\mathcal{P})$ . In particular, if  $\mathcal{P}$  is finite-depth then  $\mathcal{A}(\mathcal{P})_{n,m}$  is finite-dimensional for every  $n, m \geq 0$ .

A module over  $\mathcal{A}^+(\mathcal{P})$  is a graded vector space  $V = (V_n)$  together with an action of affine tangles. So to each affine  $(n,m)$ -tangle there is an associated linear map  $V_m \rightarrow V_n$ , which is compatible with composition of affine tangles. In particular,  $\mathcal{P}^+ = (P_n)_{n \geq 0}$  is a module over  $\mathcal{A}^+(\mathcal{P})$ . The *weight* of a module is the least value of  $n$  such that  $V_n$  is non-trivial.

If each  $V_n$  is a finite-dimensional Hilbert space, and we have

$$\langle av, w \rangle = \langle v, a^*w \rangle$$

for all  $v, w \in V$  and  $a \in \mathcal{A}^+(\mathcal{P})$ , then we say that  $V$  is a Hilbert module over  $\mathcal{A}^+(\mathcal{P})$ . For Hilbert modules the notions of *indecomposability* and *irreducibility* are equivalent, see [15], [6].

**Affine representations and Ocneanu's tube algebra:**

We will now assume that  $\mathcal{P}$  is finite-depth. Let  $2k \geq \text{depth}(\mathcal{P})$ . For each  $v \in \Gamma_+$ , fix a minimal projection  $t_v$  in the central component of  $P_{2k}$  corresponding to  $v$ . Recall that  $\text{tr}_{P_{2k}}(t_v) = \delta^{-2k} \mu_v$ . Let  $t = \sum t_v$ , then Ocneanu's *tube algebra* is the compression

$$\text{Tube}(\mathcal{P}) = t(\mathcal{A}(\mathcal{P})_k)t = \bigoplus_{v, w \in \Gamma_+} \text{Tube}(\mathcal{P})_{v, w},$$

where we set  $\text{Tube}(\mathcal{P})_{v, w} = t_v(\mathcal{A}(\mathcal{P})_k)t_w$ .

*Remark 5.5.* Ocneanu defined the tube algebra [4] using Turaev-Viro topological quantum field theory, but it is not hard to see that our definition is equivalent.

For  $v \in \Gamma_+$  and  $n \geq 0$ , define  $H_n(v) \subset P_{n+k}$  to be the range of the tangle:

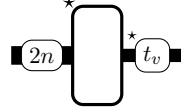

$H_n(v)$  is a Hilbert space with inner product  $\langle x, y \rangle_{H_n(v)} = \frac{\delta^{2k}}{\mu_v} \langle x, y \rangle_{P_{n+k}}$ .

Observe that

$$\left( \bigoplus_{v, w \in \Gamma_+} \text{Tube}(\mathcal{P})_{v, w} \otimes (H_n(v) \otimes H_m(w)^*) \right)_{n, m \geq 0}$$

has a natural algebraoid structure given as follows: the product of  $a \otimes x_1 \otimes y_1$  in  $\text{Tube}(\mathcal{P})_{v, w} \otimes (H_n(v) \otimes H_k(w)^*)$  and  $b \otimes x_2 \otimes y_2$  in  $\text{Tube}(\mathcal{P})_{w', z} \otimes (H_k(w') \otimes H_m(z)^*)$  is given by

$$(a \otimes x_1 \otimes y_1)(b \otimes x_2 \otimes y_2) = \delta_{w, w'} \langle y_1, x_2 \rangle_{H_k(w)} \cdot (ab \otimes x_1 \otimes y_2).$$

For  $n, m \geq 0$  define  $\phi_{n, m} : \bigoplus_{v, w \in \Gamma_+} \text{Tube}(\mathcal{P})_{v, w} \otimes (H_n(v) \otimes H_m(w)^*) \rightarrow \mathcal{A}(\mathcal{P})_{n, m}$  by

$$\phi_{n, m}(a \otimes x \otimes y^*) = \text{Diagram}$$

for  $a \otimes x \otimes y^* \in \text{Tube}(\mathcal{P})_{v, w} \otimes (H_n(v) \otimes H_m(w)^*)$ .

**Proposition 5.6.**  $\phi = (\phi_{n, m})$  gives an isomorphism of algebraoids

$$\mathcal{A}^+(\mathcal{P}) \simeq \left( \bigoplus_{v, w \in \Gamma_+} \text{Tube}(\mathcal{P})_{v, w} \otimes (H_n(v) \otimes H_m(w)^*) \right)_{n, m}.$$

*Proof.* That  $(\phi_{n, m})$  is compatible with composition follows easily from the identity

$$\text{Diagram} = \delta_{v, w} \langle y, x \rangle_{H_n(v)} \cdot t_v,$$

which holds since  $t_v, t_w$  are minimal projections.

It remains to show that  $\phi_{n,m}$  is a linear isomorphism for each  $n, m$ . Suppose we have an element

$$z = \sum_{v,w \in \Gamma_+} a_{v,w} \otimes x_v \otimes y_w^* \in \bigoplus_{v,w \in \Gamma_+} Tube(\mathcal{P})_{v,w} \otimes (H_n(v) \otimes H_m(w)^*).$$

Then we have

$$\phi_{n,m}((t_v \otimes t_v \otimes x_v^*)z(t_w \otimes y_w \otimes t_w)) = \phi_{k,k}(a_{v,w} \otimes |x_v|^2 \cdot t_v \otimes |y_w|^2 \cdot t_w) = |x_v|^2 |y_w|^2 \cdot a_{v,w}.$$

By the above it follows that  $\phi_{n,m}(z) = 0$  implies  $z = 0$ , so  $\phi_{n,m}$  is injective. Surjectivity follows from Proposition 2.6 and the fact that  $1_{P_{2k}}$  is contained in the linear span of  $\{xt_vy : x, y \in P_{2k}, v \in \Gamma_+\}$ .  $\square$

We can now determine the irreducible Hilbert modules over  $\mathcal{A}^+(\mathcal{P})$ . It is clear that any minimal central projection of  $Tube(\mathcal{P})$  must be contained in  $Tube(\mathcal{P})_{v,v}$  for some  $v \in \Gamma_+$ . Suppose that  $p$  is such a projection, and let  $V$  be a finite-dimensional Hilbert space on which  $p(Tube(\mathcal{P}))p$  acts irreducibly. Extend this action to  $Tube(\mathcal{P})$  by letting  $1 - p$  act by zero. For  $n \geq 0$  define  $V_n = V \otimes H_n(v)$ . Then  $\mathcal{V} = (V_n)_{n \geq 0}$  has a natural Hilbert module structure over

$$\left( \bigoplus_{w,z \in \Gamma_+} Tube(\mathcal{P})_{w,z} \otimes (H_n(w) \otimes H_m(z)^*) \right)_{n,m}$$

We can use the isomorphism of Proposition 5.6 to make  $\mathcal{V}$  into a Hilbert module over  $\mathcal{A}^+(\mathcal{P})$ .

**Theorem 5.7.**  $\mathcal{V} = (V_n)_{n \geq 0}$  is an irreducible Hilbert module over  $\mathcal{A}^+(\mathcal{P})$ , of weight  $d(*, v)/2$ . Moreover, any irreducible Hilbert module over  $\mathcal{A}^+(\mathcal{P})$  is of this form.

*Proof.* For fixed  $n \geq 0$ , the tensor product of the actions of  $Tube(\mathcal{P})$  on  $V$  and  $H_n(v) \otimes H_n^*(v) \simeq \mathcal{B}(H_n(v))$  on  $H_n(v)$  is clearly irreducible, and therefore the action of  $\mathcal{A}(\mathcal{P})_n$  on  $V_n = V \otimes H_n(v)$  is irreducible as well. It follows from [15] that  $V = (V_n)$  is an irreducible Hilbert module over  $\mathcal{A}^+(\mathcal{P})$ . The weight of this module is the smallest value of  $n$  for which  $H_n(v)$  is non-trivial, which is equal to  $d(*, v)/2$ .

Now by [15], any irreducible Hilbert module  $\mathcal{V} = (V_n)$  over  $\mathcal{A}^+(\mathcal{P})$  must have the property that  $V_n$  is an irreducible module over  $\mathcal{A}(\mathcal{P})_n$  for each  $n \geq 0$ . Moreover, if  $\mathcal{W} = (W_n)$  is another irreducible Hilbert module such that  $V_n$  and  $W_n$  are isomorphic  $\mathcal{A}(\mathcal{P})_n$ -modules for some  $n$ , then  $\mathcal{V}$  and  $\mathcal{W}$  are isomorphic modules over  $\mathcal{A}^+(\mathcal{P})$ . Since the isomorphism classes of irreducible modules over the multimatrix algebra  $\mathcal{A}(\mathcal{P})_n$  correspond to central projections, it follows from Proposition 5.6 that every irreducible Hilbert module over  $\mathcal{A}^+(\mathcal{P})$  is of the form described above.  $\square$

### The principal and dual principal graphs:

We will relate the lattice of higher relative commutants for  $\mathcal{M}_0 \subset \mathcal{M}_1$  with the affine category, which will allow us to compute the principal and dual principal graphs. First we need to further analyze the map  $\psi_k$  defined above. We will assume that  $2k \geq \text{depth}(\mathcal{P})$ , so that  $\psi_k$  is surjective.

First we show that the kernel is determined by the projection  $p = p^{(1)} \otimes p^{(2)}$  from Section 2. For this we need the following lemma.

**Lemma 5.8.** *Let  $x \in P_{2(n+k)}$  and  $y \in P_{2k}$ , then we have*

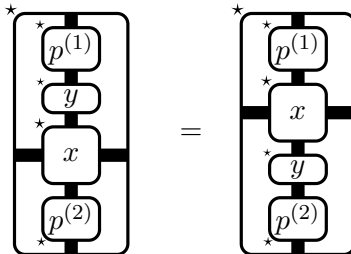

*Proof.* By Proposition 2.6, it suffices to show that

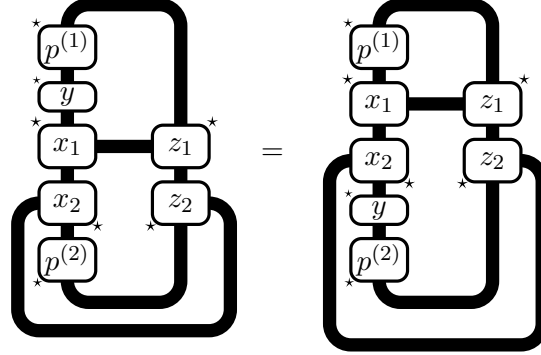

for  $x_1, x_2, z_1, z_2 \in P_{n+2k}$ . By Lemma 2.1, the left hand side is equal to

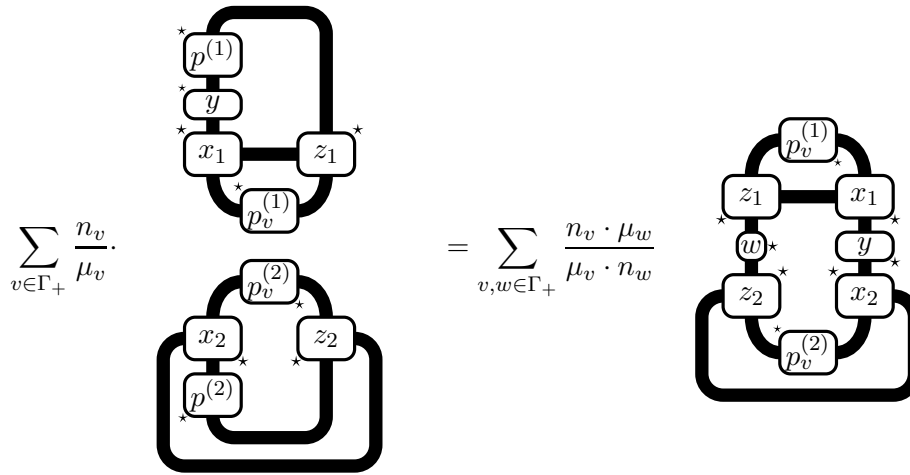

Where the equality above follows from rotating the top and bottom components on the left hand side by 180 degrees and then applying Lemma 2.1 again. But if we applied the same procedure to the right hand side of the first equation it is clear that we would obtain the same diagram, so the result follows.  $\square$

Given  $x \in P_{2(n+k)}$ , define  $p \cdot x$  by

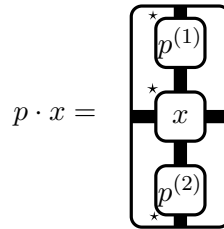

**Proposition 5.9.** *If  $x \in P_{2(n+k)}$  then  $\psi_k(x) = \psi_k(p \cdot x)$ . Moreover, if  $\psi_k(x) = 0$  then  $p \cdot x = 0$ .*

*Proof.* The first statement follows immediately from Proposition 2.3 (4). The second follows from combining Lemmas 5.4 and 5.8.  $\square$

It follows that  $\psi_k$  restricts to a linear isomorphism of  $\{p \cdot x : x \in P_{2(n+k)}\}$  onto  $\mathcal{A}(\mathcal{P})_n$ . We now want to pull back the multiplication from  $\mathcal{A}(\mathcal{P})_n$ . To do this it is convenient to modify the map

$\psi_k$ . So we define  $\tilde{\psi}_k : P_{2(n+k)} \rightarrow \mathcal{A}(\mathcal{P})_n$  by

$$\tilde{\psi}_k(x) = \sum_{v \in \Gamma_+} \sqrt{\frac{\mu_v}{n_v}} \cdot \text{Diagram}$$

It is clear that  $\tilde{\psi}_k$  has the same kernel as  $\psi_k$ , so  $\tilde{\psi}_k$  is a linear isomorphism when restricted to  $\{p \cdot x : x \in P_{2(n+k)}\}$ . For  $n$  even we also define  $\tilde{\psi}_k^{op} : P_{2(n+k)} \rightarrow \mathcal{A}(\mathcal{P})_n$  by

$$\tilde{\psi}_k^{op}(x) = \sum_{v \in \Gamma_+} \sqrt{\frac{\mu_v}{n_v}} \cdot \text{Diagram}$$

Note that we require  $n$  even because of the shading. It is clear that  $\tilde{\psi}_k^{op}$  is also a linear isomorphism when restricted to  $\{p \cdot x : x \in P_{2(n+k)}\}$ .

Now for  $x, y \in P_{2(n+k)}$  define

$$x \star_q y = \text{Diagram}$$

**Proposition 5.10.** For  $x, y \in P_{2(n+k)}$  we have

$$\begin{aligned} \tilde{\psi}_k(x \star_q y) &= \tilde{\psi}_k(x) \cdot \tilde{\psi}_k(y) \\ \tilde{\psi}_k^{op}(y \star_q x) &= \tilde{\psi}_k^{op}(x) \cdot \tilde{\psi}_k^{op}(y). \end{aligned}$$

*Proof.* This follows from Proposition 2.7. □

**Corollary 5.11.** We have an embeddings  $\mathcal{A}(\mathcal{P})_n \hookrightarrow P_{2n+4k}$  and  $\mathcal{A}(\mathcal{P})_n \hookrightarrow P_{2n+4k}^{op}$  given by

$$\tilde{\psi}_k(x) \mapsto \text{Diagram} \quad \text{and} \quad \tilde{\psi}_k^{op}(x) \mapsto \text{Diagram}$$

for  $x \in P_{2(n+k)}$ .

*Proof.* This follows from Corollary 2.9 and the previous proposition. □

**Theorem 5.12.** For  $n \geq 2$  we have an isomorphism of commuting squares:

$$\left[ \begin{array}{c} \mathcal{M}'_0 \cap \mathcal{M}_{2n-1} \subset \mathcal{M}'_0 \cap \mathcal{M}_{2n} \\ \cup \\ \mathcal{M}'_1 \cap \mathcal{M}_{2n-1} \subset \mathcal{M}'_1 \cap \mathcal{M}_{2n} \end{array} \right] \simeq \left[ \begin{array}{c} p_{n-1}(P_{4(n-1)k})p_{n-1} \subset p_n(P_{2nk} \otimes P_{2nk}^{op})p_n \\ \cup \\ p_{n-2}(\mathcal{A}(\mathcal{P})_{2(n-2)k})p_{n-2} \subset p_{n-1}(P_{4(n-1)k}^{op})p_{n-1} \end{array} \right]$$

*Proof.* This isomorphisms follow from Proposition 3.8 and Theorem 3.2. The compatibility of the inclusions can be easily checked using the description of  $Sym(\mathcal{P})$  from the previous section, the details are left to the reader.  $\square$

*Remark 5.13.* We also have an isomorphism of the dual squares

$$\left[ \begin{array}{c} \mathcal{M}'_0 \cap \mathcal{M}_{2n} \subset \mathcal{M}'_0 \cap \mathcal{M}_{2n+1} \\ \cup \\ \mathcal{M}'_1 \cap \mathcal{M}_{2n} \subset \mathcal{M}'_1 \cap \mathcal{M}_{2n+1} \end{array} \right] \simeq \left[ \begin{array}{c} p_n(P_{2nk} \otimes P_{2nk}^{op})p_n \subset p_n(P_{4nk})p_n \\ \cup \\ p_{n-1}(P_{4(n-1)k}^{op})p_{n-1} \subset p_{n-1}(\mathcal{A}(\mathcal{P})_{2(n-1)k})p_{n-1} \end{array} \right]$$

where the inclusion  $P_{4(n-1)k}^{op} \subset \mathcal{A}(\mathcal{P})_{2(n-1)k}$  is given by:

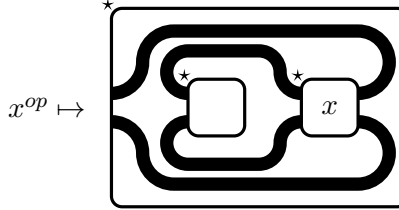

We can now compute the principal and dual principal graphs by determining the Bratelli diagrams for the above inclusions.

**Proposition 5.14.** *We have the following Bratelli diagrams.*

- (1) For  $n \geq 2$  the Bratelli diagram of  $P_{4(n-1)k} \subset P_{2nk} \otimes P_{2nk}^{op}$  is as follows. The even vertices are indexed by pairs of  $M_0 - M_0$  bimodules  $(X_v, \overline{X}_w)$  for  $v, w \in \Gamma_+$ . The odd vertices are indexed by  $M_0 - M_0$  bimodules  $X_z$ ,  $z \in \Gamma_+$ . The number of edges between  $(X_v, \overline{X}_w)$  and  $X_z$  is equal to the multiplicity of  $X_z$  in  $X_v \otimes \overline{X}_w$ , i.e. the dimension of the range of the partially labelled tangle:

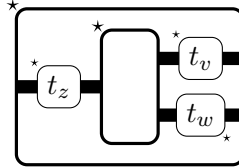

- (2) For  $n \geq 1$  the Bratelli diagram of  $P_{4nk}^{op} \subset \mathcal{A}(\mathcal{P})_{2nk}$  is as follows. The odd vertices are indexed by  $M_0 - M_0$  bimodules  $\overline{X}_z$  for  $z \in \Gamma_+$ . The even vertices are indexed by irreducible Hilbert modules over  $\mathcal{A}^+(\mathcal{P})$ , or equivalently by minimal central projections in Ocneanu's tube algebra  $Tube(\mathcal{P})$ . Given an irreducible Hilbert module  $V$  over  $\mathcal{A}^+(\mathcal{P})$ , let  $\pi_V$  be a minimal projection in the central component of  $Tube(\mathcal{P})$  corresponding to  $V$  via Theorem 5.4. Then the number of edges between  $\overline{X}_z$  and  $V$  is equal to the dimension of the range of the following partially labelled affine tangle, viewed as a linear map  $P_{4k} \rightarrow \mathcal{A}(\mathcal{P})_k$ .

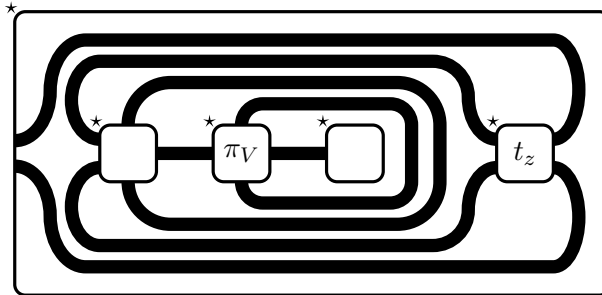

*Proof.* Recall that if  $i : A \rightarrow B$  is a unital inclusion of multi-matrix algebras and  $p \in A$  (resp.  $q \in B$ ) is a minimal projection in the central component labelled  $v$  (resp.  $w$ ) then the number of

edges between  $v$  and  $w$  in the Bratelli diagram of the inclusion is equal to the dimension of the subspace  $\{i(p)bg : b \in B\} \subset B$ . The results then follow from the previous proposition and the remark which followed.  $\square$

*Remark 5.15.* It follows from Theorem 5.12 that the principal (resp. dual principal) graph of  $M_0 \otimes M_0^{op} \subset M_0 \boxtimes M_0^{op}$  is the connected component of  $(X_*, X_*)$  (resp.  $X_*$ ) of the Bratelli diagram described in (1) (resp. (2)) above.

The vertices in the Bratelli diagrams above which are not in the principal or dual principal graphs do not correspond to bimodules arising from the Jones tower  $\mathcal{M}_n$ . However, these ‘missing’ bimodules are easily constructed. Indeed, recall that we have  $\mathcal{M}_3 \simeq p(M_{2k} \boxtimes M_{2k}^{op})p$ . This gives  $M_{2k} \boxtimes M_{2k}^{op}$  a  $\mathcal{M}_i$ - $\mathcal{M}_j$  bimodule structure for  $i, j = 0, 1$ . By adapting the arguments above it can be proved that there is an isomorphism of commuting squares:

$$\left[ \begin{array}{c} \text{Hom}_{\mathcal{M}_0, \mathcal{M}_1}(L^2(M_{2k} \boxtimes M_{2k}^{op})) \subset \text{Hom}_{\mathcal{M}_0, \mathcal{M}_0}(L^2(M_{2k} \boxtimes M_{2k}^{op})) \\ \cup \\ \text{Hom}_{\mathcal{M}_1, \mathcal{M}_1}(L^2(M_{2k} \boxtimes M_{2k}^{op})) \subset \text{Hom}_{\mathcal{M}_1, \mathcal{M}_0}(L^2(M_{2k} \boxtimes M_{2k}^{op})) \end{array} \right] \simeq \left[ \begin{array}{c} P_{8k} \subset P_{6k} \otimes P_{6k}^{op} \\ \cup \\ \mathcal{A}(\mathcal{P})_{2k} \subset P_{8k}^{op} \end{array} \right]$$

It follows that the fusion graphs of irreducible bimodules which appear in  $L^2(M_{2k} \boxtimes M_{2k}^{op})$  are precisely the Bratelli diagrams of Proposition 5.14.

### Fusion rules for $\mathcal{M}_1$ - $\mathcal{M}_1$ bimodules:

It is well-known that the quantum double of a fusion category is always braided. In the subfactor setting, it was likewise shown by Ocneanu [18] and Evans-Kawahigashi [4] that the fusion category of bimodules arising from the asymptotic inclusion is braided (see also [10, 17]). Below we show how the fusion rules and braiding for  $\mathcal{M}_1 - \mathcal{M}_1$  bimodules can be seen in our framework.

Define  $v_n \in \mathcal{A}(\mathcal{P})_{2nk}$  by

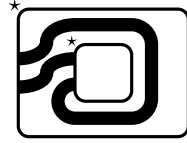

For  $x \in P_{2(n+k)}$  define  $x^{op}$  by

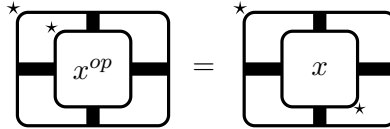

Observe that we have

$$\begin{aligned} \tilde{\psi}_k(x^{op}) &= v_n^*(\tilde{\psi}_k(x))v_n \\ \tilde{\psi}_k^{op}(x^{op}) &= v_n^*(\tilde{\psi}_k^{op}(x))v_n \end{aligned}$$

Define  $i_n : \mathcal{A}(\mathcal{P})_{2nk} \otimes \mathcal{A}(\mathcal{P})_{2nk} \hookrightarrow \mathcal{A}(\mathcal{P})_{4(n+1)k}$  by

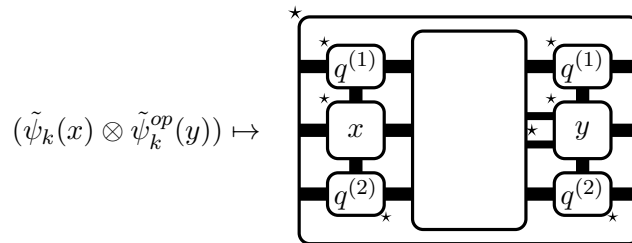

We then have

$$v_{2(n+1)}^*(i_n(\tilde{\psi}_k(x) \otimes \tilde{\psi}_k^{op}(y^{op})))v_{2(n+1)} = i_n(\tilde{\psi}_k(y) \otimes \tilde{\psi}_k^{op}(x^{op})),$$



which is easy to see by drawing the appropriate diagram. It follows that if we set

$$u_n = v_{2(n+1)} \cdot i_n(v_n \otimes v_n)$$

then we have

$$u_n^*(i_n(x \otimes y))u_n = i_n(y \otimes x)$$

for any  $x, y \in \mathcal{A}(\mathcal{P})_{2nk}$ .

Recall that we have  $L^2(\mathcal{M}_{2n}) \simeq L^2(\mathcal{M}_n) \otimes_{\mathcal{M}_0} L^2(\mathcal{M}_n)$  as  $\mathcal{M}_1 - \mathcal{M}_1$  bimodules. Moreover, the inclusion  $\text{Hom}_{\mathcal{M}_1, \mathcal{M}_1}(L^2(\mathcal{M}_n)) \otimes \text{Hom}_{\mathcal{M}_1, \mathcal{M}_1}(L^2(\mathcal{M}_n)) \hookrightarrow \text{Hom}_{\mathcal{M}_1, \mathcal{M}_1}(L^2(\mathcal{M}_{2n}))$  is given by the following tangle (the top-left corner is shaded):

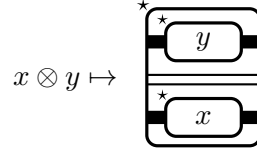

**Proposition 5.16.** *The following diagram is commutative:*

$$\begin{array}{ccc} \mathcal{A}(\mathcal{P})_{2(n-2)k} \otimes \mathcal{A}(\mathcal{P})_{2(n-2)k} & \xrightarrow{i_n} & \mathcal{A}(\mathcal{P})_{4(n-1)k} \\ \uparrow & & \uparrow \\ \text{Hom}_{\mathcal{M}_1, \mathcal{M}_1} L^2(\mathcal{M}_n) \otimes \text{Hom}_{\mathcal{M}_1, \mathcal{M}_1} L^2(\mathcal{M}_n) & \longrightarrow & \text{Hom}_{\mathcal{M}_1, \mathcal{M}_1} L^2(\mathcal{M}_{2n}) \end{array}$$

*Proof.* This can be verified by computing the tangle above in the planar algebra  $\text{Sym}(\mathcal{P})$ , using the description from the previous section.  $\square$

We are now able to recover the following description of the fusion rules for  $\mathcal{M}_1 - \mathcal{M}_1$ -bimodules due to Ocneanu [18] and Evans-Kawahigashi [4].

**Corollary 5.17.** *Let  $V, W, Z$  be irreducible  $\mathcal{M}_1 - \mathcal{M}_1$ -bimodules (corresponding to irreducible Hilbert modules over  $\mathcal{A}^+(\mathcal{P})$ ). Let  $\pi_V, \pi_W, \pi_Z$  be minimal projections in the central components of  $\text{Tube}(\mathcal{P})$  corresponding to  $V, W, Z$ . Let  $\tilde{\pi}_V, \tilde{\pi}_W \in P_{4k}$  be such that  $\pi_V = \psi_k(\tilde{\pi}_V)$  and  $\pi_W = \psi_k^{op}(\tilde{\pi}_W)$ . Then the multiplicity of  $Z$  in  $V \otimes_{\mathcal{M}_1} W$  is the dimension of the range of the following tangle, viewed as a linear map from  $P_{8k}$  to  $\mathcal{A}(\mathcal{P})_{6k}$ :*

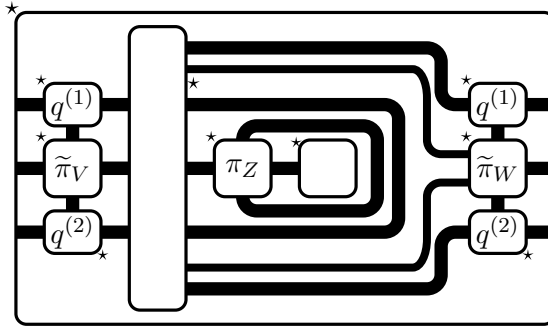

Moreover, the fusion category of  $\mathcal{M}_1 - \mathcal{M}_1$  bimodules is braided.  $\square$

*Proof.* For the first statement we compute the Bratteli diagram of the inclusion

$$\text{Hom}_{\mathcal{M}_1, \mathcal{M}_1}(L^2(\mathcal{M}_n)) \otimes \text{Hom}_{\mathcal{M}_1, \mathcal{M}_1}(L^2(\mathcal{M}_n)) \hookrightarrow \text{Hom}_{\mathcal{M}_1, \mathcal{M}_1}(L^2(\mathcal{M}_{2n})),$$

using the description from the proof of Proposition 5.14. As discussed above, the unitary operator  $p_{n-1}u_n p_{n-1} \in \text{Hom}_{\mathcal{M}_1, \mathcal{M}_1}(L^2(\mathcal{M}_{2n}))$  implements the braiding for this inclusion.  $\square$

## REFERENCES

- [1] *S. Curran, V. Jones, and D. Shlyakhtenko*, On the symmetric enveloping algebra of planar algebra subfactors, [arXiv:1105.1721 \[math.OA\]](#), 2011.
- [2] *P. Das, S. K. Ghosh, and V. P. Gupta*, Affine modules and the Drinfeld center, [arXiv:1010.0460 \[math.QA\]](#), 2010.
- [3] *P. Das, S. K. Ghosh, and V. P. Gupta*, Drinfeld center of planar algebra, [arXiv:1203.3958 \[math.QA\]](#), 2012.
- [4] *D. E. Evans and Y. Kawahigashi*, On Ocneanu’s theory of asymptotic inclusions for subfactors, topological quantum field theories and quantum doubles, *Internat. J. Math.*, **6** (1995), 205–228.
- [5] *M. Freedman, C. Nayak, K. Walker, and Z. Wang*, On picture  $(2 + 1)$ -TQFTs, in *Topology and physics*, vol. 12 of *Nankai Tracts Math.*, World Sci. Publ., Hackensack, NJ, 2008, 19–106.
- [6] *S. K. Ghosh*, Planar algebras: a category theoretic point of view, *J. Algebra*, **339** (2011), 27–54.
- [7] *F. M. Goodman, P. de la Harpe, and V. F. R. Jones*, *Coxeter graphs and towers of algebras*, vol. 14 of *Mathematical Sciences Research Institute Publications*, Springer-Verlag, New York, 1989.
- [8] *A. Guionnet, V. Jones, and D. Shlyakhtenko*, A semi-finite algebra associated to a subfactor planar algebra, *J. Funct. Anal.*, **261** (2011), 1345–1360.
- [9] *A. Guionnet, V. F. R. Jones, and D. Shlyakhtenko*, Random matrices, free probability, planar algebras and subfactors, in *Quanta of maths*, vol. 11 of *Clay Math. Proc.*, Amer. Math. Soc., Providence, RI, 2010, 201–239.
- [10] *M. Izumi*, The structure of sectors associated with Longo-Rehren inclusions. I. General theory, *Comm. Math. Phys.*, **213** (2000), 127–179.
- [11] *M. Izumi*, The structure of sectors associated with Longo-Rehren inclusions. II. Examples, *Rev. Math. Phys.*, **13** (2001), 603–674.
- [12] *V. F. R. Jones*, Index for subfactors, *Invent. Math.*, **72** (1983), 1–25.
- [13] *V. F. R. Jones*, Planar algebras, [arXiv:9909027 \[math.QA\]](#), 1999.
- [14] *V. F. R. Jones*, The planar algebra of a bipartite graph, in *Knots in Hellas ’98 (Delphi)*, vol. 24 of *Ser. Knots Everything*, World Sci. Publ., River Edge, NJ, 2000, 94–117.
- [15] *V. F. R. Jones*, The annular structure of subfactors, in *Essays on geometry and related topics*, Vol. 1, 2, vol. 38 of *Monogr. Enseign. Math.*, Enseignement Math., Geneva, 2001, 401–463.
- [16] *R. Longo and K.-H. Rehren*, Nets of subfactors, *Rev. Math. Phys.*, **7** (1995), 567–597, *Workshop on Algebraic Quantum Field Theory and Jones Theory (Berlin, 1994)*.
- [17] *M. Müger*, From subfactors to categories and topology. II. The quantum double of tensor categories and subfactors, *J. Pure Appl. Algebra*, **180** (2003), 159–219.
- [18] *A. Ocneanu*, Quantized groups, string algebras and Galois theory for algebras, in *Operator algebras and applications*, Vol. 2, vol. 136 of *London Math. Soc. Lecture Note Ser.*, Cambridge Univ. Press, Cambridge, 1988, 119–172.
- [19] *S. Popa*, Symmetric enveloping algebras, amenability and AFD properties for subfactors, *Math. Res. Lett.*, **1** (1994), 409–425.
- [20] *S. Popa*, An axiomatization of the lattice of higher relative commutants of a subfactor, *Invent. Math.*, **120** (1995), 427–445.
- [21] *S. Popa*, Some properties of the symmetric enveloping algebra of a subfactor, with applications to amenability and property T, *Doc. Math.*, **4** (1999), 665–744.
- [22] *D. Shlyakhtenko*, Free probability, planar algebras, subfactors and random matrices, in *Proceedings of the International Congress of Mathematicians (Hyderabad, India, 2010)*, vol. III, 1603–1623.

DEPARTMENT OF MATHEMATICS, UCLA, LOS ANGELES, CA 90095.

*E-mail address:* [curransr@math.ucla.edu](mailto:curransr@math.ucla.edu)