

Singular Fibers in Barking Families of Degenerations of Elliptic Curves

Takayuki OKUDA

Abstract

Takamura [Ta3] established a theory on splitting families of degenerations of complex curves. He introduced a powerful method for constructing a splitting family, called a *barking family*, in which there appear not only a singular fiber over the origin but also singular fibers over other points, called subordinate fibers. In this paper, for the case of degenerations of elliptic curves, we determine the types of these subordinate fibers.

1 Introduction

Let $\pi : M \rightarrow \Delta$ be a proper surjective holomorphic map from a smooth complex surface M to an open disk $\Delta := \{s \in \mathbb{C} : |s| < \delta\}$ ($\delta > 0$) on \mathbb{C} . We call $\pi : M \rightarrow \Delta$ a *family of complex curves* of genus $g \geq 1$ if all but a finite number of fibers of π are smooth complex curves of genus g . In particular, $\pi : M \rightarrow \Delta$ is called a *degeneration* (or *degenerating family*) of complex curves of genus g if the fiber $X_0 := \pi^{-1}(0)$ over the origin is singular and the other fibers $X_s := \pi^{-1}(s)$ ($s \neq 0$) are smooth.

In this paper, we are interested in the problem: *How does the singular fiber split in a deformation?* Let us recall the concept of splitting families of degenerations. Let \mathcal{M} be a smooth complex 3-manifold and set $\Delta^\dagger := \{t \in \mathbb{C} : |t| < \epsilon\}$ ($\epsilon > 0$), a sufficiently small disk. Consider a proper flat surjective holomorphic map $\Psi : \mathcal{M} \rightarrow \Delta \times \Delta^\dagger$. For any $t \in \Delta^\dagger$, set $\Delta_t := \Delta \times \{t\}$, $M_t := \Psi^{-1}(\Delta_t)$ and $\pi_t := \Psi|_{M_t} : M_t \rightarrow \Delta_t$. Suppose that $\pi_0 : M_0 \rightarrow \Delta_0$ coincides with a given degeneration $\pi : M \rightarrow \Delta$. Then we call $\Psi : \mathcal{M} \rightarrow \Delta \times \Delta^\dagger$ a *deformation family* of the degeneration $\pi : M \rightarrow \Delta$. In particular, $\Psi : \mathcal{M} \rightarrow \Delta \times \Delta^\dagger$ is called a *splitting family* if for any $t \in \Delta^\dagger \setminus \{0\}$, $\pi_t : M_t \rightarrow \Delta_t$ is a family of complex curves with at least two singular fibers. In this case, setting $X_{s,t} := \Psi^{-1}(s, t)$, we say that the original singular fiber X_0 in M (that is, $X_{0,0}$ in M_0) *splits into* singular fibers $X_{s_1,t}, X_{s_2,t}, \dots, X_{s_N,t}$ in M_t ($t \neq 0$).

2010 *Mathematics Subject Classification*. Primary 14D06, 32S50; Secondary 14H15, 14D05.

Key words and phrases. Degeneration of complex curves, Splitting family, Elliptic curve, Singular fiber, Monodromy.

To classify *atomic degenerations* — degenerations admitting no splitting family — Takamura [Ta3] gave a powerful method for constructing splitting families. Splitting families obtained by this construction are called *barking families*. In a barking family, the original singular fiber X_0 splits into a singular fiber over the origin (the *main fiber*) and other singular fibers (*subordinate fibers*). Takamura describes the main fiber explicitly in such a way that a part of the original singular fiber X_0 looks “barked” (peeled) off from X_0 . See Figure 2 in Section 2.

In this paper, for the case of degenerations of elliptic curves (complex curves of genus 1), we will almost completely describe the subordinate fibers appearing in barking families. In Section 2, we first review Takamura’s theory on barking deformations, mainly for degenerations with *stellar* (star-shaped) singular fibers. In fact, most of the degenerations of elliptic curves may have stellar singular fibers. In Section 3, we will give the main theorem — a list of barking deformations, which describes the types of singular fibers appearing in them. To obtain the list, in Section 4, we determine the types of subordinate fibers. We focus on the sum of the Euler characteristics of singular fibers and give a list of combinations of subordinate fibers that can appear for each deformation. Then we determine their types (except for some deformations¹) in two ways: (1) by comparing the traces of their monodromies and (2) by investigating the number of the subordinate fibers and that of their singularities.

Acknowledgements The author would like to express his deep gratitude to Shigeru Takamura for fruitful discussions. The author would also like to thank Masaaki Ue and Osamu Saeki for helpful comments and suggestions.

2 Takamura’s theory

In this section, we review Takamura’s theory on barking deformations. For details see [Ta3].

First we shall recall the concept of linear degenerations. We begin with preparation. Let $\pi : M \rightarrow \Delta$ be a degeneration of complex curves of genus $g \geq 1$ and express its singular fiber as $X_0 = \sum_i m_i \Theta_i$, where Θ_i is an irreducible component of X_0 with multiplicity m_i . We call $\pi : M \rightarrow \Delta$ (or X_0) is *normally minimal* if the following conditions are satisfied: (i) Any singularity of the *underlying reduced curve* $X_{0,red} := \sum_i \Theta_i$ of X_0 is a node. (ii) If Θ_i is a (-1) -curve (an exceptional curve of the first kind), then Θ_i intersects other irreducible components at at least three points. In what follows, we assume that any given degeneration $\pi : M \rightarrow \Delta$ is normally minimal²,

¹ See (4.8), (5.3), (5.4) and (7.2) in the list of Theorem 3.1.

² In [Ta2] and [Ta3], we define linear degenerations for the case that $X_{0,red}$ has at most *simple normal crossings*, that is, (i) any singularity of $X_{0,red}$ is a node and (iii) any irreducible component Θ_i is not self-intersecting. Note that all normally minimal degenerations of elliptic curves but of type mI_1 satisfy the condition (iii).

For an irreducible component Θ_i of X_0 , we denote by N_i the normal bundle of Θ_i in M . Let $\{p_i^{(1)}, p_i^{(2)}, \dots, p_i^{(h)}\}$ be the set of the intersection points on Θ_i with other irreducible components of X_0 and $m^{(j)}$ ($j = 1, 2, \dots, h$) be the multiplicity of the irreducible component intersecting Θ_i at $p_i^{(j)}$. Then there exists a holomorphic section σ_i of the line bundle $N_i^{\otimes(-m_i)}$ such that

$$\operatorname{div}(\sigma_i) = \sum_{j=1}^h m^{(j)} p_i^{(j)},$$

where $\operatorname{div}(\sigma_i)$ denotes the divisor defined by σ_i . Here σ_i has a zero of order $m^{(j)}$ at $p_i^{(j)}$. Note that σ_i is uniquely determined up to multiplication by a constant. We call σ_i the *standard section* of $N_i^{\otimes(-m_i)}$ on Θ_i .

Take an open covering $\Theta_i = \bigcup_{\alpha} U_{\alpha}$ such that $U_{\alpha} \times \mathbb{C}$ is a local trivialization of the normal bundle N_i on Θ_i . We denote by $(z_{\alpha}, \zeta_{\alpha})$ coordinates of $U_{\alpha} \times \mathbb{C}$. Now define a holomorphic function $\pi_{i,\alpha} : U_{\alpha} \times \mathbb{C} \rightarrow \mathbb{C}$ by

$$\pi_{i,\alpha}(z_{\alpha}, \zeta_{\alpha}) := \sigma_{i,\alpha}(z_{\alpha}) \zeta_{\alpha}^{m_i},$$

where $\sigma_{i,\alpha}$ is the local expression of σ_i on U_{α} . Then the set $\{\pi_{i,\alpha}\}_{\alpha}$ of holomorphic functions defines a global holomorphic function $\pi_i : N_i \rightarrow \mathbb{C}$.

Definition 2.1. A degeneration $\pi : M \rightarrow \Delta$ is called *linear* if for any irreducible component Θ_i of its singular fiber X_0 ,

- (1) a tubular neighborhood $N(\Theta_i)$ of Θ_i in M is biholomorphic to a tubular neighborhood of a zero-section of the normal bundle N_i , and
- (2) under the identification by the biholomorphism of (1), the following conditions are satisfied:
 - (a) The restriction $\pi|_{N(\Theta_i)}$ coincides with the holomorphic function π_i defined above.
 - (b) If Θ_i intersects Θ_j at a point p , then there exist local trivializations $U_{\alpha} \times \mathbb{C}$ of N_i and $U_{\beta} \times \mathbb{C}$ of N_j around p such that neighborhoods of p in $N(\Theta_i)$ and $N(\Theta_j)$ are identified by *plumbing* $(z_{\alpha}, \zeta_{\alpha}) = (\zeta_{\beta}, z_{\beta})$ and π is locally expressed as

$$\pi|_{N(\Theta_i)}(z_{\alpha}, \zeta_{\alpha}) = z_{\alpha}^{m_j} \zeta_{\alpha}^{m_i} \quad \text{and} \quad \pi|_{N(\Theta_j)}(z_{\beta}, \zeta_{\beta}) = z_{\beta}^{m_i} \zeta_{\beta}^{m_j},$$

where $(z_{\alpha}, \zeta_{\alpha}) \in U_{\alpha} \times \mathbb{C}$ and $(z_{\beta}, \zeta_{\beta}) \in U_{\beta} \times \mathbb{C}$.

Remark 2.2. Any degeneration of complex curves (possibly, not normally minimal), after successive blowing up and down, becomes a degeneration topologically equivalent to some linear degeneration.

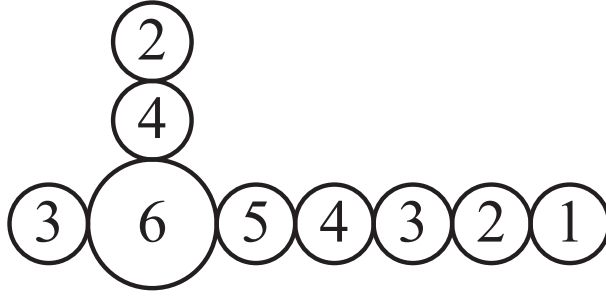

Figure 1: A singular fiber of type II^* of a degeneration of elliptic curves is stellar. Each circle denotes a projective line, the number stands for its multiplicity, and each intersection point is a node.

If $\pi : M \rightarrow \Delta$ is linear, then we may express M locally as a hypersurface in some space as follows: We first identify M with the graph of π in $M \times \Delta$

$$\text{Graph}(\pi) = \{(x, s) \in M \times \Delta : \pi(x) - s = 0\}$$

via the natural projection $\text{Graph}(\pi) \ni (x, s) \rightarrow x \in M$. Recall that for any irreducible component Θ_i of the singular fiber X_0 , the map π is expressed around Θ_i as

$$\pi(z_i, \zeta_i) = \sigma_i(z_i)\zeta_i^{m_i},$$

where σ_i is the standard section of $N_i^{\otimes(-m_i)}$ on Θ_i . Then we obtain the local expression of M around Θ_i :

$$H_i : \quad \sigma_i(z_i)\zeta_i^{m_i} - s = 0 \quad \text{in } N_i \times \Delta. \quad (2.1)$$

Note that these hypersurfaces are glued around their intersection points by plumbing $(z_j, \zeta_j, s) = (\zeta_i, z_i, s)$ where $(z_i, \zeta_i, s) \in N_i \times \Delta$ and $(z_j, \zeta_j, s) \in N_j \times \Delta$.

For a linear degeneration $\pi : M \rightarrow \Delta$, its singular fiber X_0 consists of three kinds of parts: *cores*, *branches* and *trunks*. A irreducible component Θ_i of X_0 is called a *core* if (a) Θ_i intersects other irreducible components at at least three points or (b) Θ_i is not a projective line. A *branch* is a chain $\sum_i m_i \Theta_i$ of projective lines attached with a core on one hand, while a *trunk* is a chain $\sum_i m_i \Theta_i$ of projective lines connecting other irreducible components on both hands. We say that X_0 is a *stellar* singular fiber if X_0 consists of a core and branches emanating from it. See Figure 1. Otherwise X_0 is said to be *constellar*.

We obtain a ‘degeneration’ whose singular fiber is a *fringed* branch of length λ as follow: Let $m_0, m_1, \dots, m_{\lambda+1}$ ³ ($\lambda \geq 1$) be nonnegative integers such that

$$\begin{cases} m_0 > m_1 > \dots > m_\lambda > m_{\lambda+1} = 0 \text{ and} \\ r_i := (m_{i-1} + m_{i+1})/m_i \text{ is an integer greater than 1 } (i = 1, 2, \dots, \lambda). \end{cases} \quad (\#)$$

³ In this paper, by convention, we append $m_{\lambda+1} = 0$ to the positive integers $m_0, m_1, \dots, m_\lambda$ (see [Ta3] Section 5.1, p.85), so that $r_\lambda := (m_{\lambda-1} + m_{\lambda+1})/m_\lambda$ equals $m_{\lambda-1}/m_\lambda$.

We take λ copies $\Theta_1, \Theta_2, \dots, \Theta_\lambda$ of the projective line. Let $\Theta_i = U_i \cup V_i$ be a open covering by two complex lines $U_i, V_i (= \mathbb{C})$ with coordinates $w_i \in U_i$ and $z_i \in V_i$ satisfying $z_i = 1/w_i$. Next we obtain a line bundle N_i on Θ_i of order $-r_i$ from $U_i \times \mathbb{C}$ and $V_i \times \mathbb{C}$ by identifying $(z_i, \zeta_i) \in V_i \times \mathbb{C}$ with $(w_i, \eta_i) \in U_i \times \mathbb{C}$ via

$$g_i : z_i = \frac{1}{w_i}, \quad \zeta_i = w_i^{r_i} \eta_i.$$

Now consider the hypersurface W_i in $N_i \times \Delta$ defined by

$$\begin{cases} H_i : w_i^{m_i-1} \eta_i^{m_i} - s = 0, & \text{in } U_i \times \mathbb{C} \times \Delta, \\ H'_i : z_i^{m_i+1} \zeta_i^{m_i} - s = 0, & \text{in } V_i \times \mathbb{C} \times \Delta. \end{cases} \quad (2.2)$$

Under the plumbings $(w_{i+1}, \eta_{i+1}, s) = (\zeta_i, z_i, s)$ of N_i and N_{i+1} ($i = 1, 2, \dots, \lambda - 1$), the hypersurfaces $W_1, W_2, \dots, W_\lambda$ are glued, so that they together define a smooth complex surface M . Letting $\pi : M \rightarrow \Delta$ be the natural projection, the central fiber is

$$\pi^{-1}(0) = m_0 \mathbb{C} + m_1 \Theta_1 + m_2 \Theta_2 + \dots + m_\lambda \Theta_\lambda.$$

Thus:

Lemma 2.3. *Let $m_0, m_1, \dots, m_{\lambda+1}$ ($\lambda \geq 1$) be integers satisfying the following conditions:*

$$\begin{cases} m_0 > m_1 > \dots > m_\lambda > m_{\lambda+1} = 0. \\ r_i := (m_{i-1} + m_{i+1})/m_i \text{ is an integer greater than 1 } (i = 1, 2, \dots, \lambda). \end{cases} \quad (\#)$$

Then there exists a degeneration with the singular fiber

$$X_0 = m_0 \Delta_0 + m_1 \Theta_1 + m_2 \Theta_2 + \dots + m_\lambda \Theta_\lambda,$$

where Δ_0 is an open disk and $\Theta_1, \Theta_2, \dots, \Theta_\lambda$ are projective lines such that each pair of Θ_i and Θ_{i+1} ($i = 1, 2, \dots, \lambda - 1$) and Δ_0 and Θ_1 intersect transversely at one point.

Next we define a special subdivisor of stellar singular fibers. Let $\pi : M \rightarrow \Delta$ be a linear degeneration of complex curves with the stellar singular fiber $X_0 = m_0 \Theta_0 + \sum_{j=1}^h \text{Br}^{(j)}$, where Θ_0 is the core and $\text{Br}^{(j)}$ ($j = 1, 2, \dots, h$) is a branch. Express as $\text{Br}^{(j)} = m_1^{(j)} \Theta_1^{(j)} + m_2^{(j)} \Theta_2^{(j)} + \dots + m_{\lambda^{(j)}}^{(j)} \Theta_{\lambda^{(j)}}^{(j)}$ and let $\overline{\text{Br}}^{(j)} = m_0 \Delta_0^{(j)} + m_1^{(j)} \Theta_1^{(j)} + \dots + m_{\lambda^{(j)}}^{(j)} \Theta_{\lambda^{(j)}}^{(j)}$ be a fringed branch. Consider a connected subdivisor $Y = n_0 \Theta_0 + \sum_{j=1}^h \text{br}^{(j)}$ of X_0 , where $\text{br}^{(j)} := n_1^{(j)} \Theta_1^{(j)} + n_2^{(j)} \Theta_2^{(j)} + \dots + n_{\nu^{(j)}}^{(j)} \Theta_{\nu^{(j)}}^{(j)}$ ($j = 1, 2, \dots, h$). Here Y satisfies $0 \leq \nu^{(j)} \leq \lambda^{(j)}$ and $0 < n_i^{(j)} \leq m_i^{(j)}$ for each i and j . Set $\overline{\text{br}}^{(j)} := n_0 \Delta_0^{(j)} + n_1^{(j)} \Theta_1^{(j)} + n_2^{(j)} \Theta_2^{(j)} + \dots + n_{\nu^{(j)}}^{(j)} \Theta_{\nu^{(j)}}^{(j)}$. For the time being, we focus on $\overline{\text{Br}}^{(j)}$ and $\overline{\text{br}}^{(j)}$, omitting the superscript (j) to simplify notation. We call $\overline{\text{br}}$ a *subbranch* of $\overline{\text{Br}}$ if one of the following conditions is satisfied:

(1) $\nu = 0, 1$, or (2) $\nu \geq 2$ and $n_{i+1} = r_i n_i - n_{i-1}$ ($i = 1, 2, \dots, \nu - 1$),

where $r_i := (m_{i-1} + m_{i+1})/m_i$ (see (#) in Lemma 2.3). Inductively set $n_{\nu+1} := r_\nu n_\nu - n_{\nu-1}$ ($\nu \geq 1$). If $\nu = 0$, then we set $n_{\nu+1} = n_1 := 0$. Next define the three types of subbranches for a positive integer l as follows:

Type A_l . A subbranch $\overline{\text{br}}$ of $\overline{\text{Br}}$ is of *type A_l* if $ln_i \leq m_i$ for each i and $n_{\nu+1} \leq 0$.

Type B_l . A subbranch $\overline{\text{br}}$ of $\overline{\text{Br}}$ is of *type B_l* if $ln_i \leq m_i$ for each i , $n_\nu = 1$ and $m_\nu = l$.

Type C_l . A subbranch $\overline{\text{br}}$ of $\overline{\text{Br}}$ is of *type C_l* if $ln_i \leq m_i$ for each i , $n_\nu = n_{\nu+1}$ and $m_\nu - m_{\nu+1}$ divides l .

Now we return to a connected subdivisor Y of the stellar singular fiber X_0 .

Definition 2.4. Let $Y = n_0 \Theta_0 + \sum_{j=1}^h \text{br}^{(j)}$ be a connected subdivisor of X_0 such that $n_0 < m_0$ and each $\overline{\text{br}}^{(j)}$ is a subbranch of $\overline{\text{Br}}^{(j)}$. Then Y is called a *crust* of X_0 if there exists a meromorphic section τ of the line bundle $N_0^{\otimes n_0}$ on Θ_0 such that for some nonnegative divisor $D = \sum_{i=1}^k a_i q_i$ on Θ_0 ,

$$\text{div}(\tau) = - \sum_{j=1}^h n_1^{(j)} p^{(j)} + D,$$

where N_0 denotes the normal bundle of Θ_0 in M , $\{p^{(j)}\}$ is the set of the attachment points on Θ_0 with the branches $\text{Br}^{(j)}$. Moreover, for a positive integer l , if each $\overline{\text{br}}^{(j)}$ is a subbranch of $\overline{\text{Br}}^{(j)}$ of either type A_l , type B_l or type C_l , then we call Y a *simple crust* of X_0 with *barking multiplicity l* .

We call the meromorphic section τ a *core section*. Note that τ is not uniquely determined by Y . Setting $r_0 := \sum_{j=1}^h m_1^{(j)}/m_0$ and $r'_0 := \sum_{j=1}^h n_1^{(j)}/n_0$, the following holds:

Lemma 2.5. *Suppose that Θ_0 is a projective line. Then a connected subdivisor Y is a crust of X_0 (equivalently, Y has a core section τ) if and only if $r_0 \leq r'_0$. Moreover τ has no zero, that is, $D = 0$ exactly when $r_0 \leq r'_0$.*

Now we state Takamura's theorem:

Theorem 2.6 (Takamura [Ta3]). *Let $\pi : M \rightarrow \Delta$ be a linear degeneration with the stellar singular fiber X_0 . If X_0 has a simple crust, then $\pi : M \rightarrow \Delta$ admits a splitting family $\Psi : \mathcal{M} \rightarrow \Delta \times \Delta^\dagger$.*

Takamura constructed a deformation family of $\pi : M \rightarrow \Delta$ associated with a simple crust Y , which turns out to be a splitting family. We call it a *barking family associated with the simple crust Y* and this construction is called a *barking deformation*. For a singular fiber $X_{s,t} := \Psi^{-1}(s, t)$ ($t \neq 0$) in a barking family, we say that $X_{s,t}$ is the *main fiber* if $s = 0$, and a *subordinate fiber* if $s \neq 0$. In other words, the original singular fiber splits into the main fiber and subordinate fibers. Takamura describes the main fiber $X_{0,t}$ explicitly in such a way that the simple crust Y looks “barked” (peeled) off from the original singular fiber X_0 . See Figure 2.

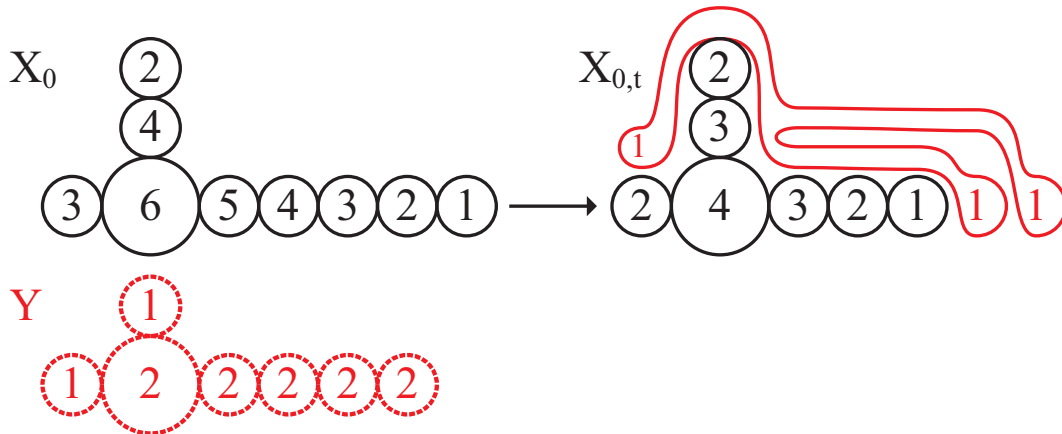

Figure 2: In a barking family, the singular fiber of type II^* splits into the main fiber of type III^* and some subordinate fiber. It seems that the simple crust is “barked” (peeled) off from the original singular fiber.

Kodaira’s notation Before proceeding, we include Kodaira’s list of singular fibers of (relatively) minimal degenerations of elliptic curves [Ko]. See Table 1 below.

For a singular fiber X , we denote by $e(X)$ the topological Euler characteristic of the underlying reduced curve of X . Let $A_X \in SL(2, \mathbb{Z})$ be the standard monodromy matrix of X and $\text{Tr}(A_X)$ denote the trace of A_X . Note that singular fibers of type II, III, IV are not normally minimal. After successive blowing up, they become normally minimal. On the other hand, The other singular fibers are normally minimal.

3 Main result

Takamura showed the list of simple crusts (and weighted crustal sets) for barking deformations for degenerations of complex curves of genera up to 5. See Chapter 26 of [Ta3]. As we saw in Section 2, barking deformations explicitly describe the main fibers appearing in barking families. On the other hand, it is not clear what types of subordinate fibers will appear. The aim of this paper is to show the description of subordinate fibers in these barking families for the case of degenerations of elliptic curves (complex curves of genus 1).

In what follows, if the original singular fiber X_0 splits into the main fiber $X_{0,t}$ and subordinate fibers $X_{s_1,t}, X_{s_2,t}, \dots, X_{s_N,t}$, then we express

$$X_0 \longrightarrow X_{0,t} \text{ with } X_{s_1,t} + X_{s_2,t} + \dots + X_{s_N,t}$$

to distinguish $X_{0,t}$ from the others. We denote the types of singular fibers of genus 1 in Kodaira’s notation. See Table 1.

Table 1: Kodaira's notation.

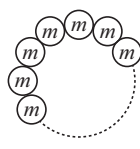
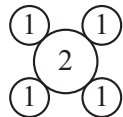
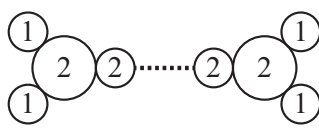
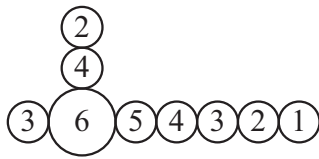
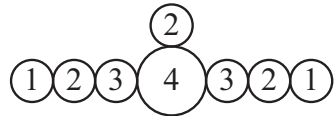
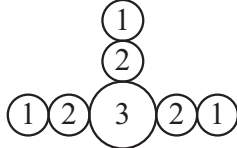
	the singular fiber X	$e(X)$	A_X	$\text{Tr}(A_X)$
$mI_0(m \geq 2)$	a multiple torus	0	$\begin{pmatrix} 1 & 0 \\ 0 & 1 \end{pmatrix}$	2
mI_1	a (multiple) projective line with one node	1	$\begin{pmatrix} 1 & 1 \\ 0 & 1 \end{pmatrix}$	2
$mI_n(n \geq 2)$		n	$\begin{pmatrix} 1 & n \\ 0 & 1 \end{pmatrix}$	2
II	a projective line with one cusp	2	$\begin{pmatrix} 1 & 1 \\ -1 & 0 \end{pmatrix}$	1
III	two projective lines with second order contact	3	$\begin{pmatrix} 0 & 1 \\ -1 & 0 \end{pmatrix}$	0
IV	three projective lines intersecting transversally at one point	4	$\begin{pmatrix} 0 & 1 \\ -1 & -1 \end{pmatrix}$	-1
I_0^*		6	$\begin{pmatrix} -1 & 0 \\ -1 & 0 \end{pmatrix}$	-1
I_n^*		$6 + n$	$\begin{pmatrix} -1 & -n \\ -1 & 0 \end{pmatrix}$	-1
II^*		10	$\begin{pmatrix} 0 & -1 \\ 1 & 1 \end{pmatrix}$	1
III^*		9	$\begin{pmatrix} 0 & -1 \\ 1 & 0 \end{pmatrix}$	0
IV^*		8	$\begin{pmatrix} -1 & -1 \\ 1 & 0 \end{pmatrix}$	-1

Theorem 3.1. For degenerations of complex curves of genus 1 (that is, elliptic curves), the types of subordinate fibers in the barking families listed in [Ta3] are presented in the following list:

(1.1) $II \rightarrow I_1$ with I_1

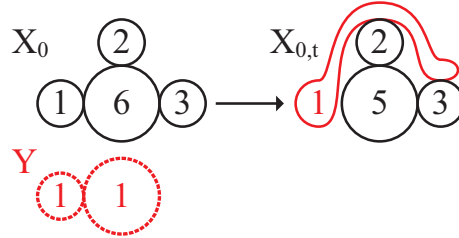

(1.2) $II \rightarrow I_1$ with I_1

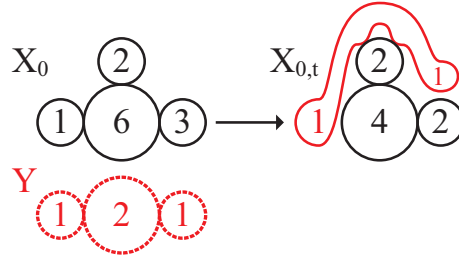

(2.1) $II^* \rightarrow III^*$ with I_1

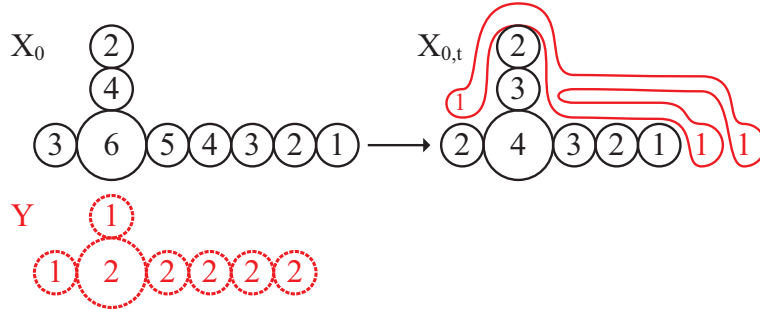

(2.2) $II^* \rightarrow IV^*$ with II

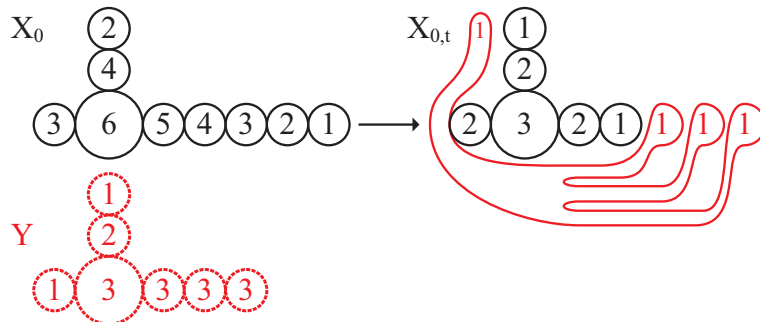

(2.3) $II^* \rightarrow I_2^*$ with $I_1 + I_1$

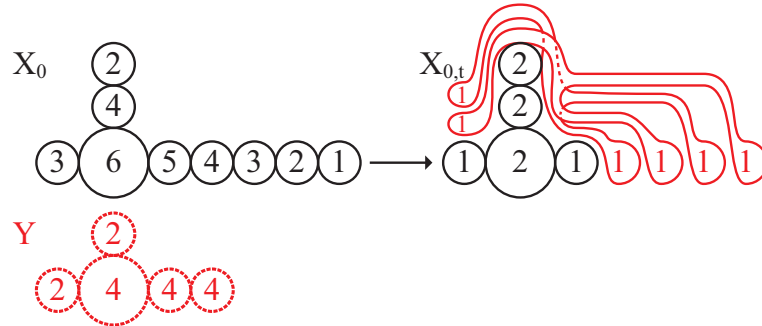

(2.4) $II^* \rightarrow I_5^*$ with $I_1 + I_1 + I_1 + I_1 + I_1$

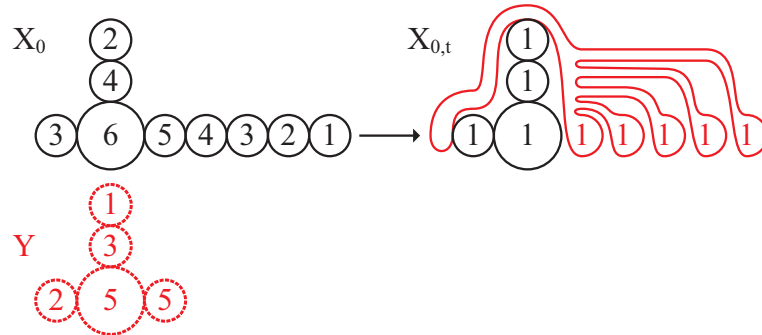

(2.5) $II^* \rightarrow I_3^*$ with I_1

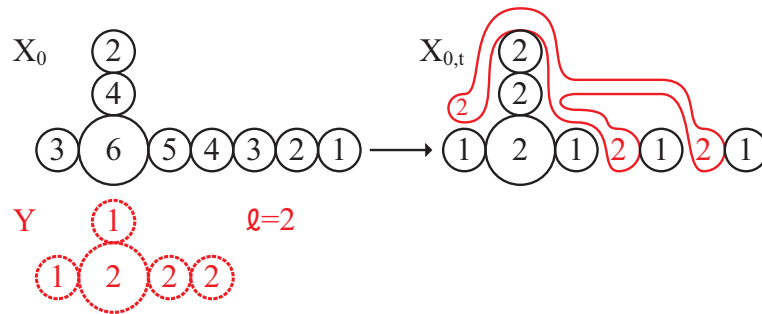

(2.6) $II^* \rightarrow I_3^*$ with I_1

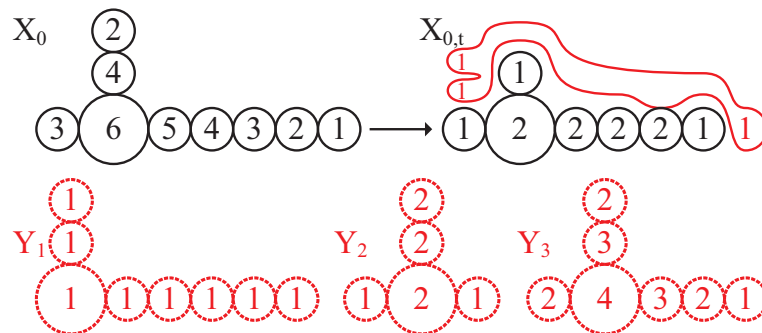

(2.7) $II^* \rightarrow I_8$ with $I_1 + I_1$

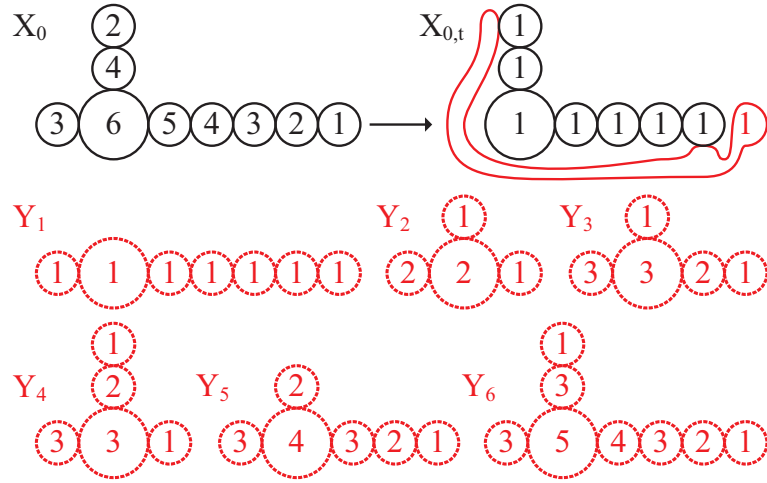

(2.8) $II^* \rightarrow III^*$ with I_1

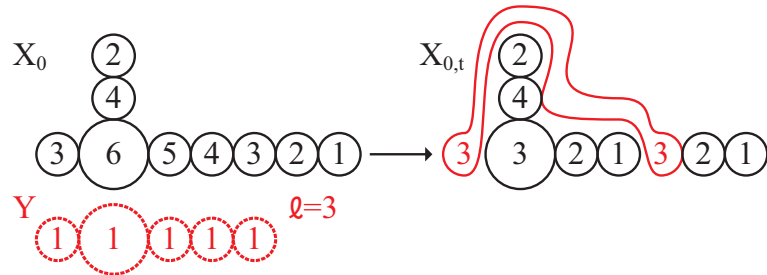

(2.9) $II^* \rightarrow III^*$ with I_1

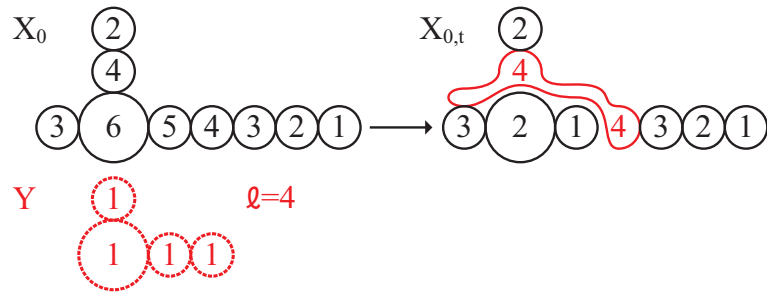

(3.1) $III \rightarrow I_2$ with I_1

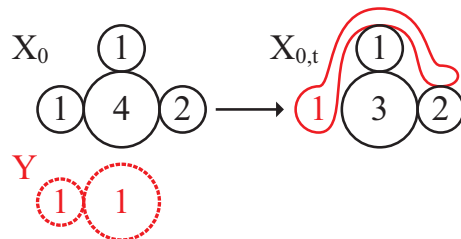

(3.2) $III \rightarrow I_1$ with I_2

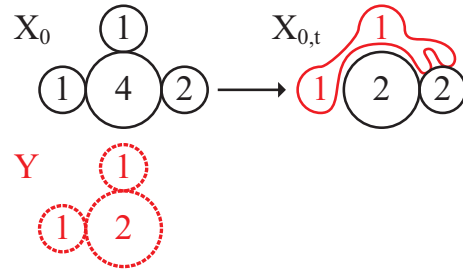

(3.3) $III \rightarrow I_2$ with I_1

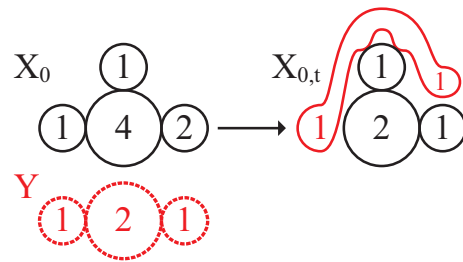

(4.1) $III^* \rightarrow IV^*$ with I_1

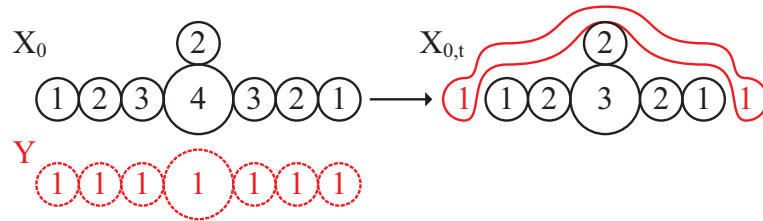

(4.2) $III^* \rightarrow I_1^*$ with I_2

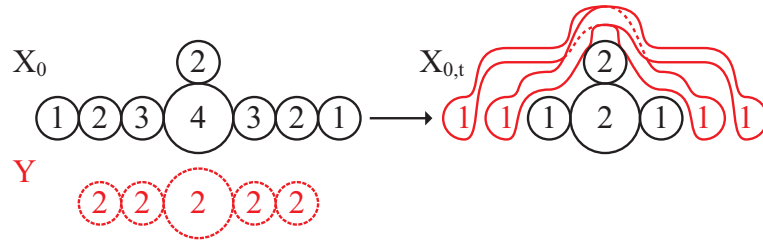

(4.3) $III^* \rightarrow I_2^*$ with I_1

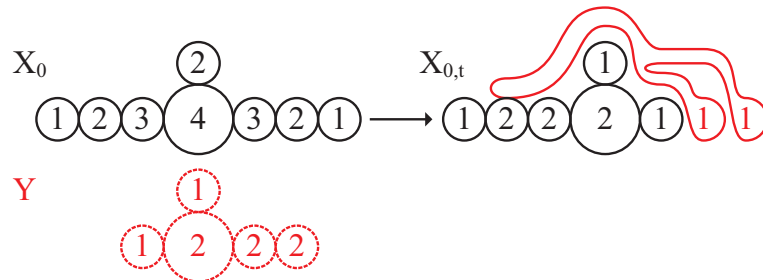

(4.4) $III^* \rightarrow I_0^*$ with $I_1 + I_1 + I_1$

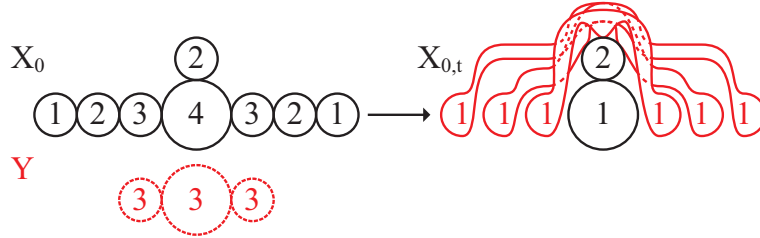

(4.5) $III^* \rightarrow I_6$ with $I_1 + I_1 + I_1$

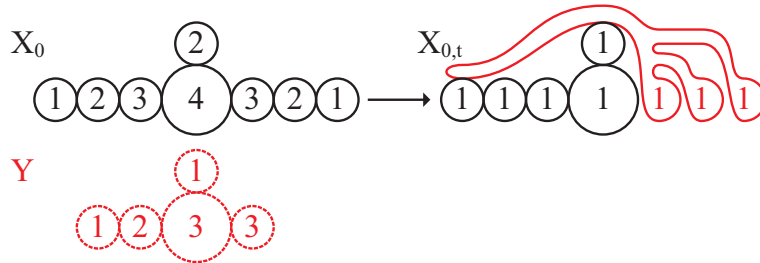

(4.6) $III^* \rightarrow I_2^*$ with I_1

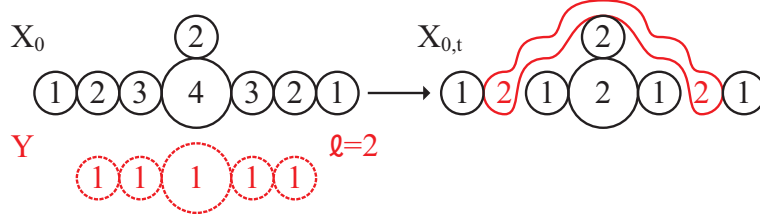

(4.7) $III^* \rightarrow I_7$ with $I_1 + I_1$

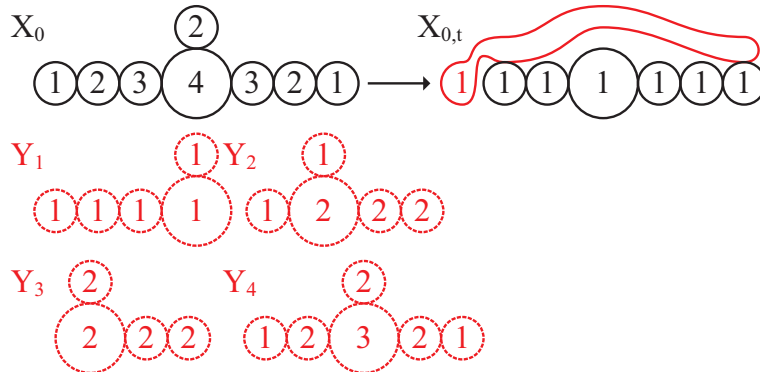

(4.8) $III^* \rightarrow I_6$ with $(II + I_1, I_2 + I_1$ or $I_1 + I_1 + I_1)$

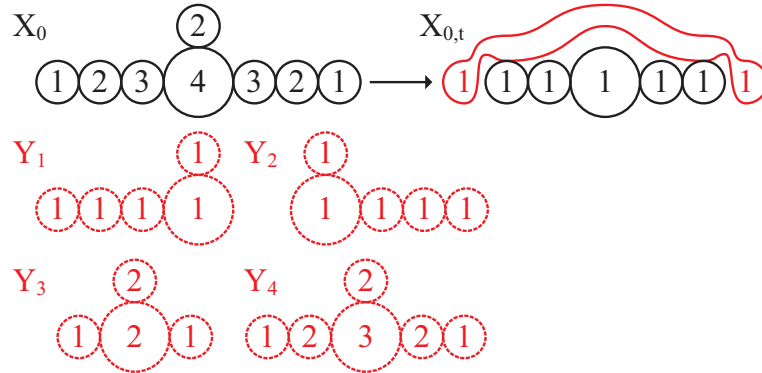

(4.9) $III^* \rightarrow IV$ with I_1

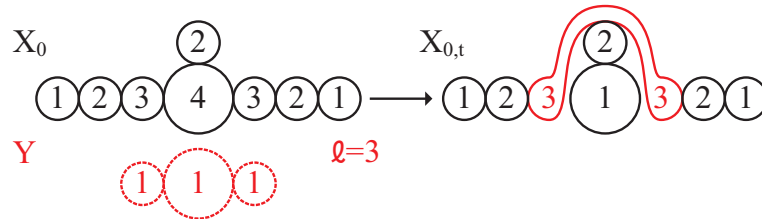

(5.1) $IV \rightarrow I_3$ with I_1

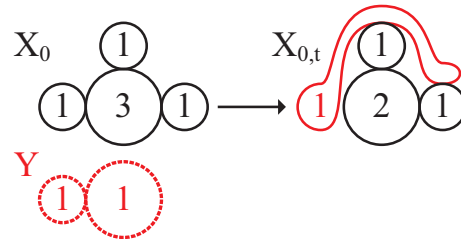

(5.2) $IV \rightarrow I_2$ with $I_1 + I_1$

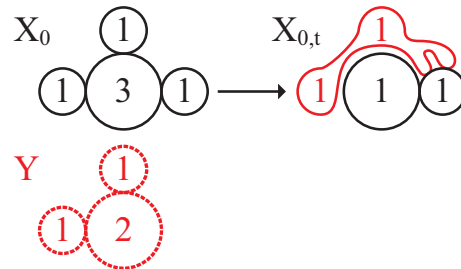

(5.3) $IV \rightarrow I_2$ with $(II \text{ or } I_1 + I_1)$

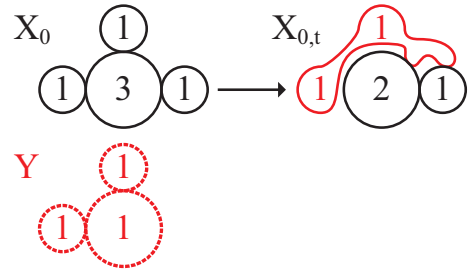

(5.4) $IV \rightarrow II$ with $(II, I_2 \text{ or } I_1 + I_1)$

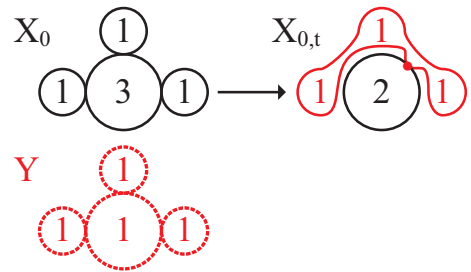

(6.1) $IV^* \rightarrow I_1^*$ with I_1

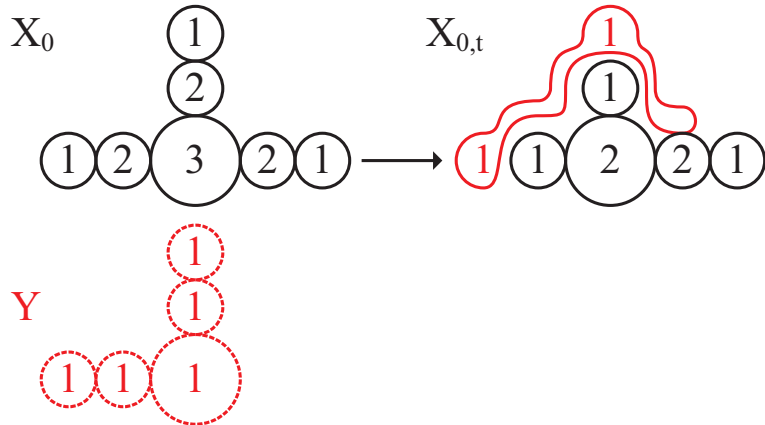

(6.2) $IV^* \rightarrow I_0^*$ with $I_1 + I_1$

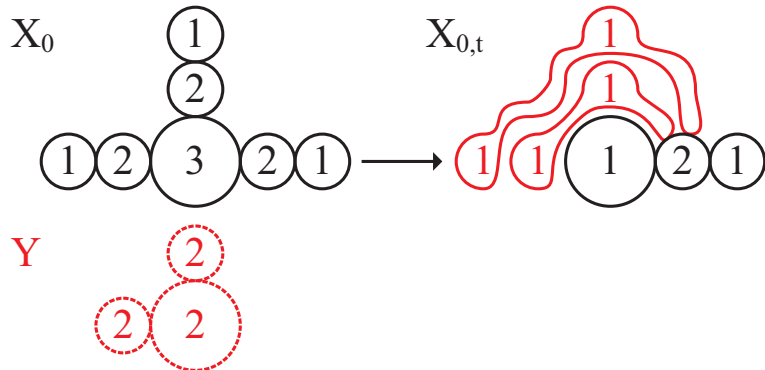

(6.3) $IV^* \rightarrow I_6$ with $I_1 + I_1$

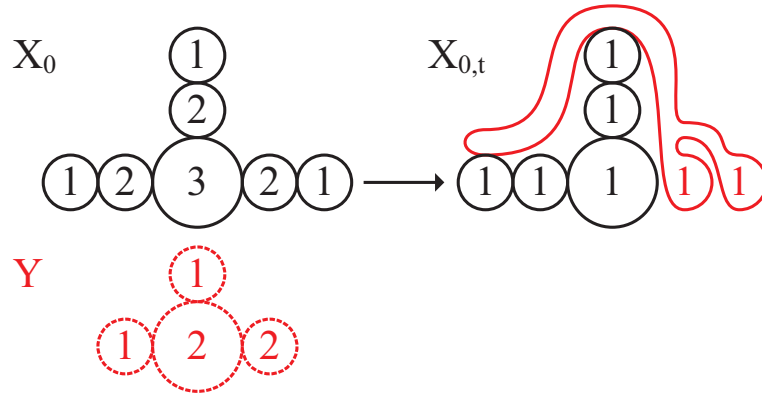

(6.4) $IV^* \rightarrow I_1^*$ with I_1

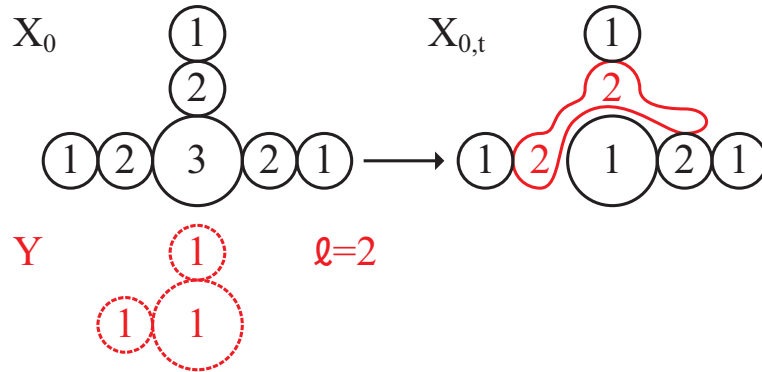

(7.1) $I_0^* \rightarrow I_4$ with $I_1 + I_1$

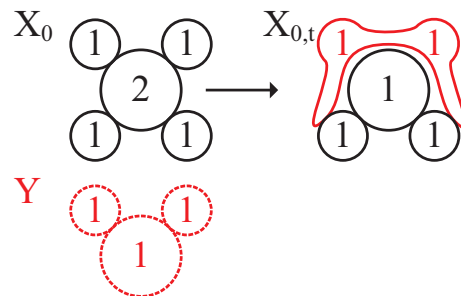

(7.2) $I_0^* \rightarrow I_3$ with $(II + I_1$ or $I_1 + I_1 + I_1)$

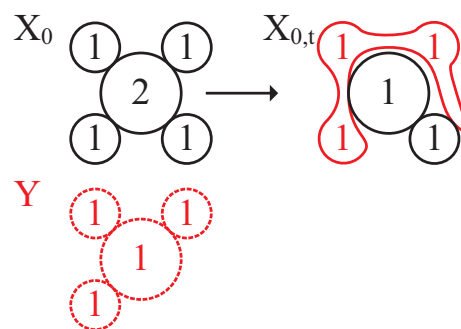

$$(8.1) \underline{I_n^* \longrightarrow I_{n-1}^* \text{ with } I_1}$$

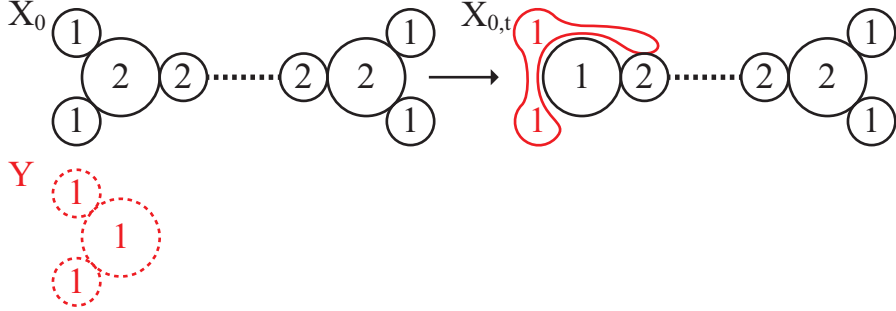

$$(8.2) \underline{I_n^* \longrightarrow I_{n+4}^* \text{ with } I_1 + I_1}$$

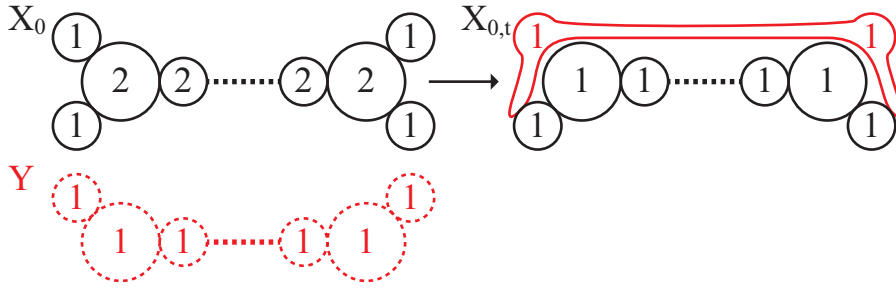

Remark 3.2. (1) The list in Theorem 3.1 does not contain singular fibers of type mI_n . In fact, mI_n splits into mI_{n-1} and I_1 by another deformation. For details see [Ta1]. (2) In Section 2, we reviewed only barking deformations associated with one simple crust for stellar singular fibers. For details of “compounding” barking like (2.6), (2.7), (4.7) and (4.8), and barking for “constellar” singular fibers like (8.1) and (8.2), see [Ta3].

4 Determination of subordinate fibers

In this section, we will determine the types of subordinate fibers appearing in barking families listed in Theorem 3.1. First we recall results on Euler characteristics of singular fibers, which gives us the sum of the Euler characteristics of the subordinate fibers. And then we will approach to determination of their types in two ways: (1) by comparing the traces of their monodromies and (2) by investigating the number of the subordinate fibers and that of their singularities.

4.1 Euler characteristics of subordinate fibers

First we recall results on Euler characteristics of singular fibers of degenerations. We denote by $e(X)$ the (*topological*) *Euler characteristic* of the underlying reduced curve of a singular fiber X .

Lemma 4.1. *Let $\pi : M \rightarrow \Delta$ be a degeneration of complex curves of genus g with the singular fiber X_0 and let $\Psi : \mathcal{M} \rightarrow \Delta \times \Delta^\dagger$ be a splitting family of $\pi : M \rightarrow \Delta$. (1) If $\Psi : \mathcal{M} \rightarrow \Delta \times \Delta^\dagger$ splits X_0 into X_1, X_2, \dots, X_N in M_t , then the following formula holds:*

$$e(X_0) - 2(1 - g) = \sum_{i=1}^N \{e(X_i) - 2(1 - g)\}. \quad (4.1)$$

(2) *Moreover, if $g = 1$ (for which $\pi : M \rightarrow \Delta$ is a degeneration of elliptic curves), then the following holds:*

$$e(X_0) = \sum_{i=1}^N e(X_i).$$

Proof. (1) The left hand side of (4.1) equals to the Euler characteristic $e(M)$ of M , while the right hand side equals to $e(M_t)$ (see p.97 of [BPV]). Since M_t is diffeomorphic to M , we have $e(M) = e(M_t)$, which confirms the assertion. (2) follows from (1) clearly. \square

Recall that for a singular fiber $X_{s,t} := \Psi^{-1}(s, t)$ ($t \neq 0$), we call $X_{s,t}$ the main fiber if $s = 0$, and a subordinate fiber if $s \neq 0$. In these terminologies we restate (2) of Lemma 4.1 as follows:

Corollary 4.2. *Let $\pi : M \rightarrow \Delta$ be a degeneration of elliptic curves with the singular fiber X_0 . Suppose a splitting family $\Psi : \mathcal{M} \rightarrow \Delta \times \Delta^\dagger$ of $\pi : M \rightarrow \Delta$ splits X_0 into the main fiber $X_{0,t}$ and subordinate fibers $X_{s_1,t}, X_{s_2,t}, \dots, X_{s_N,t}$ in M_t . Then the sum of the Euler characteristics of the subordinate fibers is*

$$\sum_{i=1}^N e(X_{s_i,t}) = e(X_0) - e(X_{0,t}).$$

Note that if X is a singular fiber of a degeneration of elliptic curves except a multiple torus, then $e(X) \geq 1$ where the equality holds exactly when X is a Lefschetz fiber of genus 1 (a projective line with a node). This fact together with Corollary 4.2 yields the following:

Lemma 4.3. *Let $\pi : M \rightarrow \Delta$ be a degeneration of elliptic curves with the singular fiber X_0 . Suppose a splitting family $\Psi : \mathcal{M} \rightarrow \Delta \times \Delta^\dagger$ of $\pi : M \rightarrow \Delta$ satisfies*

$$e(X_0) - e(X_{0,t}) = 1. \quad (4.2)$$

Then X_0 splits into the main fiber $X_{0,t}$ and a subordinate fiber $X_{s,t}$ that is a Lefschetz fiber of genus 1 (a projective line with a node).

Remark 4.4. Note that multiple tori (whose Euler characteristics are 0) do not appear as subordinate fibers. In fact, any subordinate fiber appearing in any barking family has only A -singularities. See Lemma 4.13.

Fortunately, many barking deformations in the list of Theorem 3.1 satisfy (4.2).

- (The case $e(X_0) - e(X_{0,t}) = 1$) The subordinate fiber appearing in each of the following deformations is I_1 :

$$\underline{(1.1) \ II \longrightarrow I_1 \text{ with } I_1}$$

$$\underline{(1.2) \ II \longrightarrow I_1 \text{ with } I_1}$$

$$\underline{(2.1) \ II^* \longrightarrow III^* \text{ with } I_1}$$

$$\underline{(2.5) \ II^* \longrightarrow I_3^* \text{ with } I_1}$$

$$\underline{(2.6) \ II^* \longrightarrow I_3^* \text{ with } I_1}$$

$$\underline{(2.8) \ II^* \longrightarrow III^* \text{ with } I_1}$$

$$\underline{(2.9) \ II^* \longrightarrow III^* \text{ with } I_1}$$

$$\underline{(3.1) \ III \longrightarrow I_2 \text{ with } I_1}$$

$$\underline{(3.3) \ III \longrightarrow I_2 \text{ with } I_1}$$

$$\underline{(4.1) \ III^* \longrightarrow IV^* \text{ with } I_1}$$

$$\underline{(4.3) \ III^* \longrightarrow I_2^* \text{ with } I_1}$$

$$\underline{(4.6) \ III^* \longrightarrow I_2^* \text{ with } I_1}$$

$$\underline{(4.9) \ III^* \longrightarrow IV \text{ with } I_1}$$

$$\underline{(5.1) \ IV \longrightarrow I_3 \text{ with } I_1}$$

$$\underline{(6.1) \ IV^* \longrightarrow I_1^* \text{ with } I_1}$$

$$\underline{(6.4) \ IV^* \longrightarrow I_1^* \text{ with } I_1}$$

$$\underline{(8.1) \ I_n^* \longrightarrow I_{n-1}^* \text{ with } I_1}$$

If $e(X_0) - e(X_{0,t}) \geq 2$, then we need another criterion to determine the types of subordinate fibers. But by Corollary 4.2 we can narrow down candidates.

- (The case $e(X_0) - e(X_{0,t}) = 2$) The subordinate fiber appearing in each of the following deformations is one of II , I_2 and $I_1 + I_1$:

$$\underline{(2.2) \ II^* \longrightarrow IV^* \text{ with } ?}$$

$$\underline{(2.3) \ II^* \longrightarrow I_2^* \text{ with } ?}$$

$$\underline{(2.7) \ II^* \longrightarrow I_8 \text{ with } ?}$$

$$\underline{(3.2) \ III \longrightarrow I_1 \text{ with } ?}$$

$$\underline{(4.2) \ III^* \longrightarrow I_1^* \text{ with } ?}$$

$$\underline{(4.7) \ III^* \longrightarrow I_7 \text{ with } ?}$$

$$\underline{(5.2) \ IV \longrightarrow I_2 \text{ with } ?}$$

$$\underline{(5.3) \ IV \longrightarrow I_2 \text{ with } ?}$$

$$\underline{(5.4) \ IV \longrightarrow II \text{ with } ?}$$

$$\underline{(6.2) \ IV^* \longrightarrow I_0^* \text{ with } ?}$$

$$\underline{(6.3) \ IV^* \longrightarrow I_6 \text{ with } ?}$$

$$\underline{(7.1) \ I_0^* \longrightarrow I_4 \text{ with } ?}$$

$$\underline{(8.2) \ I_n^* \longrightarrow I_{n+4} \text{ with } ?}$$

- (The case $e(X_0) - e(X_{0,t}) = 3$) The subordinate fiber appearing in each of the following deformations is one of III , I_3 , $II + I_1$, $I_2 + I_1$ and $I_1 + I_1 + I_1$:

$$\underline{(4.4) \ III^* \longrightarrow I_0^* \text{ with } ?}$$

$$\underline{(4.5) \ III^* \longrightarrow I_6 \text{ with } ?}$$

$$\underline{(4.8) \ III^* \longrightarrow I_6 \text{ with } ?}$$

$$\underline{(7.2) \ I_0^* \longrightarrow I_3 \text{ with } ?}$$

- (The case $e(X_0) - e(X_{0,t}) = 5$)

$$(2.4) \quad \underline{II^* \longrightarrow I_5 \text{ with ?}}$$

4.2 Monodromies around subordinate fibers

Next consider the monodromies around singular fibers appearing in splitting families.

Let $\pi : M \rightarrow \Delta$ be a (relatively) minimal degeneration of elliptic curves with the singular fiber X_0 . We take a base point $*$ on $\Delta \setminus \{0\}$ and a loop (simple closed curve) l in $\Delta \setminus \{0\}$ passing through $*$ and circuiting around the origin with a counterclockwise orientation. Then $\pi^{-1}(l)$ is a real 3-manifold and the restriction $\pi : \pi^{-1}(l) \rightarrow l$ is a Σ -bundle over S^1 , where $\Sigma = \pi^{-1}(*)$ is a smooth fiber, that is, an elliptic curve. Here $\pi^{-1}(l)$ is obtained from $\Sigma \times [0, 1]$ by the identification of the boundaries $\Sigma \times \{0\}$ and $\Sigma \times \{1\}$ via an orientation-preserving homeomorphism h . The isotopy class of h is called the *topological monodromy* around X_0 . Then h induces an automorphism $\rho := h_*$ on $H_1(\Sigma, \mathbb{Z})$, which is called the *monodromy* around X_0 . Under an identification of Σ and $\mathbb{R}^2/\mathbb{Z}^2$, fixing the generators of $H_1(\Sigma, \mathbb{Z})$, we may express ρ as an element of $SL(2, \mathbb{Z})$.

Next suppose that $\Psi : \mathcal{M} \rightarrow \Delta \times \Delta^\dagger$ is a splitting family of the degeneration $\pi : M \rightarrow \Delta$, say, $\pi_t : M_t \rightarrow \Delta$ ($t \neq 0$) has singular fibers X_1, X_2, \dots, X_N ($N \geq 2$). Then we express $X_0 \longrightarrow X_1 + X_2 + \dots + X_N$. Now we determine the (local) monodromy $\rho_k \in SL(2, \mathbb{Z})$ around each singular fiber X_k ($k = 1, 2, \dots, N$) as follows: Set $s_k := \pi(X_k)$. We take loops l_k in $\Delta \setminus \{s_1, s_2, \dots, s_N\}$ passing through $*$ and circuiting around s_k with a counterclockwise orientation. Then the loop l_k induces the local monodromy $\rho_k \in SL(2, \mathbb{Z})$ around X_k in $\pi_t : M_t \rightarrow \Delta$. Possibly after renumbering, we may assume that $l_1 l_2 \cdots l_N$ is homotopic to l .

The following is known:

Lemma 4.5. (1) *In $SL(2, \mathbb{Z})$, each of ρ, ρ_k is conjugate to the standard monodromy matrix of some type of singular fibers (see Table 1).*

(2)

$$\rho = \rho_1 \rho_2 \cdots \rho_N, \tag{4.3}$$

where we take such monodromy representations that the multiplication in (4.3) coincides with that in $SL(2, \mathbb{Z})$.

We prepare notation. Note that $SL(2, \mathbb{Z}) = \langle a, b \mid a^3 = b^2 = -I \rangle$ is generated by

$$a := \begin{pmatrix} 0 & 1 \\ -1 & 1 \end{pmatrix} \quad \text{and} \quad b := \begin{pmatrix} 0 & 1 \\ -1 & 0 \end{pmatrix}.$$

Setting⁴

$$s_0 := a^{-1}b = \begin{pmatrix} 1 & 1 \\ 0 & 1 \end{pmatrix} \quad \text{and} \quad s_2 := ba^{-1} = \begin{pmatrix} 1 & 0 \\ -1 & 0 \end{pmatrix},$$

⁴ The notations s_0 and s_2 stand for [FM], in which $s_1 := aba$.

then s_0 and s_2 are also generators of $SL(2, \mathbb{Z})$: indeed we have $a = s_0 s_2$ and $b = s_0 s_2 s_0 = s_2 s_0 s_2$. Since $s_2 = s_0 s_2 s_0 (s_0 s_2)^{-1}$, s_2 is conjugate to s_0 . Note that s_0 is the standard monodromy matrix of singular fibers of type I_1 .

Next we express the standard monodromy matrices of singular fibers as a product of s_0 and s_2 as follows (see [U]):

$$\begin{aligned}
I_n & : (s_0)^n \\
II & : s_0 s_2 \\
III & : s_0 s_2 s_0 = s_2 s_0 s_2 \\
IV & : s_0 s_2 s_0 s_2 \\
II^* & : (s_0 s_2)^5 \\
III^* & : (s_0 s_2)^4 s_0 \\
IV^* & : (s_0 s_2)^4 \\
I_n^* & : (s_0 s_2)^3 (s_0)^n.
\end{aligned}$$

The number of s_0 and s_2 of each product above coincides with the Euler characteristic of the corresponding type. Note that the singular fiber of any degeneration of elliptic curves but of type mI_0 ($m \geq 2$) splits into singular fibers of type I_1 (whose the Euler characteristic $e(I_1)$ is equal to 1) after repeating deformations, but not necessarily by once deformation. See [Ka] [M].

Now consider the decomposability of elements of $SL(2, \mathbb{Z})$. In what follows, we denote by the standard monodromy matrix of a singular fiber X by A_X . We write $\rho^\tau = \tau \rho \tau^{-1}$, a conjugacy of ρ .

Splittability of II

$$II \rightarrow I_1 + I_1 \qquad s_0 s_2 = A_{I_1} \cdot A_{I_1}^{s_0 s_2}$$

Splittability of III

$$\begin{aligned}
III & \rightarrow II + I_1 & s_0 s_2 s_0 & = A_{II} \cdot A_{I_1} \\
III & \rightarrow I_1 + I_1 + I_1 \\
III & \rightarrow I_2 + I_1 & s_0^2 s_0^{-1} s_2 s_0 & = A_{I_2} \cdot A_{I_1}^{s_2}
\end{aligned}$$

Splittability of IV

$$\begin{aligned}
IV & \rightarrow II + II & (s_0 s_2 s_0)^2 & = A_{II} \cdot A_{II} \\
IV & \rightarrow II + I_1 + I_1 \\
IV & \rightarrow I_1 + I_1 + I_1 + I_1 \\
IV & \rightarrow I_2 + II & s_0^2 s_2 (s_0 s_2) s_2^{-1} & = A_{I_2} \cdot A_{II}^{s_2} \\
IV & \rightarrow I_2 + I_1 + I_1 \\
IV & \rightarrow III + I_1 & s_0 s_2 s_0 s_2 & = A_{III} \cdot A_{I_1}^{s_0 s_2} \\
IV & \rightarrow I_3 + I_1 & s_0^3 s_0^{-1} s_2 s_0 & = A_{III} \cdot A_{I_1}^{s_2}
\end{aligned}$$

Proposition 4.6. *IV does not admit the following decomposition:*

$$IV \longrightarrow I_2 + I_2$$

Proof. If IV splits into $I_2 + X$, then for a monodromy matrix $A = \begin{pmatrix} a & b \\ c & d \end{pmatrix}$ of X ,

$$B := \begin{pmatrix} 1 & 2 \\ 0 & 1 \end{pmatrix} A$$

is a monodromy matrix of II^* . Accordingly B is conjugate to $\begin{pmatrix} 0 & 1 \\ -1 & -1 \end{pmatrix}$. Denoting by $\text{Tr}(A)$ (resp. $\text{Tr}(B)$) the trace of A (resp. B), we have $\text{Tr}(B) = \text{Tr}(A) + 2c$. Since $\text{Tr}(B) = -1$, we have

$$\text{Tr}(A) \equiv -1 \pmod{2}. \quad (4.4)$$

If A is conjugate to the standard monodromy matrix of I_2 , then $\text{Tr}(A)$ is equal to 2, which contradicts (4.4). Thus the assertion is confirmed. \square

- In the deformation (5.3) (see p.19), the type of the subordinate fiber is either (i) II , (ii) I_2 or (iii) $I_1 + I_1$. Now, by Proposition 4.6, we can eliminate the case (ii). Hence:

$$(5.3) \quad \underline{IV \longrightarrow I_2 \text{ with } (II \text{ or } I_1 + I_1)}$$

Splittability of II^*

$$\begin{aligned} II^* &\rightarrow IV^* + II & (s_0 s_2)^4 (s_0 s_2) &= A_{IV^*} \cdot A_{II} \\ II^* &\rightarrow I_2^* + I_1 + I_1 & (s_0 s_2)^3 (s_0)^2 (s_0^{-1} s_2 s_0) s_2 &= A_{I_2^*} \cdot A_{I_1}^{s_2} \cdot A_{I_1}^{s_0 s_2} \\ II^* &\rightarrow I_5 + I_1 + I_1 + I_1 + I_1 + I_1 & s_0^5 (s_0^{-1} s_2 s_0) s_0 s_2 s_2 s_0 &= A_{I_5} \cdot A_{I_1}^{s_2} \cdot A_{I_1} \cdot A_{I_1}^{s_0 s_2} \cdot A_{I_1}^{s_0 s_2} \cdot A_{I_1} \\ II^* &\rightarrow I_8 + I_1 + I_1 & s_0^8 (s_0^{-2} s_2 s_0^2) (s_0^{-1} s_2^{-2} s_0 s_2^2 s_0) &= A_{I_8} \cdot A_{I_1}^{s_0^{-1} s_2} \cdot A_{I_1}^{s_0^{-1} s_2^{-2}} \end{aligned}$$

Proposition 4.7. *II^* does not admit the following decompositions:*

$$\begin{aligned} II^* &\longrightarrow I_8 + II \\ II^* &\longrightarrow I_8 + I_2 \end{aligned}$$

Proof. This is showed by the same argument as that used in the proof of Proposition 4.6. \square

- In the deformation (2.7) (see p.19), the type of the subordinate fiber is either (i) II , (ii) I_2 or (iii) $I_1 + I_1$. Now, by Proposition 4.7, we can eliminate the case (i) and (ii). Hence:

$$(2.7) \quad \underline{II^* \longrightarrow I_8 \text{ with } I_1 + I_1}$$

Splittability of III^*

$$\begin{aligned}
III^* &\rightarrow I_1^* + I_2 & s_2^{-1}(s_0s_2)^3s_0s_2s_0^2 &= A_{IV^*}^{s_2^{-1}} \cdot A_{I_2} \\
III^* &\rightarrow I_0^* + I_1 + I_1 + I_1 & (s_0s_2)^3s_0s_2s_0 &= A_{I_0^*} \cdot A_{I_1} \cdot A_{I_1}^{s_0s_2} \cdot A_{I_1} \\
III^* &\rightarrow I_7 + I_1 + I_1 & s_0^7(s_0^{-5}s_2s_0^5)(s_0^{-2}s_2s_0^2) &= A_{I_7} \cdot A_{I_1}^{s_0^{-4}s_2} \cdot A_{I_1}^{s_0^{-1}s_2} \\
III^* &\rightarrow I_6 + II + I_1 & s_0^6(s_0^{-5}s_0s_2s_0^5)(s_0^{-2}s_2s_0^2) &= A_{I_6} \cdot A_{II}^{s_0^{-4}s_2} \cdot A_{I_1}^{s_0^{-1}s_2} \\
III^* &\rightarrow I_6 + I_2 + I_1 & s_0^6(s_0^{-3}s_2s_0^3)(s_2s_0^2s_2^{-1}) &= A_{I_6} \cdot A_{I_1}^{s_0^{-2}s_2} \cdot A_{I_2}^{s_2} \\
III^* &\rightarrow I_6 + I_1 + I_1 + I_1 & &
\end{aligned}$$

Proposition 4.8. III^* does not admit the following decompositions:

$$\begin{aligned}
III^* &\longrightarrow I_7 + II \\
III^* &\longrightarrow I_7 + I_2 \\
III^* &\longrightarrow I_6 + III \\
III^* &\longrightarrow I_6 + I_3
\end{aligned}$$

Proof. This is showed by the same argument as that used in the proof of Proposition 4.6. \square

- In the deformation (4.7) (see p.19), the type of the subordinate fiber is either (i) II , (ii) I_2 or (iii) $I_1 + I_1$. Now, by Proposition 4.8, we can eliminate the case (i) and (ii). Hence:

$$(4.7) \quad \underline{III^* \longrightarrow I_7 \text{ with } I_1 + I_1}$$

- In the deformation (4.8) (see p.19), the type of the subordinate fiber is either (i) III , (ii) I_3 , (iii) $II + I_1$, (iv) $I_2 + I_1$ or (v) $I_1 + I_1 + I_1$. Now, by Proposition 4.8, we can eliminate the case (i) and (ii). Hence:

$$(4.8) \quad \underline{III^* \longrightarrow I_6 \text{ with } (II + I_1, I_2 + I_1 \text{ or } I_1 + I_1 + I_1)}$$

Splittability of IV^*

$$\begin{aligned}
IV^* &\rightarrow I_0^* + I_1 + I_1 & (s_0s_2)^3s_0s_2 &= A_{I_0^*} \cdot A_{I_1} \cdot A_{I_1}^{s_0s_2} \\
IV^* &\rightarrow I_6 + I_1 + I_1 & s_0^6(s_0^{-4}s_0s_2s_0^4)(s_0^{-1}s_2s_0) &= A_{I_6} \cdot A_{II}^{s_0^{-3}s_2} \cdot A_{I_1}^{s_2}
\end{aligned}$$

Proposition 4.9. IV^* does not admit the following decompositions:

$$\begin{aligned}
IV^* &\longrightarrow I_6 + II \\
IV^* &\longrightarrow I_6 + I_2
\end{aligned}$$

Proof. This is showed by the same argument as that used in the proof of Proposition 4.6. \square

- In the deformation (6.3) (see p.19), the type of the subordinate fiber is either (i) II , (ii) I_2 or (iii) $I_1 + I_1$. Now, by Proposition 4.9, we can eliminate the case (i) and (ii). Hence:

$$(6.3) \quad \underline{IV^* \longrightarrow I_6 \text{ with } I_1 + I_1}$$

Splittability of I_0^*

$$\begin{aligned}
I_0^* &\rightarrow I_4 + I_1 + I_1 & s_0^4(s_0^{-2}s_2s_0^2)s_2 &= A_{I_4} \cdot A_{I_1}^{s_0^{-1}s_2} \cdot A_{I_1}^{s_0s_2} \\
I_0^* &\rightarrow I_3 + II + I_1 & s_0^3(s_0^{-2}s_0s_2s_0^2)s_2 &= A_{I_3} \cdot A_{II}^{s_0^{-2}s_2} \cdot A_{I_1}^{s_0s_2} \\
I_0^* &\rightarrow I_3 + I_1 + I_1 + I_1
\end{aligned}$$

Proposition 4.10. I_0^* does not admit the following decompositions:

$$\begin{aligned}
I_0^* &\longrightarrow I_4 + II \\
I_0^* &\longrightarrow I_4 + I_2 \\
I_0^* &\longrightarrow I_3 + III \\
I_0^* &\longrightarrow I_3 + I_3
\end{aligned}$$

Proof. If I_0^* splits into $X_1 + X_2$, then for monodromy matrices A_i ($i = 1, 2$) of X_i , we have $-I = A_1A_2$, that is,

$$A_1 = -A_2^{-1}.$$

In particular, $\text{Tr}(A_1) = -\text{Tr}(A_2)$. Noting that $\text{Tr}(A_i)$ is determined by the type of X_i . this confirms the assertion. \square

Proposition 4.11. I_0^* does not admit the following decomposition:

$$I_0^* \longrightarrow I_3 + I_2 + I_1$$

Proof. If I_0^* splits into $I_3 + X_1 + X_2$, then for monodromy matrices A_i ($i = 1, 2$) of X_i , we have $-I = I_3A_1A_2$. So

$$\begin{pmatrix} 1 & 3 \\ 0 & 1 \end{pmatrix} A_1 = -A_2^{-1}.$$

In particular, writing $A_1 = \begin{pmatrix} a & b \\ c & d \end{pmatrix}$, $\text{Tr}(A_1) + 3c = -\text{Tr}(A_2)$ holds. Note that the traces of the standard monodromy matrices of I_2 and I_1 do not satisfy this condition. Thus the assertion is confirmed. \square

- In the deformation (7.1) (see p.19), the type of the subordinate fiber is either (i) II , (ii) I_2 or (iii) $I_1 + I_1$. Now, by Proposition 4.10, we can eliminate the case (i) and (ii). Hence:

$$(7.1) \quad \underline{I_0^* \longrightarrow I_4 \text{ with } I_1 + I_1}$$

- In the deformation (7.2) (see p.19), the type of the subordinate fiber is either (i) III , (ii) I_3 , (iii) $II + I_1$, (iv) $I_2 + I_1$ or (v) $I_1 + I_1 + I_1$. Now, by Propositions 4.10 and 4.11, we can eliminate the case (i) (ii) and (iv). Hence:

$$(7.2) \quad \underline{I_0^* \longrightarrow I_3 \text{ with } (II + I_1 \text{ or } I_1 + I_1 + I_1)}$$

Splittability of I_n^*

$$I_n^* \rightarrow I_{n+4} + I_1 + I_1 \quad s_2 s_0^2 s_2 s_0^{-2} s_0^{n+4} = A_{I_1}^{s_0 s_2} \cdot A_{I_1}^{s_0^{-1} s_2} \cdot A_{I_{n+4}}$$

Proposition 4.12. I_n^* does not admit the following decompositions:

$$\begin{aligned} I_n^* &\longrightarrow I_{n+4} + II \\ I_n^* &\longrightarrow I_{n+4} + I_2 \end{aligned}$$

Proof. This is showed by the same argument as that used in the proof of Proposition 4.6. \square

- In the deformation (8.2) (see p.19), the type of the subordinate fiber is either (i) II , (ii) I_2 or (iii) $I_1 + I_1$. Now, by Proposition 4.12, we can eliminate the case (i) and (ii). Hence:

$$\underline{(8.2) \quad I_n^* \longrightarrow I_{n+4} \text{ with } I_1 + I_1}$$

4.3 Singularities of subordinate fibers

We next consider the numbers of the subordinate fibers appearing in a barking family and their singularities. In fact, the upper bounds of them are determined by the data of the simple crust. Moreover if it satisfies some condition, then we may determine the numbers. Note that this observation depends on barking deformations, while that in the previous subsection does not.

Let $\pi : M \rightarrow \Delta$ be a linear degeneration of complex curves with a stellar singular fiber $X_0 = m_0 \Theta_0 + \sum_{j=1}^h \text{Br}^{(j)}$. If there exist a simple crust Y of X_0 , then we may construct a splitting family of $\pi : M \rightarrow \Delta$, which is called a barking family associated with Y (see Theorem 2.6). Suppose that $Y = n_0 \Theta_0 + \sum_{j=1}^h \text{br}^{(j)}$ is a simple crust of X_0 with barking multiplicity l .

Recall that each subbranch of Y is of type A_l , B_l or C_l . A subbranch $\overline{\text{br}}^{(j)}$ is said to be *proportional* if $m_0 n_1^{(j)} = n_0 m_1^{(j)}$ (equivalently $n_0/m_0 = n_1^{(j)}/m_1^{(j)} = \dots = n_\nu^{(j)}/m_\nu^{(j)}$). Note that any proportional subbranch in simple crusts is of type A_l . Indeed, any proportional subbranch of type B_l is of type A_l , and no proportional subbranch is of type C_l . Moreover any proportional subbranch $\overline{\text{br}}^{(j)}$ has the same length as that of $\overline{\text{Br}}^{(j)}$ (that is, $\nu^{(j)} = \lambda^{(j)}$).

The following result is important in order to investigate singularities of subordinate fibers ([Ta3] Proposition 16.2.6):

Lemma 4.13. *Suppose that $\Psi : \mathcal{M} \rightarrow \Delta \times \Delta^\dagger$ is a barking family of the degeneration $\pi : M \rightarrow \Delta$ associated with a simple crust Y . Then any subordinate fiber of Ψ is a reduced curve only with A -singularities⁵. Moreover these singularities lie (a) near the core or (b) near the edge of each proportional subbranch⁶ if it exists.*

⁵ An A_μ -singularity is a singularity analytically equivalent to $y^2 = x^{\mu+1}$.

⁶ Precisely speaking, the irreducible component (which is a projective line) at the end of the branch corresponding to each proportional subbranch.

Remark 4.14. Lemma 4.13 states that any subordinate fiber in barking families is a reduced curve only with isolated singularities, which ensures that none of mI_n ($m \geq 2$), IV^* , III^* , II^* and mI_n^* ($m \geq 2$) appears as a subordinate fiber.

Singularities near proportional subbranches We will describe the singularities of subordinate fibers near a proportional subbranch. Let $\pi : M \rightarrow \Delta$ be a linear degeneration of complex curves with a stellar singular fiber X_0 and $\Psi : \mathcal{M} \rightarrow \Delta \times \Delta^\dagger$ be a barking family associated with a simple crust Y with barking multiplicity l . Suppose that Y has a proportional subbranch br of a branch Br of X_0 . First recall that near the branch Br , \mathcal{M} is given by the following data (see [Ta3] Chapter 7): for $i = 1, 2, \dots, \lambda$,

$$\begin{cases} \mathcal{H}_i : w_i^{m_i-1-l_{i-1}} \eta_i^{m_i-l_{i-1}} (w_i^{n_i-1} \eta_i^{n_i} + t^d f_i)^l - s = 0, & \text{in } U_i \times \mathbb{C} \times \Delta \times \Delta^\dagger, \\ \mathcal{H}'_i : z_i^{m_i+1-l_{i+1}} \zeta_i^{m_i-l_{i-1}} (z_i^{n_i+1} \zeta_i^{n_i} + t^d \hat{f}_i)^l - s = 0, & \text{in } V_i \times \mathbb{C} \times \Delta \times \Delta^\dagger. \end{cases} \quad (4.5)$$

Note that substituting $t = 0$ into (4.5), then we obtain (2.2).

For fixed $(s, t) \in \Delta \times \Delta^\dagger$, we consider a fiber $X_{s,t} = \Psi^{-1}(s, t)$ of Ψ . The following is required:

Lemma 4.15. *Let m, n, l be positive integers satisfying $m - ln > 0$ and m', n' be nonnegative integers satisfying $m' - ln' \geq 0$. Set $h(z, \zeta) := f(z^{p'} \zeta^p)$ for a non-vanishing holomorphic function f and positive integers p, p' ($p < p'$). Then a complex curve $C_{s,t}$ in \mathbb{C}^2 defined by*

$$C_{s,t} : z^{m'-ln'} \zeta^{m-ln} (z^{n'} \zeta^n + th)^l - s = 0$$

is singular if and only if

(1) $s = 0$ or

(2) $m' = n' = 0$ and $\left(\frac{ln-m}{ln}\right)^{l\bar{n}} s^{\bar{n}} = \left(\frac{ln-m}{m} tc\right)^{\bar{m}}$,

where $c := h(0, 0)$ and \bar{m} and \bar{n} are the relatively prime integers satisfying $\bar{n}/\bar{m} = n/m$. In the case (2), $(z, \zeta) \in C_{s,t}$ is a singularity exactly when $z = 0$ and $\zeta^n = \frac{ln-m}{m} tc$.

Lemma 4.15 ensures that the hypersurface

$$\mathcal{H}'_\lambda|_{s,t} : \zeta_\lambda^{m_\lambda-l_{n_\lambda}} (\zeta_\lambda^{n_\lambda} + t^d \hat{f}_\lambda)^l - s = 0, \quad \text{in } V_\lambda \times \mathbb{C} \times \{s\} \times \{t\},$$

has singularities, while the other hypersurfaces do not. In what follows, we write $m := m_\lambda$ and $n := n_\lambda$ for clarity.

For fixed $t \neq 0$, the equation $\left(\frac{ln-m}{ln}\right)^{l\bar{n}} s^{\bar{n}} = \left(\frac{ln-m}{m} t^d c\right)^{\bar{m}}$ for s has \bar{n} solutions, say $s_1, s_2, \dots, s_{\bar{n}}$. Noting that $(0, \zeta)$ satisfying $\zeta^n = \frac{ln-m}{m} tc$ is a singularity of $\mathcal{H}'_\lambda|_{s_k,t}$ for some s_k , each $\mathcal{H}'_\lambda|_{s_k,t}$ has n/\bar{n} ($= \text{gcd}(m, n)$) singularities respectively.

This result is summarized as follows:

Proposition 4.16. *Let $\pi : M \rightarrow \Delta$ be a linear degeneration of complex curves with a stellar singular fiber X_0 and let $\Psi : \mathcal{M} \rightarrow \Delta \times \Delta^\dagger$ be a barking family associated with a simple crust Y with barking multiplicity l . Suppose that Y has a proportional subbranch $\text{br}^{(j)}$ of a branch $\text{Br}^{(j)}$ of X_0 . Write $\overline{\text{Br}}^{(j)} := m_0\Delta_0 + m_1\Theta_1 + m_2\Theta_2 + \cdots + m_\lambda\Theta_\lambda$ and $\overline{\text{br}}^{(j)} := n_0\Delta_0 + n_1\Theta_1 + n_2\Theta_2 + \cdots + n_\lambda\Theta_\lambda$ and let \bar{m} and \bar{n} be the relatively prime integers satisfying $\bar{n}/\bar{m} = n_\lambda/m_\lambda$. Then for fixed $t \neq 0$, there exist \bar{n} subordinate fibers that have singularities near the edge of $\text{Br}^{(j)}$. Moreover, each subordinate fiber has n/\bar{n} ($= \gcd(m, n)$) singularities near the edge of $\text{Br}^{(j)}$.*

Singularities near the core Next we will describe the singularities of subordinate fibers near the core.

Let $\pi : M \rightarrow \Delta$ be a linear degeneration of complex curves with a stellar singular fiber $X_0 = m_0\Theta_0 + \sum_{j=1}^h \text{Br}^{(j)}$ and let $\Psi : \mathcal{M} \rightarrow \Delta \times \Delta^\dagger$ be a barking family of the degeneration $\pi : M \rightarrow \Delta$ associated with a simple crust $Y = n_0\Theta_0 + \sum_{j=1}^h \text{br}^{(j)}$. Write $\overline{\text{Br}}^{(j)} = m_0\Delta_0^{(j)} + m_1^{(j)}\Theta_1^{(j)} + \cdots + m_{\lambda^{(j)}}^{(j)}\Theta_{\lambda^{(j)}}^{(j)}$, $\overline{\text{br}}^{(j)} = n_0\Delta_0^{(j)} + n_1^{(j)}\Theta_1^{(j)} + \cdots + n_{\nu^{(j)}}^{(j)}\Theta_{\nu^{(j)}}^{(j)}$ and let $p^{(j)}$ be the attachment point on Θ_0 with $\text{Br}^{(j)}$. Recall that the local expression of \mathcal{M} near the core Θ_0 is given by

$$\sigma(z)\zeta^{m_0-ln_0} (\zeta^{n_0} + t^d\tau(z))^l - s = 0 \quad \text{in } N_0 \times \Delta \times \Delta^\dagger, \quad (4.6)$$

where σ is the standard section of $N_0^{\otimes(-m_0)}$ on Θ_0 and τ is a core section on Θ_0 of Y . Substituting $t = 0$ into (4.6), then we obtain (2.1) for $i = 0$. Note that σ has a zero of order $m_1^{(j)}$ at $p^{(j)}$, while τ has a pole of order $n_1^{(j)}$ at $p^{(j)}$. Suppose that τ has a zero of order a_i at q_i ($i = 1, 2, \dots, k$) on Θ_0 .

Fixing $s, t \neq 0$, consider a fiber $X_{s,t} := \Psi^{-1}(s, t)$ in $\Psi : \mathcal{M} \rightarrow \Delta \times \Delta^\dagger$. Set $F := \sigma(z)\zeta^{m_0-ln_0} (\zeta^{n_0} + t^d\tau(z))^l$. Then $(z, \zeta) \in X_{s,t}$ is a singularity precisely when $\frac{\partial}{\partial z}F(z, \zeta) = \frac{\partial}{\partial \zeta}F(z, \zeta) = 0$, equivalently

$$\begin{cases} \zeta^{m_0-ln_0} (\zeta^{n_0} + t^d\tau(z))^{l-1} (\sigma_z(z)\zeta^{n_0} + t^d(\sigma_z(z)\tau(z) + l\sigma(z)\tau_z(z))) = 0, \\ \zeta^{m_0-ln_0-1} (\zeta^{n_0} + t^d\tau(z))^{l-1} \sigma(z)(m_0\zeta^{n_0} + (m_0 - ln_0)t^d\tau_z(z)) = 0, \end{cases}$$

where $\sigma_z := \frac{d}{dz}\sigma$ and $\tau_z = \frac{d}{dz}\tau$. Setting $K(z) := n_0\sigma_z(z)\tau(z) + m_0\sigma(z)\tau_z(z)$ ⁷, then we have

$$\begin{cases} K(z) = 0, \sigma(z) \neq 0, \tau(z) \neq 0 & (4.7) \\ \zeta^{n_0} = \frac{ln_0 - m_0}{m_0} t^d \tau(z). & (4.8) \end{cases}$$

Since points (z, ζ) in $X_{s,t}$ satisfy (4.6), substituting (4.8) into (4.6), we have

$$s = \left(\frac{ln_0}{ln_0 - m_0}\right)^l \sigma(z)\zeta^{m_0}.$$

Hence:

⁷ Note that $K(z)$ is *not* a function on Θ_0 but a meromorphic section of a line bundle $N_0^{\otimes(n-m)} \otimes \Omega_{\Theta_0}^1$ on Θ_0 , where $\Omega_{\Theta_0}^1$ is the cotangent bundle of Θ_0 .

Lemma 4.17. Fix $t \neq 0$. A point $(z, \zeta) \in N_0$ is a singularity of some subordinate fiber $X_{s,t}$ if and only if the following is satisfied:

$$\begin{cases} K(z) = 0, \sigma(z) \neq 0, \tau(z) \neq 0, \\ \zeta^{n_0} = \frac{ln_0 - m_0}{m_0} t^d \tau(z). \end{cases} \quad (4.9)$$

$$\zeta^{n_0} = \frac{ln_0 - m_0}{m_0} t^d \tau(z). \quad (4.10)$$

In this case, the subordinate fiber $X_{s,t}$ satisfies

$$s = \left(\frac{ln_0}{ln_0 - m_0} \right)^l \sigma(z) \zeta^{m_0}. \quad (4.11)$$

We call a zero of $K(z)$ satisfying the condition (4.9) an *essential zero*. Combining (4.10) and (4.11), we have

$$s^{\bar{n}_0} = \left(\frac{ln_0}{ln_0 - m_0} \right)^{l\bar{n}_0} \sigma(z)^{\bar{n}_0} \left(\frac{ln_0 - m_0}{m_0} \right)^{\bar{m}_0} t^{d\bar{m}_0} \tau(z)^{\bar{m}_0}, \quad (4.12)$$

where \bar{m}_0 and \bar{n}_0 are the relatively prime integers satisfying $\bar{n}_0/\bar{m}_0 = n_0/m_0$. For an essential zero α of $K(z)$, clearly this equation for s has \bar{n}_0 solutions, say $s_1, s_2, \dots, s_{\bar{n}_0}$. On the other hand, the equation (4.10) for ζ has n_0 solutions, say $\beta_1, \beta_2, \dots, \beta_{n_0}$, which implies that $n_0/\bar{n}_0 = \gcd(m_0, n_0)$ points among $(\alpha, \beta_1), (\alpha, \beta_2), \dots, (\alpha, \beta_{n_0})$ lies on one of subordinate fibers $X_{s_1,t}, X_{s_2,t}, \dots, X_{s_{\bar{n}_0},t}$.

Lemma 4.18. Let α be an essential zero of $K(z)$. Then there exist \bar{n}_0 subordinate fibers that have a singularity with z -coordinate α . Moreover the number of such singularities of each of them is n_0/\bar{n}_0 .

Next we express $K(z) = \sigma\tau\omega$, where $\omega(z) := \frac{d \log(\sigma^{n_0} \tau^{m_0})}{dz}$. Here ω is a meromorphic section of the cotangent bundle $\Omega_{\Theta_0}^1$ on Θ_0 . For $\omega(z)$, the following holds:

- (1) $\omega(z)$ has a pole of order 1 at $p^{(j)}$ if $m_0 n_1^{(j)} - m_1^{(j)} n_0 \neq 0$, whereas $\omega(z)$ is holomorphic at $p^{(j)}$ if $m_0 n_1^{(j)} - m_1^{(j)} n_0 = 0$.
- (2) $\omega(z)$ has a pole of order 1 at q_i for $i = 1, 2, \dots, k$.

Set $J_0 := \{j \mid m_0 n_1^{(j)} - m_1^{(j)} n_0 = 0\} \subset \{1, 2, \dots, h\}$ (so $\overline{\text{br}}^{(j)}$ is a proportional subbranch for $j \in J_0$). Then

$$\begin{cases} K(z) = 0, \\ \sigma(z) \neq 0, \\ \tau(z) \neq 0 \end{cases} \iff \begin{cases} \omega(z) = 0, \\ z \neq p_j \ (j \in J_0). \end{cases}$$

Lemma 4.19. Set $v := \#J_0$ and denote by g_0 the genus of Θ_0 . Then

$$\sum_{K(\alpha)=0, \sigma(\alpha) \neq 0, \tau(\alpha) \neq 0} \text{ord}_\alpha(K(z)) = (h - v) + k + (2g_0 - 2) - \sum_{j \in J_0} \text{ord}_{p^{(j)}}(\omega).$$

We set $\chi := (h - v) + k + (2g_0 - 2) - \sum_{j \in J_0} \text{ord}_{p^{(j)}}(\omega)$, which is called the *core invariant*. From Lemma 4.19, we have:

Corollary 4.20.

$$(the\ number\ of\ essential\ zeros\ of\ K(z)) \leq \chi,$$

where the equality holds precisely when the order of any essential zero equals 1.

Where κ is the number of essential zeros of $K(z)$, let $\alpha_1, \alpha_2, \dots, \alpha_\kappa$ be the essential zeros of $K(z)$. We denote by $\bar{\kappa}$ the number of the distinct values of the set $\{\sigma(\alpha_j)^{\bar{n}_0} \tau(\alpha_j)^{\bar{m}_0} \mid j = 1, 2, \dots, \kappa\}$. Note that if α_i and α_j satisfy

$$\sigma(\alpha_i)^{\bar{n}_0} \tau(\alpha_i)^{\bar{m}_0} = \sigma(\alpha_j)^{\bar{n}_0} \tau(\alpha_j)^{\bar{m}_0},$$

then the equations (4.12) for s in the cases $z = \alpha_i$ and $z = \alpha_j$ coincide, so that they have the same \bar{n}_0 solutions. Thus, for fixed $t \neq 0$, there exist $\bar{n}_0 \bar{\kappa}$ subordinate fibers that have singularities near the core. This result together with Lemma 4.18 and Corollary 4.20 confirms the following:

Proposition 4.21. For fixed $t \neq 0$,

- (1) (the number of subordinate fibers with singularities near Θ_0) $\leq \bar{n}_0 \chi$,
where the equality holds precisely when the order of any essential zero equals 1 and $\bar{\kappa} = \kappa$.
- (2) (the number of singularities near Θ_0 on each subordinate fiber) $\leq \frac{n_0}{\bar{n}_0} \chi$,
where the equality holds precisely when the order of any essential zero equals 1 and $\bar{\kappa} = 1$.

The case that Y has no proportional subbranch Now we return to the global observation. Let $\pi : M \rightarrow \Delta$ be a linear degeneration of complex curves with a stellar singular fiber $X_0 = m_0 \Theta_0 + \sum_{j=1}^h \text{Br}^{(j)}$. Suppose that X_0 has a simple crust $Y = n_0 \Theta_0 + \sum_{j=1}^h \text{br}^{(j)}$ of with barking multiplicity l . Let $\Psi : \mathcal{M} \rightarrow \Delta \times \Delta^\dagger$ be a barking family of $\pi : M \rightarrow \Delta$ associated with Y . We define the core invariant χ of Y by

$$\chi := (h - v) + k + (2g_0 - 2) - \sum_{j \in J_0} \text{ord}_{p^{(j)}}(\omega),$$

where $J_0 := \{j \mid m_0 n_1^{(j)} - m_1^{(j)} n_0 = 0\} \subset \{1, 2, \dots, h\}$, $v := \#J_0$ (that is, the number of proportional subbranches of Y), $\omega := \frac{d}{dz} \log(\sigma^{n_0} \tau^{m_0})$ and g_0 is the genus of Θ_0 (see Lemma 4.19).

First we consider the case that Y has no proportional subbranch. Then Lemma 4.13 ensures that singularities of subordinate fibers lies only near the core. Note that $\chi = h + k + (2g_0 - 2)$.

Lemma 4.22. Suppose that Y has no proportional subbranch. Set $c := \text{gcd}(m_0, n_0)$ and $\bar{n}_0 := n_0/c$. If $\chi = 1$, then for fixed $t \neq 0$, the following holds:

- (1) $\pi_t : M_t \rightarrow \Delta$ contains \bar{n}_0 subordinate fibers.
- (2) Each subordinate fiber in $\pi_t : M_t \rightarrow \Delta$ has c singularities.
- (3) The number of singularities of all the subordinate fibers in $\pi_t : M_t \rightarrow \Delta$ is n_0 .

Proof. From Corollary 4.20, (the number of essential zeros of $K(z)$) $\leq \chi$. Since $K(z)$ has at least a zero, by assumption, we have

$$\text{(the number of essential zeros of } K(z)) = 1,$$

which implies that $K(z)$ has just one zero of order 1. Then from Proposition 4.21, we have

$$\begin{aligned} \text{(the number of subordinate fibers in } \pi_t : M_t \rightarrow \Delta) &= \bar{n}_0, \\ \text{(the number of singularities on each subordinate fiber in } \pi_t : M_t \rightarrow \Delta) &= c, \end{aligned}$$

confirming (1) and (2). Clearly (3) follows from (1) and (2). \square

In particular:

Proposition 4.23. *Suppose that (a) Θ_0 is a projective line, (b) X_0 has three branches, (c) the core section τ has no zero and (d) Y has no proportional sub-branch. Set $c := \gcd(m_0, n_0)$ and $\bar{n}_0 := n_0/c$. Then for fixed $t \neq 0$, the following holds:*

- (1) $\pi_t : M_t \rightarrow \Delta$ contains \bar{n}_0 subordinate fibers.
- (2) Each subordinate fiber in $\pi_t : M_t \rightarrow \Delta$ has c singularities.
- (3) The number of singularities of all the subordinate fibers in $\pi_t : M_t \rightarrow \Delta$ is n_0 .

Proof. By assumption, we have $g_0 = 0$, $h = 3$, $k = 0$, and so $\chi = 1$. It is immediate from Lemma 4.22. \square

Remark 4.24. By Lemma 2.5, the condition (c) is restated as “ $r_0 = r'_0$ holds,” where $r_0 := \sum_{j=1}^h m_1^{(j)}/m_0$ and $r'_0 := \sum_{j=1}^h n_1^{(j)}/n_0$.

- In the deformations (3.2) and (4.2) (see p.19), the type of the subordinate fiber is either (i) II , (ii) I_2 or (iii) $I_1 + I_1$. Now, applying Proposition 4.23, it is easy to see that there appears just one subordinate fiber which has two singularities. Hence:

$$\begin{aligned} \underline{(3.2) \quad III \longrightarrow I_1 \text{ with } I_2} \\ \underline{(4.2) \quad III^* \longrightarrow I_1^* \text{ with } I_2} \end{aligned}$$

- In the deformations (5.2) and (6.2) (see p.19), the type of the subordinate fiber is either (i) II , (ii) I_2 or (iii) $I_1 + I_1$. Now, applying Proposition 4.23, it is easy to see that there appear two subordinate fibers each of which has one singularity. Hence:

$$\begin{aligned} \underline{(5.2) \quad IV} &\longrightarrow I_2 \text{ with } I_1 + I_1 \\ \underline{(6.2) \quad IV^*} &\longrightarrow I_0^* \text{ with } I_1 + I_1 \end{aligned}$$

- In the deformations (4.4) and (4.5) (see p.19), the type of the subordinate fiber is either (i) III , (ii) I_3 , (iii) $II + I_1$, (iv) $I_2 + I_1$ or (v) $I_1 + I_1 + I_1$. Now, applying Proposition 4.23, it is easy to see that there appear three subordinate fibers each of which has one singularity. Hence:

$$\begin{aligned} \underline{(4.4) \quad III^*} &\longrightarrow I_0^* \text{ with } I_1 + I_1 + I_1 \\ \underline{(4.5) \quad III^*} &\longrightarrow I_6 \text{ with } I_1 + I_1 + I_1 \end{aligned}$$

- In the deformation (2.4) (see p.20), applying Proposition 4.23, it is easy to see that there appear five subordinate fibers each of which has one singularity. Hence:

$$\underline{(2.4) \quad II^*} \longrightarrow I_5 \text{ with } I_1 + I_1 + I_1 + I_1 + I_1$$

The case that Y has a proportional subbranch Next we assume that Y has a proportional subbranch.

Proposition 4.25. *Suppose that (a) Θ_0 is a projective line, (b) X_0 has three branches, (c) the core section τ has no zero and (d) Y has a proportional subbranch $\overline{\text{br}}^{(1)} = n_0\Delta_0 + n_1\Theta_1 + n_2\Theta_2 + \cdots + n_\lambda\Theta_\lambda$ of $\overline{\text{Br}}^{(1)}$. Then $\overline{\text{br}}^{(1)}$ is the unique proportional subbranch of Y . Moreover for fixed $t \neq 0$, the following holds:*

- (1) $\pi_t : M_t \rightarrow \Delta$ contains \bar{n}_λ subordinate fibers.
- (2) Each subordinate fiber in $\pi_t : M_t \rightarrow \Delta$ has c singularities.
- (3) The number of singularities of all the subordinate fibers in $\pi_t : M_t \rightarrow \Delta$ is n_λ .

Here $c := \gcd(m_\lambda, n_\lambda)$ and $\bar{n}_\lambda := n_\lambda/c$.

Proof. By assumption, we have $g_0 = 0$, $h = 3$, $k = 0$. Thus

$$\begin{aligned} \chi &= 1 - v - \sum_{j \in J_0} \text{ord}_{p^{(j)}}(\omega) \\ &= 1 - \sum_{j \in J_0} (\text{ord}_{p^{(j)}}(\omega) + 1). \end{aligned}$$

Recall that $\omega(z)$ is holomorphic at $p^{(j)}$ for $j \in J_0$ (that is, $m_0 n_1^{(j)} - m_1^{(j)} n_0 = 0$), which means that $\text{ord}_{p^{(j)}}(\omega) \geq 0$. Since $\chi \geq 0$, we deduce $\text{ord}_{p^{(j)}}(\omega) = 0$ and

$v = 1$. Hence $\overline{\text{br}}^{(1)}$ is the unique proportional subbranch. Noting that $\chi = 0$, from Proposition 4.21, any subordinate fiber in $\pi_t : M_t \rightarrow \Delta$ has no singularity near the core Θ_0 but near the edge of $\overline{\text{Br}}^{(1)}$. Therefore Proposition 4.16 confirms the assertion. \square

- In the deformation (2.2) (see p.19), the type of the subordinate fiber is either (i) II , (ii) I_2 or (iii) $I_1 + I_1$. Now, applying Proposition 4.25, it is easy to see that there appears just one subordinate fiber which has one singularity. Hence:

$$(2.2) \underline{II^* \longrightarrow IV^* \text{ with } II}$$

- In the deformation (2.3) (see p.19), the type of the subordinate fiber is either (i) II , (ii) I_2 or (iii) $I_1 + I_1$. Now, applying Proposition 4.25, it is easy to see that there appears two subordinate fibers each of which has one singularity. Hence:

$$(2.3) \underline{II^* \longrightarrow I_2^* \text{ with } I_1 + I_1}$$

References

- [BPV] W. Barth, C. Peter, and Van de Ven, Compact Complex Surfaces, Ergebnisse der Mathematik und ihrer Grenzgebiete (3. Folge), 4, Springer, 1984.
- [FM] R. Friedman and J. Morgan, Smooth Four-Manifolds and Complex Surfaces, Ergebnisse der Mathematik und ihrer Grenzgebiete (3. Folge), 27, Springer, 1994.
- [Ka] A. Kas, On the deformation types of regular elliptic surfaces, Complex Analysis and Algebraic Geometry, Iwanami shoten publ. and Cambridge Univ. Press, (1977), 107–112.
- [Ko] K. Kodaira, On compact complex analytic surfaces II, Ann. of Math. 77, (1963), 563–626.
- [M] B. Moishezon, Complex Surfaces and Connected Sums of Complex Projective Planes, Lecture Notes in Math. 603, Springer, 1977.
- [Ta1] S. Takamura, Towards the classification of atoms of degenerations, I, (Splitting criteria via configurations of singular fibers), Journal of the Mathematical Society of Japan, 56 (1), (2004), 115–145.
- [Ta2] S. Takamura, Towards the classification of atoms of degenerations, II - linearization of degenerations of complex curves, RIMS Preprint, 1344, (2001).

- [Ta3] S. Takamura, Towards the Classification of Atoms of Degenerations, III - Splitting Deformations of Degenerations of Complex Curves, Lecture Notes in Math. 1886, Springer, 2006.
- [U] M. Ue, On the Topology of Elliptic Surfaces, a Surgery, Amer. Math. Soc. Trans. (2) 160, (1994), 95–123.

GRADUATE SCHOOL OF MATHEMATICS, KYUSHU UNIVERSITY, MOTOOKA
744, NISHI-KU, FUKUOKA 819-0395, JAPAN
E-mail address: t-okuda@math.kyushu-u.ac.jp