

Singular Fibers in Barking Families of Degenerations of Elliptic Curves

Takayuki OKUDA

Abstract

Takamura [Ta3] established a theory of splitting families of degenerations of complex curves of genus $g \geq 1$. He introduced a powerful method for constructing a splitting family, called a *barking family*, in which the resulting family of complex curves has a singular fiber over the origin (the *main fiber*) together with other singular fibers (*subordinate fibers*). He made a list of barking families for genera up to 5 and determined the main fibers appearing in them. This paper determines *most* of the subordinate fibers of the barking families in Takamura's list for the case $g = 1$. (There remain four undetermined cases.) Also, we show that some splittings never occur in a splitting family.

1 Introduction

Let $\pi : M \rightarrow \Delta$ be a proper surjective holomorphic map from a smooth complex surface M to an open disk $\Delta := \{s \in \mathbb{C} : |s| < \delta\}$ in \mathbb{C} with radius $\delta > 0$. We call $\pi : M \rightarrow \Delta$ a *family of complex curves* of genus $g \geq 1$ over Δ if π has at most finitely many singular fibers and the other fibers are smooth complex curves of genus g . In particular, $\pi : M \rightarrow \Delta$ is called a *degeneration* of complex curves of genus g if the fiber $X_0 := \pi^{-1}(0)$ over the origin is singular and the other fibers $X_s := \pi^{-1}(s)$ ($s \neq 0$) are all smooth.

In this paper, we consider the following problem: *How does a singular fiber split in a deformation?* Let us recall the concept of a splitting family of degenerations. Let \mathcal{M} be a smooth complex 3-manifold and set $\Delta^\dagger := \{t \in \mathbb{C} : |t| < \varepsilon\}$, an open disk with sufficiently small radius $\varepsilon > 0$. Consider a proper flat surjective holomorphic map $\Psi : \mathcal{M} \rightarrow \Delta \times \Delta^\dagger$. For $t \in \Delta^\dagger$, set $\Delta_t := \Delta \times \{t\}$, $M_t := \Psi^{-1}(\Delta_t)$ and $\pi_t := \Psi|_{M_t} : M_t \rightarrow \Delta_t$. Suppose that $\pi_0 : M_0 \rightarrow \Delta_0$ coincides with a given degeneration $\pi : M \rightarrow \Delta$. Then we call $\Psi : \mathcal{M} \rightarrow \Delta \times \Delta^\dagger$ a *deformation family* of the degeneration $\pi : M \rightarrow \Delta$ and each $\pi_t : M_t \rightarrow \Delta_t$ ($t \in \Delta^\dagger \setminus \{0\}$) a *deformation* of the degeneration $\pi : M \rightarrow \Delta$. In particular, $\Psi : \mathcal{M} \rightarrow \Delta \times \Delta^\dagger$ is

MSC Classification. Primary 14D06; Secondary 14H15, 14D05, 32S50.

Key words and phrases. Degeneration of complex curves, Splitting family, Elliptic curve, Singular fiber, Monodromy.

called a *splitting family* if every deformation $\pi_t : M_t \rightarrow \Delta_t$ of the degeneration $\pi : M \rightarrow \Delta$ is a family of complex curves with at least two singular fibers. Set $X_{s,t} := \Psi^{-1}(s, t) (= \pi_t^{-1}(s))$. Clearly $X_{0,0}$ is the original singular fiber X_0 of the degeneration $\pi : M \rightarrow \Delta$. For a fixed $t \in \Delta^\dagger \setminus \{0\}$, let s_1, s_2, \dots, s_N ($N \geq 2$) be the singular values of π_t , that is, $X_{s_1,t}, X_{s_2,t}, \dots, X_{s_N,t}$ are the singular fibers of $\pi_t : M_t \rightarrow \Delta_t$. (note: The singular values s_1, s_2, \dots, s_N depend on t , but the number of them and the types of the singular fibers do not.) In this case, we say that the singular fiber X_0 *splits* into the singular fibers $X_{s_1,t}, X_{s_2,t}, \dots, X_{s_N,t}$.

To classify *atomic degenerations* — degenerations admitting no splitting family — Takamura [Ta3] introduced a powerful method for constructing splitting families. Splitting families obtained by this construction are called *barking families*. In a barking family, the original singular fiber X_0 of the degeneration $\pi : M \rightarrow \Delta$ is deformed to a simpler singular fiber of its deformation $\pi_t : M_t \rightarrow \Delta_t$ in such a way that a part of X_0 looks “barked” off from X_0 . See Figure 2 in Section 2. The resulting singular fiber appears over the origin of Δ_t under Takamura’s construction, so we denote it by $X_{0,t}$. In such a situation, we write¹

$$X_0 \xrightarrow{\text{bark}} X_{0,t},$$

and call $X_{0,t}$ the *main fiber*.

In [Ta3], for genera up to 5, Takamura made a list of barking families which enabled him to show that a degeneration is *absolutely atomic* — that is, any degeneration topologically equivalent to it is atomic — if and only if its singular fiber is either a Lefschetz fiber or a multiple of a smooth complex curve. For instance, he listed thirty five barking families for degenerations of complex curves of genus $g = 1$, that is, for degenerations of elliptic curves, and determined the type of the main fiber of each of them as follows, where we use Kodaira’s notation² for singular fibers (see also the list in Section 12):

Takamura’s list

(1.1)

$$\begin{array}{ll}
[II.1] & II \xrightarrow{\text{bark}} I_1 \\
[II.2] & II \xrightarrow{\text{bark}} I_1 \\
[II^*.1] & II^* \xrightarrow{\text{bark}} III^* \\
[II^*.2] & II^* \xrightarrow{\text{bark}} IV^* \\
[II^*.3] & II^* \xrightarrow{\text{bark}} I_2^* \\
[II^*.4] & II^* \xrightarrow{\text{bark}} I_5 \\
[II^*.5] & II^* \xrightarrow{\text{bark}} I_3^* \\
[II^*.6] & II^* \xrightarrow{\text{bark}} I_3^* \\
[III^*.5] & III^* \xrightarrow{\text{bark}} I_6 \\
[III^*.6] & III^* \xrightarrow{\text{bark}} I_2^* \\
[III^*.7] & III^* \xrightarrow{\text{bark}} I_7 \\
[III^*.8] & III^* \xrightarrow{\text{bark}} I_6 \\
[III^*.9] & III^* \xrightarrow{\text{bark}} IV^* \\
[IV.1] & IV \xrightarrow{\text{bark}} I_3 \\
[IV.2] & IV \xrightarrow{\text{bark}} I_2 \\
[IV.3] & IV \xrightarrow{\text{bark}} I_2
\end{array}$$

¹ In the same situation, Takamura [Ta3] wrote $X_0 \rightarrow X_{0,t}$. In this paper, we use “ $\xrightarrow{\text{bark}}$ ” only for splittings and distinguish “ $\xrightarrow{\text{bark}}$ ” from it.

² See Table 1 in Section 2.

$$\begin{array}{ll}
[\mathbf{II}^*.7] & II^* \xrightarrow{\text{bark}} I_8 \\
[\mathbf{II}^*.8] & II^* \xrightarrow{\text{bark}} III^* \\
[\mathbf{II}^*.9] & II^* \xrightarrow{\text{bark}} III^* \\
[\mathbf{III}.1] & III \xrightarrow{\text{bark}} I_2 \\
[\mathbf{III}.2] & III \xrightarrow{\text{bark}} I_1 \\
[\mathbf{III}.3] & III \xrightarrow{\text{bark}} I_2 \\
[\mathbf{III}^*.1] & III^* \xrightarrow{\text{bark}} IV^* \\
[\mathbf{III}^*.2] & III^* \xrightarrow{\text{bark}} I_1^* \\
[\mathbf{III}^*.3] & III^* \xrightarrow{\text{bark}} I_2^* \\
[\mathbf{III}^*.4] & III^* \xrightarrow{\text{bark}} I_0^* \\
[\mathbf{IV}.4] & IV \xrightarrow{\text{bark}} II \\
[\mathbf{IV}^*.1] & IV^* \xrightarrow{\text{bark}} I_1^* \\
[\mathbf{IV}^*.2] & IV^* \xrightarrow{\text{bark}} I_0^* \\
[\mathbf{IV}^*.3] & IV^* \xrightarrow{\text{bark}} I_6 \\
[\mathbf{IV}^*.4] & IV^* \xrightarrow{\text{bark}} I_1^* \\
[\mathbf{I}_0^*.1] & I_0^* \xrightarrow{\text{bark}} I_4 \\
[\mathbf{I}_0^*.2] & I_0^* \xrightarrow{\text{bark}} I_3 \\
[\mathbf{I}_n^*.1] & I_n^* \xrightarrow{\text{bark}} I_{n-1}^* \\
[\mathbf{I}_n^*.2] & I_n^* \xrightarrow{\text{bark}} I_{n+4}^*.
\end{array}$$

In a barking family, there appear not only the main fiber but also other singular fibers, which are called *subordinate fibers*. In what follows, when the original singular fiber X_0 splits into the main fiber $X_{0,t}$ and subordinate fibers $X_{s_1,t}, X_{s_2,t}, \dots, X_{s_N,t}$ ($s_i \neq 0$), we write

$$X_0 \longrightarrow X_{0,t} + X_{s_1,t} + X_{s_2,t} + \dots + X_{s_N,t}$$

— we always put the main fiber $X_{0,t}$ on the initial term to distinguish it from the subordinate fibers. The main fiber of a barking family is explicitly described. On the other hand, it is not clear what subordinate fibers will appear. The aim of this paper is to determine the subordinate fibers of Takamura's barking families for degenerations of elliptic curves.

Our results are summarized in two theorems. Firstly, the following theorem determines the subordinate fibers of most of the barking families in the above list (note: four cases remain undetermined, see Remark 1.1 below):

Main Theorem A (Theorem 10.10). *Each barking family in Takamura's list (1.1) except $[\mathbf{III}^*.8]$, $[\mathbf{IV}.3]$, $[\mathbf{IV}.4]$, $[\mathbf{I}_0^*.2]$ splits the singular fiber as follows:*

$$\begin{array}{ll}
[\mathbf{II}.1] & II \longrightarrow I_1 + I_1 \\
[\mathbf{II}.2] & II \longrightarrow I_1 + I_1 \\
[\mathbf{II}^*.1] & II^* \longrightarrow III^* + I_1 \\
[\mathbf{II}^*.2] & II^* \longrightarrow IV^* + II \\
[\mathbf{II}^*.3] & II^* \longrightarrow I_2^* + I_1 + I_1 \\
[\mathbf{II}^*.4] & II^* \longrightarrow I_5 \\
& \quad + I_1 + I_1 + I_1 + I_1 + I_1 \\
[\mathbf{II}^*.5] & II^* \longrightarrow I_3^* + I_1 \\
[\mathbf{II}^*.6] & II^* \longrightarrow I_3^* + I_1 \\
[\mathbf{III}^*.2] & III^* \longrightarrow I_1^* + I_2 \\
[\mathbf{III}^*.3] & III^* \longrightarrow I_2^* + I_1 \\
[\mathbf{III}^*.4] & III^* \longrightarrow I_0^* + I_1 + I_1 + I_1 \\
[\mathbf{III}^*.5] & III^* \longrightarrow I_6 + I_1 + I_1 + I_1 \\
[\mathbf{III}^*.6] & III^* \longrightarrow I_2^* + I_1 \\
[\mathbf{III}^*.7] & III^* \longrightarrow I_7 + I_1 + I_1 \\
[\mathbf{III}^*.9] & III^* \longrightarrow IV^* + I_1 \\
[\mathbf{IV}.1] & IV \longrightarrow I_3 + I_1 \\
[\mathbf{IV}.2] & IV \longrightarrow I_2 + I_1 + I_1
\end{array}$$

$$\begin{array}{ll}
[\mathbf{II}^*.7] \ II^* \longrightarrow I_8 + I_1 + I_1 & [\mathbf{IV}^*.1] \ IV^* \longrightarrow I_1^* + I_1 \\
[\mathbf{II}^*.8] \ II^* \longrightarrow III^* + I_1 & [\mathbf{IV}^*.2] \ IV^* \longrightarrow I_0^* + I_1 + I_1 \\
[\mathbf{II}^*.9] \ II^* \longrightarrow III^* + I_1 & [\mathbf{IV}^*.3] \ IV^* \longrightarrow I_6 + I_1 + I_1 \\
[\mathbf{III}.1] \ III \longrightarrow I_2 + I_1 & [\mathbf{IV}^*.4] \ IV^* \longrightarrow I_1^* + I_1 \\
[\mathbf{III}.2] \ III \longrightarrow I_1 + I_2 & [\mathbf{I}_0^*.1] \ I_0^* \longrightarrow I_4 + I_1 + I_1 \\
[\mathbf{III}.3] \ III \longrightarrow I_2 + I_1 & [\mathbf{I}_n^*.1] \ I_n^* \longrightarrow I_{n-1}^* + I_1 \\
[\mathbf{III}^*.1] \ III^* \longrightarrow IV^* + I_1 & [\mathbf{I}_n^*.2] \ I_n^* \longrightarrow I_{n+4} + I_1 + I_1.
\end{array}$$

Remark 1.1. We have not been able to determine the subordinate fibers of the four exceptional barking families $[\mathbf{III}^*.8]$, $[\mathbf{IV}.3]$, $[\mathbf{IV}.4]$, $[\mathbf{I}_0^*.2]$ (see also Remark 6.6):

$$\begin{array}{l}
[\mathbf{III}^*.8] \ III^* \longrightarrow I_6 + II + I_1, \ I_6 + I_2 + I_1, \ \text{or} \ I_6 + I_1 + I_1 + I_1 \\
[\mathbf{IV}.3] \ IV \longrightarrow I_2 + II, \ \text{or} \ I_2 + I_1 + I_1 \\
[\mathbf{IV}.4] \ IV \longrightarrow II + II, \ II + I_2, \ \text{or} \ II + I_1 + I_1 \\
[\mathbf{I}_0^*.2] \ I_0^* \longrightarrow I_3 + II + I_1, \ \text{or} \ I_3 + I_1 + I_1 + I_1.
\end{array}$$

In contrast, there are splittings that never occur in a splitting family. If in a splitting family for a degeneration of elliptic curves the singular fiber X_0 splits into N singular fibers X_1, X_2, \dots, X_N , then we have $e(X_0) = e(X_1) + e(X_2) + \dots + e(X_N)$, where $e(X_i)$ denotes the topological Euler characteristic of the underlying reduced curve of X_i (Lemma 3.1 (b)). However the converse does not hold. Even if the singular fibers satisfy this equation, the splitting $X_0 \longrightarrow X_1 + X_2 + \dots + X_N$ does not always occur. In fact:

Main Theorem B (Theorem 5.8). *None of the following splittings occurs:*

$$\begin{array}{l}
IV \longrightarrow I_2 + I_2, \\
II^* \longrightarrow I_8 + II, \quad I_7 + III, \quad I_6 + IV, \\
\quad I_4 + I_0^*, \quad I_3 + I_1^*, \\
\quad I_u + I_v \ (u + v = 10), \\
III^* \longrightarrow I_7 + II, \quad I_6 + III, \quad I_5 + IV, \\
\quad I_3 + I_0^*, \quad I_u + I_v \ (u + v = 9), \\
IV^* \longrightarrow I_6 + II, \quad I_5 + III, \quad I_4 + IV, \\
\quad I_2 + I_0^*, \quad I_u + I_v \ (u + v = 8), \\
I_n^* \ (n \geq 0) \longrightarrow I_{n+4} + II, \quad I_{n+3} + III, \quad I_{n+2} + IV, \\
\quad I_u + I_v \ (u + v = n + 6 \ \text{and} \ (n, u, v) \neq (2, 4, 4)). \\
I_0^* \longrightarrow I_3 + I_2 + I_1.
\end{array}$$

Organization of this paper

This paper is organized as follows. In Section 2, we first review Takamura's theory of barking families, mainly for degenerations with *stellar* (star-shaped) singular

fibers. In fact, most of the degenerations of elliptic curves may be assumed to have stellar singular fibers.

To determine the subordinate fibers of the barking families in Takamura's list (1.1), we investigate the singular fibers in three steps: (1) In Section 3, we first consider the Euler characteristics of the singular fibers and give a list of the sets of subordinate fibers that can appear in each of the barking families. (2) In Section 4, we recall the concept of monodromies around singular fibers, and in Section 5, by comparing the traces of monodromies, we prove Main Theorem B — we give a list of splittings that never occur. In Section 6, based on the result of Section 5, we determine the subordinate fibers of five of Takamura's barking families. (3) Sections 7, 8, 9 are devoted to study of the singularities of subordinate fibers. We investigate the singularities near proportional subbranches in Section 7 and those near the core in Section 8. In Section 9, we show useful lemmas which give us the number of the subordinate fibers and that of their singularities. In Section 10, we determine the subordinate fibers of the remaining barking families, and complete the proof of Main Theorem A.

In Section 11, we give monodromy decompositions corresponding to the splittings induced from Takamura's barking families.

In Section 12, we provide Takamura's list of barking families for genus 1 with figures of the singular fibers, which will help the reader comprehend the barking deformations.

Acknowledgements

The author would like to express his deep gratitude to Shigeru Takamura for fruitful discussions. The author would also like to thank Masaaki Ue and Osamu Saeki for helpful comments and suggestions. The author also thanks the anonymous referee for giving very useful comments and warm encouragement on an earlier version of the paper.

2 Takamura's theory

Let us review Takamura's theory of barking families. For details see [Ta3].

First we recall the concept of linear degenerations. We begin with preparation. Let $\pi : M \rightarrow \Delta$ be a degeneration of complex curves of genus $g \geq 1$ and express its singular fiber as $X_0 = \sum_i m_i \Theta_i$, where Θ_i is an irreducible component of X_0 with multiplicity m_i . In what follows, we assume that the *underlying reduced curve* $X_0^{\text{red}} := \sum_i \Theta_i$ of X_0 has at most *simple normal crossings*, that is, (i) any singularity of X_0^{red} is a node and (ii) any irreducible component Θ_i is not self-intersecting (so Θ_i is smooth).

For an irreducible component Θ_i of X_0 , we denote by N_i the normal bundle of Θ_i in M . Let $\{p_i^{(1)}, p_i^{(2)}, \dots, p_i^{(h)}\}$ be the set of the intersection points on Θ_i with other irreducible components of X_0 and $m^{(j)}$ ($j = 1, 2, \dots, h$) be the multiplicity of

the irreducible component intersecting Θ_i at $p_i^{(j)}$. Then there exists a holomorphic section σ_i of the line bundle $N_i^{\otimes(-m_i)}$ on Θ_i such that

$$\operatorname{div}(\sigma_i) = \sum_{j=1}^h m^{(j)} p_i^{(j)},$$

where $\operatorname{div}(\sigma_i)$ denotes the divisor defined by σ_i . Here σ_i has a zero of order $m^{(j)}$ at $p_i^{(j)}$. Note that σ_i is uniquely determined up to multiplication by a constant. We call σ_i the *standard section* of $N_i^{\otimes(-m_i)}$ on Θ_i .

Take an open covering $\Theta_i = \bigcup_{\alpha} U_{\alpha}$ such that $U_{\alpha} \times \mathbb{C}$ is a local trivialization of the normal bundle N_i on Θ_i . We denote by $(z_{\alpha}, \zeta_{\alpha})$ coordinates of $U_{\alpha} \times \mathbb{C}$. Now define holomorphic functions $\pi_{i,\alpha} : U_{\alpha} \times \mathbb{C} \rightarrow \mathbb{C}$ by

$$\pi_{i,\alpha}(z_{\alpha}, \zeta_{\alpha}) := \sigma_{i,\alpha}(z_{\alpha}) \zeta_{\alpha}^{m_i},$$

where $\sigma_{i,\alpha}$ is the local expression of σ_i on U_{α} . Then the set $\{\pi_{i,\alpha}\}_{\alpha}$ of holomorphic functions defines a global holomorphic function $\pi_i : N_i \rightarrow \mathbb{C}$.

Definition 2.1. A degeneration $\pi : M \rightarrow \Delta$ is said to be *linear* if for any irreducible component Θ_i of its singular fiber X_0 ,

- (i) a tubular neighborhood $N(\Theta_i)$ of Θ_i in M is biholomorphic to a tubular neighborhood of a zero-section of the normal bundle N_i , and
- (ii) under the identification by the biholomorphic map of (i), the following conditions are satisfied:

- The restriction $\pi|_{N(\Theta_i)}$ coincides with the holomorphic function π_i defined above.
- If Θ_i intersects Θ_j at a point p , then there exist local trivializations $U_{\alpha} \times \mathbb{C}$ of N_i and $U_{\beta} \times \mathbb{C}$ of N_j around p such that neighborhoods of p in $N(\Theta_i)$ and $N(\Theta_j)$ are identified by *plumbing* $(z_{\alpha}, \zeta_{\alpha}) = (\zeta_{\beta}, z_{\beta})$ and π is locally expressed as

$$\pi|_{N(\Theta_i)}(z_{\alpha}, \zeta_{\alpha}) = z_{\alpha}^{m_j} \zeta_{\alpha}^{m_i}, \quad \pi|_{N(\Theta_j)}(z_{\beta}, \zeta_{\beta}) = z_{\beta}^{m_i} \zeta_{\beta}^{m_j},$$

where $(z_{\alpha}, \zeta_{\alpha}) \in U_{\alpha} \times \mathbb{C}$ and $(z_{\beta}, \zeta_{\beta}) \in U_{\beta} \times \mathbb{C}$.

Remark 2.2. Any degeneration of complex curves (even if the underlying reduced curve of its singular fiber does *not* have at most simple normal crossings), after successive blowing up and down, becomes a degeneration topologically equivalent to some linear degeneration.

If $\pi : M \rightarrow \Delta$ is linear, then we may express M locally as a hypersurface in some space as follows: We first identify M with the graph of π in $M \times \Delta$

$$\operatorname{Graph}(\pi) = \{(x, s) \in M \times \Delta : \pi(x) - s = 0\}$$

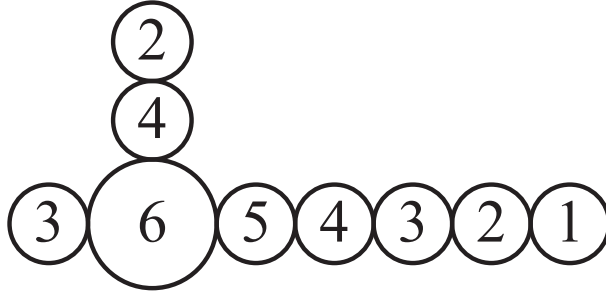

Figure 1: A singular fiber of type II^* of a degeneration of elliptic curves is stellar. Each circle denotes a complex projective line, the number stands for its multiplicity, and each intersection point is a node.

via the natural projection $\text{Graph}(\pi) \ni (x, s) \mapsto x \in M$. Recall that for any irreducible component Θ_i of the singular fiber X_0 , the map π is expressed around Θ_i as

$$\pi(z_i, \zeta_i) = \sigma_i(z_i)\zeta_i^{m_i},$$

where σ_i is the standard section of $N_i^{\otimes(-m_i)}$ on Θ_i . Then we obtain the local expression of M around Θ_i :

$$\sigma_i(z_i)\zeta_i^{m_i} - s = 0 \quad \text{in } N_i \times \Delta.$$

Note that these hypersurfaces are glued around the intersection points by plumbings $(z_j, \zeta_j, s) = (\zeta_i, z_i, s)$ where $(z_i, \zeta_i, s) \in N_i \times \Delta$ and $(z_j, \zeta_j, s) \in N_j \times \Delta$.

For a linear degeneration $\pi : M \rightarrow \Delta$, its singular fiber X_0 consists of three kinds of parts: *cores*, *branches* and *trunks*. An irreducible component Θ_i of X_0 is called a *core* if Θ_i intersects other irreducible components at at least three points or the genus of Θ_i is positive. A *branch* is a chain $\sum_i m_i \Theta_i$ of complex projective lines attached with a core on one hand, while a *trunk* is a chain $\sum_i m_i \Theta_i$ of complex projective lines connecting other irreducible components on both hands. We say that X_0 is a *stellar* singular fiber if X_0 consists of one core and branches emanating from the core. See Figure 1. Otherwise X_0 is said to be *constellar*. If X_0 is *normally minimal*, that is, (i) any singularity of X_0^{red} is a node and (ii) any irreducible component that is a (-1) -curve (an exceptional curve of the first kind) intersects other irreducible component at at least three points, then all the branches and trunks of X_0 contain no (-1) -curves.

A degeneration whose singular fiber is a (*fringed*) branch can be constructed explicitly and associated to a sequence of nonnegative integers (the *multiplicity sequence*):

Lemma 2.3. *Let $m_0, m_1, \dots, m_{\lambda+1}$ ($\lambda \geq 1$) be nonnegative integers³ satisfying the*

³ In this paper, by convention, we append $m_{\lambda+1} = 0$ to the sequence $m_0, m_1, \dots, m_\lambda$ of positive integers, so that $r_\lambda := (m_{\lambda-1} + m_{\lambda+1})/m_\lambda$ equals $m_{\lambda-1}/m_\lambda$. See [Ta3] Section 5.1.

following conditions:

$$\begin{cases} m_0 > m_1 > \cdots > m_\lambda > m_{\lambda+1} = 0 \text{ and} \\ r_i := \frac{m_{i-1} + m_{i+1}}{m_i} \text{ (} i = 1, 2, \dots, \lambda \text{) is an integer greater than 1.} \end{cases}$$

Then there exists a degeneration $\pi : M \rightarrow \Delta$ with the singular fiber

$$X_0 = m_0\Delta_0 + m_1\Theta_1 + m_2\Theta_2 + \cdots + m_\lambda\Theta_\lambda,$$

where $\Delta_0 = \mathbb{C}$, and $\Theta_1, \Theta_2, \dots, \Theta_\lambda$ are complex projective lines, and each pair of Θ_i and Θ_{i+1} ($i = 1, 2, \dots, \lambda - 1$) and Δ_0 and Θ_1 intersect transversely at one point.

Proof. We take λ copies $\Theta_1, \Theta_2, \dots, \Theta_\lambda$ of the complex projective line. Let $\Theta_i = U_i \cup V_i$ be an open covering by two complex lines $U_i, V_i (= \mathbb{C})$ with coordinates $w_i \in U_i \setminus \{0\}$ and $z_i \in V_i \setminus \{0\}$ satisfying $z_i = 1/w_i$. Then we obtain a line bundle N_i on Θ_i of degree $-r_i$ from $U_i \times \mathbb{C}$ and $V_i \times \mathbb{C}$ by identifying $(z_i, \zeta_i) \in (V_i \setminus \{0\}) \times \mathbb{C}$ with $(w_i, \eta_i) \in (U_i \setminus \{0\}) \times \mathbb{C}$ via

$$g_i : z_i = \frac{1}{w_i}, \quad \zeta_i = w_i^{r_i} \eta_i.$$

Now consider the hypersurface W_i in $N_i \times \Delta$ defined by

$$\begin{cases} H_i : w_i^{m_i-1} \eta_i^{m_i} - s = 0, & \text{in } U_i \times \mathbb{C} \times \Delta, \\ H'_i : z_i^{m_i+1} \zeta_i^{m_i} - s = 0, & \text{in } V_i \times \mathbb{C} \times \Delta. \end{cases}$$

Under plumbings $(w_{i+1}, \eta_{i+1}, s) = (\zeta_i, z_i, s)$ of $N_i \times \Delta$ and $N_{i+1} \times \Delta$ ($i = 1, 2, \dots, \lambda - 1$), the hypersurfaces $W_1, W_2, \dots, W_\lambda$ are glued, so that they together define a smooth complex surface M . Letting $\pi : M \rightarrow \Delta$ be the natural projection, the central fiber is

$$\pi^{-1}(0) = m_0\Delta_0 + m_1\Theta_1 + m_2\Theta_2 + \cdots + m_\lambda\Theta_\lambda,$$

where $\Delta_0 := \{0\} \times \mathbb{C} \subset U_1 \times \mathbb{C}$. Thus the holomorphic map $\pi : M \rightarrow \Delta$ is the desired degeneration. \square

Remark 2.4. Precisely speaking, the holomorphic function $\pi : M \rightarrow \Delta$ obtained in Lemma 2.3 does not satisfy the condition to be a degeneration. Indeed π is not proper. Note that we consider the restriction of a degeneration to a tubular neighborhood of a branch.

Next we define a special subdivisor of a stellar singular fiber. Let $\pi : M \rightarrow \Delta$ be a linear degeneration of complex curves with the stellar singular fiber $X_0 = m_0\Theta_0 + \sum_{j=1}^h \mathbf{Br}^{(j)}$, where Θ_0 is the core and $\mathbf{Br}^{(j)}$ ($j = 1, 2, \dots, h$) is a branch. Write $\mathbf{Br}^{(j)} = m_1^{(j)}\Theta_1^{(j)} + m_2^{(j)}\Theta_2^{(j)} + \cdots + m_{\lambda^{(j)}}^{(j)}\Theta_{\lambda^{(j)}}^{(j)}$ and let $\overline{\mathbf{Br}}^{(j)} = m_0\Delta_0^{(j)} + m_1^{(j)}\Theta_1^{(j)} + \cdots + m_{\lambda^{(j)}}^{(j)}\Theta_{\lambda^{(j)}}^{(j)}$ be a fringed branch. Consider a connected subdivisor $Y = n_0\Theta_0 + \sum_{j=1}^h \mathbf{br}^{(j)}$ of X_0 , where $\mathbf{br}^{(j)} := n_1^{(j)}\Theta_1^{(j)} + n_2^{(j)}\Theta_2^{(j)} + \cdots + n_{\nu^{(j)}}^{(j)}\Theta_{\nu^{(j)}}^{(j)}$ ($j =$

$1, 2, \dots, h$). Here Y satisfies $0 \leq \nu^{(j)} \leq \lambda^{(j)}$ and $0 < n_i^{(j)} \leq m_i^{(j)}$ for each i and j . Set $\overline{\mathbf{br}}^{(j)} := n_0 \Delta_0^{(j)} + n_1^{(j)} \Theta_1^{(j)} + n_2^{(j)} \Theta_2^{(j)} + \dots + n_{\nu^{(j)}}^{(j)} \Theta_{\nu^{(j)}}^{(j)}$. For the time being, we consider $\overline{\mathbf{Br}}^{(j)}$ and $\overline{\mathbf{br}}^{(j)}$, omitting the superscript (j) to simplify notation. We call $\overline{\mathbf{br}}$ a *subbranch* of $\overline{\mathbf{Br}}$ if one of the following conditions is satisfied:

- $\nu = 0, 1$, or
- $\nu \geq 2$ and $n_{i+1} = r_i n_i - n_{i-1}$ ($i = 1, 2, \dots, \nu - 1$),

where $r_i := (m_{i-1} + m_{i+1})/m_i$ (see Lemma 2.3). Set $n_{\nu+1} := r_\nu n_\nu - n_{\nu-1}$. If $\nu = 0$, then we set $n_{\nu+1} = n_1 := 0$. Define the three types of subbranches for a positive integer l as follows:

Type A_l A subbranch $\overline{\mathbf{br}}$ of $\overline{\mathbf{Br}}$ is of *type A_l* if $ln_i \leq m_i$ for each i and $n_{\nu+1} \leq 0$.

Type B_l A subbranch $\overline{\mathbf{br}}$ of $\overline{\mathbf{Br}}$ is of *type B_l* if $ln_i \leq m_i$ for each i , $n_\nu = 1$ and $m_\nu = l$.

Type C_l A subbranch $\overline{\mathbf{br}}$ of $\overline{\mathbf{Br}}$ is of *type C_l* if $ln_i \leq m_i$ for each i , $n_\nu = n_{\nu+1}$ and $m_\nu - m_{\nu+1}$ divides l .

Now we return to a connected subdivisor Y of the stellar singular fiber X_0 .

Definition 2.5. Let $Y = n_0 \Theta_0 + \sum_{j=1}^h \mathbf{br}^{(j)}$ be a connected subdivisor of X_0 such that $n_0 < m_0$ and each $\overline{\mathbf{br}}^{(j)}$ is a subbranch of $\overline{\mathbf{Br}}^{(j)}$. Y is called a *crust* of X_0 if there exists a meromorphic section τ of the line bundle $N_0^{\otimes n_0}$ on Θ_0 such that for some nonnegative divisor $D = \sum_{i=1}^k a_i q_i$ on Θ_0 ,

$$\operatorname{div}(\tau) = - \sum_{j=1}^h n_1^{(j)} p^{(j)} + D,$$

where N_0 denotes the normal bundle of Θ_0 in M , $\{p^{(j)}\}$ is the set of the attachment points on Θ_0 with the branches $\mathbf{Br}^{(j)}$. Moreover, for a positive integer l , if each $\overline{\mathbf{br}}^{(j)}$ is a subbranch of $\overline{\mathbf{Br}}^{(j)}$ of either type A_l , type B_l or type C_l , then we call Y a *simple crust* of X_0 with *barking multiplicity l* .

We call the meromorphic section τ a *core section*. Note that τ is not uniquely determined by Y . Setting $r_0 := \sum_{j=1}^h m_1^{(j)}/m_0$ and $r'_0 := \sum_{j=1}^h n_1^{(j)}/n_0$, the following holds:

Lemma 2.6. *Suppose that Θ_0 is a complex projective line. Then a connected subdivisor Y is a crust of X_0 (equivalently, Y has a core section τ) if and only if $r_0 \leq r'_0$. Moreover τ has no zero, that is, $D = 0$ exactly when $r_0 = r'_0$.*

Takamura constructed a deformation family of $\pi : M \rightarrow \Delta$ associated with a simple crust Y . We call a deformation family obtained by his method a *barking family*. In a barking family, the original singular fiber X_0 is deformed to a simpler

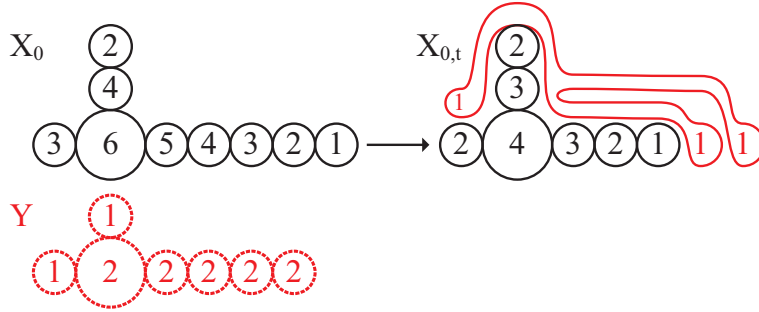

Figure 2: In the barking family $[II^*.1]$, the singular fiber of type II^* is deformed to the main fiber of type III^* . It seems that the simple crust Y is “barked” (peeled) off from the original singular fiber.

singular fiber in such a way that a part of X_0 looks “barked” off from X_0 . The resulting singular fiber appears over the origin of Δ_t , so we denote it by $X_{0,t}$ and call it the *main fiber*. See Figure 2.

In a barking family, there appear not only the main fiber but also other singular fibers over some points away from the origin of Δ_t , which are called *subordinate fibers*. It is easy to see this. Under the deformation, the topological type of the singular fiber over the origin changes, so the local monodromy around it also changes (see Section 4 for details). On the other hand, the global monodromies before and after the deformation — that is, the two monodromies each of which is induced by a loop in Δ (resp. Δ_t) parallel to its boundary $\partial\Delta$ (resp. $\partial\Delta_t$) — coincide. We then deduce that there appear other singular fibers with nontrivial monodromies. Thus every barking family turns out to be a splitting family. Therefore:

Theorem 2.7 (Takamura [Ta3]). *Let $\pi : M \rightarrow \Delta$ be a linear degeneration with the stellar singular fiber X_0 . If X_0 has a simple crust Y , then $\pi : M \rightarrow \Delta$ admits a splitting family $\Psi : \mathcal{M} \rightarrow \Delta \times \Delta^\dagger$.*

Remark 2.8. In this paper, for a degeneration which is *not* necessarily relatively minimal, a splitting family of it is defined to satisfy that each deformation has at least two singular fibers (see Section 1). Thus singular fibers of a deformation in a splitting family possibly become smooth fibers after blowing down. Such singular fibers are said to be *fake*.

Kodaira’s notation

Before proceeding, we supply Kodaira’s list of singular fibers of (relatively) minimal degenerations of elliptic curves [Ko]. See Table 1. For a singular fiber X , we denote by $e(X)$ the topological Euler characteristic of the underlying reduced curve X^{red} of X . $A_X \in SL(2, \mathbb{Z})$ is the standard monodromy matrix of X and its trace is denoted by $\text{Tr}(A_X)$.

Table 1: Kodaira's notation.

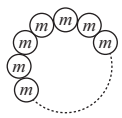
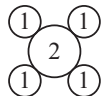
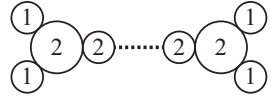
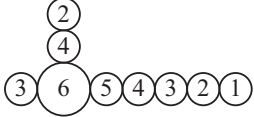
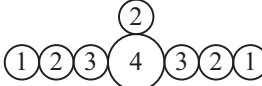
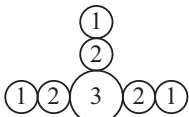
	a singular fiber X	$e(X)$	A_X	$\text{Tr}(A_X)$
mI_0 ($m \geq 2$)	a multiple torus	0	$\begin{pmatrix} 1 & 0 \\ 0 & 1 \end{pmatrix}$	2
mI_1	a (multiple) projective line with one node	1	$\begin{pmatrix} 1 & 1 \\ 0 & 1 \end{pmatrix}$	2
mI_n		n	$\begin{pmatrix} 1 & n \\ 0 & 1 \end{pmatrix}$	2
II	a projective line with one cusp	2	$\begin{pmatrix} 0 & 1 \\ -1 & 1 \end{pmatrix}$	1
III	two projective lines with second order contact	3	$\begin{pmatrix} 0 & 1 \\ -1 & 0 \end{pmatrix}$	0
IV	three projective lines intersecting transversally at one point	4	$\begin{pmatrix} -1 & 1 \\ -1 & 0 \end{pmatrix}$	-1
I_0^*		6	$\begin{pmatrix} -1 & 0 \\ 0 & -1 \end{pmatrix}$	-2
I_n^*		$6 + n$	$\begin{pmatrix} -1 & -n \\ 0 & -1 \end{pmatrix}$	-2
II^*		10	$\begin{pmatrix} 1 & -1 \\ 1 & 0 \end{pmatrix}$	1
III^*		9	$\begin{pmatrix} 0 & -1 \\ 1 & 0 \end{pmatrix}$	0
IV^*		8	$\begin{pmatrix} 0 & -1 \\ 1 & -1 \end{pmatrix}$	-1

Note that minimal singular fibers of type I_n^* , II^* , III^* and IV^* in this table are normally minimal and their underlying reduced curves have at most simple normal crossings. In contrast, minimal singular fibers of type II , III and IV have a singularity that is not a node. However, after successive blowing up, they become normally minimal degenerations such that X^{red} has at most simple normal crossings. In this paper, such degenerations are also referred to be of type II , III and IV .

3 Constraints from Euler characteristics

In [Ta3], Takamura listed thirty five barking families for degenerations of complex curves of genus $g = 1$, that is, for degenerations of elliptic curves, and determined the type of the main fiber of each of them as follows (see also the list in Section 12):

$$\begin{array}{ll}
[II.1] & II \xrightarrow{\text{bark}} I_1 \\
[II.2] & II \xrightarrow{\text{bark}} I_1 \\
[II^*.1] & II^* \xrightarrow{\text{bark}} III^* \\
[II^*.2] & II^* \xrightarrow{\text{bark}} IV^* \\
[II^*.3] & II^* \xrightarrow{\text{bark}} I_2^* \\
[II^*.4] & II^* \xrightarrow{\text{bark}} I_5 \\
[II^*.5] & II^* \xrightarrow{\text{bark}} I_3^* \\
[II^*.6] & II^* \xrightarrow{\text{bark}} I_3^* \\
[II^*.7] & II^* \xrightarrow{\text{bark}} I_8 \\
[II^*.8] & II^* \xrightarrow{\text{bark}} III^* \\
[II^*.9] & II^* \xrightarrow{\text{bark}} III^* \\
[III.1] & III \xrightarrow{\text{bark}} I_2 \\
[III.2] & III \xrightarrow{\text{bark}} I_1 \\
[III.3] & III \xrightarrow{\text{bark}} I_2 \\
[III^*.1] & III^* \xrightarrow{\text{bark}} IV^* \\
[III^*.2] & III^* \xrightarrow{\text{bark}} I_1^* \\
[III^*.3] & III^* \xrightarrow{\text{bark}} I_2^* \\
[III^*.4] & III^* \xrightarrow{\text{bark}} I_0^* \\
[III^*.5] & III^* \xrightarrow{\text{bark}} I_6 \\
[III^*.6] & III^* \xrightarrow{\text{bark}} I_2^* \\
[III^*.7] & III^* \xrightarrow{\text{bark}} I_7 \\
[III^*.8] & III^* \xrightarrow{\text{bark}} I_6 \\
[III^*.9] & III^* \xrightarrow{\text{bark}} IV^* \\
[IV.1] & IV \xrightarrow{\text{bark}} I_3 \\
[IV.2] & IV \xrightarrow{\text{bark}} I_2 \\
[IV.3] & IV \xrightarrow{\text{bark}} I_2 \\
[IV.4] & IV \xrightarrow{\text{bark}} II \\
[IV^*.1] & IV^* \xrightarrow{\text{bark}} I_1^* \\
[IV^*.2] & IV^* \xrightarrow{\text{bark}} I_0^* \\
[IV^*.3] & IV^* \xrightarrow{\text{bark}} I_6 \\
[IV^*.4] & IV^* \xrightarrow{\text{bark}} I_1^* \\
[I_0^*.1] & I_0^* \xrightarrow{\text{bark}} I_4 \\
[I_0^*.2] & I_0^* \xrightarrow{\text{bark}} I_3 \\
[I_n^*.1] & I_n^* \xrightarrow{\text{bark}} I_{n-1}^* \\
[I_n^*.2] & I_n^* \xrightarrow{\text{bark}} I_{n+4}.
\end{array}$$

The aim of this paper is to determine the subordinate fibers of the above barking families. In this section, we give a list of the sets of subordinate fibers that can

appear in each of the barking families, using results on Euler characteristics of singular fibers of degenerations.

For a singular fiber X , we denote by $e(X)$ the *topological Euler characteristic* of the underlying reduced curve of X .

Lemma 3.1. *Let $\pi : M \rightarrow \Delta$ be a degeneration of complex curves of genus $g \geq 1$ with the singular fiber X_0 and let $\Psi : \mathcal{M} \rightarrow \Delta \times \Delta^\dagger$ be a splitting family of $\pi : M \rightarrow \Delta$, say, X_0 splits into singular fibers X_1, X_2, \dots, X_N ($N \geq 2$) of a deformation $\pi_t : M_t \rightarrow \Delta_t$.*

(a) *Then the following formula holds:*

$$e(X_0) - 2(1 - g) = \sum_{i=1}^N \{e(X_i) - 2(1 - g)\}.$$

(b) *In particular, if $g = 1$, then the following holds:*

$$e(X_0) = e(X_1) + e(X_2) + \dots + e(X_N). \quad (3.1)$$

Proof. (a) The left hand side equals the Euler characteristic $e(M)$ of M , while the right hand side equals $e(M_t)$ (see [BPV, p. 97]). Since M_t is diffeomorphic to M , we have $e(M) = e(M_t)$, which confirms the assertion.

(b) clearly follows from (a). □

Consider a barking family $\Psi : \mathcal{M} \rightarrow \Delta \times \Delta^\dagger$ of the degeneration $\pi : M \rightarrow \Delta$ of elliptic curves. Recall that for a singular fiber $X_{s,t} := \Psi^{-1}(s, t)$ ($t \neq 0$), we call $X_{s,t}$ the main fiber if $s = 0$, and a subordinate fiber if $s \neq 0$. Suppose that $\Psi : \mathcal{M} \rightarrow \Delta \times \Delta^\dagger$ splits the original singular fiber X_0 into the main fiber $X_{0,t}$ and subordinate fibers $X_{s_1,t}, X_{s_2,t}, \dots, X_{s_N,t}$ ($N \geq 1$). In these notations, we restate (3.1) in Lemma 3.1 as

$$e(X_0) = e(X_{0,t}) + \sum_{i=1}^N e(X_{s_i,t}). \quad (3.2)$$

This confirms (a) of the following:

Lemma 3.2. *Let $\pi : M \rightarrow \Delta$ be a degeneration of elliptic curves with the singular fiber X_0 . Suppose that a barking family $\Psi : \mathcal{M} \rightarrow \Delta \times \Delta^\dagger$ splits the original singular fiber X_0 into the main fiber $X_{0,t}$ and subordinate fibers $X_{s_1,t}, X_{s_2,t}, \dots, X_{s_N,t}$ ($N \geq 1$). Then:*

(a) *The sum of the Euler characteristics of the subordinate fibers is $e(X_0) - e(X_{0,t})$:*

$$\sum_{i=1}^N e(X_{s_i,t}) = e(X_0) - e(X_{0,t}).$$

(b) If $e(X_0) - e(X_{0,t}) = 1$ holds, then Ψ splits X_0 into the main fiber $X_{0,t}$ and one subordinate fiber I_1 :

$$X_0 \longrightarrow X_{0,t} + I_1.$$

Proof. It remains to show the second statement (b). From the assumption $e(X_0) - e(X_{0,t}) = 1$ together with (a), we have

$$e(X_{s_1,t}) + e(X_{s_2,t}) + \cdots + e(X_{s_N,t}) = 1.$$

Note that every subordinate fiber of any barking family is a reduced curve only with A -singularities (Lemma 7.1). In particular, each subordinate fiber $X_{s_i,t}$ is not a multiple torus (whose Euler characteristic is 0), thus $e(X_{s_i,t}) \geq 1$. Hence we have $N = 1$ (that is, $X_{s_1,t}$ is the unique subordinate fiber) and $e(X_{s_1,t}) = 1$. This equality holds exactly when $X_{s_1,t}$ is mI_1 ($m \geq 1$). By Lemma 7.1 again, $X_{s_1,t}$ is a reduced curve, so $m = 1$. Accordingly $X_{s_1,t}$ is I_1 . \square

Lemma 3.2 (b) immediately yields the following:

Proposition 3.3 (Case: $e(X_0) - e(X_{0,t}) = 1$). *In each of the following barking families, the subordinate fiber is I_1 .*

$$\begin{array}{ll}
[\mathbf{II}.1] & II \xrightarrow{\text{bark}} I_1 \\
[\mathbf{II}.2] & II \xrightarrow{\text{bark}} I_1 \\
[\mathbf{II}^*.1] & II^* \xrightarrow{\text{bark}} III^* \\
[\mathbf{II}^*.5] & II^* \xrightarrow{\text{bark}} I_3^* \\
[\mathbf{II}^*.6] & II^* \xrightarrow{\text{bark}} I_3^* \\
[\mathbf{II}^*.8] & II^* \xrightarrow{\text{bark}} III^* \\
[\mathbf{II}^*.9] & II^* \xrightarrow{\text{bark}} III^* \\
[\mathbf{III}.1] & III \xrightarrow{\text{bark}} I_2 \\
[\mathbf{III}.3] & III \xrightarrow{\text{bark}} I_2 \\
[\mathbf{III}^*.1] & III^* \xrightarrow{\text{bark}} IV^* \\
[\mathbf{III}^*.3] & III^* \xrightarrow{\text{bark}} I_2^* \\
[\mathbf{III}^*.6] & III^* \xrightarrow{\text{bark}} I_2^* \\
[\mathbf{III}^*.9] & III^* \xrightarrow{\text{bark}} IV^* \\
[\mathbf{IV}.1] & IV \xrightarrow{\text{bark}} I_3 \\
[\mathbf{IV}^*.1] & IV^* \xrightarrow{\text{bark}} I_1^* \\
[\mathbf{IV}^*.4] & IV^* \xrightarrow{\text{bark}} I_1^* \\
[\mathbf{I}_n^*.1] & I_n^* \xrightarrow{\text{bark}} I_{n-1}^*.
\end{array}$$

If $e(X_0) - e(X_{0,t}) \geq 2$, then we need another criterion to determine the subordinate fibers. However by Lemma 3.2 (a) we can narrow down candidates.

Lemma 3.4 (Case: $e(X_0) - e(X_{0,t}) = 2$). *In each of the following barking families,*

the set of subordinate fibers is one of $\{II\}$, $\{I_2\}$, and $\{I_1, I_1\}$.

$$\begin{array}{ll}
[II^*.2] & II^* \xrightarrow{\text{bark}} IV^* \\
[II^*.3] & II^* \xrightarrow{\text{bark}} I_2^* \\
[II^*.7] & II^* \xrightarrow{\text{bark}} I_8 \\
[III.2] & III \xrightarrow{\text{bark}} I_1 \\
[III^*.2] & III^* \xrightarrow{\text{bark}} I_1^* \\
[III^*.7] & III^* \xrightarrow{\text{bark}} I_7 \\
[IV.2] & IV \xrightarrow{\text{bark}} I_2 \\
[IV.3] & IV \xrightarrow{\text{bark}} I_2 \\
[IV.4] & IV \xrightarrow{\text{bark}} II \\
[IV^*.2] & IV^* \xrightarrow{\text{bark}} I_0^* \\
[IV^*.3] & IV^* \xrightarrow{\text{bark}} I_6 \\
[I_0^*.1] & I_0^* \xrightarrow{\text{bark}} I_4 \\
[I_n^*.2] & I_n^* \xrightarrow{\text{bark}} I_{n+4}.
\end{array}$$

Lemma 3.5 (Case: $e(X_0) - e(X_{0,t}) = 3$). *In each of the following barking families, the set of subordinate fibers is one of $\{III\}$, $\{I_3\}$, $\{II, I_1\}$, $\{I_2, I_1\}$, and $\{I_1, I_1, I_1\}$.*

$$\begin{array}{ll}
[III^*.4] & III^* \xrightarrow{\text{bark}} I_0^* \\
[III^*.5] & III^* \xrightarrow{\text{bark}} I_6 \\
[III^*.8] & III^* \xrightarrow{\text{bark}} I_6 \\
[I_0^*.2] & I_0^* \xrightarrow{\text{bark}} I_3.
\end{array}$$

Lemma 3.6 (Case: $e(X_0) - e(X_{0,t}) = 5$). *The sum of the Euler characteristics of the subordinate fibers of the following barking family is 5:*

$$[II^*.4] \quad II^* \xrightarrow{\text{bark}} I_5.$$

4 Monodromies around singular fibers

Next we consider the monodromies around singular fibers of splitting families (*not necessarily* barking families).

Let $\pi : M \rightarrow \Delta$ be a (relatively) minimal degeneration of elliptic curves with the singular fiber X_0 . We take a base point s_0 in $\Delta \setminus \{0\}$ and a loop (simple closed curve) l_0 in $\Delta \setminus \{0\}$ passing through the base point s_0 and circuiting around the origin with the counterclockwise orientation. Then $\pi^{-1}(l_0)$ is a real 3-manifold and the restriction $\pi : \pi^{-1}(l_0) \rightarrow l_0$ is a Σ -bundle over S^1 , where Σ is an elliptic curve. Here $\pi^{-1}(l_0)$ is obtained from $\Sigma \times [0, 1]$ by the identification of the boundaries $\Sigma \times \{0\}$ and $\Sigma \times \{1\}$ via an orientation-preserving homeomorphism f of Σ . The isotopy class $[f]$ of f is called the *topological monodromy* around X_0 . Then f induces an automorphism $\rho := f_*$ on $H_1(\Sigma, \mathbb{Z})$, which is called the (*homological*) *monodromy* around X_0 . Under an identification of Σ and $\mathbb{R}^2/\mathbb{Z}^2$, fixing a basis of $H_1(\Sigma, \mathbb{Z})$, we obtain an isomorphism

$$\text{Aut}(H_1(\Sigma, \mathbb{Z})) \rightarrow SL(2, \mathbb{Z}).$$

In the subsequent discussion, we consider ρ as an element of $SL(2, \mathbb{Z})$.

Next suppose that $\Psi : \mathcal{M} \rightarrow \Delta \times \Delta^\dagger$ is a splitting family of the degeneration $\pi : M \rightarrow \Delta$, that is, the deformation $\pi_t : M_t \rightarrow \Delta_t$ of $\pi : M \rightarrow \Delta$ for a fixed $t \neq 0$ has singular fibers X_1, X_2, \dots, X_N ($N \geq 2$). Then we say that X_0 splits into X_1, X_2, \dots, X_N and express $X_0 \rightarrow X_1 + X_2 + \dots + X_N$. Now we define the local monodromies around the singular fibers X_k ($k = 1, 2, \dots, N$) as follows: Set $s_k := \pi_t(X_k)$. We take a base point s'_0 in $\Delta_t \setminus \{s_1, s_2, \dots, s_N\}$ (so the fiber $X_{s'_0} = \pi_t^{-1}(s'_0)$ is smooth). For each $k = 1, 2, \dots, N$, we take a loop l_k in $\Delta_t \setminus \{s_1, s_2, \dots, s_N\}$ passing through the base point s'_0 and circuiting around s_k with the counterclockwise orientation. Then the loop l_k induces an orientation-preserving homeomorphism f_k of Σ , which defines the local topological monodromy $[f_k]$ and the local (homological) monodromy $\rho_k \in SL(2, \mathbb{Z})$ around X_k .

The following is known (see [U]):

Lemma 4.1. *The monodromy ρ around X_0 (resp. the local monodromy ρ_k around X_k for each $k = 1, 2, \dots, N$) is conjugate to the standard monodromy matrix⁴ corresponding to the singular fiber X_0 (resp. X_k).*

Possibly after renumbering, we may assume that $l_1 \circ l_2 \circ \dots \circ l_N$ is homotopic to a loop rounding all the singular values s_1, s_2, \dots, s_N with the counterclockwise orientation. Let $\mathcal{D} \subset \Delta \times \Delta^\dagger$ be the set of singular values of Ψ . We now take a path l in $(\Delta \times \Delta^\dagger) \setminus \mathcal{D}$ connecting $s_0 \in \Delta_0$ and $s'_0 \in \Delta_t$. Note that for any point $(s, t) \in l$, the fiber $X_{s,t} = \Psi^{-1}(s, t)$ is smooth. Since the loop $l^{-1} \circ l_1 \circ l_2 \circ \dots \circ l_N \circ l$ is homotopic to the loop l_0 , the topological monodromy $[f]$ is conjugate to the composition of the local topological monodromies $[f_1] \circ [f_2] \circ \dots \circ [f_N]$. Similarly:

Lemma 4.2. *The monodromy ρ is conjugate to the composition of the local monodromies $\rho_1, \rho_2, \dots, \rho_N$.*

We prepare notation. $SL(2, \mathbb{Z}) = \langle a, b \mid a^3 = b^2 = -E \rangle$ is generated by

$$a := \begin{pmatrix} 0 & 1 \\ -1 & 1 \end{pmatrix} \quad \text{and} \quad b := \begin{pmatrix} 0 & 1 \\ -1 & 0 \end{pmatrix}.$$

Setting⁵

$$s_0 := a^{-1}b = \begin{pmatrix} 1 & 1 \\ 0 & 1 \end{pmatrix} \quad \text{and} \quad s_2 := ba^{-1} = \begin{pmatrix} 1 & 0 \\ -1 & 1 \end{pmatrix},$$

then s_0 and s_2 are also generators of $SL(2, \mathbb{Z})$: indeed we have $a = s_0 s_2$ and $b = s_0 s_2 s_0 = s_2 s_0 s_2$. Since $s_2 = (s_0 s_2) s_0 (s_0 s_2)^{-1}$, s_2 is conjugate to s_0 .

⁴ See Table 1 in Section 2.

⁵ The notations s_0 and s_2 are used in [FM] Section 2.4, where ‘ s_1 ’ is defined as $s_1 := aba$.

Next we express the standard monodromy matrices of singular fibers as a product of s_0 and s_2 as follows (see [U]):

$$\begin{aligned}
A_{I_n} &= (s_0)^n \quad (n \geq 1) \\
A_{II} &= s_0 s_2 \\
A_{III} &= s_0 s_2 s_0 = s_2 s_0 s_2 \\
A_{IV} &= s_0 s_2 s_0 s_2 \\
A_{II^*} &= (s_0 s_2)^5 \\
A_{III^*} &= (s_0 s_2)^4 s_0 \\
A_{IV^*} &= (s_0 s_2)^4 \\
A_{I_n^*} &= (s_0 s_2)^3 (s_0)^n \quad (n \geq 0).
\end{aligned}$$

The number of s_0, s_2 contained in each product coincides with the Euler characteristic of the corresponding singular fiber. Note that s_0 is the standard monodromy matrix A_{I_1} of the singular fiber I_1 . It is known that for any degeneration of elliptic curves except with mI_0 ($m \geq 2$), the singular fiber splits into singular fibers of type I_1 (whose Euler characteristic $e(I_1)$ is equal to 1) after successive deformations. See [Ka], [M].

Example 4.3. The barking family [III.1] splits the singular fiber III into the main fiber I_2 and a subordinate fiber I_1 :

$$III \longrightarrow I_2 + I_1.$$

Lemma 4.2 states that, if X_0 splits into X_1, X_2, \dots, X_N , then a monodromy matrix of X_0 is conjugate to the composition of monodromy matrices of X_1, X_2, \dots, X_N (that is, conjugacies of the standard monodromy matrices corresponding to X_1, X_2, \dots, X_N respectively). In this case, the standard monodromy matrix A_{III} of III is decomposed into conjugacies of the standard monodromy matrices corresponding to I_2 and I_1 :

$$\begin{aligned}
A_{III} &= s_0 s_2 s_0 \\
&= s_0^2 (s_0^{-1} s_2 s_0) \\
&= s_0^2 (s_2 s_0 s_2^{-1}) && (s_0 s_2 s_0 = s_2 s_0 s_2) \\
&= A_{I_2} \cdot (s_2 A_{I_1} s_2^{-1}).
\end{aligned}$$

In Section 11, we will give decompositions of the standard monodromy matrix corresponding to the splittings induced from Takamura's barking families.

5 Constraints from monodromies

From Lemmas 4.1 and 4.2, it is a necessary condition for a singular fiber X_0 to split into singular fibers X_1, X_2, \dots, X_N ($N \geq 2$) that some monodromy matrix of X_0 is conjugate to the composition of monodromy matrices of X_1, X_2, \dots, X_N ,

which means that monodromies give some constraints to splittings. In this section, we prove that none of the following splittings occurs (Theorem 5.8):

$$\begin{aligned}
IV &\longrightarrow I_2 + I_2, \\
III^* &\longrightarrow I_8 + II, \quad I_7 + III, \quad I_6 + IV, \\
&\quad I_4 + I_0^*, \quad I_3 + I_1^*, \\
&\quad I_u + I_v (u + v = 10), \\
III^* &\longrightarrow I_7 + II, \quad I_6 + III, \quad I_5 + IV, \quad I_3 + I_0^*, \\
&\quad I_u + I_v (u + v = 9), \\
IV^* &\longrightarrow I_6 + II, \quad I_5 + III, \quad I_4 + IV, \quad I_2 + I_0^*, \\
&\quad I_u + I_v (u + v = 8), \\
I_n^* (n \geq 0) &\longrightarrow I_{n+4} + II, \quad I_{n+3} + III, \quad I_{n+2} + IV, \\
&\quad I_u + I_v (u + v = n + 6 \text{ and } (n, u, v) \neq (2, 4, 4)). \\
I_0^* &\longrightarrow I_3 + I_2 + I_1.
\end{aligned}$$

We begin with preparation.

Lemma 5.1. *If matrices $A_1, A_2 \in SL(2, \mathbb{Z})$ are conjugate, then $\text{Tr}(A_1) = \text{Tr}(A_2)$, where $\text{Tr}(A_i)$ denotes the trace of A_i .*

Proof. By assumption, we may write $A_1 = PA_2P^{-1}$ for some $P \in SL(2, \mathbb{Z})$. Hence

$$\text{Tr}(A_1) = \text{Tr}((PA_2)P^{-1}) = \text{Tr}(P^{-1}(PA_2)) = \text{Tr}(A_2).$$

□

The following is useful:

Lemma 5.2. *Suppose that a singular fiber X splits into two singular fibers I_n ($n \geq 1$) and Y :*

$$X \longrightarrow I_n + Y.$$

Then

$$\text{Tr}(A_X) \equiv \text{Tr}(A_Y) \pmod{n},$$

where A_X and A_Y are the standard monodromy matrices of X and Y .

Proof. If X splits into I_n and Y , then for some monodromy matrix $C = \begin{pmatrix} a & b \\ c & d \end{pmatrix}$ of Y ,

$$B := A_{I_n}C = \begin{pmatrix} 1 & n \\ 0 & 1 \end{pmatrix} \begin{pmatrix} a & b \\ c & d \end{pmatrix} = \begin{pmatrix} a + nc & b + nd \\ c & d \end{pmatrix}$$

is a monodromy matrix of X . Then we have

$$\text{Tr}(B) = a + nc + d = \text{Tr}(C) + nc.$$

Thus

$$\mathrm{Tr}(B) \equiv \mathrm{Tr}(C) \pmod{n}.$$

Where A_X and A_Y denote the standard monodromy matrices corresponding to X and Y respectively, B is conjugate to A_X , while C is conjugate to A_Y . By Lemma 5.1 we have $\mathrm{Tr}(B) = \mathrm{Tr}(A_X)$ and $\mathrm{Tr}(C) = \mathrm{Tr}(A_Y)$. Accordingly

$$\mathrm{Tr}(A_X) \equiv \mathrm{Tr}(A_Y) \pmod{n}.$$

□

We now consider the singular fiber IV . Since the Euler characteristic of IV is 4 and that of I_2 is 2,

$$e(IV) = e(I_2) + e(I_2)$$

holds. Note that, if a singular fiber X_0 splits into two singular fibers X_1 and X_2 , then $e(X_0) = e(X_1) + e(X_2)$ (Lemma 3.1 (b)). So it is plausible that some deformation family splits the singular fiber IV into two I_2 . However this is not the case. If IV splits into two I_2 , by Lemma 5.2, we have

$$\mathrm{Tr}(A_{IV}) \equiv \mathrm{Tr}(A_{I_2}) \pmod{2},$$

which contradicts that $\mathrm{Tr}(A_{IV}) = -1$ and $\mathrm{Tr}(A_{I_2}) = 2$. Thus the splitting

$$IV \longrightarrow I_2 + I_2$$

does not occur. We have shown the first statement of the following lemma, and we can show the others by the same argument:

Lemma 5.3. (a) *The singular fiber IV never splits as follows:*

$$IV \longrightarrow I_2 + I_2.$$

(b) *The singular fiber II^* never splits as follows:*

$$\begin{aligned} II^* &\longrightarrow I_8 + II, & I_7 + III, & I_6 + IV, \\ &I_4 + I_0^*, & I_3 + I_1^*, \\ &I_u + I_v \ (u + v = 10). \end{aligned}$$

(c) *The singular fiber III^* never splits as follows:*

$$\begin{aligned} III^* &\longrightarrow I_7 + II, & I_6 + III, & I_5 + IV, \\ &I_3 + I_0^*, & I_u + I_v \ (u + v = 9). \end{aligned}$$

(d) *The singular fiber IV^* never splits as follows:*

$$\begin{aligned} IV^* &\longrightarrow I_6 + II, & I_5 + III, & I_4 + IV, \\ &I_2 + I_0^*, & I_u + I_v \ (u + v = 8). \end{aligned}$$

(e) *The singular fiber I_n^* ($n \geq 1$) never splits as follows:*

$$\begin{aligned} I_n^* &\longrightarrow I_{n+4} + II, \quad I_{n+3} + III, \quad I_{n+2} + IV, \\ &I_u + I_v \quad (u + v = n + 6, \quad (n, u, v) \neq (2, 4, 4)). \end{aligned}$$

Next we consider splittings of I_0^* . The standard monodromy matrix of I_0^* is $A_{I_0^*} = -E$, where E is the identity matrix.

Lemma 5.4. *Suppose that the singular fiber I_0^* splits into two singular fibers X and Y :*

$$I_0^* \longrightarrow X + Y.$$

Then

$$\mathrm{Tr}(A_X) + \mathrm{Tr}(A_Y) = 0.$$

Proof. If I_0^* splits into X and Y , then for monodromy matrices B and C of X and Y , we have $A_{I_0^*} = BC$, where $A_{I_0^*}$ is the standard monodromy matrix of I_0^* . Since $A_{I_0^*} = -E$, we have $-E = BC$, that is, $B = -C^{-1}$. In particular,

$$\mathrm{Tr}(B) = -\mathrm{Tr}(C).$$

Since B (resp. C) is conjugate to A_X (resp. A_Y), by Lemma 5.1 we have $\mathrm{Tr}(B) = \mathrm{Tr}(A_X)$ and $\mathrm{Tr}(C) = \mathrm{Tr}(A_Y)$. Thus

$$\mathrm{Tr}(A_X) + \mathrm{Tr}(A_Y) = 0.$$

□

Lemma 5.5. *Suppose that the singular fiber I_0^* splits into three singular fibers I_n ($n \geq 1$), X and Y :*

$$I_0^* \longrightarrow I_n + X + Y.$$

Then

$$\mathrm{Tr}(A_X) + \mathrm{Tr}(A_Y) \equiv 0 \pmod{n}.$$

Proof. If I_0^* splits into I_n , X_1 and X_2 , then for monodromy matrices B and C of X and Y , we have $A_{I_0^*} = A_{I_n}BC$. Since $A_{I_0^*} = -E$ and $A_{I_n} = \begin{pmatrix} 1 & n \\ 0 & 1 \end{pmatrix}$, writing

$$B = \begin{pmatrix} a & b \\ c & d \end{pmatrix},$$

$$-C^{-1} = A_{I_n}B = \begin{pmatrix} 1 & n \\ 0 & 1 \end{pmatrix} \begin{pmatrix} a & b \\ c & d \end{pmatrix} = \begin{pmatrix} a + nc & b + nd \\ c & d \end{pmatrix}.$$

Then we have

$$-\mathrm{Tr}(C) = a + nc + d = \mathrm{Tr}(B) + nc.$$

Thus

$$\mathrm{Tr}(B) + \mathrm{Tr}(C) \equiv 0 \pmod{n}.$$

Since B (resp. C) is conjugate to A_X (resp. A_Y), by Lemma 5.1 we have $\text{Tr}(B) = \text{Tr}(A_X)$ and $\text{Tr}(C) = \text{Tr}(A_Y)$. Accordingly

$$\text{Tr}(A_X) + \text{Tr}(A_Y) \equiv 0 \pmod{n}.$$

□

Lemma 5.6. (a) *The singular fiber I_0^* never splits as follows:*

$$\begin{aligned} I_0^* \longrightarrow & I_4 + II, & I_3 + III, & I_2 + IV, \\ & I_5 + I_1, & I_4 + I_2, & I_3 + I_3. \end{aligned}$$

(b) *The singular fiber I_0^* never splits as follows:*

$$I_0^* \longrightarrow I_3 + I_2 + I_1.$$

Proof. (a) we only show that the splitting $I_0^* \longrightarrow I_4 + II$ does not occur, because we can give the proof for the other splittings by the same argument. If I_0^* splits into I_4 and II , by Lemma 5.4, we have

$$\text{Tr}(A_{I_4}) + \text{Tr}(A_{II}) = 0,$$

which contradicts that $\text{Tr}(A_{I_4}) = 2$ and $\text{Tr}(A_{II}) = 1$. Thus the splitting

$$I_0^* \longrightarrow I_4 + II$$

does not occur.

(b) If I_0^* splits into I_3 , I_2 and I_1 , by Lemma 5.5, we have

$$\text{Tr}(A_{I_2}) + \text{Tr}(A_{I_1}) \equiv 0 \pmod{3}.$$

which contradicts that $\text{Tr}(A_{I_2}) = \text{Tr}(A_{I_1}) = 2$. Thus the splitting

$$I_0^* \longrightarrow I_3 + I_2 + I_1.$$

does not occur. □

Remark 5.7. We can give an alternative proof of Lemma 5.6 (a) *except for the splitting $I_0^* \longrightarrow I_4 + I_2$* as follows; For instance, suppose that I_0^* splits into I_4 and II . By Lemma 5.2, we then have

$$\text{Tr}(A_{I_0^*}) \equiv \text{Tr}(A_{II}) \pmod{4},$$

which contradicts that $\text{Tr}(A_{I_0^*}) = -2$ and $\text{Tr}(A_{II}) = 1$. Thus the splitting

$$I_0^* \longrightarrow I_4 + II$$

does not occur.

We summarize Lemmas 5.3 and 5.6 as follows:

Theorem 5.8. *None of the following splittings occurs:*

$$\begin{aligned}
IV &\longrightarrow I_2 + I_2, \\
II^* &\longrightarrow I_8 + II, \quad I_7 + III, \quad I_6 + IV, \\
&\quad I_4 + I_0^*, \quad I_3 + I_1^*, \\
&\quad I_u + I_v (u + v = 10), \\
III^* &\longrightarrow I_7 + II, \quad I_6 + III, \quad I_5 + IV, \quad I_3 + I_0^*, \\
&\quad I_u + I_v (u + v = 9), \\
IV^* &\longrightarrow I_6 + II, \quad I_5 + III, \quad I_4 + IV, \quad I_2 + I_0^*, \\
&\quad I_u + I_v (u + v = 8), \\
I_n^* (n \geq 0) &\longrightarrow I_{n+4} + II, \quad I_{n+3} + III, \quad I_{n+2} + IV, \\
&\quad I_u + I_v (u + v = n + 6 \text{ and } (n, u, v) \neq (2, 4, 4)). \\
I_0^* &\longrightarrow I_3 + I_2 + I_1.
\end{aligned}$$

6 Determination of subordinate fibers, 1

In this section, based on the result of the previous section, we determine the subordinate fibers of Takamura's barking families $[II^*.7]$, $[III^*.7]$, $[IV^*.3]$, $[I_0^*.1]$, $[I_n^*.2]$.

Proposition 6.1. *The barking family $[II^*.7]$ splits the singular fiber II^* as follows:*

$$II^* \longrightarrow I_8 + I_1 + I_1,$$

where I_8 is the main fiber and the two I_1 are subordinate fibers.

Proof. In the barking family $[II^*.7]$, II^* is deformed to I_8 :

$$II^* \xrightarrow{\text{bark}} I_8.$$

By Lemma 3.4, the set of subordinate fibers is one of (i) $\{II\}$, (ii) $\{I_2\}$, and (iii) $\{I_1, I_1\}$. Now Lemma 5.3 (b) eliminates the cases (i) and (ii). Thus the subordinate fibers are two I_1 . \square

Proposition 6.2. *The barking family $[III^*.7]$ splits the singular fiber III^* as follows:*

$$III^* \longrightarrow I_7 + I_1 + I_1,$$

where I_7 is the main fiber and the two I_1 are subordinate fibers.

Proof. In the barking family $[III^*.7]$, III^* is deformed to I_7 :

$$III^* \xrightarrow{\text{bark}} I_7.$$

By Lemma 3.4, the set of subordinate fibers is one of (i) $\{II\}$, (ii) $\{I_2\}$, and (iii) $\{I_1, I_1\}$. Now Lemma 5.3 (c) eliminates the cases (i) and (ii). Thus the subordinate fibers are two I_1 . \square

Proposition 6.3. *The barking family [IV*.3] splits the singular fiber IV^* as follows:*

$$IV^* \longrightarrow I_6 + I_1 + I_1,$$

where I_6 is the main fiber and the two I_1 are subordinate fibers.

Proof. In the barking family [IV*.3], IV^* is deformed to I_6 :

$$IV^* \xrightarrow{\text{bark}} I_6.$$

By Lemma 3.4, the set of subordinate fibers is one of (i) $\{II\}$, (ii) $\{I_2\}$, and (iii) $\{I_1, I_1\}$. Now Lemma 5.3 (d) eliminates the cases (i) and (ii). Thus the subordinate fibers are two I_1 . \square

Proposition 6.4. *The barking family [I₀*.1] splits the singular fiber I_0^* as follows:*

$$I_0^* \longrightarrow I_4 + I_1 + I_1,$$

where I_4 is the main fiber and the two I_1 are subordinate fibers.

Proof. In the barking family [I₀*.1], I_0^* is deformed to I_4 :

$$I_0^* \longrightarrow I_4.$$

By Lemma 3.4, the set of subordinate fibers is one of (i) $\{II\}$, (ii) $\{I_2\}$, and (iii) $\{I_1, I_1\}$. Now Lemma 5.6 (a) eliminates the cases (i) and (ii). Thus the subordinate fibers are two I_1 . \square

Proposition 6.5. *The barking family [I_n*.2] splits the singular fiber I_n^* as follows:*

$$I_n^* \longrightarrow I_{n+4} + I_1 + I_1,$$

where I_{n+4} is the main fiber and the two I_1 are subordinate fibers.

Proof. In the barking family [I_n*.2], I_n^* is deformed to I_{n+4} :

$$I_n^* \xrightarrow{\text{bark}} I_{n+4}.$$

By Lemma 3.4, the set of subordinate fibers is one of (i) $\{II\}$, (ii) $\{I_2\}$, and (iii) $\{I_1, I_1\}$. Now Lemma 5.3 (e) eliminates the cases (i) and (ii). Thus the subordinate fibers are two I_1 . \square

Remark 6.6. For the barking families [IV.3], [III*.8], [I₀*.2], we cannot determine the subordinate fibers but we can narrow down candidates:

- The splitting of IV induced from the barking family [IV.3] is one of the following:

$$\begin{aligned} IV &\longrightarrow I_2 + II, \\ IV &\longrightarrow I_2 + I_1 + I_1. \end{aligned}$$

In fact, by Lemma 3.4, the set of subordinate fibers is one of (i) $\{II\}$, (ii) $\{I_2\}$, and (iii) $\{I_1, I_1\}$, and Lemma 5.3 (a) eliminates the case (ii).

- The splitting of III^* induced from the barking family $[III^*.8]$ is one of the following:

$$\begin{aligned} III^* &\longrightarrow I_6 + II + I_1, \\ III^* &\longrightarrow I_6 + I_2 + I_1, \\ III^* &\longrightarrow I_6 + I_1 + I_1 + I_1. \end{aligned}$$

In fact, by Lemma 3.5, the set of subordinate fibers is one of (i) $\{III\}$, (ii) $\{I_3\}$, (iii) $\{II, I_1\}$, (iv) $\{I_2, I_1\}$, and (v) $\{I_1, I_1, I_1\}$, and Lemma 5.3 (c) eliminates the cases (i) and (ii).

- The splitting of I_0^* induced from the barking family $[I_0^*.2]$ is one of the following:

$$\begin{aligned} I_0^* &\longrightarrow I_3 + II + I_1, \\ I_0^* &\longrightarrow I_3 + I_1 + I_1 + I_1. \end{aligned}$$

In fact, by Lemma 3.5, the set of subordinate fibers is one of (i) $\{III\}$, (ii) $\{I_3\}$, (iii) $\{II, I_1\}$, (iv) $\{I_2, I_1\}$, and (v) $\{I_1, I_1, I_1\}$, and Lemma 5.6 eliminates the cases (i), (ii) and (iv).

7 Singularities near proportional subbranches

Let $\pi : M \rightarrow \Delta$ be a linear degeneration of complex curves with a stellar singular fiber $X_0 = m_0\Theta_0 + \sum_{j=1}^h \mathbf{Br}^{(j)}$. If there exists a simple crust Y of X_0 , then we can construct a splitting family of $\pi : M \rightarrow \Delta$, which is called a barking family associated with Y (Theorem 2.7). Suppose that $Y = n_0\Theta_0 + \sum_{j=1}^h \mathbf{br}^{(j)}$ is a simple crust of X_0 with barking multiplicity l .

Recall that each subbranch of Y is of type A_l , B_l or C_l . A subbranch $\overline{\mathbf{br}}^{(j)}$ is said to be *proportional* if $m_0 n_1^{(j)} = n_0 m_1^{(j)}$ (equivalently $n_0/m_0 = n_1^{(j)}/m_1^{(j)} = \dots = n_\nu^{(j)}/m_\nu^{(j)}$). Note that every proportional subbranch of simple crusts is of type A_l . Indeed, any proportional subbranch of type B_l is of type A_l , and no proportional subbranch is of type C_l . Moreover every proportional subbranch $\overline{\mathbf{br}}^{(j)}$ has the same length as that of $\overline{\mathbf{Br}}^{(j)}$ (that is, $\nu^{(j)} = \lambda^{(j)}$) and satisfies $n_{\lambda^{(j)}+1} = 0$.

The following lemma is important ([Ta3] Proposition 16.2.6):

Lemma 7.1. *Suppose that $\Psi : \mathcal{M} \rightarrow \Delta \times \Delta^\dagger$ is a barking family of the degeneration $\pi : M \rightarrow \Delta$ associated with a simple crust Y . Then any subordinate fiber of Ψ is a reduced curve only with A -singularities⁶. Moreover these singularities lie (i) near the core or (ii) near the edge⁷ of each proportional subbranch if it exists.*

⁶ An A -singularity is a singularity analytically equivalent to $y^2 = x^{\mu+1}$ for some positive integer μ .

⁷ To be precise, near the ‘terminal’ irreducible component $\Theta_{\lambda^{(j)}}$ of the branch $\mathbf{Br}^{(j)}$ corresponding to each proportional subbranch $\mathbf{br}^{(j)}$.

Remark 7.2. By Lemma 7.1, every subordinate fiber in barking families is a reduced curve only with isolated singularities. In particular, for degenerations of elliptic curves, none of mI_n ($m \geq 2$), IV^* , III^* , II^* , mI_n^* ($m \geq 2$) appears as a subordinate fiber.

The rest of this section investigates the singularities of subordinate fibers near a proportional subbranch. Let $\pi : M \rightarrow \Delta$ be a linear degeneration of complex curves with a stellar singular fiber X_0 and $\Psi : \mathcal{M} \rightarrow \Delta \times \Delta^\dagger$ be a barking family associated with a simple crust Y with barking multiplicity l . Suppose that Y has a proportional subbranch \mathbf{br} of a branch \mathbf{Br} of X_0 . First recall that near the branch \mathbf{Br} , \mathcal{M} is given by the following data (see [Ta3] Chapter 7): for $i = 1, 2, \dots, \lambda$,

$$\begin{cases} \mathcal{H}_i : w_i^{m_i-1-ln_i-1} \eta_i^{m_i-ln_i} (w_i^{n_i-1} \eta_i^{n_i} + t^d f_i)^l - s = 0, \\ \quad \text{in } U_i \times \mathbb{C} \times \Delta \times \Delta^\dagger, \\ \mathcal{H}'_i : z_i^{m_i+1-ln_i+1} \zeta_i^{m_i-ln_i} (z_i^{n_i+1} \zeta_i^{n_i} + t^d \hat{f}_i)^l - s = 0, \\ \quad \text{in } V_i \times \mathbb{C} \times \Delta \times \Delta^\dagger. \end{cases}$$

Note that, substituting $t = 0$ into these equations, we obtain

$$\begin{cases} \mathcal{H}_i|_{t=0} : w_i^{m_i-1} \eta_i^{m_i} - s = 0, \\ \mathcal{H}'_i|_{t=0} : z_i^{m_i+1} \zeta_i^{m_i} - s = 0, \end{cases}$$

which are the local expressions of M near \mathbf{Br} . See the proof of Lemma 2.3. For a fixed $(s, t) \in \Delta \times \Delta^\dagger$, we consider the fiber $X_{s,t} = \Psi^{-1}(s, t)$ of Ψ . The following is required ([Ta3] Section 7.2):

Lemma 7.3. *Let m, n, l be positive integers satisfying $m - ln > 0$ and m', n' be nonnegative integers satisfying $m' - ln' \geq 0$. Set $h(z, \zeta) := f(z^{p'} \zeta^p)$ for a non-vanishing holomorphic function f and positive integers p, p' ($p < p'$). Then a complex curve $C_{s,t}$ in \mathbb{C}^2 defined by*

$$C_{s,t} : z^{m'-ln'} \zeta^{m-ln} (z^{n'} \zeta^n + th)^l - s = 0$$

is singular if and only if

(i) $s = 0$ or

(ii) $m' = n' = 0$ and $\left(\frac{ln-m}{ln}\right)^{\bar{ln}} s^{\bar{n}} = \left(\frac{ln-m}{m} tc\right)^{\bar{m}}$,

where $c := h(0, 0)$ and \bar{m} and \bar{n} are the relatively prime integers satisfying $\bar{n}/\bar{m} = n/m$. In the case (ii), $(z, \zeta) \in C_{s,t}$ is a singularity exactly when

$$z = 0 \quad \text{and} \quad \zeta^n = \frac{ln-m}{m} tc.$$

Since \mathbf{br} is proportional, we have $m_{\lambda+1} = n_{\lambda+1} = 0$, so

$$\mathcal{H}'_{\lambda}|_{s,t} : \zeta_{\lambda}^{m_{\lambda}-ln_{\lambda}} \left(\zeta_{\lambda}^{n_{\lambda}} + t^d \hat{f}_{\lambda} \right)^l - s = 0.$$

Lemma 7.3 ensures that for some (s, t) ($s, t \neq 0$), the curve $\mathcal{H}'_{\lambda}|_{s,t}$ has singularities. In what follows, we write $m := m_{\lambda}$ and $n := n_{\lambda}$, and denote by \bar{m} and \bar{n} the relatively prime integers satisfying $\bar{n}/\bar{m} = n/m$.

For a fixed $t \neq 0$, the equation

$$\left(\frac{ln - m}{ln} \right)^{\bar{n}} s^{\bar{n}} = \left(\frac{ln - m}{m} t^d c \right)^{\bar{m}}$$

for s has \bar{n} solutions, say, $s_1, s_2, \dots, s_{\bar{n}}$. Since $(0, \zeta)$ satisfying $\zeta^n = \frac{ln-m}{m} t^d c$ is a singularity of $\mathcal{H}'_{\lambda}|_{s_k, t}$ for some s_k , each $\mathcal{H}'_{\lambda}|_{s_k, t}$ has n/\bar{n} ($= \gcd(m, n)$) singularities.

The above result is summarized as follows:

Proposition 7.4. *Let $\pi : M \rightarrow \Delta$ be a linear degeneration of complex curves with a stellar singular fiber X_0 and let $\Psi : \mathcal{M} \rightarrow \Delta \times \Delta^{\dagger}$ be a barking family associated with a simple crust Y with barking multiplicity l . Suppose that Y has a proportional subbranch $\mathbf{br}^{(j)}$ of a branch $\mathbf{Br}^{(j)}$ of X_0 . Write $\overline{\mathbf{Br}}^{(j)} := m_0 \Delta_0 + m_1 \Theta_1 + m_2 \Theta_2 + \dots + m_{\lambda} \Theta_{\lambda}$ and $\overline{\mathbf{br}}^{(j)} := n_0 \Delta_0 + n_1 \Theta_1 + n_2 \Theta_2 + \dots + n_{\lambda} \Theta_{\lambda}$ and let \bar{m} and \bar{n} be the relatively prime positive integers satisfying $\bar{n}/\bar{m} = n_{\lambda}/m_{\lambda}$. Then in the deformation $\pi_t : M_t \rightarrow \Delta_t$ for a fixed $t \neq 0$, there exist \bar{n} subordinate fibers that have singularities near the edge of $\mathbf{Br}^{(j)}$. Moreover, each of these subordinate fibers has n/\bar{n} ($= \gcd(m, n)$) singularities near the edge of $\mathbf{Br}^{(j)}$.*

8 Singularities near the core

We next investigate the singularities of subordinate fibers near the core.

Let $\pi : M \rightarrow \Delta$ be a linear degeneration of complex curves with a stellar singular fiber $X_0 = m_0 \Theta_0 + \sum_{j=1}^h \mathbf{Br}^{(j)}$ and let $\Psi : \mathcal{M} \rightarrow \Delta \times \Delta^{\dagger}$ be a barking family of the degeneration $\pi : M \rightarrow \Delta$ associated with a simple crust $Y = n_0 \Theta_0 + \sum_{j=1}^h \mathbf{br}^{(j)}$. Write $\overline{\mathbf{Br}}^{(j)} = m_0 \Delta_0^{(j)} + m_1^{(j)} \Theta_1^{(j)} + \dots + m_{\lambda}^{(j)} \Theta_{\lambda}^{(j)}$, $\overline{\mathbf{br}}^{(j)} = n_0 \Delta_0^{(j)} + n_1^{(j)} \Theta_1^{(j)} + \dots + n_{\nu}^{(j)} \Theta_{\nu}^{(j)}$ and let $p^{(j)}$ be the attachment point on Θ_0 with $\mathbf{Br}^{(j)}$. For brevity, we assume that the subbranches $\overline{\mathbf{br}}^{(1)}, \overline{\mathbf{br}}^{(2)}, \dots, \overline{\mathbf{br}}^{(v)}$ are proportional and $\overline{\mathbf{br}}^{(v+1)}, \overline{\mathbf{br}}^{(v+2)}, \dots, \overline{\mathbf{br}}^{(h)}$ are not.

Let N_0 be the normal bundle of Θ_0 in M . Recall that the local expression of \mathcal{M} near the core Θ_0 is given by

$$\sigma(z) \zeta^{m_0} - s + \sum_{k=1}^l {}_l C_k t^{kd} \sigma(z) \tau(z)^k \zeta^{m_0 - kn_0} = 0 \quad \text{in } N_0 \times \Delta \times \Delta^{\dagger},$$

equivalently

$$\sigma(z) \zeta^{m_0 - ln_0} \left(\zeta^{n_0} + t^d \tau(z) \right)^l - s = 0,$$

where σ is the standard section of $N_0^{\otimes(-m_0)}$ and τ is a core section of $N_0^{\otimes n_0}$ for Y (see [Ta3] Chapter 16). Substituting $t = 0$ into this equation, we obtain

$$\sigma(z)\zeta^{m_0} - s = 0 \quad \text{in } N_0 \times \Delta \times \{0\},$$

which is the local expression of M around Θ_0 . See the paragraph subsequent to Remark 2.2. Note that σ has a zero of order $m_1^{(j)}$ at $p^{(j)}$, while τ has a pole of order $n_1^{(j)}$ at $p^{(j)}$. Suppose that τ has a zero of order a_i at q_i ($i = 1, 2, \dots, k$) on Θ_0 .

Fixing $s, t \neq 0$, consider a fiber $X_{s,t} := \Psi^{-1}(s, t)$ of $\Psi : \mathcal{M} \rightarrow \Delta \times \Delta^\dagger$. Set $F := \sigma(z)\zeta^{m_0 - ln_0} (\zeta^{n_0} + t^d \tau(z))^l$. Then $(z, \zeta) \in X_{s,t}$ is a singularity if and only if

$$\frac{\partial}{\partial z} F(z, \zeta) = \frac{\partial}{\partial \zeta} F(z, \zeta) = 0,$$

equivalently

$$\begin{cases} \zeta^{m_0 - ln_0} (\zeta^{n_0} + t^d \tau(z))^{l-1} \{ \sigma_z(z) \zeta^{n_0} + t^d (\sigma_z(z) \tau(z) + l \sigma(z) \tau_z(z)) \} \\ \hspace{15em} = 0, \\ \zeta^{m_0 - ln_0 - 1} (\zeta^{n_0} + t^d \tau(z))^{l-1} \sigma(z) (m_0 \zeta^{n_0} + (m_0 - ln_0) t^d \tau(z)) = 0, \end{cases}$$

where $\sigma_z := \frac{d}{dz} \sigma$ and $\tau_z = \frac{d}{dz} \tau$. Set $K(z) := n_0 \sigma_z(z) \tau(z) + m_0 \sigma(z) \tau_z(z)$, which is called the *plot function*⁸. Then the above equations hold precisely when

$$\begin{cases} K(z) = 0, & \sigma(z) \neq 0, & \tau(z) \neq 0, \\ \zeta^{n_0} = \frac{ln_0 - m_0}{m_0} t^d \tau(z). \end{cases}$$

In particular, whether $(z, \zeta) \in X_{s,t}$ is a singularity does *not* depend on s . Noting that every point (z, ζ) in $X_{s,t}$ satisfies

$$\sigma(z)\zeta^{m_0 - ln_0} (\zeta^{n_0} + t^d \tau(z))^l - s = 0,$$

s is given by

$$\begin{aligned} s &= \sigma(z)\zeta^{m_0 - ln_0} (\zeta^{n_0} + t^d \tau(z))^l \\ &= \sigma(z)\zeta^{m_0 - ln_0} \left\{ \zeta^{n_0} + \left(\frac{m_0}{ln_0 - m_0} \zeta^{n_0} \right) \right\}^l \\ &= \left(\frac{ln_0}{ln_0 - m_0} \right)^l \sigma(z)\zeta^{m_0}. \end{aligned}$$

Hence:

⁸ Note that $K(z)$ is *not* a function on Θ_0 but a meromorphic section of a line bundle $N_0^{\otimes(n-m)} \otimes \Omega_{\Theta_0}^1$ on Θ_0 , where $\Omega_{\Theta_0}^1$ is the cotangent bundle of Θ_0 .

Lemma 8.1. Fix $t \neq 0$. A point $(z, \zeta) \in N_0$ is a singularity of some subordinate fiber $X_{s,t}$ of the deformation $\pi_t : M_t \rightarrow \Delta_t$ if and only if the following condition is satisfied:

$$\begin{cases} K(z) = 0, & \sigma(z) \neq 0, & \tau(z) \neq 0, \\ \zeta^{n_0} = \frac{ln_0 - m_0}{m_0} t^d \tau(z). \end{cases}$$

In this case, the following holds:

$$s = \left(\frac{ln_0}{ln_0 - m_0} \right)^l \sigma(z) \zeta^{m_0}.$$

We call a zero α of the plot function $K(z)$ an *essential zero* if $\sigma(\alpha) \neq 0$ and $\tau(\alpha) \neq 0$. For an essential zero α of $K(z)$, Lemma 8.1 implies that $(\alpha, \beta) \in N_0$ is a singularity of a subordinate fiber $X_{s,t}$ if and only if

$$\begin{cases} \beta^{n_0} = \frac{ln_0 - m_0}{m_0} t^d \tau(\alpha), \\ s = \left(\frac{ln_0}{ln_0 - m_0} \right)^l \sigma(\alpha) \beta^{m_0}. \end{cases}$$

Eliminating β , we have

$$s^{\bar{n}_0} = \left(\frac{ln_0}{ln_0 - m_0} \right)^{\bar{l}n_0} \left(\frac{ln_0 - m_0}{m_0} \right)^{\bar{m}_0} t^{d\bar{m}_0} \sigma(\alpha)^{\bar{n}_0} \tau(\alpha)^{\bar{m}_0},$$

where \bar{m}_0 and \bar{n}_0 are the relatively prime integers satisfying $\bar{n}_0/\bar{m}_0 = n_0/m_0$. This equation for s has \bar{n}_0 solutions, say, $s_1, s_2, \dots, s_{\bar{n}_0}$. Observe that the equation

$$\beta^{n_0} = \frac{ln_0 - m_0}{m_0} t^d \tau(\alpha)$$

for β has n_0 solutions, say $\beta_1, \beta_2, \dots, \beta_{n_0}$. Then $n_0/\bar{n}_0 (= \gcd(m_0, n_0))$ points among $(\alpha, \beta_1), (\alpha, \beta_2), \dots, (\alpha, \beta_{n_0})$ lie on one of the subordinate fibers $X_{s_1,t}, X_{s_2,t}, \dots, X_{s_{\bar{n}_0},t}$.

Lemma 8.2. Let α be an essential zero of $K(z)$. Then:

(a) There exist \bar{n}_0 subordinate fibers $X_{s_1,t}, X_{s_2,t}, \dots, X_{s_{\bar{n}_0},t}$ that have singularities with z -coordinate α . (In fact, $s_1, s_2, \dots, s_{\bar{n}_0}$ are given as the solutions of the following equation for s :

$$s^{\bar{n}_0} = \left(\frac{ln_0}{ln_0 - m_0} \right)^{\bar{l}n_0} \left(\frac{ln_0 - m_0}{m_0} \right)^{\bar{m}_0} t^{d\bar{m}_0} \sigma(\alpha)^{\bar{n}_0} \tau(\alpha)^{\bar{m}_0}.)$$

(b) Moreover the number of such singularities on each of these subordinate fibers is n_0/\bar{n}_0 .

Next we write $K(z) = \sigma\tau\omega$, where $\omega(z) := \frac{d \log(\sigma^{n_0} \tau^{m_0})}{dz}$. Here ω is a meromorphic section of the cotangent bundle $\Omega_{\Theta_0}^1$ on Θ_0 . Recall the assumption that the subbranches $\overline{\mathbf{br}}^{(j)}$ ($j = 1, 2, \dots, v$) are proportional (so $m_0 n_1^{(j)} - m_1^{(j)} n_0 = 0$) and the others are not. Then $\omega(z)$ is holomorphic at $p^{(1)}, p^{(2)}, \dots, p^{(v)}$, whereas

$\omega(z)$ has a pole of order 1 at $p^{(v+1)}, p^{(v+2)}, \dots, p^{(h)}$. On the other hand, $\omega(z)$ has a pole of order 1 at q_1, q_2, \dots, q_k (which are zeros of the core section τ). Moreover

$$\begin{cases} K(z) = 0, \\ \sigma(z) \neq 0, \\ \tau(z) \neq 0 \end{cases} \iff \begin{cases} \omega(z) = 0, \\ z \notin \{p^{(1)}, p^{(2)}, \dots, p^{(v)}\}. \end{cases}$$

Lemma 8.3 ([Ta3] Lemma 21.3.5). *Let g_0 denote the genus of the core Θ_0 . Then*

$$\sum_{K(\alpha)=0, \sigma(\alpha) \neq 0, \tau(\alpha) \neq 0} \text{ord}_\alpha(K(z)) = (h - v) + k + (2g_0 - 2) - \sum_{j=1}^v \text{ord}_{p^{(j)}}(\omega).$$

We set $\chi := (h - v) + k + (2g_0 - 2) - \sum_{j=1}^v \text{ord}_{p^{(j)}}(\omega)$, which is called the *core invariant*.

Corollary 8.4. *Let κ denote the number of essential zeros of $K(z)$. Then we have*

$$\kappa \leq \chi,$$

where the equality holds precisely when the order of any essential zero of $K(z)$ equals 1.

Proof. For any essential zero α of the plot function $K(z)$ we have

$$\text{ord}_\alpha(K(z)) \geq 1,$$

thus

$$\sum_{K(\alpha)=0, \sigma(\alpha) \neq 0, \tau(\alpha) \neq 0} \text{ord}_\alpha(K(z)) \geq \kappa.$$

From Lemma 8.3, the left hand side of this inequality is equal to the core invariant χ , which confirms the assertion. \square

Let $\alpha_1, \alpha_2, \dots, \alpha_\kappa$ be the essential zeros of $K(z)$, where κ is the number of essential zeros of $K(z)$. By Lemma 8.2 (a), for each α_i , there exist \bar{n}_0 subordinate fibers that have singularities with z -coordinate α_i , and their singular values are given by

$$s^{\bar{n}_0} = \left(\frac{ln_0}{ln_0 - m_0} \right)^{\bar{n}_0} \left(\frac{ln_0 - m_0}{m_0} \right)^{\bar{m}_0} t^{d\bar{m}_0} \sigma(\alpha_i)^{\bar{n}_0} \tau(\alpha_i)^{\bar{m}_0}.$$

Thus, if α_i and α_j satisfy

$$\sigma(\alpha_i)^{\bar{n}_0} \tau(\alpha_i)^{\bar{m}_0} = \sigma(\alpha_j)^{\bar{n}_0} \tau(\alpha_j)^{\bar{m}_0},$$

then the the singularities with z -coordinate α_i and α_j lie on the *same* subordinate fiber. We denote by $\bar{\kappa}$ the number of the distinct values of the set $\{\sigma(\alpha_i)^{\bar{n}_0} \tau(\alpha_i)^{\bar{m}_0} : i = 1, 2, \dots, \kappa\}$. Then for a fixed $t \neq 0$, the deformation $\pi_t : M_t \rightarrow \Delta_t$ has exactly $\bar{n}_0 \bar{\kappa}$ subordinate fibers that have singularities near the core. This result together with Lemma 8.2 and Corollary 8.4 confirms the following:

Proposition 8.5. *Let us consider the deformation $\pi_t : M_t \rightarrow \Delta_t$ of $\pi : M \rightarrow \Delta$ for a fixed $t \neq 0$. Then we have the following.*

$$(a) \left(\begin{array}{l} \text{The number of subordinate fibers in } M_t \\ \text{that have singularities near } \Theta_0 \end{array} \right) \leq \bar{n}_0 \chi.$$

Here the equality holds precisely when the order of any essential zero equals 1 and $\bar{\kappa} = \kappa$.

$$(b) \left(\begin{array}{l} \text{The number of singularities near } \Theta_0 \\ \text{on each subordinate fiber in } M_t \end{array} \right) \leq \frac{n_0}{\bar{n}_0} \chi.$$

Here the equality holds precisely when the order of any essential zero equals 1 and $\bar{\kappa} = 1$.

9 Constraints from the numbers of singularities

In this section, we show two useful lemmas which give us the number of the subordinate fibers and that of their singularities. See Lemmas 9.2 and 9.4.

Let $\pi : M \rightarrow \Delta$ be a linear degeneration of complex curves with a stellar singular fiber $X_0 = m_0 \Theta_0 + \sum_{j=1}^h \mathbf{Br}^{(j)}$. Suppose that X_0 has a simple crust $Y = n_0 \Theta_0 + \sum_{j=1}^h \mathbf{br}^{(j)}$ of with barking multiplicity l . For brevity, we assume that the subbranches $\overline{\mathbf{br}}^{(1)}, \overline{\mathbf{br}}^{(2)}, \dots, \overline{\mathbf{br}}^{(v)}$ are proportional and the others are not (so v is the number of the proportional subbranches). Let $\Psi : \mathcal{M} \rightarrow \Delta \times \Delta^\dagger$ be a barking family of $\pi : M \rightarrow \Delta$ associated with Y . We define the core invariant of Y as

$$\chi := (h - v) + k + (2g_0 - 2) - \sum_{j=1}^v \text{ord}_{p^{(j)}}(\omega),$$

where g_0 is the genus of the core Θ_0 and $\omega := \frac{d}{dz} \log(\sigma^{n_0} \tau^{m_0})$.

First we assume that Y has no proportional subbranches. Since $v = 0$, we have $\chi = h + k + (2g_0 - 2)$. Then Lemma 7.1 ensures that the subordinate fibers have singularities only near the core.

Lemma 9.1. *Suppose that Y has no proportional subbranch. Set $c := \text{gcd}(m_0, n_0)$ and $\bar{n}_0 := n_0/c$. If $\chi = 1$, then for a fixed $t \neq 0$, we have the following.*

(a) $\pi_t : M_t \rightarrow \Delta_t$ has exactly \bar{n}_0 subordinate fibers.

(b) Each subordinate fiber of $\pi_t : M_t \rightarrow \Delta_t$ has c singularities.

(c) The number of singularities of all the subordinate fibers of $\pi_t : M_t \rightarrow \Delta_t$ is n_0 .

Proof. First note that the plot function $K(z)$ has at least one essential zero. Otherwise, from Lemma 8.1, there would exist no singularities around the core, which implies that $\pi_t : M_t \rightarrow \Delta_t$ has no subordinate fibers. Accordingly

$$1 \leq (\text{the number of essential zeros of } K(z)).$$

On the other hand, Corollary 8.4 states that

$$(\text{the number of essential zeros of } K(z)) \leq \chi.$$

From the assumption $\chi = 1$, we obtain

$$(\text{the number of essential zeros of } K(z)) = 1.$$

Namely $K(z)$ has exactly one zero of order 1. By Proposition 8.5, we have

$$\begin{aligned} (\text{the number of subordinate fibers of } \pi_t : M_t \rightarrow \Delta_t) &= \bar{n}_0, \\ (\text{the number of singularities on each subordinate fiber}) &= c, \end{aligned}$$

confirming (a) and (b).

(c) clearly follows from (a) and (b). \square

In particular:

Lemma 9.2. *Suppose that (i) Θ_0 is a complex projective line, (ii) X_0 has three branches, (iii) the core section τ has no zero and (iv) Y has no proportional subbranches. Set $c := \gcd(m_0, n_0)$ and $\bar{n}_0 := n_0/c$. Then for a fixed $t \neq 0$, we have the following.*

(a) $\pi_t : M_t \rightarrow \Delta_t$ has exactly \bar{n}_0 subordinate fibers.

(b) Each subordinate fiber of $\pi_t : M_t \rightarrow \Delta_t$ has c singularities.

(c) The number of singularities of all the subordinate fibers of $\pi_t : M_t \rightarrow \Delta_t$ is n_0 .

Proof. By assumption, we have $g_0 = 0$, $h = 3$, $k = 0$, and so $\chi = 1$. Hence Lemma 9.1 confirms the assertion. \square

Remark 9.3. By Lemma 2.6, we can restate the condition (iii) of Lemma 9.2 as “ $r_0 = r'_0$,” where $r_0 := \sum_{j=1}^h m_1^{(j)}/m_0$ and $r'_0 := \sum_{j=1}^h n_1^{(j)}/n_0$.

Next we assume that Y has a proportional subbranch.

Lemma 9.4. *Suppose that (i) Θ_0 is a complex projective line, (ii) X_0 has three branches, (iii) the core section τ has no zero and (iv) Y has a proportional subbranch $\overline{\mathbf{br}}^{(1)} = n_0\Delta_0 + n_1\Theta_1 + n_2\Theta_2 + \cdots + n_\lambda\Theta_\lambda$ of $\overline{\mathbf{Br}}^{(1)}$. Then $\overline{\mathbf{br}}^{(1)}$ is the unique proportional subbranch of Y (that is, $v = 1$). Moreover for a fixed $t \neq 0$, we have the following.*

(a) $\pi_t : M_t \rightarrow \Delta_t$ has exactly \bar{n}_λ subordinate fibers.

(b) Each subordinate fiber of $\pi_t : M_t \rightarrow \Delta_t$ has c singularities.

(c) The number of singularities of all the subordinate fibers of $\pi_t : M_t \rightarrow \Delta_t$ is n_λ .

Here $c := \gcd(m_\lambda, n_\lambda)$ and $\bar{n}_\lambda := n_\lambda/c$.

Proof. By assumption, we have $g_0 = 0$, $h = 3$, $k = 0$. Thus

$$\chi = 1 - v - \sum_{j=1}^v \text{ord}_{p^{(j)}}(\omega),$$

so

$$\chi + \sum_{j=1}^v (\text{ord}_{p^{(j)}}(\omega) + 1) = 1.$$

Recall that $\omega(z)$ is holomorphic at $p^{(j)}$ for $j = 1, 2, \dots, v$, that is, $\text{ord}_{p^{(j)}}(\omega) \geq 0$. Noting that $\chi \geq 0$ and $v \geq 1$, we deduce that $\chi = 0$, $v = 1$ and $\text{ord}_{p^{(1)}}(\omega) = 0$. Hence $\overline{\mathbf{br}}^{(1)}$ is the unique proportional subbranch. Since $\chi = 0$, from Proposition 8.5, every subordinate fiber of $\pi_t : M_t \rightarrow \Delta$ has no singularities near the core Θ_0 . Therefore Proposition 7.4 confirms (a), (b) and (c). \square

10 Determination of the subordinate fibers, 2

We now determine the subordinate fibers of the remaining barking families.

We first consider barking families whose simple crust has *no* proportional subbranches. In the barking family [III.2], III is deformed to I_1 :

$$III \xrightarrow{\text{bark}} I_1.$$

By Lemma 3.4, the set of subordinate fibers is one of (i) $\{II\}$, (ii) $\{I_2\}$, and (iii) $\{I_1, I_1\}$. Note that the simple crust for this family has no proportional subbranches. See [III.2] of the list in Section 12. Applying Lemma 9.2, since $c = 2$ and $\bar{n}_0 = 1$, we deduce that there appears exactly one subordinate fiber and it has two singularities. This condition is satisfied only for the case (ii). Hence:

Proposition 10.1. *The barking family [III.2] splits the singular fiber III as follows:*

$$III \longrightarrow I_1 + I_2,$$

where I_1 is the main fiber and I_2 is a subordinate fiber.

Similarly:

Proposition 10.2. *The barking family [III*.2] splits the singular fiber III* as follows:*

$$III^* \longrightarrow I_1^* + I_2,$$

where I_1 is the main fiber and I_2 is a subordinate fiber.

In the barking family [IV.2], IV is deformed to I_2 :

$$IV \xrightarrow{\text{bark}} I_2.$$

By Lemma 3.4, the set of subordinate fibers is one of (i) $\{II\}$, (ii) $\{I_2\}$, and (iii) $\{I_1, I_1\}$. Applying Lemma 9.2, since $c = 1$ and $\bar{n}_0 = 2$, we deduce that there appear two subordinate fibers and each of them has one singularity. This condition is satisfied only for the case (iii). Hence:

Proposition 10.3. *The barking family [IV.2] splits the singular fiber IV as follows:*

$$IV \longrightarrow I_2 + I_1 + I_1,$$

where I_2 is the main fiber and the two I_1 are subordinate fibers.

Similarly:

Proposition 10.4. *The barking family [IV*.2] splits the singular fiber IV* as follows:*

$$IV^* \longrightarrow I_0^* + I_1 + I_1,$$

where I_0^* is the main fiber and the two I_1 are subordinate fibers.

In the barking family [III*.4], III* is deformed to I_0^* :

$$III^* \xrightarrow{\text{bark}} I_0^*.$$

By Lemma 3.5, the set of subordinate fibers is one of (i) $\{III\}$, (ii) $\{I_3\}$, (iii) $\{II, I_1\}$, (iv) $\{I_2, I_1\}$, and (v) $\{I_1, I_1, I_1\}$. Applying Lemma 9.2, since $c = 1$ and $\bar{n}_0 = 3$, we deduce that there appear three subordinate fibers and each of them has one singularity. This condition is satisfied only for the case (v). Hence:

Proposition 10.5. *The barking family [III*.4] splits the singular fiber III* as follows:*

$$III^* \longrightarrow I_0^* + I_1 + I_1 + I_1,$$

where I_0^* is the main fiber and the three I_1 are subordinate fibers.

Similarly:

Proposition 10.6. *The barking family [III*.5] splits the singular fiber III* as follows:*

$$III^* \longrightarrow I_6 + I_1 + I_1 + I_1,$$

where I_6 is the main fiber and the three I_1 are subordinate fibers.

In the barking family [II*.4], II* is deformed to I_5 :

$$II^* \xrightarrow{\text{bark}} I_5.$$

By Lemma 3.6, the sum of the Euler characteristics of the subordinate fibers is 5. Applying Lemma 9.2, since $c = 1$ and $\bar{n}_0 = 5$, we deduce that there appear five subordinate fibers and each of them has one singularity. Hence:

Proposition 10.7. *The barking family [II*.4] splits the singular fiber II* as follows:*

$$II^* \longrightarrow I_5 + I_1 + I_1 + I_1 + I_1 + I_1,$$

where I_5 is the main fiber and the five I_1 are subordinate fibers.

In the following cases, the simple crust has a proportional subbranch. In the barking family $[II^*.2]$, II^* is deformed to IV^* :

$$II^* \xrightarrow{\text{bark}} IV^*.$$

By Lemma 3.4, the set of subordinate fibers is one of (i) $\{II\}$, (ii) $\{I_2\}$, and (iii) $\{I_1, I_1\}$. Note that the simple crust for this family has a proportional subbranch of length 2. See $[II^*.2]$ of the list in Section 12. Applying Lemma 9.4, since $c = 1$ and $\bar{n}_2 = 1$, we deduce that there appears exactly one subordinate fiber and it has one singularity. This condition is satisfied only for the case (i). Hence:

Proposition 10.8. *The barking family $[II^*.2]$ splits the singular fiber II^* as follows:*

$$II^* \longrightarrow IV^* + II,$$

where IV^* is the main fiber and II is a subordinate fiber.

In the barking family $[II^*.3]$, II^* is deformed to I_2^* :

$$II^* \xrightarrow{\text{bark}} I_2^*.$$

By Lemma 3.4, the set of subordinate fibers is one of (i) $\{II\}$, (ii) $\{I_2\}$, and (iii) $\{I_1, I_1\}$. Note that the simple crust for this family has a proportional subbranch of length 1. See $[II^*.3]$ of the list in Section 12. Applying Lemma 9.4, since $c = 1$ and $\bar{n}_1 = 2$, we deduce that there appear two subordinate fibers and each of them has one singularity. This condition is satisfied only for the case (iii). Hence:

Proposition 10.9. *The barking family $[II^*.3]$ splits the singular fiber II^* as follows:*

$$II^* \longrightarrow I_2^* + I_1 + I_1,$$

where I_2^* is the main fiber and the two I_1 are subordinate fibers.

We summarize Propositions 3.3, 6.1–6.5, 10.1–10.9 as follows:

Theorem 10.10. *Each barking family in Takamura's list (1.1) except $[III^*.8]$,*

[**IV.3**], [**IV.4**], [**I₀^{*}.2**] splits the singular fiber as follows:

$$\begin{array}{ll}
[\mathbf{II.1}] \ II \longrightarrow I_1 + I_1 & [\mathbf{III^*.2}] \ III^* \longrightarrow I_1^* + I_2 \\
[\mathbf{II.2}] \ II \longrightarrow I_1 + I_1 & [\mathbf{III^*.3}] \ III^* \longrightarrow I_2^* + I_1 \\
[\mathbf{II^*.1}] \ II^* \longrightarrow III^* + I_1 & [\mathbf{III^*.4}] \ III^* \longrightarrow I_0^* + I_1 + I_1 + I_1 \\
[\mathbf{II^*.2}] \ II^* \longrightarrow IV^* + II & [\mathbf{III^*.5}] \ III^* \longrightarrow I_6 + I_1 + I_1 + I_1 \\
[\mathbf{II^*.3}] \ II^* \longrightarrow I_2^* + I_1 + I_1 & [\mathbf{III^*.6}] \ III^* \longrightarrow I_2^* + I_1 \\
[\mathbf{II^*.4}] \ II^* \longrightarrow I_5 & [\mathbf{III^*.7}] \ III^* \longrightarrow I_7 + I_1 + I_1 \\
& + I_1 + I_1 + I_1 + I_1 + I_1 & [\mathbf{III^*.9}] \ III^* \longrightarrow IV^* + I_1 \\
[\mathbf{II^*.5}] \ II^* \longrightarrow I_3^* + I_1 & [\mathbf{IV.1}] \ IV \longrightarrow I_3 + I_1 \\
[\mathbf{II^*.6}] \ II^* \longrightarrow I_3^* + I_1 & [\mathbf{IV.2}] \ IV \longrightarrow I_2 + I_1 + I_1 \\
[\mathbf{II^*.7}] \ II^* \longrightarrow I_8 + I_1 + I_1 & [\mathbf{IV^*.1}] \ IV^* \longrightarrow I_1^* + I_1 \\
[\mathbf{II^*.8}] \ II^* \longrightarrow III^* + I_1 & [\mathbf{IV^*.2}] \ IV^* \longrightarrow I_0^* + I_1 + I_1 \\
[\mathbf{II^*.9}] \ II^* \longrightarrow III^* + I_1 & [\mathbf{IV^*.3}] \ IV^* \longrightarrow I_6 + I_1 + I_1 \\
[\mathbf{III.1}] \ III \longrightarrow I_2 + I_1 & [\mathbf{IV^*.4}] \ IV^* \longrightarrow I_1^* + I_1 \\
[\mathbf{III.2}] \ III \longrightarrow I_1 + I_2 & [\mathbf{I_0^*.1}] \ I_0^* \longrightarrow I_4 + I_1 + I_1 \\
[\mathbf{III.3}] \ III \longrightarrow I_2 + I_1 & [\mathbf{I_n^*.1}] \ I_n^* \longrightarrow I_{n-1}^* + I_1 \\
[\mathbf{III^*.1}] \ III^* \longrightarrow IV^* + I_1 & [\mathbf{I_n^*.2}] \ I_n^* \longrightarrow I_{n+4} + I_1 + I_1.
\end{array}$$

11 Supplement: Monodromy decompositions

In this section, we give decompositions of the standard monodromy matrices corresponding to the splittings of the singular fibers induced by Takamura's barking families. Recall that $SL(2, \mathbb{Z})$ is generated by

$$s_0 = \begin{pmatrix} 1 & 1 \\ 0 & 1 \end{pmatrix} \quad \text{and} \quad s_2 = \begin{pmatrix} 1 & 0 \\ -1 & 1 \end{pmatrix}.$$

Note that, since $s_0 s_2 s_0 = s_2 s_0 s_2$, we have

$$s_2 = (s_0 s_2) s_0 (s_0 s_2)^{-1}.$$

Decomposition of A_{II} The standard monodromy matrix of II is $A_{II} = s_0 s_2$. A_{II} is decomposed into two conjugacies of A_{I_1} as follows:

$$A_{II} = s_0 s_2 = A_{I_1} \cdot (s_0 s_2) A_{I_1} (s_0 s_2)^{-1}.$$

In fact, the splitting $II \longrightarrow I_1 + I_1$ occurs in the barking families [**II.1**] and [**II.2**].

Decomposition of A_{III} The standard monodromy matrix of III is $A_{III} = s_0 s_2 s_0$. A_{III} is decomposed into A_{I_2} and a conjugacy of A_{I_1} :

$$A_{III} = s_0 s_2 s_0 = s_0^2 (s_0^{-1} s_2 s_0) = A_{I_2} \cdot s_2 A_{I_1} s_2^{-1}.$$

In fact, the splitting $III \rightarrow I_2 + I_1$ occurs in the barking families [**III.1**], [**III.2**], [**III.3**].

A_{III} has other monodromy decompositions as follows (but we have not found barking families that admit the corresponding splittings):

$$\begin{aligned} A_{III} &= (s_0 s_2) s_0 = A_{II} \cdot A_{I_1}, \\ &\quad (III \rightarrow II + I_1) \\ A_{III} &= s_0 s_2 s_0 = A_{I_1} \cdot (s_0 s_2) A_{I_1} (s_0 s_2)^{-1} \cdot A_{I_1}, \\ &\quad (III \rightarrow I_1 + I_1 + I_1) \end{aligned}$$

Decomposition of A_{IV} The standard monodromy matrix of IV is $A_{IV} = s_0 s_2 s_0 s_2$. A_{IV} is decomposed into A_{I_3} and a conjugacy of A_{I_1} :

$$\begin{aligned} A_{IV} &= s_0 s_2 s_0 s_2 = s_0^3 (s_0^{-1} s_2 s_0) \\ &= A_{I_3} \cdot s_2 A_{I_1} s_2^{-1}. \end{aligned}$$

In fact, the splitting $IV \rightarrow I_3 + I_1$ occurs in the barking family [**IV.1**].

A_{IV} has another monodromy decomposition

$$\begin{aligned} A_{IV} &= s_0 s_2 s_0 s_2 = s_0^2 s_2 s_0 \\ &= A_{I_2} \cdot (s_0 s_2) A_{I_1} (s_0 s_2)^{-1} \cdot A_{I_1}, \end{aligned}$$

while the barking family [**IV.2**] induces the splitting $IV \rightarrow I_2 + I_1 + I_1$.

We have other monodromy decompositions of A_{IV} as follows (but we have not found splitting families that admit the corresponding splittings):

$$\begin{aligned} A_{IV} &= (s_0 s_2 s_0) s_2 = A_{III} \cdot (s_0 s_2) A_{I_1} (s_0 s_2)^{-1}, \\ &\quad (IV \rightarrow III + I_1) \\ A_{IV} &= (s_0 s_2)^2 = A_{II} \cdot A_{II}, \\ &\quad (IV \rightarrow II + II) \\ A_{IV} &= (s_0 s_2) s_0 s_2 = A_{II} \cdot A_{I_1} \cdot (s_0 s_2) A_{I_1} (s_0 s_2)^{-1}, \\ &\quad (IV \rightarrow II + I_1 + I_1) \\ A_{IV} &= s_0^2 s_2 (s_0 s_2) s_2^{-1} = A_{I_2} \cdot s_2 A_{II} s_2^{-1}, \\ &\quad (IV \rightarrow I_2 + II) \\ A_{IV} &= s_0 s_2 s_0 s_2 \\ &= A_{I_1} \cdot (s_0 s_2) A_{I_1} (s_0 s_2)^{-1} \cdot A_{I_1} \cdot (s_0 s_2) A_{I_1} (s_0 s_2)^{-1}, \\ &\quad (IV \rightarrow I_1 + I_1 + I_1 + I_1) \end{aligned}$$

Decomposition of A_{II^*} The standard monodromy matrix of II^* is $A_{II^*} = (s_0 s_2)^5$. A_{II^*} is decomposed into A_{III^*} and a conjugacy of A_{I_1} :

$$A_{II^*} = (s_0 s_2)^4 s_0 s_2 = A_{III^*} \cdot (s_0 s_2) A_{I_1} (s_0 s_2)^{-1}.$$

In fact, the splitting $II^* \longrightarrow III^* + I_1$ occurs in the barking families **[II*.1]**, **[II*.8]**, **[II*.9]**.

A_{II^*} is also decomposed into $A_{I_3^*}$ and a conjugacy of A_{I_1} :

$$\begin{aligned} A_{II^*} &= (s_0 s_2)^3 s_0 s_2 s_0 s_2 = (s_0 s_2)^3 s_0^3 (s_0^{-1} s_2 s_0) \\ &= A_{I_3^*} \cdot s_2 A_{I_1} s_2^{-1}. \end{aligned}$$

Note that the barking families **[II*.5]** and **[II*.6]** induce the splitting $II^* \longrightarrow I_3^* + I_1$.

We have other monodromy decompositions of A_{II^*} which respectively correspond to the splittings induced by Takamura's barking families as follows:

$$\begin{aligned} A_{II^*} &= (s_0 s_2)^4 (s_0 s_2) = A_{IV^*} \cdot A_{II}, \\ &\quad (\mathbf{[II*.2]} \quad II^* \longrightarrow IV^* + II) \\ A_{II^*} &= (s_0 s_2)^3 s_0^2 (s_0^{-1} s_2 s_0) s_2 = A_{I_2^*} \cdot s_2 A_{I_1} s_2^{-1} \cdot (s_0 s_2) A_{I_1} (s_0 s_2)^{-1}, \\ &\quad (\mathbf{[II*.3]} \quad II^* \longrightarrow I_2^* + I_1 + I_1) \\ A_{II^*} &= s_0^5 (s_0^{-1} s_2 s_0) s_0 s_2 s_2 s_0 \\ &= A_{I_5} \cdot s_2 A_{I_1} s_2^{-1} \cdot A_{I_1} \cdot (s_0 s_2) A_{I_1} (s_0 s_2)^{-1} \cdot (s_0 s_2) A_{I_1} (s_0 s_2)^{-1} \cdot A_{I_1}, \\ &\quad (\mathbf{[II*.4]} \quad II^* \longrightarrow I_5 + I_1 + I_1 + I_1 + I_1 + I_1) \\ A_{II^*} &= s_0^8 (s_0^{-2} s_2 s_0^2) (s_0^{-1} s_2^{-2} s_0 s_2^2 s_0) \\ &= A_{I_8} \cdot (s_0^{-1} s_2) A_{I_1} (s_0^{-1} s_2)^{-1} \cdot (s_0^{-1} s_2^{-2}) A_{I_1} (s_0^{-1} s_2^{-2})^{-1}. \\ &\quad (\mathbf{[II*.7]} \quad II^* \longrightarrow I_8 + I_1 + I_1) \end{aligned}$$

Decomposition of A_{III^*} The standard monodromy matrix of III^* is $A_{III^*} = (s_0 s_2)^4 s_0$. A_{III^*} is decomposed into A_{IV^*} and A_{I_1} :

$$A_{III^*} = (s_0 s_2)^4 s_0 = A_{IV^*} \cdot A_{I_1}.$$

In fact, the splitting $III^* \longrightarrow IV^* + I_1$ occurs in the barking families **[III*.1]** and **[III*.9]**.

A_{III^*} is also decomposed into $A_{I_2^*}$ and a conjugacy of A_{I_1} :

$$\begin{aligned} A_{III^*} &= (s_0 s_2)^3 s_0 s_2 s_0 = (s_0 s_2)^3 s_0^2 (s_0^{-1} s_2 s_0) \\ &= A_{I_2^*} \cdot s_2 A_{I_1} s_2^{-1}. \end{aligned}$$

Note that the barking families **[III*.3]** and **[III*.6]** induce the splitting $III^* \longrightarrow I_2^* + I_1$.

We have other monodromy decompositions of A_{III^*} which respectively correspond to the splittings induced by Takamura's barking families as follows:

$$\begin{aligned}
A_{III^*} &= s_2^{-1} (s_0 s_2)^3 s_0 s_2 s_0^2 = s_2^{-1} A_{I_1^*} s_2 \cdot A_{I_2}, \\
&\quad ([III^*.2] \ III^* \longrightarrow I_1^* + I_2) \\
A_{III^*} &= (s_0 s_2)^3 s_0 s_2 s_0 = A_{I_0^*} \cdot A_{I_1} \cdot (s_0 s_2) A_{I_1} (s_0 s_2)^{-1} \cdot A_{I_1}, \\
&\quad ([III^*.4] \ III^* \longrightarrow I_0^* + I_1 + I_1 + I_1) \\
A_{III^*} &= s_0^6 (s_0^{-3} s_2 s_0^3) (s_0^{-1} s_2 s_0) (s_0^{-1} s_2 s_0) \\
&= A_{I_6} \cdot (s_0^{-2} s_2) A_{I_1} (s_0^{-2} s_2)^{-1} \cdot s_2 A_{I_1} s_2^{-1} \cdot s_2 A_{I_1} s_2^{-1}, \\
&\quad ([III^*.5] \ III^* \longrightarrow I_6 + I_1 + I_1 + I_1) \\
A_{III^*} &= s_0^7 (s_0^{-5} s_2 s_0^5) (s_0^{-2} s_2 s_0^2) \\
&= A_{I_7} \cdot (s_0^{-4} s_2) A_{I_1} (s_0^{-4} s_2)^{-1} \cdot (s_0^{-1} s_2) A_{I_1} (s_0^{-1} s_2)^{-1}. \\
&\quad ([III^*.7] \ III^* \longrightarrow I_7 + I_1 + I_1)
\end{aligned}$$

Decomposition of A_{IV^*} The standard monodromy matrix of IV^* is $A_{IV^*} = (s_0 s_2)^4$. A_{IV^*} is decomposed into $A_{I_1^*}$ and a conjugacy of A_{I_1} :

$$A_{IV^*} = (s_0 s_2)^3 s_0 s_2 = A_{I_1^*} \cdot (s_0 s_2) A_{I_1} (s_0 s_2)^{-1}.$$

In fact, the splitting $IV^* \longrightarrow I_1^* + I_1$ occurs in the barking families $[IV^*.1]$ and $[IV^*.4]$.

We have other monodromy decompositions of A_{IV^*} which respectively correspond to the splittings induced by Takamura's barking families as follows:

$$\begin{aligned}
A_{IV^*} &= (s_0 s_2)^3 s_0 s_2 = A_{I_0^*} \cdot A_{I_1} \cdot (s_0 s_2) A_{I_1} (s_0 s_2)^{-1}, \\
&\quad ([IV^*.2] \ IV^* \longrightarrow I_0^* + I_1 + I_1) \\
A_{IV^*} &= s_0^6 (s_0^{-4} s_2 s_0^4) (s_0^{-1} s_2 s_0) \\
&= A_{I_6} \cdot (s_0^{-3} s_2) A_{I_1} (s_0^{-3} s_2)^{-1} \cdot s_2 A_{I_1} s_2^{-1}. \\
&\quad ([IV^*.3] \ IV^* \longrightarrow I_6 + I_1 + I_1)
\end{aligned}$$

Decomposition of $A_{I_n^*}$ ($n \geq 0$) The standard monodromy matrix of I_n^* ($n \geq 0$) is $A_{I_n^*} = (s_0 s_2)^3 s_0^n$. $A_{I_n^*}$ is decomposed into $A_{I_{n+4}}$ and two conjugacies of A_{I_1} as follows:

$$\begin{aligned}
A_{I_{n+4}} &= s_0 s_2 s_0 s_2 s_0 s_2 s_0^n = s_2 (s_0^2 s_2 s_0^{-2}) s_0^4 s_0^n \\
&= (s_0 s_2) A_{I_1} (s_0 s_2)^{-1} \cdot (s_0^3 s_2) A_{I_1} (s_0^3 s_2)^{-1} \cdot A_{I_{n+4}}.
\end{aligned}$$

In fact, the splitting $IV^* \longrightarrow I_1^* + I_1$ occurs in the barking families $[I_0^*.1]$ and $[I_n^*.2]$.

For $n \geq 1$, note that the barking family $[I_n^*.1]$ induces the splitting $I_n^* \longrightarrow I_{n-1}^* + I_1$. Then $A_{I_n^*}$ is also decomposed into $A_{I_{n-1}^*}$ and A_{I_1} as follows:

$$A_{I_n^*} = (s_0 s_2)^3 s_0^{n-1} s_0 = A_{I_{n-1}^*} \cdot A_{I_1}.$$

12 Appendix: Takamura's list for genus $g = 1$

In [Ta3], for genera up to 5, Takamura made a list of barking families — precisely speaking, a list of simple crusts (and weighted crustal sets) for constructing barking families — which enables him to show that a degeneration is absolutely atomic if and only if its singular fiber is either a Lefschetz fiber or a multiple of a smooth fiber. Recall that in a barking family, for a fixed $t \neq 0$, the singular fiber $X_{0,t}$ over the origin is called the main fiber and other singular fibers $X_{s,t}$ ($s \neq 0$) are called subordinate fibers. As we saw in Section 2, the main fibers of barking families are explicitly described. In this paper, when the original singular fiber X_0 is deformed to the main fiber $X_{0,t}$, we express $X_0 \xrightarrow{\text{bark}} X_{0,t}$.

For the convenience of the reader, we provide Takamura's list of barking families for genus 1 with figures of the singular fibers:

$$[II.1] \ II \xrightarrow{\text{bark}} I_1$$

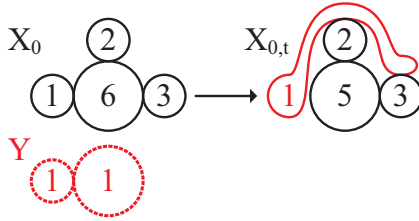

$$[II.2] \ II \xrightarrow{\text{bark}} I_1$$

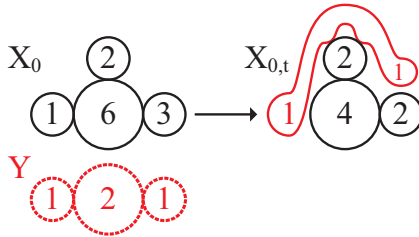

$$[III*.1] \ III^* \xrightarrow{\text{bark}} III^*$$

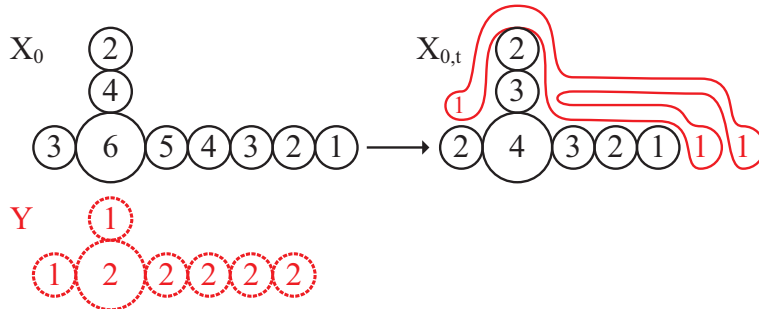

[II*.2] $II^* \xrightarrow{\text{bark}} IV^*$

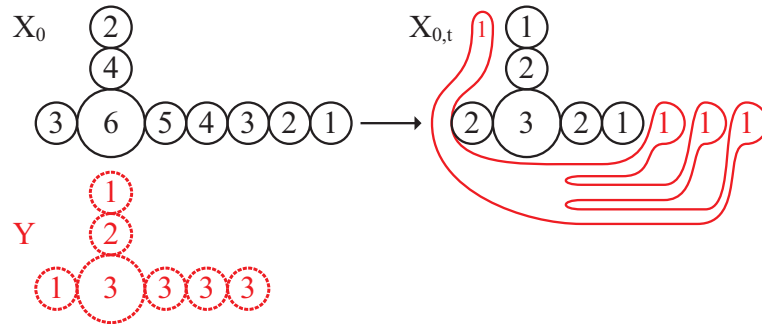

[II*.3] $II^* \xrightarrow{\text{bark}} I_2^*$

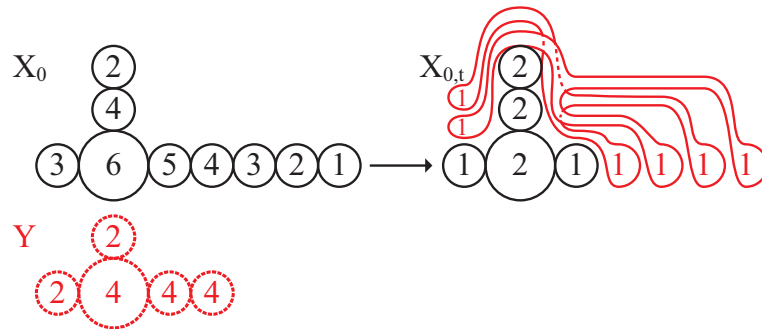

[II*.4] $II^* \xrightarrow{\text{bark}} I_5^*$

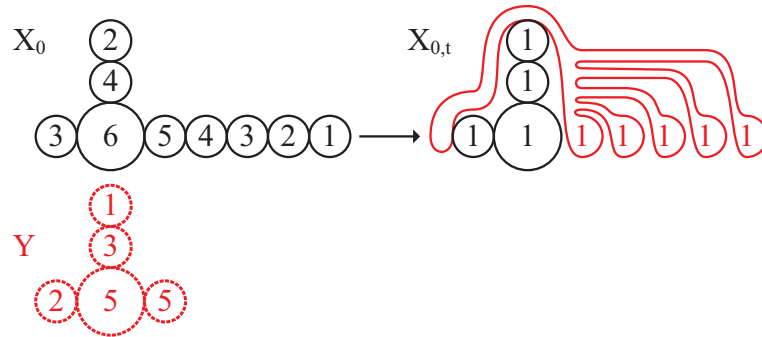

[II*.5] $II^* \xrightarrow{\text{bark}} I_3^*$

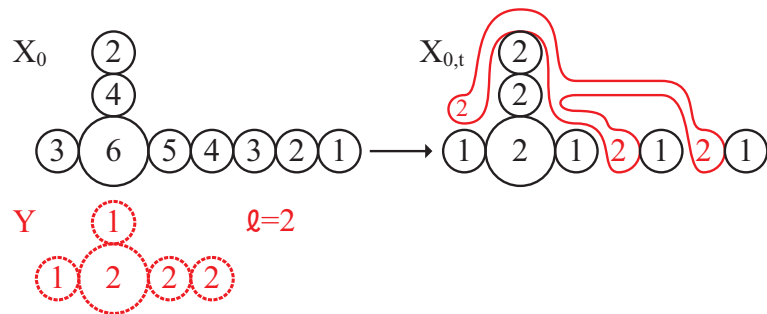

[II*.6] $II^* \xrightarrow{\text{bark}} I_3^*$

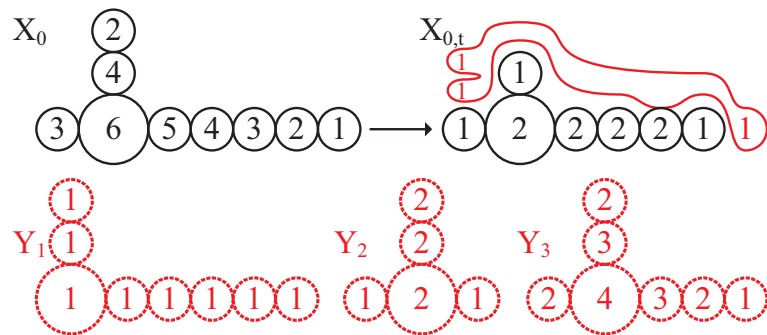

[II*.7] $II^* \xrightarrow{\text{bark}} I_8$

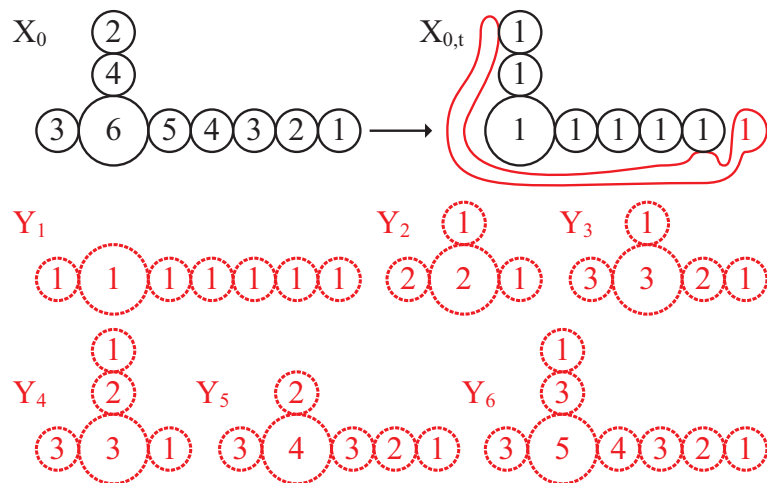

[III.3] $III \xrightarrow{\text{bark}} I_2$

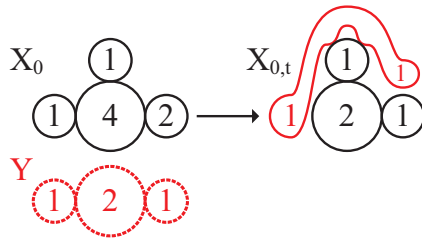

[III*.1] $III^* \xrightarrow{\text{bark}} IV^*$

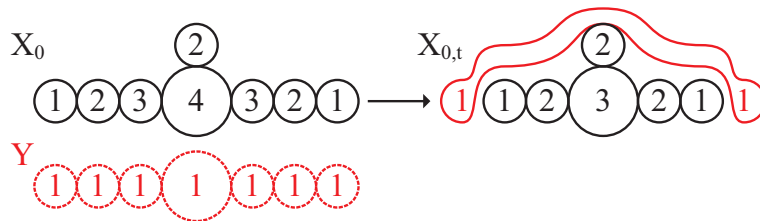

[III*.2] $III^* \xrightarrow{\text{bark}} I_1^*$

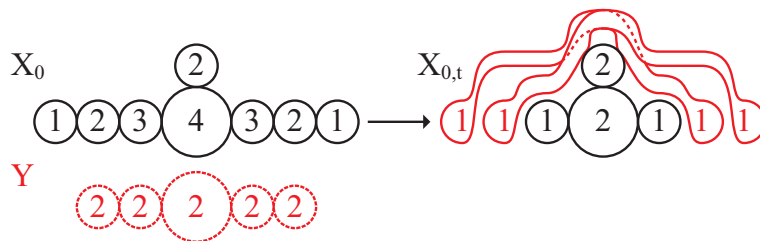

[III*.3] $III^* \xrightarrow{\text{bark}} I_2^*$

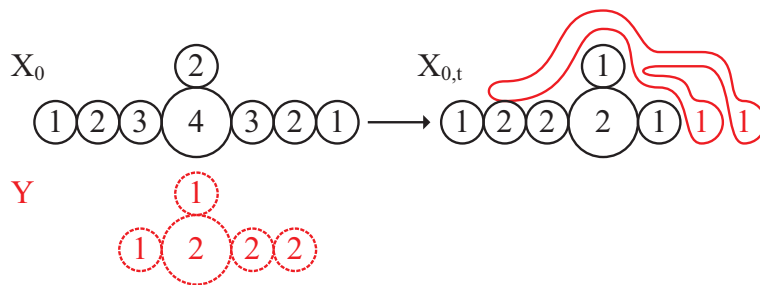

$$[III^*.4] III^* \xrightarrow{\text{bark}} I_0^*$$

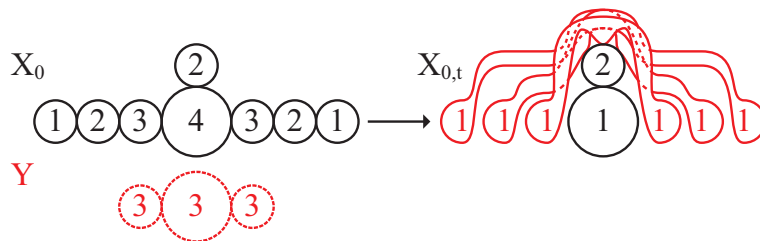

$$[III^*.5] III^* \xrightarrow{\text{bark}} I_6$$

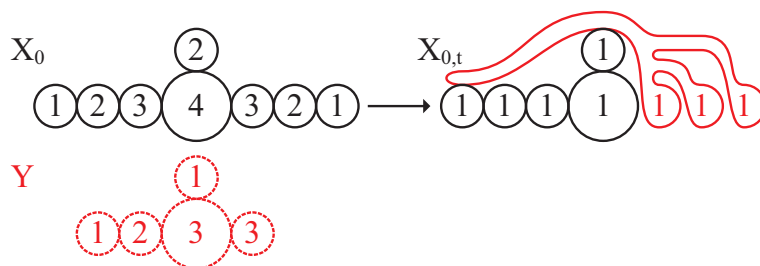

$$[III^*.6] III^* \xrightarrow{\text{bark}} I_2^*$$

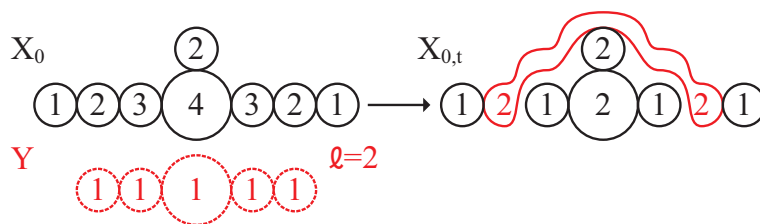

$$[III^*.7] III^* \xrightarrow{\text{bark}} I_7$$

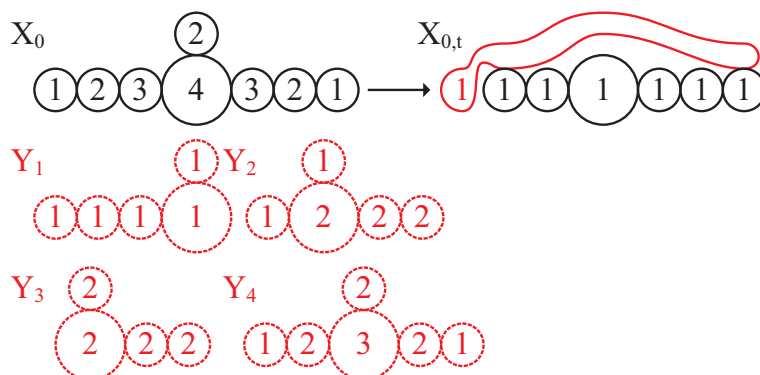

[III*.8] $III^* \xrightarrow{\text{bark}} I_6$

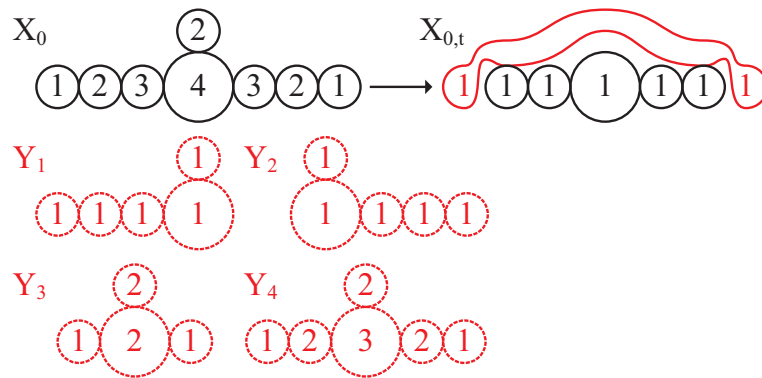

[III*.9] $III^* \xrightarrow{\text{bark}} IV^*$

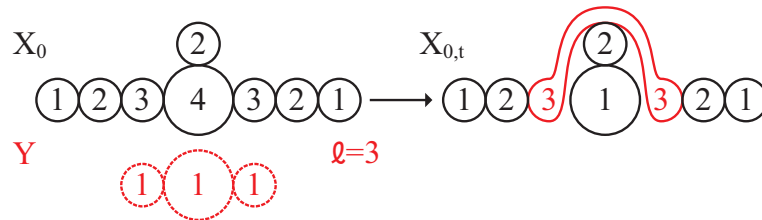

[IV.1] $IV \xrightarrow{\text{bark}} I_3$

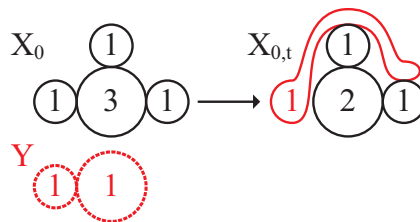

[IV.2] $IV \xrightarrow{\text{bark}} I_2$

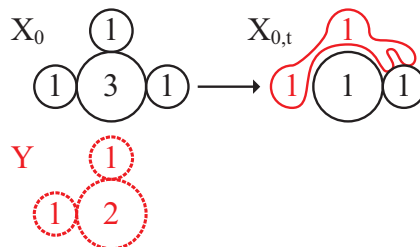

$$[IV.3] IV \xrightarrow{\text{bark}} I_2$$

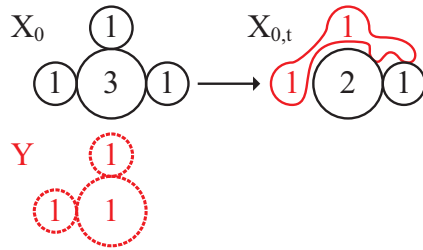

$$[IV.4] IV \xrightarrow{\text{bark}} II$$

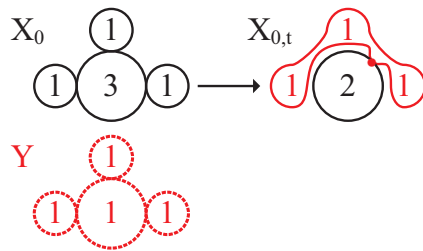

$$[IV^*.1] IV^* \xrightarrow{\text{bark}} I_1^*$$

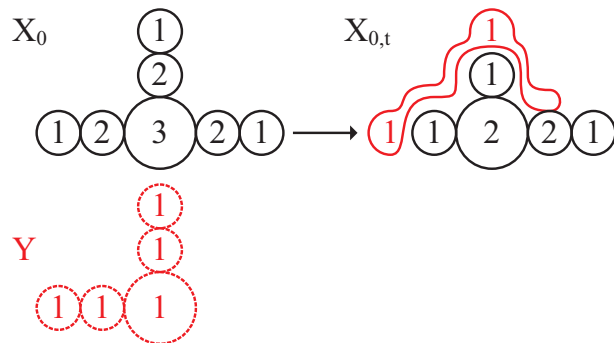

$$[IV^*.2] IV^* \xrightarrow{\text{bark}} I_0^*$$

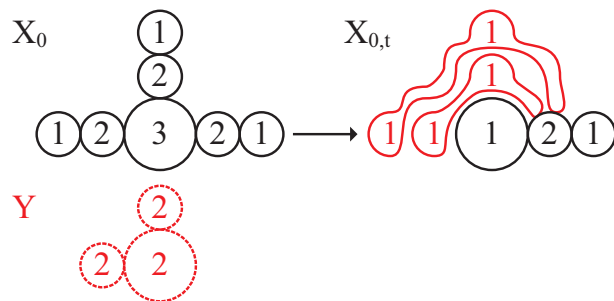

$$[IV^*.3] IV^* \xrightarrow{\text{bark}} I_6$$

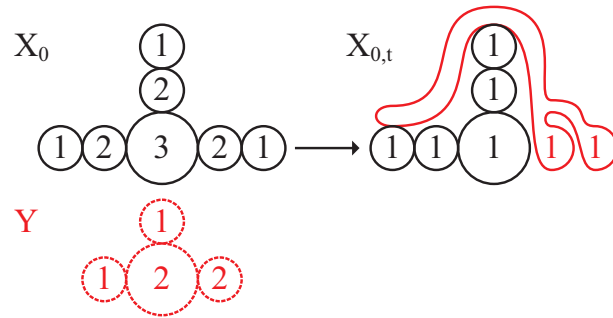

$$[IV^*.4] IV^* \xrightarrow{\text{bark}} I_1^*$$

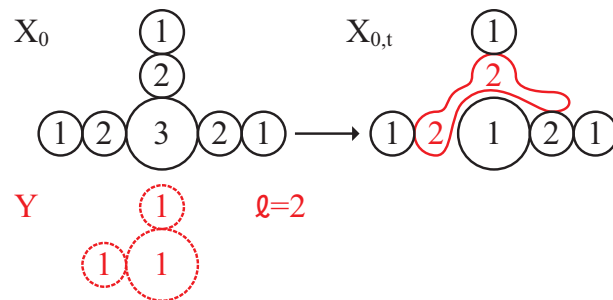

$$[I_0^*.1] I_0^* \xrightarrow{\text{bark}} I_4$$

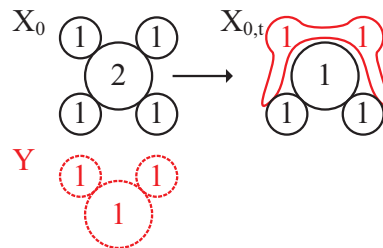

$$[I_0^*.2] I_0^* \xrightarrow{\text{bark}} I_3$$

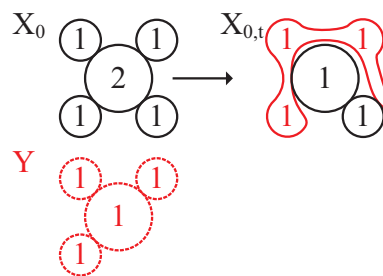

$$[\mathbf{I}_n^*.1] I_n^* \xrightarrow{\text{bark}} I_{n-1}^*$$

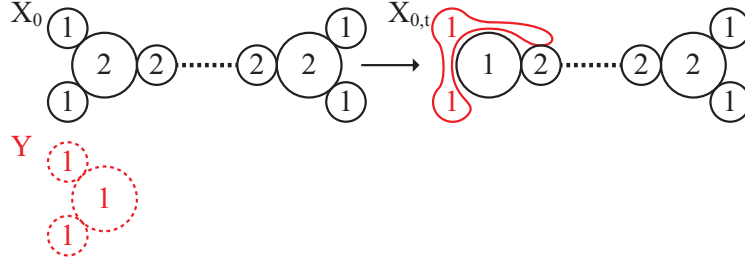

$$[\mathbf{I}_n^*.2] I_n^* \xrightarrow{\text{bark}} I_{n+4}^*$$

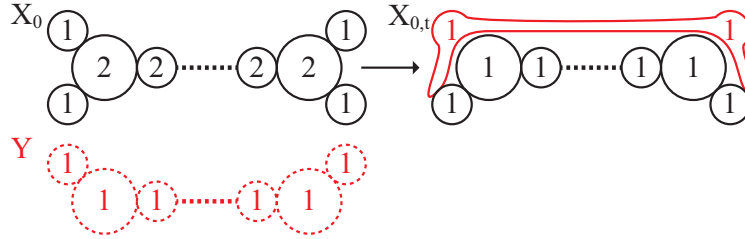

- Remark 12.1.** (a) Takamura [Ta3] introduced not only a barking family associated with *one* simple crust (which we reviewed in Section 2) but also a barking family associated with *several* crusts. The latter is called a *compound barking family*. Note that the barking families $[\mathbf{II}^*.6]$, $[\mathbf{II}^*.7]$, $[\mathbf{III}^*.7]$, $[\mathbf{III}^*.8]$ are compound barking families.
- (b) The singular fiber I_n^* ($n \geq 1$) is *constellar* (constellation-shaped), that is, it is obtained by bonding stellar singular fibers. So $[\mathbf{I}_n^*.1]$ and $[\mathbf{I}_n^*.2]$ are barking families for constellar case rather than for stellar case. See [Ta3] for details.
- (c) This list contains no barking families for a degeneration with the singular fiber mI_n . In fact, for mI_n ($m \geq 2$), we use another method to construct a splitting family, which splits mI_n into mI_{n-1} and I_1 . See [Ta1] for details.

References

- [BPV] W. Barth, C. Peters, and A. Van de Ven, *Compact Complex Surfaces*, Ergebnisse der Mathematik und ihrer Grenzgebiete (3), **4**, Springer-Verlag, 1984
- [FM] R. Friedman, and J. W. Morgan, *Smooth Four-manifolds and Complex Surfaces*, Ergebnisse der Mathematik und ihrer Grenzgebiete (3) **27**, Springer-Verlag, 1994
- [Ka] A. Kas, *On the deformation types of regular elliptic surfaces*, Complex Analysis and Algebraic Geometry, Iwanami and Cambridge Univ. Press (1977), 107–112

- [Ko] K. Kodaira, *On compact complex analytic surfaces, II*, Ann. of Math. (2) **77** (1963), 563–626
- [M] B. Moishezon, *Complex Surfaces and Connected Sums of Complex Projective Planes*, Lecture Notes in Math. **603**, Springer-Verlag, 1977
- [Ta1] S. Takamura, *Towards the classification of atoms of degenerations, I — Splitting criteria via configurations of singular fibers*, J. Math. Soc. Japan **56** (2004), no. 1, 115–145
- [Ta2] S. Takamura, *Towards the classification of atoms of degenerations, II — Linearization of degenerations of complex curves*, RIMS Preprint, 1344 (2001)
- [Ta3] S. Takamura, *Towards the classification of atoms of degenerations, III — Splitting Deformations of Degenerations of Complex Curves*, Lecture Notes in Math. **1886**, Springer-Verlag, 2006
- [U] M. Ue, *On the topology of elliptic surfaces—a survey*, Amer. Math. Soc. Transl. Ser. 2 **160** (1994), 95–123

TAKAYUKI OKUDA

GRADUATE SCHOOL OF MATHEMATICS, KYUSHU UNIVERSITY,
MOTOOKA 744, NISHI-KU, FUKUOKA 819-0395, JAPAN
E-mail address: t-okuda@math.kyushu-u.ac.jp