

OBTAINING GENUS 2 HEEGAARD SPLITTINGS FROM DEHN SURGERY

KENNETH L. BAKER, CAMERON GORDON, AND JOHN LUECKE

ABSTRACT. Let K' be a hyperbolic knot in S^3 and suppose that some Dehn surgery on K' with distance at least 3 from the meridian yields a 3-manifold M of Heegaard genus 2. We show that if M does not contain an embedded Dyck's surface (the closed non-orientable surface of Euler characteristic -1), then the knot dual to the surgery is either 0-bridge or 1-bridge with respect to a genus 2 Heegaard splitting of M . In the case that M does contain an embedded Dyck's surface, we obtain similar results. As a corollary, if M does not contain an incompressible genus 2 surface, then the tunnel number of K' is at most 2.

1. INTRODUCTION

Let $M = K'(\gamma)$ be the manifold obtained by Dehn surgery on a knot K' in S^3 along a slope γ . In $K'(\gamma)$, the core of the attached solid torus is a knot which we denote by K . It is natural to consider the properties of K as a knot in M . In this paper we are interested in the relationship between K and the Heegaard splittings of M ; more specifically, if \widehat{F} is a Heegaard surface in M of genus g , what can we say about the bridge number $br(K)$ of K with respect to \widehat{F} ? Assume K' is a hyperbolic knot, meaning that its complement $S^3 - K'$ admits a complete Riemannian metric of constant sectional curvature -1 . It follows from [34] (see also [31] and [33]) that for all but finitely many slopes γ , K can be isotoped to lie on \widehat{F} , i.e. $br(K) = 0$. Let $\Delta = \Delta(\gamma, \mu)$ be the *distance* of the surgery, in other words the minimal geometric intersection number on $\partial N(K')$ of the slope γ and the meridian μ of K' . Since the trivial Dehn surgery $K'(\mu) = S^3$ represents the maximal possible degeneration of Heegaard genus, one would expect the Heegaard splittings of $K'(\gamma)$ to reflect those of the exterior of K' as Δ gets large. Indeed, it follows from [33] that for any Heegaard surface \widehat{F} of $K'(\gamma)$ of genus g if $\Delta \geq 18(g+1)$ then $br(K) = 0$, and so after at most one stabilization \widehat{F} is isotopic to a Heegaard surface for the exterior of K' . Also, in [2] we show that if $\Delta \geq 2$, γ is not a boundary slope for K' , and M has a strongly irreducible Heegaard splitting of genus g , then the bridge number $br(K)$ of K with respect to *some* genus g splitting of M is bounded above by a universal linear function of g . In contrast, this is not true for $\Delta = 1$: By Teragaito [38] there exists a family of knots K'_n and a γ with $\Delta(\gamma, \mu) = 1$ such that $K'_n(\gamma)$ is the same small Seifert fiber space M for all n , and we show in [3] that the set of bridge numbers of the corresponding cores K_n with respect to any genus 2 Heegaard splitting of M is unbounded.

Turning to small values of g , note that the impossibility of getting S^3 by non-trivial Dehn surgery on a non-trivial knot [21] can be expressed as saying that if $g = 0$ and $\Delta > 0$ then $br(K) = 0$. When $g = 1$, $K'(\gamma)$ is a lens space and here the

Cyclic Surgery Theorem [9] says that if $\Delta > 1$ then K' is a torus knot, which is easily seen to imply $br(K) = 0$, while if $\Delta = 1$ and K' is hyperbolic the Berge Conjecture [4] asserts that $br(K) = 1$. In the present paper we consider the case $g = 2$ and show that if $\Delta > 2$ then, generically, $br(K) \leq 1$ (with respect to some genus 2 splitting). In fact we consider 1-sided as well as 2-sided genus 2 Heegaard splittings of M ; recall that such a splitting is defined by a closed (connected) non-orientable surface of Euler characteristic -1 in M , the complement of an open regular neighborhood of which is a genus 2 handlebody. Such a surface is a connected sum of three projective planes and is also known as a *cross cap number 3 surface* or as a *Dyck's surface*; in this paper we shall adopt the latter terminology.

Theorem 2.4. *Let K' be a hyperbolic knot in S^3 and assume $M = K'(\gamma)$ has a 1- or 2-sided Heegaard splitting of genus 2. Assume that $\Delta(\gamma, \mu) \geq 3$ where μ is the meridian of K' . Denote by K the core of the attached solid torus in M . Then either*

- (1) *K is 0-bridge or 1-bridge with respect to a 1- or 2-sided, genus 2 Heegaard splitting of M . In this case, the tunnel number of K' is at most two.*

or

- (2) *M contains a Dyck's surface, \widehat{S} , such that the orientable genus 2 surface \widehat{F} that is the boundary of a regular neighborhood of \widehat{S} is incompressible in M . Furthermore, K can either be isotoped onto \widehat{S} as an orientation-reversing curve or can be isotoped to intersect \widehat{S} once. In the latter case, the intersection of \widehat{F} with the exterior of K (which is also the exterior of K') gives a twice-punctured, incompressible, genus 2 surface in that exterior.*

Conclusion (2) is an artifact of the proof and probably not necessary, but allowing it simplifies an already lengthy argument. Similarly, the assumption that K' is hyperbolic simplifies the argument; we will consider the case where K' is a satellite knot elsewhere.

As a warning, the Heegaard splitting of conclusion (1) may be different than the one you started with – for example, starting with a 2-sided genus 2 Heegaard splitting of $K'(\gamma)$, the proof of Theorem 2.4 may produce a 1-sided splitting with respect to which K is 1-bridge.

Theorem 2.4 fails dramatically when $\Delta = 1$. For the Teragaito examples mentioned above [38], Theorem A.2 of Appendix A shows that the ambient Seifert fiber space, M , contains no Dyck's surface; thus conclusion (2) of Theorem 2.4 does not apply and every genus 2 splitting of M is 2-sided. On the other hand, [3] shows there are knots in the Teragaito family with arbitrarily large bridge number with respect to any genus 2 splitting of M .

Theorem 2.4 says that there exists a Heegaard splitting of M with respect to which K is most 1-bridge. If the bridge number is more than one, the proof of Theorem 2.4 constructs a new genus 2 splitting with respect to which the bridge number is smaller. By keeping a track of when such a modification is necessary, we see that the proof typically shows that K is at most 1-bridge with respect to any genus 2 splitting of M . We make this precise in Theorem 2.6 below. For this we need the following definitions.

Definition 1.1. Let $H_B \cup_{\widehat{F}} H_W$ be a genus 2 (2-sided) Heegaard splitting of M . Assume there is a Möbius band on one side of the Heegaard surface \widehat{F} whose boundary is a primitive curve on the other side of \widehat{F} . A new Heegaard splitting of

M , of the same genus, can be formed by removing a neighborhood of the Möbius band from one side of \widehat{F} and adding it to the other side. We say that this new splitting is obtained from the old by *adding/removing a Möbius band*.

Definition 1.2. Let M be a Seifert fiber space over the 2-sphere with three exceptional fibers. A *vertical* Heegaard splitting of M is a genus 2 splitting for which one of the Heegaard handlebodies is gotten by tubing together the neighborhoods of two exceptional fibers, where the tube connecting them is the neighborhood of a co-core arc of a vertical annulus connecting the neighborhoods of these exceptional fibers.

Theorem 2.6. *Let K' be a hyperbolic knot in S^3 . Let $H_B \cup_{\widehat{F}} H_W$ be a genus 2 (2-sided) Heegaard splitting of $M = K'(\gamma)$. Assume that $\Delta(\gamma, \mu) \geq 3$ where μ is the meridian of K' . Furthermore assume that M does not contain a Dyck's surface. Denote by K the core of the attached solid torus in M . Then either*

- (1) K is 0-bridge or 1-bridge with respect to a Heegaard splitting of M obtained from $H_B \cup_{\widehat{F}} H_W$ by a (possibly empty) sequence of adding/removing Möbius bands; or
- (2) M is a Seifert fiber space over the disk with three exceptional fibers, one of which has order 2 or 3, and K is 0-bridge or 1-bridge with respect to a Heegaard splitting gotten from a vertical Heegaard splitting of the Seifert fiber space M which has been changed by a (possibly empty) sequence of adding/removing Möbius bands; or
- (3) M is $n/2$ -surgery on a trefoil knot, n odd, and K is 0-bridge or 1-bridge with respect to the Heegaard splitting on M coming from the genus 2 splitting of the trefoil knot exterior. Note that in this case M is a Seifert fiber space over the 2-sphere with three exceptional fibers, one of order 2 and a second of order 3.

In particular, if M is not a Seifert fiber space over the 2-sphere with an exceptional fiber of order 2 or 3, and if the Heegaard surface \widehat{F} has no Möbius band on one side whose boundary is a primitive curve on the other, then K must be 0-bridge or 1-bridge with respect to the given splitting $H_B \cup_{\widehat{F}} H_W$.

Remark 1.3. The situations in which the Heegaard splitting $H_B \cup_{\widehat{F}} H_W$ must be altered in Theorem 2.6 are special. The situation when M contains a Dyck's surface is discussed in more detail below, for example in Theorem 7.2 (see also Appendix A). It is conjectured that the second and third conclusions of Theorem 2.6 never hold, that a Seifert fiber space never arises by non-integral surgery on a hyperbolic knot. Finally, the existence of a Möbius band in one Heegaard handlebody of $H_B \cup_{\widehat{F}} H_W$ whose boundary is primitive on the other is a special case of this Heegaard splitting having Hempel distance 2 [27, 39] — which also places restrictions on what M can be. Presumably these exceptions are artifacts of the proof, and that in fact K is at most 1-bridge with respect to any genus 2 splitting when $\Delta \geq 3$.

Our results give information on the relationship between the Heegaard genus of M and that of $X = S^3 - N(K')$, the exterior of K' . Recall that a Heegaard splitting of X is a decomposition $X = V \cup_S W$, where V is a handlebody with $\partial V = S$ and W is a compression body with $\partial W = S \sqcup \partial X$. The *Heegaard genus* $g(X)$ of X is the minimal genus of S over all such decompositions.

In this context one often talks about the *tunnel number* $t(K')$ of K' , the minimum number of arcs (“tunnels”) that need to be attached to K' so that the complement

of an open regular neighborhood of the resulting 1-complex is a handlebody. It is easy to see that $g(X) = t(K') + 1$. For any slope γ , $V \cup_S W(\gamma)$ is a Heegaard splitting of $M = K'(\gamma)$; in particular $g(M) \leq g(X)$. In fact, by [35], generically we have $g(M) = g(X)$. More precisely, recall that for all but finitely many slopes γ , $br(K) = 0$ with respect to any Heegaard surface \widehat{F} of M . Taking \widehat{F} to have minimal genus, it is then easy to see that when $br(K) = 0$ either $g(M) = g(X) = t(K') + 1$ or $g(M) = g(X) - 1 = t(K')$. See [33] for details. By [35], the second possibility can happen for only a finite number of lines of slopes (where a *line* of slopes is a set of slopes γ such that $\Delta(\gamma, \gamma_0) = 1$ for some fixed slope γ_0). We know no examples where the Heegaard genus of $K'(\gamma)$ ($\gamma \neq \mu$) is less than $t(K')$.

Question. *Is $t(K') \leq g(K'(\gamma))$ for all $\gamma \neq \mu$?*

Now it is easy to see that an upper bound on $br(K)$ in M , with respect to a 1- or 2-sided Heegaard surface, gives an upper bound on $t(K')$. In particular part (1) of Theorem 2.4 gives

Corollary 1.4. *Let K' be a hyperbolic knot in S^3 and suppose $K'(\gamma)$ has Heegaard genus 2 and does not contain an incompressible genus 2 surface, where $\Delta(\gamma, \mu) \geq 3$. Then the tunnel number of K' is at most 2.*

Corollary 1.4 is sharp: there exist hyperbolic tunnel number 2 knots K' having non-Haken Dehn surgeries $K'(\gamma)$ of Heegaard genus 2 with $\Delta(\gamma, \mu)$ arbitrarily large. To see this, let K' be a knot that lies on a standard genus 2 Heegaard surface in S^3 , and let λ be the (integral) slope on $\partial N(K')$ induced by the surface. Then for any γ such that $\Delta(\gamma, \lambda) = 1$, $K'(\gamma)$ has a (2-sided) Heegaard splitting of genus 2. Note that the tunnel number of K' is at most 2; on the other hand one can arrange that it is 2, and that $K'(\gamma)$ is non-Haken. Explicit examples are provided by the pretzel knots $K' = P(p, q, r)$ where $|p|, |q|, |r|$ are distinct odd integers greater than 1. Such a knot K' lies on the standard genus 2 surface in S^3 , with λ the canonical longitude (slope 0). Hence $K'(\gamma)$ has a genus 2 Heegaard splitting for all γ of the form $1/n$ (with the usual parametrization of slopes for knots). Note that $\Delta(\gamma, \mu) = |n|$ can be arbitrarily large. By [42], K' is non-invertible, and therefore does not have tunnel number 1. The double branched cover of K' is a Seifert fiber space over S^2 with three exceptional fibers, which does not contain an incompressible surface, and hence by [19] $S^3 - K'$ contains no closed essential surface. It follows that K' is hyperbolic. It also follows that if $K'(\gamma)$ is Haken then γ is a boundary slope. Since any knot has only finitely many boundary slopes [26], $K'(1/n)$ will be non-Haken for all but finitely many values of n . (Other pretzel knots provide similar examples, using [32] to ensure that they have tunnel number 2.)

One reason we are interested in the genus 2 case is that this includes the situation where M is a Seifert fiber space over S^2 with three exceptional fibers. Here it is expected that (when K' is hyperbolic) $\Delta = 1$, although to date the best known upper bound is 8 [29]. The techniques of this article ought to enable further restrictions on non-integral, Seifert fibered surgeries on hyperbolic knots in S^3 . We will explore this elsewhere.

We derived the bound on the tunnel number $t(K')$ from the bound on the bridge number $br(K)$ in $K'(\gamma)$ given in Theorem 2.4. We point out that the latter bound is stronger: for example for any $t \geq 1$ there are knots in S^3 with tunnel number t whose bridge number with respect to the genus t splitting of S^3 is arbitrarily high [30]. Also, although Teragaito's family of knots [38] mentioned above have tunnel

number 2, we show that the set of their bridge numbers with respect to any genus 2 Heegaard splitting of the small Seifert fiber space is unbounded [3]. At any rate, the bound on bridge number in Theorem 2.4 allows us to use a result of Tomova [41] to get a statement about the distance of splittings of exteriors of knots with genus 2 Dehn surgeries. If S is a Heegaard surface for some 3-manifold, we denote by $d(S)$ the (*Hempel*) distance of the corresponding splitting; see [27].

Corollary 1.5. *Let K' be a hyperbolic knot in S^3 whose exterior has a Heegaard splitting S with $d(S) > 6$. Let γ be a slope with $\Delta(\gamma, \mu) \geq 3$, where μ is a meridian of K' , and suppose the manifold $K'(\gamma)$ does not contain a Dyck's surface and has Heegaard genus 2. Then S has genus 2.*

Thus the distance of a splitting of a knot exterior is putting a limit on the degeneration of Heegaard genus under Dehn filling. For instance, this applies to the examples of [30]. First note that the condition that $K'(\gamma)$ not contain a Dyck's surface (or indeed any closed non-orientable surface) can be easily ensured by taking $\gamma = p/q$ with p odd. Now by [30], for any $g \geq 3$, there are knots K' in S^3 whose exteriors have genus g Heegaard splittings S with $d(S) > 6$, in fact with $d(S)$ arbitrarily large (such knots are necessarily hyperbolic). Corollary 1.2 says that for such a knot K' , if $q \geq 3$ and p is odd, $K'(p/q)$ does not have Heegaard genus 2.

Proof. (*Corollary 1.5*) Let K', γ, S be as in the hypothesis. By Theorem 2.4, the bridge number of K with respect to some genus 2 Heegaard surface \widehat{F} of $K'(\gamma)$ is at most 1. Thus K can be put in bridge position with respect to \widehat{F} so that $2 - \chi(\widehat{F} - K) = 2 - (-2 - 2) = 6$. Since $d(S) > 6$ by assumption, the main result of [41] implies that, in $K'(\gamma)$, \widehat{F} is isotopic to a stabilization of S . Hence S has genus 2 (and \widehat{F} is isotopic to S in $K'(\gamma)$). \square

In the course of proving Theorem 2.4, we consider Dehn surgeries that produce Dyck's surfaces, leading to conclusion (2) of that theorem. If a knot K' in S^3 has a maximal Euler characteristic spanning surface S with $\chi(S) = -1$ (so that K' has genus 1 or cross cap number 2) then surgery on K' along a slope γ of distance 2 from ∂S produces a manifold with Dyck's surface embedded in it. There is a Möbius band embedded in the surgery solid torus whose boundary coincides with ∂S so that together they form an embedded Dyck's surface \tilde{S} . The core of the surgery solid torus is the core of the Möbius band, and hence the surgered knot lies as a simple closed curve on \tilde{S} . Furthermore, such a surgery slope γ may be chosen so that it has any desired odd distance $\Delta = \Delta(\gamma, \mu)$ from the meridian μ of K' . Any knot with (Seifert) genus more than 1 and crosscap number 3 has an integral surgery containing a Dyck's surface that does not come from this construction, and there are many such hyperbolic knots, the smallest being 6_3 (see e.g. the tables [8]). However, we conjecture that this is the only way a Dyck's surface arises from a non-integral (i.e. $\Delta > 1$) Dehn surgery on a hyperbolic knot:

Conjecture 7.1. *Let K' be a hyperbolic knot in S^3 and assume that $K'(\gamma)$ contains an embedded Dyck's surface. If $\Delta(\gamma, \mu) > 1$, where μ is a meridian of K' , then there is an embedded Dyck's surface, $\widehat{S} \subset K'(\gamma)$, such that the core of the attached solid torus in $K'(\gamma)$ can be isotoped to an orientation-reversing curve in \widehat{S} . In particular, K' has a spanning surface with Euler characteristic -1 .*

In section 7, we prove the following, which goes a long way towards verifying this conjecture.

Theorem 7.2. *Let K' be a hyperbolic knot in S^3 and assume that $M = K'(\gamma)$ contains an embedded Dyck's surface. If $\Delta(\gamma, \mu) > 1$, where μ is a meridian of K' , then there is an embedded Dyck's surface in M that intersects the core of the attached solid torus in M transversely once.*

Conjecture 7.1 fits in well with earlier results on small surfaces in Dehn surgery on a knot in the 3-sphere. When $\Delta \geq 2$, M cannot contain an essential sphere ([20]), an embedded projective plane ([20], [9]), or an embedded Klein bottle ([23]). When $\Delta \geq 3$ (as in fact must be the case when M contains an embedded, closed, non-orientable surface and $\Delta > 1$), M cannot contain an essential torus ([22]).

1.1. Sketch of the argument for Theorem 2.4. The idea of the proof of Theorem 2.4 is as follows. Assume $M = K'(\gamma)$ has a 2-sided, genus 2 Heegaard splitting. Assume K has the smallest bridge number with respect to this splitting, among all 2-sided, genus 2 splittings of M . The typical situation is when this bridge position of K is also a thin position of K with respect to this splitting (see section 2.1). This thin presentation of K in M and one of K' in S^3 allow us to find a genus 2 Heegaard surface \widehat{F} of the splitting of M and a genus 0 Heegaard surface \widehat{Q} of S^3 such that $F = \widehat{F} - N(K)$ and $Q = \widehat{Q} - N(K')$ intersect essentially. The arcs of $F \cap Q$ form graphs G_F, G_Q on \widehat{F}, \widehat{Q} . Then $t = |K \cap \widehat{F}|$ is twice the bridge number of K in M . We show that $t \leq 2$, thereby implying that K is 0-bridge or 1-bridge with respect to this splitting. We do this typically by showing that if $t > 2$ then we can thin the presentation (i.e. find one with smaller bridge number) with respect to some genus 2 Heegaard splitting in M . To find such “thinnings” of K , we show that G_Q has a special subgraph, Λ , called a great 2-web (section 5.1). Disk faces of Λ are thought of as disks properly embedded $M - N(K \cup \widehat{F})$ (at least when there are no simple closed curves of $F \cap Q$). Within Λ we look for configurations of small faces that can be used to locate K in its bridge presentation with respect to \widehat{F} . For example, a configuration called an “extended Scharlemann cycle” (an ESC, see Figure 1) leads to a “long Möbius band” (Figure 3), which, when long enough, leads to an essential torus in M (which does not happen since $\Delta \geq 3$) or to a thinning of K (e.g. Lemmas 8.5 and 8.10). For $t \leq 6$, configurations of bigons and trigons at “special vertices” of Λ (section 5.3) are often used to construct a new Heegaard splitting of M with respect to which K has smaller bridge number.

As a note to the reader, the generic argument (showing that K is at most 4-bridge with respect to some genus 2 splitting of M) is given in sections 2, 4, 5.1, 5.2, 8, and 9. The arguments get more complicated as the supposed bridge number of K in M gets smaller. In particular, almost half of the current paper is from section 13 on, showing that the minimal bridge number of K is not 2 (i.e. $t \neq 4$).

1.2. Notation. By $N(\cdot)$ we denote a regular open neighborhood or its subsequent closure as the situation dictates.

Let Y be a subset of the manifold X , typically a properly embedded submanifold (such as an arc or loop in a surface or a surface or handlebody in a 3-manifold). By $X \setminus Y$ we denote X *chopped* or *cut* along Y . That is, $X \setminus Y$ may be viewed as either $X - \text{Int } N(Y)$ or the closure of $X - Y$ in the path metric.

For Y a connected codimension 1 properly embedded submanifold of X , any newly created maximal connected submanifold of the boundary of $X \setminus Y$ is an *impression* of Y . In other words, an impression of Y is a component of the closure of $\partial(X \setminus Y) - \partial X$. Note that the impressions of Y form a double cover of Y . Suitably identifying $\partial(X \setminus Y)$ along them will reconstitute X with Y inside. Alternatively X with Y may be reconstituted by suitably attaching $N(Y)$ to $X \setminus Y$.

1.3. Acknowledgements. In the course of this work KB was partially supported by NSF Grant DMS-0239600, by the University of Miami 2011 Provost Research Award, and by a grant from the Simons Foundation (#209184 to Kenneth Baker). KB would also like to thank the Department of Mathematics at the University of Texas at Austin for its hospitality during his visits. These visits were supported in part by NSF RTG Grant DMS-0636643.

2. THIN-BRIDGE POSITION, G_Q, G_F , AND THE PROOF OF THEOREM 2.4

2.1. Heegaard splittings, thin position, and bridge position. Given a (2-sided) Heegaard surface Σ of a closed 3-manifold Y there is a product $\Sigma \times \mathbb{R} \subset Y$ so that $\Sigma = \Sigma \times \{0\}$ and the complement of the product is the union of spines for each of the two handlebodies. This defines a height function on the complement of spines for each of the handlebodies. Consider all the circles C embedded in the product that are Morse with respect to the height function and represent the knot type of J . The following terms are all understood to be taken with respect to the Heegaard splitting.

Following [15] (see also [40]), the *width* of an embedded circle C is the sum of the number of intersections $|C \cap \Sigma \times \{y_i\}|$ where one regular value y_i is chosen between each pair of consecutive critical values. The *width* of a knot J is the minimum width of all such embeddings. However, if J can be isotoped to a curve embedded in a level surface $\Sigma \times \{y\}$, we define such an embedding as having width 0. An embedding realizing the width of J is a *thin position* of J , and J is said to be *thin*. If the critical point immediately below y_i is a minimum and the critical point immediately above y_i is a maximum, then the level $\Sigma \times \{y_i\}$ is a *thick level*.

The minimal number of maxima among Morse embeddings of C is the *bridge number* of J , and denoted $br(J)$. An embedding realizing the bridge number of J may be ambient isotoped so that all maxima lie above all minima, without introducing any more extrema. The resulting embedding is a *bridge position* of J , and J is said to be *bridge*. If J can be isotoped into a level surface $\Sigma \times \{y\}$, we define such an embedding as having bridge number 0.

With J in bridge position, the arcs of J intersecting a Heegaard handlebody are collectively ∂ -parallel. There is an embedded collection of disks in the handlebody such that the boundary of each is formed of one arc on Σ and one arc on J . A single such disk is called a *bridge disk* for that arc of J , and the arc is said to be *bridge*.

A thin position for a knot may have smaller width than that of its bridge position, with respect to the same Heegaard splitting. That is, thin position may not be bridge position. However, this only happens when the meridian of the knot in the ambient manifold is a boundary slope of the knot exterior.

Definition 2.1. Let E be an orientable 3-manifold with a single torus boundary. Let γ be the isotopy class of a non-trivial curve on ∂E . Then γ is said to be

a *boundary slope* for E if there is an incompressible, ∂ -incompressible, orientable surface, P , properly embedded in E with non-empty boundary, such that each component of ∂P is in isotopy class γ . γ is said to be a *g -boundary slope* if there is such a surface P with genus at most g .

Lemma 2.2. *Assume J is a knot in a 3-manifold M . If J has a thin position which is not a bridge position with respect to a genus g Heegaard splitting of M , then the meridian of J is a g -boundary slope for the exterior of J .*

Proof. This is proved in [40] when $g = 0$. The same proof works here. We sketch it for the convenience of the reader.

Let Σ be the Heegaard surface of a genus g splitting of M with respect to which J is in thin position but not bridge position. Then there must be a *thin level* — a level surface $\Sigma \times \{y\}$ at a regular value of the height function such that the first critical level below the surface is a maximum and the first critical level above the surface is a minimum. There can be no bridge disks for J to the thin level surface, else such a disk would give rise to a thinner presentation of J . Maximally compress $(\Sigma \times \{y\}) - N(J)$ in the exterior of J . Either some component of the result is an incompressible, ∂ -incompressible surface of genus at most g whose boundary components are meridians of J , or the result is a non-empty collection of boundary parallel annuli along with some closed surfaces. But each boundary parallel annulus gives rise to a bridge disk of J onto $\Sigma \times \{y\}$, which is not possible. Thus the meridian is a g -boundary slope for the exterior of J . \square

We tend to consider the situation where thin position is not bridge position as non-generic. For example we have the following useful result.

Lemma 2.3. *Let K' be a hyperbolic knot in S^3 with meridian μ . Assume there is a Heegaard splitting of $M = K'(\gamma)$ with respect to which the core of the attached solid torus, K , has a thin position which is not a bridge position. If $\Delta(\gamma, \mu) \geq 2$ then M is not Seifert fibered.*

Proof. Assume M is Seifert fibered. By Corollary 1.7 of [5] or Theorem 1.1 of [24], M is non-Haken. Considering K in M , Lemma 2.2 says that γ is a boundary slope for the exterior of K . But this contradicts Theorem 2.0.3 of [9] (M is irreducible and $K(\mu)$ is non-Haken). \square

We now give the proof of the main theorem, which defines the graphs G_Q, G_F studied throughout the rest of the paper.

Theorem 2.4. *Let K' be a hyperbolic knot in S^3 and assume $M = K'(\gamma)$ has a 1- or 2-sided Heegaard splitting of genus 2. Assume that $\Delta(\gamma, \mu) \geq 3$ where μ is the meridian of K' . Denote by K the core of the attached solid torus in M . Then either*

- (1) K is 0-bridge or 1-bridge with respect to a 1- or 2-sided, genus 2 Heegaard splitting of M . In this case, the tunnel number of K' is at most two.

or

- (2) M contains a Dyck's surface, \widehat{S} , such that the orientable genus 2 surface \widehat{F} that is the boundary of a regular neighborhood of \widehat{S} is incompressible in M . Furthermore, K can either be isotoped onto \widehat{S} as an orientation-reversing

curve or can be isotoped to intersect \widehat{S} once. In the latter case, the intersection of \widehat{F} with the exterior of K gives a twice-punctured, incompressible, genus 2 surface in that exterior.

Remark 2.5. In this proof and throughout the article, since K' is hyperbolic and $\Delta \geq 3$, M cannot contain an essential sphere ([20]), an embedded projective plane ([20], [9]), an embedded Klein bottle ([23]), or an essential torus ([22]).

Proof. Let K' be a hyperbolic knot in S^3 , and let $M = K'(\gamma)$. Assume $\Delta = \Delta(\gamma, \mu) \geq 3$. Let K be the core of the attached solid torus in $M = K'(\gamma)$.

If M contains an embedded Dyck's surface, then the theorem follows from Corollary 7.14. This includes the case where M has a 1-sided genus 2 Heegaard splitting. We assume hereafter that M contains no embedded Dyck's surface.

Thus M has 2-sided, genus 2 Heegaard splitting. Note that any such splitting is irreducible, since M is neither a lens space nor a connected sum ([9], [20]). Consequently, such a splitting is also strongly irreducible (the disjoint disks can be taken to be separating, hence to have isotopic boundaries).

Assume we have a genus 2 Heegaard splitting of M for which K does not have bridge number 0. Take K to be in bridge position. By Theorem 2.7, we may assume that K is also in thin position with respect to this Heegaard splitting of M . In S^3 , put K' into thin position with respect to the genus 0 Heegaard splitting. By Theorem 6.2 of [33] (by assumption K, K' cannot be isotoped onto their Heegaard surfaces), there exist thick level surfaces, \widehat{F} of M and \widehat{Q} of S^3 such that

(*) **each arc of $F \cap Q$ is essential in each of $F = \widehat{F} - N(K)$ and $Q = \widehat{Q} - N(K')$.**

As the exterior of K' is irreducible, after an isotopy we may assume:

(**) **there are no simple closed curves of $F \cap Q$ trivial in both F and Q .**

On \widehat{Q} and \widehat{F} form the *fat vertexed graphs of intersection* G_Q and G_F , respectively, consisting of the *fat vertices* that are the disks $\overline{N(K')} \cap \widehat{Q}$ and $\overline{N(K)} \cap \widehat{F}$ and *edges* that are the arcs of $F \cap Q$.

Choosing an orientation on $K \subset M$, we may number the intersections of K with \widehat{F} , and hence the vertices of G_F , from 1 to $t = |K \cap \widehat{F}|$ in order around K . Similarly, if $|K' \cap \widehat{Q}| = u$, by choosing an orientation on $K' \subset S^3$ we may number the intersections of K' with \widehat{Q} and hence the vertices of G_Q from 1 to u in order around K' .

Each component of ∂F intersects each component of ∂Q a total of Δ times. Thus a vertex of G_Q has valence Δt and a vertex of G_F has valence Δu . Since each component of $\partial F \cap \partial Q$ is an endpoint of an arc of $F \cap Q$, each endpoint of an edge in G_Q may be labeled with the vertex of G_F whose boundary contains the endpoint. Thus around the boundary of each vertex of G_Q the labels $\{1, \dots, t\}$ appear in order Δ times. Similarly around the boundary of each vertex of G_F the labels $\{1, \dots, u\}$ appear in order Δ times.

Now $t/2$ is the bridge number of K with respect to the Heegaard surface \widehat{F} . We show that $t \leq 2$, thereby implying that K is 0-bridge or 1-bridge with respect to this genus 2 splitting.

The arguments typically divide into the two cases:

- SITUATION NO SCC: There are no closed curves of $Q \cap F$ in the interior of disk faces of G_Q .
- SITUATION SCC: There are closed curves of $Q \cap F$ in the interior of disk faces of G_Q . The strong irreducibility of the Heegaard splitting allows us then to assume (section 3.1) that any such closed curve must be non-trivial on \widehat{F} and bound a disk on one side of \widehat{F} .

In SITUATION SCC there is then a meridian disk on one side of the genus 2 splitting that is disjoint from K and Q . This imposes strong restrictions on the graph G_F . Typically then, the arguments are simpler (though different) than those for SITUATION NO SCC.

Now assume that \widehat{F} is a Heegaard surface for M for which K has the smallest bridge number among genus 2 splittings of M . The paper is divided into sections ruling out various values of t , which are necessarily even as \widehat{F} is separating. Theorems 9.1, 10.1, 11.1 show in sequence $t < 10, t < 8, t < 6$ in both SITUATION NO SCC and SITUATION SCC. Theorem 13.2 then implies that $t \leq 2$ in SITUATION NO SCC, and Theorem 18.11 that $t \leq 2$ in SITUATION SCC. That is, K is at most 1-bridge with respect to the genus 2 splitting \widehat{F} .

To see that K (and hence K') has tunnel number at most 2, write K in M as the union of an arc in \widehat{F} and a trivial arc in a handlebody H on one side of \widehat{F} (this can be done if K is 0-bridge as well). Attaching two tunnels to K to form core curves of H thickens to a genus 3 handlebody whose complement is a handlebody in M . Thus the tunnel number of K is at most two. \square

Keeping track of when and how we are forced to modify the Heegaard splitting in the proof of Theorem 2.4 gives the following:

Theorem 2.6. *Let K' be a hyperbolic knot in S^3 . Let $H_B \cup_{\widehat{F}} H_W$ be a genus 2 (2-sided) Heegaard splitting of $M = K'(\gamma)$. Assume that $\Delta(\gamma, \mu) \geq 3$ where μ is the meridian of K' . Furthermore assume that M does not contain a Dyck's surface. Denote by K the core of the attached solid torus in M . Then either*

- (1) K is 0-bridge or 1-bridge with respect to a Heegaard splitting of M obtained from $H_B \cup_{\widehat{F}} H_W$ by a (possibly empty) sequence of adding/removing Möbius bands (Definition 1.1); or
- (2) M is a Seifert fiber space over the disk with three exceptional fibers, one of which has order 2 or 3, and K is 0-bridge or 1-bridge with respect to a Heegaard splitting gotten from a vertical Heegaard splitting of the Seifert fiber space M which has been changed by a (possibly empty) sequence of adding/removing Möbius bands; or
- (3) M is $n/2$ -surgery on a trefoil knot, n odd, and K is 0-bridge or 1-bridge with respect to the Heegaard splitting on M coming from the genus 2 splitting of the trefoil knot exterior. Note that in this case M is a Seifert fiber space over the 2-sphere with three exceptional fibers, one of order 2 and a second of order 3.

In particular, if M is not a Seifert fiber space over the 2-sphere with an exceptional fiber of order 2 or 3, and if the Heegaard surface \widehat{F} has no Möbius band on one side whose boundary is a primitive curve on the other, then K must be 0-bridge or 1-bridge with respect to the given splitting $H_B \cup_{\widehat{F}} H_W$.

Proof. Let $H_B \cup_{\widehat{F}} H_W$ be a genus 2 Heegaard splitting of M for which K is not 0-bridge or 1-bridge. As in the proof of Theorem 2.4, the arguments of sections 8–18 show, or can be adapted to show, that either

- M contains a Dyck's surface; or
- $H_B \cup_{\widehat{F}} H_W$ can be altered by adding/removing a Möbius band so that we get a new genus 2 splitting for which K has smaller bridge number; or
- M is a Seifert fiber space over the 2-sphere with an exceptional fiber of order 2 or 3 and we can find a vertical splitting of this Seifert fiber space for which K has smaller bridge number.
- M is an $n/2$ -surgery on the trefoil knot, n odd, and K is shown to be at most 1-bridge with respect to a genus 2 splitting of M coming from the Heegaard splitting of the trefoil exterior (i.e. remove a neighborhood of the unknotting tunnel from the exterior of the trefoil for one handlebody of the splitting of M , then the filling solid torus in union with a neighborhood of the unknotting tunnel is the other). This conclusion only occurs at the very end of section 18.

In sections 8–18, there are a few places where the argument given needs to be altered slightly to see that in fact one of the items above occurs. We have included remarks to that end when necessary. Repeated applications of the above alternatives leads to a genus 2 splitting of M with respect to which K is 0-bridge or 1-bridge as claimed by Theorem 2.6. Note that the statement there when M is a Seifert fiber space with an exceptional fiber of order 2 or 3 follows by starting with a vertical splitting of M . \square

We finish this section with the proof of Theorem 2.4 in the special case that thin position is not bridge position. Here the arguments of the preceding proof are applied to thin level surfaces rather than thick.

Theorem 2.7. *Let K' be a hyperbolic knot in S^3 . Assume there is a genus two Heegaard splitting of $M = K'(\gamma)$ with respect to which K , the core of the attached solid torus, has a thin position which is not a bridge position. If $\Delta(\gamma, \mu) \geq 3$ then M contains an embedded Dyck's surface.*

Proof. Let K', K, M be as given. Assume M has a genus 2 Heegaard splitting with respect to which K (in M) has a thin presentation which is not a bridge presentation. Note that this implies K is not isotopic onto the Heegaard surface of the splitting. As M is neither a lens space nor a connected sum, the splitting is irreducible and therefore strongly irreducible. Let \widehat{F} be a thin level surface — a level surface at a regular value of the height function such that the first critical level below the surface is a maximum and the first critical level above the surface is a minimum.

Lemma 2.8. *Let \widehat{F} be a thin level surface in a thin presentation of K . There is no trivializing disk D for a subarc α of K with respect to \widehat{F} . That is, there is no embedded disk $D \subset M$ such that*

- (1) *The interior of D is disjoint from K , and*
- (2) *$\partial D = \alpha \cup \beta$ where α is a subarc of K and β lies in \widehat{F} .*

Proof. After an isotopy we may assume that D lies above \widehat{F} near β and otherwise D intersects \widehat{F} transversely. Among all the arcs of $\text{Int } D \cap \widehat{F}$, let β' be outermost

with respect to β , and let D' be the outermost disk that it cuts from D . (If none exists take $\beta' = \beta$ and $D' = D$.) Then $\partial D' = \alpha' \cup \beta'$ where α' is a component of $K - \widehat{F}$. D' guides an isotopy of α' to β' , giving a positioning of K with smaller width, a contradiction. \square

In S^3 , put K' into thin position with respect to the genus 0 Heegaard splitting. The thin position argument of [15], shows that there exists a level surface \widehat{Q} of S^3 such that $F = \widehat{F} - N(K)$ and $Q = \widehat{Q} - N(K')$ intersect transversely and each arc of $F \cap Q$ is essential F . Furthermore, Lemma 2.8 shows that each arc of $F \cap Q$ is essential in Q ($\partial F, \partial Q$ are taken to intersect minimally on the boundary of the knot exterior). As the exterior of K' is irreducible, after an isotopy we may further assume there are no simple closed curves of $F \cap Q$ that are trivial in both F and Q .

We set up the fat vertexed graphs of intersection G_Q in \widehat{Q} and G_F in \widehat{F} as in the proof of Theorem 2.4, recording the intersection patterns of F and Q . Let $t = |\widehat{F} \cap K| > 0$.

Exactly as in the context of Theorem 2.4, there are two cases to consider:

- SITUATION NO SCC: There are no closed curves of $Q \cap F$ in the interior of disk faces of G_Q .
- SITUATION SCC: There are closed curves of $Q \cap F$ in the interior of disk faces of G_Q . The strong irreducibility of the Heegaard splitting allows us then to assume (section 3.1) that any such closed curve must be non-trivial on \widehat{F} and bound a disk on one side of \widehat{F} . In SITUATION SCC, there is then a meridian disk on one side of the genus 2 splitting that is disjoint from K and Q .

The arguments of sections 3, 4, and 5 apply just as in the context of Theorem 2.4 giving rise to ESCs and SCs, and their corresponding long Möbius bands and Möbius bands. The constituent annuli and Möbius bands of the long Möbius bands are almost properly embedded on either side of \widehat{F} , and they are properly embedded in SITUATION NO SCC.

We now have the following stronger versions of Lemmas 8.5 and 8.13.

Lemma 2.9. *Let σ be a proper $(n - 1)$ -ESC in G_Q . Let $A = A_1 \cup \cdots \cup A_n$ be the corresponding long Möbius band and let $a_i \in a(\sigma)$ be $\partial A_i - \partial A_{i-1}$ for each $i = 2 \dots n$ and $a_1 = \partial A_1$. Assume that, for some $i < j$, a_i, a_j cobound an annulus B in \widehat{F} . Then K must intersect the interior of B .*

Proof. The context of section 8 is that of Theorem 2.4, that K is in a bridge position that is also thin. However, the proof of Lemma 8.5 proves the above, using a thin presentation of K , and inserting Lemmas 2.8 and 2.3 when necessary. In particular, the final conclusion of Lemma 8.5, that V guides an isotopy of A_j to B , contradicts Lemma 2.8. \square

Lemma 2.10. *Assume M contains no Dyck's surface. If G_Q contains a proper r -ESC then $r \leq 1$. Furthermore, if σ is a proper 1-ESC then the two components of $a(\sigma)$ are not isotopic on \widehat{F} .*

Proof. Let σ be a proper $(n - 1)$ -ESC in G_Q for which n is largest. We assume $n \geq 2$. Let $A = A_1 \cup A_2 \cup \cdots \cup A_n$ be the long Möbius band associated to σ . Let $a(\sigma)$ be the collection of simple closed curves $a_i = \partial A_i \cap \partial A_{i+1}$. If no two elements

of $a(\sigma)$ are isotopic on \widehat{F} , then either $n = 3$ and a_1, a_2, a_3 cobound a 3-punctured sphere in \widehat{F} , contradicting (Lemma 8.12) that M contains no Dyck's surface, or $n = 2$ and we satisfy the second conclusion. Thus we assume a_i, a_j are isotopic on \widehat{F} for some $i < j$. Let B be the annulus cobounded by a_i, a_j on \widehat{F} . We may assume that the interior of B is disjoint from $a(\sigma)$.

Lemma 2.9 shows that there is a vertex x of $K \cap \text{Int } B$. Since, by Corollary 5.3, Λ_x contains a bigon, there is a proper ESC, ν , and a corresponding long Möbius band A^x whose boundary is a curve comprising two edges of Λ_x meeting at x and one other vertex. Therefore this curve cannot transversely intersect ∂B and thus must be contained in B . By Lemma 4.3, ν, σ must have the same core labels. But this contradicts the maximality of n . \square

Finally, observe

Lemma 2.11. *If G_Q contains a 1-ESC, σ , and an SC, τ , on disjoint label sets, then M contains a Dyck's surface.*

Proof. Let $A = A_1 \cup A_2$ be the long Möbius band corresponding to σ and A_3 the almost properly embedded Möbius band corresponding to τ . By Lemma 2.10, the components of ∂A_2 are not isotopic on \widehat{F} . Neither is isotopic to ∂A_3 , else M would contain a Klein bottle. By Lemma 8.12, M contains a Dyck's surface. \square

To finish the proof of the theorem, assume M contains no Dyck's surface. Lemmas 2.12, 2.13, 2.15, and 2.16 now eliminate the possibilities for t .

Lemma 2.12. $t < 8$

Proof. By Corollary 5.3 and Lemma 2.10, each label of G_Q belongs to a 1-ESC or to an SC. Assume $t \geq 8$. If G_Q contains no 1-ESC, then there are three SCs on disjoint label sets, and Lemma 8.11 contradicts that M contains no Dyck's surface.

So assume G_Q contains a 1-ESC, σ , on labels, say, $\{1, 2, 3, 4\}$ – i.e. whose core is a (23)-SC. By Lemma 2.11, the label 7 of G_Q belongs to a 1-ESC on labels $\{7, 8, 1, 2\}$. Similarly, label 6 must belong to a 1-ESC on labels $\{3, 4, 5, 6\}$. The latter 1-ESCs contradict Lemma 2.11. \square

Lemma 2.13. $t \neq 6$.

Proof.

Claim 2.14. *With $t = 6$, G_Q cannot have two 1-ESCs on different label sets whose core SCs lie on the same side of \widehat{F} .*

Proof. WLOG assume σ, σ' are 1-ESCs on labels $\{1, 2, 3, 4\}, \{3, 4, 5, 6\}$ (resp.). Let $A = A_1 \cup A_2, A' = A'_1 \cup A'_2$ be the long mobius bands corresponding to σ, σ' . First assume SITUATION NO SCC. Then A_2, A'_2 are (non-separating) incompressible annuli in a handlebody on one side of \widehat{F} intersecting is the single arc (34) of K . A boundary compressing disk of A_2 can be taken disjoint from A'_2 (or vice versa). This disk can be used to construct a trivializing disk for (34), contradicting Lemma 2.8.

So assume we are in SITUATION SCC and let D be a meridian disjoint from Q and K . As each component of ∂A_2 intersects $\partial A'_2$ in a single point, ∂D must be separating in \widehat{F} . In particular, one component of $\widehat{F} - \partial D$ contains vertices $\{2, 3, 6\}$ of G_F and the other contains vertices $\{4, 5, 1\}$. But the arcs (34), (61) of K contradict that D is separating on one side of \widehat{F} . \square

Assume $t = 6$. By Corollary 5.3 and Lemma 2.10, each of the six labels of G_Q belong to either a 1-ESC or SC in G_Q . If G_Q contains no 1-ESC, then G_Q must have three SCs on disjoint label sets. Lemma 8.11 shows that M contains a Dyck's surface. So assume G_Q contains a 1-ESC on labels, say, $\{1, 2, 3, 4\}$.

If G_Q also contains a 1-ESC on a different label set, then by Claim 2.14 and Lemma 2.11, we may assume it is on labels $\{2, 3, 4, 5\}$. Now label 6 must belong to a 1-ESC or an SC. A 1-ESC contradicts Claim 2.14, an SC contradicts Lemma 2.11.

So we assume all 1-ESCs are on label set $\{1, 2, 3, 4\}$. Corollary 5.3 then implies there is a (45)-SC and a (61)-SC (a (56)-SC contradicts Lemma 2.11). But then Lemma 8.11 says that M contains a Dyck's surface. \square

Lemma 2.15. $t \neq 4$.

Proof. Let $t = 4$. By Corollary 5.3, G_Q either contains a 1-ESC or two SCs on disjoint label sets. First assume we have SITUATION NO SCC. In the case of a 1-ESC a boundary compression of the associated incompressible annulus and in the case of two SCs a boundary compression of one Möbius band disjoint from the second, gives rise to a trivializing disk for an arc of $K - \widehat{F}$, contradicting Lemma 2.8.

So assume we are in SITUATION SCC, and let D be a meridian on one side of \widehat{F} disjoint from Q and K . Let \mathcal{N} be the solid torus or tori obtained by surgering the handlebody in which D lies along D , and that have non-empty intersection with K .

Assume G_Q has a 1-ESC, and let $A = A_1 \cup A_2$ be the associated long Möbius band. After an isotopy we may take A_1, A_2 as properly embedded in \mathcal{N} or its exterior. If A_2 lies in \mathcal{N} , then a boundary compression of A_2 in \mathcal{N} gives a trivializing disk for an arc of $K - \widehat{F}$. Thus A_2 lies outside of \mathcal{N} . If both components of ∂A_2 lie on the same component of \mathcal{N} , then $\mathcal{O} = N(\mathcal{N} \cup A_2)$ is Seifert fibered over the annulus with an exceptional fiber of order two. As the exterior of K is atoroidal and irreducible. Some component of $M - \text{Int } \mathcal{O}$ bounds a solid torus \mathcal{T} . As M is irreducible and atoroidal and as M is not a Seifert fiber space (Lemma 2.3), $\mathcal{O} \cup \mathcal{T}$ is a solid torus whose exterior in M has incompressible boundary. Again as the exterior of K is atoroidal and irreducible, K must be isotopic to a core of the solid torus $\mathcal{O} \cup \mathcal{T}$ and consequently to the core of \mathcal{N} . But then K can be isotoped to lie on the Heegaard surface – a contradiction. So we may assume N consists of two solid tori, each containing a component of ∂A_2 . But then a boundary compression of A_1 in the solid torus component containing it, gives rise to a trivializing disk for an arc of $K - \widehat{F}$.

So it must be that G_Q contains SCs on disjoint labels sets. Let A, A' be the corresponding almost properly embedded Möbius bands. As M contains no Klein bottle or projective plane, $\partial A, \partial A'$ must lie on different components of \mathcal{N} . Then D is a separating meridian of one side of \widehat{F} and must lie on the same side as the A, A' (by the separation of vertices of G_F). After surgering away simple closed curves of intersection, A and A' can be taken to be properly embedded Möbius bands in separate components of \mathcal{N} . Then a boundary compression of either gives rise to a trivializing disk for an arc of $K - \widehat{F}$. \square

Lemma 2.16. $t \neq 2$

Proof. By Corollary 5.3, G_Q contains an SC. Let A be the corresponding almost properly embedded Möbius band. In SITUATION NO SCC, A is properly embedded

on one side of \widehat{F} . A boundary compression of A then gives rise to a trivializing disk for an arc of $K - \widehat{F}$, contradicting Lemma 2.8. So we assume SITUATION NO SCC, and let D be a meridian disjoint from Q and K . Let \mathcal{N} be the solid torus obtained by surgering the handlebody in which D lies along D and taking that component containing ∂A . We may surger the interior of A off of $\partial \mathcal{N}$, so that A is properly embedded in \mathcal{N} or its exterior. If A now lies in \mathcal{N} , then a boundary compression of it will give rise to a trivializing disk for an arc of $K - \widehat{F}$. So we assume A is properly embedded in the exterior of \mathcal{N} and set $\mathcal{O} = N(\mathcal{N} \cup A)$. If ∂A is longitudinal in \mathcal{N} , then \mathcal{O} is a solid torus containing K . As M is not a lens space and the exterior of K is atoroidal and irreducible, K must be isotopic to a core of \mathcal{O} . On the other hand, the core L of \mathcal{N} is a $(2, 1)$ -cable of the core of \mathcal{O} , and hence of K . As L has tunnel number one in M , Claim 8.7 implies that K can be isotoped to lie on the Heegaard surface.

Thus we assume ∂A is not longitudinal in \mathcal{N} . Then \mathcal{N} is a Seifert fiber space over the disk with two exceptional fibers (M contains no projective planes). As both M and the exterior of K are irreducible and atoroidal, the exterior of \mathcal{O} is a solid torus, and M is a Seifert fiber space. This contradicts Lemma 2.3. \square

This completes the proof of Theorem 2.7. \square

3. MORE ON G_Q, G_F AND SIMPLE CLOSED CURVES OF $F \cap Q$

Assume K' is a hyperbolic knot in S^3 and $K'(\gamma)$ has a 2-sided genus 2 Heegaard splitting. Let $\widehat{F}, F, \widehat{Q}, Q$ be as in the proof of Theorem 2.4. Let G_Q, G_F be the labelled graphs of intersection defined there. In this section we define some terminology for G_Q, G_F , and discuss simple closed curves of intersection between Q and F .

On each of G_Q and G_F , if the labels around two vertices occur in the same direction (equivalently: the oriented intersections of K' with \widehat{Q} or K with \widehat{F} at those spots have the same signs) then we say the vertices are *parallel*; otherwise they are *anti-parallel*. The orientability of F and Q and the knot exterior gives the following

Parity Rule: *An edge connects parallel vertices on one of G_F, G_Q if and only if it connects anti-parallel vertices on the other.*

We may refer to an edge of G_F or G_Q with endpoints labeled 1 and 2, for example, as a $\overline{12}$ -edge. We will also say that $\{1, 2\}$ is the *label pair* of the edge.

In M , the Heegaard surface \widehat{F} bounds two genus 2 handlebodies H_B and H_W : $M = H_B \cup_{\widehat{F}} H_W$. We refer to H_B as *Black* and H_W as *White* and similarly color the objects inside them.

A *face* of G_Q is a component of the complement of the edges of G_Q in Q . We color it Black or White according to the side of \widehat{F} on which a small collar neighborhood of its boundary lies. The arcs of intersection between the boundary of a face and a vertex are the *corners* of the face; a vertex is chopped into corners. We shall refer to both the corners of G_Q between labels 2 and 3 and the arc of $K \subset M$ from intersection 2 to 3, for example, as (23) , as a (23) -corner, or as a (23) -arc. For a contiguous run of corners $(t1), (12), (23)$ around a vertex or arcs of K we may write $(t123)$.

Two edges of $F \cap Q$ are *parallel* on F or on Q if they cobound an embedded bigon in that surface (with corners on the vertices). We also refer to such edges as parallel on G_F or G_Q . Two faces g and g' of G_Q are *parallel* if there is an embedding of $g \times [0, 1]$ into $M - N(K)$ such that $g \times \{0\} = g$, $g \times \{1\} = g'$ and the components of $\partial g \times [0, 1]$ are alternately composed of rectangles on $\partial N(K)$ and parallelisms on F between edges of g and g' .

3.1. Simple closed curves of $Q \cap F$. The intersection graphs G_Q, G_F are given by the arc components of $F \cap Q$. However, there may also be simple closed curves in $Q \cap F$. By (**) of the proof of Theorem 2.4, we may assume no such curve is trivial on both Q and F . We show in this subsection that any such that is trivial on Q must, WLOG, be a meridian on one side of \widehat{F} .

Lemma 3.1. *No simple closed curve of $Q \cap F$ that is trivial in Q is trivial in \widehat{F} .*

Proof. Otherwise let $\widehat{D} \subset \widehat{F}$ be the disk bounded by such a simple closed curve. Let G_D be G_F restricted to \widehat{D} . By (**), G_D is non-empty. Then there are no 1-sided faces in G_D , and no 1-sided faces in the subgraph of G_Q corresponding to the edges of G_D . The argument of Proposition 2.5.6 of [9], along with the assumption that $\Delta \geq 3$, implies that one of G_D or G_Q contains a Scharlemann cycle. Such a Scharlemann cycle would imply the contradiction that either S^3 or M contains a lens space summand. \square

Corollary 3.2. *Any simple closed curve of $F \cap Q$ that is trivial on Q is a meridian of either H_W or H_B .*

Proof. This follows immediately from Lemma 3.1, Lemma 3.3 below, and the fact that $H_W \cup_{\widehat{F}} H_B$ is a genus 2, strongly irreducible Heegaard splitting of M . \square

For Corollary 3.2, we need the following which generalizes Proposition 1.5 and Lemma 2.2 of [36].

Lemma 3.3. *Let $M = H_W \cup_{\widehat{F}} H_B$ be a Heegaard splitting, where M is a closed 3-manifold other than S^3 . Let C be a simple closed curve in \widehat{F} such that*

- (1) *C does not bound a disk in H_W or H_B , and*
- (2) *C lies in a 3-ball in M .*

Then the splitting $H_W \cup_{\widehat{F}} H_B$ is weakly reducible.

Remark 3.4. By the uniqueness of Heegaard splittings of S^3 , Lemma 3.3 also holds when M is S^3 , provided $g(\widehat{F}) \neq 1$.

Proof. Since M is not S^3 , the boundary of the 3-ball containing C is essential in $M - C$, so $M - C$ is reducible. Since $M - C = H_W \cup_{\widehat{F}-C} H_B$, and H_W and H_B are irreducible, this implies that $\widehat{F} - C$ is compressible in H_W or H_B , say H_W .

Let \mathcal{D} be a maximal (with respect to inclusion) disjoint union of properly embedded disks in H_W such that $\partial \mathcal{D} \subset \widehat{F} - C$, no component of $\partial \mathcal{D}$ bounds a disk in $\widehat{F} - C$, and no pair of components of $\partial \mathcal{D}$ cobound an annulus in $\widehat{F} - C$. Note that $\mathcal{D} \neq \emptyset$. Let $H_{W_0} \subset H_W$ be the compression body determined by \mathcal{D} , i.e. H_{W_0} is obtained from a regular neighborhood $N(\widehat{F} \cup \mathcal{D})$ in H_W by capping off any 2-sphere boundary components of $\partial N(\widehat{F} \cup \mathcal{D})$ with 3-balls in H_W . Let $\partial_- H_{W_0} = \partial H_{W_0} - \widehat{F}$. Since C does not bound a disk in H_W by hypothesis, C is not contained in any 2-sphere component of $\partial N(\widehat{F} \cup \mathcal{D})$. By the maximality of \mathcal{D} , it follows that $\partial_- H_{W_0}$

has exactly one component, G , say, C is contained in G , and no component of $\partial\mathcal{D}$ bounds a disk in \widehat{F} .

Let $H_{W_1} \subset H_W$ be the handlebody bounded by G , and isotop C into $\text{Int } H_{W_1}$. By the maximality of \mathcal{D} , G is incompressible in $H_{W_1} - C$. This together with the irreducibility of H_{W_1} , implies also that $H_{W_1} - C$ is irreducible. Let $M_0 = H_B \cup H_{W_0}$. Since $M - C \cong M_0 \cup_G (H_{W_1} - C)$ is reducible, either M_0 is reducible or G is compressible in M_0 . This implies that the splitting of M_0 given by $H_{W_0} \cup_{\widehat{F}} H_B$ is reducible or weakly reducible, by [25] or [7], respectively. Hence the same holds for $H_W \cup_{\widehat{F}} H_B$. \square

Many of the arguments in later sections naturally divide themselves into the two basic cases:

- SITUATION NO SCC: There are no closed curves of $Q \cap F$ in the interior of disk faces of G_Q . In the later sections, this assumption will allow us to think of the faces of G_Q as disks in a Heegaard handlebody of M .
- SITUATION SCC: There are closed curves of $Q \cap F$ in the interior of disk faces of G_Q . By Corollary 3.2, any such curve must be non-trivial on \widehat{F} and bound a disk on one side of \widehat{F} . A disk face of G_Q containing such a curve does not sit in one Heegaard handlebody of M , hence some of the arguments applied in SITUATION NO SCC will not apply. However, an innermost such curve will supply a meridian disk D of either H_W or H_B which is disjoint from both K and Q . This places strong restrictions on G_F and yet the combinatorics of the faces of G_Q remain the same. Also, one can usually think of the faces of G_Q then as living in the exterior of \widehat{F} surgered along D . Together, these facts allow simpler, though somewhat different arguments in SITUATION SCC.

4. SCHARLEMANN CYCLES, (FORKED) EXTENDED SCHARLEMANN CYCLES, AND LONG MÖBIUS BANDS

4.1. SC, ESC, FESC. A *Scharlemann cycle* (of length n) is a disk face of G_Q or G_F with n edges, all with the same labels $\{a, b\}$, and all connecting parallel vertices of the graph. We use the same term for the set of edges defining the face. Typically, the Scharlemann cycles considered in this paper are on G_Q and of length 2, so we designate such by the abbreviation SC. For specificity, an (ab) -SC is one whose edges have labels $\{a, b\}$. A (23)-SC whose corners are on the vertices x and y is depicted in Figure 1(a). Though it is a rectangle, by virtue of alternatingly naming its sides ‘corners’ and ‘edges’, we call it a *bigon*. A *Scharlemann cycle of length 3* is shown in Figure 1(b). Its face is a *trigon*.

For $n \geq 0$, an n -times extended Scharlemann cycle of length 2, abbreviated n -ESC, is a set of $2(n+1)$ adjacent parallel edges and the $2n+1$ bigon faces they delineate between two parallel vertices of a fat vertexed graph such that the central bigon is a Scharlemann cycle of length 2. This central bigon is referred to as the *core Scharlemann cycle* for the n -ESC. When $n > 0$, we sometimes refer to an n -ESC as simply an “extended Scharlemann cycle”, abbreviated as “ESC”. Figure 1(c) shows a 2-ESC on the corner $(t12345)$. An n -ESC is called *proper* if in its corner no label appears more than once. As with SCs, to emphasize the labels along the corner of an ESC, we will also call an ESC on the corner $(t123)$, for example, an $(t123)$ -ESC.

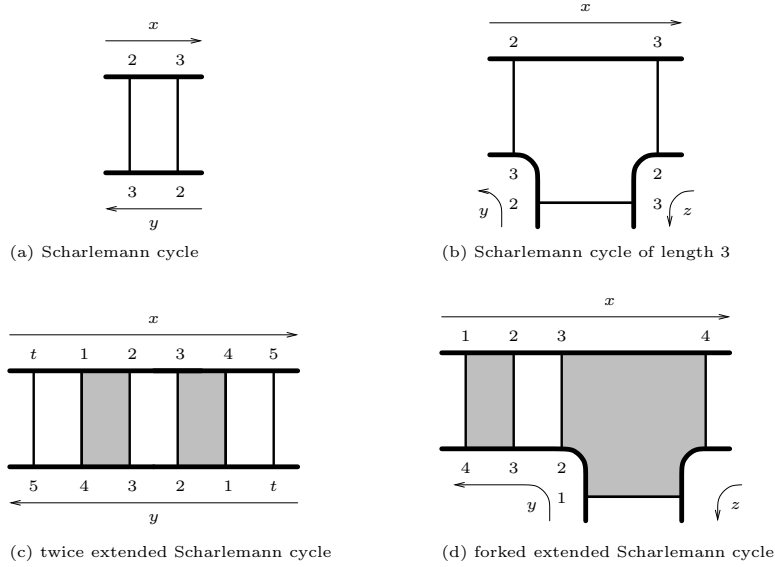

FIGURE 1.

A *forked n -times extended Scharlemann cycle* is an $(n-1)$ -times extended Scharlemann cycle of length 2 with an extra bigon and trigon at its two ends. Figure 1(d) shows a forked 1-time extended Scharlemann cycle. In this paper, a “forked extended Scharlemann cycle,” which is abbreviated “FESC,” means a forked 1-time extended Scharlemann cycle.

We will often use the letters σ and τ to refer to the sets of edges of these various sorts of SCs and the letters f , g , and h to refer to the faces within them.

4.2. Almost properly embedded surfaces, long Möbius bands.

Definition 4.1. Let H be a handlebody on one side of \widehat{F} . A surface, A , in M is *almost properly embedded in H* if

- (1) $\partial A \subset \widehat{F}$ and A near ∂A lies in H ;
- (2) $\text{Int } A$ is transverse to \widehat{F} and $A \cap \widehat{F}$ consists of ∂A along with a collection of simple closed curves, referred to as $\partial_I A$. Each component of $\partial_I A$ is trivial in A , essential in \widehat{F} , and bounds a disk on one side of \widehat{F} (i.e. is a meridian for H_W or H_B).

We use the disk faces of G_Q to build almost properly embedded surfaces in H_W, H_B .

Assume (23) is a White arc of $K \cap H_W \subset M$. By $N((23))$ we indicate the closed 1-handle neighborhood $I \times D^2$ of $(23) \subset H_W$ that is a component of $H_W - \text{Int}(M - N(K))$.

Let g be the bigon face of a (23)-SC of G_Q shown in Figure 2(a). Then in M the two corners of g both run along the 1-handle $N((23)) \subset H_W$ extending radially to the (23)-arc of K . This forms a White Möbius band $A_{23} = g \cup (23)$. Refer to Figure 2(b). If $\text{Int } g$ is disjoint from \widehat{F} , then A_{23} is properly embedded in H_W ; otherwise, by Corollary 3.2, it is almost properly embedded in H_W .

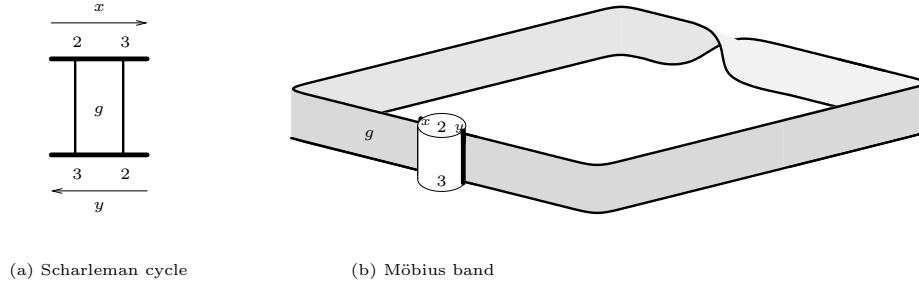

(a) Scharleman cycle

(b) Möbius band

FIGURE 2.

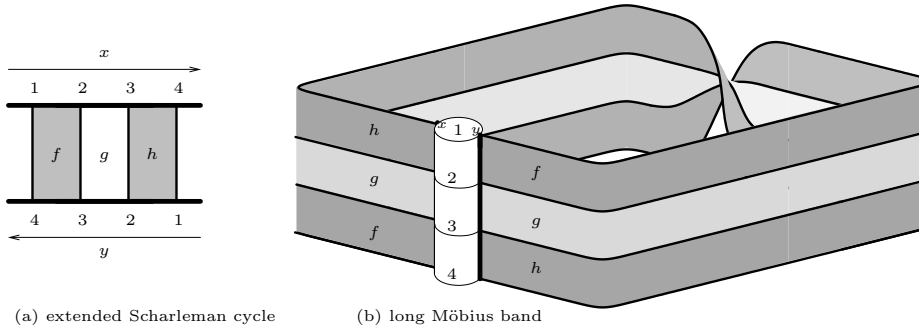

(a) extended Scharleman cycle

(b) long Möbius band

FIGURE 3.

Assume the two Black (12),(34)-bigons f and h flank g as in Figure 3(a). Identifying their corners to the arcs (12) and (34) of K accordingly in M forms a Black annulus $A_{12,34} = f \cup (12) \cup h \cup (34)$, which by Corollary 3.2 is almost properly embedded in H_B . As ∂A_{23} is a component of $\partial A_{12,34}$, together $A_{23} \cup A_{12,34}$ is a Möbius band. We regard it as a *long Möbius band* where the annulus $A_{12,34}$ extends the Möbius band A_{23} . See Figure 3(b). Note that the arc (1234) is a spanning arc of the long Möbius band.

More generally, given σ , an $(n-1)$ -times ESC ($n \geq 2$), we may again form a long Möbius band $A_1 \cup A_2 \cup \dots \cup A_n$ where A_1 is an almost properly embedded Möbius band arising from the core Scharlemann cycle and each A_i , $i \geq 2$, is an (almost properly embedded) extending annulus formed from successive pairs of flanking bigons. The A_i with odd indices i will have one color and those with even indices will have the other color. Let a_i denote the boundary component $\partial A_i \cap \partial A_{i+1}$. Let $a(\sigma) = \{a_i | i = 1, \dots, n-1\}$. Denote by $L(\sigma)$, the label set for σ , the set of labels appearing on a corner of σ . The *core labels* for σ are the two labels of its core Scharlemann cycle. For example, if σ is as in Figure 3(a), $L(\sigma) = \{1, 2, 3, 4\}$ and the core labels of σ are $\{2, 3\}$.

Generically we will use this notation, $A_1 \cup A_2 \cup \dots \cup A_n$, for a long Möbius band and its constituent annuli and Möbius band, but when $n \leq 3$ we will often use the notation $A_{23}, A_{12,34}, \dots$ described above to emphasize the arc of K on the long Möbius band or its constituent annuli.

The consideration of long Möbius bands falls into two basic contexts (see section 4.2):

- SITUATION NO SCC: There are no closed curves of $Q \cap F$ in the interior of disk faces of G_Q . Thus the annuli, Möbius band constituents of a long Möbius band are each properly embedded in H_W or H_B .
- SITUATION SCC: There are closed curves of $Q \cap F$ in the interior of disk faces of G_Q . By Corollary 3.2, any such curve must be non-trivial on \widehat{F} and bound a disk on one side of \widehat{F} . In this case the annuli, Möbius band constituents of a long Möbius band are each almost properly embedded on one side of \widehat{F} . Furthermore, there is a meridian disk D of either H_W or H_B which is disjoint from both K and Q .

The fact that in SITUATION SCC, the constituent annuli of the long Möbius bands are almost properly embedded rather than properly embedded, complicates the picture of these surfaces. On the other hand, the existence of the meridian disk D in this case (disjoint from Q), greatly restricts what Q can look like, and usually simplifies the arguments considerably.

We finish this subsection by describing some properties of long Möbius bands.

Lemma 4.2. *Let σ be an n -ESC, $n \geq 0$. Then no component of $a(\sigma)$ bounds a disk on either side of \widehat{F} .*

Proof. Otherwise, the long Möbius band corresponding to σ coupled with the meridian disk bounded by the component of $a(\sigma)$ can be used to create an embedded projective plane in M . Since M is $K'(\gamma)$, where $\Delta \geq 3$, this contradicts either [20] or [9]. \square

Lemma 4.3. *Let σ be a proper n_1 -ESC and τ a proper n_2 -ESC of G_Q . If there are components a_σ, a_τ of $a(\sigma), a(\tau)$ (resp.) that are isotopic on \widehat{F} , then σ, τ have the same core labels.*

Addendum: *Let D be a meridian disk of H_B, H_W disjoint from K and Q . Let F^* be \widehat{F} surgered along D . If components a_σ, a_τ of $a(\sigma), a(\tau)$ (resp.) are isotopic on F^* , then σ, τ have the same core labels.*

Proof. The argument for the Addendum is the same as that for the Lemma with F^* replacing \widehat{F} , so we give only the argument for the Lemma itself.

For the proof of this Lemma, we use *ESC* to refer to an n -ESC for which $n \geq 0$. Let $A(\sigma), A(\tau)$ be the long Möbius bands corresponding to σ, τ . By possibly working with ESCs within σ, τ , we may assume $a_\sigma = \partial A(\sigma)$ and $a_\tau = \partial A(\tau)$. We write $A(\sigma) = E_\sigma \cup F_\sigma, A(\tau) = E_\tau \cup F_\tau$ where F_σ, F_τ is the union of faces of σ, τ (resp.) (thought of as disks in, X_K , the exterior of K) and where E_σ, E_τ are rectangles in $N(K)$ describing an extension of F_σ, F_τ across $N(K)$ to form the long Möbius band. Thus, $\partial E_\sigma \cap \partial X_K = \partial F_\sigma \cap \partial X_K$ and $\partial E_\tau \cap \partial X_K = \partial F_\tau \cap \partial X_K$. In all but Case IV' below (and Case II when σ, τ have the same core labels), we will choose E_σ, E_τ to be disjoint, making $A(\sigma), A(\tau)$ disjoint long Möbius bands whose boundaries are isotopic on \widehat{F} . Such long Möbius bands can be used to construct an embedded projective plane or Klein bottle in M (note that each component of $A(\sigma) \cap \widehat{F}$ is either a component of $a(\sigma)$ or a meridian of H_W, H_B ; the same for $A(\tau)$). This contradicts either [9], [20], or [22]. Thus in each case below, it suffices to show how to construct the desired E_σ, E_τ .

Let $\{x, z\}$ be the extremal labels of σ , and $\{y, w\}$ the extremal labels of τ . Let $\{\alpha, \beta\}$ be the corners of σ , $\{\alpha', \beta'\}$ the corners of τ (thought of as arcs in ∂X_K). See Figure 4.

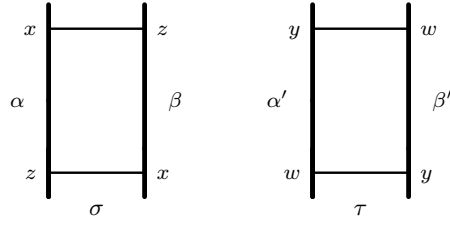

FIGURE 4.

Let $L(\sigma), L(\tau)$ denote the label set of σ, τ .

Case I: $L(\sigma) \cap L(\tau) = \emptyset$

In this case E_σ, E_τ are automatically disjoint, and $A(\sigma), A(\tau)$ can be used to construct the forbidden projective plane or Klein bottle.

Case II: $L(\tau) \subset L(\sigma)$

We may assume that, say, $y \neq x, z$. Let b_σ be the component of $a(\sigma)$ through vertex y – connecting y to another vertex r . If $r = w$, then σ, τ have the same core labels and we are done.

Thus we assume $r \neq y, w, x, z$ ($r \neq y$ by the Parity Rule). Then b_σ intersects a_τ in a single point (at the vertex y). Since b_σ is disjoint from a_σ , and a_σ is isotopic to a_τ on \widehat{F} , b_σ must intersect a_τ tangentially. That is, as one transverses around (fat) vertex y of G_F the labels $\{\alpha, \beta\}$ are not separated by the labels $\{\alpha', \beta'\}$. Thus in $N(K)$, we may choose disjoint E_σ, E_τ as pictured in Figure 5 (thereby making $A(\sigma), A(\tau)$ disjoint).

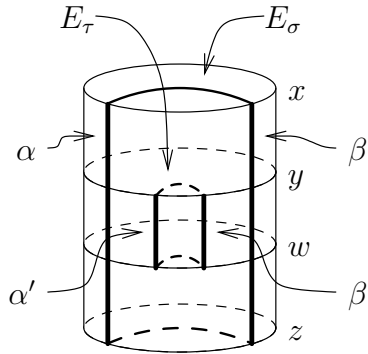

FIGURE 5.

Case III: $L(\sigma) \cap L(\tau)$ is a single interval of labels (xy) (including a point interval).

First we consider the case of a point interval, that is, when $x = y$ (and Case II does not hold). Then a_σ, a_τ intersect in a single point (at vertex $x = y$). As a_σ, a_τ are isotopic on \widehat{F} , they must be non-transverse around vertex x on G_F . This means that as one reads around vertex x on G_F , labels $\{\alpha, \beta\}$ do not separate the labels

$\{\alpha', \beta'\}$. We choose disjoint E_σ, E_τ as pictured in Figure 6 (with $x = y$), making $A(\sigma), A(\tau)$ disjoint.

Thus we may assume that $\{x, z\} \cap \{y, w\} = \emptyset$. Let b_σ be the component of $a(\sigma)$ through vertex y . Then b_σ intersects a_τ in a single point (at y). Again b_σ is disjoint from a_σ which is isotopic to a_τ , so b_σ must intersect a_τ tangentially. Thus, as one transverses vertex y in G_F the $\{\alpha, \beta\}$ labels do not separate $\{\alpha', \beta'\}$. We then may choose disjoint E_σ, E_τ as pictured in Figure 6.

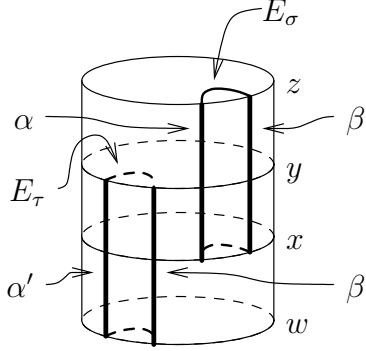

FIGURE 6.

Case IV: $L(\sigma) \cap L(\tau)$ contains all labels of G_Q , and $L(\sigma)$ overlaps $L(\tau)$ in two intervals of labels: (xy) and (wz) . See Figure 7.

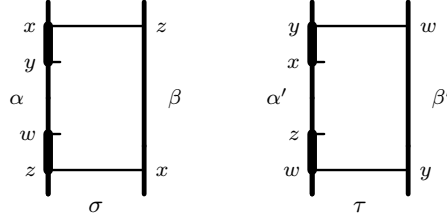

FIGURE 7.

If $\{x, z\} = \{y, w\}$ then $\partial A(\sigma), \partial A(\tau)$ are isotopic on \widehat{F} and both go through vertices x, z of \widehat{F} . Thus $A(\sigma), A(\tau)$ can be amalgamated along their boundary to create an embedded Klein bottle.

Next assume that $x = y$ but $z \neq w$. Let b_σ be the component of $a(\sigma)$ through vertex w . As b_σ is disjoint from a_σ and intersects a_τ once at w , b_σ and a_τ intersect non-transversely. Thus around vertex w , the labels $\{\alpha, \beta\}$ do not separate $\{\alpha', \beta'\}$. Similarly, as a_σ, a_τ intersect in a single point at vertex x and yet are isotopic, their intersection is non-transverse. That is, around vertex x , the labels $\{\alpha, \beta\}$ do not separate $\{\alpha', \beta'\}$. Figure 8 (with $x = y$) shows that we can choose disjoint E_σ, E_τ .

Thus we may assume $\{x, z\} \cap \{y, w\} = \emptyset$. Let b_σ be the component of $a(\sigma)$ through vertex y , and let r be the other vertex of G_F to which b_σ is incident. Then $r \neq x, z$.

Assume $r \neq w$. Then as b_σ intersects a_τ once and is disjoint from a_σ , it must intersect a_τ non-transversely. That is, around vertex y the labels $\{\alpha, \beta\}$ do not separate $\{\alpha', \beta'\}$. Let c_σ be the component of $a(\sigma)$ through vertex w . Again, c_σ must intersect a_τ non-transversely at w . Hence around w in G_F , the labels $\{\alpha, \beta\}$ do not separate $\{\alpha', \beta'\}$. Thus we may choose disjoint disks E_σ, E_τ in $N(K)$ as pictured in Figure 8.

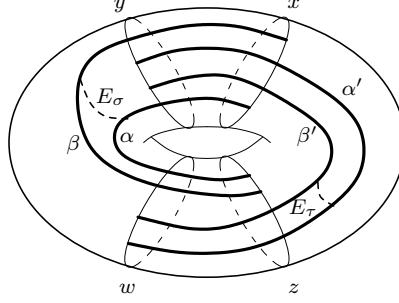

FIGURE 8.

This leaves us with the case that $r = w$, whose argument is slightly different from the preceding ones.

Case IV': In Case IV above $r = w$.

This is the case when the core labels of σ, τ are “antipodal” labels. Let b_σ be the component of $a(\sigma)$ through vertices y and w of G_F . Then b_σ and a_τ intersect twice. Since b_σ is disjoint from a_σ which is isotopic to a_τ , the algebraic intersection number of b_σ and a_τ is 0. Thus we can choose E_σ, E_τ in $N(K)$ so that they are either (1) disjoint or (2) intersect in exactly two arcs. See Figure 9. This follows since the labels $\{\alpha, \beta\}$ must separate $\{\alpha', \beta'\}$ either (1) around neither vertices y, w or (2) around both vertices y, w .

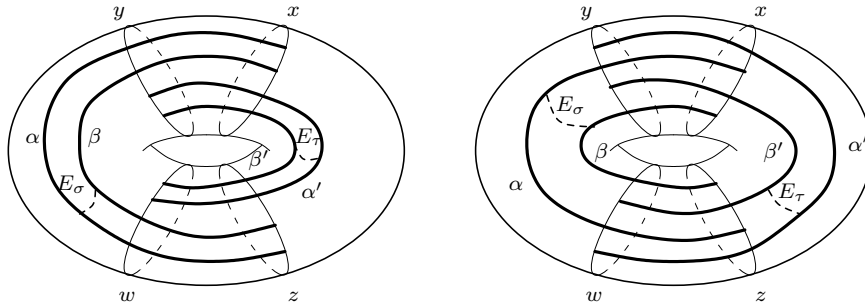

FIGURE 9.

Let B be the annulus on \widehat{F} between a_σ and a_τ . If $\text{Int } B$ contains a vertex u of G_F (i.e. a vertex other than x, y, w, z), then there must be another, v , such that u, v lie on the same component of $a(\sigma)$ or $a(\tau)$. If only one, say $a(\sigma)$, then we let σ' be the ESC within σ on labels u, v . Then we may apply the argument of Case I to σ', τ . If u, v lie on components of both $a(\sigma)$ and $a(\tau)$, then we let σ', τ' be the ESC

within σ, τ (resp.) with labels $\{u, v\}$. We apply the argument at the beginning of Case III (when $\{x, z\} = \{y, w\}$).

Thus we may assume $\text{Int } B$ is disjoint from the vertices of G_F . Consider $A(\sigma) = E_\sigma \cup F_\sigma, A(\tau) = E_\tau \cup F_\tau$ where F_σ, F_τ is the union of faces of σ, τ . Then $A(\sigma), A(\tau)$ are either (1) disjoint or (2) intersect in two double arcs (from x to y and w to z along K). If (1), M contains an embedded Klein bottle. If (2), $S = A(\sigma) \cup B \cup A(\tau)$ is a Klein bottle that self-intersects in a single double-curve (note that the core of B cannot be a meridian of H_W, H_B else we obtain a projective plane from $A(\sigma)$). Thus we may assume $A(\sigma), A(\tau)$ are disjoint from B except along $a(\sigma), a(\tau)$. The two preimage curves are disjoint from the cores of each of $A(\sigma), A(\tau)$, and B , and consequently bound disjoint disks, Möbius bands in the pre-image. We may surger along the double curve to obtain an embedded projective plane or Klein bottle in M . \square

5. COMBINATORICS

Let G_Q, G_F be the graphs of intersections defined in the proof of Theorem 2.4.

5.1. Great webs. Say a label around a vertex of a subgraph Λ of G_Q is a *ghost label* of Λ if no edge of Λ is incident to the vertex at that label. A *ghost edge* is an edge of G_Q incident to a ghost label. Let ℓ denote the number of ghost labels, or equivalently the number of ghost edges counted with multiplicity. Recall $t = |K \cap \widehat{F}|$ and hence is the number of vertices of G_F .

A *g-web* Λ is a connected subgraph of G_Q whose vertices are parallel (section 3) and has at most $t + 2g - 2$ ghost labels: $\ell \leq t + 2g - 2$. If U is a component of $\widehat{Q} - \Lambda$ then we say $D = \widehat{Q} - U$ is a *disk bounded by* Λ . A *great g-web* is a *g-web* Λ such that there is a disk bounded by Λ containing only vertices of Λ . When Λ is a great *g-web* this disk is unique (since there must be vertices of G_Q anti-parallel to those in Λ) and so we say it is *the* disk bounded by Λ .

For each label x , the subgraph of a great *g-web* Λ consisting of all vertices of Λ and edges of Λ with an endpoint labeled x is denoted Λ_x . Say an x -label on a vertex of Λ_x is a *ghost x-label* if the edge incident to it does not belong to Λ_x . Let ℓ_x denote the total number of ghost x -labels of Λ_x . Observe that a ghost x -label of Λ_x is a ghost label of Λ .

Given a great *g-web* Λ and a disk D bounded by Λ containing only vertices of Λ , the disk D_Λ that is the closure of $\widehat{Q} - D$ is the *outside face* of Λ ; all other faces of Λ are *ordinary faces* and are contained in D . A corner (section 3) of a vertex v of Λ is *outside* or *ordinary* according to whether it is the corner of an outside or ordinary face. A vertex v of Λ is an *outside* vertex if and only if it has an outside corner, otherwise it is an *ordinary* vertex.

Lemma 5.1 ([17], Theorem 6.1). *Since $\Delta \geq 3 > 2$ and \widehat{F} has genus 2, then G_Q contains a great 2-web Λ .*

5.2. The abundance of bigons. Let Λ be a great *g-web* of G_Q . Its existence is ensured by Lemma 5.1.

Lemma 5.2. *If $\Delta \geq 3$ and $t \geq g - 1$ then either Λ_x contains a bigon for each label x or Λ has just one vertex and $t = g - 1$.*

Proof. First consider the case that Λ has just one vertex. Then Λ may have no edges, else G_Q would have a monogon. Therefore $\Delta t = \ell \leq t + 2g - 2$. Since $\Delta \geq 3$, this implies $t \leq g - 1$. Thus if $t \geq g - 1$ and Λ has just one vertex, then $t = g - 1$.

Now fix a label x . We will show if Λ_x does not contain a bigon but has more than one vertex, then $g - 2 \geq t$.

Regard Λ_x as a graph contained in \widehat{Q} . First we assume Λ_x is connected. Refer to the sole face of $\Lambda_x \subset \widehat{Q}$ that is not contained in the disk bounded by Λ as the *outside face* of Λ_x . Assume the outside face has $k \geq 1$ corners. We count vertices (corners) and edges in a face locally, i.e. the same edge or vertex of G_Q may contribute more than once to k .

Let V , E , and F denote the number of vertices, edges, and faces of Λ_x . By the Parity Rule (section 3), $E = \Delta V - \ell_x$. Let k_i be the number of corners in the outside face of Λ_x with exactly i ghost x -labels. Then $k = \sum_{i=0}^{\Delta} k_i$ and $\ell_x = \sum_{i=1}^{\Delta} i k_i$. (Recall that a vertex has at most Δ x -labels.)

Suppose Λ_x contains no bigons. Then

$$\begin{aligned} 2E &\geq 3(F - 1) + k = 3F + (k - 3) \\ F &\leq 2/3E - 1/3(k - 3) \\ 2 = V - E + F &\leq V - E + 2/3E - 1/3(k - 3) \\ E &\leq 3V - (k + 3) \end{aligned}$$

Hence $(\Delta - 3)V + (k + 3) \leq \ell_x$. Because the outer face of Λ_x has k corners, some corner(s) of the outer face must have more than one ghost x -label.

Let V_2 be the number of corners in the outer face with exactly 2 ghost x -labels. Let $V_{\geq 3}$ be the number of corners in the outer face with at least 3 ghost x -labels. Since a corner may have at most Δ ghost x -edges, $\Delta \geq 3$, and $k + \Delta \leq (\Delta - 3)V + (k + 3) \leq \ell_x$, then

$$(\dagger) \quad V_2 + 2V_{\geq 3} \geq 3 \quad \text{and} \quad V_2 + V_{\geq 3} \geq 2.$$

(The count $k + \Delta \leq \ell_x$ shows that, at worst, each of the k corners has at least one ghost x -edge though there are at least Δ more. Since a corner has at most Δ ghost x -labels, there must be at least 2 corners with more than one ghost x -label. Hence $V_2 + V_{\geq 3} \geq 2$. Since $\Delta \geq 3$, the possible distributions of these last Δ ghost x -labels implies $V_2 + 2V_{\geq 3} \geq 3$.)

Since there are $t - 1$ labels between two consecutive ghost x -labels on a corner of the outer face, there are at least $(t + 1)V_2$ ghost labels on all corners of the outer face with exactly 2 ghost x -labels. (No ghost labels of Λ are separated by a cycle of edges in Λ .) Similarly there are at least $(2t + 1)V_{\geq 3}$ ghost labels on all corners of the outer face with at least 3 ghost x -labels. Therefore if ℓ is the total number of ghost labels for Λ , then

$$(\ddagger) \quad t + 2g - 2 \geq \ell \geq (t + 1)V_2 + (2t + 1)V_{\geq 3} = t(V_2 + 2V_{\geq 3}) + (V_2 + V_{\geq 3}) \geq 3t + 2.$$

Hence $g - 2 \geq t$.

Now assume Λ_x is not connected. Observe that (\dagger) holds for each connected component of Λ_x with at least 2 vertices, using V_2 and $V_{\geq 3}$ to count the corners of the component's outside face.

Consider a component Λ_x^a of Λ_x . To each interval between consecutive ghost x -labels on a corner of its outside face we associate at least $t - 1$ different ghost labels of Λ : If all edges incident to the interval are actually ghost labels of Λ , then we

use these. If there is an edge of Λ in this interval, then (because the ghost x -labels bounding the interval cannot be separated by a cycle in Λ) removing from Λ all edges, \mathcal{E} , incident to this interval disconnects Λ , one component of which contains our initial component Λ_x^a . Another component of $\Lambda - \mathcal{E}$ contains a component Λ_x^b of Λ_x where all the edges of $\Lambda - \Lambda_x$ incident to the outside face of Λ_x^b lie in a single interval on a corner of its outside face between consecutive x -labels of the vertex giving that corner. If Λ_x^b has at least two vertices, then by (\dagger) there must be another corner of its outside face with two consecutive ghost x -labels yielding at least $t+1$ ghost edges that we may associate to the original interval. If Λ_x^b has only one vertex then its labels outside this single interval, at least $\Delta t - (t-1) \geq 2t+1$ of them, are all ghost labels that we may associate to the original interval.

If Λ_x^a has at least two vertices, then (\ddagger) still holds with V_2 and $V_{\geq 3}$ counting corners of Λ_x^a and the associations above. If Λ_x^a has just one vertex, then since it has no edges (else G_Q would have a monogon) and there is another component of Λ_x we may associate, as above, more than Δt ghost labels to Λ_x^a . In either case we may conclude that $t < g-1$. \square

Corollary 5.3. *If $\Delta \geq 3$ and $g = 2$ then Λ_x contains a bigon for each label x . Thus, for each label x , Λ contains a proper ESC or SC with (outermost) label x .*

Proof. Apply Lemma 5.2 with $g = 2$ to get the first statement. Note that if Λ were to have just one vertex, then $t = 1$ which cannot be. The second statement follows immediately from the first, as a bigon face of Λ_x corresponds to an ESC or SC of Λ . \square

5.3. Special vertices. By Lemma 5.1 we have a great 2-web $\Lambda \subset G_Q$ that resides in the sphere \widehat{Q} .

Here we seek the existence of a so-called *special* vertex of our great 2-web Λ with a large number of ordinary corners incident to bigons, though permitting fewer bigons at the expense of a greater number of trigons.

Definition 5.4. Let \mathcal{V} be the set of vertices of Λ . At each vertex $v \in \mathcal{V}$ let $\phi_i(v)$ count the number of its ordinary corners incident to i -gon faces of Λ . We have that $\sum_i \phi_i(v) \leq \Delta t$ for each vertex v . This an equality if and only if v is ordinary. Since only the outside face of Λ may be a monogon, $\phi_1(v) = 0$ for all v . Thus we shall write $\phi(v) = (\phi_2(v), \phi_3(v), \dots)$.

Definition 5.5. Let F_i denote the number of faces of Λ (including the outside face) that are i -gons; let \overline{F}_i denote the number of ordinary faces of Λ that are i -gons. The total number of faces of Λ is thus $F = \sum_i F_i = 1 + \sum_i \overline{F}_i$. Furthermore $i\overline{F}_i = \sum_{v \in \Lambda} \phi_i(v)$ for each i and also $2E = \sum_i iF_i$.

Definition 5.6. Let $\rho = (\rho_2, \rho_3, \rho_4, \dots)$ be a sequence of non-negative integers. We say that ρ is of *type* $[k_2, \dots, k_m]$ if

$$\rho_2 = k_2, \quad \dots, \quad \rho_{m-1} = k_{m-1}, \quad \text{and} \quad \rho_m \geq k_m.$$

A vertex v is said to be of *type* $[k_2, \dots, k_m]$ if $\phi(v)$ is of type $[k_2, \dots, k_m]$.

Each integer $N \geq 2$ gives a *weight* to which we associate a measure of a sequence of integers $\rho = (\rho_2, \rho_3, \dots)$:

$$\alpha_N(\rho) = \sum_{i=2}^N \binom{N-i}{i} \rho_i$$

We say that v is a *special vertex (of weight N)* of Λ if

$$\alpha_N(\phi(v)) > \frac{N-2}{2}\Delta t - N.$$

Recall that since Λ is a 2-web, the number of ghost labels ℓ is at most $t+2$. Hence setting V to be the total number of vertices of Λ and E to be the number of edges, then $2E = \Delta tV - \ell$.

Proposition 5.7. *Assume the outside face of Λ is a k -gon. Then for any integer $N \geq 2$ there exists a vertex v of Λ with*

$$\alpha_N(\phi(v)) \geq \left(\left(\frac{N-2}{2} \right) \Delta t - N \right) + \frac{k + N - \left(\frac{N-2}{2} \right) \ell}{V}$$

with equality only if $\bar{F}_i = 0$ for $i > N$. In particular, using that $\ell \leq t+2$,

$$\alpha_N(\phi(v)) \geq \left(\left(\frac{N-2}{2} \right) \Delta t - N \right) + \frac{k + 2 - \left(\frac{N-2}{2} \right) t}{V}.$$

Proof. Multiplying the equation $\sum F_i = F = E - V + 2$ by N and subtracting $\sum iF_i = 2E$ yields:

$$\begin{aligned} \sum (N-i)F_i &= (N-2)E - NV + 2N \\ \sum_{i=2}^N (N-i)F_i &= \left(\frac{N-2}{2} \right) 2E - NV + 2N + \sum_{i>N} (i-N)F_i \\ \sum_{i=2}^N (N-i)\bar{F}_i &= \left(\frac{N-2}{2} \right) (\Delta tV - \ell) - NV + 2N + \sum_{i>N} (i-N)\bar{F}_i + (k-N) \\ \sum_{i=2}^N (N-i)\bar{F}_i &\geq \left(\left(\frac{N-2}{2} \right) \Delta t - N \right) V + \left(k + N - \left(\frac{N-2}{2} \right) \ell \right) \end{aligned}$$

with equality only if $\bar{F}_i = 0$ for $i > N$.

Since $i\bar{F}_i = \sum_{v \in \mathcal{V}} \phi_i(v)$ for all i ,

$$\sum_{i=1}^N (N-i)\bar{F}_i = \sum_{v \in \mathcal{V}} \sum_{i=1}^N \left(\frac{N-i}{i} \right) \phi_i(v) = \sum_{v \in \mathcal{V}} \alpha_N(\phi(v)).$$

Hence

$$(\diamond) \quad \sum_{v \in \mathcal{V}} \alpha_N(\phi(v)) \geq \left(\left(\frac{N-2}{2} \right) \Delta t - N \right) V + \left(k + N - \left(\frac{N-2}{2} \right) \ell \right).$$

Therefore there exists a vertex v such that

$$\alpha_N(\phi(v)) \geq \left(\left(\frac{N-2}{2} \right) \Delta t - N \right) + \frac{k + N - \left(\frac{N-2}{2} \right) \ell}{V}$$

as claimed.

Furthermore, using that $\ell \leq t+2$,

$$\alpha_N(\phi(v)) \geq \left(\left(\frac{N-2}{2} \right) \Delta t - N \right) + \frac{k + 2 - \left(\frac{N-2}{2} \right) t}{V}$$

□

Proposition 5.8. *Assume there are j distinct outside vertices v_1, \dots, v_j with v_i contributing k_i corners to the outside face of Λ (so that the outside face is a k -gon where $k = \sum_{i=1}^j k_i$). If Λ has an ordinary vertex, then for any integer $N \geq 2$ there exists an ordinary vertex v with*

$$\alpha_N(\phi(v)) > \left(\binom{N-2}{2} \Delta t - N \right) + \frac{N(1 + \frac{1}{2}k - j)}{V - j}.$$

Proof. Let ℓ_{v_i} be the number of ghost labels incident to the outside vertex v_i . If v_i contributes k_i corners to the outside face, then v_i has $\Delta t - \ell_{v_i} - k_i$ ordinary corners. Since there can be no ordinary monogons,

$$\alpha_N(\phi(v_i)) \leq \left(\frac{N-2}{2} \right) (\Delta t - \ell_{v_i} - k_i)$$

where equality is only possible in the event that every ordinary face incident to v_i is a bigon. Assuming Λ has an ordinary vertex, then this cannot be an equality for every outside vertex. This induces the strict inequality in the calculation below.

Continuing from (\diamond) in the proof of Proposition 5.7 (which is an equality only if every ordinary face has N sides or less),

$$\sum_{\mathcal{V} \setminus \{v_1, \dots, v_j\}} \alpha_N(\phi(v)) + \sum_{i=1}^j \alpha_N(\phi(v_i)) \geq \left(\binom{N-2}{2} \Delta t - N \right) V + \left(k + N - \binom{N-2}{2} \ell \right).$$

Thus

$$\begin{aligned} \sum_{\mathcal{V} \setminus \{v_1, \dots, v_j\}} \alpha_N(\phi(v)) &\geq \left(\binom{N-2}{2} \Delta t - N \right) (V - j) + \left(\binom{N-2}{2} \Delta t - N \right) j \\ &\quad + \left(k + N - \binom{N-2}{2} \sum_{i=1}^j \ell_{v_i} \right) - \sum_{i=1}^j \alpha_N(\phi(v_i)) \\ &> \left(\binom{N-2}{2} \Delta t - N \right) (V - j) + \left(\binom{N-2}{2} \Delta t - N \right) j \\ &\quad + \left(N + k - \binom{N-2}{2} \sum_{i=1}^j \ell_{v_i} \right) - \sum_{i=1}^j \left(\frac{N-2}{2} \right) (\Delta t - \ell_{v_i} - k_i) \\ &= \left(\binom{N-2}{2} \Delta t - N \right) (V - j) - Nj + (N + k) + \left(\frac{N-2}{2} \right) k \\ &= \left(\binom{N-2}{2} \Delta t - N \right) (V - j) + N(1 + \frac{1}{2}k - j). \end{aligned}$$

Thus there exists an ordinary vertex $v \in \mathcal{V} \setminus \{v_1, \dots, v_j\}$ such that

$$\alpha_N(\phi(v)) > \left(\binom{N-2}{2} \Delta t - N \right) + \frac{N(1 + \frac{1}{2}k - j)}{V - j}.$$

□

5.3.1. *The existence of special vertices.* In most of the following lemmas, we conclude that our great 2-web Λ either has a special vertex or a large number of mutually parallel edges. In the applications of these lemmas such numbers of mutually parallel edges will be prohibited thereby implying the existence of a special vertex.

Lemma 5.9. *If $t = 8$ then Λ either has a special vertex v of weight $N = 3$ or 19 mutually parallel edges.*

Proof. By Proposition 5.7 there exists a vertex $v \in \Lambda$ such that

$$\alpha_3(\phi(v)) \geq (4\Delta - 3) + \frac{k-2}{V}$$

where k is the length of the outside face. Thus if $k \geq 3$ then v is special.

If $k = 1$ or 2 , then let $j \leq k$ be the number of vertices contributing to the k outside corners. If Λ has an ordinary vertex, then by Proposition 5.8 there exists an ordinary vertex $v \in \Lambda$ such that

$$\alpha_3(\phi(v)) > (4\Delta - 3) + \frac{3(1 + \frac{1}{2}k - j)}{V - j}$$

This is the special vertex.

If Λ has no ordinary vertices and $j = 1$, then each edge of Λ must bound a monogon. This cannot occur.

Thus we now assume Λ has no ordinary vertices and $(k, j) = (2, 2)$. Then all ordinary faces of Λ are bigons. Since there may be at most 10 ghost edges, Λ consists of two vertices and at least $8\Delta - 5 \geq 19$ mutually parallel edges. \square

Lemma 5.10. *If $t = 6$ then Λ either has a special vertex of weight $N = 4$ or 8 mutually parallel edges.*

Proof. By Proposition 5.7 there exists a vertex $v \in \Lambda$ such that

$$\alpha_4(\phi(v)) \geq (6\Delta - 4) + \frac{k-4}{V}$$

where k is the length of the outside face. Thus if $k \geq 5$ then v is special. Therefore assume $k = 1, 2, 3$, or 4 and $j \leq k$ is the number of vertices contributing to the k outside corners.

If Λ has no ordinary vertex then the only vertices of Λ are the j outside vertices. Consider the reduced graph of Λ obtained by amalgamating mutually parallel edges in the disk bounded by Λ . Assuming Λ does not have 8 mutually parallel edges, each edge of this reduced graph represents at most 7 edges. Thus a vertex (of this reduced graph) of valence n must have at least $6\Delta - 7n$ ghost edges. Since $\Delta \geq 3$, a valence 1 vertex has at least 11 ghost edges and a valence 2 vertex has at least 4 ghost edges. Since the total number of incidences of ghost edges to Λ is at most 8 there can be no valence 1 vertices and no more than two valence 2 vertices. Hence it must be that $(k, j) = (4, 4)$ where there the reduced graph has two valence 2 vertices. The remaining two vertices of Λ have no ghost labels and must be of valence 3. Both these vertices have $\phi = (6\Delta - 3, 2)$ and are thus special vertices of weight $N = 4$.

Now assume there is an ordinary vertex in Λ . Then by Proposition 5.8 there exists an ordinary vertex $v \in \Lambda$ such that

$$\alpha_4(\phi(v)) > (6\Delta - 4) + \frac{4(1 + \frac{1}{2}k - j)}{V - j}.$$

Hence v is necessarily special unless (k, j) is $(4, 4)$ or $(3, 3)$. For these two situations we must push the proof of Proposition 5.8 further:

Let v_1, \dots, v_k be the outside vertices of Λ . Since $k = j$, each outside vertex has just one outside corner. Again ℓ_{v_i} denotes the number of ghost labels on the outside corner of v_i . Then v_i has $6\Delta - \ell_{v_i} - 1$ ordinary corners which occur consecutively.

Assume Λ does not have 8 mutually parallel edges. Then there may be at most 6 consecutive bigons. Let n_i be the number of ordinary corners of v_i that do not belong to bigons. Then

$$\begin{aligned} \alpha_4(\phi(v_i)) &\leq \left(\frac{N-2}{2}\right) (\Delta t - \ell_{v_i} - 1 - n_i) + \left(\frac{N-3}{3}\right) n_i \\ &= \left(\frac{N-2}{2}\right) (\Delta t - \ell_{v_i} - 1) - \frac{N}{6} n_i \end{aligned}$$

and hence

$$\alpha_4(\phi(v_i)) \leq (6\Delta - \ell_{v_i} - 1) - \frac{2}{3} n_i.$$

If for some i , $\ell_{v_i} = 0$ and $n_i \leq 2$, then v_i is a special vertex of weight $N = 4$. So we assume this is not the case. Since $\Delta \geq 3$, $n_i \leq 1$ implies that $n_i = 1$ and $\ell_{v_i} \geq 4$. If there are two v_i with $n_i = 1$, then, as $\ell = \sum \ell_{v_i} \leq t + 2 = 8$, all others have no ghost labels. Together these observations mean that $\sum_{i=1}^k n_i \geq 2k - 1$.

Hence

$$\begin{aligned} \sum_{i=1}^k \alpha_4(\phi(v_i)) &\leq \sum_{i=1}^k \left((6\Delta - \ell_{v_i} - 1) - \frac{2}{3} n_i \right) \\ &= (6\Delta - 1)k - \sum_{i=1}^k \ell_{v_i} - \sum_{i=1}^k \frac{2}{3} n_i \\ &\leq (6\Delta - 1)k - \ell - \frac{2}{3}(2k - 1). \end{aligned}$$

Thus, again continuing from (\diamond) in the proof of Proposition 5.7 (as we did in the proof of Proposition 5.8) where now $j = k$,

$$\begin{aligned} \sum_{v \setminus \{v_1, \dots, v_k\}} \alpha_N(\phi(v)) &\geq \left(\left(\frac{N-2}{2} \right) \Delta t - N \right) (V - k) + \left(\left(\frac{N-2}{2} \right) \Delta t - N \right) k \\ &\quad + \left(k + N - \left(\frac{N-2}{2} \right) \ell \right) - \sum_{i=1}^k \alpha_N(\phi(v_i)) \end{aligned}$$

so that

$$\begin{aligned}
\sum_{\mathcal{V} \setminus \{v_1, \dots, v_k\}} \alpha_4(\phi(v)) &\geq (6\Delta - 4)(V - k) + (6\Delta - 4)k + (4 + k - \ell) - \sum_{i=1}^k \alpha_4(\phi(v_i)) \\
&\geq (6\Delta - 4)(V - k) + (6\Delta - 4)k + (4 + k - \ell) \\
&\quad - (6\Delta - 1)k + \ell + \frac{2}{3}(2k - 1) \\
&= (6\Delta - 4)(V - k) - 4k + 4 + k + k + \frac{4}{3}k - \frac{2}{3} \\
&= (6\Delta - 4)(V - k) + \frac{10 - 2k}{3}.
\end{aligned}$$

Therefore there is an ordinary vertex $v \in \mathcal{V} \setminus \{v_1, \dots, v_k\}$ such that

$$\alpha_4(\phi(v)) \geq (6\Delta - 4) + \frac{10 - 2k}{3(V - k)}.$$

Since $k = 3$ or 4 , $10 - 2k > 0$. Hence

$$\alpha_4(\phi(v)) > 6\Delta - 4.$$

Thus v is a special vertex. This completes the proof of Lemma 5.10. \square

Lemma 5.11. *If $t = 4$ then Λ either has a special vertex v of weight $N = 4$ or 9 mutually parallel edges.*

Proof. By Proposition 5.7 there exists a vertex $v \in \Lambda$ such that

$$\alpha_4(\phi(v)) \geq (4\Delta - 4) + \frac{k - 2}{V}$$

where k is the length of the outside face. Thus if $k \geq 3$ then v is special.

If Λ has an ordinary vertex, then Proposition 5.8 implies there is a special vertex of weight $N = 4$ if $k = 1, 2$. Thus we assume Λ has no ordinary vertex and $k = 1, 2$. Let $j \leq k$ be the number of vertices contributing to the outside corners.

Since Λ contains no ordinary vertices, any loop edge must bound a monogon (1-sided face) – which does not happen in G_Q . Thus $j \neq 1$. Thus $(k, j) = (2, 2)$, Λ consists of two vertices, and all the ordinary faces are bigons between the two vertices. Since there may be at most 6 ghost edges, these bigons must be induced by at least $4\Delta - 3 \geq 9$ mutually parallel edges. \square

5.3.2. *Types of special vertices.* See Definition 5.6 for vertex type.

Lemma 5.12. *A special vertex of weight $N = 3$ has type $[t\Delta - 5]$.*

Proof. If v is a special vertex of weight $N = 3$, then

$$\alpha_3(\phi(v)) = \frac{1}{2}\phi_2(v) > \frac{1}{2}t\Delta - 3.$$

Hence $\phi_2(v) > t\Delta - 6$. Thus $\phi_2(v) \geq t\Delta - 5$ and v is of type $[t\Delta - 5]$. \square

Lemma 5.13. *A special vertex of weight $N = 4$ has type $[\Delta t - 5, 4]$, $[\Delta t - 4, 1]$, or $[\Delta t - 3]$.*

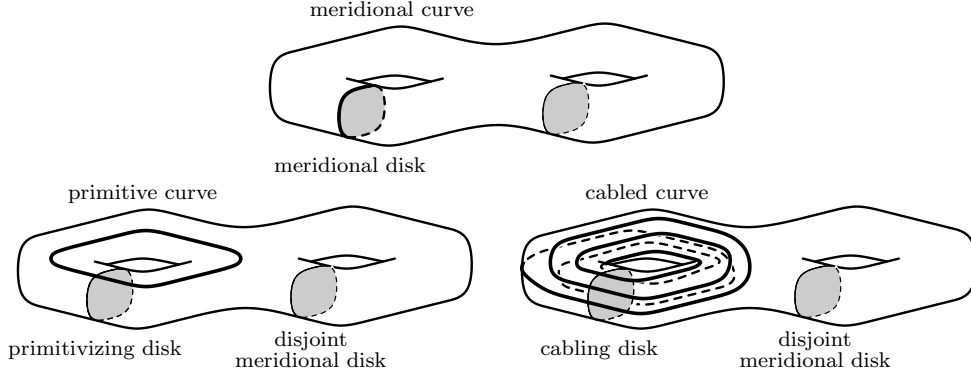

FIGURE 10.

Proof. If v is a special vertex of weight $N = 4$, then

$$\alpha_4(\phi(v)) = \phi_2(v) + \frac{1}{3}\phi_3(v) > \Delta t - 4.$$

Hence $3\phi_2(v) + \phi_3(v) > 3\Delta t - 12$. Then since $\phi_2(v) + \phi_3(v) \leq \Delta t$, we have $2\phi_2(v) \geq 2\Delta t - 11$. Thus $\phi_2(v) \geq \Delta t - 5$.

In order to maintain that $\alpha_4(\phi(v)) > \Delta t - 4$,

- if $\phi_2(v) = \Delta t - 5$ then $\phi_3(v) \geq 4$;
- if $\phi_2(v) = \Delta t - 4$ then $\phi_3(v) \geq 1$; and
- if $\phi_2(v) = \Delta t - 3$ then $\phi_3(v) \geq 0$.

The conclusion now follows. \square

6. ELEMENTARY SURFACES IN GENUS 2 HANDLEBODIES

Handlebodies are irreducible. Every properly embedded connected surface in a handlebody is either compressible, ∂ -compressible, the sphere, or the disk.

Throughout this article we will repeatedly be considering disks, annuli, and Möbius bands that are properly embedded in a genus 2 handlebody H and the results of chopping the handlebody along these surfaces.

6.1. Definitions and notation. On the boundary of a solid torus \mathcal{T} a non-separating simple closed curve c is:

- *meridional* if it bounds a (meridional) disk in \mathcal{T} ;
- *longitudinal* (or *primitive*) if it transversely intersects a meridian of \mathcal{T} once and thus runs once around \mathcal{T} ; or
- *cabled* if it is neither meridional nor longitudinal and thus runs more than once around \mathcal{T} .

Analogously, there are three notable types of non-separating simple closed curves c on the boundary of a genus 2 handlebody H depicted in Figure 10.

- If c bounds a disk in H , then c is *meridional* or a *meridian*. The disk is a compressing disk which, in this case, we also describe as *meridional*. (Note: In later sections we refer to any compressing disk for the handlebody to be a meridian, regardless of whether or not it is separating.)

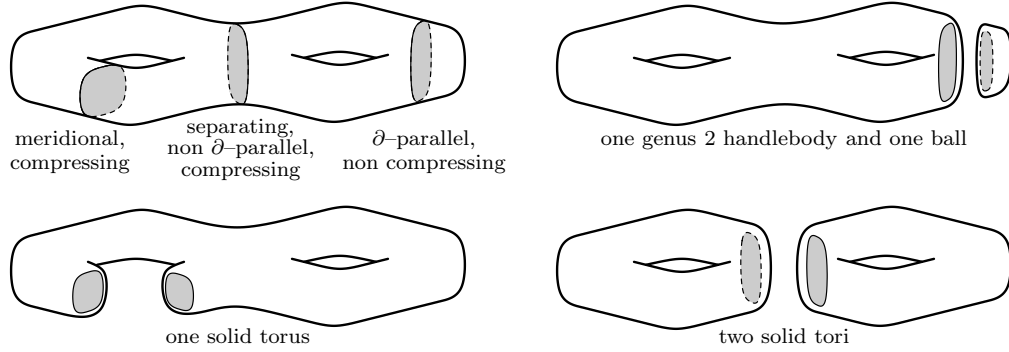

FIGURE 11.

- If there is a compressing disk of H whose boundary transversely intersects c once, then c is *primitive*. We say such a meridional compressing disk is a *primitivizing* disk for c . Given a primitivizing disk for a primitive curve there is necessarily a meridional compressing disk disjoint from both.
- If c is neither meridional nor primitive and there is a disjoint meridional compressing disk for H then c is *cabled*. A meridional disk of H whose boundary transversely intersects c non-trivially and coherently (with respect to some chosen orientations) is a *cabling* disk if there is another meridional disk disjoint from both it and c .

Indeed, in each of the three cases there is a non-separating compressing disk D for H that is disjoint from c . Then c is an essential simple closed curve on the boundary of the solid torus $H \setminus D$. Hence c is either meridional on $H \setminus D$ and H , longitudinal on $H \setminus D$ and primitive on H , or wound $n > 1$ times longitudinally on $H \setminus D$ and cabled on H .

Denote the attachment of a 2-handle to H along c by $H \langle c \rangle$.

- If c is primitive, then $H \langle c \rangle$ is a solid torus.
- If c is cabled, then $H \langle c \rangle$ is the connect sum of a solid torus and a non-trivial lens space.

6.2. Disks in genus 2 handlebodies. Let D be a disk properly embedded in the genus 2 handlebody H . Then we have the following trichotomy depicted in Figure 11:

- D is a non-separating compressing disk; $H \setminus D$ is one solid torus.
- D is a separating compressing disk; $H \setminus D$ is two solid tori.
- D is ∂ -parallel; $H \setminus D$ is one genus 2 handlebody and one 3-ball.

6.3. Annuli. Let A be an incompressible annulus properly embedded in the genus 2 handlebody H . Then we have the following trichotomy:

- A is a non-separating annulus. In this case, ∂A is non-separating on ∂H .
- A is a separating but not ∂ -parallel annulus. In this case, ∂A also bounds an annulus on ∂H .
- A is a ∂ -parallel annulus. Again, ∂A bounds an annulus on ∂H .

Examples of the first two situations are depicted in Figures 12 and 13.

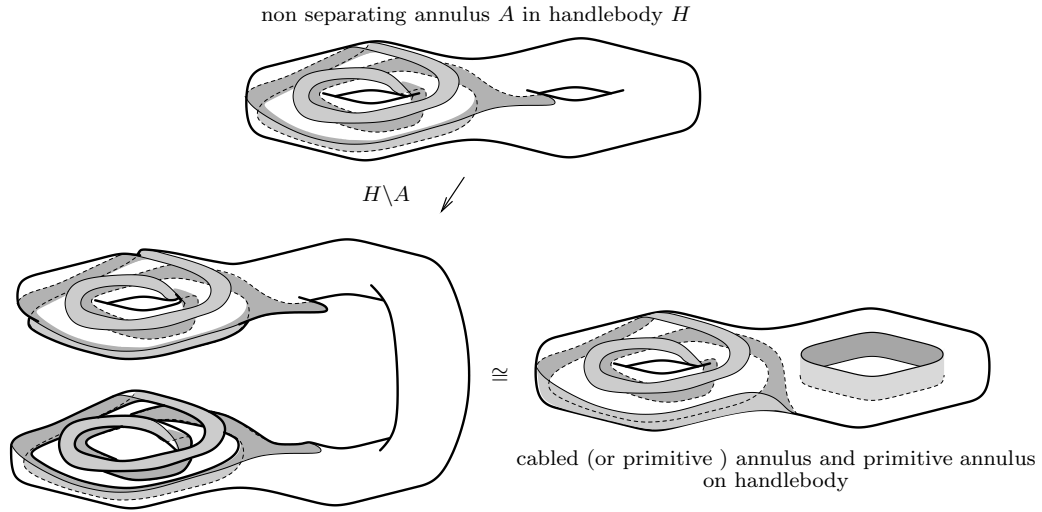

FIGURE 12.

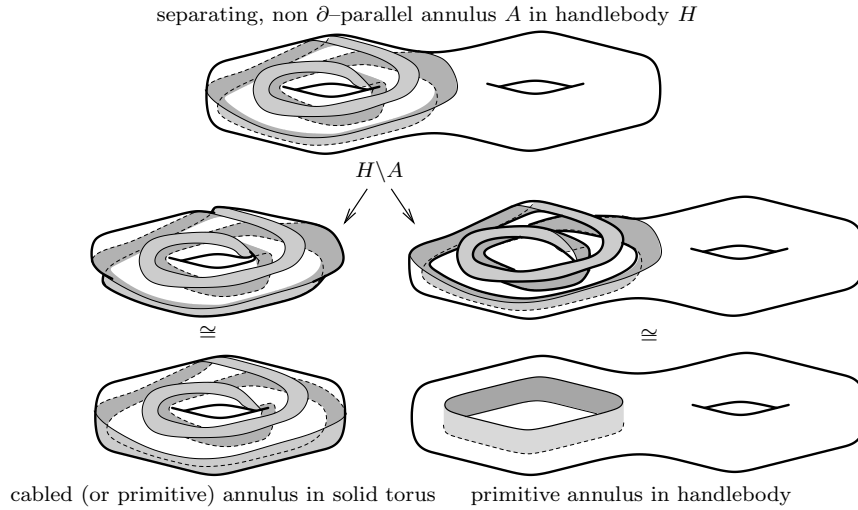

FIGURE 13.

Let d be a ∂ -compressing disk for A . Then $\partial N(A \cup d) - \partial H$ is a properly embedded disk D and a parallel copy of A in H . Let A_+ be the impression of A on the side of $H \setminus A$ containing d . Let A_- be the other impression of A . Then one of the following occurs (situations (2) and (3) are not exclusive):

- (1) If D is non-separating, then A is non-separating; $H \setminus A$ is a genus 2 handlebody on which A_+ is primitive and A_- either primitive or cabled. See Figure 12.
- (2) If D is separating, then A is separating; $H \setminus A$ is a genus 2 handlebody on which A_+ is primitive and a solid torus \mathcal{T} on which A_- is either primitive or cabled. See Figure 13.

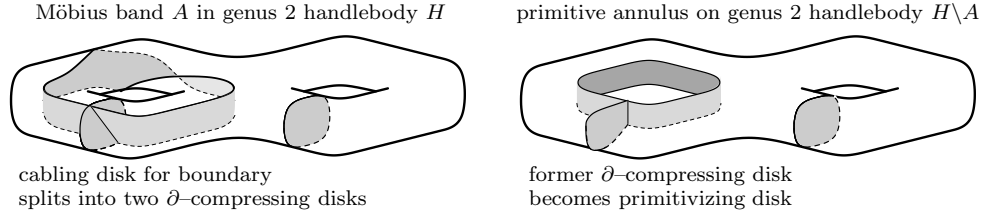

FIGURE 14.

- (3) If D is ∂ -parallel, then A is ∂ -parallel; $H \setminus A$ is a genus 2 handlebody on which A_- lies and a solid torus \mathcal{T} on which A_+ is primitive.

In each of these situations d becomes a primitivizing disk for A_+ in $H \setminus A$.

We say an annulus, A , in a handlebody, H , is *primitive* if there is a meridian disk of H that intersects A in a single essential arc. Note that an annulus is primitive if and only a component of its boundary is primitive in the ambient handlebody.

6.4. Möbius bands. Let A be an incompressible Möbius band properly embedded in the genus 2 handlebody H . Let d be a ∂ -compressing disk for A . Then $\partial N(A \cup d) - \partial H$ is a properly embedded disk D . The disk D is separating and not ∂ -parallel in H . Therefore $H \setminus D$ is two solid tori, one of which contains the Möbius band A . Because there is a unique embedding of a Möbius band in a solid torus (up to homeomorphism):

- Up to homeomorphism, there is a unique embedding of a Möbius band A in a genus 2 handlebody H ; $H \setminus A$ is a genus 2 handlebody on which the annular impression of A is primitive.

A ∂ -compressing disk for A in H becomes a primitivizing disk for the impression of A in $H \setminus A$. This is depicted in Figure 14.

6.5. Cores of Handlebodies. A curve embedded in the interior of the solid torus $D^2 \times S^1$ is a *core* if it is isotopic to $\{z\} \times S^1$ for some point $z \in D^2$. A curve c embedded in the interior of a handlebody H is a *core* if it is the core of a solid torus connect summand of H . This is equivalent to saying c is isotopic to a primitive curve in ∂H .

7. OBTAINING DYCK'S SURFACE BY SURGERY.

A closed, connected, compact, non-orientable surface with Euler characteristic -1 is the connect sum of three projective planes. It is known as a *cross cap number 3 surface* and as *Dyck's surface* [13].

If a knot K' in S^3 has maximal Euler characteristic spanning surface S with $\chi(S) = -1$ (so that K' has genus 1 or cross cap number 2) then surgery on K' along a slope γ of distance 2 from ∂S produces a manifold with Dyck's surface embedded in it. There is a Möbius band embedded in the surgery solid torus whose boundary coincides with ∂S so that together they form an embedded Dyck's surface \tilde{S} . The core of the surgery solid torus is the core of the Möbius band, and hence the surgered knot lies as a simple closed curve on \tilde{S} . Furthermore, such a surgery slope γ may be chosen so that it has any desired odd distance $\Delta = \Delta(\gamma, \mu)$ from the S^3 meridian μ of K' . We conjecture that this is the only way a Dyck's surface arises from a non-integral Dehn surgery on a hyperbolic knot:

Conjecture 7.1. *Let K' be a hyperbolic knot in S^3 and assume that $K'(\gamma)$ contains an embedded Dyck's surface. If $\Delta = \Delta(\gamma, \mu) > 1$, where μ is a meridian of K' , then there is an embedded Dyck's surface, $\widehat{S} \subset K'(\gamma)$, such that the core of the attached solid torus in $K'(\gamma)$ can be isotoped to an orientation-reversing curve in \widehat{S} . In particular, K' has a spanning surface with Euler characteristic -1 .*

The following goes a long way towards verifying this conjecture.

Theorem 7.2. *Let K' be a hyperbolic knot in S^3 and assume that $M = K'(\gamma)$ contains an embedded Dyck's surface. If $\Delta = \Delta(\gamma, \mu) > 1$, where μ is a meridian of K' , then there is an embedded Dyck's surface in M that intersects the core of the attached solid torus in M transversely once.*

Proof. The proof of this Theorem occupies most of this section. Initially it closely follows §6 and §7 of [22] where an analogous theorem is proven for a Klein bottle. We refer the reader to these sections and note where the proofs diverge in our situation.

For homological reasons (see e.g. Lemma 6.2, [22]), or just by explicit construction of a closed non-orientable surface in the exterior of K' , if M were to contain an embedded closed non-orientable surface, then Δ cannot be even. Hence we assume $\Delta \geq 3$ and odd.

Assume that a Dyck's surface does embed in $M = K'(\gamma)$. Note that any embedding of Dyck's surface in M must be incompressible since otherwise a compression would produce an embedded Klein bottle or projective plane; neither of these may occur since $\Delta > 1$.

Let K be the core of the attached solid torus in $M = K'(\gamma)$. As S^3 contains no embedded Dyck's surface there is no such surface in M that is disjoint from K . Thus if K can be isotoped onto a Dyck's surface in M , it must be as an orientation-reversing curve, and can thus be perturbed to intersect the surface transversely once. So we may assume this does not happen. Among all embeddings of Dyck's surfaces in M that intersect K transversely, take \widehat{S} to be one that intersects K minimally. Let \widehat{T} be the closed orientable genus 2 surface that is the boundary of a regular neighborhood of \widehat{S} . Let S and T be the intersection of \widehat{S} and \widehat{T} respectively with the exterior E of K' . Let $t = |\partial T| = 2|\partial S|$. As mentioned above, we assume $t > 0$. The goal is to show that $t = 2$.

Let \widehat{Q} be a 2-sphere in S^3 . As in [22], via thin position we may assume \widehat{Q} intersects K' (in S^3) transversely so that $Q = \widehat{Q} \cap E$ intersects S transversely and no arc component of $Q \cap S$ is parallel in Q to ∂Q or parallel in S to ∂S . Moreover, as T “double covers” S , Q intersects T transversely and no arc component of $Q \cap T$ is parallel in Q to ∂Q or parallel in T to ∂T . We may now form the labeled fat vertexed graphs of intersection G_Q in \widehat{Q} and G_T in \widehat{T} whose edges are the arc components of $Q \cap T$ as well as the graphs G_Q^S in \widehat{Q} and G_S in \widehat{S} whose edges are the arc components of $Q \cap S$. Furthermore, the incompressibility of \widehat{S} allows us to assume no disk face of either G_Q^S or G_Q contains a simple closed curve component of $Q \cap S$ or $Q \cap T$ respectively.

The proofs in §2 of [22] go through for the pair G_Q and G_T after replacing “web” with “2-web” throughout to accommodate that T has genus 2 rather than 1. In particular, Theorem 6.3 of [22] becomes

Lemma 7.3. *G_Q contains a great 2-web.*

We refer to the side of \widehat{T} containing \widehat{S} as *Black* and the other side as *White*. Correspondingly the faces of G_Q are divided into Black and White faces. Each Black face of G_Q is a bigon and corresponds to an edge of G_Q^S .

Lemma 7.4 (cf. Theorem 6.4 [22]). *If $t \geq 4$ then no Scharlemann cycle in G_Q of any length bounds a White face.*

Proof. The proof of Theorem 6.4 [22] goes through replacing the Klein bottle with Dyck's surface. \square

Lemma 7.5 (cf. Theorem 6.5 [22]). *If $\sigma_1, \sigma_2, \sigma_3,$ and σ_4 are SCs in G_Q , then two of them must have the same pair of labels.*

Proof. Assuming no two of the SCs have the same label pair, it must be that $t \geq 4$. Since the faces of each of these SCs must be Black by Lemma 7.4, then their label pairs are all mutually distinct. Hence they give rise to four disjoint Möbius bands properly embedded in the Black side of \widehat{T} . Their intersections with \widehat{S} form four mutually disjoint orientation reversing curves. But this contradicts that \widehat{S} is the connect sum of only three projective planes. \square

Lemma 7.6 (cf. Theorem 6.6 [22]). *If $t \geq 6$ then G_Q does not contain a 1-ESC (see section 4.1).*

Proof. Follow the proof of Theorem 6.6 [22] until the last three sentences. Recall there is a Möbius band A such that $\partial A = \hat{\alpha}$ and the core curve of A is $\hat{\beta}$. An arc of K is a spanning arc of A . On \widehat{S} the curves $\hat{\alpha}$ and $\hat{\beta}$ are disjoint, embedded non-trivial loops. On \widehat{S} $\hat{\alpha}$ is orientation preserving and $\hat{\beta}$ is orientation reversing. A small neighborhood of $\hat{\beta}$ on \widehat{S} is a Möbius band B .

If $\hat{\alpha}$ is separating, then on \widehat{S} it must bound either a Möbius band, once-punctured Klein bottle, or once-punctured torus P that is disjoint from $\hat{\beta}$. If P is a Möbius band, then $P \cup A$ is a Klein bottle. By assumption (since $\Delta > 2$) this cannot occur. If P is a once-punctured Klein bottle or once-punctured torus, then $\widehat{P} = P \cup A$ is a closed non-orientable surface with $\chi = -1$. We may now perturb \widehat{P} to be transverse to K and have fewer intersections with K . This contradicts the minimality of \widehat{S} .

If $\hat{\alpha}$ is non-separating then consider the annulus $A' = A \setminus \hat{\beta}$. Then A' may be pushed off A keeping $\partial A'$ on \widehat{S} so that $\partial A'$ is a push-off of $\hat{\alpha}$ and ∂B . Then cutting \widehat{S} open along $\hat{\alpha}$ and ∂B , we may attach A and A' to the resulting boundary components to form \widehat{P} , a new embedded instance of Dyck's surface. Again we may now perturb \widehat{P} to be transverse to K and have fewer intersections with K . This contradicts the minimality of \widehat{S} . \square

Let \mathcal{L} be the set of labels of G_Q that are labels of SCs in G_Q .

Lemma 7.7 (cf. Theorem 6.7 [22]). *If $t \geq 6$ then $|\mathcal{L}| \geq (4t - 2)/5$.*

Proof. The proof is the same as that of Theorem 4.3 [22], using Lemma 7.3 instead of its Corollary 2.7 and Lemma 7.6 instead of its Theorem 3.2. \square

Lemma 7.8. *t is not a positive multiple of 4.*

Proof. If $t = 4k$, then $|K \cap \widehat{S}| = 2k$. Therefore \widehat{S} may be tubed k times along K to form a closed non-orientable surface in the exterior of K . This forms a closed, embedded, non-orientable surface in S^3 : a contradiction. \square

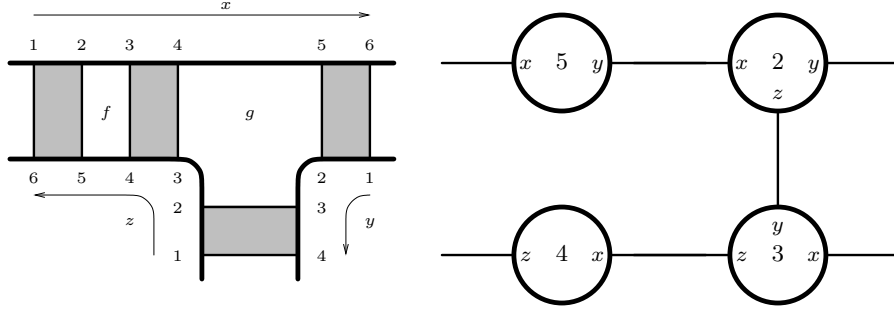

FIGURE 15.

Lemma 7.9. $t \leq 6$

Proof. By Lemma 7.7 if $t \geq 10$ then there must be at least seven labels that appear as labels of SCs in G_Q . This contradicts Lemma 7.5. Lemma 7.8 forbids $t = 8$. Hence $t \leq 6$. \square

Lemma 7.10. *If $t = 6$, then three consecutive bigons in Λ must be Black-White-Black with a Black SC. In particular, there may be at most 4 mutually parallel edges on Λ .*

Proof. In a stack of three consecutive bigons, each corner has four labels. Since $t = 6$, the two sets of four labels of the two corners either completely coincide or overlap in just two labels. The former situation implies the stack is an ESC; this violates Lemma 7.6. The latter situation implies one of the outer bigons is an SC. By Lemma 7.4, this bigon must be Black. The lemma at hand now follows. \square

Lemma 7.11. *If $t = 6$, there cannot be a forked (once) extended Scharlemann cycle (see section 4.1).*

Proof. Assume there is a forked extended Scharlemann cycle. By symmetry we may assume, without loss of generality, that it has labels and faces marked as in Figure 15(a). The edges of ∂f and ∂g form the subgraph of G_T shown in Figure 15(b).

Collapse $N(\widehat{S})$ back down to \widehat{S} expanding the two faces f and g into \overline{f} and \overline{g} as shown in Figure 16(a). Since the two $\overline{34}$ -edges of Figure 15(b) bound a single Black bigon, they are collapsed into one orientation reversing loop on G_S . Because the other edges of ∂f and ∂g belong to distinct bigons, they remain distinct edges of $\partial \overline{f}$ and $\partial \overline{g}$. In particular the two $\overline{25}$ -edges continue to form an orientation preserving loop on G_S . The corresponding subgraph of G_S is shown in Figure 16.

A small collar neighborhood of the $\overline{34}$ -edge on G_S is a Möbius band. Nearby, the faces \overline{f} and \overline{g} encounter the $3/4$ vertex as in Figure 17(a). To separate these faces we may perturb K near the vertex, introducing two new intersections with \widehat{S} as shown in Figure 17(b). The perturbation is done so that the resulting five edges of $\partial \overline{f}$ and $\partial \overline{g}$ are disjoint.

Now we surger \widehat{S} along the two arcs of K that form the corners of \overline{f} and \overline{g} . This produces a new closed non-orientable surface \widehat{R} that K intersects 2 fewer times than \widehat{S} , though $\chi(\widehat{R}) = -5$. Finally, since the boundaries of the faces \overline{f} and \overline{g} are disjoint

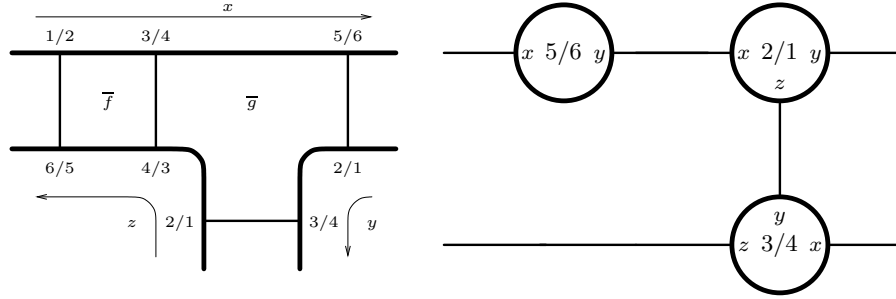

FIGURE 16.

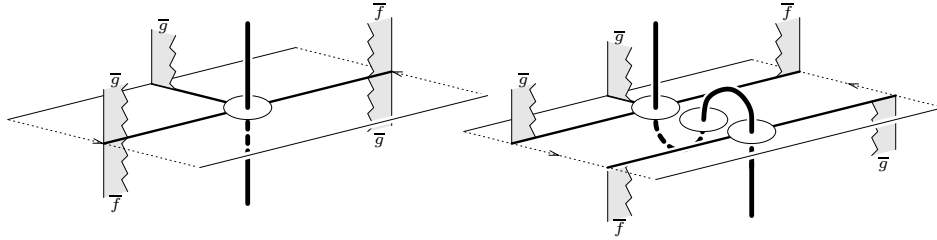

FIGURE 17.

on \widehat{R} and non-separating both individually and together, they simultaneously give compressions of \widehat{R} yielding a closed non-orientable surface \widehat{S}' with $\chi(\widehat{S}') = -1$ that K intersects transversely just once. This contradicts the minimality assumption on \widehat{S} . \square

Lemma 7.12. *If $t = 6$ and Λ contains a Black (34),(56)-bigon, then there is only one parallelism class of Black (12)-SC.*

Proof. By Lemma 7.7 there must be at least five labels that appear as labels of SCs in G_Q . Hence all 6 labels are labels of SCs. In particular, there are (12)-, (34)-, and (56)-SCs. Choose a representative SC for each Black label pair. Since these Black bigons are disjoint, after their corners are identified along K , they project to three mutually disjoint orientation reversing simple curves on \widehat{S} . Thus the complement of these three curves is a thrice-punctured sphere P . A Black (34),(56)-bigon projects to a properly embedded arc a on \widehat{S} connecting two of the punctures on P . Given a new (12)-SC, it projects to a properly embedded arc b on P disjoint from a and connects the third puncture to itself. Since $P \setminus a$ is an annulus, b must be boundary parallel. Hence the new (12)-SC must be parallel to the original representative (12)-SC. \square

Theorem 7.13. $t \leq 2$

Proof. By Lemma 7.9 we have $t \leq 6$. Since $t \neq 4$ by Lemma 7.8, we assume for a contradiction that $t = 6$. Since bigons may occur in at most runs of three according to Lemma 7.10, Lemmas 5.13 and 5.10 imply that Λ has a special vertex v of type $[6\Delta - 5, 4]$, $[6\Delta - 4, 1]$, or $[6\Delta - 3]$. Thus there are bigons at at least $6\Delta - 5$ corners of v . By Lemma 7.10 at most $\frac{3}{4}$ of the corners around a vertex may belong to bigons,

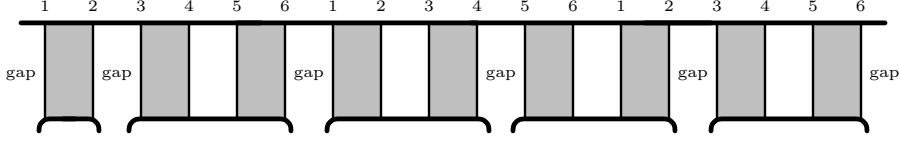

FIGURE 18.

however. Hence $6\Delta - 5 \leq \frac{3}{4}\Delta t = \frac{9}{2}\Delta$ and so $\Delta \leq \frac{10}{3}$. Thus $\Delta = 3$. Therefore v has type $[13, 4]$ or $[14]$ (which includes both types $[14, 1]$ and $[15]$).

If v is of type $[14]$ then there are at most 4 faces around v that are not bigons. Hence there must be some run of at least 4 bigons. This contradicts Lemma 7.10.

If v is of type $[13, 4]$ and not type $[14]$ then the 13 bigons must appear around v as in Figure 18 up to relabeling. In Figure 18, each “gap” marks a non-bigon (the two on the ends mark the same corner); at least 4 mark a trigon. Since each gap must correspond to a White corner at v , there are either three bigons or just one bigon between gaps. Hence around v there must be four runs of three consecutive bigons, as pictured, each containing a Black SC by Lemma 7.10.

Because at most one non-bigon around v is not a trigon, at least two of the trigons lie between two of these runs of bigons. Such a trigon is adjacent to 0, 1, or 2 SCs in the two runs of bigons. Lemma 7.4 prohibits such a trigon being adjacent to 0 SCs. If such a trigon is adjacent to 1 SC, then it must be part of a forked extended Scharlemann cycle as in Figure 15; Lemma 7.11 prohibits this configuration. Hence every such trigon must be adjacent to 2 SCs. This implies that there cannot be three consecutive runs of bigon triples at v — that the central gap in Figure 18 is the one not filled by a trigon in Λ . The labeling is now completely forced, except for that of the singleton Black bigon at the left of the figure. It must be a (12)-SC, otherwise one of the trigons on either side is a White SC, contradicting Lemma 7.4. But then there are three (12)-SCs incident to v , along with a (34),(56)-bigon. Lemma 7.12 implies that there are $\overline{12}$ edges incident to v that are parallel on G_T . The argument of Lemma 8.15 applied to G_T, G_Q shows that K is a cable knot — a contradiction. \square

The above lemma provides the conclusion of Theorem 7.2. \square

Corollary 7.14. *Let K' be a hyperbolic knot in S^3 and assume that $M = K'(\gamma)$ contains an embedded Dyck’s surface. If $\Delta = \Delta(\gamma, \mu) > 1$, where μ is a meridian of K' , then there is an embedded Dyck’s surface, \widehat{S} , in M that intersects transversely once the core, K , of the attached solid torus. Let $\widehat{N} = M - N(\widehat{S})$. Either*

- (1) $\partial\widehat{N}$ is incompressible in \widehat{N} (hence in M). Furthermore, either K can be isotoped in M onto \widehat{S} as an orientation-reversing curve, or the twice-punctured, genus 2 surface $\partial\widehat{N} - N(K)$ is incompressible in the exterior of K .
- (2) \widehat{N} is a genus 2 handlebody in which $K \cap \widehat{N}$ is a trivial arc. That is, \widehat{S} gives a 1-sided Heegaard splitting for M with respect to which K is 1-bridge. In this case, K' has tunnel number at most 2.

Proof. Theorem 7.2 provides the Dyck’s surface \widehat{S} in M that intersects K at most once. If K in M can be isotoped onto \widehat{S} , then it must be an orientation-reversing curve in that surface (as S^3 admits no embedded, closed, non-orientable surfaces)

and we are done (if \widehat{N} has incompressible boundary, it is the first conclusion, if not, it is the second as M is atoroidal and \widehat{S} is incompressible). So assume K cannot be isotoped onto \widehat{S} . Using a thin position of K' in S^3 , find surfaces $\widehat{S}, S, \widehat{T}, T$ as at the beginning of the proof of Theorem 7.2. Now we have $t = 2$. By Lemma 7.3, G_Q contains a great 2-web. This web must contain some White face, f , which must be a Scharlemann cycle (though not necessarily a bigon). We view f as giving an essential disk in $N = \widehat{N} - N(K)$.

Assume the twice-punctured, genus 2 surface $\partial\widehat{N} - N(K)$ is incompressible in the exterior of K . This is equivalent to its incompressibility in $\widehat{N} - N(K)$. As f gives a compressing disk for the boundary of N , Lemma 2.1.1 of [9] (handle addition lemma) implies that $\partial\widehat{N}$ is incompressible in \widehat{N} and hence in M . This is one of the desired conclusions.

So we assume that $\partial\widehat{N} - N(K)$ is compressible in the exterior of K , hence in N . Compress $\partial\widehat{N} - N(K)$ maximally in N . As K is hyperbolic, no component of the result can be an essential annulus in N . Thus $\partial\widehat{N} - N(K)$ must compress so that the component containing its boundary is either a twice-punctured, essential torus or a boundary parallel annulus in N . Assume first it is a twice-punctured, essential torus. That is, we may assume there is a compressing D for $\partial\widehat{N}$ that is disjoint from K , such that some component of $\partial\widehat{N} - N(K)$ surgered along D is a twice-punctured essential torus, F . Let \widehat{F} be the corresponding torus component obtained by compressing $\partial\widehat{N}$ along D . Note that \widehat{F} is incompressible on the side containing \widehat{S} as any compressing disk could be taken disjoint from both \widehat{S} and D . On the other hand, \widehat{F} is also incompressible on the side, \mathcal{O} , lying in \widehat{N} by Lemma 2.1.1 of [9]: surgering the disk f off of D , gives rise to an essential disk in $\mathcal{O} - N(K)$. Thus, \widehat{F} is an incompressible torus in M , a contradiction.

Thus $\partial\widehat{N} - N(K)$ must compress to a boundary parallel annulus in N . Thus for the arc $\kappa = K \cap \widehat{N}$, there is a disk D_κ in \widehat{N} such that $\partial D_\kappa = \kappa \cup \delta$ where $\delta \subset \partial\widehat{N}$. That is, D_κ is a ‘‘bridge disk’’ for κ in \widehat{N} .

First, assume that $\partial\widehat{N}$ does not compress in \widehat{N} .

Claim 7.15. *Let A be the annulus $N \cap N(\kappa)$, and α be the core of A . There are disjoint disks D_1, D_2 properly embedded in N such that ∂D_1 intersects α once and ∂D_2 intersects α algebraically and geometrically $n > 1$ times.*

Proof. Initially, set $D_1 = D_\kappa, D_2 = f$. Isotope D_1 so that it is disjoint from D_2 along A . Subject to this condition, isotope D_1 to intersect D_2 minimally. If D_1, D_2 are disjoint, we are done. Otherwise, there is an outermost arc of intersection, ν , on D_1 cutting off a disk d which is disjoint from D_2 except along ν and also disjoint from α . By minimality, each side of ν in D_2 contains components of $\partial D_2 \cap A$. If one side of ν contains a single component of $\partial D_2 \cap A$, then add this side of ν in D_2 to d , thereby getting a new disk D_1 disjoint from the disk D_2 as desired. Otherwise, surger D_2 along d and take either component as the new D_2 . Then D_1, D_2 still satisfy the desired intersection properties with α but have fewer components of intersection with each other. Repeating, we eventually get disjoint D_1, D_2 . \square

Note that $N - N(D_1)$ is isotopic to \widehat{N} . Under this isotopy the disk D_2 becomes a disk in \widehat{N} whose boundary is easily seen to be non-separating in $\partial\widehat{N}$. This

contradicts the incompressibility of $\partial\widehat{N}$ in \widehat{N} . Thus it must be that K could be isotoped onto \widehat{S} .

Finally, assume $\partial\widehat{N}$ compresses in \widehat{N} . Since M is atoroidal, \widehat{N} is a genus 2 handlebody. That is, \widehat{S} is a 1-sided Heegaard surface for M , and D_κ says that K is 1-bridge with respect to this splitting. Adding the cores of \widehat{N} as tunnels to K gives a genus 3 handlebody isotopic to $\widehat{N} \cup N(K)$. Since the neighborhood of a punctured non-orientable surface (in an orientable 3-manifold) is a handlebody, these two tunnels provide a tunnel system for K , hence also for K' . \square

8. SCHARLEMANN CYCLES, MÖBIUS BANDS, AND ANNULI

See section 4 for definitions regarding extended Scharlemann cycles, long Möbius bands, and almost properly embedded surfaces. Recall that $M = K'(\gamma)$ with $\Delta = \Delta(\gamma, \mu) > 2$, where μ is a meridian of K' . In particular, as K' is hyperbolic this implies that M does not contain an essential 2-sphere, 2-torus, projective plane, or Klein bottle and is not a lens space. $M = H_B \cup_{\widehat{F}} H_W$ is a strongly irreducible genus 2 Heegaard splitting of M . We assume that thin position of K , the core of the attached solid torus in M , with respect to this splitting is the minimal bridge position for K among all genus 2 Heegaard splittings of M and that we have surgered Q to get rid of any simple closed curves of $Q \cap F$ that are trivial on both.

In this and subsequent sections, we will often need to divide the argument into the two cases:

- SITUATION NO SCC: There are no closed curves of $Q \cap F$ in the interior of faces of G_Q . Thus the annuli, Möbius band constituents of a long Möbius band are each properly embedded on one side of \widehat{F} .
- SITUATION SCC: There are closed curves of $Q \cap F$ in the interior of faces of G_Q . Recall (Corollary 3.2) that any such must be non-trivial on \widehat{F} and bound a disk on one side of \widehat{F} . In this case the annuli, Möbius band constituents of a long Möbius band are each almost properly embedded on one side of \widehat{F} (section 4.2).

Lemma 8.1. *Assume A is an almost properly embedded Möbius band in one handlebody of a Heegaard splitting $H_W \cup_{\widehat{F}} H_B$ of a 3-manifold M . If a core curve of A lies in a 3-ball in M then the Heegaard splitting is weakly reducible.*

Proof. ∂A cannot be a meridian of either H_W or H_B since M contains no projective planes. But ∂A can be isotoped into a neighborhood of the core of A . Hence ∂A lies in a 3-ball in M , and Lemma 3.3 says the splitting is weakly reducible. \square

Lemma 8.2. *The exterior of K contains no properly embedded, essential, twice-punctured torus with boundary slope γ , the meridian of K in M .*

Proof. Assume T is a properly embedded, essential, twice-punctured torus in $M - N(K)$. Then T caps off to a separating torus \widehat{T} in M that is punctured twice by K , $T = \widehat{T} - N(K)$. Color the two components of $M \setminus \widehat{T}$ Black and White and denote them M_B and M_W respectively.

The thin position argument of [15] shows that we may find a thick sphere \widehat{Q} for $K' \subset S^3$ in thin position so that the fat-vertexed graph G_Q of intersection on \widehat{Q} between $Q = \widehat{Q} - N(K')$ and F in the exterior of K has no monogons. (A monogon of G_Q would give a bridge disk for an arc of $K \setminus \widehat{T}$ and hence give a compression of

T .) We may now follow Lemmas 8.2 and 8.3 of [22] to show that both $M_B - N(K)$ and $M_W - N(K)$ are genus 2 handlebodies.

Since M_B is recovered from the handlebody $M_B - N(K)$ by attaching a 2-handle along the core of the annulus $\partial(M_B - N(K)) - T$, the Handle Addition Lemma 2.1.1 of [9] implies that $\widehat{T} = \partial M_B$ is incompressible in M_B . The same argument shows $\widehat{T} = \partial M_W$ is also incompressible in M_W . Thus the torus \widehat{T} is incompressible in M , a contradiction since M is atoroidal. \square

Lemma 8.3. *Let $N \subset M$ be a small Seifert fiber space over the disk with two exceptional fibers. Assume N contains a properly embedded Möbius band A such that ∂A does not lie in a 3-ball in M (for example, ∂A lies on a genus 2 Heegaard splitting of M , Lemma 3.3). Furthermore, assume $K \cap N$ is a spanning arc of A . Then there is a genus 2 Heegaard splitting of M in which K is 0-bridge.*

Remark 8.4. Note that the proof of Lemma 8.3 actually shows that under the given hypotheses, M is a Seifert fiber space with at most three exceptional fibers, one of which has order 2. Furthermore, the new splitting constructed is a vertical splitting of the Seifert fiber space and K is a core of this vertical splitting.

Proof. Since ∂A , hence N , does not lie in a 3-ball in M , and M is atoroidal, $M - \text{Int } N$ must be a solid torus. Let $T = \partial N$. As $\partial N(A) - T$ must be an essential annulus in N , $T - N(K)$ is incompressible in $N - N(K)$. Lemma 8.2 implies $T - N(K)$ must compress in $(M - \text{Int } N) - N(K)$ to give a boundary parallel annulus. This gives an isotopy of $K \cap (M - \text{Int } N)$ onto T through $M - \text{Int } N$.

Attaching the 1-handle $N(K) \cap N$ to $M - \text{Int } N$ then forms a genus 2 handlebody where K is isotopic onto its boundary. Since $N - N(A)$ must be a solid torus, $N - N(K)$ is a genus 2 handlebody. Thus we have the desired Heegaard splitting. \square

Recall that an ESC is called *proper* if in its corner no label appears more than once. Section 4 describes how an ESC gives rise to an almost properly embedded, long Möbius band.

Lemma 8.5. *Let σ be a proper $(n - 1)$ -ESC in G_Q . Let $A = A_1 \cup \dots \cup A_n$ be the corresponding long Möbius band and let $a_i \in a(\sigma)$ be $\partial A_i - \partial A_{i-1}$ for each $i = 2 \dots n$ and $a_1 = \partial A_1$. Assume that, for some $i < j$, a_i, a_j cobound an annulus B in \widehat{F} that is otherwise disjoint from K . Then $j = i + 1$ and A_j cobounds a solid torus V with B . Furthermore, A_j is longitudinal in V , the interior of V is disjoint from K , and V guides an isotopy of A_j to B .*

Addendum: *Let D be a meridian disk of H_B or H_W disjoint from K and A , and let F^* be \widehat{F} surgered along D . If a_i, a_j cobound an annulus B of F^* (rather than \widehat{F}) that is otherwise disjoint from K , then the above conclusion is still valid (i.e. $A_j = A_{i+1}$ is isotopic to B).*

Proof. The proof of the Addendum is the same as the proof for the Lemma, replacing \widehat{F} with F^* , after noting that A can be surgered off of B . So we proceed with the proof of the Lemma.

Let B be the annulus on \widehat{F} cobounded by a_i and a_j whose interior is disjoint from K . Any simple closed curves of $A \cap B$ in the interior of B must be meridians of either H_B or H_W , and we could use such with A to create a projective plane in M . Hence we may assume A is disjoint from the interior of B . Then $T = A_{i+1} \cup \dots \cup A_j \cup B$ is an embedded 2-torus in M . M is atoroidal, so let D be a compressing disk for T .

The proof now splits into three cases depending on the relationship of A_{i+1}, A_j, D with respect to \widehat{F} .

Case I: A_{i+1} and A_j lie on opposite sides of \widehat{F} .

Compressing T along D gives a sphere which bounds a ball B^3 in M . If D is not contained in B^3 then T bounds a solid torus to the side containing D (and B^3). In this situation, the unfurling move from Section 4.3 of [1] applies to reduce the width of K . (Let V be the solid torus bounded by T . K intersects V as a single arc partitioned as a pair of spanning arcs κ and κ'' on the annulus $A_{i+1} \cup \dots \cup A_j$ union an arc κ' in $\text{Int } V$ with its boundary on a single boundary component of this annulus. With support in a small neighborhood of V , there is an isotopy of K (which may be viewed as rotations of V) that returns κ' to its original position and replaces κ, κ'' by spanning arcs of B (these may be taken to be on $B \cap \widehat{F}$ for the Addendum). A further slight isotopy in a neighborhood of the new κ, κ'' puts K in bridge position with respect to \widehat{F} again, but with smaller bridge number (width.) Since this contradicts the presumed thinnest positioning of K , D must be contained in B^3 . On the other hand, if B^3 contains D then T lies in B^3 , hence a_i does also. But this contradicts Lemma 3.3.

Case II: A_{i+1} and A_j lie on the same side of \widehat{F} , and D near B lies on the opposite side of \widehat{F} .

Let V be the closure of the component of $M \setminus T$ containing D . As a_i does not lie in a 3-ball by Lemma 3.3, V is a solid torus. Isotop K into the interior of V . Since M is irreducible and not a lens space, and since the exterior of K is irreducible and atoroidal, K must be a core of V . Now $A' = A_1 \cup \dots \cup A_i$ is a Möbius band properly embedded in V . Thus K is isotopic to the core of A' , hence of A_1 . The following contradicts either that K has bridge number greater than zero with respect to \widehat{F} or that K is hyperbolic.

Claim 8.6. *The core of A_1 is isotopic to a core curve of H_W or H_B or has exterior which is a Seifert fiber space over the disk with at most two exceptional fibers.*

Proof. In SITUATION NO SCC, A_1 is a properly embedded Möbius band in one of the Heegaard handlebodies. So the core of A_1 is a core curve of the handlebody. So assume we are in SITUATION SCC. Then there is a meridian disk E of a Heegaard handlebody H on one side of \widehat{F} that is disjoint from both K and Q . Let \mathcal{N} be the component of $H - N(E)$ containing ∂A_1 . We may isotop A_1 in M , fixing ∂A_1 , so that its interior is disjoint from $\partial \mathcal{N}$. If $A_1 \subset \mathcal{N}$ then the core of A_1 is isotopic to a core of H . Thus we assume that A_1 is properly embedded in the exterior of \mathcal{N} in M . Let n be the number of times ∂A_1 winds around the core of \mathcal{N} . As M contains no projective plane, $n > 0$. If $n > 1$ then, $U = N(\mathcal{N} \cup A_1)$ is a Seifert fiber space over the disk with two exceptional fibers. ∂U must compress in $M - U$. As ∂A_1 does not lie in a 3-ball by Lemma 3.3, $M - U$ must be a solid torus. Thus the exterior of the core of A_1 is a Seifert fiber space over the disk with at most two exceptional fibers. Finally, assume $n = 1$. Let L be a core of \mathcal{N} . Then L is a $(2, 1)$ -cable of the core of A_1 . Claim 8.7 below shows that the core of A_1 , since it is isotopic to K and therefore hyperbolic, is isotopic to a core of H_B or H_W . \square

Claim 8.7. *Let L be a cable of a hyperbolic knot K in a 3-manifold $M \not\cong S^3$. Assume that L is a core of H_B in a strongly irreducible genus 2 Heegaard splitting $H_B \cup_{\widehat{F}} H_W$ of M . Then K is isotopic to a core of either H_B or H_W .*

Proof. Let $Y = M - N(L)$. Let A be the cabling annulus for L considered as properly embedded in Y . Because K is hyperbolic, A is the unique essential annulus in Y up to isotopy. Let E be a non-separating disk in H_B disjoint from L , and let $\alpha = \partial E \subset \partial H_W$. Then A is the unique essential annulus in $H_W \cup N(E) = Y$. Now $\partial H_W - \alpha$ is incompressible in H_W by the strong irreducibility of the splitting. Apply Theorem 1 of [12] where $M = H_W$ and $M_\alpha = Y$. First assume (a) of that Theorem holds and let A' be the α -essential annulus. By Proposition C of [12] (and the uniqueness of essential annuli in Y), A' is isotopic to A in Y . Then A' is a separating essential annulus in H_W and consequently cobounds a solid torus T with an annulus A'' on ∂H_W . As A'' is disjoint from ∂E , T is isotopic to the solid torus cobounded by A and ∂Y . Thus K can be isotoped in Y to a core of T and hence to a core of H_W . So assume (b) of Theorem 1 holds and let S be the essential annulus of Y described. Then again, S is isotopic to A . Furthermore, the solid torus T there must be the cabling solid torus in Y whose core is K . As τ_1 described in Theorem 1 is also a core of T , K is isotopic to τ_1 . As τ_1 is a core of H_B , so is K . \square

Case III: A_{i+1} and A_j lie on the same side of \widehat{F} , and D near B lies on the same side of \widehat{F} .

Let V be the component of $M \setminus T$ containing D . Then K may be perturbed to miss V completely. Since K cannot lie in a 3-ball (by the irreducibility of the exterior of K), V is a solid torus. $A' = A_1 \cup \dots \cup A_i$ is a Möbius band properly embedded in $M - V$. We may assume ∂D intersects $\partial A'$ minimally on T . Let n be this intersection number. If $n = 0$, then we may use A' and D to construct a projective plane in M , a contradiction. If $n = 1$ then B is longitudinal in V . If furthermore, $j > i + 1$ then we can use V to thin K (by reducing the bridge number), a contradiction. Thus, when $n = 1$ we have the conclusion of the Lemma.

So assume $n > 1$. Let $N = N(V \cup A')$. Then N is a Seifert fiber space over the disk with two exceptional fibers of order $2, n$. Lemma 8.3 now applies to give a genus 2 Heegaard splitting of M in which K is 0-bridge. This contradicts the presumed minimal bridge position of K with respect to the original splitting $H_B \cup_{\widehat{F}} H_W$. \square

We make the following useful observation:

Lemma 8.8. *Let Γ be a bridge collection of arcs in a handlebody H . Let A be an annulus or Möbius band properly embedded in H that is disjoint from Γ . Let κ be a co-core of A . Then $\{\kappa\} \cup \Gamma$ is a bridge collection of arcs in H .*

Proof. Let \mathcal{D} be a collection of bridge disks in H for Γ . If \mathcal{D} is disjoint from A , then a ∂ -compressing disk of A (i.e. a disk intersecting A in a single arc essential in A) can be isotoped to give a bridge disk for κ . We may isotope this disk to be disjoint from \mathcal{D} , thereby showing that $\kappa \cup \Gamma$ is a bridge collection.

So we assume that \mathcal{D} can be chosen to meet A in a non-empty collection of co-cores of A . An outermost arc, κ' , of $A \cap \mathcal{D}$ in \mathcal{D} cuts out an outermost disk D . After perturbing D slightly, D becomes a bridge disk for κ' disjoint from \mathcal{D} , showing that $\kappa' \cup \Gamma$ is a bridge collection. As κ is isotopic to κ' in A , this proves the Lemma. \square

Lemma 8.9. *Let $A = A_1 \cup \dots \cup A_n$ be the long Möbius band corresponding to a proper ESC, and assume we are in SITUATION NO SCC. Assume, as in the conclusion of Lemma 8.5, some A_j cobounds a solid torus V with an annulus B in*

\widehat{F} , that A_j is longitudinal in V , and the interior of V is disjoint from K . Then $j = n$.

Proof. Assume for contradiction that $j < n$. We use V to isotop A_j to B and then into the opposite handlebody, H_W say. Then $A_{j-1} \cup A_j \cup A_{j+1}$ is a properly embedded, incompressible annulus or Möbius band in H_W . Lemma 8.8 shows that we can reduce the bridge number of K by replacing the arcs $K \cap (A_{j-1} \cup A_j \cup A_{j+1})$ with the co-cores of this properly embedded annulus or Möbius band. \square

Lemma 8.10. *Let a, a', a'' be components of $a(\sigma)$ for a proper ESC, σ . If a, a' and a', a'' each cobound annuli on \widehat{F} with interiors disjoint from K , then K can be thinned.*

Addendum: *Let D be a meridian disk of H_B or H_W disjoint from K and Q . Let F^* be \widehat{F} surgered along D . If a, a' and a', a'' each cobound annuli on F^* (rather than \widehat{F}) with interiors disjoint from K , then K can be thinned.*

Proof. The argument for the Addendum is the same as the argument below with \widehat{F} replaced by F^* .

Assume a, a' cobound an annulus B on \widehat{F} , and a', a'' cobound B' on \widehat{F} , with $\text{int}(B), \text{int}(B')$ disjoint from K . Let $A = A_1 \cup \cdots \cup A_n$ be the long Möbius band associated to σ and $a_i = \partial A_i - \partial A_{i-1}$ be the components $a(\sigma)$. Then by Lemma 8.5 (and its Addendum for the Addendum here), we can write $a = a_i, a' = a_{i+1}, a'' = a_{i+2}$ for some i . Furthermore, $A_{i+1} \cup B, A_{i+2} \cup B'$ bound solid tori V, V' whose interiors are disjoint from K and which guide isotopies of A_{i+1}, A_{i+2} to B, B' (resp.). Together these define an isotopy of the arcs $K \cap (A_{i+1} \cup A_{i+2})$ onto B, B' . We can then perturb the resulting arcs off of \widehat{F} , resulting in a thinning of K . \square

Lemma 8.11. *M contains a Dyck's surface if either*

- (1) *there are three mutually disjoint Möbius bands in M , each almost properly embedded in H_B or H_W .*
- (2) *there is a Möbius band in M almost properly embedded in either H_B or H_W whose boundary is separating on \widehat{F} .*

Proof. First assume the Möbius bands are properly embedded in the Heegaard handlebodies. Note that 3 mutually disjoint Möbius bands cannot all be properly embedded in a single genus 2 handlebody. Thus to have 3 mutually disjoint Möbius bands in M each properly embedded in either H_B or H_W , two must lie to one side of \widehat{F} and one must lie to the other. Furthermore their boundaries must be in different isotopy classes on \widehat{F} , else M contains an embedded Klein bottle.

If the boundary of a Möbius band that is properly embedded in either of these handlebodies has separating boundary on \widehat{F} , then it divides \widehat{F} into two once-punctured tori. Capping off one of these with the Möbius band produces an embedding of Dyck's surface in the handlebody, a contradiction. Thus the boundaries of these 3 Möbius bands cut \widehat{F} into two thrice-punctured spheres. Capping off one of these thrice-punctured spheres with the 3 Möbius bands produces an embedding of Dyck's surface in M .

Now assume that some Möbius band is almost properly embedded. Then there is a meridian disk disjoint from all three Möbius bands. After surgering \widehat{F} along this disk the hypotheses above guarantee that M contains an embedded Klein bottle or

projective plane (either some Möbius band boundary becomes trivial or two become isotopic), contrary to assumption. \square

Lemma 8.12. *Assume there is an annulus, A , almost properly embedded in either H_B or H_W whose boundary components are in distinct, essential isotopy classes in \widehat{F} neither of which is a meridian of either handlebody. If there is an almost properly embedded Möbius band in either handlebody that is disjoint from A and whose boundary is not isotopic on \widehat{F} to either boundary component of A , then M contains a Dyck's surface.*

Proof. Note that in fact the annulus and Möbius band are properly embedded, else the hypothesis would imply the existence of an embedded projective plane in M . Let A be the annulus and B be the Möbius band. By Lemma 8.11 we assume ∂B is not separating on \widehat{F} . Since A is non-separating and incompressible, each component of ∂A is non-separating in \widehat{F} (A is disjoint from a non-separating meridian disk). Therefore all three components of $\partial(A \cup B)$ are non-separating. The complement of these three curves on \widehat{F} is two copies of the thrice punctured sphere. Let one be P . Then $P \cup A \cup B$ is an embedding of Dyck's surface in M . \square

Lemma 8.13. *Assume M does not contain a Dyck's surface. In SITUATION NO SCC*

- (1) *If G_Q contains a proper r -ESC then $r \leq 2$.*
- (2) *The long Möbius band $A_1 \cup A_2 \cup A_3$ arising from any proper 2-ESC must have ∂A_2 non-isotopic on \widehat{F} , ∂A_3 cobounding an annulus B on \widehat{F} . $A_3 \cup B$ cobounds a solid torus V whose interior is disjoint from K and in which A_3 is longitudinal. That is, V guides an isotopy of A_3 in M to B .*

Proof. Consider an $(n - 1)$ -times extended Scharlemann cycle (an $(n - 1)$ -ESC, see section 4), σ , in G_Q for which n is largest and that is still proper. Let $A = A_1 \cup A_2 \cup \dots \cup A_n$ be its associated long Möbius band. Let $a_i = \partial A_i \cap \partial A_{i+1}$. Assume A_1 is Black so that A_i is White for i even and Black for i odd.

Assume there exists a proper 3-ESC so that $n \geq 4$ (σ is maximal). Since there are at most 3 isotopy classes of mutually disjoint simple loops on \widehat{F} , two curves of $a(\sigma)$ must be isotopic. Let B be the annulus cobounded by adjacent ones.

If the interior of B is not disjoint from K then there is a vertex x of $K \cap \text{Int } B$. Since, by Corollary 5.3, Λ_x contains a bigon, there is a proper extended Scharlemann cycle, ν , and a corresponding long Möbius band A^x whose boundary is a curve comprising two edges of Λ_x meeting at x and one other vertex. Therefore this curve cannot transversely intersect ∂B and thus must be contained in B . By Lemma 4.3, ν, σ must have the same core labels. But this contradicts the maximality of σ .

Hence $K \cap \text{Int } B = \emptyset$. Thus by Lemma 8.5 and Lemma 8.9, since K does not lie on a genus 2 splitting of M and $\text{Int } B \cap K = \emptyset$, $\partial B = a_{n-1} \cup a_n$. That is, a_{n-1}, a_n are the only components of $a(\sigma)$ parallel on \widehat{F} . Since $n \geq 4$, $n = 4$ and the components of $\partial A_4, a_3$ and a_4 , cobound an annulus on \widehat{F} . Moreover the curves a_1, a_2, a_3 are in different isotopy classes on \widehat{F} . But then A_1 and A_3 contradict Lemma 8.12 (no a_i bounds a disk else M contains a projective plane).

Now assume there exists a 2-ESC so that $n = 3$. Then by Lemma 8.12 some pair of boundary components of A_1 and A_3 must be isotopic. Lemma 8.5, Lemma 8.9, and the argument above (now a 2-ESC is maximal) shows this pair must be ∂A_3 and proves part (2). \square

Lemma 8.14. *If there are 3 SCs in G_Q with disjoint label pairs then M contains a Dyck's surface.*

Proof. Assume there are 3 SCs with disjoint label pairs. These give rise to 3 mutually disjoint Möbius bands each almost properly embedded in either H_B or H_W . By Lemma 8.11 M contains a Dyck's surface. \square

Lemma 8.15. *No two edges may be parallel in G_F that meet a vertex at the same label.*

Proof. Assume there were two such parallel edges in G_F . If the two vertices of G_F that these edges connect are parallel, then there must be a length 2 Scharlemann cycle in G_F which can be used to create an embedded projective plane in the meridional surgery on K — a contradiction. If the two vertices that the parallel edges connect are anti-parallel, then the argument of [18, §5 Case (2)], implies that K is a cable knot — contradicting that K is hyperbolic. \square

Lemma 8.16. *In SITUATION NO SCC, assume there is a White (23)-SC. Let A_{23} be its corresponding Möbius band in H_W . Then there are mutually disjoint bridge disks for all of the White arcs $K \cap H_W$ whose interiors are also disjoint from A_{23} .*

Proof. First take a bridge disk D_{23} for (23) disjoint from the from the other bridge disks $K \cap H_W$. This disk may be chosen to have interior disjoint from A_{23} since otherwise there is a compression, ∂ -compression, or a banding that will form a new bridge disk for (23) intersecting A_{23} fewer times.

Then $\partial N(D_{23} \cup A_{23}) - \partial H_W$ is a separating meridian disk in H_W . Any collection of bridge disks for the remaining arcs of $K \cap H_W$ may be pushed off this disk. \square

Lemma 8.17. *Two properly embedded, non- ∂ -parallel arcs in a Möbius band with the same boundary are isotopic rel- ∂ .*

Proof. Let a and b be two properly embedded, non- ∂ -parallel arcs in a Möbius band such that $\partial a = \partial b$. Let a' be a push-off of the arc a . Isotop b rel- ∂ to minimize both $|a' \cap b|$ and $|a \cap b|$.

If $|a' \cap b| = 0$, then a and b are isotopic rel- ∂ . If $|a' \cap b| \neq 0$ then the two arcs of $b - a'$ sharing an end point with a either lie on the same side of $a \cup a'$ or on different sides. If they lie on the same side, then there must be a bigon with boundary composed of an arc in a' and an arc in b with interior disjoint from $a' \cup b$. Thus there is an isotopy rel- ∂ of b to reduce $|a' \cap b|$ contrary to assumption. If they lie on different sides, then their union must be b with b parallel into the boundary of the Möbius band. This too is contrary to assumption. \square

9. $t < 10$.

In this section we prove

Theorem 9.1. *Either M contains a Dyck's surface or $t < 10$.*

Proof. This is Proposition 9.2 of section 9.1 when we are in SITUATION NO SCC, and Proposition 9.8 of section 9.2 in SITUATION SCC. \square

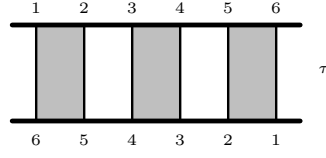

FIGURE 19.

9.1. $t \geq 10$ and SITUATION NO SCC.

Proposition 9.2. *In SITUATION NO SCC, either M contains a Dyck's surface or $t < 10$.*

Proof. Assume we are in SITUATION NO SCC, M does not contain a Dyck's surface, and $t \geq 10$. By Lemma 8.13, there are three cases to consider:

- A. There is a 2-ESC in Λ .
- B. There is an ESC in Λ but no 2-ESC.
- C. There is no ESC in Λ .

Case A. *There is a 2-ESC in Λ .*

Assume G_Q contains τ , the 2-ESC depicted in Figure 19 (WLOG as labelled there and with Black and White as pictured). It gives rise to a long Möbius band $A_1 \cup A_2 \cup A_3$ in which A_1 is a Black Möbius band, A_2 is a White annulus, and A_3 is a Black annulus. By Lemma 8.13 the components of ∂A_2 lie in two distinct isotopy classes on \widehat{F} whereas the components of ∂A_3 are isotopic to each other.

Lemma 9.3. *There is no SC whose label set is disjoint from the labels $\{2, 3, 4, 5\}$.*

Proof. Assume there is a SC disjoint from the labels $\{2, 3, 4, 5\}$. This gives rise to a Möbius band properly embedded in H_B or H_W which must be disjoint from the annulus A_2 . Since M contains no Klein bottles, the boundary of this Möbius band cannot be isotopic to either component of ∂A_2 . By Lemma 8.12, however, this cannot occur. \square

Recall Corollary 5.3, that for each label x the subgraph $\Lambda_x \subset \Lambda$ must contain a bigon and hence an ESC or SC. By Lemma 9.3, the SC in a bigon of Λ_x must have label pair intersecting $\{2, 3, 4, 5\}$, and by Lemma 8.13(1) an ESC may be at most twice extended. Thus x can be no more than 3 away from the label 2 or 5; at its furthest, $x = t - 1$ or $x = 8$. Therefore $t = 10$.

For Λ_9 the only possibility is a 2-ESC with labels $\{9, 10, 1, 2, 3, 4\}$; it contains an SC with label pair $\{1, 2\}$. Similarly, for Λ_8 the only possibility is a 2-ESC with labels $\{3, 4, 5, 6, 7, 8\}$; it contains an SC with label pair $\{5, 6\}$. The SC in τ has label pair $\{3, 4\}$. But now the existence of these three SCs with disjoint label pairs contradicts Lemma 8.14. (Really this contradicts that there cannot be 3 disjoint, properly embedded Möbius bands in a genus 2 handlebody.) This completes the proof in Case A.

Case B. *There is an ESC in Λ but no 2-ESC.*

Assume G_Q contains τ , the ESC depicted in Figure 20.

Lemma 9.4. *There cannot be two ESCs whose SCs have opposite colors and for which the corresponding long Möbius bands are disjoint.*

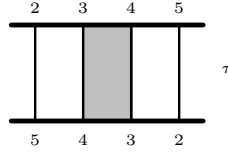

FIGURE 20.

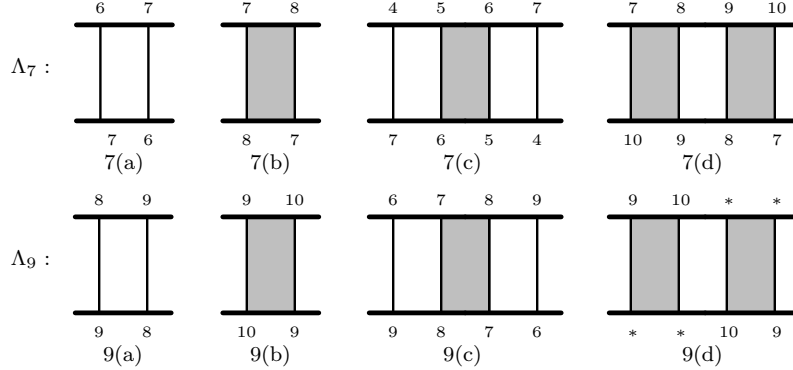

FIGURE 21.

Proof. Assume otherwise. Let A_1 and A_2 be the Möbius band and annulus respectively arising from one ESC and B_1 and B_2 be the Möbius band and annulus respectively arising from the other. We may assume A_1 and B_2 are Black while A_2 and B_1 are White. No component of ∂A_2 is isotopic on \widehat{F} to a component of ∂B_2 since otherwise the two long Möbius bands will form an embedded Klein bottle. Then by Lemma 8.12 the components of ∂A_2 must be isotopic as must the components of ∂B_2 . By Lemma 8.5, A_2 and B_2 are parallel into \widehat{F} (note that since these ESCs are of maximal length, we may apply the argument of Lemma 8.13 to show that the annuli on \widehat{F} between the components of ∂A_2 and ∂B_2 respectively must be disjoint from K). These two parallelisms however give a thinning of K . This is a contradiction. \square

We now consider the possible bigons of Λ_7 and Λ_9 . The possibilities are shown in Figure 21. Lemma 9.4 immediately rules out 7(d).

Claim 9.5. *9(c) is impossible.*

Proof. Consider the bigons of Λ_1 . The four possibilities are listed in Figure 22. With τ and 9(c), each of 1(a), 1(b), and 1(c) contradict Lemma 8.14. Together 9(c) and 1(d) contradict Lemma 9.4. \square

Claim 9.6. *7(a) and 7(c) are impossible.*

Proof. With τ and 7(a), each of 9(a), 9(b), and 9(d) (the remaining possible bigons of Λ_9) contradict Lemma 8.14. Similarly with τ and 7(c), each of 9(a), 9(b), and 9(d) contradict Lemma 8.14. \square

Claim 9.7. *7(b) is impossible.*

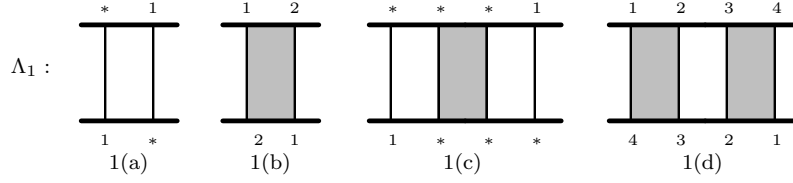

FIGURE 22.

Proof. With τ and 7(b), each of 9(b) and 9(d) contradict Lemma 8.14. Therefore we must have 9(a). Hence we have SCs with label pairs $\{3, 4\}$, $\{7, 8\}$, and $\{8, 9\}$. Again, Λ_1 must have one of the bigons listed in Figure 22. Each of the SCs contained within 1(a), 1(b), and 1(c) form, along with two of those with labels pairs $\{3, 4\}$, $\{7, 8\}$, and $\{8, 9\}$, a triple of mutually disjoint SCs. This contradicts Lemma 8.14.

So we assume we have 1(d) along with τ , 7(b), and 9(a). The possible bigons of Λ_6 are 7(a), 9(c), an SC on labels $\{5, 6\}$, and a 1-ESC on labels $\{3, 4, 5, 6\}$. The first two have already been ruled out. Each of the two remaining gives rise to an SC that joins with those above to contradict Lemma 8.14. \square

This completes the proof in Case B.

Case C. *There is no ESC in Λ .*

In this case every label belongs to an SC. Lemma 8.14 then forces $t \leq 6$ contrary to the assumed $t \geq 10$. This completes the proof in Case C and thus the proof of Proposition 9.2. \square

9.2. $t \geq 10$ and SITUATION SCC.

Proposition 9.8. *In SITUATION SCC, either M contains a Dyck's surface or $t < 10$.*

Proof. Assume we are in SITUATION SCC. Then there is a meridian disk D of H_W or H_B disjoint from K and Q . Let F^* be \widehat{F} surgered along D . Then F^* is one or two tori. For contradiction, assume M does not contain a Dyck's surface, and $t \geq 10$.

Lemma 9.9. *If G_Q contains an r -ESC then $r \leq 3$.*

Proof. Let r be the largest value such G_Q contains a proper r -ESC, σ . Assume for contradiction, $r \geq 4$. Then $|a(\sigma)| \geq 5$ and there must be at least three components of $a(\sigma)$ that are isotopic on F^* . Let B be an annulus between two components of $a(\sigma)$ on F^* whose interior is disjoint from $a(\sigma)$. Any vertex of G_F in $\text{Int } B$ must belong to a component, a , of $a(\tau)$ for some r' -ESC, τ , of Λ . Since a intersects $a(\sigma)$ at most once, it must lie in B and (Lemma 4.2) be isotopic to the components ∂B of $a(\sigma)$. But this would contradict the Addendum to Lemma 4.3 and the maximality of r . Thus $\text{Int } B$ must be disjoint from K . That is, there are components a_1, a_2, a_3 of $a(\sigma)$ such that a_1, a_2 and a_2, a_3 cobound annuli in F^* whose interiors are disjoint from K . This contradicts the Addendum to Lemma 8.10. \square

Lemma 9.10. *G_Q contains no 3-ESC.*

Proof. Suppose σ is a 3-ESC. As argued in the preceding lemma, the Addendum to Lemma 4.3 and the maximality of σ show that if B is an annulus of F^* cobounded

by components of $a(\sigma)$ such that $\text{Int } B$ is disjoint from $a(\sigma)$, then $\text{Int } B$ must be disjoint from K . Then the Addendum to Lemma 8.10 shows that at most two components of $a(\sigma)$ are isotopic on F^* . Since $|a(\sigma)| = 4$, F^* must be two tori with exactly two components of $a(\sigma)$ on each. But the argument above then says that every vertex of G_F must lie on $a(\sigma)$ — contradicting that $t \geq 10$. \square

Lemma 9.11. *There is no 2-ESC.*

Proof. Let σ be a 2-ESC. The argument of Lemma 9.10 coupled with its conclusion that there is no 3-ESC, implies that F^* must consist of two tori: T_1 containing two components of $a(\sigma)$ and T_2 containing one. Again, the argument of Lemma 9.10, shows that the only vertices of G_F on T_1 are those lying on the two components of $a(\sigma)$.

Assume σ is given by Figure 19. By Corollary 5.3 there is a bigon of Λ_8 . This can be taken to be a proper r -ESC, τ (where $r = 0$ means an SC). Then $r \leq 2$. By the Addendum to Lemma 4.3, each component of $a(\tau)$ must intersect a component of $a(\sigma)$. Enumerating the possibilities for the labels of τ consistent with these conditions we have

- a. $\{5, 6, 7, 8\}$
- b. $\{8, 9, 10, 1, 2, 3\}$
- c. $\{3, 4, 5, 6, 7, 8\}$

But (a) is not possible as vertices 7, 8 of G_F must lie on T_2 , but the corresponding components of $a(\tau)$ intersect two different components of $a(\sigma)$. The same argument with vertices 8, 9 rules out (b). So we assume the labels of τ are given by (c). Since vertices 7, 8 of G_F lie in T_2 , then vertices 3, 4 must also lie in T_2 while vertices 1, 2, 5, 6 must be those in T_1 .

Now take a bigon of Λ_{10} giving a proper n -ESC, ν . By the Addendum to Lemma 4.3, as argued above, each component of $a(\nu)$ must intersect both $a(\sigma)$ and $a(\tau)$. Furthermore, $n \leq 2$. These conditions guarantee that the label set for ν is $\{10, 1, 2, 3, 4, 5\}$. But this contradicts that vertex 2 lies on T_1 and vertex 3 on T_2 . \square

Lemma 9.12. *There is no 1-ESC.*

Proof. Assume there is an ESC, σ , on the labels $\{1, 2, 3, 4\}$. By Corollary 5.3, there is a proper r -ESC, τ , coming from a bigon of Λ_5 , and a proper n -ESC, ν , coming from a bigon of Λ_9 . Furthermore, $0 \leq r, n \leq 1$. A simple enumeration shows the possible label pairs of the core SC for τ are: $\{34, 45, 56, 67\}$. The possible labels for the core SC of ν are: $\{78, 89, 910, 10*\}$ (where the label $*$ means either 1 or 11). Three SCs on disjoint label pairs would allow us to use F^* to form a Klein bottle in M . Thus the label pairs of the core SCs of two of $\{\sigma, \tau, \nu\}$ must intersect. The possibilities are

- a. σ, τ where τ has label set $\{2, 3, 4, 5\}$
- b. τ, ν where τ has label set $\{5, 6, 7, 8\}$ and ν has label set $\{6, 7, 8, 9\}$.

Both lead to the same contradiction. We consider (b). The edges of τ, ν force the vertices 5, 6, 7, 8, 9 to lie on the same torus component of F^* . There is a component of $a(\tau)$ disjoint from a component of $a(\nu)$. Hence these components are isotopic on F^* . But this contradicts the Addendum to Lemma 4.3. \square

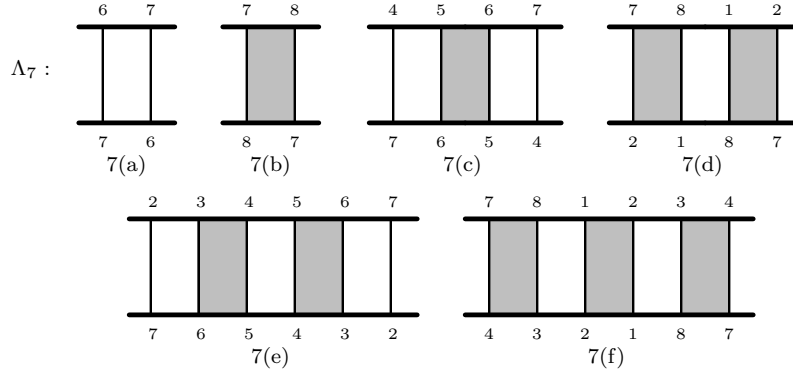

FIGURE 23.

The preceding lemmas along with Corollary 5.3, implies that every label of Λ belongs to an SC. But then Lemma 8.14 along with the assumption that $t \geq 10$ implies that M contains a Dyck's surface. This contradiction concludes the proof of Proposition 9.8. \square

10. $t < 8$

By Theorem 9.1, $t \leq 8$. In this section we prove

Theorem 10.1. *Either M contains a Dyck's surface or $t < 8$.*

Proof. This is Proposition 10.2 of section 10.1 when we are in SITUATION NO SCC, and Proposition 10.17 of section 10.3 in SITUATION SCC. \square

10.1. $t = 8$ and SITUATION NO SCC.

Proposition 10.2. *In SITUATION NO SCC, either M contains a Dyck's surface or $t < 8$.*

Proof. Assume M does not contain a Dyck's surface and $t = 8$. By Lemma 8.13, there are three cases to consider:

- A. There is a 2-ESC in Λ .
- B. There is a 1-ESC in Λ but no 2-ESC.
- C. There is no ESC in Λ .

The proof in Case B relies upon Corollary 10.16 and Proposition 10.27 which are proven in subsections following the present proof.

Case A. *There is a 2-ESC in Λ .*

As in Case A of Theorem 9.1, assume G_Q contains τ , the 2-ESC depicted in Figure 19. It gives rise to a long Möbius band $A_\tau = A_1 \cup A_2 \cup A_3$ in which A_1 is a Black Möbius band, A_2 is a White annulus, and A_3 is a Black annulus. By Lemma 8.13 the components of ∂A_2 are not isotopic on \widehat{F} whereas the components of ∂A_3 are.

Figure 23 lists all possible bigons of Λ_7 that are at most 2-ESCs (i.e. containing at most 6 edges). We proceed to rule out all of these bigons, thereby contradicting Corollary 5.3.

Claim 10.3. *$7(a)$, $7(b)$, and $7(d)$ are impossible.*

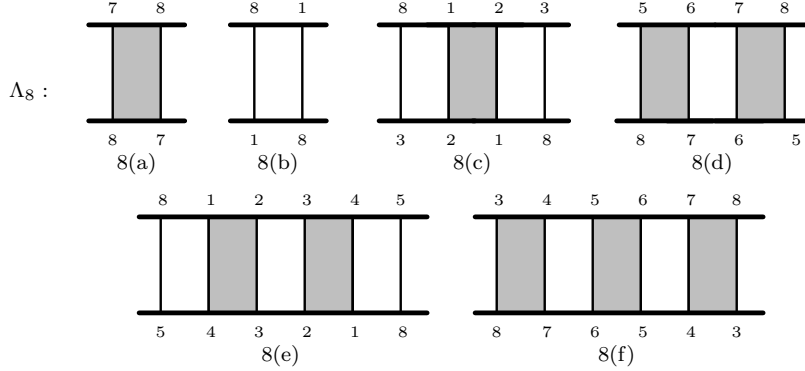

FIGURE 24.

Proof. Each of these bigons contain an SC whose associated Möbius band is disjoint from A_2 . The boundary of such a Möbius band must not be isotopic to a component of ∂A_2 , else there would be an embedded Klein bottle in M . This contradicts Lemma 8.12. \square

Claim 10.4. *7(c) and 7(f) are impossible.*

Proof. Each 7(c) and 7(f) contain an SC whose associated Möbius band B intersects A_3 along a component of $A_3 \cap K$. Because A_3 is separating in the Black side of \widehat{F} , the intersection of B with A_3 is not transverse. Therefore the Möbius band B may be isotoped in H_B to be disjoint from A_3 and hence A_2 . Since ∂B cannot be isotopic on \widehat{F} to either component of ∂A_2 , together B and A_2 form a contradiction to Lemma 8.12. \square

Claim 10.5. *7(e) is impossible.*

Proof. Figure 24 lists all possible bigons of Λ_8 that are at most 2-ESCs. Analogously to Claims 10.3 and 10.4, we may rule out all but 8(e). Yet now 7(e) and 8(e) cannot coexist as the proof of Claim 10.4 applies analogously with 7(e) and 8(e) in lieu of 7(c) and τ respectively. \square

This completes the proof in Case A.

Case B. *There is a 1-ESC in Λ but no 2-ESC.*

Assume G_Q contains τ , the ESC depicted in Figure 20.

Lemma 10.6. *There cannot be two 1-ESCs whose label sets intersect in one label.*

Proof. Assume otherwise. Then their SCs have opposite colors. Let A_1 and A_2 be the Möbius band and annulus arising from one ESC; let B_1 and B_2 be the Möbius band and annulus arising from the other. Since A_1 and B_1 are on opposite sides, so are A_2 and B_2 .

By Lemma 8.12 some pair of curves of $\partial A_1 \cup \partial B_2$ must be isotopic as must some pair of curves of $\partial B_1 \cup \partial A_2$. Since we may not form any embedded Klein bottles, the two components of ∂B_2 must be isotopic as must the two components of ∂A_2 . Then by Lemma 8.5 it follows that A_2 and B_2 are each parallel into \widehat{F} . (The ESCs are of maximum length, so the argument of Lemma 8.13 shows that the parallelism between, say, ∂A_2 is disjoint from K .)

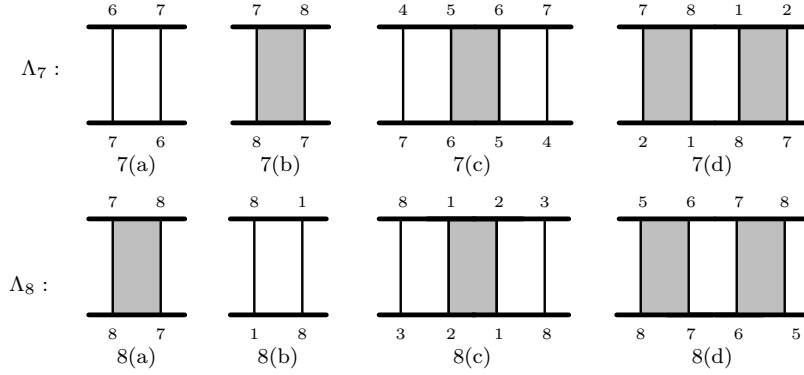

FIGURE 25.

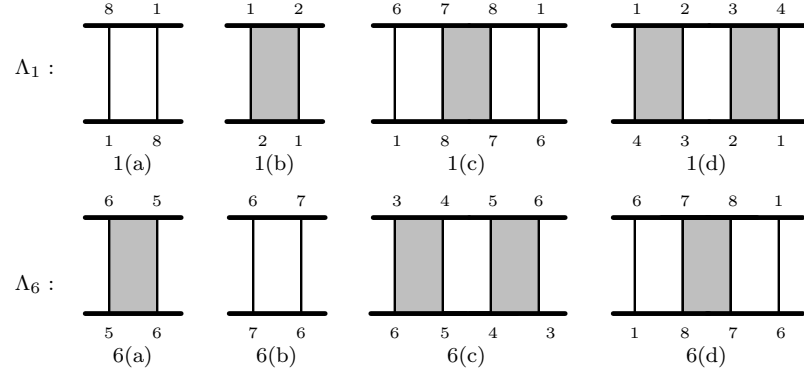

FIGURE 26.

By assumption, ∂A_2 and ∂B_2 intersect in one point, and thus this intersection is not transverse. Hence, as with Lemma 9.4, the parallelisms of A_2 and B_2 into \widehat{F} give a thinning of K . This is a contradiction. \square

Let us now consider the possible ESCs, SCs coming from bigons of Λ_8 and Λ_7 . These possibilities are shown in Figure 25.

Claim 10.7. *Neither 7(d) nor 8(d) may occur.*

Proof. Since each of these shares one label with τ , Lemma 10.6 rules them out. \square

Claim 10.8. *Neither 7(c) nor 8(c) may occur.*

Proof. Since 7(c) and 8(c) have disjoint labels, at most one may occur by Proposition 10.27. Assume 7(c) does occur. Then either 8(a) or 8(b) must also occur (because 8(d) cannot by the preceding Claim). But then there will be three disjoint SCs contradicting Lemma 8.14. A similar argument shows 8(c) cannot occur. \square

Figure 26 shows the possible ESCs, SCs coming from bigons of Λ_1 and Λ_6 . These will be of use in the next two claims.

Claim 10.9. *Neither 7(a) nor 8(b) may occur.*

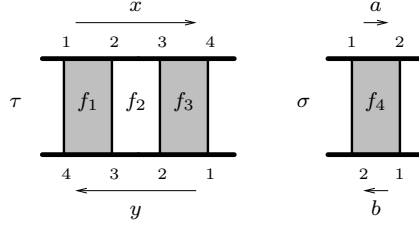

FIGURE 27.

Proof. Assume 7(a) occurs. With 7(a) and the SC in τ , each of 1(a) and 1(b) form a triple of disjoint SCs contradicting Lemma 8.14. 1(c) violates Proposition 10.27. Therefore 1(d) must occur.

With relabeling (subtracting 1 from each label), we may now apply Corollary 10.16 to show that there is another genus 2 Heegaard splitting of M with respect to which K is 3-bridge. (The SC in 1(d) plays the role of σ , τ is again τ , and 7(a) is the SC disjoint from the labels $\{2, 3, 4\}$.) This contradicts our minimality assumptions (3-bridge means $t = 6$).

A similar argument rules out 8(b), using Λ_6 in place of Λ_1 . \square

Claim 10.10. Λ does not contain a (78)-SC.

Proof. Assume there is a (78)-SC i.e. 7(b) and 8(a) occur. By Proposition 10.27, this SC cannot be contained within an ESC. We must consider the bigons of Λ_1 and Λ_6 shown in Figure 26.

Proposition 10.27 rules out 1(c) and 6(d). Corollary 10.16 rules out 1(d) and 6(c) as in the proof of Claim 10.9. Lemma 8.14 forbids each of 1(b) and 6(a) as they are SCs each disjoint from the SC in τ and the (78)-SC.

Thus 1(a) and 6(b) must occur. But then 1(a), 6(b), and the SC in τ form 3 mutually disjoint SCs in violation of Lemma 8.14. \square

The above claims imply that all bigons of Λ_8 are forbidden, contradicting Corollary 5.3. This completes the proof of Theorem 10.1 in Case B.

Case C. *There is no 1-ESC in Λ .*

By Corollary 5.3, every label belongs to an SC. Lemma 8.14 then forces $t \leq 6$ contrary to the assumption that $t = 8$. This completes the proof in Case C.

Given the the proofs of Corollary 10.16 and Proposition 10.27 in subsequent subsections, the proof of Theorem 10.1 is now complete. \square

10.2. A proposition and a corollary for Claim 10.9. For Claim 10.9 and Claim 10.10 above we use Corollary 10.16 which is a consequence of Proposition 10.11. In this subsection we prove the proposition and its corollary.

Proposition 10.11. *Assume we are in SITUATION NO SCC and there exists an ESC τ and SC σ as in Figure 27. Let A_{23} be the White Möbius band arising from the SC in τ , and let A_{12} be the Black Möbius band arising from σ . If ∂A_{23} intersects ∂A_{12} transversely on \widehat{F} then there is a new Heegaard splitting of M in which K is 3-bridge.*

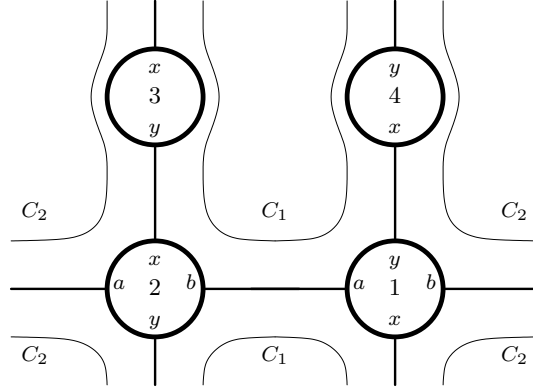

FIGURE 28.

Proof. Let $A_{12,34}$ be the Black annulus arising from τ that extends A_{23} . We assume ∂A_{23} intersects ∂A_{12} transversely. Let E be a neighborhood in \widehat{F} of the union of the vertices $\{1, 2, 3, 4\}$ and the edges of σ, τ . The labeling of these edges on \widehat{F} must be as in Figure 28. Let A be $\widehat{F} - E$.

Claim 10.12. A is an annulus in \widehat{F} .

Proof. Let C_1 and C_2 be the two curves on \widehat{F} as shown that form $\partial E = \partial A$. Since $\chi(E) = -2 = \chi(\widehat{F})$, we have $\chi(A) = 0$. If either C_1 or C_2 were to bound a disk in the complement of E , then such a disk could be joined to itself across an edge of f_4 to form an annulus in \widehat{F} . Then this resulting annulus together with the annulus $A_{12,34}$ would form an embedded Klein bottle. This cannot occur. Hence A is an annulus. \square

Let $\mathcal{N} = N(A_{12} \cup A_{12,34}) \subset H_B$. Then $\partial H_B - \mathcal{N} = A$ and set $H_B - \mathcal{N} = \mathcal{T}$.

Claim 10.13. \mathcal{T} is a solid torus and the annulus A is longitudinal on $\partial \mathcal{T}$.

Proof. Consider \mathcal{D} , a disjoint collection of bridge disks for $K \cap H_B$. By considering the intersections of these disks with the faces f_1, f_3, f_4 , surgering along outermost arcs of intersection in \mathcal{D} , and banding along f_1, f_3, f_4 , we can take the bridge disks D_{12}, D_{34} for (12), (34) to have interiors disjoint from $A_{12} \cup A_{12,34}$. Hence $H_B - \mathcal{N} = \mathcal{T}$ is a solid torus in which A is longitudinal. \square

By Claim 10.13, \mathcal{N} is isotopic to H_B through \mathcal{T} .

Claim 10.14. The arcs (12), (34), (56), and (78) in H_B have mutually disjoint bridge disks that lie in \mathcal{T} and provide an isotopy of these arcs onto A .

Proof. The above proof of Claim 10.13 shows that there are bridge disks D_{12} and D_{34} for (12) and (34) respectively, disjoint from the other arcs of $K \cap H_B$, which lie in \mathcal{T} and provide an isotopy of these arcs onto A . Indeed these are meridional disks of \mathcal{T} . Since bridge disks D_{56} and D_{78} for the other two arcs (56) and (78) are disjoint from D_{12} and D_{34} , the arcs of $(D_{56} \cup D_{78}) \cap (\partial \mathcal{T} - \text{Int } A)$ may be either isotoped along $\partial \mathcal{T} - \text{Int } A - (D_{12} \cup D_{34})$ onto A or banded to D_{12} or D_{34} to form bridge disks for (56) and (78) as desired. \square

Attach a neighborhood of the White Möbius band A_{23} in H_W to $H_B = \mathcal{N} \cup \mathcal{T}$. Write $\mathcal{N}' = H_B \cup N(A_{23}) = N(A_{12} \cup A_{12,34} \cup A_{23}) \cup \mathcal{T}$ and $\widehat{F}' = \partial\mathcal{N}'$.

Claim 10.15. $M = \mathcal{N}' \cup_{\widehat{F}'} (M \setminus \mathcal{N}')$ is a genus 2 Heegaard splitting.

Proof. We must show that \mathcal{N}' and $M \setminus \mathcal{N}'$ are each genus 2 handlebodies.

To see that \mathcal{N}' is a genus 2 handlebody, we show that the curve ∂A_{23} on \widehat{F} is primitive in H_B . It suffices to show that ∂A_{23} is primitive in \mathcal{N} since A_{23} is disjoint from \mathcal{T} and \mathcal{T} provides an isotopy of \mathcal{N} to all of H_B .

In \mathcal{N} a cocore of the annulus $A_{12,34}$ (such as the arc (34)) thickens to a meridian disk of \mathcal{N} and thus extends through \mathcal{T} to a meridian disk D of H_B . Since ∂A_{23} is a component of $\partial A_{12,34}$, it intersects D once. Hence ∂A_{23} is primitive in H_B and \mathcal{N}' is a genus 2 handlebody.

To see that $M \setminus \mathcal{N}'$ is a genus 2 handlebody, observe that it is the complement of a neighborhood of a Möbius band in H_W . \square

To complete the proof of Proposition 10.11 we must show that K is 3-bridge with respect to the Heegaard splitting $M = \mathcal{N}' \cup_{\widehat{F}'} (M \setminus \mathcal{N}')$.

Claim 10.14 shows that the arcs (56) and (78) are bridge in \mathcal{N}' . As $(1234) = (12) \cup (23) \cup (34)$ is a cocore of the properly embedded Möbius band $A_{12,34} \cup A_{23}$ in the handlebody \mathcal{N}' , it is bridge as well.

By Lemma 8.16, the arcs (45), (67), and (81) have mutually disjoint bridge disks in H_W that are also disjoint from A_{23} . Therefore they remain bridge in $H_W - N(A_{23})$ which is isotopic to $M \setminus \mathcal{N}'$.

Hence K is 3-bridge with respect to this new Heegaard splitting. \square

Corollary 10.16. *Assume we are in SITUATION NO SCC. If there is an ESC τ and an SC σ as in Figure 27 as well as an SC disjoint from the labels $\{1, 2, 3\}$ then K is 3-bridge with respect to some genus 2 Heegaard splitting of M .*

Proof. Given such a set-up, the boundaries of the Möbius bands arising from the SCs in τ and σ cannot be isotoped to be disjoint. Otherwise there would be three disjoint Möbius bands contrary to Lemma 8.14. Proposition 10.11 now applies. \square

10.3. $t = 8$ and SITUATION SCC.

Proposition 10.17. *In SITUATION SCC, either M contains a Dyck's surface or $t < 8$.*

Proof. Assume we are in SITUATION SCC. Then there is a meridian disk D of H_W or H_B disjoint from K and Q . Let F^* be \widehat{F} surgered along D . Then F^* is one or two tori. For contradiction, assume M does not contain a Dyck's surface, and $t = 8$.

Lemma 10.18. G_Q contains no 3-ESC.

Proof. Otherwise, there is a 3-ESC, σ . Note that this is a maximal proper ESC when $t = 8$. Thus the argument of Lemma 9.10 shows that F^* must be two tori, T_1, T_2 , with exactly two components of $a(\sigma)$ on each. WLOG assume the core SC of σ is a (45)-SC. Let $A = A_1 \cup \dots \cup A_4$ be the long Möbius band associated to σ and $a_i \in a(\sigma)$ be $\partial A_i - \partial A_{i-1}$. By the Addendum to Lemma 8.5 isotopic components of $a(\sigma)$ on F^* must be consecutive in A . Thus we may take a_1, a_2 in T_1 and a_3, a_4 in T_2 . That is, vertices $\{3, 4, 5, 6\}$ of G_Q lie on T_1 and vertices $\{1, 2, 7, 8\}$ on T_2 . Recall

that D is the meridian disk along which \widehat{F} is surgered to get $T_1 \cup T_2$. Because D is disjoint from K , vertex 3 lies on T_1 , and vertex 2 lies on T_2 , D must lie on the opposite side of \widehat{F} to the (23)-arc of K . Taking (23) to lie in H_W , D must lie in H_B . Let $\mathcal{N} = H_B - N(D) = \mathcal{N}_1 \cup \mathcal{N}_2$ where $\mathcal{N}_1, \mathcal{N}_2$ are solid tori with $\partial\mathcal{N}_j = T_j$. Since the components of $a(\sigma)$ cannot bound disks in either handlebody, the A_i of the long Möbius band meet F^* in their interiors in simple closed curves which are trivial on F^* . We surger along these curves to make the A_i properly embedded in either \mathcal{N} or $M - \text{Int}\mathcal{N}$. By the separation of $a(\sigma)$ in T_1, T_2 , A_1, A_3 lie in the exterior of \mathcal{N} , A_2 lies in \mathcal{N}_1 , and A_4 in \mathcal{N}_2 .

Claim 10.19. A_{2i} is a longitudinal annulus in \mathcal{N}_i for $i = 1, 2$.

Proof. Assume not. Then $U = N(\mathcal{N} \cup A_1 \cup A_3)$ is a Seifert fiber space over the disk with two or three exceptional fibers (the core of A_1 being one). Furthermore $K \cap U$ lies as a cocore in the Möbius band $A' = A_1 \cup A_2 \cup A_3 \cup A_4$ properly embedded in U , where $\partial A'$ is a Seifert fiber of U .

In fact U must be Seifert fibered with exactly two exceptional fibers. Otherwise, $V = U - N(A')$ would be a Seifert fiber space over the disk with two exceptional fibers that is disjoint from K . As V does not lie in a 3-ball by Lemma 3.3 and the exterior of K is irreducible and atoroidal, then V would be isotopic to the exterior of K — contradicting that K is hyperbolic.

Now Lemma 8.3 applies to give a genus 2 Heegaard splitting of M in which K is 0-bridge, a contradiction. \square

Let $U = N(\mathcal{N} \cup A_1 \cup A_3)$. Then $K \cap U$ lies as a cocore in the Möbius band $A' = A_1 \cup A_2 \cup A_3 \cup A_4$ properly embedded in U . The preceding Lemma means that U is a solid torus, and hence that $K \cap U$ is isotopic onto ∂U fixing its endpoints. Let W be the genus 2 handlebody $U \cup N(K)$. Then K is isotopic onto ∂W .

Claim 10.20. An edge of a Black bigon of Λ is parallel in T_1 or T_2 to an edge of σ .

Proof. Let τ be a black bigon with a (12)-corner. The argument for the other black corners is similar.

Assume τ is a SC . Let A' be the almost properly embedded Möbius band corresponding to τ . After surgery along trivial disks in T_2 , we may take A' to be properly embedded in \mathcal{N}_2 . Consider the annulus A_4 in \mathcal{N}_2 and the edges of σ in T_2 lying in ∂A_4 . Using the fact that \mathcal{N}_2 contains no Klein bottle, a close look at the labeling of the edges of σ and τ on T_2 shows that $\partial A'$ can be perturbed to be disjoint from ∂A_4 . But this contradicts that ∂A_4 is longitudinal in \mathcal{N}_2 .

So τ is not a SC . As the edges of G_F lie in either T_1 or T_2 , the edges of τ must be a $\overline{27}$ -edge and an $\overline{81}$ -edge. Looking at the edges of σ in T_2 , we see the edges of τ must be parallel to these. \square

Claim 10.21. There is no bigon in Λ with an (81)-corner.

Proof. Let τ be such a bigon. An edge of τ must lie in T_2 , implying that τ is an (81) — SC . But then the corresponding almost properly embedded Möbius band could be surgered to produce a properly embedded Möbius band in the complement of \mathcal{N} whose boundary was parallel to ∂A_4 on T_2 . Along with A we would see a Klein bottle in M . \square

By Lemmas 5.9 and 5.12, there is a special vertex v in Λ of type $[8\Delta - 5]$ (Claim 10.21 implies there can be no more than eight consecutive bigons in Λ .) This means that all but five corners at v belong to bigons of Λ . By Claim 10.21, no (81)-corner belongs to a bigon of Λ . So there must be a black corner, say (12), such that every (12)-corner at v belongs to a bigon of Λ . By Claim 10.20, the edges of these bigons incident to v at label 2 must be $\overline{27}$ -edges parallel in T_2 to the edges of σ . In particular, there are two parallel edges in T_2 both incident to vertex 2 in T_2 with label v . This contradicts Lemma 12.15. \square

To finish the proof of Proposition 10.17, we now follow the outline of the proof of Proposition 10.2, indicating the necessary modifications.

By Lemma 10.18, there are three cases to consider:

- A. There is a 2-ESC in Λ .
- B. There is a 1-ESC in Λ but no 2-ESC.
- C. There is no ESC in Λ .

Case A. *There is a 2-ESC in Λ .*

Assume G_Q contains τ , the 2-ESC depicted in Figure 19. It gives rise to a long Möbius band $A_\tau = A_1 \cup A_2 \cup A_3$ in which A_1 is, say, a Black Möbius band, A_2 is a White annulus, and A_3 is a Black annulus (each almost properly embedded in H_W or H_B). As argued in Lemma 9.11, F^* consists of two tori T_1 containing two components of $a(\tau)$ and T_2 containing one. Furthermore, the only vertices of G_F on T_1 must be those lying on the two components of $a(\tau)$ — the other four are on T_2 . Finally, by the Addendum of Lemma 8.5, components of $a(\tau)$ that are isotopic on F^* must cobound some A_i . Thus the vertices of G_F on T_1 are either

- (i) $\{1,2,5,6\}$
- (ii) $\{2,3,4,5\}$

Figure 23 lists all possible bigons of Λ_7 that are at most 2-ESCs (i.e. containing at most 6 edges). We proceed to rule out all of these bigons in subcases (i) and (ii), thereby contradicting Corollary 5.3.

First, assume (i). Then 7(a),(d),(e) are impossible by the separation of vertices of G_F . 7(b) is impossible as it can be used with the (34)-SC of σ to create a Klein bottle in M . So let f be the face bounded by the core SC of either 7(c) or 7(f). $\text{Int } A_3, \text{Int } f$ intersect T_1 in trivial curves (since M contains no projective planes). We surger away these intersections. Let B be an annulus on T_1 cobounded by the components of $a(\tau)$ and containing an edge of f . Since $B \cup A_3$ is separating, f must lie on one side. But this implies that the Möbius band, A_f corresponding to f can be pushed off of A_3 so that ∂A_f is parallel to ∂A_3 on T_1 . Then the long Möbius band A_τ can be combined with A_f to construct a Klein bottle in M . This rules out all possibilities in subcase (i).

So assume (ii). 7(c),(d),(e),(f) are ruled out by the separation of vertices. 7(b) is impossible as then we can combine its face with the long Möbius band A_τ to see a Klein bottle in M . Thus we assume Λ contains the (67)-SC of 7(a). By Corollary 5.3 and Lemma 10.18, there is a bigon face of Λ_8 giving rise to an r -ESC with $r \leq 2$. The possibilities are listed in Figure 24. But 8(c),(d),(e),(f) are ruled out by the separation of vertices. 8(b) is impossible, else it and 7(a) combine along T_2 to make a Klein bottle in M . Finally, 8(a) can be combined with A_τ to give a Klein bottle in M . This rules out possibility 7(a), hence (ii).

Case B. *There is a 1-ESC in Λ , but no 2-ESC.*

Assume G_Q contains τ , the ESC depicted in Figure 20. We follow the sequence of lemmas for Case B in SITUATION NO SCC, modifying their proofs as necessary. Note that Proposition 10.27 is proven in the next section under both SITUATION NO SCC and SITUATION SCC.

Lemma 10.22. *There cannot be two ESCs whose label sets intersect in one label.*

Proof. Let σ, ν be such ESCs. As their core SCs are on disjoint label sets, F^* must consist of two tori, each containing one of these SCs. Then one of these tori must contain all of $a(\sigma)$, say, and one component of $a(\nu)$. Since this component of $a(\nu)$ intersects $a(\sigma)$ once, they must all be isotopic on F^* . But this contradicts the Addendum to Lemma 4.3. \square

Let us now consider the possible bigons of Λ_8 and Λ_7 . These possibilities are shown in Figure 25.

Claim 10.23. *Neither 7(d) nor 8(d) may occur.*

Proof. Since each of these shares one label with τ , Lemma 10.22 rules them out. \square

Claim 10.24. *Neither 7(c) nor 8(c) may occur.*

Proof. Since 7(c) and 8(c) have disjoint labels, at most one may occur by Proposition 10.27. Assume 7(c) does occur. Then either 8(a) or 8(b) must also occur (8(d) cannot). But then there will be three disjoint SCs, contradicting Lemma 8.14. A similar argument shows 8(c) cannot occur. \square

Figure 26 shows the possible bigons of Λ_1 and Λ_6 . These will be of use in the next two claims.

Claim 10.25. *Neither 7(a) nor 8(b) may occur.*

Proof. Assume 7(a) occurs. With 7(a) and the SC in τ each of 1(a) and 1(b) form a triple of disjoint SCs, contradicting Lemma 8.14. 1(c) violates Proposition 10.27.

Therefore 1(d) must occur. Call this 1-ESC, ν . Because of 7(a), F^* must consist of two tori. By the Addendum to Lemma 4.3, one of these, T_1 , contains $a(\tau)$, and the other, T_2 , contains the edges of 7(a). But then, $a(\nu)$ must also lie in T_1 . But then the component of $a(\nu)$ containing vertex 4 of G_F must be isotopic to the components of $a(\tau)$, contradicting the Addendum to Lemma 4.3. This rules out 1(d), and hence 7(a).

A similar argument rules out 8(b), using Λ_6 in place of Λ_1 . \square

Claim 10.26. *There cannot be a (78)-SC.*

Proof. Assume there is a (78)-SC; i.e. 7(b) and 8(a) occur. We must consider the bigons of Λ_1 and Λ_6 shown in Figure 26.

Proposition 10.27 rules out 1(c) and 6(d). The argument of Claim 10.25 rules out 1(d) and 6(c). Lemma 8.14 forbids each of 1(b) and 6(a) as they are SCs each disjoint from the SC in τ and the (78)-SC.

Thus 1(a) and 6(b) must occur by Corollary 5.3. But then 1(a), 6(b), and the SC in τ form 3 mutually disjoint SCs in violation of Lemma 8.14. Thus there cannot be a (78)-SC. \square

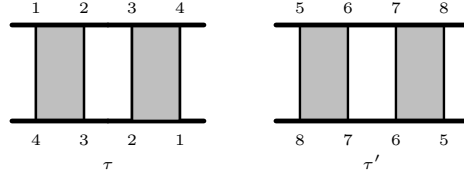

FIGURE 29.

The above claims imply that all bigons of Λ_8 are forbidden. This contradicts Corollary 5.3.

Case C. *There is no ESC in Λ .*

In this case every label belongs to an SC. Lemma 8.14 then forces $t \leq 6$ contrary to the assumed $t = 8$. This completes the proof in Case C.

Given the following subsection, the proof of Proposition 10.17 is now complete. \square

10.4. A proposition for the preceding subsections. This subsection is devoted to the proof, in both SITUATION NO SCC and SITUATION SCC, of Proposition 10.27 stated below. This proposition was used in the preceding subsections.

Proposition 10.27. *Assume M contains no Dyck's surface and $t = 8$. If there is no 2-ESC in Λ then there cannot be two disjoint ESCs.*

Throughout this subsection we assume that there is no 2-ESC and that there exists two disjoint 1-ESCs τ and τ' on the corners (1234) and (5678) as shown in Figure 29 (with Black and White faces as pictured). At the end of this section we prove Proposition 10.27 by obtaining a contradiction. To do so we must first develop several lemmas.

Let A_{23} and $A_{12,34}$ be the White Möbius band and Black annulus arising from τ . Let A_{67} and $A_{56,78}$ be the White Möbius band and Black annulus arising from τ' . By Lemma 8.12 the two components of $\partial A_{12,34}$ are parallel on \widehat{F} as are the two components of $\partial A_{56,78}$ (as M contains no Klein bottle and no Dyck's surface). By Lemma 8.5 the two annuli $A_{12,34}$ and $A_{56,78}$ are parallel into \widehat{F} (the ESCs are maximal, hence K must be disjoint from their parallelism).

Claim 10.28. *In SITUATION SCC, there is a separating, meridian disk D of H_B disjoint from K and Q (i.e. disjoint from Q in the exterior of K) such that ∂D separates $\partial A_{12,34}$ from $\partial A_{56,78}$.*

Proof. Otherwise there is a meridian disk, D , on one side of \widehat{F} which is disjoint from K and Q (see section 4.2). In particular, D is disjoint from $A_{23} \cup A_{12,34}$ and $A_{67} \cup A_{56,78}$. But then ∂D must separate $\partial A_{12,34}$ and $\partial A_{56,78}$ (else compressing \widehat{F} along D gives a 2-torus which allows one to find a Klein bottle in M). The disk D cannot be in H_W since it is disjoint from the arc (45) of $K \cap H_W$. Thus D lies in H_B as a separating disk. \square

Lemma 10.29. *The only possible Black bigons of Λ are (12),(34)-bigons and (56),(78)-bigons.*

Proof. Assume there exists a Black SC. It gives rise to a Black Möbius A' band that meets either $A_{12,34}$ or $A_{56,78}$ along an arc of K . Since these two annuli are separating, this intersection cannot be transverse. Hence A' may be slightly nudged to be disjoint from both of these annuli. Thus there are three mutually disjoint Möbius bands in M each properly embedded in H_B or H_W . This is contrary to Lemma 8.11.

The lemma now follows immediately in SITUATION SCC since the disk D of Claim 10.28 separates vertices $\{1, 2, 3, 4\}$ from $\{5, 6, 7, 8\}$ on \widehat{F} . So we assume that we are in SITUATION NO SCC. In particular, the above Möbius bands and annuli are properly embedded on the White or Black sides of \widehat{F} .

Assume there exists a (34),(56)-bigon g . (A similar argument works for (34),(78)-, (12),(56)-, and (12),(78)-bigons.) Let D_{34} and D_{56} be bridge disks for the arcs (34) and (56) contained in the solid tori cut off from the Black handlebody H_B by the annuli $A_{12,34}$ and $A_{56,78}$. Then, since g is not contained in either of these solid tori, together $D_{34} \cup g \cup D_{56}$ forms a primitivizing disk for ∂A_{23} (i.e. a disk in H_B intersecting ∂A_{23} once). Note $D_{34} \cup g \cup D_{56}$ also forms a primitivizing disk for ∂A_{67} .

Since ∂A_{23} is primitive with respect to the Black handlebody H_B , $H'_B = H_B \cup N(A_{23})$ is again a handlebody. Now K intersects H'_B in the arcs $(1234) = (12) \cup (23) \cup (34)$, (56), and (78). Note that the bridge disks for (56), (78) may be taken to be disjoint from $N(A_{23})$ hence the arcs (56) and (78) are bridge in H'_B . The arc (1234) lies in the properly embedded Möbius band $A_{12,34} \cup A_{23}$ in H'_B and hence has a bridge disk in H'_B disjoint from the bridge disks for (56) and (78). Hence the arcs for $K \cap H'_B$ are bridge in H'_B .

Furthermore since A_{23} is a Möbius band, $H'_W = H_W - N(A_{23})$ is also a handlebody. By Lemma 8.16, the arcs $K \cap H'_W$ are bridge in H'_W . Therefore H'_B and H'_W form a genus 2 Heegaard splitting of M with respect to which K is at most 3-bridge. This contradicts that $t = 8$. \square

Recall that two edges in a graph G are *in the same edge class* or *are parallel* if they cobound a bigon in the graph (not necessarily a bigon face of the graph).

Lemma 10.30. *For one of the pairs (x, y) among the set of pairs $\{(2, 3), (4, 1), (6, 7), (5, 8)\}$, there are at most two edge-classes between the vertices x, y in G_F .*

Proof. Otherwise each pair has three such edge-classes. This contradicts that \widehat{F} is genus two. \square

Lemma 10.31. *For one of either $i = 1$ or $i = 5$ the following holds: at each vertex of Λ , there are at most two Black bigons of Λ incident to its $(i, i + 1)$ -corners and at most two Black bigons of Λ incident to its $(i + 2, i + 3)$ -corners.*

Proof. After Lemma 10.30, assume that there are only two edge classes in G_F connecting vertices 4, 1 of G_F . Assume there is a vertex v of Λ that has three (12)-corners belonging to Black bigons of Λ . By Lemma 10.29, the bigons incident at these (12)-corners are (12),(34)-bigons. In particular, each such corner has a $\overline{41}$ -edge incident at label 1. But this means that one of the edges classes connecting vertices 4, 1 on G_F has two edges incident to vertex 1 with label v . This contradicts Lemma 8.15. We get a similar contradiction if there is a vertex of Λ that has three (34)-corners belonging to the same Black bigons of Λ . \square

Lemma 10.32. *A White bigon of Λ with a (23)- or (67)-corner is a SC.*

Proof. We may assume we are in SITUATION NO SCC as otherwise by Claim 10.28 there are no edges of G_F connecting vertices $\{1, 2, 3, 4\}$ with $\{5, 6, 7, 8\}$.

Assume g is a bigon of Λ with a (23)-corner that is not an SC (the argument for the (67)-corner is analogous). Hence its other corner is a (45)-, (67)-, or an (81)-corner. It cannot be a (67)-corner since then, by the orderings of labels on \widehat{F} around vertices 2 and 3, its $\overline{27}$ -edge and $\overline{36}$ -edge must lie on different components of $\widehat{F} - \partial A_{12,34}$ — contradicting that vertices 6, 7 of G_F are connected by an edge (of τ'). Let us therefore assume that g has a (45)-corner; the argument for a (81)-corner is similar.

Let r be an arc in the annulus $A_{12,34}$ sharing endpoints with (34) that projects through the ∂ -parallelism of $A_{12,34}$ onto the $\overline{34}$ -edge of g . Note that up to isotopy rel endpoints, r is just (34) twisted along $\partial A_{12,34}$. So we may take r to have a single critical value (indeed the same as for (23)) under the height function on M for the thin presentation of K . Let r' be an arc in the annulus $A_{12,34}$ disjoint from r and sharing endpoints with (12). Similarly r' can be taken to have a single critical value with respect to the height function on M . Then $r' \cup (23) \cup r$ and $(12) \cup (23) \cup (34)$ are two properly embedded, non- ∂ -parallel arcs in the Möbius band $A_{23} \cup A_{12,34}$ with the same boundary. By Lemma 8.17, these two arcs are isotopic rel- ∂ within this long Möbius band. After this isotopy the bridge arcs (34), (23), (12) are replaced with bridge arcs r , (23), r' . We may now isotop $(23) \cup r \cup (45)$, rel ∂ , onto the $\overline{25}$ -edge of g : isotop r onto the $\overline{34}$ -edge of g using the ∂ -parallelism of $A_{12,34}$, then use g to guide the remainder of the isotopy. Perturbing the result slightly into H_W gives a smaller bridge presentation of K . \square

Lemma 10.33. *There is a $\overline{23}$ -edge class in G_F that contains an edge of every (23)-SC of Λ . The analogous statement for (67)-SCs also holds.*

Proof. We prove this for (23)-SCs. The same proof works for (67)-SCs.

We assume first that we are in SITUATION NO SCC. Let e_1, e_2 be the edges of the (23)-SC in τ , and let f be the face that they bound. We assume for contradiction that there is a (23)-SC, σ_1 , with no edge parallel to e_1 in G_F , and a (23)-SC, σ_2 , of G_Q with no edge parallel to e_2 . Let g_1, g_2 be the faces of G_Q bounded by σ_1, σ_2 . Because of the orderings of the labels around vertices of G_F , one edge of g_i must lie in the annulus of \widehat{F} bounded by $\partial A_{12,34}$. This implies that one edge of g_i is parallel to e_j where $\{i, j\} = \{1, 2\}$ (note that the interior of this annulus is disjoint from K). By identifying f with g_1 along their parallel edges (in the class of e_2) we get a disk D_1 properly embedded in H_W whose boundary is given by the curve $e_1 \cup e^1$ where e^1 is the edge of σ_1 not parallel to e_2 . Similarly identifying f with g_2 , we get a meridian disk D_2 of H_W whose boundary is the curve $e_2 \cup e^2$, where e^2 is the other edge of σ_2 . By looking at the ordering of these edges around the vertices 2, 3 of G_F we see that we can take D_1, D_2, A_{23} (along with A_{67}) to be disjoint. Both D_1, D_2 must be separating in H_W (else there is a Klein bottle or projective plane in M). Then ∂D_1 , say, must separate ∂D_2 from ∂A_{23} . But again looking at the ordering of the edges of these SCs around vertices 2, 3 of G_F shows that this does not happen.

Thus we assume we are in SITUATION SCC. Let D be the separating disk of H_B given by Claim 10.28. Then there can be at most three edge-classes of $\overline{23}$ -edges in G_F (surgering \widehat{F} along D gives two 2-tori, one containing $\partial A_{12,34}$ and

the other $\partial A_{56,78}$). If the Lemma is false, then there must be exactly three such edge-classes and there must be three (23)-SCs of length two representing each pair of these edge-classes. One of these SCs is that of τ , and again let e_1, e_2 be its edges. The other two of these SCs σ_1, σ_2 , each have an edge in the $\overline{23}$ -edge class, ϵ , not represented by e_1, e_2 . Let f_1, f_2 be the faces bounded by σ_1, σ_2 in G_Q . Identifying f_1, f_2 along their edges in class ϵ gives a disk D' which is almost properly embedded in H_W whose boundary is the curve $e_1 \cup e_2$ in \widehat{F} . Then Lemma 3.3 implies that $\partial D'$ bounds a disk, D'' on one side of \widehat{F} . But then A_{23} and D'' can be used to construct a projective plane in M , a contradiction. \square

Corollary 10.34. *At every vertex of Λ there are at most two bigons of Λ at (23)-corners and at most two bigons at (67)-corners.*

Proof. Lemma 10.32 says that any bigon of Λ at a (23)- or (67)-corner must be an SC. By Lemma 10.33, there is a $\overline{23}$ -edge class containing an edge of any (23)-SC and a $\overline{67}$ -edge class containing an edge of any (67)-SC. Hence if there were three (23)-SCs or three (67)-SCs at a vertex, then two of the edges would be parallel on G_F meeting a vertex at the same label. Lemma 8.15 forbids this. \square

Proof of Proposition 10.27. By Lemmas 5.9 and 5.12, Λ has a vertex v of type $[8\Delta - 5]$ (there are no 2-ESCs). Hence v has at most 5 gaps, i.e. corners to which bigons of Λ are not incident. By Lemma 10.31, without loss of generality there exists a gap at a (12)-corner and a (34)-corner of v . By Corollary 10.34, there must be a gap at a (23)-corner and a (67)-corner. This accounts for 4 of the gaps. We now enumerate and rule out the possibilities for the remaining gap.

Since $\Delta \geq 3$, v has at least three runs of the sequences of labels 4567812. The (23)-gap and (34)-gap are not contained in these sequences. Each such sequence must have at least one gap, else by Lemma 10.32, there would be a 2-ESC (contradicting our assumptions). Thus $\Delta = 3$ and the (67)-gap, the (12)-gap, and the fifth gap must be in different runs of the sequence. But the run containing the (12)-gap will have five consecutive bigons on 456781, and, as above, Lemma 10.32 guarantees a 2-ESC. \square

11. $t < 6$.

The goal of this section is the proof of

Theorem 11.1. *Either M contains a Dyck's surface or $t < 6$.*

Proof. For contradiction we assume M contains no Dyck's surface and, by the earlier sections, that $t = 6$. Given Corollary 5.3, there are four ways in which Λ_x contains a bigon for each x :

- A. There is a 2-ESC in Λ .
- B. There are two 1-ESCs in Λ whose label sets overlap in exactly two labels.
- C. There are three SCs whose corresponding Möbius bands are disjoint.
- D. There is a 1-ESC and a disjoint SC in Λ .

Hence we proceed to address these four cases. The arguments will need to account for each of the two possibilities: SITUATION NO SCC and SITUATION SCC.

Case A. *There is a 2-ESC in Λ .*

Assume σ is a 2-ESC in Λ with corner (612345) so that it contains a (23)-SC. Let A_{23} be the White, say, Möbius band, $A_{12,34}$ be the Black annulus, and $A_{61,45}$ be the White annulus of the long Möbius band corresponding to σ , where the subscripts indicate the subarcs of K lying in these surfaces.

Subcase A(i). SITUATION NO SCC holds.

Then $A_{23}, A_{12,34}, A_{61,45}$ are properly embedded on each side of \widehat{F} . Furthermore, by Lemma 8.13, $\partial A_{12,34}$ is non-separating in H_B and $A_{61,45}$ is isotopic in H_W onto \widehat{F} .

Lemma 11.2. *There is a non-separating disk D in H_B disjoint from $A_{12,34}$ and all arcs of $K \cap H_B$.*

Proof. One can find a bridge disk for the arc (12) of K whose interior is disjoint from $A_{12,34}$ and K . Using this to ∂ -compress a push-off of $A_{12,34}$ gives the desired disk. \square

Let \mathcal{T} be the solid torus obtained by cutting H_B along D . Then $A_{12,34}$ is properly embedded in \mathcal{T} and $A_{23}, A_{61,45}$ in $M - \mathcal{T}$. Then $a(\sigma)$ is three parallel curves on $\partial\mathcal{T}$. Let B, B' be the annuli on \mathcal{T} between $\partial A_{61,45}, \partial A_{12,34}$ (resp.) on $\partial\mathcal{T}$ whose interiors are disjoint from K . Because $A_{12,34}$ is non-separating in H_B , B' intersects $N(D)$ in a disk. B is disjoint from $N(D)$. The Addendum to Lemma 8.5 applied to the long Möbius band $A_{23} \cup A_{12,34}$ (i.e. to the 1-ESC), with $\partial\mathcal{T}$ as F^* , shows that $B' \cup A_{12,34}$ bounds a solid torus, V' whose interior is disjoint from K and in which B' is longitudinal. That is, V' guides an isotopy of $A_{12,34}$ to B' , and, hence, an isotopy (rel endpoints) of the arcs (12) and (34) of K onto $\widehat{F} \cap B'$. At the same time, there is an isotopy in H_W of $A_{61,45}$ onto B , and hence of the arcs (61) and (45) (rel endpoints) onto B . This allows us to thin K to be 1-bridge, contradicting that $t = 6$ and thereby proving Theorem 11.1 in Subcase A(i).

Subcase A(ii). SITUATION SCC holds.

There is a meridian disk, D , disjoint from K and Q . Let F^* be \widehat{F} surgered along D . By Lemma 4.2 and the Addendum to Lemma 8.10, F^* consists of two tori: T_1 containing two components of $a(\sigma)$, and T_2 containing one. Finally, by the Addendum to Lemma 8.5, components of $a(\sigma)$ that are isotopic on F^* must be consecutive along the long Möbius band. Thus the vertices of G_F on T_2 are either

- (i) {2,3}
- (ii) {5,6}

Assume (i) holds. The separation of vertices implies there are no bigons of Λ with corner (56). (Since there are no $\overline{25}$ -edges or $\overline{36}$ -edges, such a bigon would have to be an SC. Its corresponding Möbius band would have boundary isotopic on T_1 to a component of $\partial A_{61,45}$ permitting the construction of an embedded Klein bottle.) Furthermore, any face of Λ containing a (23)-corner must be a (23)-SC and, since M contains no Klein bottles, the edges of any two such (23)-SCs must be parallel on T_2 (i.e. lie in two edge classes on T_2). Again by separation, any Black bigon of Λ with either a (12)-corner or a (34)-corner must be a (12),(34)-bigon, and the $\overline{41}$ -edges of any such bigon must be parallel on T_1 to one of the $\overline{41}$ -edges of σ . Thus by Lemma 8.15, at most two (23)-corners, at most two (12)-corners, and at most two (34)-corners of bigons of Λ may be incident to a vertex of Λ . Since $\Delta \geq 3$, the above implies that a vertex of Λ must have at least 6 corners (in fact at least 9) not incident to bigons of Λ . So Lemmas 5.10 and 5.13 imply that Λ must have an

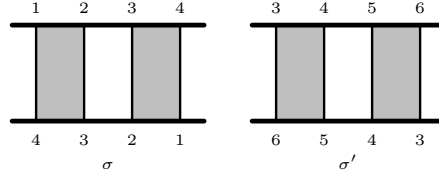

FIGURE 30.

edge class containing 8 edges. But among 8 consecutive mutually parallel edges of Λ one must have a bigon at a (56)-corner.

Thus we may assume that (ii) occurs. We are assuming (45) of K lies in H_W ; thus, by separation, the meridian disk D along which we surger to get F^* must be a meridian of H_B . Then $H_B - N(D)$ is two solid tori, $\mathcal{N} = \mathcal{N}_1 \cup \mathcal{N}_2$ where $\partial\mathcal{N}_i = T_i$. After surgery along trivial curves of intersection on F^* , we may take $A_{23}, A_{12,34}, A_{61,45}$ to be properly embedded in \mathcal{N} or its exterior.

First assume $\partial A_{61,45}$ is longitudinal in each of the solid tori \mathcal{N}_1 and \mathcal{N}_2 . Then $W = \mathcal{N} \cup N(A_{23} \cup A_{61,45})$ is a solid torus. Since K lies entirely in W , the exterior of K is irreducible and atoroidal, and M is not a lens space, K must be isotopic to a core of W . But then the core, L , of the solid torus \mathcal{N}_1 is a (2,1)-cable of K . As L is a core of H_B , Claim 8.7 contradicts that $t = 6$.

Next assume that $\partial A_{61,45}$ is not longitudinal in \mathcal{N}_2 . Let $A' = A_{23} \cup A_{12,34} \cup A_{61,45}$ be the long Möbius band properly embedded in the exterior of \mathcal{N}_2 and set $U = \mathcal{N}_2 \cup N(A')$. Then U is Seifert fibered over the disk with two exceptional fibers. We may isotop K in U so that K is the union of two arcs: α in $\partial U \cap N(A')$, and β isotopic to the arc (56) of $K \cap \mathcal{N}_2$. Since (56) is bridge in H_B , it is bridge in \mathcal{N}_2 . Let γ be a cocore of the annulus $N(A') \cap \mathcal{N}_2$. Then $V = U - N(\gamma)$ is a genus two handlebody in which β is bridge (the intersections of a bridge disk with $N(A') \cap \mathcal{N}_2$ can be isotoped onto $N(\gamma)$). Furthermore, $M - U$ must be a solid torus (the exterior of K is irreducible and atoroidal); hence, $M - V$ is genus 2 handlebody. Thus K is at most 1-bridge ($t \leq 2$) with respect to the Heegaard handlebody V of M — contradicting that $t = 6$.

Thus $\partial A_{61,45}$ must be longitudinal in \mathcal{N}_2 and hence must not be longitudinal in \mathcal{N}_1 . Let $U = \mathcal{N}_1 \cup N(A_{23})$ and $A' = A_{23} \cup A_{12,34}$. Then U is a Seifert fiber space over the disk with two exceptional fibers and A' is a properly embedded Möbius band in U whose boundary is a Seifert fiber. As $K \cap U$ is a spanning arc of A' , Lemma 8.3 contradicts that $t = 6$.

This final contradiction finishes the proof of Theorem 11.1 in Subcase A(ii).

Case B. *There are two 1-ESCs in Λ whose label sets overlap in two labels.*

First note that we may assume in Case B that SITUATION NO SCC holds. For if SITUATION SCC holds, there is a meridian disk D of either H_W or H_B disjoint from Q and K . WLOG we may assume the two ESCs are as in Figure 30. The edges of Figure 30 show that either ∂D on \hat{F} must separate vertices $\{1, 4, 5\}$ from $\{2, 3, 6\}$ or there is a projective plane or Klein bottle in M . The first is impossible as D is disjoint from K , the second since the surgery slope is non-integral.

Assume there are two ESCs σ and σ' on the corners (1234) and (3456) respectively as shown in Figure 30. Let A_{23} and A_{45} be the two White Möbius bands arising from the SCs contained within σ and σ' . Let $A_{12,34}$ and $A_{34,56}$ be the two

Black annuli arising from the remaining two pairs of bigons. As we are in SITUATION NO SCC we have that $A_{23}, A_{12,34}, A_{45}, A_{34,56}$ are properly embedded on their sides of \widehat{F} .

If either $A_{12,34}$ or $A_{34,56}$ is separating in H_B , then since $A_{12,34} \cap A_{34,56} = (34)$ they cannot intersect transversely. Hence $A_{12,34}$ and $A_{34,56}$ may be slightly isotoped to be disjoint. In particular, after this isotopy we may assume ∂A_{23} is disjoint from $\partial A_{34,56}$ (and isotopic to neither component) and similarly ∂A_{45} is disjoint from $\partial A_{12,34}$. Then by Lemma 8.12 the components of $\partial A_{12,34}$ must be parallel and the components of $\partial A_{34,56}$ must be parallel. Thus both of these annuli are separating.

Therefore either both $A_{12,34}$ and $A_{34,56}$ are separating in H_B or both are non-separating in H_B .

Subcase B(i). Both $A_{12,34}$ and $A_{34,56}$ are separating in H_B .

As noted above, $A_{12,34}$ and $A_{34,56}$ must intersect non-transversely along the arc (34) and can be perturbed to be disjoint. The annulus $A_{12,34}$ separates H_B into a solid torus \mathcal{T} and a genus 2 handlebody. As M contains no Klein bottle, $A_{34,56}$ lies outside of \mathcal{T} . Surgering along innermost closed curves and outermost arcs of intersection, we can find a bridge disk, D_{34} , for (34) of $K \cap H_B$ that intersects $A_{12,34}$ only along (34). We first assume D_{34} lies outside \mathcal{T} , i.e. it intersects it only in the arc (34). Then $\partial N(D_{34} \cup A_{12,34}) \setminus \partial H_B$ is an essential disk D and an annulus A .

The annulus A chops H_B into a solid torus \mathcal{T}' on which one impression of A on $\partial \mathcal{T}'$ runs $n \geq 1$ times longitudinally and a genus 2 handlebody H'_B that contains $A_{34,56}$ and $A_{12,34}$ such that $A_{12,34}$ is ∂ -parallel to the other impression of A on $\partial H'_B$. Then D_{34} marks ∂A_{23} as a primitive curve on H'_B . Also note that by banding across $A_{12,34} \cup D_{34}$, the arc (56) has a bridge disk D_{56} that is disjoint from $N(A_{12,34} \cup D_{34})$ and thus from D .

Attach $N(A_{23})$ to H'_B along the annulus $N(\partial A_{23})$ to form H''_B . Since ∂A_{23} is primitive in H'_B , H''_B is a genus 2 handlebody. Note that the arc (1234) of $K \cap H''_B$ lies in a Möbius band in H''_B and hence is bridge. The arc (56) is bridge in H''_B as it has a bridge disk disjoint from D .

By Lemma 8.16 both arcs (45) and (61) have bridge disks in H_W disjoint from A_{23} . Thus they both have bridge disks in the genus 2 handlebody $H'_W = H_W - N(A_{23})$. Attach \mathcal{T}' to H'_W along the annulus $A' = \partial \mathcal{T}' \setminus A = \partial \mathcal{T}' \cap \partial H_W$ to form H''_W . Since A' has ∂A_{23} as one of its boundary components it is primitive on H'_W and thus H''_W is a genus 2 handlebody. Moreover, since \mathcal{T}' is disjoint from K , so is A' ; thus the bridge disks for (45) and (61) may be assumed to be disjoint from A' as well. Hence these two arcs are bridge in H''_W .

Therefore $H''_B \cup H''_W$ is a new genus 2 Heegaard splitting for M in which K has a 2-bridge presentation. This is contrary to assumption. Hence it must be that D_{34} lies in \mathcal{T} .

Remark 11.3. If ∂A_{23} is longitudinal in \mathcal{T}' , the new Heegaard splitting, $H''_B \cap H''_W$, comes from the old (up to isotopy) by adding/removing a primitive Möbius band as described in the proof of Theorem 2.6. If ∂A_{23} is not longitudinal in \mathcal{T}' , then M is a Seifert fiber space over the 2-sphere with an exceptional fiber of order 2. In this case, we could find a vertical splitting with respect to which K has smaller bridge number by applying Lemma 8.3 to $N(A_{23}) \cup \mathcal{T}'$, a Seifert fiber space over the disk. This would then be consistent with the proof of Theorem 2.6.

Let \mathcal{T}'' be the solid torus that $A_{34,56}$ separates off H_B . Since M contains no Klein bottles, \mathcal{T} lies outside of \mathcal{T}'' ; hence, so is D_{34} . Apply the above argument to $A_{34,56}$ in place of $A_{12,34}$ to get a 2-bridge presentation of K .

Subcase B(ii). Both $A_{12,34}$ and $A_{34,56}$ are non-separating in H_B .

Since no pair of the four components of $\partial A_{12,34} \cup \partial A_{34,56}$ may be isotopic on \widehat{F} (else we get a Klein bottle), $A_{12,34}$ and $A_{34,56}$ intersect transversely along (34). Since H_B is a handlebody, $H_B - N(A_{12,34} \cup A_{34,56})$ is a single solid torus on which the annulus $\partial H_B \setminus \partial(A_{12,34} \cup A_{34,56})$ is a longitudinal annulus. That is, H_B is isotopic to $N(A_{12,34} \cup A_{34,56})$. Then ∂A_{23} is primitive in H_B . Furthermore, the arc (56) has a bridge disk in H_B disjoint from $A_{12,34}$.

Since ∂A_{23} is primitive in H_B , we may form the genus 2 handlebody H'_B by attaching $N(A_{23})$ to H_B along $N(\partial A_{23})$. Its complement $H'_W = H_W - N(A_{23})$ is also a genus 2 handlebody. Thus together H'_W and H'_B form a new genus 2 Heegaard splitting for M .

The White arcs $K \cap H_W$ other than (23) continue to be bridge in H'_W . Furthermore, since there is a bridge disk D_{56} in H_B for the Black arc (56) that is disjoint from $A_{12,34}$, D_{56} continues to be a bridge disk for (56) in H'_B . Finally, the arc (1234) is bridge in H'_B as it lies in the Möbius band $A_{12,34} \cup A_{23}$.

Thus the handlebodies H'_W and H'_B form a new genus 2 Heegaard splitting for M in which K is at most 2-bridge. This contradicts the assumption that $t = 6$.

This completes the proof of Subcase B(ii) and hence Case B cannot occur.

Case C. *There are three mutually disjoint SCs in Λ .*

Lemma 8.11 (independent of SITUATION NO SCC and SITUATION SCC) implies Case C does not occur.

Case D. *There is a 1-ESC and disjoint SC in Λ .*

This case is considered in the following Section §12. Proposition 12.1 shows Case D cannot occur.

This completes the proof of Theorem 11.1. □

12. CASE D OF THEOREM 11.1.

In this section we show:

Proposition 12.1. *Case D of Theorem 11.1 cannot occur. That is, if*

- (1) $t = 6$,
- (2) Λ contains no 2-ESC,
- (3) Λ contains a 1-ESC and an SC on a disjoint label sets,

then M contains a Dyck's surface.

Proof. Assume M does not contain a Dyck's surface. Assume there is an ESC τ with labels $\{1, 2, 3, 4\}$ and an SC σ with labels $\{5, 6\}$ as shown in Figure 31. Let A_{23} and $A_{12,34}$ be the White Möbius band and Black annulus arising from τ . Let A_{56} be the Black Möbius band arising from σ . By Lemma 8.12 (and that M contains no Klein bottle or projective plane) the components of $\partial A_{12,34}$ must be parallel on \widehat{F} bounding an annulus $B_{12,34}$ in \widehat{F} . Then by Lemma 8.5, $A_{12,34}$ is isotopic in M to $B_{12,34}$.

We consider the arguments of this subsection under both possibilities, SITUATION NO SCC and SITUATION SCC.

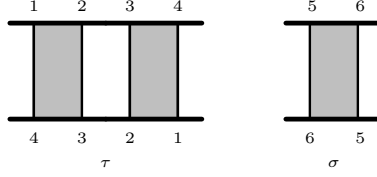

FIGURE 31.

Claim 12.2. *In SITUATION SCC, there is a separating, meridian disk D of H_B disjoint from K and Q . Let F^* be \widehat{F} surgered along D . Then F^* is two tori, T_1, T_2 , where vertices $\{1, 2, 3, 4\}$ lie on T_1 and vertices $\{5, 6\}$ on T_2 .*

Proof. Recall that SITUATION SCC implies that there is a meridian disk on one side of \widehat{F} that is disjoint from K and from Q . First assume this disk was nonseparating. Compressing \widehat{F} along it would produce a 2-torus that intersected the interiors of A_{23}, A_{56} only in trivial curves. Surgering away such intersections exposes either a projective plane or Klein bottle in M . So this disk must be separating on one side of \widehat{F} . It is disjoint from $B_{12,34}$ else it along with A_{23} forms a projective plane in M . Thus the boundary of this disk must separate vertices $\{1, 2, 3, 4\}$ in \widehat{F} from vertices $\{5, 6\}$. Since the disk is disjoint from the (45)-arc of K , it must be in H_B . \square

Lemma 12.3. *In SITUATION NO SCC, the edges of all (23)-SCs of Λ belong to two parallelism classes in G_F . In SITUATION SCC, all (23)-edges belong to two parallelism classes in G_{F^*} , where G_{F^*} is the graph induced on F^* from G_F .*

Proof. First assume SITUATION SCC holds and Claim 12.2 applies. Because the components of $\partial A_{12,34}$ are disjoint, essential curves in T_1 , any $\overline{23}$ -edge of Λ is parallel on G_{F^*} to one of the $\overline{23}$ -edges of τ .

Thus we assume we are in SITUATION NO SCC. Let ν be the core (23)-SC of τ , and assume there is another (23)-SC, ν' , with an edge that is not parallel on G_F to either edge of ν . Let f, f' be the faces bounded by ν, ν' . Let A'_{23} be the Möbius band corresponding to f' . By the ordering of the labels around the vertices 2, 3 of G_F , one edge, e'_1 , of ν' must lie within $B_{12,34}$ and the other, e'_2 , outside. That is, e'_1 is parallel in G_F to an edge e_1 of ν .

We may use the parallelism between e_1, e'_1 , along with the parallelisms of the corners of f, f' along $\partial N((23))$, to band together f, f' to get a properly embedded disk D' in H_W . Here $\partial D'$ is the curve $e_2 \cup e'_2$ on \widehat{F} , where e_2 is the edge of ν other than e_1 . By an inspection of the labelling around vertices 2, 3 of G_F , one can see that the D' can be taken to be disjoint from both A_{23}, A'_{23} and K . As e_2, e'_2 are not parallel on G_F , $\partial D'$ is not trivial on \widehat{F} . $\partial D'$ must separate $\partial A_{23}, \partial A'_{23}$ from ∂A_{56} on \widehat{F} , since M contains no Klein bottles. But this contradicts that D' is disjoint from the (45)-arc of K . \square

Lemma 12.4. *No White bigon or trigon has an edge that is a spanning arc of $B_{12,34}$.*

Proof. Let f be a White bigon or trigon with such an edge e . We assume e is a $\overline{34}$ -edge, the argument for when it is a $\overline{12}$ -edge is the same. There is a bridge disk for some arc of $K \cap H_W$ that is disjoint from f (except possibly along that arc) and hence from $\text{Int } e$ (after removing trivial arcs and simple closed curves of intersection

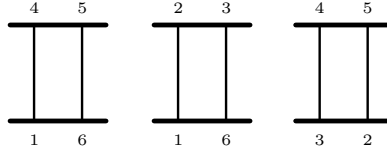

FIGURE 32.

of f with an arbitrary bridge disk, D , an outermost arc of intersection on D will cut out the desired bridge disk).

Let r be an arc in the annulus $A_{12,34}$ sharing endpoints with (34) that projects through the ∂ -parallelism of $A_{12,34}$ onto the $\overline{34}$ -edge of f . That is, there is a bridge disk for r , D_r , that intersects \widehat{F} in e . Note that up to isotopy rel endpoints, r is just (34) twisted along $\partial A_{12,34}$. So we may take r to have a single critical value (indeed the same as for (34)) under the height function on M for the thin presentation of K . Let r' be an arc in the annulus $A_{12,34}$ disjoint from r and sharing endpoints with (12). Similarly r' can be taken to have a single critical value with respect to the height function on M . Then $r' \cup (23) \cup r$ and $(12) \cup (23) \cup (34)$ are two properly embedded, non- ∂ -parallel arcs in the Möbius band $A_{23} \cup A_{12,34}$ with the same boundary. By Lemma 8.17, these two arcs are isotopic rel- ∂ within this long Möbius band. Perform this isotopy, then use the Black bridge disk D_r along with the White bridge disk of the preceding paragraph to give a thinner presentation of K — a contradiction. \square

Lemma 12.5. *The only type of White bigon in Λ that is not an SC is a (45),(61)-bigon.*

Proof. The three possible non-Scharlemann White bigons are shown in Figure 32. We will rule out the two that have a (23)-corner. Note that we may assume we have SITUATION NO SCC because of the separation that comes from Claim 12.2 in SITUATION SCC. Let us focus on the bigon R with the $\overline{12}$ -edge as the proof is analogous for the other.

Since R has a (23)-corner, the labelling around vertices 2, 3 of G_F forces the edges $\overline{12}$ and $\overline{36}$ to be incident to the vertices 2 and 3 on opposite sides of ∂A_{23} in \widehat{F} . Therefore since the $\overline{36}$ -edge must connect vertex 3 to vertex 6, the $\overline{12}$ -edge must lie in the annulus $B_{14,23}$. But this contradicts Lemma 12.4. \square

Corollary 12.6. *At most two (23)-corners at a vertex belong to bigons of Λ .*

Proof. Assume there are three (23)-corners at vertex x of Λ belonging to bigons of Λ . By Lemma 12.5, these bigons must all be SCs. By Lemma 12.3 these six edges belong to two parallelism classes on either G_F or G_{F^*} . Therefore two of these six edges must be incident to the same vertex of G_F (G_{F^*}) at the label x and parallel. This violates Lemma 8.15 (Lemma 12.15). (If only two bigons are incident at these three corners, two of the edges will have label x at both ends in G_F and Lemma 8.15 (Lemma 12.15) is still violated). \square

Lemma 12.7. *Λ does not contain a (12)- or a (34)-SC.*

Proof. Assume there exists a (34)-SC. Let A_{34} be the corresponding Möbius band.

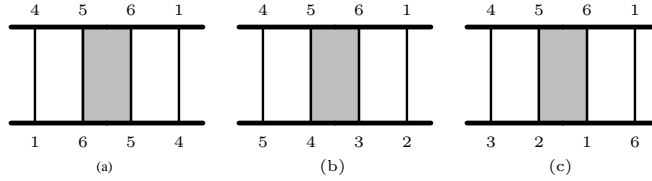

FIGURE 33.

Since the annulus $A_{12,34}$ cobounds a solid torus with $B_{12,34}$, the Möbius band A_{34} must intersect $A_{12,34}$ tangentially. Therefore A_{34} may be isotoped to be disjoint from A_{23} . Since it is also disjoint from A_{56} , Lemma 8.11 implies that M contains a Dyck's surface.

A similar argument rules out the existence of a (12)-SC. \square

Lemma 12.8. *There cannot be an ESC with labels $\{4, 5, 6, 1\}$.*

Proof. Assume there is such an ESC and take σ to be its core SC. Let $A_{45,61}$ be the corresponding annulus formed from the bigons that flank σ . Observe that $A_{45,61}$ is disjoint from the Möbius band A_{23} , and $A_{12,34}$ is disjoint from the Möbius band A_{56} . Then by Lemma 8.12 (and that there are no Klein bottles in M) the components of $\partial A_{45,61}$ must be parallel as must the components of $\partial A_{12,34}$. This contradicts Claim 12.2 in SITUATION SCC. In SITUATION NO SCC, Lemma 8.5 implies these annuli must be isotopic into \widehat{F} . Together these parallelisms give a thinning of K . \square

Corollary 12.9. *There cannot be three consecutive bigons around a vertex with a (4561)-corner.*

Proof. Assume there were. Then there are three possibilities according to whether opposite the (56)-corner is the (56)-, (34)-, or (12)-corner. These are shown in Figure 33. The first is ruled out by Lemma 12.8 since it is an ESC with labels $\{4, 5, 6, 1\}$. The second and third are ruled out since they contain the non-SC White bigons prohibited by Lemma 12.5. \square

Lemma 12.10. *There cannot be a White trigon with a single (23)-corner.*

Proof. If there were such a trigon, then its two edges incident to that corner must be incident to opposite sides of ∂A_{23} on \widehat{F} . Thus one of these edges must be a spanning arc of $B_{12,34}$. This is prohibited by Lemma 12.4. \square

Lemma 12.11. *There cannot be a Scharlemann cycle of length 3 on the labels $\{2, 3\}$.*

Proof. Assume g is the trigon face of such a (23)-Scharlemann cycle. The ends of two edges of g incident to the same corner of g must be incident to opposite sides of ∂A_{23} as they lie on \widehat{F} . Since the annulus $B_{12,34}$ has ∂A_{23} as a boundary component, around ∂g the edges are alternately in or not in $B_{12,34}$. This of course cannot occur since g has three edges. \square

Lemma 12.12. *In Λ , a trigon cannot have exactly two (23)-corners.*

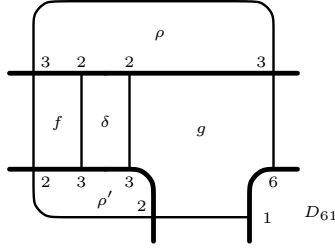

FIGURE 34.

Proof. First we assume SITUATION SCC holds. This means there is a Black meridian disjoint from G_F separating vertices $\{1, 2, 3, 4\}$ and $\{5, 6\}$. The third corner of a trigon with two (23)-corners must be either a (61)-corner or a (45)-corner. But then G_F has an edge joining either vertices 2 and 5 or vertices 3 and 6, a contradiction.

Thus we may assume we satisfy SITUATION NO SCC. A trigon with a single (23)-corner is prohibited by Lemma 12.10. A trigon with three (23)-corners is a Scharlemann cycle of length 3 which cannot occur by Lemma 12.11. Thus any trigon with a (23)-corner must have exactly one other (23)-corner.

Assume g is a trigon with two (23)-corners and, WLOG, one (61)-corner. We shall construct a bridge disk for (61) that does not intersect the interior of $B_{12,34}$. Such a bridge disk for (61) is disjoint from a bridge disk for (34) and hence provides a contradictory thinning of K .

Because the $\overline{12}$ -edge and the $\overline{36}$ -edge of g must be incident to the side of ∂A_{23} opposite from which the $\overline{23}$ -edge is incident (by the labelling around vertices 2, 3 of G_F), neither of them lie in the annulus $B_{12,34}$. Furthermore, the $\overline{23}$ -edge is parallel in G_F to a $\overline{23}$ -edge of the SC in τ . Let f be the bigon face of the SC in τ . Let δ be the rectangle of parallelism on G_F between the two $\overline{23}$ -edges of g and f ; its other two sides are arcs of the vertices 2 and 3. Let ρ and ρ' be the disjoint rectangles on $\partial N(K)$ between the two (23)-corners of g and the two (23)-corners of f ; the other two sides of each of ρ, ρ' being arcs of the vertices 2 and 3. Then $g \cup \delta \cup \rho \cup \rho' \cup f$ forms a disk D_{61} whose boundary is composed of the (61)-corner of g and an arc on \widehat{F} ; see Figure 34. By a slight isotopy, the interior of this arc on \widehat{F} may be made disjoint from $B_{12,34}$. Thus D_{61} is the desired bridge disk for (61). \square

Lemma 12.13. *No trigon in Λ has a (23)-corner.*

Proof. This is a combination of Lemmas 12.11, 12.12, and 12.10. \square

12.1. Special vertices for Case D of Theorem 11.1. As Λ contains no 2-ESCs there may be no more than 7 edges that are mutually parallel.

Since $t = 6$, Lemmas 5.10 and 5.13 imply there exists a vertex v of Λ of type $[6\Delta - 5, 4]$, $[6\Delta - 4, 1]$, or $[6\Delta - 3]$. We refer to a corner at v that is not incident to a bigon of Λ as a *gap*. Thus there are at most 5 gaps at v . We will argue by contradiction, in each case showing that there must be more gaps than specified.

By Corollary 12.9, each of the Δ corners (4561) around v must have a gap. By Corollary 12.6 at least $\Delta - 2$ (23)-corners must have gaps as well. Thus there must be at least $2\Delta - 2$ gaps. If $\Delta \geq 4$ then there must be at least 6 gaps; a contradiction. Hence $\Delta = 3$.

When $\Delta = 3$ the vertex v is of type $[13, 4]$, $[14, 1]$, or $[15]$. Type $[15]$ is prohibited since using $\Delta = 3$ in the argument of the preceding paragraph implies v must have at least 4 gaps. We eliminate the remaining types in the following subsections.

12.2. Vertex v is of type $[14, 1]$. There are at most 4 gaps at v . By Corollary 12.9, each of the three sequences of the labels (4561) must have a gap. By Corollary 12.6 one (23) -corner must be a gap. Thus there are two sequence of bigons with a (1234) -corner. Therefore by the following Lemma 12.14 there must be a gap at the remaining (12) -corner or (34) -corner at v . This however requires 5 gaps at v .

Lemma 12.14. *If there are two (23) -corners at a vertex x that belong to bigons of Λ , then at the other (23) -corner of x one of the adjacent corners does not belong to a bigon of Λ .*

Proof. Assume two (23) -corners at x belong to bigons of Λ . By Lemma 12.5 these bigons are SCs, σ_1, σ_2 (we assume they are distinct else a similar argument holds). Assume there is another (23) -corner at x such that there is a bigon incident to its adjacent (12) -corner (if the (34) -corner, the same argument applies). Let e_2, e_3 be the edges of G_Q incident to this (23) -corner (where e_2 has label 2 at x). By Lemma 12.7, e_2 is either a $\overline{23}$ -edge or a $\overline{25}$ -edge of Λ . As an edge of G_F , e_2 must lie outside of $B_{12,34}$ (if it were a $\overline{23}$ -edge, then it along with edges of σ_1, σ_2 would, by Lemma 12.3, violate Lemma 8.15 or Lemma 12.15). But then e_3 as an edge in G_F must lie inside $B_{12,34}$ (by the ordering of the labels around vertices 2,3 of G_F coming from (23) -Scharleman cycle of τ and e_2, e_3). If e_3 is also in a bigon of Λ , then it must be a $\overline{23}$ -edge (by Lemma 12.7 and since vertex 6 does not lie in $B_{12,34}$). As e_3 lies in $B_{12,34}$, it must be parallel to edges of σ_1, σ_2 , which by Lemma 12.3 would violate Lemma 8.15 or Lemma 12.15. \square

12.3. Vertex v is of type $[13, 4]$. There are at most 5 gaps around v ; at least 4 of these gap corners belong to trigons of Λ ; there is at most one corner that may belong to neither a bigon nor trigon of Λ . Note that this implies that every edge incident to v lies in Λ .

By Corollary 12.9 each of the three (4561) -corner sequences around v must be missing a bigon. Thus among the three (1234) -corner sequences, only two may be missing a bigon. Let us distinguish these three (1234) -corner sequences around v by marking them as $v, v',$ and v'' . Furthermore let e_i, e'_i and e''_i be the edge of Λ incident to $v, v',$ and v'' respectively at the label i for $i = 1, 2, 3, 4$.

By Corollary 12.6 at least one (23) -corner is a gap, say the one at v . Since there is not a trigon with a (23) -corner by Lemma 12.13, only v may have a gap at its (23) -corner. Thus the two (23) -corners at v' and v'' have bigons. These bigon faces are SCs by Lemma 12.5. By Lemmas 12.3, 8.15, and 12.15, neither e_2 nor e_3 may be parallel on G_F to one of the $\overline{23}$ -edges in $\partial B_{12,34}$. Thus the labelling around vertices 2,3 of G_F forces one edge to be a spanning arc of $B_{12,34}$ and the other to lie outside $B_{12,34}$ and not parallel into $\partial B_{12,34}$. Without loss of generality, let us assume e_3 is a spanning arc of $B_{12,34}$ and thus is a $\overline{34}$ -edge (by the Parity Rule of section 3).

Since e_3 is a $\overline{34}$ -edge, the adjacent (34) -corner cannot belong to a bigon. Otherwise such a bigon would be a Black (34) -SC. By Lemma 12.7 this does not occur. Thus the adjacent (34) -corner must belong to a trigon g . Since the edge e_3 of this Black trigon g is a spanning arc of $B_{12,34}$, g lies in the solid torus of parallelism

of $A_{12,34}$ into $B_{12,34}$. Hence g has a second (34)-corner and a (12)-corner. (It cannot be a (34)-SC as $A_{12,34}$ is parallel into $B_{12,34}$.) Moreover edge e_4 of g is a $\overline{14}$ -edge. Since e_4 is contained in $B_{12,34}$, it belongs to one of the two $\overline{14}$ -edge classes of $\partial B_{12,34}$.

Because there are at most 5 corners of v without bigons, the two (1234)-corner sequences at v' and v'' must entirely belong to bigons and thus form ESCs. Furthermore, the (12)-corner at v must be a bigon h in Λ . It is either a (12),(34)-bigon or a (12),(56)-bigon.

Assume h is a (12),(34)-bigon. At v we have identified three $\overline{41}$ -edges incident to v at label 4, e_4, e'_4, e''_4 , and three $\overline{23}$ -edges incident to v at label 2. By Lemma 8.15, the $\overline{41}$ -edges (as well as the $\overline{23}$ -edges) must be in distinct edge classes in G_F . Thus a neighborhood of $B_{12,34}$ and these edges is an essential 4-punctured sphere, S , in \widehat{F} . This immediately rules out SITUATION SCC as there would have to be a separating Black meridian disjoint from S . We assume SITUATION NO SCC. As e_4 is parallel to one of the $\overline{41}$ -edges of $\partial B_{12,34}$, it must be that e'_4 , say, is not in one of the edge classes of $\partial B_{12,34}$. By Lemma 12.3, there must be a (12),(34)-bigon f of τ and a (12),(34)-bigon f' containing e'_4 such that the $\overline{23}$ -edges of f, f' are parallel but the $\overline{41}$ -edges are not. Banding f, f' together along the parallelism of the $\overline{23}$ -edges in G_F , along with the corresponding rectangles along the boundary of the knot exterior, gives a Black disks D' whose boundary on \widehat{F} is the union of the $\overline{41}$ -edges of f, f' . This disk can be taken disjoint from K , and from the Möbius bands formed from σ and from the (23)-SC of τ . Thus $\partial D'$ must be separating in \widehat{F} (else we can form a Klein bottle or projective plane with these Möbius bands). But $\partial D'$ can be isotoped to ∂S , contradicting the fact that it is separating.

Thus we may assume h is a (12),(56)-bigon. This immediately rules out SITUATION SCC (vertices 2, 5 would have to be separated). Again let e_4, e'_4, e''_4 be the $\overline{41}$ -edges incident to v with label 4. By Lemma 8.15, one of these (not e_4), say e'_4 , is not parallel to either of the $\overline{41}$ -edges of $\partial B_{12,34}$. By Lemma 12.3, there must be a (12),(34)-bigon, f , of τ and (12,34)-bigon, f' , containing e'_4 whose $\overline{23}$ -edges are parallel but whose $\overline{41}$ -edges are not. Banding f, f' along the parallelism of their $\overline{23}$ -edges as above gives a Black disk D' which is disjoint from the Möbius bands formed from σ and from τ . Thus $\partial D'$ must be separating in \widehat{F} . On the other hand, $\partial D'$ can be isotoped to the boundary of the essential 4-punctured sphere formed from a neighborhood in \widehat{F} of the $\overline{25}$ -edge in h, e'_4, σ , and $B_{12,34}$; hence, it cannot be separating.

This completes the proof of Proposition 12.1. \square

12.4. A generalization of Lemma 8.15 to G_{F^*} . We finish with a generalization of Lemma 8.15 that is needed for this section as well for section 18.

Lemma 12.15. *Let D be a meridian disk of \widehat{F} disjoint from Q and K , and F^* be \widehat{F} surgered along D (hence is either one or two tori). Let G_{F^*} be the induced graph on F^* . There cannot be parallel edges of G_{F^*} that are incident to a vertex at the same label.*

Proof. Let e, e' be parallel edges on G_{F^*} incident to a vertex v of G_{F^*} with the same label. If there are no monogons (1-sided faces) of G_{F^*} in the parallelism between these two edges, then the proof of Lemma 8.15 directly applies (after possibly surgering away simple closed curves of intersection). But the graph G_{F^*} may contain monogons even though G_F does not. Any monogon of G_{F^*} must

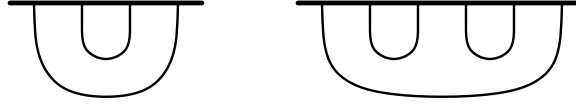

FIGURE 35.

contain at least one impression of D . In particular, there may be at most two innermost monogons of G_{F^*} .

Claim 12.16. *Any monogon of G_{F^*} must be innermost.*

Proof. If there is a non-innermost monogon of G_{F^*} , then there is one that appears as one in Figure 35. Each of these configurations gives a long disk¹ for K as a knot in S^3 , contradicting its thinness there. \square

Claim 12.17. *If there are monogons of G_{F^*} in the parallelism between e and e' , then there are exactly two and they appear as in Figure 36(a).*

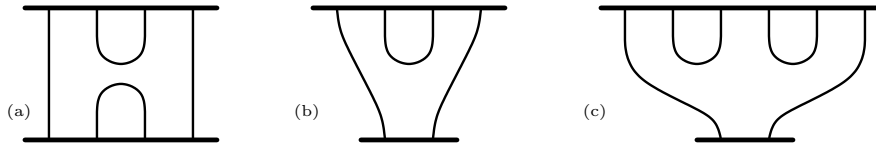

FIGURE 36.

Proof. Since there may be only two monogons and they are not nested, there are three possible configurations for monogons between parallel edges. These are shown in Figure 36(a), (b), (c). Configurations (b) and (c) give lopsided bigons² for K as a knot in S^3 , contradicting its thinness there. \square

So we may assume there are two monogons as in Figure 36(a) among the parallel edges between e and e' . Note that e and e' have the same label pairs. Abstractly band the monogons together as in Figure 37 to take advantage of the arguments of [18].

We employ the notation of [18], substituting $F^* = P_\alpha$ and $Q = P_\beta$. We set $n_\beta = |K \cap \widehat{Q}|$ and may assume $n_\beta + 1$ is the number of arcs from e to e' . Let A_m and A_{m+1} be the arcs formed from banding the two monogons together, $1 < m < n_\beta$. (Since n_β is even, we have $n_\beta + 1$ arcs, and neither A_m nor A_{m+1} is e or e' , then we may relabel and take our n_β parallel arcs so that neither A_m nor A_{m+1} is outermost among these n_β arcs.) Let A' and A'' be the arcs of the original monogons.

We first assume the vertices of G_{F^*} connected by e, e' have the same parity (are parallel). Using A_m, A_{m+1} in place of A', A'' , we apply the arguments in section 5 of [18] in the case $(1)\epsilon = -1$. These show that these edges form an ESC on G_{F^*} which we may assume is centered about the edges A_m, A_{m+1} that form a SC (else S^3 has an RP^3 summand). The edges of this ESC other than A_m, A_{m+1} then

¹See Lemma 15.2 here or Lemma 2.2 and Figure 1 of [1] for the concept of a *long disk*.

²See Lemma 15.2 here or the last two paragraphs of the of Lemma 6.15 [1] for the concept of a *lopsided bigon*.

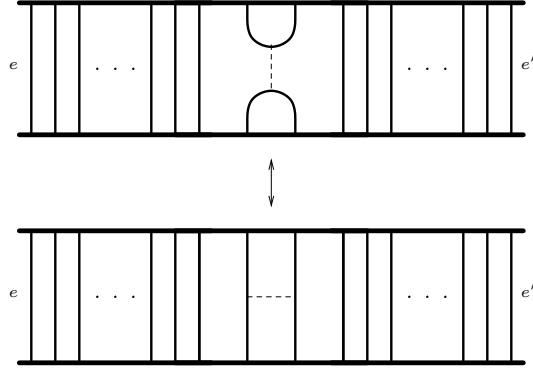

FIGURE 37.

come in pairs, forming disjoint simple closed curves on \widehat{Q} . Some innermost pair of these edges then bounds a disk in G_Q (since the edges A', A'' connect the remaining vertices $\{m, m+1\}$). The argument of [18], after possibly surgering away simple closed curves of intersection, implies that K is a $(1, 2)$ -cable knot — contradicting its hyperbolicity.

We next assume the vertices of G_{F^*} connected by e, e' have the opposite parity. Again, using A_m, A_{m+1} in place of A', A'' , we apply the arguments in section 5 of [18] in the case (2) $\epsilon = 1$. The map π partitions the arcs A_1, \dots, A_{n_β} into orbits of equal cardinality of at least 2. Since the surface \widehat{Q} is separating, the map π must have an even number of orbits ($i \equiv \pi(i) \pmod{2}$ by the Parity Rule). In particular, A_m and A_{m+1} belong to different orbits. Each orbit θ , other than the ones containing A_m and A_{m+1} , gives rise to a simple closed curve C_θ on \widehat{Q} . Exchanging A_m, A_{m+1} for A', A'' merges the two orbits containing vertices $m, m+1$, giving rise to a single simple closed curve C' on \widehat{Q} . All of these simple closed curves are mutually disjoint on \widehat{Q} .

If there is a simple closed curve other than C' (i.e. if there are more than 2 orbits of π) then there is one that is innermost on \widehat{Q} ; let this be the C_θ that is used to complete the proof in [18].

If C' is the only simple closed curve then e and e' must be parallel on G_Q , bounding a disk in G_Q whose interior is disjoint from C' . The argument of [18] in case (1) (above) applies to show that K is a $(1, 2)$ -cable knot, a contradiction. \square

13. WHEN $t = 4$ AND NO SCC.

In this section we assume that $t = 4$ and that we are in SITUATION NO SCC.

We use configurations of bigons and trigons at a special vertex of Λ to either produce a Dyck's surface in M or to find a new genus two Heegaard splitting of M with respect to which K has bridge number 0 or 1 (i.e. making $t = 0$ or $t = 2$).

Λ cannot have 9 mutually parallel edges by Lemma 16.9. Therefore by Lemmas 5.11 and 5.13 there exists a special vertex x in Λ of type $[4\Delta - 3], [4\Delta - 4, 1]$, or $[4\Delta - 5, 4]$. Recall from section 5.3 that a special vertex, x , of Λ is of type $[a, b]$ if, of the 4Δ corners at x , a belong to bigons of Λ and b belong to trigons of Λ . Nothing is known of the faces to which the remaining corners belong, indeed these faces might not even belong to Λ . We refer to the corners of x which belong to

these latter faces as *true gaps* at x . Thus all but $a + b$ corners of x are true gaps. We refer to those corners at x as *gaps* which are not known to belong to bigons of Λ at x (i.e. the true gaps as well as the b corners that belong to trigons of Λ). Thus, all but a corners at x are gaps. In sequence around x we label the faces in Λ as follows: **B**: bigon, **S**: an SC, **M**: mixed bigon, **T**: trigon. A mixed bigon of Λ is one that is not an SC. We label as **g**: gap, **G**: true gap. If **ABC** and **XYZ** are two disjoint subsequences of faces around a vertex, we write **ABC+XYZ** to indicate coherent ordering (orientation) without assuming relative positions.

Lemma 13.1. *If $t = 4$ and SITUATION NO SCC then either M contains a Dyck's surface or $\Delta \leq 3$.*

Proof. Assume $t = 4$ and SITUATION NO SCC, that $\Delta \geq 4$ and M does not contain a Dyck's surface. As mentioned above, Lemma 16.9 along with Lemmas 5.11 and 5.13 guarantee that there exists a special vertex x in Λ of type $[4\Delta - 3]$, $[4\Delta - 4, 1]$, or $[4\Delta - 5, 4]$.

x **has type** $[4\Delta - 3]$. Since $\Delta \geq 4$, there must be five consecutive bigons around x . This contradicts Lemma 16.9.

x **has type** $[4\Delta - 4, 1]$. First assume there are 4 consecutive bigons at x . By Lemma 16.9, these must be flanked by two gaps. By relabeling we may assume these four bigons contain a (1234)-ESC. By Lemma 16.7 all bigons or trigons of Λ at (23)-corners must actually be (23)-SCs; furthermore, the edges of any two such bigons must come in parallel pairs on G_F . By Lemma 8.15 then, all but at most two (23)-corners at x are (true) gaps. As there are four gaps at x , two of which are contiguous to the four consecutive bigons above and hence are not (23)-corners, $\Delta = 4$. By Lemma 16.9 the positions of these two remaining gaps at (23)-corners is forced and there must exist a (3412)-ESC at x . But then there are four (41)-SCs at x . Together Lemmas 16.7 and 8.15 provide a contradiction.

Since there cannot be four consecutive bigons at x , we must have $\Delta = 4$ and there must be four triples of bigons at x separated by single gaps. Since one of the gaps is actually a trigon, Lemma 15.5 implies that the adjacent triples of bigons are ESCs. Then Lemma 16.7 implies all four triples are ESCs. Since their SCs all have the same labels, Lemmas 16.7 and 8.15 provide a contradiction.

x **has type** $[4\Delta - 5, 4]$. If there is a, say, (1234)-ESC, then it must be adjacent to a true gap by Lemma 16.8. By Lemmas 16.7 and 8.15 there must also be a true gap at some (23)-corner, but x has only one true gap. Hence there is no ESC at x .

Since $\Delta \geq 4$ and there is no ESC, there must appear **BgSMSgB** around x . Because there is only one true gap at x , applying Lemma 15.6 to those gaps that are actually trigons implies there are at most 10 corners around x , a contradiction. \square

Theorem 13.2. *If $\Delta \geq 3$, $t = 4$, and SITUATION NO SCC then M contains a Dyck's surface.*

Proof. Assume $t = 4$ and SITUATION NO SCC, that $\Delta \geq 3$ and M does not contain a Dyck's surface. As mentioned above, Lemma 16.9 along with Lemmas 5.11 and 5.13 guarantee that there exists a special vertex x in Λ of type $[4\Delta - 3]$, $[4\Delta - 4, 1]$, or $[4\Delta - 5, 4]$.

By Lemma 13.1 and our hypothesis, $\Delta = 3$. But then Theorems 13.6 and 13.7 contradict each other. \square

13.1. The lemmas to complete $t = 4$ and SITUATION NO SCC. The goal of this section is to finish the proof of Theorem 13.2 by proving Theorems 13.6 and 13.7. So for this subsection we assume $t = 4$, SITUATION NO SCC, M contains no Dyck's surface, and $\Delta = 3$. Thus a special vertex of Λ is one of type $[4]$, $[8, 1]$, or $[7, 4]$.

Lemma 13.3. *If $\Delta = 3$ then a special vertex x of Λ cannot have BBBB.*

Proof. By Lemma 16.9 there cannot be five bigons in a row. By Lemma 16.14 there cannot be a trigon adjacent to these four bigons. Hence four consecutive bigons must be flanked by true gaps. Thus, assuming a special vertex x of Λ has BBBB, it has type $[9]$ or $[8, 1]$.

Up to relabeling, we may assume for this vertex we have

1	2	3	4	1	2	3	4	1	2	3	4
G	M	S	M	S	G						G

By Lemma 16.7 the remaining two (23) -corners each have a G or S and the remaining (41) -corner has a G, S, or Scharlemann cycle T. Lemmas 8.15 and 16.7 imply that one of these two (23) -corners must have the last G so that the (41) -corner has an S or a Scharlemann cycle T:

	1	2	3	4	1	2	3	4	1	2	3	4
(1)	G	M	S	M	S	G	S				G	G
(2)	G	M	S	M	S	G	G				S	G

If x has type $[9]$, then the remaining corners must be bigons. In line (2) above there must be five consecutive bigons, contrary to Lemma 16.9. In line (1) above the three bigons to the left of the G (at (23)) form an ESC with labeling contrary to Lemma 16.10.

Thus x has type $[8, 1]$ and there must be a T. First, assume this T is at the remaining (41) -corner, and hence is an SC. Then Lemma 16.15 contradicts both lines (1) and (2) above (where the roles of labels 2, 3 and 4, 1 are interchanged). Thus we assume this (41) -corner must belong to an S. Lemma 16.10 implies that the T must be adjacent to this S. Since the bigon to the other side of this S must be an M, we have a FESC whose presence violates Lemma 16.13. \square

Theorem 13.4. *If $\Delta = 3$ then a special vertex x of Λ cannot have an ESC.*

Proof. Assume there is an ESC around x . By Lemma 16.8 this ESC must be adjacent to a true gap. WLOG we assume the ESC is on the corner (1234) with the true gap to the left and, by Lemma 13.3, a gap to the right.

Case I. The vertex x has type $[7, 4]$.

By Lemma 16.7, all three (23) corners around x have SCs whose edges are parallel to that of the ESC. This gives a contradiction via Lemma 8.15.

Case II. The vertex x has type $[8, 1]$ or $[9]$.

Up to relabeling we may assume we have one of the following:

	1	2	3	4	1	2	3	4	1	2	3	4
(1)	G	M	S	M	G							G
(2)	G	M	S	M	T							G

By Lemmas 16.7 and 8.15 one of the remaining (23) -corners has a G and the other has an S. (If both (23) -corners have a true gap then we are in (2) above, and

the remaining corners belong to bigons of Λ . Then by Lemma 16.7 there is an ESC containing a (41)-SC. This contradicts Lemma 16.10.) Furthermore Lemma 16.7 implies the remaining (41)-corner has a \mathbf{G} , \mathbf{S} , or Scharlemann cycle \mathbf{T} .

If x is as in line (1) then one of the remaining (23)-corners must take the last \mathbf{G} . This gives a run of five yet to be accounted corners. Without one of the last corners being a \mathbf{T} , there would be four consecutive bigons contrary to Lemma 13.3. So x cannot have type [9] and must have type [8, 1]. Since the remaining (23)-corner in this run of five must be an \mathbf{S} , the two possible placements of the \mathbf{T} give configurations $\mathbf{GMSTSMG}$ and $\mathbf{GMSMTMG}$ (or $\mathbf{GMTMSMG}$) overlapping the original \mathbf{GMSMG} on one \mathbf{G} . The former is forbidden by Lemma 15.12. The latter may be seen as a case of line (2).

We may now assume x is as in line (2). Note that the pictured \mathbf{T} is a Scharlemann cycle by Lemma 16.7. If the remaining (41)-corner has an \mathbf{S} then Lemma 13.3 implies that the final \mathbf{G} must be between this \mathbf{S} and the \mathbf{S} at whichever of the two remaining (23)-corners. In these two cases, the types of bigons may be determined at enough of the remaining corners for Lemma 16.15 to apply and be contradicted by the number of $\overline{23}$ -edges at the vertex. Therefore the remaining (41)-corner has a \mathbf{G} . Whichever of the remaining (23)-corners gets an \mathbf{S} must then be flanked by \mathbf{M} bigons and all remaining bigons must be Black. Hence we must have the configuration $\mathbf{gMSMgMSMgBgB}$ which is forbidden by Lemma 16.12. \square

Theorem 13.5. *If $\Delta = 3$ then at a special vertex x of Λ a triple of bigons must be adjacent to a true gap.*

Proof. Assume otherwise. Then by Lemma 13.3 we must have \mathbf{TBBBT} at x . By Lemma 16.8 we have \mathbf{TSMST} . Hence the vertex x must have type [7, 4]. By symmetry we may assume we do not have the true gap immediately to the right, so that we have either \mathbf{TSMSTB} or \mathbf{TSMSTT} . We then have the following possible configurations at x :

(1)		B	T	S	M	S	T	B	
(2)		B	T	S	M	S	T	T	
(3)		T	T	S	M	S	T	T	
(4)		G	T	S	M	S	T	B	
(5)		G	T	S	M	S	T	T	

Lines (1) and (4) contradict Lemma 15.6 (too many true gaps). Note, as in all of these lemmas, Lemma 15.6 applies equally well to the reverse ordering, \mathbf{BTSM} .

In line (2), the \mathbf{B} must be an \mathbf{S} by Lemma 15.6. There are three remaining corners of the same color as the \mathbf{M} shown. Lemmas 15.10, 15.14, and 15.6 then imply the \mathbf{G} must be adjacent to the newly placed \mathbf{S} and the other two corners are filled with an \mathbf{M} and the last \mathbf{T} . Regardless of this last choice, the remaining two corners are both \mathbf{S} s (Lemma 15.2). Thus five corners of the same color have an \mathbf{S} . The edge shared by the adjacent \mathbf{T} s is parallel to an edge of the \mathbf{M} shown in line (2) by Lemmas 15.2 and 14.5. Now Lemma 16.1 applies providing a contradiction to Lemma 8.15.

In lines (3) and (5) there must be two more bigons the same color as the \mathbf{M} shown. Lemma 15.14 implies each of these must be an \mathbf{M} , but this contradicts Lemma 15.10. \square

Theorem 13.6. *If $\Delta = 3$ then a special vertex x of Λ cannot contain a triple of bigons.*

Proof. Assume there is BBB at the special vertex x . By Theorems 13.4 and 13.5, every BBB is an SMS adjacent to a gap. In particular, we have GSMST.

Case I. The vertex x has type $[7, 4]$. Then by Lemma 13.3 we must have GSMST. Note that the true gap indicated is the only one at x . The FESC must be type I by Lemma 15.2. Lemma 15.6 implies we cannot have GSMSTB. Thus we must have GSMSTT. To the right of this there are 2, 1, or 0 Bs before the next T (Theorem 13.5).

Case Ia. Assume we have GSMSTTBBT. If the BB are SM then we contradict Lemma 15.8. If the BB are MS then by Lemmas 15.5 and 15.8 the remaining three spots are filled with TMS. Yet this contradicts Lemma 15.10.

Case Ib. Assume we have GSMSTTBT. The B is the same color as the M. Since three of the remaining four positions get a bigon, one of these must be the same color as the M too. This however contradicts Lemma 15.10 or 15.14.

Case Ic. Assume we have GSMSTTT. Theorem 13.5 permits only two positions for the final T.

(1)	G	S	M	S	T	T	T		T				G
(2)	G	S	M	S	T	T	T			T			G

Theorem 13.4 labels the triple of bigons in line (1) as SMS. Now Lemma 15.6 gives a contradiction.

In line (2), the bigons to each side of this last T are the same color as the M. This contradicts Lemma 15.10 or 15.14.

Case II. The vertex x has type $[8, 1]$.

Thus we have four gaps (one trigon and three true gaps) and by Lemma 13.3 we must have gSMSg (where at least one of these gaps is a true gap). By Lemma 16.17 we cannot have gSMSgSMSg. Thus, up to symmetry, we must have one of the following four configurations

	1	2	3	4	1	2	3	4	1	2	3	4	
(1)	g	S	M	S	g	g	S	M	S	g			g
(2)	g	S	M	S	g		g			g			g
(3)	g	S	M	S	g		g	S	M	S	g		g
(4)	g	S	M	S	g			g		g			g

In line (1), filling in the last two blanks with either MS or SM produces a contradiction to Lemma 17.1.

In line (2), by Lemma 15.5 the initial g must be G so that the T occurs at one of the remaining three. Lemmas 15.2 and 15.14 force configuration (i) below when the T is at the second gap. When the T is at the third gap, Lemmas 15.2, 15.14, and 17.1 force configurations (ii), (iii), and (iv) below. Lemma 15.5 determines the labelings of all the bigons but one if the T is at the last g, giving (v) below.

	1	2	3	4	1	2	3	4	1	2	3	4	
(i)	G	S	M	S	T	S	G	S	M	G	M	S	g
(ii)	G	S	M	S	G	S	T	S	M	G	M	S	g
(iii)	G	S	M	S	G	S	T	M	S	G	S	M	g
(iv)	G	S	M	S	G	M	T	M	S	G	S	M	g
(v)	G	S	M	S	G		G	S	M	T	M	S	g

Lemma 16.1 (with the roles of 1,2 and 3,4 interchanged) applies to each of configurations (i),(ii), and (v), giving a contradiction to Lemma 8.15. (Notice that

the T in line (v) is an SC.) For (iv), Lemma 17.1 implies that a neighborhood of the $\overline{41}$ -edges of the MSGSM subconfiguration is a 1-punctured torus, and hence that the $\overline{23}$ -edges of the (23)-Scharlemann cycle (bigon and trigon) lie in a 1-punctured torus. This contradicts Lemma 16.15. To eliminate (iii), consider the two (12)-SCs, S_1, S_2 , in that configuration. The argument of Lemma 16.16 applied to the sub-configurations S_1MS , SM , and S_2 (with labels 1, 2, 3, 4 relabelled 3, 4, 1, 2), shows that S_1, S_2 are parallel bigons. Thus we can think of the sub-configurations S_1M, S_2T together as one FESC. That is, applying the argument of Lemma 15.13 to these faces and the (41),(23)-SCs of (iii) shows that three Möbius bands A_{41}, A_{23}, A_{12} corresponding to these Scharlemann cycle faces can be perturbed to be disjoint. But Lemma 8.11 contradicts that M does not contain a Dyck's surface. We have eliminated configurations (i)-(v), and line (2) does not occur.

In line (3), by symmetry we may assume the second g (just to the left of the first blank) is actually T and the other g are all G . Then Lemma 15.6 implies that the first blank is an S and the contiguous FESC is of type I. Applying Lemma 15.10 to this FESC and the mixed bigon in the remaining SMS configuration contradicts Lemma 8.15.

In line (4) we examine where the T may go. It cannot be either of the first two gaps (at the (41)-corners) by Lemma 15.5. So without loss of generality assume the trigon is the third gap (at the (34)-corner). Now we have two cases according to whether the bigon between the trigon and fourth gap is M or S .

If it is M , then to the left of the trigon there must also be an M . Otherwise we must have $MSTM$ contradicting Lemma 15.2. Thus around the trigon we have $SMTM$. But now the SCs of the SMS provide a configuration contrary to Lemma 16.15 (where the (34)-corners and $\overline{12}$ -edges play the role of the (23)-corners and $\overline{41}$ -edges of the Lemma).

If it is S , then it is a (41)-SC and we can apply Lemma 17.1(4) to conclude we obtain $MSTSGSM$. But then Lemma 15.14 gives a contradiction.

Case III. The vertex x has type [9].

Since there are no MSM and no string of four bigons, there is just one configuration:

1	2	3	4	1	2	3	4	1	2	3	4	
G	S	M	S	G	S	M	S	G	S	M	S	G

This configuration is forbidden by Lemma 16.1 and Lemma 8.15. □

Theorem 13.7. *If $\Delta = 3$, then a special vertex x of Λ must contain a triple of bigons.*

Proof. Assume there is no BBB at x . Then there can be neither ggg nor $gg+gg$ at x , or else there would be a BBB at x .

Without loss of generality we may assume a (41)-corner of x has a G , a true gap. We will use this G to mark the beginning and end of the sequence of faces around x as follows:

1	2	3	4	1	2	3	4	1	2	3	4	
G												G

The light grey G at the end is a repeat of the initial G .

Case I. The vertex has type [7, 4] and there exists TT .

We enumerate the possibilities for the placement of this pair up to symmetry:

	1	2	3	4	1	2	3	4	1	2	3	4
(1)	G	T	T									G
(2)	G		T	T								G
(3)	G			T	T							G
(4)	G				T	T						G
(5)	G					T	T					G

In each line two more Ts must be placed with the remaining being Bs. Any placement of these two Ts in lines (1) and (4) contradicts having no BBB. In line (2), having no BBB forces the placement of the remaining two Ts. One application of Lemma 15.5 to the bigons around the central T renders the following:

(2)	G	B	T	T	S	M	T	M	S	T	B	B	G
-----	---	---	---	---	---	---	---	---	---	---	---	---	---

But now a second application of Lemma 15.5 around the rightmost T gives a contradiction.

For line (5), one T must be among the leftmost four spots and the other must be in the middle of the rightmost five. Lemma 15.5 gives the labeling of these rightmost five as SMTMS. Note that this T is a Scharlemann cycle. The two possibilities for the leftmost four are: (i) BBTB and (ii) BTBB. Labeling (i) as MSTB contradicts Lemma 15.6 so it must be labeled as SMTB. But now the SMTM (reading right to left) along with the (12)-SC call upon Lemma 16.15 to contradict that there are two more $\overline{34}$ -edges at x . Hence we must have (ii). Labeling it as BTMS forms MSTTSM which contradicts Lemma 15.8. Thus it must be labeled as BTSM giving us, by Lemma 15.6, the following configuration. Lemma 16.1 (with the roles of labels 1, 2 and 3, 4 interchanged) then gives three parallel edges that provide a contradiction to Lemma 8.15.

(5)	G	S	T	S	M	T	T	S	M	T	M	S	G
-----	---	---	---	---	---	---	---	---	---	---	---	---	---

For line (3) both remaining Ts must be on the right side, and there are three possible placements. The two bigons on the left are either MS or SM.

	1	2	3	4	1	2	3	4	1	2	3	4		
	G	M	S	T	T		T	S	M	T	M	S	G	(i)
	G	M	S	T	T	S	M	T		T	M	S	G	(ii)
(3)	G	M	S	T	T	M	S	T	B		T		G	(iii)
	G	S	M	T	T		T	S	M	T	M	S	G	(iv)
	G	S	M	T	T	S	M	T		T	M	S	G	(v)
	G	S	M	T	T	S	M	T	M	S	T	S	G	(vi)

For lines (i) and (iv), first apply Lemma 15.5 to get the pictured configurations, then note these contradict Lemma 15.6. To get the configuration for line (ii) apply Lemma 15.6. But this line contradicts Lemma 15.8. For line (iii), apply Lemma 15.8 to get the pictured configuration. This now contradicts Lemma 15.6.

For line (v) apply Lemma 15.6 twice to obtain the pictured configuration. Then Lemma 15.2 applied to the TSM adjacent to the leftmost T implies the leftmost T is a Scharlemann cycle. Lemma 14.5 shows that the $\overline{34}$ -edges on either end of the FESC TSM are parallel in G_F . This parallelism allows us to apply the argument of Lemma 16.15 to the subconfiguration SMT on the left-hand side and the middle M

(for the analog of SMTM) along with (34)-SC at the right. But then the five $\overline{12}$ -edges incident to x contradict the conclusion of that argument.

For line (vi), apply Lemma 15.5 and then Lemma 15.6 to obtain the configuration shown. Furthermore, Lemma 15.6 shows that the first T must be a Scharlemann cycle. Lemma 16.1 then gives three parallel edges that provide a contradiction to Lemma 8.15.

Case II. The vertex has type $[7, 4]$ and no TT.

Case IIa. Assume there exists MST.

Lemma 15.9 gives three configurations to consider.

		1	2	3	4	1	2	3	4	1	2	3	4		
(1)	G							B	T	M	S	T	G		
(2)	G							B	T	M	S	T	S	G	
(3)	G							B	T	M	S	T	S	T	G

Line (1) must have either TB or BT to the left of the labeled faces. In the former, since no TT, we then have BTBBTB which is either BTSMTB or BTMSTB. The positions of each of these is incongruous with Lemma 15.6. In the latter, the placement of the fourth T is forced and Lemma 15.5 gives:

G	S	M	T	M	S	T	B	T	M	S	T	G
---	---	---	---	---	---	---	---	---	---	---	---	---

The MSTB here contradicts Lemma 15.6 too.

In line (2), Lemma 15.14 forces the B to be an M. Then Lemmas 15.14 and 15.12 imply that the remaining (23) and (41) corners take the final two Ts. Hence the remaining three corners have bigons. Being adjacent to an M, the center (12) corner takes an S. Lemma 15.6 now gives a contradiction.

In line (3) the placement of the fourth T is forced. Lemma 15.5 then gives a labeling contrary to Lemma 15.6.

Case IIb. There exists no MST.

There must be BB, and it must be between the G and a T. Hence BB must be either GSMT or TMSG. This forces:

	1	2	3	4	1	2	3	4	1	2	3	4	
	G	S	M	T	B	T	B	T	B	T	M	S	G

If the left and the right B are both an S then we have the configuration of Figure 38. Lemma 17.1 shows that no pair of e_1, \dots, e_6 are parallel on G_F . But Lemma 16.4 shows that either there is a parallelism among $e_1, e_4,$ and e_5 or there is a parallelism among $e_2, e_3,$ and e_6 . Hence WLOG the leftmost B is an M.

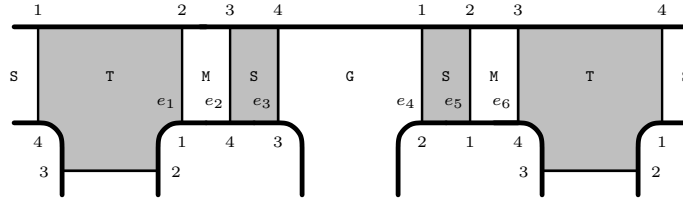

FIGURE 38.

If at least one of the two remaining Bs is an M, then it will provide a fifth $\overline{12}$ -edge incident to x . Then we will have a configuration contrary to Lemma 16.15. If the remaining Bs are each an S, then we may apply Lemma 17.1 to conclude that the $\overline{34}$ -edges lie in a 3-punctured torus on \widehat{F} (since the $\overline{12}$ -edges fill out a 1-punctured torus). This contradicts again Lemma 16.15.

Case III. The vertex has type [8, 1].

There are 8 bigons and 4 gaps. There cannot be gBg since this would imply the existence of BBB. Hence the gaps are equally spaced. Due to symmetry, we may designate any of these gaps to be the T and the others to be Gs. Apply Lemma 15.5 to label the two pairs of bigons around the T. If any of the remaining bigons are (12)-SCs, then the resulting configuration will contradict Lemma 16.15 (with too many $\overline{34}$ -edges). This leaves the configuration shown in Figure 39. The faces f_1, \dots, f_6

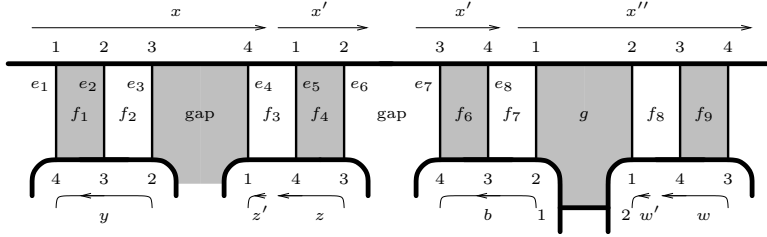

FIGURE 39.

give the configuration and labeling in Figure 75 where f_5 is now a gap and the label a is now x' . The remaining three bigons are labeled f_7, f_8, f_9 and the trigon is labeled g .

Let A_{34} be the Black Möbius band arising from f_6 . Let $A_{12,34}$ be the Black annulus arising from f_1 and f_4 . By Lemma 17.1, A_{34} and $A_{12,34}$ intersect transversely along the (34)-arc of K . The subgraph of G_F arising from their edges is shown in Figure 79. As a neighborhood of this subgraph is a twice punctured torus, Lemma 17.1 (1) implies its complement in \widehat{F} is an annulus $B_{\widehat{F}}$. Furthermore, the (34)-arc of K has a bridge disk otherwise disjoint from $A_{12} \cup A_{12,34}$ that meets this annulus along a single spanning arc. Hence cutting H_B open along $N = N(A_{12} \cup A_{12,34})$ forms a solid torus \mathcal{T} on which $B_{\widehat{F}}$ is a longitudinal annulus.

Since g is a properly embedded disk in \mathcal{T} , and ∂g crosses three times along the impressions of the 1-handle neighborhood of (12), g must be a meridional disk of \mathcal{T} . From this, one can see that two of the edges of g must be parallel into $\partial B_{\widehat{F}}$ and the third runs from one component of $\partial B_{\widehat{F}}$ to the other. In particular, the two edges that are boundary parallel cobound contiguous squares in $G_{\widehat{F}}$ as pictured in Figure 40(b). The labellings of the endpoints of edges e_7, e_8 on vertices 3, 4 force one of e_3 or e_4 to lie in one of these squares in G_F . But this means that either e_3 is parallel to one of e_2, e_6 or e_4 is parallel to one of e_1, e_5 , contradicting Lemma 17.1.

Case IV. The vertex has type [9].

There must be a triple of bigons contrary to hypothesis. \square

14. THRICE-PUNCTURED SPHERES, FORKED EXTENDED SCHARLEMANN CYCLES, AND AN APPLICATION WHEN $t = 4$.

In this section we assume that $t = 4$ and that we are in SITUATION NO SCC.

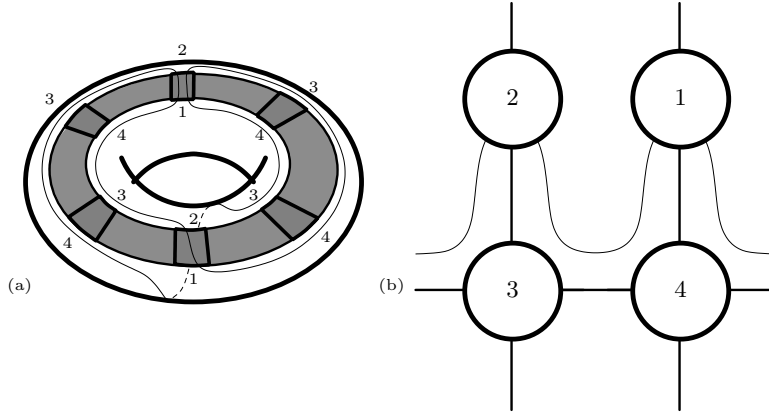

FIGURE 40.

14.1. Thrice-punctured spheres in genus 2 handlebodies. Let P be an incompressible, separating, thrice-punctured sphere in a genus 2 handlebody H . Decompose H along P as $H = M_1 \cup_P M_2$. Since P is an incompressible surface in the handlebody H , it must be ∂ -compressible. Assume P is ∂ -compressible into M_2 . It is easy to see that M_1 and M_2 are genus 2 handlebodies.

Lemma 14.1.

$$M_2 = P \times [0, 1] \cup_{A_1 \cup A_2} \mathcal{T}$$

where P is identified with $P \times \{0\}$, A_1 and A_2 are disjoint, non-isotopic, essential annuli in $P \times \{1\}$, and either

- (1) \mathcal{T} is the union of two solid tori, \mathcal{T}_1 and \mathcal{T}_2 , and $A_i \subset \partial\mathcal{T}_i$ is incompressible for each $i = 1, 2$; or,
- (2) \mathcal{T} is a solid torus and $A_1 \cup A_2 \subset \partial\mathcal{T}$ is incompressible.

In either case, if A_i is not longitudinal in \mathcal{T} (\mathcal{T}_i), then the component c_i of ∂P that is isotopic (through $P \times [0, 1]$) to the core of A_i is primitive in M_1 .

Proof. Let δ be a ∂ -compressing disk for P in M_2 . The ∂ -compression of P along δ yields A , an incompressible annulus or pair of annuli. Cutting M_2 along δ yields \mathcal{T} , either one or two solid tori, with $A \subset \partial\mathcal{T}$. In the case that A is a single annulus, then \mathcal{T} is a single solid torus. Reversing the compression along δ , we see $M_2 = P \times [0, 1] \cup_A \mathcal{T}$. To get description (1) above, set $\mathcal{T}_1 = \mathcal{T}$, $A_1 = A$ and pick a second disjoint, essential annulus, $A_2 \subset P \times \{1\}$ along which we attach a solid torus \mathcal{T}_2 longitudinally (giving a trivial decomposition). Otherwise, $A = A_1 \cup A_2$ and reversing the compression along δ gives either (1) or (2).

To prove the final statement, collapse M_2 along $P \times [0, 1]$ to write H as $M_1 \cup_{A_1 \cup A_2} \mathcal{T}$ and let c_i be the core of A_i . A_i must boundary compress in H , but if A_i is not longitudinal in \mathcal{T} such a compression can be taken disjoint from $\text{Int } \mathcal{T}$. This gives a meridian disk in M_1 that marks c_i as primitive in M_1 . \square

14.2. Forked extended Scharlemann cycles. Consider a FESC τ in G_Q . Up to relabelling vertices of G_F and G_Q , we may assume it is as illustrated in Figure 41(a). As shown, label the two Black faces f and g . Also label and orient the two edges α and β . The subgraph of G_F induced by the edges of τ then appears on \hat{F} as

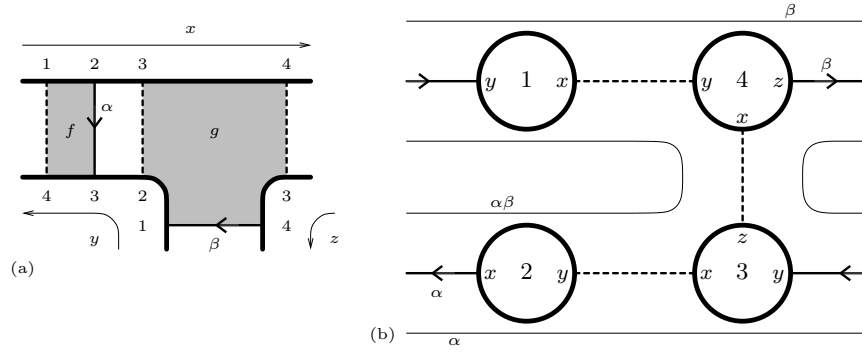

FIGURE 41.

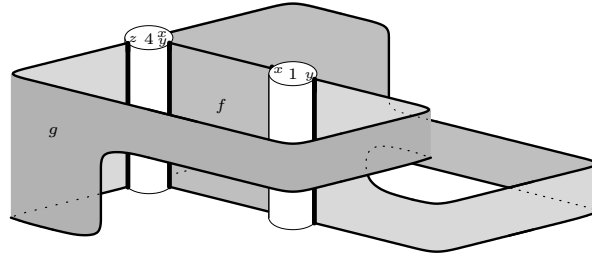

FIGURE 42.

shown in Figure 41(b) or its mirror. We assume in this subsection that we are in SITUATION NO SCC, so that f, g are properly embedded in $H_B - N(K)$. The White SC between f and g gives rise to a Möbius band, A_{23} , properly embedded in H_W .

Contracting the remaining three edges of τ to a point $*$ in this subgraph of G_F , we may view the edges α and β as oriented loops. A neighborhood on \widehat{F} of this subgraph of G_F induced by the edges of τ is a 3-punctured sphere P' . Its boundary components may be identified with the loops α , β , and $\alpha\beta$ based at $*$ also indicated in Figure 41(b). We aim to show that β bounds a disk in \widehat{F} (Lemma 14.5).

Form the genus 2 handlebody $M_1 = N((12) \cup (34) \cup f \cup g) \subset H_B$. Since $\partial M_1 \cap \partial H_B = P'$, $P = \partial M_1 \setminus \partial H_B$ is also a 3-punctured sphere. Thus we may write $\partial M_1 = P \cup_{\{\alpha, \beta, \alpha\beta\}} P'$ and $H_B = M_1 \cup_P M_2$. Figure 41(a) gives instructions for the assembly of M_1 which we may realize embedded in S^3 as in Figure 42 with f and g thickened. Note that one may thus visualize M_1 as the trefoil complement with the neighborhood of an unknotting tunnel removed: $\alpha\beta$ is the cocore of the unknotting tunnel and α and β result from a banding of $\alpha\beta$ to itself. Recall that if O is a 3-manifold with boundary and γ is a curve in ∂O , then $O\langle\gamma\rangle$ is O with a 2-handle attached along γ .

Claim 14.2. *Let $\alpha, \beta, \alpha\beta \subset M_1$ be as above.*

- (1) α and β are primitive in M_1 . Indeed M_1 contains disjoint meridian disks, one intersecting α once and disjoint from β , the other disjoint from α and intersecting β once.
- (2) The arcs $(12), (34)$ of $K \cap M_1$ can be isotoped in M_1 , fixing their endpoints, to arcs on ∂M_1 that are disjoint from α and β and that intersect $\partial A_{23} \subset \partial M_1$

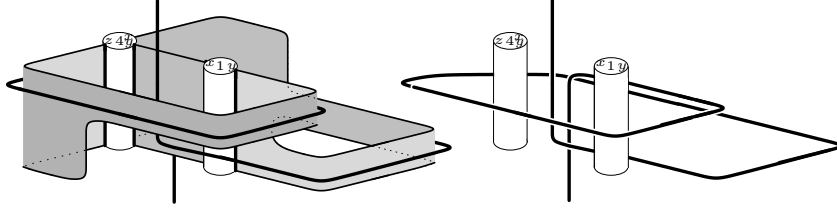

FIGURE 43.

only in their endpoints (at vertices 2, 3 of G_F). Furthermore, these arcs are incident to the same side of ∂A_{23} in ∂M_1 .

- (3) $M_1\langle\alpha\beta\rangle$ is homeomorphic to the exterior of the trefoil. In particular, $\alpha\beta$ is neither primitive nor cabled in ∂M_1 .

Proof. In Figures 41 and 42, α and β encircle the two visible holes of the embedded genus 2 handlebody indicated by Figure 42. Let f, g be the black faces of τ (Figure 41). Let e_1, e_2 be disjoint properly embedded arcs in g parallel to the (34)-corners of g along vertices x, z (resp.) of G_Q . In M_1 , a product neighborhood of e_1 (e_2) is a disk E_1 (E_2) in $g \times I$ such that ∂E_1 (∂E_2) intersects α (β) once but is disjoint from β (α). E_1 and E_2 verify (1).

Let E'_1 be the disk component of $E_1 \setminus e_1$ that is disjoint from α . Band E'_1 to the (34)-corner of g (to which e_1 is parallel) to obtain a bridge disk D_{34} in M_1 for the arc (34) of K . D_{34} is disjoint from both α and β and intersects ∂A_{23} only in vertex 3 of G_F . Band the (12)-corner of f along f to D_{34} to obtain a bridge disk D_{12} of (12) of K in M_1 which is disjoint from D_{34} , α , and β ; and which intersects ∂A_{23} only at vertex 2. D_{12}, D_{34} guide the isotopies of (12), (34) described in (2).

Figure 43 shows that $M_1\langle\alpha\beta\rangle$ is homeomorphic to the exterior of the trefoil. Since this is neither a solid torus nor the connect sum of a solid torus and a lens space, $\alpha\beta$ cannot be primitive or cabled in M_1 . \square

Claim 14.3. P is incompressible in M_1 .

Proof. If P were compressible in M_1 , then either α, β , or $\alpha\beta$ would bound a disk in M_1 . Claim 14.2 shows this cannot be. \square

Claim 14.4. There is no properly embedded disk D in M_1 such that ∂D meets P in a single essential arc.

Proof. Let D be a properly embedded disk in M_1 such that $\partial D \cap P$ is an essential arc in P .

First suppose D separates M_1 , and let D_1, D_2 be meridian disks of the two solid tori $M_1 \setminus D$. Both points of $\partial D \cap \partial P$ belong to the same component of γ of ∂P . The other two components γ_1, γ_2 of ∂P can be numbered so that $\gamma_i \cap \partial D_j = \emptyset, \{i, j\} = \{1, 2\}$. Hence $\{\gamma_1, \gamma_2\} = \{\alpha, \beta\}$ and γ_i intersects D_i in a single point, $i = 1, 2$. But then $\gamma (= \alpha\beta)$ intersects D_1 (and D_2) in a single point, contradicting the fact that $M_1\langle\alpha\beta\rangle$ is the trefoil exterior.

Next suppose D does not separate M_1 . Let D' be a disk in M_1 disjoint from D such that $M_1 \setminus (D \cup D')$ is a 3-ball. If the two points of $\partial D \cap \partial P$ belong to the same component of ∂P , then the other two components are disjoint from D , and hence must be α and β . But then $\alpha \cup \beta$ is disjoint from D , a contradiction. If the

two points of $\partial D \cap \partial P$ belong to different components of ∂P , then each of these components intersects D once, and hence they are α and β , so the third component must be $\alpha\beta$. But this component is disjoint from D , contradicting the fact that $M_1 \langle \alpha\beta \rangle$ so the trefoil exterior. \square

Lemma 14.5. *Assume we are in SITUATION NO SCC and there is a FESC centered (WLOG) about a (23)-SC. Then the two $\overline{14}$ -edges are parallel in G_F .*

Remark 14.6. We later use this lemma for an FESC put together by an MS and ST pair where the S are parallel bigons (merging the SCs to one to give the faces of the FESC). We will also use this (Lemma 15.6) for an FESC put together by an ST and M where the leftmost edge of the ST is parallel to an edge of M.

Proof. Assume there is a FESC τ , without loss of generality as shown in Figure 41. Construct M_1 from f, g and write $H_B = M_1 \cup_P M_2$ as above. Observe that α is the boundary of the White Möbius band $A_{23} \subset H_W$ arising from the (23)-SC between f and g on G_Q . If P is incompressible in H_B , then by Claim 14.4 it must boundary compress in M_2 and Lemma 14.1 holds. If P compresses in H_B , it must compress in M_2 by Claim 14.3.

Case I: P is incompressible in H_B and (1) of Lemma 14.1 holds.

Then collapsing along $P \times [0, 1]$, we may write $H_B = M_1 \cup_{(A_1 \cup A_2)} (\mathcal{T}_1 \cup \mathcal{T}_2)$. The cores of the annuli must be isotopic to either α, β , or $\alpha\beta$ in P . If the core, c , of either A_1 or A_2 is isotopic to $\alpha\beta$ then, again by Lemma 14.1, c must be longitudinal in \mathcal{T} as $\alpha\beta$ is not primitive in M_1 . Thus if α, β are not the cores of some A_1, A_2 in the original decomposition, then we can replace the trivial decomposition along $\alpha\beta$ with a trivial decomposition along α or β . So we may assume that in P , the core of A_1 is isotopic to α and the core of A_2 to β . By Claim 14.2(1), both α and β are jointly primitive curves in M_1 , and $H'_B = N(A_{23}) \cup_\alpha M_1 \cup_{A_2} \mathcal{T}_2$ is a genus 2 handlebody. Since α is a primitive curve in $H_W \setminus A_{23}$, $H'_W = (H_W \setminus A_{23}) \cup_\alpha \mathcal{T}_1$ is also a genus 2 handlebody. Together H'_B and H'_W form a new genus 2 Heegaard splitting for M .

Since (41) has a bridge disk D_{41} in H_W that is disjoint from A_{23} (Lemma 8.16), it continues to be bridge in $H_W \setminus A_{23}$. Moreover since D_{41} may be taken to be disjoint from α , D_{41} is a bridge disk for (41) in H'_W . By Claim 14.2, arcs (12),(34) can be isotoped to $\partial H'_B$, fixing their endpoints, so they intersect ∂A_{23} only at vertices 2, 3 (resp.) of G_F and are incident to the same side of ∂A_{23} (the isotopy in M_1 is disjoint from α, β). Now we can write K as the union of two arcs (3412) that is a bridge arc of H'_W and (23) which is a bridge arc of H'_B : After isotoping (34),(12) to $\partial H'_B$, the arc (3412) is isotopic as a properly embedded arc in $\partial H'_W$ to (41) — which is bridge in H'_W . On the other hand, (23) can be isotoped as a properly embedded arc in H'_B to be a cocore of the annulus $N(A_{23}) \cap \partial H_B$. The primitivity of this annulus in H_B now describes (23) as a bridge arc in H'_B . That is, K is 1-bridge with respect to the splitting $H'_W \cup H'_B$. This contradicts that $t = 4$.

Remark 14.7. If A_1 is longitudinal in \mathcal{T}_1 then ∂A_{23} will be primitive in H_B and the new splitting is gotten from the old by adding/removing a primitive Möbius band (in this case, adding \mathcal{T}_1 to H_W is isotopic to the splitting where \mathcal{T}_1 is not added). This is consistent with the proof of Theorem 2.6. If A_1 is not longitudinal in \mathcal{T}_1 then M is a Seifert fiber space over the 2-sphere with an exceptional fiber of order 2. In this case, we could find a vertical splitting with respect to which K has

bridge number 0 by applying Lemma 8.3 to $\mathcal{T}_1 \cup_\alpha A_{23}$, a Seifert fiber space over the disk. This would then be consistent with the proof of Theorem 2.6.

Case II: P is incompressible in H_B and (2) of Lemma 14.1 holds.

Collapsing along $P \times [0, 1]$, we view H_B as $M_1 \cup_{A_1 \cup A_2} \mathcal{T}$. Then the cores of A_1, A_2 must be α, β in M_1 . This follows from Lemma 14.1 when A_1 (hence A_2 as well) is not longitudinal in \mathcal{T} , since $\alpha\beta$ is not primitive in M_1 . When A_1, A_2 are longitudinal on \mathcal{T} , assume for contradiction that the core of A_1 is $\alpha\beta$. As $A_1 \cup A_2$ must be ∂ -compressible in H_B , and $\alpha\beta$ is not primitive in M_1 , it must be that there is a meridian disk for M_1 that is disjoint from A_1 and crossing the core of A_2 once. But then we obtain the contradiction that the trefoil knot exterior, $M_1 \langle \alpha\beta \rangle$, has compressible boundary.

So we may assume the core of A_1 is α and the core of A_2 is β in M_1 .

First consider the case where A_1 runs $n > 1$ times longitudinally around \mathcal{T} . There is an annulus B contained in ∂M_1 which we may assume contains ∂A_{23} and A_1 and that intersects K only at vertices 2, 3 of G_F (i.e. only along ∂A_{23}). Let \mathcal{N} be $N(B \cup A_{23} \cup \mathcal{T})$. Then \mathcal{N} is a Seifert-fibered space over the disk with two exceptional fibers. Furthermore, $K \cap \mathcal{N}$ lies as a co-core of the Möbius band A_{23} properly embedded in \mathcal{N} . Lemma 8.3 then gives a genus 2 splitting of M in which K is 0-bridge, a contradiction.

Finally consider the case where A_1, A_2 are longitudinal in \mathcal{T} . By Claim 14.2, there are disjoint meridian disks D_1, D_2 of M_1 such that D_i intersects the core of A_i once and is disjoint from A_j where $\{i, j\} = \{1, 2\}$. Then there is a disk D_3 in \mathcal{T} such that $D = D_1 \cup D_2 \cup D_3$ forms a meridian disk in H_B that intersects each of α and β once. In particular, α is primitive in H_B . Then $H'_B = H_B \cup N(A_{23})$ is a genus 2 handlebody. Also $H'_W = H_W - N(A_{23})$ is a genus 2 handlebody. Hence $H'_B \cup H'_W$ is a genus 2 Heegaard splitting of M . We now show that K has bridge number one with respect to this splitting, thereby contradicting the assumption that $t = 4$. By Claim 14.2, arcs (12), (34) can be isotoped to ∂H_B so they intersect ∂A_{23} only at vertices 2, 3 (resp.) of G_F and are incident to the same side of ∂A_{23} (the isotopy in M_1 is disjoint from α, β). Now we can write K as the union of two arcs, (3412) that is a bridge arc of H'_W and (23) which is a bridge arc of H'_B : After isotoping (34), (12) to ∂H_B , the arc (3412) is isotopic as a properly embedded arc in $\partial H'_W$ to (41) — which is bridge in H'_W (Lemma 8.16). On the other hand, (23) can be isotoped as a properly embedded arc in H'_B to be a cocore of the annulus $N(A_{23}) \cap H_B$. The primitivity of this annulus in H_B now describes (23) as a bridge arc in H'_B . That is, K is 1-bridge with respect to the splitting $H'_W \cup H'_B$.

Case III: P is compressible.

Because P is not compressible into M_1 by Claim 14.3, some component of ∂P bounds a disk D in M_2 . The following then proves the lemma in this case.

Claim 14.8. *Assume there is a disk D properly embedded in H_B disjoint from M_1 and with ∂D isotopic to α, β or $\alpha\beta$ in ∂H_B . Then ∂D must in fact be isotopic to β , and β must bound a disk in ∂H_B .*

Proof. If ∂D were isotopic to α , then $D \cup A_{23}$ forms an $\mathbb{R}P^2$; this is a contradiction. If ∂D were $\alpha\beta$, then $N(D) \cup_{\alpha\beta} M_1 = M_1 \langle \alpha\beta \rangle$ is a trefoil complement embedded in H_B (Claim 14.2). Thus $M_1 \langle \alpha\beta \rangle$ must be contained in a 3-ball. By Lemma 3.3, α bounds a disk in H_B or H_W which, as above, cannot occur. Thus ∂D is isotopic to β .

Now assume β , hence ∂D , is essential in ∂H_B . Let \mathcal{O} be the solid torus component of $H_B - N(D)$ containing M_1 . Let \mathcal{N} be $\mathcal{O} \cup N(A_{23})$. Using D , we may extend the isotopy from Claim 14.2(b) of arcs (12),(34), fixing their endpoints, to $\partial \mathcal{O}$ so that the resulting arcs a, b are incident ∂A_{23} only at their endpoints and on the same side of ∂A_{23} (alternatively, Lemma 14.9 constructs such an isotopy). Thus K can be written as the union of two arcs: (34123), μ . Arc (34123) is the union of the arcs a, b on $\partial \mathcal{O}$, the arc (41) of $K \cap H_W$, and an arc on $\partial N(A_{23}) - \mathcal{O}$ (a cocore of this annulus) running from vertex 2 to vertex 3. The arc μ is a cocore of the annulus $B = N(A_{23}) \cap \partial \mathcal{O}$ on \widehat{F} . Note that (34123) is the union of the (41)-arc of K with two arcs on $\partial \mathcal{N}$. Pushing (34123) slightly into the exterior of \mathcal{N} , we have $K \cap \mathcal{N} = \mu$.

B winds $n > 0$ times around \mathcal{O} . First assume $n > 1$. Then \mathcal{N} is a Seifert fiber space over the disk with two exceptional fibers. Furthermore, $\mu = K \cap \mathcal{N}$ is a co-core of the annulus $B \subset \mathcal{N}$, where B is vertical under the Seifert fibration. Lemma 8.3 applies to give a new genus 2 Heegaard splitting of M in which K is 0-bridge, contradicting that $t = 4$.

So assume $n = 1$. Then ∂A_{23} is primitive in H_B . So $H'_B = H_B \cup N(A_{23})$ is a genus two handlebody, as is its exterior $H'_W = H_W - N(A_{23})$. Then $K \cap H'_W = (34123)$ is properly isotopic to the bridge arc (41) of H'_W , hence is bridge in H'_W . $K \cap H'_B = \mu$ is properly isotopic to a cocore of B whose core is primitive in H_B . Thus μ is a bridge arc in H'_B . That is, K is 1-bridge in the Heegaard splitting $H'_B \cup H'_W$, contradicting that $t = 4$. \square

This completes the proof of Lemma 14.5. \square

Lemma 14.9. *Assume SITUATION NO SCC and that there is a FESC centered, WLOG, about a (23)-SC, f . There are bridge disks D_{12} and D_{34} disjoint from the edges of the (23)-SC. These bridge disks guide isotopies of the arcs (12),(34), fixing endpoints, onto arcs of \widehat{F} that are incident to the same side in \widehat{F} of the curve formed by the edges of this SC. Let A_{23} be the Möbius band associated to f . If ∂A_{23} is primitive in H_B , then K is 1-bridge with respect to a genus two Heegaard splitting of M .*

Proof. WLOG we may assume there is a FESC τ as shown in Figure 41(a). Its edges induce the subgraph of G_F shown in Figure 41(b).

Let E be a disk giving the parallelism guaranteed by Lemma 14.5. Let ρ_{12} and ρ_{34} be rectangles on $\partial N((12))$ and $\partial N((34))$ respectively that are between f and g and meet E . Then together $f \cup g \cup E \cup \rho_{12} \cup \rho_{34}$ form a bridge disk D_{34} for (34) as shown in Figure 44(a) that meets \widehat{F} as shown in Figure 44(b).

Let $\rho_{34'}$ be a rectangle on $\partial N((34))$ between the x corner of g and y corner of f and containing the z corner of g . Banding D_{34} to (12) with the rectangle $\rho'_{34} \cup f$ produces the bridge disk $D_{12} = D_{34} \cup \rho'_{34} \cup f$ shown in Figure 45(a) which may be made embedded and disjoint from D_{34} by a slight perturbation. Figure 45(b) shows how D_{12} and D_{34} meet \widehat{F} . In particular, they are incident to the same side of ∂A_{23} .

Now assume ∂A_{23} is primitive in H_B . So $H'_B = H_B \cup N(A_{23})$ is a genus 2 handlebody, as is its exterior $H'_W = H_W - N(A_{23})$. Now argue as in the last paragraph of Claim 14.8. That is, $K \cap H'_W = (34123)$ is properly isotopic to the bridge arc (41) of H'_W , hence is bridge in H'_W . $K \cap H'_B = \mu$ is properly isotopic

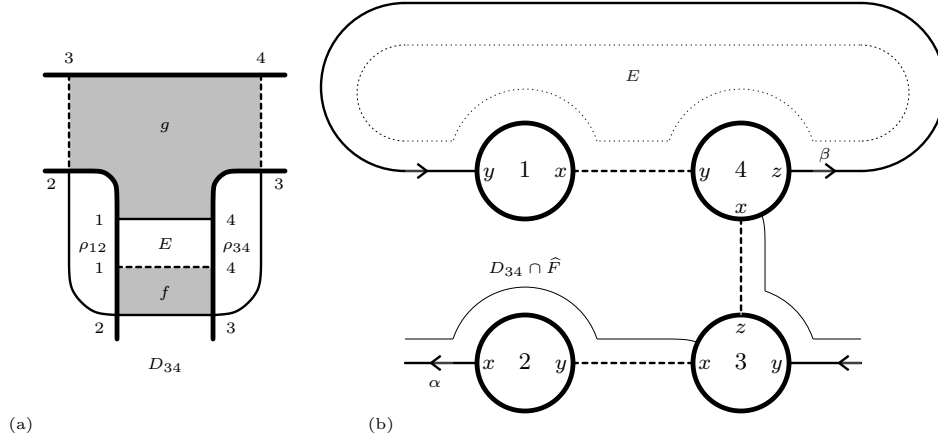

FIGURE 44.

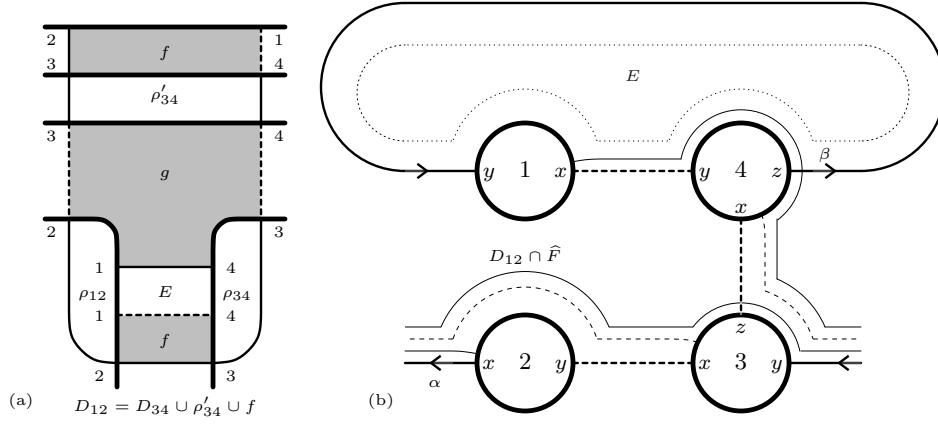

FIGURE 45.

to a cocore of the annulus B , a neighborhood in \widehat{F} of ∂A_{23} . As ∂A_{23} is primitive in H_B , μ is a bridge arc in H'_B . That is, K is 1-bridge in the Heegaard splitting $H'_B \cup H'_W$, contradicting that $t = 4$. \square

15. FESCs

Throughout this section assume $t = 4$, there are no Dyck's surfaces embedded in M , and we are in SITUATION NO SCC.

15.1. Type I and II FESCs.

Definition 15.1. By Lemma 14.5 two of the edges bounding a FESC are parallel on G_F . A FESC along a vertex x of G_Q is *type I* or *type II* (at x) according to whether both or just one of these parallel edges are incident to the vertex. See Figure 46 for an illustration of types I and II at the vertex x .

The boldface notation in the lemmas of this section refers to that of section 13.

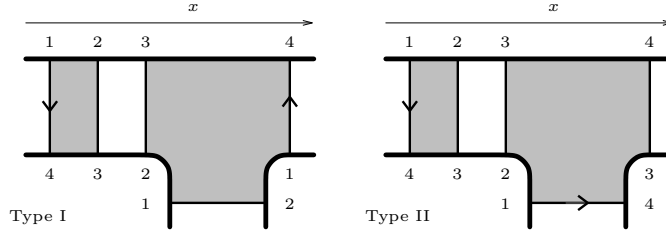

FIGURE 46.

Lemma 15.2. $MST_{II} \implies MSTG$

At a vertex x , the trigon of a type II FESC cannot be further adjacent to another bigon or a trigon. In particular, a type II FESC must have its trigon adjacent to a true gap at x .

Proof. Assume there is a type II FESC adjacent to another bigon or trigon. In the case of a bigon we construct a long disk³ as in Figure 47. In the case of a trigon we construct a lopsided bigon⁴ as in Figure 48. Hence in both cases there is a thinning of K .

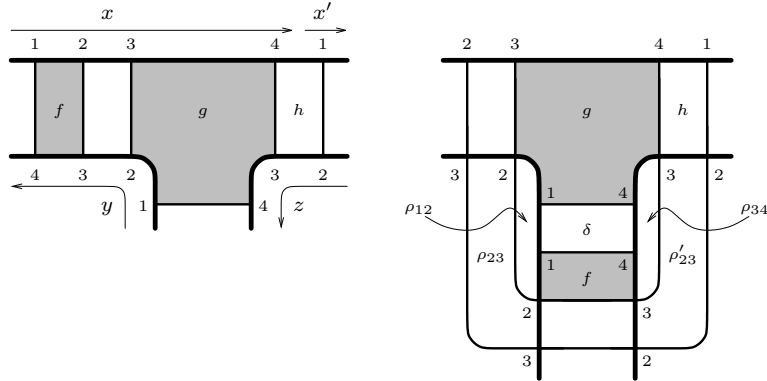

FIGURE 47.

In these figures δ is the disk of parallelism guaranteed by Lemma 14.5, and ρ_{ab} denotes a rectangle on the boundary of the (ab) handle. Note that ρ_{23} and ρ'_{23} have disjoint interiors.

The long disk may be taken to lie on the boundary of the neighborhood of the 2-complex formed from the four faces and K as they are embed in M . The lopsided bigon will be embedded except at its short $(a + 1)$ -corner; nevertheless, the lopsided bigon guides an isotopy of K . Both the long disk and the lopsided bigon run over both sides of the (23)-SC.

To verify these isotopies explicitly, one may construct models of these 2-complexes, their neighborhoods and their intersections with \widehat{F} . As the case when the adjoining face, h , is a trigon can be viewed as a “splintering” of the case when h is a bigon, we begin with the model of the bigon case.

³See also Lemma 2.2 [1].

⁴See also the last two paragraphs of the of Lemma 6.15 [1].

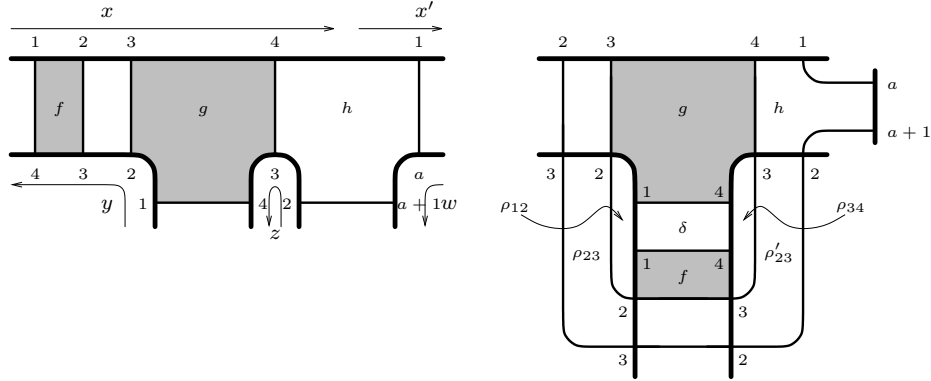

FIGURE 48.

The long disk. Form a Möbius band out of the (23) -SC and the (23) -arc of K . Complete K and take a small regular neighborhood. The attachment of f is unique. The attachment of g is unique up to a choice of placement of its (34) -corner opposite the $\overline{23}$ -edge. These two choices give mirror images and are thus equivalent up to homeomorphism. The boundary of δ is now set and we may attach it. The bigon h may now also be attached along the $\overline{34}$ -edge of g in a unique manner. Beginning from the corners of δ , the choices for ρ_{12} , ρ_{23} , ρ_{34} , and ρ'_{23} are determined. One may now “wrap” the long disk around this complex to exhibit an isotopy of (2341) onto \widehat{F} . The graph on \widehat{F} induced by the edges of these faces and the arc onto which the isotopy lays down (2341) is shown in Figure 49. Since K is isotopic to the arc (12) and an arc on \widehat{F} , it is at most 1-bridge.

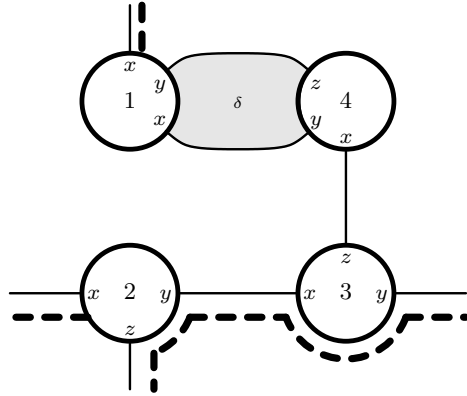

FIGURE 49.

Remark 15.3. The long disk can also be pictured as the union of the bridge disk D_{34} of Lemma 14.9 and a White bigon on corners $(23),(41)$ gotten by banding h and two disjoint copies of the (23) -SC along the boundary of a neighborhood of the (23) -arc of K . This white bigon and D_{34} agree on F along one edge of the bigon.

The lopsided bigon. Take the above constructed complex and break the $\overline{12}$ -edge of h by inserting a corner, thereby changing h from a bigon into a trigon. This

new corner will be either a (23)- or a (41)-corner. To complete this model, this corner must be attached to K . The long disk isotopy now becomes an isotopy of (2341) onto two arcs of \widehat{F} and either the (23)- or (41)-arc of K . There are seven possible ways of hooking up this new corner to its position on the complex: three for (23) and four for (41). When the new corner is a (23)-corner, Figure 50 shows the three possible graphs on \widehat{F} and the resulting two arcs on \widehat{F} after the isotopy of (2341). Figure 51 shows four possibilities when the new corner is a (41)-corner. Note that $\overline{41}$ -edge of h cannot lie in δ by Lemma 8.15. Since K is isotopic to the union of arc (12), two arcs on \widehat{F} , and one of the arcs (23) or (41), it is at most 1-bridge.

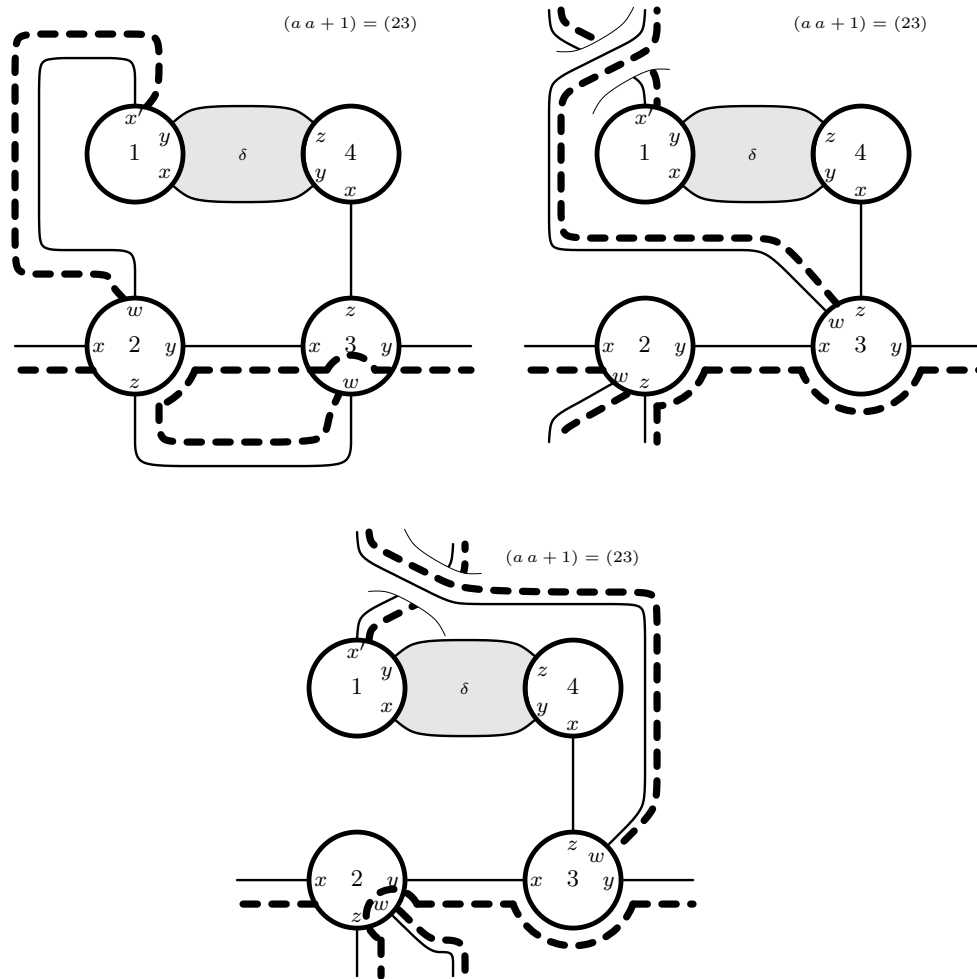

FIGURE 50.

Remark 15.4. As in the remark above for the long disk, the lopsided bigon can be pictured as the union of the Black bridge disk D_{34} with a new White trigon gotten by banding h and two copies of the (23)-SC. The new trigon has the property that it matches the bridge disk along one of its edges (and disjoint elsewhere).

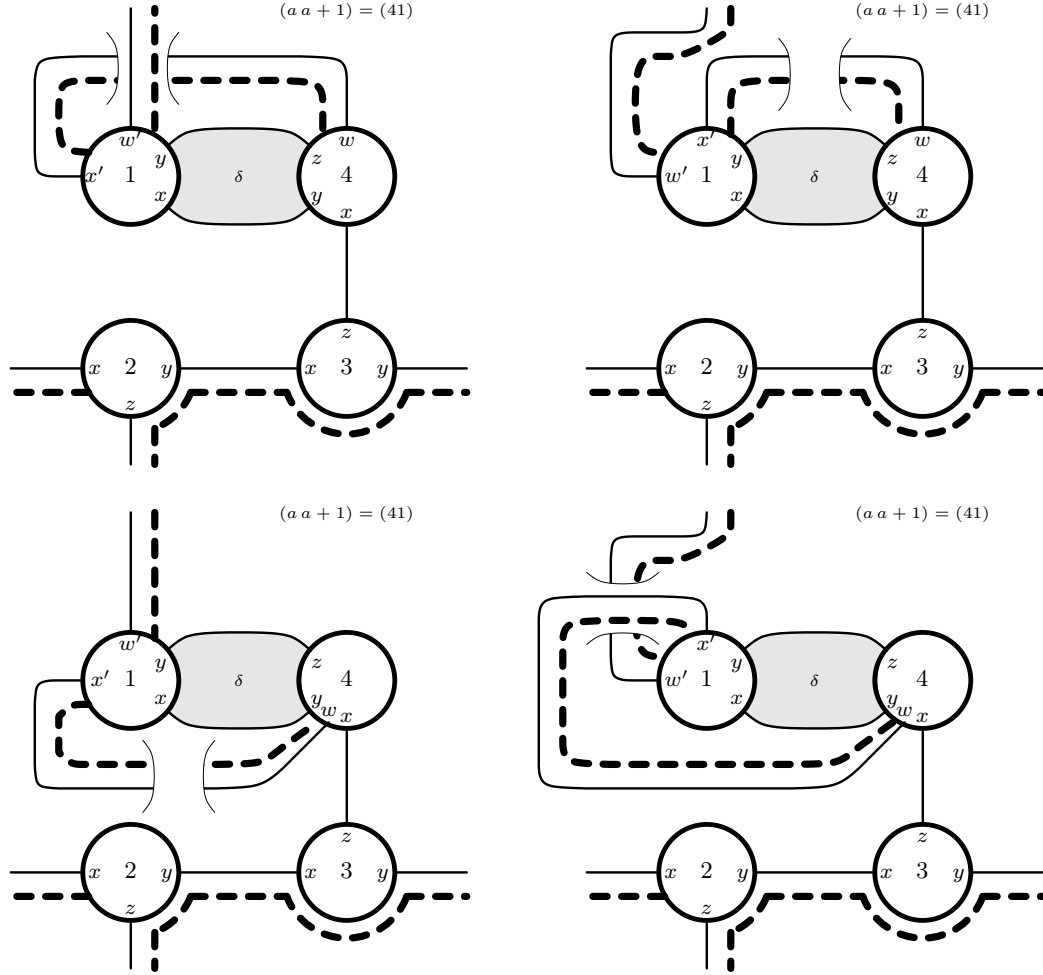

FIGURE 51.

□

Lemma 15.5. $\text{BBTBB} \implies \text{SMTMS}$. *In particular, the T is a Scharlemann cycle.*

Proof. If the T were a Scharlemann cycle, then the desired conclusion would follow, so assume otherwise. By Lemma 15.2, if one of the B adjacent to the T is an S, then the other is too. Hence we assume we have MSTSM as shown, WLOG, in Figure 52(a). By Lemma 14.5, the $\overline{41}$ -edges of f_1 and g are parallel as are the $\overline{23}$ -edges of f_4 and g . Using these parallelisms we may form the annulus $f_1 \cup f_2 \cup f_3 \cup f_4$ shown in Figure 52(b). Since the two boundary components of this annulus each run along K once in opposite directions, joining them along K forms an embedded Klein bottle. This is a contradiction. □

Lemma 15.6. $\text{MSTB} \implies \text{MSTSG}$ or MSTSTG .

Proof. Given MSTB at a vertex, $B = S$ since otherwise MST would form a type II FESC giving a contradiction to Lemma 15.2. We cannot have MSTSB since this

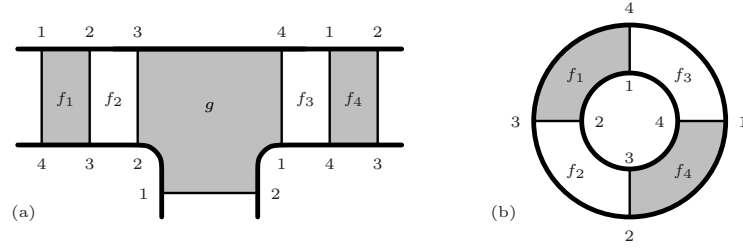

FIGURE 52.

contradicts Lemma 15.5. Thus we have either MSTSG or MSTST. We continue to examine the latter.

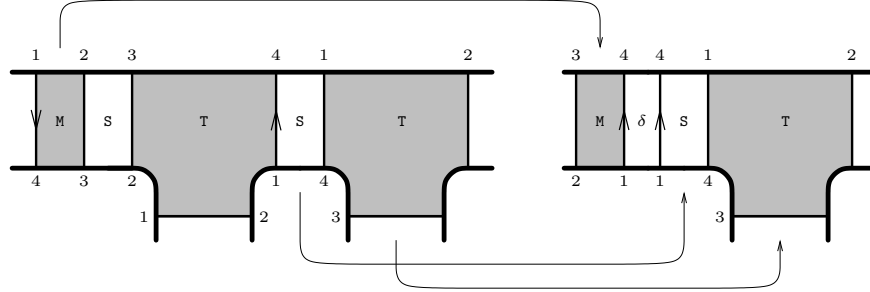

FIGURE 53.

Since the initial MST forms a type I FESC, we have a parallelism δ on G_F between the leftmost edge of the M and the rightmost edge of the T. We may use this to attach the M to the S of the subsequent ST to form a FESC. This is illustrated in Figure 53 (without loss of generality we may use the labeling shown). By the proof of Lemma 14.5 (see the remark there) there is a parallelism δ' of the $\overline{23}$ -edge of the M to a $\overline{23}$ -edge of the T. Lemma 8.15 forces this $\overline{23}$ -edge of T to not be incident to the vertex and thus the unlabeled corner in Figure 53 is a (12) -corner. Following the proof of Lemma 15.2 we may build either a long disk or lopsided bigon as shown in Figure 54. (Note that the regions ρ_{341} and ρ_{412} in $\partial N(K)$ must be as in Figure 55(a) and not (b). The corner x is labeled in each; in (b) two continue into δ' contrary to Lemma 8.15.) Therefore there cannot be a bigon or trigon incident to the $\overline{12}$ -edge of this T. Hence if we have MSTST, we then have MSTSTG.

Remark 15.7. From the point of view of the remarks in the proof of Lemma 15.2, the White bigon or trigon constructed is the same as there, the difference is in the construction of the Black bridge disk where the parallelism (here given by δ) is used to modify the bridge disk on the Black side to line up with the White bigon, trigon along an edge.

□

Lemma 15.8. MSTTSM cannot occur.

Proof. Either MST or TSM must be a type II FESC. Since the trigon is not adjacent to a gap, this is forbidden by Lemma 15.2. □

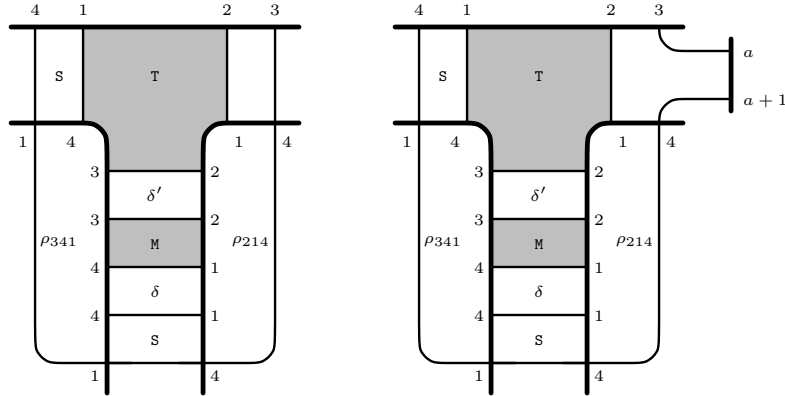

FIGURE 54.

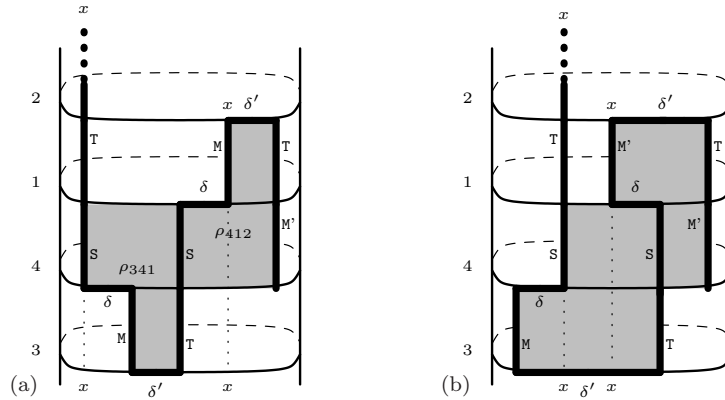

FIGURE 55.

Lemma 15.9. *At a vertex of type $[7, 4]$, if no TT and no BBB then $MST \implies$*

$$BTMST \left\{ \begin{array}{l} G \\ SG \\ STG \end{array} \right\}.$$

Proof. First consider the faces to the right of MST. Since no TT, we must have either MSTG or MSTB. For the latter, Lemma 15.6 gives MSTSG or MSTSTG. Now since there is only one true gap at this vertex and having no TT and no BBB implies BT must be to the left of MST. \square

15.2. More with FESC: Configurations SMST and MSTs.

Lemma 15.10. *Assume there is an SMST configuration incident to vertex x for which the MST is a type I FESC. WLOG assume the bigon Scharlemann cycles of this configuration are on the White side. Then any Black mixed bigon, f , must have an edge that is parallel on G_F to an edge in the MST subconfiguration (the FESC). Furthermore, if that edge is parallel to an edge of the M in the MST, then f is parallel to the M. In particular, there is at most one more Black mixed bigon incident to x , other than f and that in the given FESC.*

Proof. WLOG we assume the configuration SMST and f on G_Q are as in Figure 56.

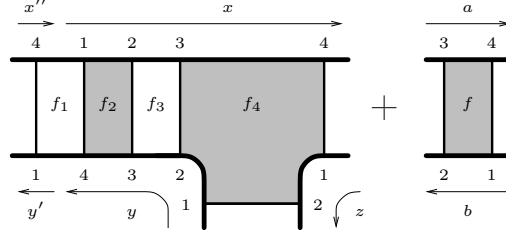

FIGURE 56.

Let A_{23}, A_{41} be the Möbius bands in H_W gotten from the bigon Scharlemann cycles of the SMST configuration. By Lemma 14.9, ∂A_{23} cannot be primitive in H_B . A similar argument shows that ∂A_{41} cannot be primitive: Otherwise consider the new genus two Heegaard splitting gotten by attaching $N(A_{41})$ to H_B . Then constructing the right bridge disks Δ_{12} and Δ_{34} as in Lemma 14.9 (see the left or right of Figure 57, ignoring the $\overline{23}$ -edge with a, b endpoints and setting $a = x'', b = y'$ on vertices 4 and 1), one sees that the (12)-arc and (34)-arc of K can be isotoped (rel endpoints) to arcs on \widehat{F} that are incident to ∂A_{41} on the same side (and otherwise disjoint from it). We then get a 1-bridge presentation of K with respect to the new splitting by isotoping it to a (12341)-arc and an arc which is a cocore of $N(\partial A_{41})$ — a contradiction.

We assume for contradiction that neither edge of f is parallel on G_F to an edge of f_2, f_3, f_4 . Applying Lemma 14.5 to the FESC, the edges of f and of the FESC must appear on G_F as in one of the two configurations of Figure 57.

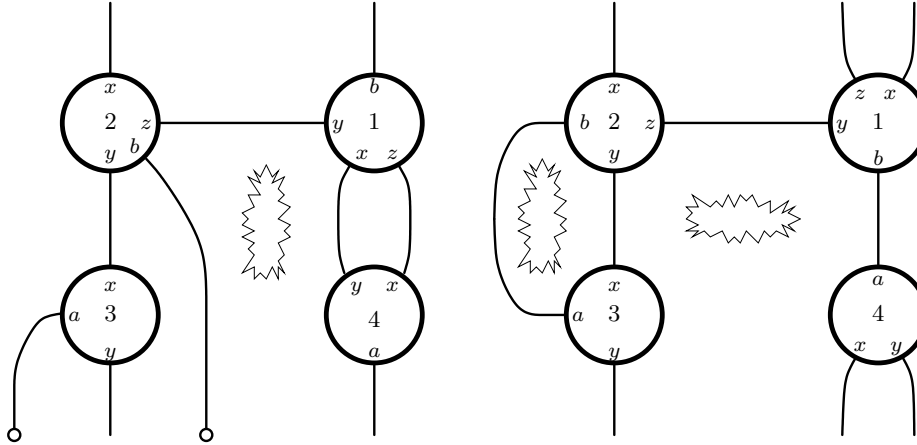

FIGURE 57.

Let $A_{12,34}$ be the annulus gotten from the union of f_2 and f . Since no two of the edges of these faces are parallel on G_F , each component of $\partial A_{12,34}$ is essential in \widehat{F} . Furthermore, $A_{12,34}$ must be incompressible in H_B , otherwise we get a Black disk that either makes ∂A_{23} primitive in H_B or compresses \widehat{F} to induce the formation of a Klein bottle in M from A_{23}, A_{41} .

As in the proof of Lemma 14.9, we construct a thinning disk Δ_{12} from f_2, f_4 . ∂ -compressing $A_{12,34}$ along Δ_{12} , we get a Black disk, D , with the boundary as in Figure 58. In Case (A) of that figure, ∂D intersects ∂A_{23} once, implying that ∂A_{23} is primitive.

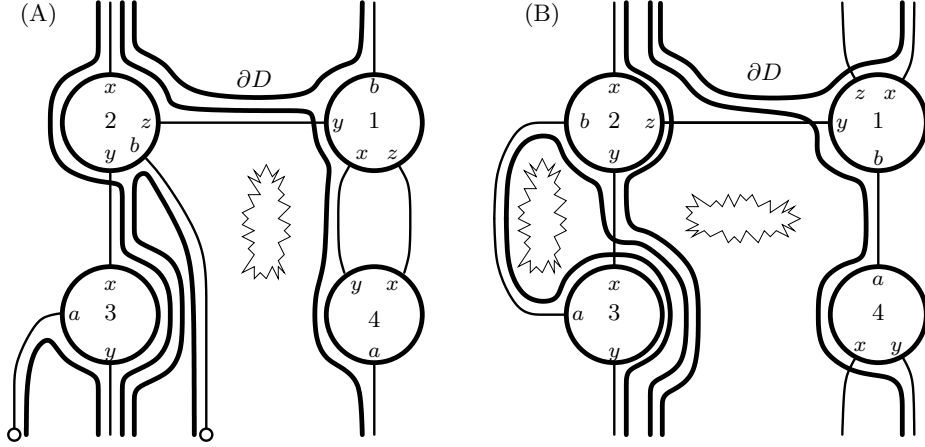

FIGURE 58.

Thus we assume we are in Case (B), where ∂D intersects ∂A_{23} algebraically zero times and geometrically twice. If D is non-separating, then we can construct a Dyck's surface in M by attaching to A_{23} the once-punctured torus or Klein bottle in H_B pictured in Figure 59.

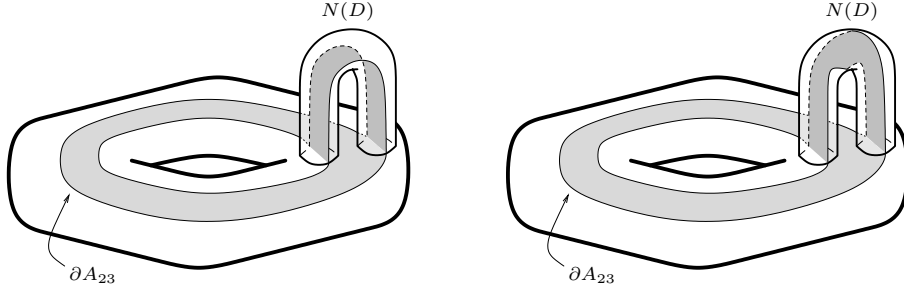

FIGURE 59.

Thus we may assume D is separating in H_B . As D is homologous to $A_{12,34}$, this annulus must be separating in H_B . Let B be the annulus bounded by $\partial A_{12,34}$ on \widehat{F} . Note that ∂D is not trivial in \widehat{F} , for if so an edge of f would be parallel on G_F to one of the edges of f_2 or f_3 contrary to assumption. Thus $A_{12,34}$ is an incompressible, separating annulus in H_B . Note that if $A_{12,34}$ is parallel to ∂H_B , then each component of $\partial A_{12,34}$ is primitive in H_B . Let P be the 4-punctured sphere that is the union in \widehat{F} of the edges of f, f_2, f_3, f_4 , the fat vertices of G_F , and the disk of parallelism on G_F between the $\overline{4\Gamma}$ -edges of f_2 and f_4 . Then the closure of $\widehat{F} - P$ is two annuli, one of which is B . Call the other B' . See Figure 60.

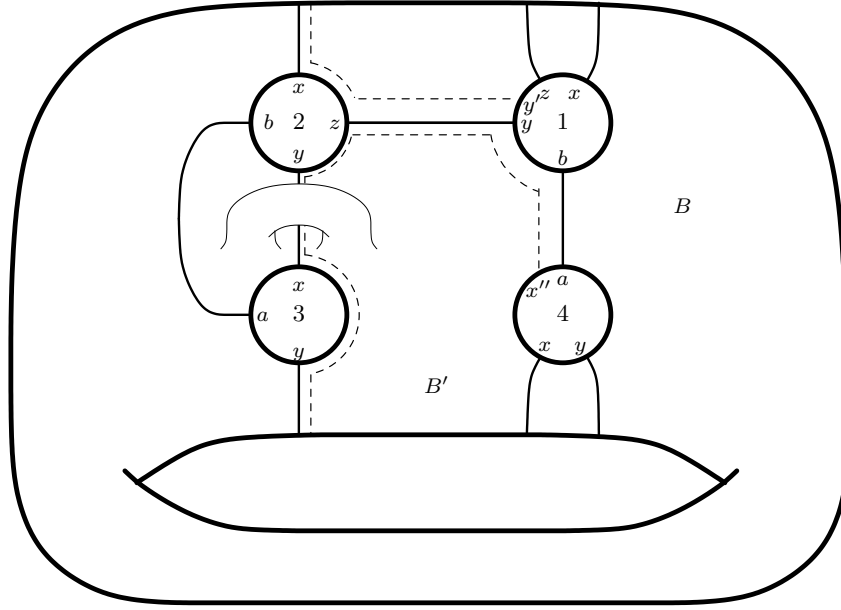

FIGURE 60.

Claim 15.11. *Let e be the $\overline{41}$ -edge that f_1 does not share with f_2 . Then e on G_F is either (i) the dotted line in Figure 60, or (ii) parallel to the $\overline{41}$ -edge of f .*

Proof. If e lies in B on G_F then it is isotopic into ∂B and hence is parallel to either the $\overline{41}$ -edge of f_2 or f . The former cannot occur else M has a lens space summand, the latter is conclusion (ii). If e lies in B' then it is isotopic into $\partial B'$ and hence either is parallel to the $\overline{41}$ -edge of f yielding conclusion (ii), is parallel to the $\overline{41}$ -edge of f_2 (a contradiction as above), is parallel to the dotted edge in Figure 60 yielding conclusion (i), or is such that ∂A_{41} would be isotopic on \widehat{F} to ∂A_{23} giving a Klein bottle in M . \square

Assume e is as in (i) of the Claim. Then A_{41} , $A_{12,34}$ and D can be perturbed to be disjoint with boundaries as indicated in Figure 61 (by forming these with the given faces and the appropriate rectangles along $\partial N(K)$). D divides H_B into two solid tori $\mathcal{T} \cup \mathcal{T}'$ where $\partial \mathcal{T}$ contains ∂A_{41} . Since ∂A_{41} is not primitive in H_B , it is not longitudinal in \mathcal{T} . Let $\mathcal{N} = \mathcal{T} \cup N(A_{41})$. Then \mathcal{N} is a Seifert fiber space over the disk with two exceptional fibers. A close look at Figure 61 shows that we can perturb K so that $K \cap \mathcal{N}$ is a single arc, η , (basically the (41) -arc) which is isotopic to the cocore of the Möbius band A_{41} . Lemma 8.3 now produces a genus 2 Heegaard splitting of M in which K is 0-bridge, a contradiction.

So assume e is as in conclusion (ii) of the Claim. As ∂A_{41} is isotopic to a component of $\partial A_{12,34}$, and ∂A_{41} is not primitive in H_B , $A_{12,34}$ is not parallel into \widehat{F} . We can enlarge the annulus B slightly in \widehat{F} so that it contains ∂A_{41} . Let \mathcal{T} be the solid torus bounded by $B \cup A_{12,34}$ in H_B . Then $\mathcal{N} = N(\mathcal{T} \cup A_{41})$ is a Seifert fiber space over the disk with two exceptional fibers. $K \cap \mathcal{N}$ is a single arc which is a cocore of a properly embedded Möbius band, $A_{12,34} \cup A_{41}$, in \mathcal{N} . Lemma 8.3

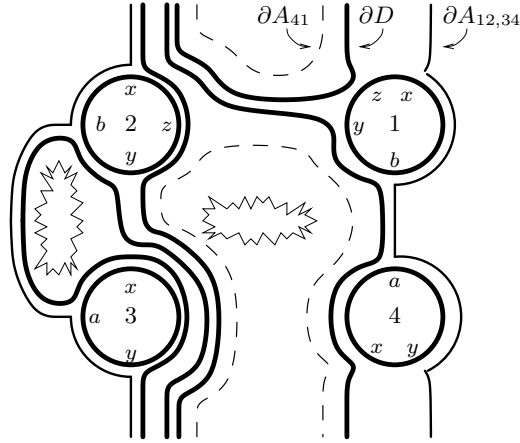

FIGURE 61.

now applies to produce a genus 2 Heegaard splitting of M in which K is 0-bridge, a contradiction.

This last contradiction proves the first conclusion of the Lemma, that some edge of f must be parallel in G_F to an edge of f_2, f_3, f_4 . Furthermore, if one edge of f is parallel to an edge of f_2 , then, in fact, f is parallel to f_2 . For otherwise, banding f and f_2 together along these parallel edges, and perturbing slightly gives a disk in H_B whose non-trivial boundary intersects $\partial A_{23} \cup \partial A_{41}$ at most once. If this disk is disjoint from $\partial A_{23} \cup \partial A_{41}$, and the boundary of the disk is non-separating in \widehat{F} , then ∂A_{23} and ∂A_{41} will be isotopic in \widehat{F} surgered along this disk, and M contains a Klein bottle. If disjoint and the boundary of the disk is separating, then one of $\partial A_{23}, \partial A_{41}$ must be primitive in H_B since M is irreducible, atoroidal, and the Heegaard splitting is strongly irreducible (Lemma 3.3). If the disk intersects $\partial A_{23} \cup \partial A_{41}$ once, then one of these Möbius bands will have primitive boundary in H_B .

Finally, assume f is incident to vertex x . Then Lemma 8.15 says that f cannot be parallel to f_2 (both $\overline{4T}$ -edges of the FESC are parallel on G_F). Thus the $\overline{2B}$ -edge of f must be parallel in G_F with the $\overline{2B}$ -edge of f_3 that is not shared with f_2 . Applying this argument to another mixed black bigon incident to vertex x , will then contradict Lemma 8.15. \square

Lemma 15.12. *Assume there is an MSTS configuration incident to vertex x . WLOG assume the bigon Scharlemann cycles of this configuration are on the White side. Then any Black mixed bigon, f , must have an edge which is parallel on G_F to an edge in the MST subconfiguration (the FESC). Furthermore, if that edge is parallel to an edge of the M in the MST, then f is parallel to M . In particular, there is at most one more Black mixed bigon incident to x .*

Proof. This is the same as the proof for Lemma 15.10. Note that the FESC is of type I at x and in both contexts one edge of the additional White SC has an edge parallel to both the M and T in the FESC, MST. \square

Lemma 15.13. *Assume Λ contains a FESC and an SC on the side of \widehat{F} opposite to that of the SC in the FESC, then the corresponding Möbius bands can be perturbed to be disjoint.*

That is, WLOG assume we have the configurations of Figure 62 where one of f_1, f_3 is a bigon and the other is a trigon and where f_4 is a Black SC (f_4 could equally well be a (12)-SC). Let A_{23}, A_{34} be the Möbius bands corresponding to f_2, f_4 . If ∂A_{23} and ∂A_{34} intersect transversely once, then K is 1-bridge with respect to a genus two Heegaard splitting of M .

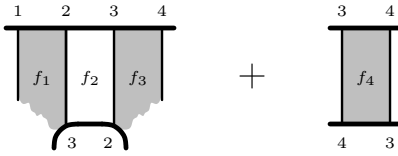

FIGURE 62.

Proof. Without loss of generality assume f_1 is a bigon and f_3 is a trigon. In this proof we consider faces of G_Q as disks properly embedded in $H_B - N(K), H_W - N(K)$. The proof of Lemma 14.9 shows that there are thinning disks Δ_{34}, Δ_{12} for (34), (12) disjoint from f_2 .

In fact, the thinning disk Δ_{34} may be chosen to be disjoint from f_4 as well as f_2 : Isotop $\partial\Delta_{34} \cap N((34))$ so that it is disjoint from f_2 and f_4 , for example as in Figure 63. After surgering Δ_{34} , we may assume it intersects f_4 in transverse arcs

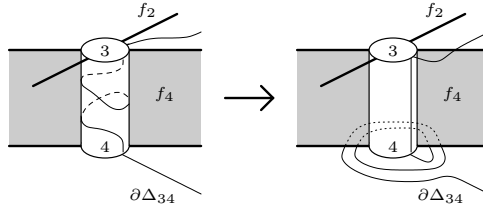

FIGURE 63.

(i.e. from one edge of f_4 to the other). Band an outermost disk of intersection along f_4 to give a thinning disk disjoint from both f_2 and f_4 .

Using Δ_{34} to ∂ -compress A_{34} yields a Black disk intersecting ∂A_{23} transversely once. See, for example, Figure 64. Thus ∂A_{23} is primitive in H_B . Apply Lemma 14.9. \square

Lemma 15.14. *Assume G_Q has a configuration SMST where WLOG the SCs are on the White side. Then G_Q contains no Black SC.*

The same conclusion holds for the configuration MSTs.

Proof. WLOG we assume the SMST configuration on G_Q is as in Figure 56 (without the face f). Assume for contradiction that G_Q also contains a Black SC, h . Denote by A_{23}, A_{41}, A_h , the Möbius bands that result from f_1, f_3, h (resp.). As argued in Lemma 15.10, neither ∂A_{23} nor ∂A_{41} can be primitive in H_B . By Lemma 15.13,

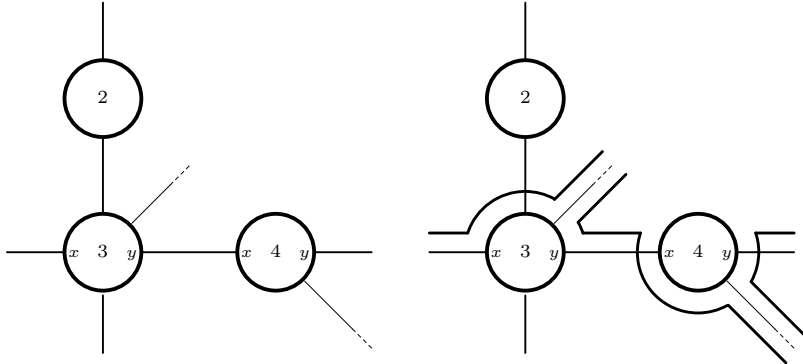

FIGURE 64.

∂A_h can be perturbed to be disjoint from ∂A_{23} . Since M contains no Dyck's surface, ∂A_{41} must intersect ∂A_h transversely once (at either vertex 1 or 4). Now follow the argument of Lemma 15.13. Let Δ_{12}, Δ_{34} be the bridge disks constructed as in Lemma 14.9. These bridge disks can be taken disjoint from both f_1 and h . Then boundary compressing A_h along one of these disks gives a disk in H_B intersecting ∂A_{41} once. But this implies ∂A_{41} is primitive in H_B .

Applying Lemma 14.5, the same argument shows that configuration MSTS where the S are White implies there are no Black S. \square

16. BIGONS AND TRIGONS WHEN $t = 4$.

Throughout this section assume $t = 4$, there are no Dyck's surfaces embedded in M , and we are in SITUATION NO SCC. Recall that an (ab) -SC is a bigon Scharlemann cycle on the labels a, b .

16.1. Embeddings of SCs and mixed trigons in a handlebody.

Lemma 16.1. *Given three (12) -SCs, one (34) -SC, and three more $\overline{34}$ -edges, then either three of the six $\overline{12}$ -edges are parallel in G_F or three of the five $\overline{34}$ -edges are parallel in G_F . Furthermore, if the three extra $\overline{34}$ -edges form a trigon Scharlemann cycle then three $\overline{12}$ -edges are parallel.*

Proof. Assume these SCs are contained in the handlebody H .

If there exists a compressing disk D in H that separates the (12) -SCs from the (34) -SC, then in one of the solid tori of $H \setminus D$ the three (12) -SCs are all parallel. Hence three of their $\overline{12}$ -edges are parallel in G_F .

If there exists a compressing disk D in H disjoint from these Scharlemann cycles that is non-separating, then $H \setminus D$ is a solid torus containing a (12) -SC and a (34) -SC. Thus there are two disjoint Möbius bands in this solid torus, a contradiction.

If no compressing disk of H is disjoint from the (12) -SCs and the (34) -SC, then any pair of (12) -SCs are either parallel or have no parallel edges (else band two SCs together along parallel edges). In particular, only two are parallel. (If all three (12) -SCs were parallel there would be a disk separating them from the (34) -SC.) The complement in H of these (12) -SCs and the (12) -arc of K is then one or two solid tori, that meet \widehat{F} in annuli, and a ball (the parallelism). Since the subgraph

of G_F consisting of vertices 3 and 4 and the five $\overline{34}$ -edges must lie in one of the annuli, three $\overline{34}$ -edges must be parallel.

If the three extra $\overline{34}$ -edges form a Scharlemann cycle trigon, then we must be in the former case of three parallel $\overline{12}$ -edges, as the edges of a (34)-SC and a (34)-Scharlemann cycle trigon cannot lie together in an annulus (e.g. Goda-Teragaito [16]). \square

Lemma 16.2. *Given two (12)-SCs and two (34)-SCs then either one pair is parallel or each pair has a pair of parallel edges.*

Proof. Assume no pair of edges of the (12)-SCs are parallel. Then the complement of the graph of these four edges and the vertices 1 and 2 in the boundary of the handlebody must be a collection of annuli. Hence the edges of the (34)-SCs lie in an annulus. Since handlebodies are irreducible and the edges of these Scharlemann cycles cannot lie in a disk, the (34)-SCs are parallel.

Similarly, if no pair of edges of the (34)-SCs are parallel, then the (12)-SCs are parallel. \square

Lemma 16.3. *Given a (12)-SC, a (34)-SC, and a trigon of Λ with two (12)-corners and one (34)-corner, then there are two embeddings in their genus 2 handlebody H up to homeomorphism. One has a pair of parallel $\overline{12}$ -edges; the other does not. These are shown in Figure 65 with H cut along the two SCs.*

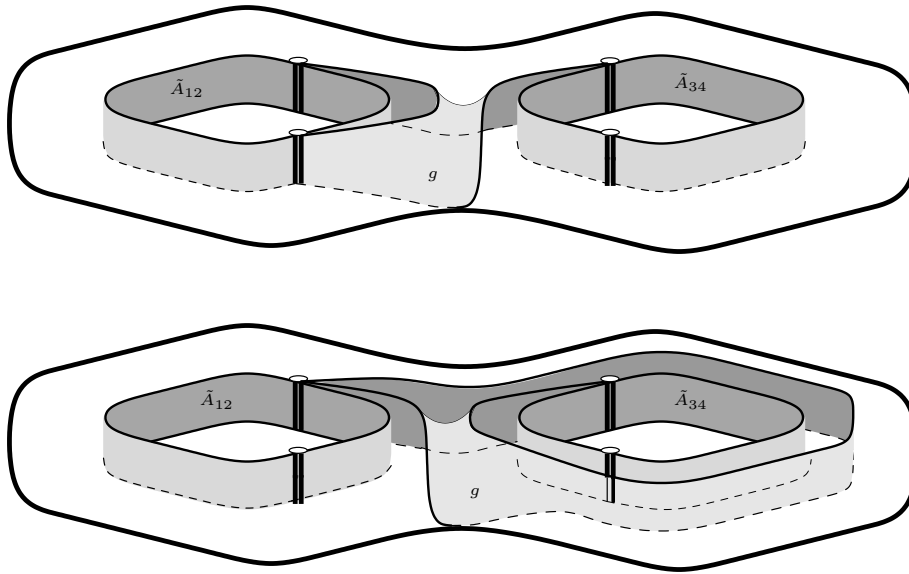

FIGURE 65.

Proof. Let A_{12} and A_{34} be the Möbius bands associated to the two SCs in the handlebody H . Then $H \setminus (A_{12} \cup A_{34})$ is a genus 2 handlebody H' . The impressions \tilde{A}_{12} and \tilde{A}_{34} of the Möbius bands are primitive annuli in H' and each has a primitivizing disk disjoint from the other annulus. Attach a 2-handle to H' along the core of \tilde{A}_{12} to form a solid torus \mathcal{T} . The primitivizing disk for \tilde{A}_{12} extends to a

disk δ giving a boundary-parallelism for the cocore c of this 2-handle. Moreover δ is disjoint from the (now longitudinal) annulus \tilde{A}_{34} .

Let g be the trigon. The two (12)-corners of g are identified along c to form \tilde{g} in \mathcal{T} . If A_{12} and g met transversely along (12) in H , then \tilde{g} is an annulus. Otherwise \tilde{g} is a Möbius band. In each situation, c is a spanning arc of \tilde{g} , \tilde{g} is properly embedded, and $\partial\tilde{g}$ crosses the longitudinal annulus \tilde{A}_{34} in $\partial\mathcal{T}$ just once.

If \tilde{g} is a Möbius band, then its embedding in \mathcal{T} is unique up to homeomorphism. If \tilde{g} is an annulus, then one boundary component is disjoint from \tilde{A}_{34} and trivial on $\partial\mathcal{T}$; because the spanning arc c (on \tilde{g}) is trivial in \mathcal{T} , the embedding of \tilde{g} in \mathcal{T} is unique up to homeomorphism. Recover H' with the impression \tilde{A}_{12} from $\mathcal{T}\setminus c$. Carrying the two possibilities of \tilde{g} along produces the two embeddings of g in H' shown in Figure 65. Reconstitute H and the two Möbius bands by sewing up \tilde{A}_{12} and \tilde{A}_{34} . This gives the two claimed embeddings of g in H . \square

Lemma 16.4. *Given a (12)-SC, a (34)-SC, a trigon of Λ with two (12)-corners and one (34)-corner, and a trigon of Λ with two (34)-corners and one (12)-corner, then either a pair of $\overline{12}$ -edges or a pair of $\overline{34}$ -edges must be parallel.*

Proof. Otherwise by Lemma 16.3 each trigon lives in $H' = H\setminus(A_{12} \cup A_{34})$ as pictured in the second part of Figure 65. These trigon faces form a meridian system for H' , where dual curves give generators x, y of $H_1(H')$. Up to swapping the generators and taking their inverses, the core of \tilde{A}_{12} represents xy^2 in $H_1(H')$, and the core of \tilde{A}_{34} may be oriented to then represent either yx^2 or yx^{-2} . In either case, attaching 2-handles to H' along the cores of $\tilde{A}_{12}, \tilde{A}_{34}$ gives a manifold with non-trivial torsion in first homology. But from Figure 65, one sees that attaching such 2-handles gives a 3-ball. \square

16.2. Configurations containing an ESC. Recall from section 6.3 that an annulus is primitive if and only a component of its boundary is primitive in the ambient handlebody.

Proposition 16.5. *If there is an ESC such that the extending annulus is non-separating in its handlebody, then the boundary of the central Möbius band is primitive with respect to the extending annulus's handlebody. Hence the extending annulus is primitive in its handlebody.*

Proof. Assume there is an ESC on the corner (1234) giving rise to a central White Möbius band A_{23} and an extending Black annulus $A_{12,34}$. Assume $A_{12,34}$ is non-separating in H_B and that ∂A_{23} is not primitive with respect to H_B .

There exists a bridge disk D_{12} for (12) that is disjoint from $A_{12,34}$. Indeed, D_{12} is a ∂ -compressing disk for the annulus $A_{12,34}$. Performing the ∂ -compression on a push-off of this annulus produces a non-separating disk D_B in H_B that is disjoint from $A_{12,34}$ and K . Let \mathcal{T} be the solid torus obtained by compressing H_B along D_B . Then $A_{12,34}$ is contained in \mathcal{T} and is ∂ -parallel into $\partial\mathcal{T}$.

Either both curves of $\partial A_{12,34}$ are primitive on H_B or both are non-primitive. Since ∂A_{23} is a component of $\partial A_{12,34}$, the former case is contrary to assumption. Hence we may assume $\partial A_{12,34}$ consists of two non-primitive curves in H_B . Therefore in \mathcal{T} the ∂ -parallel annulus $A_{12,34}$ wraps $n > 1$ times longitudinally. Then $\mathcal{N} = \mathcal{T} \cup (A_{23})$ is a Seifert fiber space over the disk with two exceptional fibers of orders 2 and n . Furthermore $K \cap \mathcal{N}$ is the arc (1234) that is the co-core of the long Möbius

band $A_{23} \cup A_{12,34}$. Lemma 8.3 now applies to produce a genus 2 Heegaard splitting of M in which K is 0-bridge, a contradiction. \square

Lemma 16.6. *If there is an ESC then the extending annulus is ∂ -parallel in its handlebody but is not primitive.*

Proof. Assume there is an ESC on the corner (1234). Let $A_{12,34}$ be the corresponding extending Black annulus.

Assume ∂A_{23} is a primitive curve on ∂H_B with respect to H_B . Then $H'_B = H_B \cup_{\partial A_{23}} N(A_{23})$ is a handlebody in which (1234) is bridge. Also $H'_W = H_W \setminus A_{23}$ is a handlebody in which (41) remains bridge. Thus (H'_B, H'_W) is a Heegaard splitting of M in which K is 1-bridge. This contradicts the minimality assumption on t . Hence ∂A_{23} cannot be primitive in H_B .

Consequently, Proposition 16.5 also implies that $A_{12,34}$ must be separating in H_B . Chopping H_B along $A_{12,34}$ forms a genus 2 handlebody H'_B and a solid torus \mathcal{T} .

We may assume $A_{12,34}$ is not longitudinal in \mathcal{T} . Lemma 8.3 applied to the Seifert fiber space over the disk given by $N(A_{23}) \cup \mathcal{T}$ contradicts that $t = 4$. \square

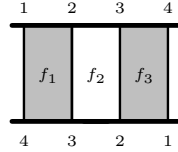

FIGURE 66.

Lemma 16.7. *Given the ESC of Figure 66, then in Λ any White bigon is an SC and any White trigon is a (41)-Scharlemann cycle. Furthermore any such (23)-SC must have its edges parallel to those of f_2 .*

Proof. Given the ESC on the corner (1234) as in Figure 66 let A_{23} be the corresponding White Möbius band and $A_{12,34}$ be the extending Black annulus. By Lemma 16.6 the annulus $A_{12,34}$ is parallel to an annulus $B_{12,34}$ on \widehat{F} .

The arguments of Lemma 12.4 prove that a White bigon must be a SC, while the arguments of Lemma 12.10 prove there is no White trigon with just one (23)-corner. Lemma 12.11 shows there cannot be a (23)-Scharlemann cycle of length 3. By an argument similar to that of Lemma 12.12, a trigon with two (23)-corners and one (41)-corner may be used in conjunction with the (23)-SC of the ESC to form a bridge disk for (41) with interior disjoint from $B_{12,34}$; this provides a thinning of K . Hence a White trigon must be a (41)-Scharlemann cycle.

Let σ be a (23)-SC and f be the face it bounds. One of the edges of σ must lie in $B_{12,34}$, call it e_1 , and the other, e_2 , lies outside of $B_{12,34}$. Then e_1 must be parallel to an edge e'_1 of f_2 . Let e'_2 be the other edge of f_2 .

We assume e_2, e'_2 are not parallel on G_F . Then f, f_2 can be amalgamated along the parallelism of e_1, e'_1 to give a White meridional disk D disjoint from K and $B_{12,34}$. See Figure 67. But then K can be isotoped into the solid torus $H_W - N(D)$ using the parallelism of $A_{12,34}$ to $B_{12,34}$, a contradiction. \square

Lemma 16.8. *There must be a true gap contiguous to an ESC of Λ .*

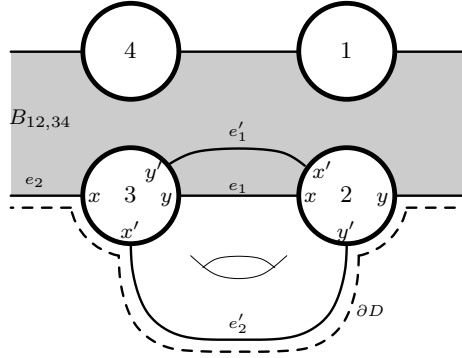

FIGURE 67.

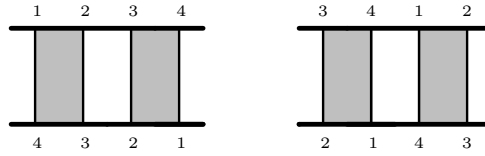

FIGURE 68.

Proof. Assume there is a bigon or trigon of Λ on each side of an ESC on the corner (1234) as in Figure 66. We can find a bridge disk D for either (23) or (41) which is disjoint (in the exterior of K) from both of these faces as well as the White face of the ESC. Let $B_{12,34}$ be the annulus on \widehat{F} to which the Black annulus $A_{12,34}$ (arising from the ESC) is parallel by Lemma 16.6. Since $\partial D \cap \widehat{F}$ is disjoint from the edges of the ESC, it either lies inside $B_{12,34}$ and is isotopic to an edge of the ESC or it lies entirely outside $B_{12,34}$. In either case, the parallelism of $A_{12,34}$ to $B_{12,34}$ along with D gives a thinning of K . \square

Lemma 16.9. *There cannot be five consecutive bigons.*

Proof. Assume there are five consecutive bigons. Then by Lemma 16.8, they appear as MSMSM. No two of the M are parallel since otherwise either there would be a contradiction to Lemma 8.15 or the boundary of a Möbius band arising from one of the SCs would bound a disk in \widehat{F} . Hence the two extending annuli of the two ESC are not parallel. In particular the annuli on \widehat{F} to which they are boundary parallel by Lemma 16.6 have disjoint interiors. But since the two extending annuli share a spanning arc, the two boundary parallelisms cause it two sweep out a compressing disk for the handlebody that contains it. This disk however is a primitivizing disk for the annuli, contrary to Lemma 16.6. \square

Lemma 16.10. *There cannot be two ESCs extending the same color but differently labeled SCs.*

Proof. Assume to the contrary that there are two ESCs as shown in Figure 68. Lemma 16.9 accounts for when they share a Black bigon. Indeed, using Lemma 16.6 and the fact that the boundaries of two Möbius bands cannot be isotopic in \widehat{F} (no Klein bottle), a similar proof works when they do not share a bigon. \square

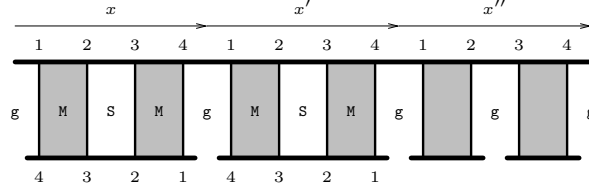

FIGURE 69.

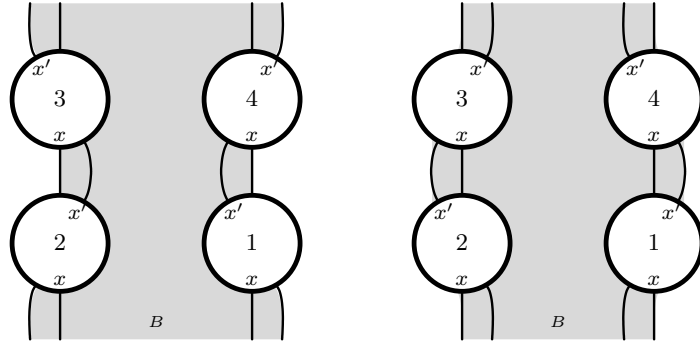

FIGURE 70.

Lemma 16.11. *Any two ESCs of Λ extending SCs of the same labels must have their extending annuli parallel. In particular, the corresponding faces of these two ESCs are parallel (see section 2.1).*

Proof. By Lemma 16.7, the SCs of these two ESCs have their edges parallel. Let A and A' be the extending annuli of the two ESCs. By Lemma 16.6, they are each ∂ -parallel to annuli B and B' , respectively, in \widehat{F} . Let D_{12} and D'_{12} be bridge disks for (12) swept out by the parallelisms of A to B and A' to B' respectively. Assuming A and A' are not parallel, $B \cup B'$ is a once-punctured torus. In particular, $D_{12} \cup D'_{12}$ is a disk in the handlebody containing A and A' whose boundary transversally intersects each component of ∂A and $\partial A'$ once. Thus A and A' are primitive in their handlebody, contradicting Lemma 16.6. \square

Lemma 16.12. *If $\Delta = 3$, then at a vertex of Λ there cannot be two (1234)-ESC's and bigons at the remaining (12)- and (34)-corners. That is, there cannot be the configuration $gMSMgMSMgBgB$ as shown in Figure 69.*

Proof. Assume the configuration shown in Figure 69 is around a vertex x in Λ . Let $A_{12,34}$ and $A'_{12,34}$ be the Black annuli extending the two Möbius bands arising from the two SCs. By Lemma 16.6 and Lemma 16.11 they are parallel to one another and they are both ∂ -parallel onto \widehat{F} . Let B be the union of the annuli on \widehat{F} to which $A_{12,34}$ and $A'_{12,34}$ are ∂ -parallel. The edges of the two ESCs and the annulus B are shown in Figure 70 with the relevant labelings of edges.

If one of the two remaining Black bigons were an M with an edge in B , then that edge would be parallel to an edge of each of the two ESCs. But then there would be three parallel edges that all have an endpoint labeled x , contradicting Lemma 8.15. If one of these bigons were an S with an edge in B , then it would

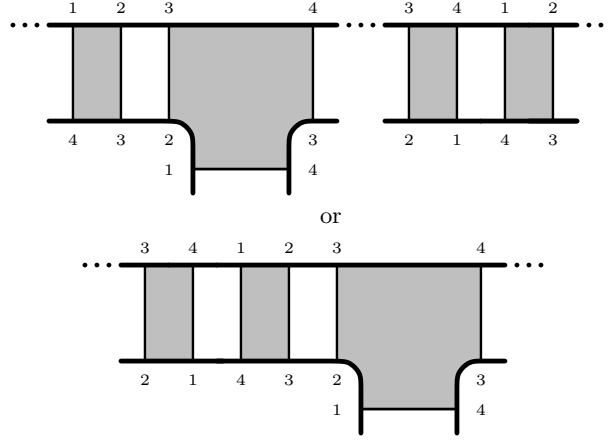

FIGURE 71.

form a Black Möbius band with boundary in B . This would imply the existence of an embedded Klein bottle, a contradiction. Thus the x'' labels on all four vertices must be outside B . This however creates an ordering violation. \square

Lemma 16.13. *In Λ there cannot be an ESC and an FESC such that the two interior SCs are the same color but have different labels.*

Proof. Assume otherwise. Up to relabeling we may assume the ESC and FESC appear as in Figure 71. This FESC is the one shown in Figure 41(a). As in Figure 41(a), let f denote the Black bigon and g denote the Black trigon of this FESC. Its White bigon forms a White Möbius band A_{23} . Lemma 14.5 implies that the two $\overline{14}$ -edges of it cobound a disk δ in H_B .

The ESC gives rise to a White Möbius band A_{41} and a Black annulus $A_{34,12}$. By Lemma 16.6, this annulus $A_{34,12}$ is ∂ -parallel onto an annulus $B_{34,12}$ on \widehat{F} . Either the trigon g is contained within this solid torus of parallelism \mathcal{T} between $A_{34,12}$ and $B_{34,12}$ or it is not.

Case I: The trigon g lies within \mathcal{T} . Then the edges of g lie within the annulus $B_{34,12}$. The bigon f can neither lie within \mathcal{T} nor also be a bigon of the ESC. Otherwise ∂A_{23} would lie in $B_{34,12}$ and we could form either an embedded $\mathbb{R}P^2$ if it were inessential or an embedded Klein bottle if it were essential (since it would be parallel to ∂A_{41}).

Since the $\overline{41}$ -edge of g lies in $B_{34,12}$, it is parallel to a $\overline{41}$ -edge of a Black bigon, say h , of the ESC. (By the preceding paragraph, h is necessarily distinct from f .) Then, since the $\overline{41}$ -edges of f and g cobound the disk δ , there must be a disk δ' that the $\overline{41}$ -edges of f and h bound. Furthermore we may assume the interior of δ' is disjoint from $A_{34,12}$.

Because f lies outside \mathcal{T} , there are rectangles ρ_{12} and ρ_{34} on the boundaries of the 1-handle neighborhoods $N((12))$ and $N((34))$ between the corners of f and h that have interiors disjoint from \mathcal{T} . Then together $f \cup \delta' \cup h \cup \rho_{12} \cup \rho_{34}$ forms a disk D whose boundary is the union of the $\overline{23}$ -edges of f and h (and arcs of the boundaries of the fat vertices 2 and 3). We may now slightly lift the interior of D into H_B off \widehat{F} so that it is disjoint from A_{41} . Attach D to the White Möbius band

A_{23} along the $\overline{23}$ -edge of f . Then $D \cup A_{23}$ is an embedded Möbius band in M that is disjoint from A_{41} and has boundary (formed of the $\overline{23}$ -edges of g and h) lying in $B_{34,12}$. As argued earlier, if this boundary were inessential we could form an embedded \mathbb{RP}^2 , and if it were essential we could form an embedded Klein bottle. Neither of these may occur.

Case II: The trigon g is not contained in \mathcal{T} . Then the edges of g meet the annulus $B_{34,12}$ only at the vertices.

Assume f does not lie in \mathcal{T} (so that f is also not a bigon of the ESC). We follow the bridge disk construction of Lemma 14.9. There are rectangles that are disjoint from \mathcal{T} , ρ_{12} and ρ_{34} , on the boundaries of the 1-handle neighborhoods $N((12))$ and $N((34))$ between corners of f and g , such that $f \cup \delta \cup g \cup \rho_{12} \cup \rho_{34}$ forms a disk D whose interior may be lifted off $A_{34,12}$ and \mathcal{T} . Note that the (34)-corner of g incident to the $\overline{34}$ -edge of g cannot lie in the rectangle ρ_{34} since otherwise g would intersect the interior of δ . Then ∂D intersects $A_{34,12}$ only along the arc (34) (the (34) corner of g that was disjoint from ρ_{34}) and at the vertex 2. A slight isotopy pulls D off vertex 2. Now attach a bridge disk D_{34} for the (34)-arc contained in \mathcal{T} to D along the (34)-arc. Then $D' = D \cup D_{34}$ is a properly embedded disk in H_B that intersects $B_{34,12}$ only in the spanning arc $D_{34} \cap B_{34,12}$. Hence D' is a primitivizing disk for the component ∂A_{41} of $\partial B_{34,12}$. However, ∂A_{41} cannot be primitive in H_B by Lemma 16.6.

Thus we must assume f lies in \mathcal{T} . Yet as in Case I (though using g instead of f there) there is a Black bigon h of the ESC so that the $\overline{41}$ -edges of g and h together bound a disk δ' . Using h and δ' in lieu of f and δ we may apply the previous argument to again conclude that ∂A_{41} is primitive in H_B contradicting Lemma 16.6. \square

Lemma 16.14. *There cannot be four bigons adjacent to a trigon.*

Proof. If there were, then by Lemma 16.8 they must form an ESC and a FESC that share a bigon. Lemma 16.13 prohibits this configuration. \square

16.3. More configurations of bigons and trigons.

Lemma 16.15. *Assume that at a vertex, x , of G_Q there is a configuration SMTM and another S on the same corner as the T. That is, WLOG assume we have the configurations of Figure 72. Then the edges of the length two and three (23)-Scharlemann cycles cannot lie in \widehat{F} in a subsurface which is a 3-punctured sphere or a 1-punctured torus. In particular, there cannot be two more $\overline{41}$ -edges incident to x .*

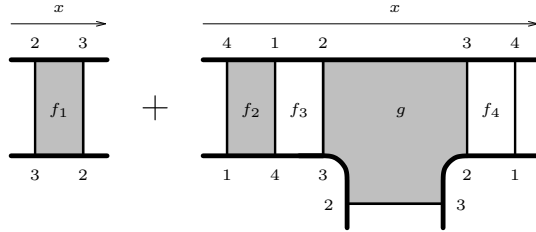

FIGURE 72.

Proof. Assume we have the configuration of Figure 72. Let A_{23} and A_{41} be the two Black Möbius bands arising from the two SCs. Let $A_{12,34}$ be the White annulus formed by joining f_3 and f_4 along the arcs (12) and (34). Write $\partial A_{12,34} = \gamma_{23} \cup \gamma_{41}$ where γ_{23} is the component formed from edges of g .

Let Θ_{23} be the Black “twisted θ -band” gotten by identifying the corners of the Scharlemann cycle trigon along the (23)-arc of K . By $\partial\Theta_{23}$ we denote the θ -graph formed from the three edges of the Scharlemann cycle trigon and the vertices 2 and 3 that is the intersection of Θ_{23} with \widehat{F} .

The edges of f_1 and g , as edges in G_F , cannot lie in a 3-punctured sphere. For by Lemma 8.15, the edges of f_1 would have to be separating in this punctured sphere and this contradicts the labelling around vertices 2, 3 of the edges of g .

So we assume for contradiction that edges of f_1, g lie in a 1-punctured torus in \widehat{F} . But then there is a properly embedded disk D in H_B that separates A_{41} from A_{23} and Θ_{23} and that is disjoint from K (in the boundary of the 3-manifold gotten by thickening the punctured torus, the (23)-arc of K , and f_1, g).

Then $H_B - N(D)$ is two solid tori \mathcal{T}_{41} and \mathcal{T}_{23} containing A_{41} and $A_{23} \cup \Theta_{23}$ respectively. The subgraph of G_F on $\partial\mathcal{T}_{23}$ consisting of the vertices 2 and 3 and the edges of the two (23)-SCs has three parallel edges, two from g flanking one from f_1 (use Lemma 8.15, the fact that \mathcal{T}_{23} is a solid torus, and the labelling at vertices 2, 3 of the edges of f_1, g on $\partial\mathcal{T}_{23}$, also see Goda-Teragaito [16]). Furthermore ∂A_{23} lies in an annulus on $\partial\mathcal{T}_{23}$ that runs twice longitudinally and $\partial\Theta_{23}$ lies in an annulus running three time longitudinally along \mathcal{T}_{23} (consider the lens space resulting from attaching a 2-handle to \mathcal{T}_{23} along these annuli). We may take γ_{41} disjoint from D and contained in $\partial\mathcal{T}_{41}$. Since $\gamma_{23} \subset \partial\Theta_{23}$, it is either trivial on $\partial\mathcal{T}_{23}$ or it runs three times longitudinally around \mathcal{T}_{23} . Furthermore, observe that (23) and (41) have bridge disks disjoint from D and $A_{23} \cup \Theta_{23}$ and A_{41} .

If γ_{23} is trivial on $\partial\mathcal{T}_{23}$. Then it must be isotopic to ∂D on \widehat{F} since otherwise the two edges forming it would be parallel to a $\overline{23}$ -edge of f_1 violating Lemma 8.15. Thus $A_{12,34}$ is separating and ∂ -parallel (else $H_B \cup D$ contains a lens space summand) onto a neighborhood of $\partial D \subset \widehat{F}$. Since there exists a bridge disk for (23) in \mathcal{T}_{23} disjoint from D , there is an isotopy of the arc (1234) onto \widehat{F} fixing the complementary arc (41). Hence K is at most 1-bridge, a contradiction.

Thus we assume γ_{23} runs three times longitudinally around \mathcal{T}_{23} . If γ_{41} bounds a disk D' on $\partial\mathcal{T}_{41}$, then $N(D' \cup A_{12,34} \cup \mathcal{T}_{23})$ forms a punctured $L(3, 1)$. This cannot occur since M is irreducible and not a lens space. Hence γ_{41} is essential on $\partial\mathcal{T}_{41}$.

Let $\mathcal{N} = \mathcal{T}_{23} \cup N(A_{12,34}) \cup \mathcal{T}_{41}$. If γ_{41} is longitudinal on $\partial\mathcal{T}_{41}$, then \mathcal{N} is a solid torus containing K contradicting the hyperbolicity of K , that $t = 4$, or Lemma 3.3. Thus \mathcal{N} is a Seifert fiber space over the disk with two exceptional fibers. Hence $M \setminus \mathcal{N}$ is a solid torus. Let $H'_B = \mathcal{T}_{23} \cup N(f_3) \cup \mathcal{T}_{41}$ and note that, by using the bridge disks disjoint from the SCs, K is isotopic onto $\partial H'_B$. Viewing $N(f_4)$ as a 1-handle attached to the solid torus $M \setminus \mathcal{N}$, $M \setminus H'_B = (M \setminus \mathcal{N}) \cup N(f_4)$ is a genus 2 handlebody. Hence K is 0-bridge with respect to this new genus 2 Heegaard splitting, a contradiction. Thus the edges of f_1, g do not lie on a 1-punctured torus in \widehat{F} .

To prove the last sentence of the Lemma, note that the first part implies that all $\overline{41}$ -edges must lie in an annulus on \widehat{F} . Given two more $\overline{41}$ -edges with an endpoint labeled x , then we have at least five such total. There is then a violation of Lemma 8.15. \square

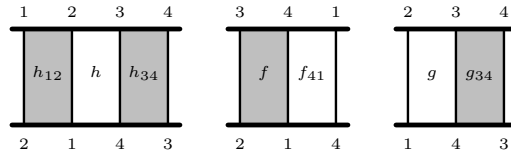

FIGURE 73.

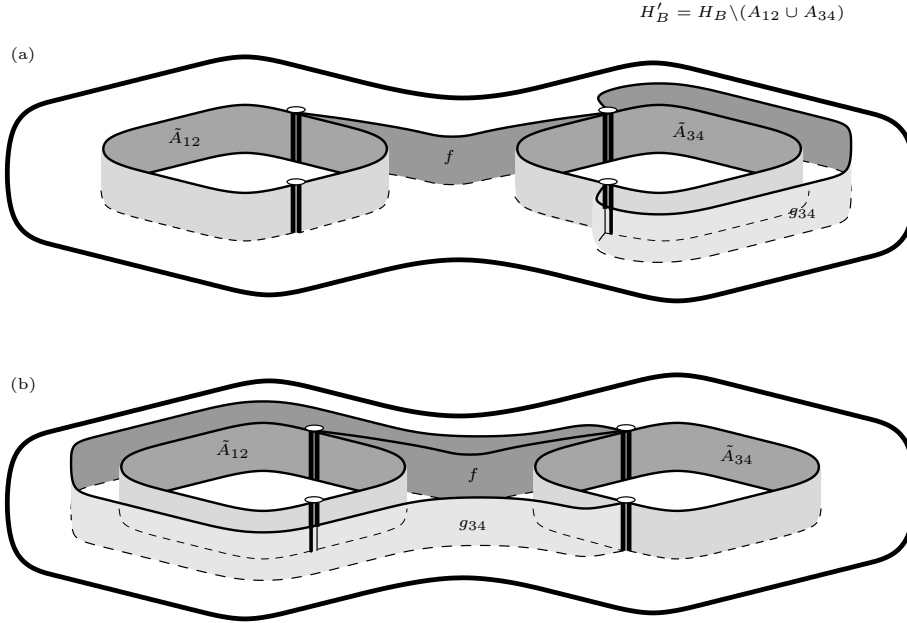

FIGURE 74.

Lemma 16.16. *Given a collection of bigons in G_Q as shown in Figure 73, then the two (34) -SCs must be parallel such that the two $\overline{34}$ -edges of g and h are parallel.*

Proof. Assume we do have the collection of bigons shown in Figure 73. Let f , g , and h denote the bigons as shown. Let A_{12} and A_{34} be the Black Möbius bands arising from the two Black SCs h_{12} and h_{34} in the run of 3 bigons. Let A'_{34} be the Black Möbius band arising from the remaining Black SC g_{34} . Let A_{41} be the White Möbius band arising from the White SC f_{41} .

Chop open H_B along A_{12} and A_{34} to form the genus 2 handlebody H'_B . These leave annular impressions \tilde{A}_{12} and \tilde{A}_{34} that are each primitive on H'_B . The bigon f becomes a compressing disk that traverses the impressions \tilde{A}_{12} and \tilde{A}_{34} each once. Further chopping along f leaves a solid torus in which the SC g_{34} may only have two positions. Figure 74 shows the two possibilities of g_{34} in H'_B with respect to f . Reforming H_B by gluing \tilde{A}_{12} and \tilde{A}_{34} back into A_{12} and A_{34} , we observe that the two (34) -SCs either have no two edges parallel or are parallel.

Assume no pair of edges of the two Black $\overline{34}$ -SCs are parallel as in Figure 74(b). The complement in \hat{F} of the subgraph of G_F induced by the edges of the Black bigons is seen to be one annulus and two disks. The annulus does not meet the

vertices 1 or 2. Each disk meets each of the four vertices of G_F . Around the boundary of one disk we see the vertices in the cyclic order 143412; around the other we see 234321. The $\overline{41}$ -edge of f appears as the subarcs of the boundary of the first disk joining the consecutive 1 and 4 vertices. The $\overline{41}$ -edge of f_{41} that is not an edge of f cannot be in the first disk, since then ∂A_{41} would be isotopic to ∂A_{12} and a Klein bottle could be formed. Thus it must be an edge of the second disk, and this choice is unique.

We can now find bridge disks for the arcs (12) and (34) in H_B that guide isotopies of these arcs (rel ∂) to arcs on ∂H_B that are disjoint from ∂A_{41} except at vertices 1 and 4, and which arcs are incident to ∂A_{41} on the same side. Furthermore, we see that ∂A_{41} is primitive in H_B (e.g. boundary compressing A_{12} along the above bridge disk for (12) gives a disk intersecting ∂A_{41} once). Attaching a neighborhood of A_{41} to H_B forms a new genus 2 handlebody H_B'' , whose complement $H_W'' = H_W - N(A_{41})$ is a genus 2 handlebody. As in the argument of Lemma 14.9, K can be isotoped to be 1-bridge with respect to this new splitting (as the union of the arc (12341), properly isotopic to the bridge arc (23) in H_W'' , and an arc in H_B'' that is a cocore of the attaching annulus $N(A_{41}) \cap H_B$). This contradicts the minimality of the presentation of K .

Hence the two (34)-SCs are parallel as in Figure 74(a). Assume the $\overline{34}$ -edges of g and h are not parallel. Then after an isotopy of the $\overline{34}$ -edge of g , these two edges form ∂A_{34} . Thus we may regard $g \cup h$ as a White annulus $A_{23,41}$ that has ∂A_{34} as a boundary component. Thus $A_{34} \cup A_{23,41}$ is a long Möbius band as if it arose from an ESC centered at a Black SC. The argument of Lemma 16.7 now applies to show that the Black bigon f should have been an SC. \square

Lemma 16.17. *There cannot be two triples of SMS on the same corner at a vertex of Λ .*

Proof. Assume there are two such triples on the corner (2341) of a vertex of Λ . Then each triple contains a (23)-SC and a (41)-SC. By Lemma 16.2 either each pair of like-labeled SCs has a pair of parallel edges or one pair of the SCs is parallel.

Thus an outside edge of one triple must be parallel on G_F to an edge of the middle mixed bigon, f , of the other triple. Say this outside edge belongs to a (23)-SC of the first triple. Then the faces of the first triple, along with f and the (41)-SC of the second triple, can be used in the argument of Lemma 16.8 to find a thinning. (The two mixed bigons form the equivalent of an ESC about this (23)-SC). \square

17. LEMMA 17.1 AND ITS PROOF

Throughout this section assume $t = 4$, there are no Dyck's surfaces embedded in M , and we are in SITUATION NO SCC.

Lemma 17.1. *Assume the configurations shown in Figure 75 appear in Λ . Then*

- (1) e_3 is incident to opposite sides of $e_2 \cup e_6$,
- (2) e_4 is incident to opposite sides of $e_1 \cup e_5$,
- (3) ∂A_{34} transversely intersects each component of $\partial A_{12,34}$ once, and
- (4) neither f_0 nor f_5 is a bigon.

Here A_{34} is the Black Möbius band arising from the SC f_6 and $A_{12,34}$ is the Black annulus arising from gluing f_1 and f_4 together along (12) and (34).

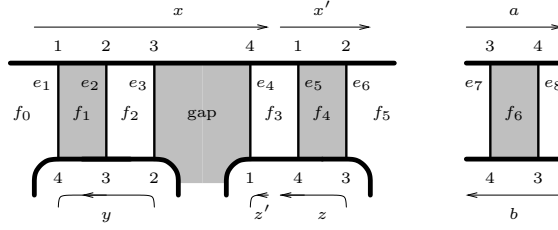

FIGURE 75.

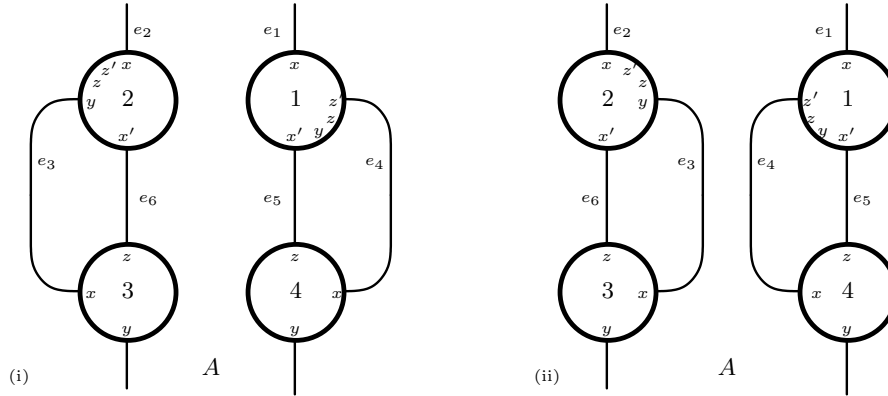

FIGURE 76.

Proof. In addition to forming the Black annulus $A_{12,34}$ and Black Möbius band A_{34} from f_1 , f_4 , and f_6 , the White SCs f_2 and f_3 form White Möbius bands A_{23} and A_{41} respectively. By Lemma 8.15, no component of $\partial A_{12,34}$ is trivial in \widehat{F} .

Claim 17.2. *The annulus $A_{12,34}$ is non-separating in H_B .*

Proof. Assume $A_{12,34}$ is separating in H_B . Then $\partial A_{12,34}$ bounds an annulus A in ∂H_B . Furthermore, no edge of G_F may be incident to opposite sides of either $e_2 \cup e_6$ or $e_1 \cup e_5$.

Subclaim 1a: Both e_3 and e_4 are disjoint from A .

Proof. By labelings, if e_3 is incident to just one side of $e_2 \cup e_6$, then e_4 must be incident to just one side of $e_1 \cup e_5$ as indicated in Figure 76 (i) where neither e_3 nor e_4 lie in A or (ii) where both e_3 and e_4 lie in A . However in Figure 76(ii) either ∂A_{23} or ∂A_{41} is trivial in A or both are isotopic to the core of A ; hence an embedded $\mathbb{R}P^2$ or Klein bottle may be created. (As drawn in Figure 76(ii), ∂A_{41} is trivial and a $\mathbb{R}P^2$ may be created.) Thus the edges must appear as in Figure 76(i). \square

Subclaim 1b: Both edges e_7 and e_8 of f_6 are disjoint from A .

Proof. By labelings, if either e_7 or e_8 were to lie in A then so would the other. Hence ∂A_{34} would be isotopic to the core of A . Thus A_{23} , A_{34} , and A_{41} are three disjoint Möbius bands, each properly embedded in either H_B or H_W . This contradicts Lemma 8.11. \square

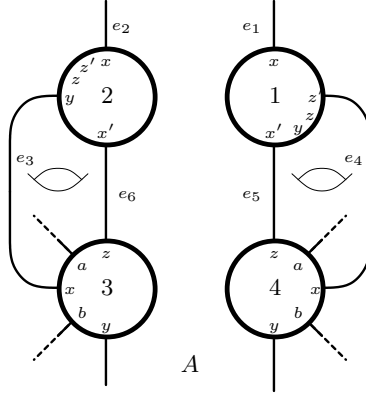

FIGURE 77.

Subclaim 1c: For $i = 3, 4$, let C_i be the corner on vertex i cobounded by the edges e_7 and e_8 of f_6 that is disjoint from A . Then e_3 must be incident to C_3 and e_4 must be incident to C_4 . Consequently e_3 is not parallel to either e_2 or e_6 and e_4 is not parallel to either e_1 or e_5 .

Proof. By labelings, e_3 is incident to C_3 if and only if e_4 is incident to C_4 . Thus assume neither is incident to C_3 or C_4 . Then we may perturb A_{34} to be disjoint from A_{23} and A_{41} . Again, this contradicts Lemma 8.11.

Since the edges e_7 and e_8 separate both e_3 from e_2 and e_6 at vertex 3 and e_4 from e_1 and e_5 at vertex 4, no pairs of these edges may be parallel. \square

As a consequence of these subclaims, the subgraph of G_F induced by the edges e_1, \dots, e_8 appear as in Figure 77 with possibly e_7 and e_8 swapped.

Note that $P = N(A \cup e_3 \cup e_4) \subset \partial H_B$ is a 4-punctured sphere whose complement in ∂H_B is two annuli A_1 and A_2 . Moreover ∂A_{23} is isotopic to the core of one of these annuli and ∂A_{41} is isotopic to the core of the other; they cannot be isotopic to the same core since together they would form a Klein bottle. However, since e_8 (or e_7) lies outside of P , it lies in, say, A_1 . But then A_1 connects ∂A_{23} to ∂A_{41} .

This finishes the proof of Claim 17.2. \square

Claim 17.3. ∂A_{34} transversely intersects each component of $\partial A_{12,34}$ just once.

Proof. Assume otherwise. Then the subgraph of G_F induced by the edges of f_1, f_4 , and f_6 appears as in Figure 78 (disregard δ and D for now). Note that ∂A_{34} may be perturbed to be disjoint from $A_{12,34}$. Since $A_{12,34}$ is a Black annulus and A_{34} is a Black Möbius band, there is a non-separating compressing disk D for H_B that is disjoint from both. Cutting H_B along D we obtain a solid torus \mathcal{T} in which $A_{12,34}$ must be the boundary of a neighborhood around A_{34} . Thus some component of $\partial A_{12,34}$ must be isotopic on ∂H_B to ∂A_{34} . As in Figure 78, let δ be the region of ∂H_B giving this parallelism.

Note that if either e_3 or e_4 lies in δ then it is parallel to an edge of $\partial A_{12,34}$. Then either A_{23} or A_{41} in union with $A_{12,34}$ forms a long Möbius band. Assuming δ is as shown in Figure 78, then e_3 could lie in δ and $A_{23} \cup A_{12,34}$ would form the long Möbius band. By Proposition 16.5 ∂A_{23} must then be primitive in H_B . Yet since

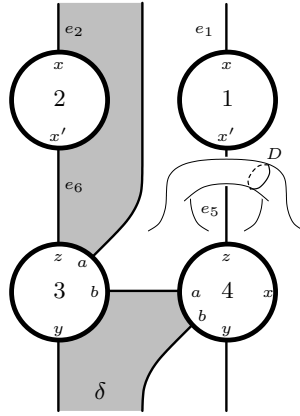

FIGURE 78.

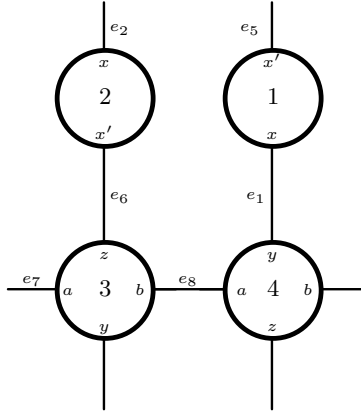

FIGURE 79.

$A_{12,34}$ is the boundary of a neighborhood around A_{34} in \mathcal{T} , neither component of $\partial A_{12,34}$ may be primitive in H_B .

Thus we may assume neither e_3 nor e_4 may lie in δ , and that δ is as pictured in Figure 78. Therefore the two ends of e_3 are incident to the same side of $e_2 \cup e_6$, and thus ∂A_{23} can be perturbed off $\partial A_{12,34}$. Then A_{23} , A_{34} , and A_{41} are disjoint Möbius bands contrary to Lemma 8.11. \square

Without loss of generality, the subgraph of G_F induced by the edges of f_1 , f_4 , and f_6 appears as in Figure 79. Let $N = N((12) \cup (34) \cup f_1 \cup f_4 \cup f_5) = N(A_{12,34} \cup A_{34})$. Thus $B = \partial N - \partial H_B$ is an annulus and $A = \partial H_B - \partial N$ is an annulus. Also $B \cup A = \partial \mathcal{T}$ where \mathcal{T} is a solid torus in which A is longitudinal (since a bridge disk for (12) , say, can be taken to be disjoint from $f_1 \cup f_4 \cup f_6$). Thus there is a compressing disk for H_B transversely intersecting $A_{12,34}$ once and each component of $\partial A_{12,34}$ is primitive in H_B . Finally, note that N is a twisted I -bundle over a once-punctured Klein bottle.

Claim 17.4. *The edge e_4 is incident to opposite sides of the closed curve $e_1 \cup e_5$.*

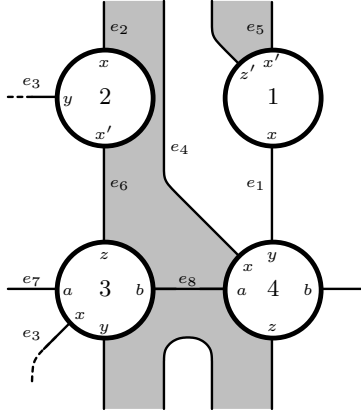

FIGURE 80.

Proof. Assume both ends of e_4 are incident to the same side of $e_1 \cup e_5$. Then both endpoints of e_4 lie on the same component of ∂A . Since ∂A_{41} is not trivial in ∂H_B , either

- (1) e_4 is parallel to e_1 ,
- (2) ∂A_{41} is isotopic to the core of A , or
- (3) ∂A_{41} is isotopic to the 23-component of $\partial A_{12,34}$.

In situation (1), ∂A_{41} is isotopic to the 41-component of $\partial A_{12,34}$. Thus $A_{41} \cup A_{12,34}$ forms a long Möbius band containing the arc (3412). Since there is a disk in H_B transversely intersecting $A_{12,34}$ just once, we may form the handlebody $H'_B = H_B \cup_{\partial A_{41}} N(A_{41})$ in which the arc (3412) is bridge. Since the White arc (23) has a bridge disk disjoint from A_{41} , removing $N(A_{41})$ from H_W forms the handlebody $H'_W = H_W - N(A_{41})$ in which (23) is bridge. Thus together H'_B and H'_W form a genus 2 Heegaard splitting of M in which K is 1-bridge. This contradicts the minimality of t .

In situation (2) we may form an embedded Dyck's surface by taking the 0-section of the twisted I -bundle N in union with A_{41} . Its existence is contrary to assumption.

Thus we are in situation (3) and we have the subgraph of G_F shown in Figure 80. This implies that the endpoints of the edge e_3 must lie on the same side of $e_2 \cup e_6$. Hence the same argument applied to e_4 applies to e_3 allowing us to conclude that ∂A_{23} must be isotopic to the 41-component of $\partial A_{12,34}$. Then together $A_{23} \cup A_{12,34} \cup A_{41}$ form a Klein bottle in M . \square

Claim 17.5. *The edge e_3 is incident to opposite sides of the closed curve $e_2 \cup e_6$.*

Proof. The argument for Claim 17.4 applies analogously. \square

Claim 17.6. *Neither f_0 nor f_5 is a bigon.*

Proof. We will show that f_0 cannot be a bigon. The argument for f_5 is the same.

Assume f_0 is a bigon. Then it must be a 41-SC as shown in Figure 81. Let A'_{41} be the White Möbius band arising from f_0 . We divide the argument into cases according to the relationships among the $\overline{41}$ -edges of f_0 and f_3 .

Case I: No two edges of f_0 and f_3 are parallel in ∂H_B .

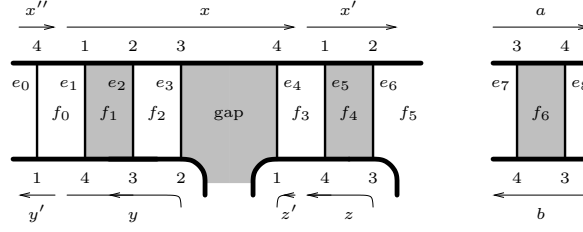

FIGURE 81.

Then A_{41} and $A_{41'}$ intersect transversely and a neighborhood in ∂H_B of the union of the edges of f_0 and f_3 is a 4-punctured sphere. (Otherwise A_{41} and $A_{41'}$ could be isotoped to be disjoint from one another and from A_{23} ; two or three of these together then would form an embedded non-orientable surface in the handlebody H_W .) Yet by Claim 17.5, these edges lie in a 1-punctured torus on ∂H_B . Hence one of the components of the 4-punctured sphere must bound a disk in ∂H_B . This however implies that two edges of f_0 and f_3 are parallel.

Case II: Two edges of f_0 and f_3 are parallel in ∂H_B .

By Lemma 8.15, it must be that either e_0 is parallel to e_5 or e_1 is parallel to e_4 on ∂H_B . Then either $\partial A'_{41}$ or ∂A_{41} respectively is isotopic to the $\overline{41}$ -component of $\partial A_{12,34}$. Hence we have a long Möbius band and may apply the argument of situation (1) in the proof of Claim 17.4 to obtain a thinning of K . \square

This completes the proof of Lemma 17.1 \square

18. SITUATION SCC FOR $t = 4$.

Throughout this section we assume we are in SITUATION SCC for $t = 4$. In Theorem 18.11 we will conclude that $t \neq 4$.

We may assume there is a meridian disk D of \widehat{F} disjoint from K and Q . Let F^* be \widehat{F} surgered along D .

Lemma 18.1. *The graph G_F lies in a single component \widehat{T} of F^* .*

Proof. Otherwise F^* is two tori. Say $D \subset H_W$ so that D cuts H_W into two solid tori \mathcal{T}_{23} and \mathcal{T}_{41} , each containing one arc of K , say (23) and (41) respectively. Then every White face of Λ is a SC and every Black face is not. Moreover every Black face is either a mixed bigon or has at least four sides. Finally, we may surger any disk face of G_Q so that its interior is disjoint from F^* (by Corollary 3.2 and the strong irreducibility of the Heegaard splitting, an innermost curve of intersection is either a copy of D or bounds a meridian disk of \mathcal{T}_{23} or \mathcal{T}_{41} that is disjoint from K . In the former case we can surger the intersection away. The latter combines with Corollary 5.3 to give the contradiction that M contains a lens space summand.)

The edges of any two White Scharlemann cycles of Λ of length at most three and on the same label pair, lie in exactly two parallelism classes in the graphs on $\partial \mathcal{T}_{23}$ or $\partial \mathcal{T}_{41}$. Thus Lemma 12.15 prevents there from being three or more bigon, trigon Scharlemann cycles at the (23)-corners of a vertex of Λ or at the (41)-corners of a vertex of G_Q . In the language of special vertices (see below), this means there must be at least one true gap at a (23)-corner and at a (41)-corner of any special vertex.

Recall that two bigon faces of G_Q are said to be *parallel* if each edge of one is parallel to an edge of the other.

Claim 18.2. *In Λ if a Black bigon is adjacent to a White bigon or trigon Scharlemann cycle, then all Black bigons are parallel. Moreover, at a vertex of Λ , at most two Black corners have bigons and these would have opposite labels.*

Proof. To the contrary, assume Λ has two non-parallel mixed Black bigons f and g such that f shares an edge with a White bigon or trigon Scharlemann cycle. Note that neither edge of f is parallel on F^* to an edge of g , else the two Black faces can be combined to give a disk that contradicts Lemma 3.3 and the strong irreducibility of the Heegaard splitting. Then $\mathcal{N} = N(f \cup (12) \cup (34) \cup \mathcal{T}_{23} \cup \mathcal{T}_{41})$ is a genus 2 handlebody in which K is isotopic to an arc on $\partial\mathcal{N}$ and a bridge arc (using the bigon/trigon Scharlemann cycle that can be surgered to lie entirely in \mathcal{T}_{23} or \mathcal{T}_{41}). Attaching $N(g)$ to \mathcal{N} forms a Seifert fiber space over the disk with two exceptional fibers. (Otherwise K would be contained in the solid torus, $N(g) \cup \mathcal{N}$. As K is hyperbolic and M is not a lens space, K would have to be a core of this solid torus. But then K is 0-bridge with respect to $H_W \cup H_B$.) Then as usual $M \setminus (\mathcal{N} \cup N(g))$ is a solid torus \mathcal{T} . So now \mathcal{N} and $\mathcal{T} \cup N(g)$ form a genus 2 Heegaard splitting of M in which K is 1-bridge.

Given that all Black bigons are parallel, a vertex of Λ may have at most one Black bigon at a (12)-corner and one at a (34)-corner. \square

Remark 18.3. To make the proof of Claim 18.2 consistent with the proof of Theorem 2.6 we need to sharpen the argument to show that either Claim 18.2 holds (without changing the splitting) or M is a Seifert fiber space with an exceptional fiber of order 2 and furthermore that K is 1-bridge with respect to a vertical splitting of M . The argument given in Claim 18.2 applied to an ESC shows this. So we must show there is an ESC. We have shown that any black interval either belongs to a mixed bigon or corresponds to a true gap. We have also shown that there is a true gap at a (41)-corner and a (23)-corner. If there is no ESC then Lemma 5.11 shows that Γ has a special vertex of weight $N = 4$. The fact that there are at least two true gaps at this special vertex implies that there are at most three true gaps and one more corner which is has a trigon. Between these four corners every other corner belongs to a bigon of Γ . First, note that if there is no ESC, then there is no triple of bigons. Otherwise on either side of this triple must be black gaps, hence true gaps – but then there are four true gaps (two black and two white). There is only one way that there is no triple of bigons, and that is that $\Delta = 3$ and there are exactly two bigons between each of these four corners. But this implies that two of these four corners are black, which along with the white gaps makes four true gaps. Thus there must be an ESC.

To finish the proof of Lemma 18.1, Claim 18.2 and Lemma 8.15 imply that there cannot be 9 mutually parallel edges in Λ . By Lemma 5.11, Λ must have a special vertex of length $N = 4$. Recall from the beginning of section 13, that a “true gap” is a corner of a special vertex that is not known to be a bigon or trigon. By Lemma 5.13, the special vertex of Λ has at most three true gaps. If around a vertex of Λ there is a Black bigon adjacent to a White bigon or trigon (which are Scharlemann cycles), then Claim 18.2 and Lemma 8.15 imply at least 4 Black corners at the special vertex have true gaps (any Black face is a true gap or a bigon). Thus a special vertex of Λ must have any White bigon or trigon flanked by true gaps. But then, since there are at least two true gaps at White corners, this vertex must have at least 4 true gaps. \square

Let \widehat{T} be as in Lemma 18.1 and \mathcal{T} be the solid torus it bounds (gotten by surgering the Heegaard handlebody along D). By possibly rechoosing D , we may assume that any disk face of G_Q may be surgered so that its interior is disjoint from \widehat{T} (as argued in the proof of Lemma 18.1).

Lemma 18.4. *There cannot be two SCs of the same color but with different labels.*

Proof. Otherwise the Möbius bands to which they give rise are disjoint and have parallel boundaries on \widehat{T} . From this we may construct an embedded Klein bottle. \square

Proposition 18.5. *There is no ESC.*

Proof. Assume we do have an ESC as in Figure 66. Let A_{23} be the associated White Möbius band and $A_{12,34}$ be the Black annulus. We may take both to be properly embedded in \mathcal{T} or its exterior.

Claim 18.6. $D \subset H_B$

Proof. If $D \subset H_W$, then A_{23} is contained in \mathcal{T} .

Set $\mathcal{N} = \mathcal{T} \cup N(A_{12,34})$. Observe that \mathcal{N} is a Seifert fiber space over the annulus with one exceptional fiber and that $K \subset \mathcal{N}$. Then $\partial\mathcal{N}$ is two tori and one of these components must compress outside of \mathcal{N} . Such a compression produces a 2-sphere which must bound a 3-ball B . Since $K \not\subset B$, $\mathcal{N} \not\subset B$. Therefore this torus bounds a solid torus \mathcal{T}' with interior disjoint from \mathcal{N} .

Assume $\mathcal{N} \cup \mathcal{T}'$ is a solid torus. Since K is hyperbolic and M does not contain a lens space summand, $K \subset \mathcal{N} \cup \mathcal{T}'$ must be isotopic to its core. That is, K is isotopic to a core curve of H_W . But then K is 0-bridge.

Thus $\mathcal{N} \cup \mathcal{T}'$ must form a Seifert fiber space over the disk with two exceptional fibers. Hence $M \setminus (\mathcal{N} \cup \mathcal{T}')$ is a solid torus \mathcal{T}'' . Now we may form a genus 2 Heegaard splitting of M by taking $H'_B = \mathcal{T}' \cup N(f_1) \cup \mathcal{T}''$ and $H'_W = M \setminus H'_B = \mathcal{T} \cup N(f_3)$. Then $K \subset H'_W$ and K may be isotoped so that it is 1-bridge with respect to this Heegaard splitting. \square

Since $D \subset H_B$ by Claim 18.6, $A_{12,34}$ is contained in \mathcal{T} of $H_B \setminus D$.

Claim 18.7. ∂A_{23} is a longitude of \mathcal{T} .

Proof. If it is not, then we may form a Seifert fiber space over the disk with two exceptional fibers $\mathcal{N} = \mathcal{T} \cup N(A_{23})$. Now apply Lemma 8.3 to produce a genus 2 Heegaard splitting of M in which K is 0-bridge. \square

There can be no White mixed bigon. Otherwise K could be isotoped into $\mathcal{T} \cup N(A_{23})$ which is a solid torus by Claim 18.7. As K is hyperbolic and M contains no lens space summand, K is isotopic to a core of $\mathcal{T} \cup N(A_{23})$. But then the core, L , of the solid torus \mathcal{T} is a (2,1)-cable of K . As L is a core of H_B , Claim 8.7 contradicts that $t = 4$.

There cannot be a White (41)-SC by Lemma 18.4. Consequently, there can be no bigon of Λ at a (41)-corner of a vertex in Λ . This prohibits there being 4 parallel edges at a vertex of Λ . Hence by Lemmas 5.11 and 5.13 there must be a special vertex v in Λ . Such a special vertex has at most 5 gaps (counting both trigons and true gaps).

Furthermore, around v there may only be two (23)-corners that have SCs. Otherwise, since $\partial A_{12,34}$ bounds an annulus on \widehat{T} , there would be two edges of G_F that meet a vertex at the same label and are parallel on \widehat{T} . Lemma 12.15 prevents this.

Since $D \subset H_B$ there can be no Black SCs. Otherwise one would give a Möbius band intersecting the separating annulus $A_{12,34}$ transversely in a single arc in \mathcal{T} .

Thus in total, v must have at least Δ gaps at all the (41)-corners and $\Delta - 2$ gaps among the (23)-corners. Since v has at most 5 gaps, it must be the case that $\Delta = 3$. Hence with three gaps at the (41)-corners and one gap at a (23)-corner, either all three (12)-corners have a mixed bigon or all three (34)-corners have a mixed bigon. Yet since their edges must be parallel to the edges of $\partial A_{12,34}$ on \mathcal{T} , there will have to be two edges parallel on \mathcal{T} that meet a vertex at the same label, contrary to Lemma 12.15. \square

Lemma 18.8. *There cannot be three consecutive bigons in Λ .*

Proof. By Proposition 18.5, a triplet of bigons must be two SCs flanking a mixed bigon. But then these two SCs will have the same color and different labels, contrary to Lemma 18.4. \square

Lemma 18.9. *Assume Λ contains an FESC and let h be its SC. Then any bigon in Λ of the same color as h (Black or White) is a SC on the same label pair.*

Proof. WLOG assume there is an FESC as in Figure 41(a). The graph induced by the edges of the FESC is shown abstractly in Figure 41(b). As mentioned above, any face of Λ can be taken to have interior disjoint from \widehat{T} .

First assume $D \subset H_W$. Since the graph of Figure 41(b) lies in \widehat{T} , one of α , β , $\alpha\beta$ bounds a disk in \widehat{T} . It cannot be α since α bounds a Möbius band A_{23} . If it were β then as in Lemma 14.9 we could form bridge disks that guided isotopies of the arcs(12) and (34) onto \widehat{T} so that K would be contained in \mathcal{T} . But then K is isotopic to a core of \mathcal{T} , and K is 0-bridge in the given Heegaard splitting. Thus $\alpha\beta$ bounds a disk E in \widehat{T} .

Let $\mathcal{N} = N((12) \cup (34) \cup f \cup g)$. As shown in Claim 14.2, $\mathcal{N} \cup N(E)$ is a trefoil complement (and the meridian of this trefoil complement is ∂A_{23}). Then $\mathcal{N}' = \mathcal{N} \cup N(E) \cup N(A_{23})$ has incompressible boundary T' . Therefore, by Lemma 8.1, $\mathcal{T}' = M \setminus \mathcal{N}'$ is a solid torus. K intersects \mathcal{T}' in only the arc (41). By Lemma 8.2 (and that K is not locally knotted), $T' - N(K)$ compresses in $\mathcal{T}' - N(K)$ to show that (41) is ∂ -parallel in \mathcal{T}' . ($T' - N(K)$ cannot compress into \mathcal{N}' since that would imply the arc $K \cap \mathcal{N}'$ and hence K is isotopic into \mathcal{T}' . But then T' would be an essential torus in the exterior of K , a contradiction.)

Since α is a primitive curve on \mathcal{N} by Claim 14.2, $\mathcal{N} \cup N(A_{23})$ is a genus 2 handlebody, H'_B . On the other hand, the complement of H'_B is a genus two handlebody, H'_W (the union of \mathcal{T}' and a 1-handle dual to E). As in the proof of Claim 14.8, K can be written as the union of two arcs: (34123), κ . Here κ is $K \cap H'_B$ and is properly isotopic in H'_B to a cocore of the annulus $N(\partial A_{23}) \cap \partial \mathcal{N}$. As ∂A_{23} primitive in \mathcal{N} , κ is a bridge arc in H'_B . On the other hand, the arc (34123) is $K \cap H'_W$ and is properly isotopic in H'_W to (41). As (41) is bridge in \mathcal{T}' , it is bridge in H'_W . Thus K is 1-bridge with respect to a genus 2 splitting of M .

Remark 18.10. This is one of the special cases of the proof of Theorem 2.6. Here M is $n/2$ -surgery on the trefoil (and hence a Seifert fiber space over the 2-sphere

with an exceptional fiber of order 2 and one of order 3.) The argument presents K as 1-bridge with respect to the splitting of M gotten from a genus 2 Heegaard splitting of the trefoil exterior: i.e. remove a neighborhood of the unknotting tunnel from the exterior of the trefoil for one handlebody of the splitting, then the filling solid torus in union with a neighborhood of the unknotting tunnel is the other.

If $D \subset H_B$, then the first part of the argument of Claim 14.8 shows that ∂A_{23} is longitudinal in \mathcal{T} . Thus $\mathcal{N}' = \mathcal{T} \cup N(A_{23})$ is a solid torus. Let l be a bigon of Λ of the same color as h , that is a White bigon. If l is a mixed bigon, then l guides an isotopy of K into the solid torus \mathcal{N}' . As K is hyperbolic and M contains no lens space summand, K can be isotoped to be a core of \mathcal{N}' . But the core, L , of \mathcal{T} is a $(2,1)$ -cable of K (in \mathcal{N}'). As L is a core of H_B , Claim 8.7 contradicts that $t = 4$. Thus l cannot be a mixed bigon. By Lemma 18.4, l must be a SC on the same label pair as h . \square

Theorem 18.11. *In SITUATION SCC, $t \neq 4$.*

Proof. By Lemma 18.8, Λ cannot have a triple of bigons. Hence by Lemma 5.11 there must be a special vertex v in Λ . By Lemma 5.13, such a special vertex has at most 5 gaps (counting both trigons and true gaps). That is, there are at most 5 corners at v that do not belong to bigons of Λ . Furthermore v must be of type $[8, 1]$ with $\Delta = 3$ or type $[7, 4]$ with $\Delta = 3$, else it must have a triple of bigons.

If the special vertex v has type $[7, 4]$, then there are five gaps. Having no triple of bigons implies there must be at least two instances of adjacent bigons flanked by gaps. First assume there is no sequence TBBT at v (notation as described at the beginning of section 13). Then there must be a TBBGBT. Lemmas 18.4 and 18.9 force this to be TSMGMST. Again applying Lemmas 18.4 and 18.9, we must have TTSMGMSTT. But then there is a triple of bigons at v , contradicting Lemma 18.8. So assume there is a sequence TBBT at v . By Lemmas 18.4 and 18.9, we may assume we have TMSTg, where the MST is an FESC. There must be at least two more bigon pairs, BB. In particular there must be a sequence gBBgBBg, possibly including part of the above sequence. As argued above, the existence of the FESC forces ggSMgMSgg and hence a triple of bigons, a contradiction.

If the special vertex has type $[8, 1]$, then there are four gaps. Having no triple of bigons implies that the gaps occur at every third corner separating four pairs of adjacent bigons. There is now no way to label these bigons without violating Lemma 18.4. \square

APPENDIX A. SMALL SEIFERT FIBER SPACES CONTAINING A DYCK'S SURFACE.

This appendix proves Theorem A.2, which restricts the small Seifert fiber spaces containing a Dyck's surface.

In what follows a *surface* will always be connected.

Definition A.1. $M = S^2(s_1/t_1, s_2/t_2, s_3/t_3)$ is defined as follows. Let $\widetilde{M} = S^1 \times F$ where F is a pair of pants. An orientation on each of the factors induces coordinates (s, t) where s is the number of times around the S^1 factor. To each component of $\partial \widetilde{M}$ attach a solid torus T_i so that the meridian of T_i is identified with the curve (s_i, t_i) . The resulting manifold is M . \widetilde{M} is a circle bundle, $p : \widetilde{M} \rightarrow F$. M is a Seifert fiber space over S^2 where each T_i is a neighborhood of an exceptional fiber of order t_i .

Theorem A.2. *Let M be a SFS over the 2-sphere with three exceptional fibers. If M contains an incompressible Dyck's surface, then either*

- (A) $M = S^2(2/p_1, 2/p_2, 2/p_3)$ where each p_i is an odd integer; or
- (B) one of the exceptional fibers of M has order 2 and a second has order which is a multiple of 4; or
- (C) M has exceptional fibers of order 2 and 3. In fact, M is $(2/n)$ -surgery on a trefoil knot; or
- (D) M has two exceptional fibers of order 2. In this case M contains a Klein bottle; or
- (E) M has two exceptional fibers of order 3.

Remark A.3. The Teragaito examples are in $S^2(-1/2, 1/6, 2/7)$, which by the above does not contain a Dyck's surface.

Proof. Let K be an incompressible Dyck's surface in M . Theorem 2.5 of [14] shows that K can be isotoped to be either pseudovertical or pseudohorizontal. K is said to be *pseudovertical* if $\tilde{K} = K \cap \tilde{M}$ is a vertical annulus whose boundary lies in distinct components of $\partial\tilde{M}, \partial T_i, \partial T_j$; furthermore, $K \cap T_i$ and $K \cap T_j$ are one-sided incompressible surfaces in T_i and T_j . K is said to be *pseudohorizontal* if $K \cap \tilde{M}$ is horizontal under the circle fibration and K intersects each of T_1, T_2, T_3 in either a family of meridian disks or in a one-sided incompressible surface. Note that by Corollary 2.2 of [14], a one-sided incompressible surface in a solid torus has a single boundary component. \square

Claim A.4. *If K is pseudohorizontal then one of the conclusions to Theorem A.2 holds.*

Proof. Assume K is pseudohorizontal. Then $p : \tilde{K} \rightarrow F$ is a cover of index $\lambda \geq 1$. Note that λ is the intersection number of \tilde{K} with any circle fiber of \tilde{M} .

Assume $\lambda = 1$. Then a component c of $\partial\tilde{K}$ would intersect the Seifert fiber in the neighborhood of the corresponding exceptional fiber once. This immediately implies that c does not bound a meridian of that solid torus neighborhood. Thus K intersects the neighborhood of an exceptional fiber in a single one-sided incompressible surface. As the Euler characteristic of K is -1 , it must be that K intersects the neighborhood of each of the exceptional fibers of M in a Möbius band. As \tilde{K} is a section for the circle bundle we can use it to define the product structure on \tilde{M} . This gives coordinates on the boundary of each exceptional fiber so that $\tilde{K} \cap \partial T_i$ is $(0, 1)$ and the circle fiber (which is the Seifert fiber of M) is $(1, 0)$. As $K \cap T_i$ is a Möbius band, its boundary must intersect the meridian of the solid torus twice. Thus in these coordinates, the meridian is $(2, p_i)$ where $|p_i|$ is the order of the exceptional fiber (and odd). Thus $M = S^2(2/p_1, 2/p_2, 2/p_3)$ and we have conclusion (A) above.

Assume $\lambda > 1$. As K is 1-sided it cannot intersect all of the T_i in disks. On the other hand, since \tilde{K} is a λ -fold cover of the pair of pants F , it must have Euler characteristic $-\lambda$. Thus K must intersect some T_i in disks.

Assume first that K intersects only T_1 in disks. Let $r \leq 0$ be the sum of the Euler characteristics of the one-sided surfaces $K \cap T_2, K \cap T_3$. Then $-1 = \chi(K) = -\lambda + \lambda/p + r$ where p is the order of the singular fiber at T_1 . This implies that $r = 0$ and $\lambda(p - 1) = p$. As λ is a multiple of p , this implies that $\lambda = p = 2$. But then we

conclude that \tilde{K} has exactly three boundary components and Euler characteristic -2 . This implies that \tilde{K} is non-orientable. But \tilde{K} covers the orientable F .

So assume K intersects T_1, T_2 in disks and T_3 in a 1-sided surface with Euler characteristic $r \leq 0$. Let p_1, p_2 be the orders of the singular fibers of T_1, T_2 . Then we have the following equality (*): $-1 = \chi(K) = -\lambda + \lambda/p_1 + \lambda/p_2 + r$.

Claim A.5. *One of the following must hold.*

- (1) $r = -1$ and $p_1 = p_2 = 2$; or
- (2) $r = 0$, $p_1 = 2, p_2 = 3$, and $\lambda = 6$; or
- (3) $r = 0$, $p_1 = 2, p_2 = 4$, and $\lambda = 4$; or
- (4) $r = 0$, $p_1 = 3 = p_2$, and $\lambda = 3$.

Proof. Noting that λ is a multiple of both p_1 and p_2 , define the natural numbers $e_1 = \lambda/p_1, e_2 = \lambda/p_2$.

Assume that $r \leq -1$. Then (*) implies that $p_1 p_2 \leq p_1 + p_2$, hence $p_1 = p_2 = 2$ and $r = -1$, giving conclusion (1).

We hereafter take $r = 0$. WLOG assume $p_2 \geq p_1$ and hence $e_1 \geq e_2$.

First assume $p_1 > 2$. Then $2e_1 < \lambda = e_1 + e_2 + 1$ from (*); hence, $e_1 < e_2 + 1$. Thus $e_1 = e_2, p_1 = p_2$. Then (*) becomes $\lambda((p_1 - 2)/p_1) = 1$ or that $e_1(p_1 - 2) = 1$. This gives conclusion (4) above.

So assume $p_1 = 2$. Then we get that $e_2(p_2 - 2) = 2$. This means that either $e_2 = 2, p_2 = 3, \lambda = 6$ or $e_2 = 1, p_2 = 4, \lambda = 4$. These are conclusions (2) and (3). \square

Lemma A.4 now follows from Claim A.5: Conclusion (1), (2), (3), (4) of Claim A.5 imply conclusions (D), (C), (B), (E) respectively. Note that in conclusion (D), M contains a pseudovertical Klein bottle between the exceptional fibers of order 2. In the context of conclusion (2) of the claim (which is the context of (C) in the Theorem) $X = M - \text{Int}(T_3)$ is the exterior of a trefoil knot and $K \cap X$ is a 1-punctured torus, hence a Seifert surface for X . As T_3 intersects K in a Möbius band, the meridian of T_3 intersects the boundary of this Seifert surface twice. Hence M is an $(2/n)$ -filling of X as claimed. \square

Claim A.6. *If K is pseudovertical then conclusion (B) of Theorem A.2 holds.*

Proof. Assume K is pseudovertical. As $\chi(K) = -1$, K is the union of a vertical annulus \tilde{K} and a Möbius band K_1 in T_1 (say) along with a punctured Klein bottle K_2 in T_2 (say).

Now ∂K_1 will intersect the meridian of T_1 twice. As ∂K_1 is a Seifert fiber of M this says that the order of the exceptional fiber at T_1 is 2.

By Corollary 2.2 of [14], a one-sided incompressible surface in a solid torus has boundary a single $(2k, l)$ -curve in longitude, meridian coordinates of the solid torus where k, l are integers and $k > 0$. In [6], a recursive formula is developed for $N(2k, l)$, which, as pointed out in [14], is equal to the cross-cap number of the (unique) 1-sided incompressible surface whose boundary is the $(2k, l)$ -curve. By picking the right longitude, we may assume that $k > l > 0$ in the computation of $N(2k, l)$. Then [6](6.4) shows that $N(2k, l) = 2$ iff k is even. So let ∂K_2 be such a $(2k, l)$ curve in T_2 . Then $2 = N(2k, l)$ and k is even. As ∂K_2 is a Seifert fiber for M , this implies that the exceptional fiber for T_2 has order $2k$ with k even.

Thus M is as in (B) of the Theorem A.2. \square

REFERENCES

1. Kenneth L. Baker, *Small genus knots in lens spaces have small bridge number.*, *Algebr. Geom. Topol.* **6** (2006), 1519–1621 (electronic).
2. Kenneth L. Baker, Cameron McA. Gordon, and John Luecke, *Bridge number, Heegaard genus, and non-integral Dehn surgery*, arXiv:1202.0263v1 [math.GT]
3. Kenneth L. Baker, Cameron McA. Gordon, and John Luecke, *Bridge number and integral Dehn surgery*, preprint.
4. J. Berge, *Some knots with surgeries yielding lens spaces*, unpublished manuscript.
5. S. Boyer and X. Zhang, *On Culler-Shalen seminorms and Dehn filling*, *Ann. of Math.* **148** (1998), 737–801.
6. G. Bredon and J. Wood, *Non-orientable surfaces in orientable 3-manifolds*, *Invent. Math.* **7** (1969), 83–110.
7. A. J. Casson and C. McA. Gordon, *Reducing Heegaard splittings*, *Topology Appl.* **27** (1987), 275–283.
8. J. C. Cha and C. Livingston, *KnotInfo: Table of Knot Invariants*, <http://www.indiana.edu/~knotinfo>, March 7, 2010.
9. Marc Culler, Cameron McA. Gordon, John Luecke, and Peter B. Shalen, *Dehn surgery on knots*, *Bull. Amer. Math. Soc. (N.S.)* **13** (1985), no. 1, 43–45. MR MR788388 (86k:57013)
10. Mario Eudave-Muñoz, *Appendix. On the knots $k(l, m, n, p)$* , 4–page preprint.
11. ———, *Non-hyperbolic manifolds obtained by Dehn surgery on hyperbolic knots*, *Geometric topology* (Athens, GA, 1993), *AMS/IP Stud. Adv. Math.*, vol. 2, Amer. Math. Soc., Providence, RI, 1997, pp. 35–61. MR MR1470720 (98i:57007)
12. ———, *On nonsimple 3-manifolds and 2-handle addition*, *Topology Appl.* **55** (1994) 131–152.
13. George K. Francis, *On knot-spanning surfaces: an illustrated essay on topological art*, *The visual mind*, *Leonardo Book Ser.*, MIT Press, Cambridge, MA, 1993, pp. 57–64. MR MR1255839
14. C. Frohman, *One-sided incompressible surfaces in Seifert fibered spaces*, *Topology Appl.* **23** (1985), 103–116.
15. David Gabai, *Foliations and the topology of 3-manifolds. III*, *J. Differential Geom.* **26** (1987), no. 3, 479–536. MR MR910018 (89a:57014b)
16. Hiroshi Goda and Masakazu Teragaito, *Dehn surgeries on knots which yield lens spaces and genera of knots*, *Math. Proc. Cambridge Philos. Soc.* **129** (2000), no. 3, 501–515. MR MR1780501 (2001g:57011)
17. Cameron McA. Gordon, *Combinatorial methods in Dehn surgery*, *Lectures at KNOTS '96* (Tokyo), *Ser. Knots Everything*, vol. 15, World Sci. Publishing, River Edge, NJ, 1997, pp. 263–290. MR MR1474525 (98m:57020)
18. Cameron McA. Gordon and R.A. Litherland, *Incompressible planar surfaces in 3-manifolds*, *Topology Appl.* **18** (1984), no. 2-3, 121–144. MR MR769286 (86e:57013)
19. ———, *Incompressible surfaces in branched coverings*, *The Smith Conjecture*, Eds. J.W. Morgan and H. Bass, Academic Press, Inc, 1984, 139–152.
20. Cameron McA. Gordon and John Luecke, *Only integral Dehn surgeries can yield reducible manifolds*, *Math. Proc. Cambridge Philos. Soc.* **102** (1987), no. 1, 97–101. MR MR886439 (89a:57003)
21. ———, *Knots are determined by their complements*, *J. Amer. Math. Soc.* **2** (1989), no. 2, 371–415.
22. ———, *Dehn surgeries on knots creating essential tori. I*, *Comm. Anal. Geom.* **3** (1995), no. 3-4, 597–644. MR MR1371211 (96k:57003)
23. ———, *Dehn surgeries on knots creating essential tori. II*.
24. ———, *Non-integral toroidal Dehn surgeries*, *Comm. Anal. Geom.* **12** (2004), no. 1-2, 417–485. MR MR2074884 (2005k:57013)
25. W. Haken, *Some results on surfaces in 3-manifolds*, *Studies in Modern Topology* (Math. Assoc. Amer., distributed by: Prentice-Hall, 1968), 34–98.
26. A.E. Hatcher, *On the boundary curves of incompressible surfaces*, *Pacific J. Math.* **99** (1982), 373–377.
27. J. Hempel, *3-manifolds as viewed from the curve complex*, *Topology* **40** (2001), 631–657.

28. Tsuyoshi Kobayashi, *Structures of the Haken manifolds with Heegaard splittings of genus two*, Osaka J. Math. **21** (1984), 437–455.
29. M. Lackenby and R. Meyerhoff, *The maximal number of exceptional Dehn surgeries*, arXiv:0808.1176v1 [math.GT]
30. Y.N. Minsky, Y. Moriah and S. Schleimer, *High distance knots*, Alg. Geom. Top. **7** (2007), 1471–1483.
31. Yoav Moriah and J. Hyam Rubinstein, *Heegaard structures of negatively curved manifolds*, Communications in Analysis and Geometry **5** (3) (1997), 375–412.
32. K. Morimoto, M. Sakuma and Y. Yokota, *Identifying tunnel number one knots*, J. Math. Soc. Japan **48** (1996), 667–688.
33. Yo'av Rieck, *Heegaard structures of manifolds in the Dehn filling space*, Topology **39** (2000), no. 3, 619–641. MR MR1746912 (2001b:57037)
34. Y. Rieck and E. Sedgwick, *Finiteness results for Heegaard surfaces in surgered manifolds*, Comm. Anal. Geom. **9** (2001), 351–367.
35. ———, *Persistence of Heegaard structures under Dehn filling*, Topology Appl. **109** (2001), 41–53.
36. Martin Scharlemann, *Local detection of strongly irreducible Heegaard splittings*, Topology Appl. **90** (1998), no. 1-3, 135–147. MR MR1648310 (99h:57040)
37. Martin Scharlemann and Ying Qing Wu, *Hyperbolic manifolds and degenerating handle additions*, J. Austral. Math. Soc. Ser. A **55** (1993), no. 1, 72–89. MR MR1231695 (94e:57019)
38. M. Teragaito, *A Seifert fibered manifold with infinitely many knot-surgery descriptions*, Int. Math. Res. Not. **2007**, no. 9, Art. ID rnm028, 16 pp.
39. Abigail Thompson, *The disjoint curve property and genus 2 manifolds*, Topology Appl. **97** (1999), no. 3, 273–279. MR MR1711418 (2000h:57015)
40. ———, *Thin position and bridge number for knots in the 3-sphere*, Topology **36** (1997), no. 2, 505–507. MR MR1415602 (97m:57013)
41. M. Tomova, *Distance of Heegaard splittings of knot complements*, Pacific J. Math. **236** (2008), 119–138.
42. Hale F. Trotter, *Non-invertible knots exist*, Topology **2** (1963), 275–280. MR MR0158395 (28 #1618)

DEPARTMENT OF MATHEMATICS, UNIVERSITY OF MIAMI, CORAL GABLES, FL 33146
E-mail address: kb@math.miami.edu

DEPARTMENT OF MATHEMATICS, THE UNIVERSITY OF TEXAS AT AUSTIN, AUSTIN, TX 78712
E-mail address: gordon@math.utexas.edu

DEPARTMENT OF MATHEMATICS, THE UNIVERSITY OF TEXAS AT AUSTIN, AUSTIN, TX 78712
E-mail address: luecke@math.utexas.edu