

SEMIFLOWS INDUCED BY LENGTH METRICS: ON THE WAY TO EXTINCTION

ÁLVARO MARTÍNEZ-PÉREZ AND MANUEL A. MORÓN

ABSTRACT. Bing and Moise proved, independently, that any Peano continuum admits a length metric d . We treat non-degenerate Peano continua with a length metric as evolution systems instead of stationary objects. For any compact length space (X, d) we consider a semiflow in the hyperspace 2^X of all non-empty closed sets in X . This semiflow starts with a canonical copy of the Peano continuum (X, d) at $t = 0$ and, at some time, collapses everything into a point. We study some properties of this semiflow for several classes of spaces, manifolds, graphs and finite polyhedra among them.

CONTENTS

1.	Introduction	1
2.	Preliminaries	3
3.	Definition and basic properties of the semiflow	6
4.	Topological robustness of length spaces: examples and counterexamples	9
5.	The semiflow for finite metric graphs.	16
6.	\mathbb{R} -trees: geometrical models for the semiflow	34
	References	38

Keywords: Peano continuum, length metric, hyperspace, semiflow, dynamical cone.

MSC: Primary: 37B45; 54E35. Secondary: 54B20.

1. INTRODUCTION

Along this paper, X will represent a non-degenerate Peano continuum, that is a connected and locally connected compact metrizable space with more than one point. As known, see the preliminaries, we can always define a geodesic metric in X inducing the original topology.

Let (Y, d) be a compact metric space. The hyperspace of all non-empty closed sets in Y is denoted by 2^Y . The Hausdorff metric, d_H , induced by d on 2^Y is defined to be, given $A_1, A_2 \in 2^Y$,

$$d_H(A_1, A_2) := \max\left\{\sup_{x \in A_1} \{d(x, A_2)\}, \sup_{y \in A_2} \{d(y, A_1)\}\right\},$$

or equivalently,

$$d_H(A_1, A_2) := \inf\{\varepsilon > 0 \mid A_1 \subset B(A_2, \varepsilon) \text{ y } A_2 \subset B(A_1, \varepsilon)\}.$$

2_H^Y represents 2^Y endowed with the Hausdorff metric.

The authors are partially supported by MTM-2009-07030.

Our starting point comes from a result by S. B. Nadler in [19]. Considering a length metric on a Peano continuum X , we define a semiflow in the hyperspace 2_H^X such that for every non-empty compact subset A and every positive t , the image is the generalized closed ball about A of radius t . This semiflow has a global asymptotically stable attractor which is the point $\{X\} \in 2^X$. This attractor is reached from any orbit at a finite time which is at most equal to the diameter of (X, d) . In this sense we say that this evolution system is *extinguishable*.

Our main idea is to consider any non-degenerate Peano continuum X with a length metric d as an extinguishable evolution system instead of an stationary object. By this way many natural questions appear. In this paper we get only few answers and some adequate examples.

In this semiflow any point $x \in X$, considered as a unitary closed subset of X , evolves following a geodesic in 2_H^X till reaching the point $\{X\} \in 2^X$. This geodesic, which is the trajectory of x , takes values on closed metric balls centered at x . In this sense the canonical copy X inside 2_H^X evolves, with constant speed 1, through the subspace of real closed metric balls till the extinction which is produced just at the time equal to the diameter of (X, d) . Then from time $t = 0$ to $t = \text{diam}(X)$ we pass from an isometric copy of (X, d) to a trivial space (i.e. a single point) through geodesics. Consequently, many questions naturally arise. For example, how many different topological types (homotopy types) of spaces appear throughout the evolution till the extinction? Since any point in the canonical copy is moving along a geodesic, a general principle is in order:

The whole canonical copy is moving under a minimum energy principle till the extinction.

What does this principle imply regarding the topological types (homotopy types, etc.) you have to reach in the evolution? Specifically, for each time $t \in [0, \text{diam}(X)]$ the semiflow converts the canonical copy X into the space X_t which is the subspace of all closed balls with radius t with the Hausdorff metric. How are topologically (homotopically, etc.) related X to X_t ? Note that $X_0 = X$ and $X_{\text{diam}(X)}$ is a point. What kind of properties of (X, d) are *positively invariant* under the action of the semiflow? A property P is said to be positively invariant when if X has P , this implies X_t has P for all $t > 0$. Obviously, the property of being a Peano continuum is positively invariant.

Another interesting question is to detect what kind of properties are *Weierstrass-type* for the evolution induced by the semiflow. Without treating to give an exhaustive definition of this terminology, we recall that the classical Weierstrass Theorem in Real Analysis, later extended to Topology, asserts that any continuous real function on a closed finite real interval is bounded and it attains its maximal and minimum value. Think about the semiflow as a *continuous* function $t \rightarrow X_t$ defined on the real interval $[0, \text{diam}(X)]$. Any consistent definition of a property P to be *bounded* for the evolution should imply that if the semiflow reach only a finite number of different P -type then P has to be bounded.

Associated to the above paragraphs, there is also a problem on the stability of the topological type of the canonical copy (X, d) . This problem is related to the existence of a positive time ε_0 such that the semiflow behaves like a flow in the subspace of closed balls for $t \in [0, \varepsilon_0)$. This is a kind of parallelizability property of the semiflow near $t = 0$. It is equivalent to a very natural geometric question: If (X, d) is a Peano continuum with a geodesic metric, is it true that there is

a positive real ε_0 such that each closed ball of radius lower than ε_0 determines univocally its center? We call this property as the *topological robustness* of (X, d) . It is obviously invariant by isometries. We show that this property strongly depends on the (metric) geometry of (X, d) and not on the topology of X . In fact we give an example of bilipschitz homeomorphic pairs, one of them being topologically robust and the other not.

After some preliminaries we describe, in Section 3, the semiflow and some of its basic properties. The main element is what we call the *dynamical cone* of (X, d) which is just a dynamical view of the subspace of closed balls with the Hausdorff metric. Using this we give a homological model of the evolution. We introduce a Lyapunov function for the semiflow which plays the role of a potential function on the canonical copy. It allows us to define *centers*, as points of minimal energy, and *extremes*, as points of maximal energy. Some examples are provided.

In section 4 we focus on topological robustness giving some positive and negative results. We also give an example of a compact geodesic space that has to pass through countable many different topological type before the extinction, although the homotopy type remains constant.

In section 5, we prove that being, topologically, a finite graph is a positively invariant property for the semiflow as it is also being a finite tree. We study the semiflow for finite graphs with natural geodesic metrics in some depth. We prove that, in this case, the topological properties of the levels for the semiflow are all *bounded* in the sense that the canonical copy only goes through a finite number of topological types until the extinction. This means that in the framework of finite metric graphs all the topological properties are *Weierstrass-type* properties. This gives some meaning to our minimum energy principle. We also put examples that prevent on the monotonicity on the changes of topological types in the sense that our example is a graph with the homotopy type of a 1-sphere and on the way to extinction it has to pass through the homotopy type of the figure eight.

In Section 6 we point out that the Whitney functions in hyperspaces are intrinsically related to Lyapunov functions for the semiflow. Using this we give some geometric model for the semiflow in terms of geodesically complete \mathbb{R} -trees and their corresponding end spaces and give a characterization of the topological robustness.

The work in this paper can be extended to the non-compact case by considering complete connected proper metric spaces and the hyperspace of compact subsets with the Hausdorff metric.

2. PRELIMINARIES

To avoid introducing too many concepts which are unnecessary for this work, we are going to introduce length spaces in a very restricted way. Thus, instead of talking about length structures, in which we must fix a set of admissible paths and a measure for them, see [4], we are going to start with a metric space and consider the length structure induced by the metric when all the paths are admissible. For the general framework of length spaces we also follow [3].

Definition 2.1. *Let (X, d) be a metric space. The length $l(c)$ of a path $c : [a, b] \rightarrow X$ is*

$$l(c) = \sup_{a=t_0 \leq t_1 \leq \dots \leq t_n = b} \sum_{i=0}^{n-1} d(c(t_i), c(t_{i+1})),$$

where the supremum is taken among all possible partitions of the interval $a = t_0 \leq t_1 \leq \dots \leq t_n = b$.

Definition 2.2. Let (X, d) be a metric space. d is a length metric if the distance between every pair of points $x, y \in X$ is equal to the infimum of the lengths of the paths joining them. (If there is not such a path then $d(x, y) = \infty$). If d is a length metric, then (X, d) is called length space.

Definition 2.3. Let (X, d) be a metric space. A geodesic path from $x \in X$ to $y \in X$ is a map c from a closed interval $[0, l] \subset \mathbb{R}$ to X such that $c(0) = x$, $c(l) = y$ and $d(c(t), c(t')) = |t - t'| \forall t, t' \in [0, l]$. In particular, $l = d(x, y)$. The image of c is called geodesic segment with endpoints x and y and it is denoted as $[x, y]$. When the context is clear, we may abuse of the notation and refer to the geodesic segment simply as geodesic.

Definition 2.4. If X is a metric space such that for every pair of points there is a geodesic path joining them, then X is said to be geodesic.

In general, not every length space is geodesic. Let us consider, for example, the euclidean plane without the origin. In this case, there is no path from x to its symmetric with respect to the origin, $-x$, with length $d(x, -x)$, although it is clear that there are paths between them whose length is as close to that distance as we want.

Next result was proved, independently, by R. H. Bing and E. Moise, in [2] and [18] respectively, in 1949.

Theorem 2.5 (Bing and Moise). *Every Peano continuum (X, τ) admits a metric d such that (X, τ) and (X, d) are homeomorphic and (X, d) is a length space.*

The following is a slightly weak version for length spaces of the Hopf-Rinow theorem (see [10]). It is also known as Hopf-Rinow-Cohn-Vossen Theorem, see [4, Theorem 2.5.28].

Proposition 2.6. [3, Proposition 3.7] *Let X be a length space. If X is complete and locally compact, then:*

- (1) *Every closed bounded set of X is compact;*
- (2) *X is a geodesic space.*

Remark 2.7. *In this work we are dealing with geodesic compact spaces. Notice that, using the results above, we may consider on any Peano continuum a metric for which the space is geodesic.*

Notice that the existence of a geodesic path doesn't mean that it should be unique.

Example 2.8. *Consider the graph from Figure 1 with the natural metric where every edge has length 1.*

As we can see, there are two geodesic paths (of length 2) joining x to y .

For the next basic definitions and properties we follow the book from Bhatia and Szegő, [1].

Definition 2.9. *A dynamical system on X is the triplet (X, \mathbb{R}, π) where π is a map from the product space $X \times \mathbb{R}$ into X satisfying the following axioms:*

- (i) $\pi(x, 0) = x \quad \forall x \in X$

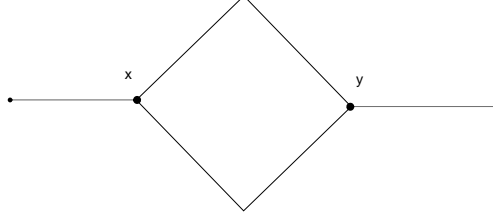

FIGURE 1. The geodesic path joining two points need not be unique.

- (ii) $\pi(\pi(x, t), s) = \pi(x, t + s)$ for every $x \in X$ and $t, s \in \mathbb{R}$.
- (iii) π is continuous.

For any point $x \in X$, $\pi(\pi(x, t), -t) = x$. From this, it is readily seen the following result.

Proposition 2.10. *For every $t \in \mathbb{R}$, the map $\pi_t : X \rightarrow X$ defined by $\pi_t(x) = \pi(x, t)$ is a homeomorphism of X in itself. \square*

Let $\Lambda^+(x) := \{y \in X \mid \text{there is a sequence } \{t_n\} \text{ in } \mathbb{R} \text{ with } t_n \rightarrow +\infty \text{ and } \pi(x, t_n) \rightarrow y\}$.

$$A(M) := \{x \in X \mid \Lambda^+(x) \neq \emptyset \text{ and } \Lambda^+(x) \cap M \neq \emptyset\}.$$

Definition 2.11. *A set M is positively invariant if for every $x \in M$ and every $t > 0$, $\pi(x, t) \in M$.*

Definition 2.12. *A set M is said to be stable if every neighbourhood U of M contains a positively invariant neighbourhood V of M .*

Definition 2.13. *A set M is an attractor if $A(M)$ is a neighbourhood of M .*

Definition 2.14. *A set M is said to be asymptotically stable if it is stable and an attractor.*

Lyapunov functions.

Theorem 2.15. [1, Chapter V, Theorem 2.2] *A compact $M \subset X$ is asymptotically stable if and only if there exist a real valued continuous function, Φ , defined in a neighbourhood N of M such that:*

- (i) $\Phi(x) = 0$ if $x \in M$ and $\Phi(x) > 0$ if $x \notin M$;
- (ii) $\Phi(x, t) < \Phi(x)$ for $x \notin M$, $t > 0$ and $x[0, t] \subset N$.

Definition 2.16. *This function Φ is a Lyapunov function on N for π .*

Semidynamical systems.

Let us denote by \mathbb{R}^+ the interval $[0, \infty)$ in the real line.

Definition 2.17. A semidynamical system on X is a triplet (X, \mathbb{R}^+, π) where π is a map from the product space $X \times \mathbb{R}^+$ into X satisfying the following axioms:

- (i) $\pi(x, 0) = x \quad \forall x \in X$
- (ii) $\pi(\pi(x, t), s) = \pi(x, t + s)$ for every $x \in X$ and $t, s \in \mathbb{R}^+$.
- (iii) π is continuous.

Remark 2.18. Since the action of \mathbb{R}^+ is not reversible as in the case of dynamical systems, the behavior of the trajectories, $\{\pi_x(t) : t \in \mathbb{R}^+\}$, in the semiflow is substantially different. Thus, contrary to the case shown in 2.10, the map $\pi_t : X \rightarrow X$ defined by $\pi_t(x) = \pi(x, t)$ need not be a homeomorphism. Nevertheless, the definitions above referred to properties when $t \rightarrow +\infty$ as stable, asymptotically stable or attractor, work as well for semidynamical systems.

Example 2.19. Consider $X = [0, 1]$ and $\pi(x, t) = \min\{x + t, 1\}$. Clearly, this is a semidynamical system but for $t \geq 1$, $\pi(x, t) = 1 \quad \forall x \in X$. In fact, 1 is an asymptotically stable set for this semiflow.

3. DEFINITION AND BASIC PROPERTIES OF THE SEMIFLOW

The basic concepts used below can be found in [20].

Let (X, d) be a compact length space. Since X is compact, the closed subsets are compact and $2^X = \{A \subset X \mid A \text{ nonempty and compact}\}$. As we mentioned in the introduction, 2_H^X represents 2^X with the Hausdorff metric.

Consider the map $\pi : 2_H^X \times [0, \infty) \rightarrow 2_H^X$ such that for any compact set A and any $t \geq 0$, $\pi(A, t) := B^c(A, t) = \{x \in X : d(x, A) \leq t\}$, this is, the generalized closed ball in X about A of radius t . We understand that $B^c(A, 0) = A$.

Proposition 3.1. The triplet $(2_H^X, \mathbb{R}_+, \pi)$ defines a semidynamical system. \square

The proof can be found in [19] although with a different language.

Note that when X is a length space any generalized closed ball is the closure of the generalized open ball, $B^c(A, \varepsilon) = \bar{B}(A, \varepsilon)$. Let us refer to $\partial \bar{B}(A, \varepsilon) = \partial B(A, \varepsilon) = S(A, \varepsilon) = \{z \in X \mid d(z, A) = \varepsilon\}$ as the *border* of the ball and its points as *border points*. From now on, we will denote the closed ball as $\bar{B}(A, \varepsilon)$.

Remark 3.2. Since X is a compact metric space, for any $A \subset X$ there exists some t_A such that for every $t \geq t_A$, $\bar{B}(A, t) = X$ and therefore, $\pi(A, t) = \{X\} \in 2^X$.

Let us state a few basic properties about the hyperspace in relation to this map.

Lemma 3.3. Let X be a compact connected length space, $A \subset X$ and $0 < \varepsilon_0 < \varepsilon_1$ such that $\bar{B}(A, \varepsilon_0) \neq X$. Then $\bar{B}(A, \varepsilon_0) \subsetneq \bar{B}(A, \varepsilon_1)$.

Proof. Otherwise, let us suppose that $\bar{B}(A, \varepsilon_0) = \bar{B}(A, \varepsilon_1)$. Let $\delta = \frac{1}{2}(\varepsilon_0 + \varepsilon_1)$, $\bar{B}(A, \varepsilon_0) \subset B(A, \delta) \subset \bar{B}(A, \delta) \subset \bar{B}(A, \varepsilon_1)$ and all those balls coincide. Therefore, there is a proper subspace which is open and closed. This contradicts the fact that X is connected. \square

Proposition 3.4. For every $\varepsilon < \text{diam}(X)$, $P(\varepsilon, X) := \{A \subset X \mid A \text{ closed and } \text{diam}(A) \geq \varepsilon\}$ is a neighborhood of $\{X\}$ in 2_H^X .

Proof. Let $\delta < \frac{\text{diam}(X) - \varepsilon}{2}$. Consider any closed subset $A \subset X$ such that $d_H(A, X) < \delta$. Since X is compact there are two points $x, y \in X$ such that $d(x, y) = \text{diam}(X)$. Then, $d(x, A), d(y, A) \leq \delta$ implies that $\text{diam}(A) \geq \text{diam}(X) - 2\delta > \varepsilon$ and $A \in P(\varepsilon, X)$. \square

Proposition 3.5. $\forall \varepsilon < \text{diam}(X)$ there exists a strong deformation retraction from 2_H^X onto $P(\varepsilon, X)$.

Proof. For every closed subset $A \subset X$ there exists some $t_A \geq 0$ such that $t_A := \inf\{t \mid \text{diam}(\bar{B}(A, t)) \geq \varepsilon\}$. If $\text{diam}(A) \geq \varepsilon$ consider $t_A = 0$. The assignment $A \mapsto t_A$ defines a continuous real function on 2_H^X because of the continuity of the diameter function. Let us define the homotopy $G : 2_H^X \times I \rightarrow 2_H^X$ as follows: $G(A, t) = \bar{B}(A, \min\{t \cdot \text{diam}(X), t_A\}) = \pi(A, \min\{t \cdot \text{diam}(X), t_A\})$. G is continuous, G_0 is the identity, $G_1(2_H^X) \subset P(\varepsilon, X)$ and $G_t|_{P(\varepsilon, X)}$ is the identity. \square

Suppose always that (X, d) is a non-degenerate Peano continuum with a geodesic metric. It is clear that the points in the trajectories of the semiflow π , going from single points $\{x\} \in 2^X$ to the whole space $\{X\} \in 2^X$, are always closed balls centered at points. Hence, if we restrict π to the subspace $\mathcal{B} \subset 2^X$ of all closed balls centered at points of X we still have a semiflow.

Proposition 3.6. *The subspace \mathcal{B} of 2^X (or $C(X)$) is positively invariant for the semiflow π and it is closed in 2_H^X (or $C(X)$) with the Hausdorff metric. Moreover, it is contractible and the canonical copy, considered as the subset of closed balls of radius zero, is a Z -set inside \mathcal{B} in the sense that the identity in \mathcal{B} is uniformly approximated by maps missing X .*

Proof. Given a ball $\bar{B}(x, \varepsilon)$ and a non-negative real number t , we have

$$\pi(\bar{B}(x, \varepsilon), t) = \pi(x, \varepsilon + t) = \bar{B}(x, \varepsilon + t).$$

Since $\mathcal{B} = \pi(X \times [0, \text{diam}(X)])$, then it is compact. Moreover $\pi : \mathcal{B} \times [0, \text{diam}(X)] \rightarrow \mathcal{B}$ defines a strong deformation retraction from \mathcal{B} to the point $\{X\} \in 2^X$ representing the whole space. The sequence of maps $\pi_n : \mathcal{B} \rightarrow \mathcal{B}$, defined by $\pi_n(B) = \pi(B, \frac{1}{n})$ converges uniformly to the identity. Moreover $\pi_n(\mathcal{B}) \cap X = \emptyset$. \square

Thus, the semiflow in \mathcal{B} takes the isometric copy of the original metric space (given by the single points with the Hausdorff metric in the Hyperspace) to the point $\{X\}$ as we saw in 3.2.

For obvious reasons we call \mathcal{B} the *dynamical cone* of (X, d) .

Further questions the space \mathcal{B} naturally arise. For example, its topological dimension, local properties, when is it an absolute retract?, etc. We are not going to follow this line herein. We will probably do it in a future work.

Homological model for the semiflow.

We use the book of Hatcher, [9], for undefined concepts and notations related to homology. Let us denote by X_0 the canonical copy of X inside 2_H^X and by $[X_0, X_t]$ the set $\pi(X_0 \times [0, t])$. Note that

$$[X_0, X_t] = \{A \in 2^X \mid \exists \varepsilon \in [0, t], x \in X_0 \text{ with } A = \bar{B}(x, \varepsilon)\}.$$

The following is clear

Proposition 3.7. *The semiflow π induces a strong deformation retraction from $[X_0, X_t]$ onto X_t . Concretely*

$$G : [X_0, X_t] \times [0, 1] \rightarrow [X_0, X_t] \text{ defined by } G(\bar{B}(x, \varepsilon), s) = \bar{B}(x, (1-s)\varepsilon + st)$$

is a strong deformation retraction onto X_t .

So, the singular relative homology groups $H_n([X_0, X_t], X_0)$ measure the difference between the homology of the semiflow at time t , because $H_n([X_0, X_t])$ is isomorphic to $H_n(X_t)$, and the homology of the initial condition X_0 .

Given a compact geodesic space (X, d) and for every natural number n we can define a transformation

$$H_n : [0, \text{diam}(X)] \longrightarrow \text{AbGroups} \text{ defined by } H_n(t) = H_n([X_0, X_t], X_0)$$

which transform non-negative real numbers into abelian groups. The long exact sequence for relative singular homology and the fact that $[X_0, X_{\text{diam}(X)}] = \mathcal{B}$ is contractible, allow us to calculate the values at the extremes of the interval.

Proposition 3.8. *For any compact geodesic metric space (X, d) and for every natural number n we have: $H_n(0)$ is the trivial group and $H_n(\text{diam}(X)) \cong \tilde{H}_{n-1}(X)$.*

Once we have the definition of the dynamical cone of a compact geodesic metric space (X, d) , we can define the *dynamical suspension* of (X, d) as the space obtained from the dynamical cone \mathcal{B} by collapsing the canonical copy X_0 of X in \mathcal{B} to a point. The result below detects a similarity of behavior between the dynamical and the usual suspension. The proof relies on the fact that when (X, d) is a topologically robust compact metric geodesic space (see Definition 4.2) then (\mathcal{B}, X_0) is a good pair in the sense of [9].

Proposition 3.9. *Suppose that (X, d) is a topologically robust compact metric geodesic space and denote by \mathcal{S} the dynamical suspension of (X, d) . Then $\tilde{H}_n(\mathcal{S}) \cong \tilde{H}_{n-1}(X)$.*

Order arcs.

Next, let us focus on the trajectories, $\{\pi_A(t) : t \in \mathbb{R}^+\}$, for any $A \in 2^X$.

We will see that from every point in the hyperspace, the trajectory on the semiflow is what is called an order arc from the initial point A to $\{X\}$.

Also, these trajectories are geodesic paths with the Hausdorff metric. This means that we can see the semiflow in the hyperspace as a minimal energy flow in which each point is sent to the global attractor through a minimal path.

We extract the following definitions from [13]

Definition 3.10. *A collection \mathcal{N} of sets is a nest provided that for any $N_1, N_2 \in \mathcal{N}$, $N_1 \subset N_2$ or $N_2 \subset N_1$.*

Definition 3.11. *Let X be a compactum, and let $\mathcal{H} \subset 2^X$. An order arc in \mathcal{H} is an arc, α , in \mathcal{H} such that α is a nest.*

Definition 3.12. *A nest from A_0 to A_1 is a nest, \mathcal{N} such that $A_0, A_1 \in \mathcal{N}$ and $A_0 \subset N \subset A_1$ for all $N \in \mathcal{N}$.*

For any $A \in X$, with X a compact length space (and therefore connected), $N_A = \{\bar{B}(x, \varepsilon) \mid \varepsilon \geq 0\}$ is an order arc and, in particular, a nest from $\{A\}$ to $\{X\}$.

Proposition 3.13. *The trajectories of the semiflow are geodesic paths in the hyperspace with the Hausdorff metric.*

Proof. In general, $\forall A \in \mathcal{H}$, $N_A = \{\bar{B}(A, \varepsilon) \mid \varepsilon \geq 0\}$, the generalized closed balls, defines an order arc. Let $t_A := \inf_{t \geq 0} \{\bar{B}(A, t) = X\}$. Then the path $\alpha_A : [0, t_A] \rightarrow \mathcal{H}$ with $\alpha_A(t) = \bar{B}(A, t)$ is a geodesic path from A to X where $d_H(\alpha_A(t), X) =$

$t_A - t \forall A \in \mathcal{H}$ and $\forall 0 \leq t \leq t_A$. Thus, the trajectories in the semiflow are geodesic paths in the hyperspace with the Hausdorff metric. \square

Lyapunov functions. Since we have a semiflow with a global asymptotically stable attractor, it is natural to define a Lyapunov function for it.

Clearly, $\{X\} \in \mathcal{H}$ is an asymptotically stable equilibrium point for the semiflow.

Following [1], the first step to define a Lyapunov function is to define the map $\Phi(A) = d_H(A, X)$ and then, with some technical work, make it decreasing in the orbits. In this case, it is trivial to check that Φ is already a Lyapunov function and we can avoid the rest of the construction which does not provide any benefits.

Consider Φ , as above, such that $\Phi(A) = d_H(A, X)$. This function, restricted to the isometric copy of X in 2_H^X allows us to define a function that, in some sense, plays the role of a potential on the hyperspace:

$$\Phi|_X : X \rightarrow [m, M] \text{ where } \Phi(x) = d_H(x, X) = \max\{d(x, y) \mid y \in X\}.$$

Note that $M = \text{diam}(X)$ and $m \geq M/2$.

This function yields a decomposition of the space in equipotential subspaces $\{\Phi^{-1}(t) \mid t \in [m, M]\}$.

Remark 3.14. For any isometry $f : X \rightarrow X$ and any $x \in X$, $\Phi(x) = \Phi(f(x))$.

Let us denote as *centers* the points where this function takes the minimum value, $\Phi^{-1}(m)$, and as *extrema* the points where it takes the maximum value, $\Phi^{-1}(M)$.

Example 3.15.

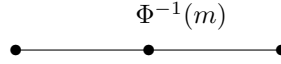

Here, the center is the middle of the segment while the extrema are the end points of the interval.

Example 3.16. Consider the circle: $X = \{e^{2\pi i \cdot x} \mid 0 \leq x < 1\} \subset \mathbb{C}$ with the length metric.

Clearly, $\Phi(x) = \pi \forall x \in X$.

Example 3.17. Let $Q = [0, \frac{1}{n}]^{\mathbb{N}}$, the Hilbert cube, with the l_2 metric.

Then,

$$M = \sum_{n \in \mathbb{N}} \frac{1}{n^2} \text{ and } \Phi^{-1}(M) = \{(x_n) \mid x_n = \{0, \frac{1}{n}\} \forall n\}.$$

while

$$m = \sum_{n \in \mathbb{N}} \frac{1}{4n^2} \text{ and } \Phi^{-1}(m) = \left(\frac{1}{2n}\right).$$

4. TOPOLOGICAL ROBUSTNESS OF LENGTH SPACES: EXAMPLES AND COUNTEREXAMPLES

Let us define $p_\varepsilon : X \rightarrow 2_H^X$ such that $p_\varepsilon(x) := \bar{B}(x, \varepsilon) \forall x \in X$. We already know that at level 0 we have an isometric copy of the space and that there is a level, ε_0 , such that $p_\varepsilon(X)$ is a single point $\forall \varepsilon \geq \varepsilon_0$. The problem is to understand how are

these projections $p_\varepsilon(X)$. The difficulty to give general results comes from the fact that, even for easy examples, the projection might be more complex (topologically or even homotopically) than the original metric space.

Example 4.1. Consider the graph in Figure 2 with the geodesic metric and every edge of length 1.

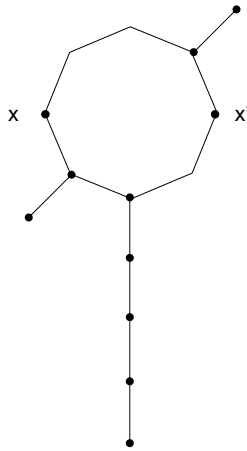

FIGURE 2. The projection need not be homotopically dominated by the original space.

Considering $\varepsilon = 4$, the balls about x and x' coincide and the projection is something homeomorphic to Figure 3:

Definition 4.2. A compact length space (X, d) is topologically robust if there is some ε_0 such that $\forall \varepsilon \leq \varepsilon_0$, p_ε is a topological embedding.

Our first aim is finding conditions on (X, d) to assure that it is topologically robust. As we saw in the introduction, this means that the semiflow π keeps the topological type of X for some time ε_0 . It is clear that if for some $\varepsilon' p_{\varepsilon'} : X \rightarrow 2^X_H$ is a topological embedding then the same holds for $0 \leq \varepsilon \leq \varepsilon'$.

Hyperspaces of Peano continua are Hilbert cubes (see [7]). This implies that there exists an embedding of X as Z -set in the Hilbert cube in such a way that there are homeomorphic copies of X in its complement and as close to X as we want if we consider the hyperspace 2^{2^X} with the Hausdorff metric d_{H^2} .

Remark 4.3. $d_{H^2}(X, p_\varepsilon(X)) = \varepsilon$.

Not every compact connected length space is topologically robust.

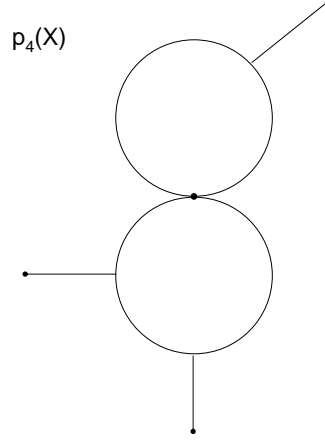

FIGURE 3. Projection of the graph from Figure 2 for $\varepsilon = 4$.

Counterexample 4.4. Consider in the real plane the space:

$$X = \{(x, 0) \mid 0 \leq x \leq 1\} \cup \left\{ \bigcup_{n \in \mathbb{N}} \left\{ \left(\frac{1}{2^n}, y \right) \mid 0 \leq y \leq \frac{1}{2^n} \right\} \right\}$$

with the natural length metric. See Figure 4.

This is a compact connected length space. Then for every $\varepsilon > 0$ let n_0 be such that $\frac{1}{2^{n_0}} < \frac{\varepsilon}{2}$ and consider the points $x = (0, 0)$ and $y = (\frac{1}{2^{n_0}}, \frac{1}{2^{n_0}})$. Clearly $\bar{B}(x, \varepsilon) = \bar{B}(y, \varepsilon)$ and p_ε fails to be injective.

In fact, for every $\varepsilon > 0$, $p_\varepsilon(X)$ is not homeomorphic to X . For every $0 < \varepsilon < \text{diam}(X)$ and $\forall n$ such that $\frac{2}{2^n} \leq \varepsilon$ the geodesic segment $[(2^{-n}, 2^{-n}), (2^{-n}, 0)]$ is identified with the geodesic segment $[(0, 0), (2^{-n}, 0)]$, and it is readily seen that $p_\varepsilon(X)$ is a finite tree.

Notice that, in this example, $M = 2$, $m = 1$, its extrema are the points $\Phi^{-1}(2) = \bigcup_{n \in \mathbb{N} \cup 0} \{(2^{-n}, 2^{-n})\} \cup \{0, 0\}$ and its center is the point $\Phi^{-1}(1) = (1, 0)$.

We take the following definition from [3]. See Definition 3.26 and, explicitly on page 119.

Definition 4.5. Given $r > 0$, a metric space (X, d) is said to be r -uniquely geodesic if for every pair of points x, y with $d(x, y) < r$ there is a unique geodesic segment joining x to y .

Definition 4.6. We define X to be r -perfectly geodesic if it is r -uniquely geodesic and for any three points x_1, x_2, x_3 with $d(x_i, x_j) < r$ if the geodesic segments $[x_1, x_2]$

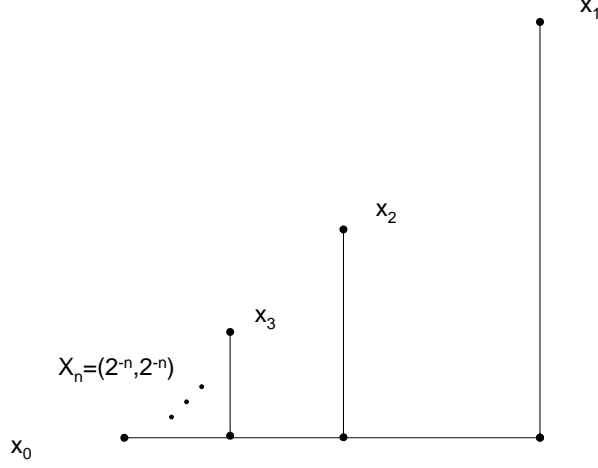

FIGURE 4. Compact length space which is not topologically robust.

and $[x_1, x_3]$ have a common non-trivial interval then one of the geodesic segments is contained in the other.

Remark 4.7. When this property holds, for any x_1, x_2, x_3 with $d(x_i, x_j) < r$, $[x_1, x_2] \cap [x_1, x_3]$ equals $\{x_1\}$, $[x_1, x_2]$ or $[x_1, x_3]$.

Remark 4.8. If X is a length space, $p_\varepsilon : X \rightarrow p_\varepsilon(X)$ is continuous. Since X is compact and $2_{\mathbb{H}}^X$ is Hausdorff (and then, so it is $p_\varepsilon(X)$ for any ε), $p_\varepsilon : X \rightarrow p_\varepsilon(X)$ is a quotient map and $p_\varepsilon(X)$ is homeomorphic to the quotient space X/\sim where two points are related $x \sim y$ if and only if $p_\varepsilon(x) = p_\varepsilon(y)$. Thus, it is trivial that when p_ε is injective, X is homeomorphic to $p_\varepsilon(X)$.

Theorem 4.9. If (X, d) is a r -perfectly geodesic compact length space, then (X, d) is topologically robust.

Proof. As we saw in Remark 4.8, it suffices to check the injectivity. So, let us see that there exists some $\varepsilon_0 > 0$ such that for every pair of points x, y of X , $\bar{B}(x, \varepsilon) \neq \bar{B}(y, \varepsilon) \forall \varepsilon \leq \varepsilon_0$.

Let $\varepsilon := \frac{r}{4}$ and assume $r \ll \text{diam}(X)$. If $d(x, y) > \varepsilon$ it is trivial, so let us suppose $d(x, y) \leq \varepsilon \leq \varepsilon_0$. Consider any point $z \in X$ such that $d(z, x), d(z, y) > r$ (remember that $r \ll \text{diam}(X)$) and, since X is a length space, let z_0 be the point in the geodesic segment $[z, x]$ such that $d(z_0, x) = \frac{r}{2}$. Clearly, $\varepsilon \leq d(z_0, x), d(z_0, y) < r$. Now the geodesic segments $[z_0, x]$ and $[z_0, y]$ are unique and $[z_0, x] \cap [z_0, y]$ may be $[z_0, x]$, $[z_0, y]$ or $\{z_0\}$.

Case 1: if $[z_0, x] \cap [z_0, y]$ is $[z_0, x]$. (If this intersection was equal to $[z_0, y]$ it would be analogous). The geodesic segment $[z_0, y]$ is isometric to a subinterval of the real line $[0, d(z_0, y)]$; let us denote such isometry from the subinterval to the geodesic as $f_{[z_0, y]}$. In this case, there exists some $t \in [0, d(z_0, y)]$ such that $f_{[z_0, y]}(t) = x$ and since $d(z_0, x) \geq \varepsilon$ then clearly $t \geq \varepsilon$.

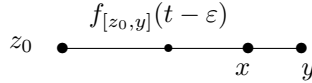

Clearly, the point $f_{[z_0, y]}(t - \varepsilon)$ is in $\bar{B}(x, \varepsilon)$ but it is not in $\bar{B}(y, \varepsilon)$ since the distance to y through this geodesic is obviously $\varepsilon + d(x, y)$ and this distance is less than r which means that this is the unique geodesic from this point to y .

Case 2: if $[z_0, x] \cap [z_0, y]$ is $\{z_0\}$. Assume $d(z_0, x) \leq d(z_0, y)$ and consider z_1 the point in the geodesic segment $[z_0, x]$ such that $d(z_1, x) = \varepsilon$. Clearly, $d(z_1, y) \geq d(z_0, y) - d(z_0, z_1) \geq d(z_0, x) - d(z_0, z_1) = \varepsilon$. If $d(z_1, y) \neq \varepsilon$ then $z_1 \in \bar{B}(x, \varepsilon) \setminus \bar{B}(y, \varepsilon)$ and hence $\bar{B}(x, \varepsilon) \neq \bar{B}(y, \varepsilon)$.

Suppose then that $d(z_1, y) = \varepsilon$. Hence, $[z_0, z_1] \cup [z_1, y]$ has the same length of $[z_0, x]$ and, since $d(z_0, y) \geq d(z_0, x)$, it defines a geodesic from z_0 to y whose intersection with $[z_0, x]$ is $[z_0, z_1]$ and this contradicts the fact that there is a unique geodesic from z_0 to y which must be the one which intersected $[z_0, x]$ just in $\{z_0\}$. \square

Given a connected Riemannian manifold, there is a natural length metric induced by the length piecewise continuously differentiable paths. See [3, I.3].

Corollary 4.10. *If (X, d) is a compact connected Riemannian manifold with its natural length metric, then (X, d) is topologically robust.*

Proof. It is a basic result on Riemannian geometry that every point of a Riemannian manifold lives at the center of a convex ball such that any two points in that ball are joined by a unique geodesic segment contained in the ball. Since it is compact, through the Lebesgue number we can find a global radius r . \square

The following corollary follows from the fact that geodesics in a space of curvature $\geq k$ (with k an arbitrary real number) do not branch. The definitions can be found in [4] where this statement is left as an exercise, see 10.1.2.

Corollary 4.11. *If (X, d) is a locally uniquely geodesic compact length space of curvature bounded bellow, then (X, d) is topologically robust.*

This condition on the geodesics is sufficient but it is not necessary. There are important groups of spaces for which this map would be an embedding and they are not necessarily r -perfectly geodesic, for example trees or finite polyhedra with a length metric. These will be further referred as *polyhedral spaces*. Let us begin by endowing an n -simplex Δ^n with vertices x_0, \dots, x_n with a length metric. Let us consider it as a subspace of \mathbb{R}^{n+1} with $x_{i-1} = \varepsilon_0 e_i$ where e_1, \dots, e_{n+1} is the canonical basis of \mathbb{R}^{n+1} . Therefore, we will say that the n -simplex is endowed the

euclidean metric. Note that if the vertices are $x_{i-1} = \varepsilon_0 e_i$, the edges have length $\sqrt{2} \cdot \varepsilon_0$.

Lemma 4.12. *Let Δ^n be a n -simplex endowed with the euclidean metric d , with vertices x_0, \dots, x_n and suppose length ε for the edges. For every pair of points given in barycentric coordinates $x := \lambda_0 x_0 + \dots + \lambda_n x_n$ and $x' := \lambda'_0 x_0 + \dots + \lambda'_n x_n$ the distance between those points is given by the formula*

$$d(x, x') := \frac{\varepsilon}{\sqrt{2}} \sqrt{\sum_{i=0}^n (\lambda_i - \lambda'_i)^2}$$

Proof. In order to get length ε on the edges, since the euclidean distance between two vertices is $\sqrt{2} \cdot \varepsilon_0$, it suffices to take $\varepsilon_0 = \frac{\varepsilon}{\sqrt{2}}$ and measure the euclidean distance in the n -simplex as a subset of \mathbb{R}^{n+1} . \square

Consider any finite simplicial complex K . If we consider the geometric realization $|K|$, this finite polyhedron can be metrized with a length metric d in a natural way. Set each simplex isometric to a euclidean one and assume length $\sqrt{2}$ on the edges for simplicity. Now for any two points x, y in $|K|$, $d(x, y)$ will be defined as the greatest lower bound of the length of PL paths joining them. (It is immediate to see that if K is a finite simplicial complex this is a metric and the metric topology is the same of $|K|$).

Thus, d will be referred to as a **polyhedral metric** and $|K|$ endowed with the metric d , $|K|_d$, as a **finite polyhedral space**.

Remark 4.13. *If we have a finite polyhedron K with vertices x_0, \dots, x_n , for any point $x \in K$ we can represent it in barycentric coordinates as $\sum_{i=0}^n \lambda_i x_i$ where if x belongs to a simplex with vertices x_0, \dots, x_k then $\lambda_i = 0 \forall i \neq 0, \dots, k$. The distance between two points $\sum_{i=0}^n \lambda_i x_i$ and $\sum_{i=0}^n \lambda'_i x_i$ in the same simplex, measured in the euclidean metric of that simplex, is then $\sqrt{\sum_{i=0}^n (\lambda_i - \lambda'_i)^2}$.*

Lemma 4.14. *For any two points $x, x' \in \Delta$ with Δ any simplex of K , the distance $d(x, x')$ in $|K|_d$ is the distance in Δ when considered as isometric to an euclidean simplex of diameter $\sqrt{2}$.*

Proof. Consider the points in barycentric coordinates $x := \lambda_0 x_0 + \dots + \lambda_n x_n$ and $x' := \lambda'_0 x_0 + \dots + \lambda'_n x_n$ with x_0, \dots, x_n all the vertices of K as we saw in remark 4.13. The euclidean distance in the simplex is $d_0 = \sqrt{\sum_{i=0}^n (\lambda_i - \lambda'_i)^2}$. Consider now a PL path joining x and x' which is a finite union of linear paths joining $x := y_0$ to y_1 , y_1 to y_2 , \dots , y_{k-1} to $y_k := x'$ where y_{j-1}, y_j belong to the same simplex $\forall j = 1, k$. Let us denote $\beta_1^j, \dots, \beta_n^j$ the barycentric coordinates of y_j (Note that $\beta_i^0 = \lambda_i$ and $\beta_i^k = \lambda'_i$). Then, the length of this path may be computed as

$$l_0 := \sqrt{\sum_{i=0}^n (\beta_i^0 - \beta_i^1)^2} + \sqrt{\sum_{i=0}^n (\beta_i^1 - \beta_i^2)^2} + \dots + \sqrt{\sum_{i=0}^n (\beta_i^{k-1} - \beta_i^k)^2}$$

and by Minkowski's inequality,

$$l_0 \geq \sqrt{\sum_{i=0}^n (\beta_i^0 - \beta_i^k)^2} = d_0.$$

Then d_0 is a lower bound of the length of these paths finishing the proof. \square

Theorem 4.15. *Let $|K|_d$ be a finite polyhedral space. Then $|K|_d$ is topologically robust.*

Proof. Let $n := \max\{\dim(\Delta_i) \mid \Delta_i \in K\}$ and $\varepsilon < \frac{1}{n}$.

As we mentioned before, it suffices to check that it is injective. Consider x, x' any two points in $|K|_d$. If $d(x, x') > \varepsilon$ then obviously $\bar{B}(x, \varepsilon) \neq \bar{B}(x', \varepsilon)$. If $d(x, x') \leq \varepsilon$ and there is some simplex Δ_i such that $x, x' \in \Delta_i$, then restricting to this simplex (where the restricted metric is the euclidean one) it is clear that the closed balls do not coincide.

Then, the remaining case is when the points x, x' are in different simplices Δ, Δ' and $d(x, x') < \varepsilon$.

Suppose that these points are, in barycentric coordinates, $x = \lambda_0 x_0 + \dots + \lambda_n x_n$ and $x' = \lambda'_0 x_0 + \dots + \lambda'_n x_n$, in the representation we saw at Remark 4.13. Let us assume that $\sum_{i=0}^n (\lambda_i)^2 \leq \sum_{i=0}^n (\lambda'_i)^2$. We can choose a vertex (there is no loss of generality if we consider it x_0) such that $x_0 \in \Delta \setminus \Delta'$ with $\lambda_0 > 0$. (This can be done because otherwise x would be in Δ').

Now we claim that $d(x_0, x) < d(x_0, x')$. Clearly

$$d(x_0, x) = \sqrt{(1 - \lambda_0)^2 + \sum_{i=1}^n \lambda_i^2}.$$

To compute $d(x_0, x')$ consider as in lemma 4.14 any sequence of points $x_0 := y_0, y_1, \dots, y_k := x'$ with y_{j-1}, y_j in the same simplex and $\beta_1^j, \dots, \beta_n^j$ the barycentric coordinates of y_j ($\beta_0^0 = 1, \beta_i^0 = 0 \forall i \neq 0$ and $\beta_i^k = \lambda'_i$).

The length of this PL-path is

$$l_0 = \sqrt{\sum_{i=0}^n (\beta_i^0 - \beta_i^1)^2} + \sqrt{\sum_{i=0}^n (\beta_i^1 - \beta_i^2)^2} + \dots + \sqrt{\sum_{i=0}^n (\beta_i^{k-1} - \beta_i^k)^2}$$

and by Minkowski's inequality,

$$l_0 \geq \sqrt{\sum_{i=0}^n (\beta_i^0 - \beta_i^k)^2} = \sqrt{(1 - \lambda'_0)^2 + \sum_{i=1}^n (\lambda'_i)^2}$$

but $x_0 \notin \Delta'$ and therefore $\lambda'_0 = 0$.

Finally, the assumption that $\sum_{i=0}^n (\lambda_i)^2 \leq \sum_{i=0}^n (\lambda'_i)^2$ (together with $\lambda_0 > 0$ and $\lambda'_0 = 0$) implies that $d(x_0, x)^2 = (1 - \lambda_0)^2 + \sum_{i=1}^n (\lambda_i)^2 < 1 + \sum_{i=0}^n (\lambda_i)^2 - \lambda_0 \leq 1 + \sum_{i=0}^n (\lambda'_i)^2 - \lambda_0 \leq (l_0)^2 - \lambda_0$. Thus

$$\sqrt{d(x_0, x)^2 + \lambda_0} < l_0 \text{ and } d(x_0, x) < \sqrt{d(x_0, x)^2 + \lambda_0} \leq d(x_0, x').$$

Then, let z_0 be the point in the geodesic segment $[x_0, x]$ such that $d(z_0, x) = \varepsilon$. Since $d(x_0, x) < d(x_0, x')$, $d(z_0, x) < d(z_0, x')$ and hence $z_0 \notin \bar{B}(x', \varepsilon)$. Therefore, the closed balls do not coincide. \square

Question 4.16. *Is it true that for every 2-dimensional connected Riemannian manifold with its usual length metric any two balls with the same radius and different center coincide if and only if they are the whole space?*

If this were true, then the dynamical cone of any Riemannian manifold would be exactly the topological cone.

Nevertheless, being topologically robust is a strongly geometric condition. We can give an example of a compact length space (X, d) such that considering an equivalent metric up to bi-lipschitz homeomorphism (X, d') the condition holds for (X, d) and not for (X, d') .

Example 4.17. Consider $X = \{(0, y) | 0 \leq y \leq 1\} \cup \{(x, 0) | 0 \leq x \leq 1\} \cup \{(x, y) | 0 \leq x \leq y = 2^{-i}, i > 0\} \cup \{(x, y) | 0 \leq y \leq x = 2^{-i}, i > 0\}$. See Figure 5

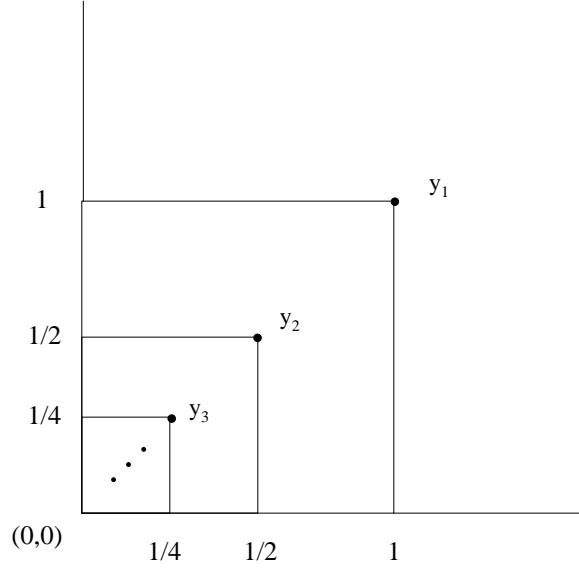

FIGURE 5. The space is not topologically robust.

In X with the natural length metric the balls centered at $x = (0, 0)$ and $y_i = (2^{-i}, 2^{-i})$ and radius $\varepsilon_i = 2 \cdot 2^{-i}$ coincide. Consider the space $X' = \{(0, y) | 0 \leq y \leq 1\} \cup \{(x, 0) | 0 \leq x \leq 1\} \cup (\cup_{i>0} \{(x, y) | 0 \leq x, y \text{ and } x + y = 2^{-i}\})$ with the natural length metric. See Figure 6.

Note that X' can be obtained from X up to isometry, just by the following change in the distance: for any pair of points z, z' in $\{(x, y) | 0 \leq x \leq y = 2^{-i}\} \cup \{(x, y) | 0 \leq y \leq x = 2^{-i}\}$ for some $i > 0$, $d'(z, z') = \frac{d(z, z')}{\sqrt{2}}$. Now in (X, d') , for any $\varepsilon \leq \frac{1}{2}$ it may be easily checked that two balls of radius ε and different centers do not coincide.

5. THE SEMIFLOW FOR FINITE METRIC GRAPHS.

By a graph, we mean a 1-dimensional simplicial complex.

A *finite metric graph* is a connected finite graph endowed with the usual length metric where every edge has length 1. In this section we prove that if X is a finite

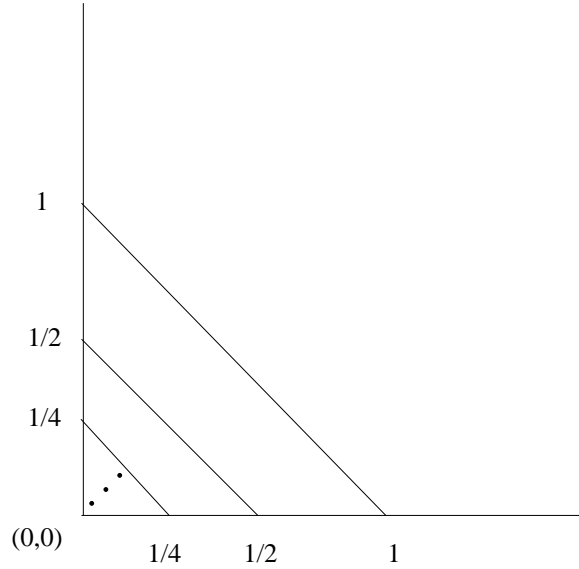

FIGURE 6. The space is topologically robust.

metric graph, then being a finite graph is a positively invariant property. This is, if X is a finite metric graph, then $p_\varepsilon(X)$ is (topologically) a finite graph for every $\varepsilon > 0$. Moreover, the graph goes through a finite number of topological types before collapsing to a point.

The underlying idea is that, in order to study geometric properties of the initial metric space, this tool preserves more information than other alternatives as Whitney levels which need not be even 1-dimensional. See [13] and [20] for further information about Whitney levels.

Finite trees.

By a tree, we refer to a 1-dimensional simply connected simplicial complex. A *rooted tree* (T, v) consists of a tree T and a point $v \in T$, called the *root*. If c is any point of the rooted tree (T, v) , the *subtree of (T, v) determined by c* is

$$T_c = \{x \in T \mid c \in [v, x]\}.$$

Lemma 5.1. *Let x, y be two points in a finite tree T such that $p_\varepsilon(x) = p_\varepsilon(y)$. Then, for any pair of points z, z' in the geodesic segment $[x, y]$ with $z = tx + (1-t)y$ and $z' = (1-t)x + ty$ for any t , $p_\varepsilon(z) = p_\varepsilon(z')$.*

Proof. Consider $v \in [x, y]$ the middle point of the geodesic, $d(x, v) = d(v, y) = \frac{1}{2}d(x, y)$. Let (T, v) be the rooted tree and T_x, T_y the corresponding subtrees. Since $\bar{B}(x, \varepsilon) = \bar{B}(y, \varepsilon)$ it is easy to see that $T_x \subset \bar{B}(y, \varepsilon)$ and $T_y \subset \bar{B}(x, \varepsilon)$. In fact,

$\forall z \in [x, v], z \neq v \quad T_z \subset \bar{B}(y, \varepsilon)$ and conversely $\forall z \in [v, y], z \neq v \quad T_z \subset \bar{B}(x, \varepsilon)$. Else, suppose $z \in [x, v], z \neq v$ with $T_z \not\subset \bar{B}(y, \varepsilon)$. Then, there is a point $p \in T_z$ such that $d(p, y) = \varepsilon + \delta$ and, by the properties of the length metric, we can assume this $\delta > 0$ to be smaller than $d(z, v)$. If this is so, then $d(p, x) \leq d(p, z) + d(z, x) < d(p, z) + d(z, y) - 2\delta = \varepsilon - \delta$ and hence, $p \in \bar{B}(x, \varepsilon)$ which contradicts the fact that the balls centered in x and y coincide.

Moreover, $\forall z \in [x, v], z \neq v$ and $\forall z' \in [v, y], z \neq v \quad T_z \subset \bar{B}(z', \varepsilon)$ and $T_{z'} \subset \bar{B}(z, \varepsilon)$ with the same argument since $d(z, z') < d(z, y), d(x, z')$. Thus, if both points z, z' are at the same distance to the root v , then their balls necessarily coincide. \square

Also, the following lemmas are clear from the proof.

Lemma 5.2. *Consider any pair of points in a finite tree, $x, y \in T$, such that $p_\varepsilon(x) = T = p_\varepsilon(y)$. Then, $p_\varepsilon(z) = T$ for every $z \in [x, y]$. In particular, the set $T'_\varepsilon := \{x \in T \mid p_\varepsilon(x) = T\}$ is a (possibly empty) subtree.* \square

Lemma 5.3. *If two points x, y are such that $p_\varepsilon(x) = p_\varepsilon(y)$ and the middle point v of the geodesic has order two in the tree, then $p_\varepsilon(z) = T$ for every $z \in [x, y]$.* \square

Lemma 5.4. *There are no cycles in $p_\varepsilon(T)$.* \square

Proposition 5.5. *If T is a finite tree, then $p_\varepsilon(T)$ is a finite tree for every ε .*

Proof. For any $\varepsilon > 0$ consider $T'_\varepsilon = \{x \in T \mid p_\varepsilon(x) = T\}$. As we mentioned before, T'_ε is a subtree (it may be the empty set). We can construct $p_\varepsilon(T) = T/\sim$ (see 4.8) in two steps: first T/T'_ε identifying all the points in T'_ε . This is obviously homeomorphic to a tree. The second step is to identify every other pair of points with the same projection but, since there is a finite number of points of order > 2 and the tree is locally finite, we are identifying a finite number of geodesic segments without generating any cycle. Therefore, we obtain a tree. \square

Finite graphs.

In this paragraph the space X will always be a non-degenerated finite metric graph.

Let us recall that $B^c(x, \varepsilon) = \bar{B}(x, \varepsilon)$ and $\partial\bar{B}(x, \varepsilon) = \partial B(x, \varepsilon) = S(x, \varepsilon) = \{z \in X \mid d(z, x) = \varepsilon\}$.

Lemma 5.6. *For any point $x \in X$ and any $\varepsilon > 0$, $\partial B(x, \varepsilon)$ consists at most of a finite number of points.*

Proof. Let $x \in |e|$ for some edge e with vertices v_0, v_1 (if x is a vertex suppose it is v_0), and let $d_0 = d(x, v_0)$ and $d_1 = d(x, v_1) = 1 - d_0$ (let us assume, without loss of generality, that $d_0 \leq d_1$, and $d_0 = 0$ if x is a vertex). For every vertex $v_i \in X$ the distance to v_0 is a positive integer n_i and the distance to v_1 is m_i (obviously $|n_i - m_i| \leq 1$). Hence the distance from v_i to x is either $d_0 + n_i$ if $n_i \leq m_i$ or $d_1 + m_i$ if $m_i < n_i$. For any point in any edge $y \in [v, v']$ the distance $d(x, y)$ is $\min\{d(y, v) + d(v, x), d(y, v') + d(v', x)\}$.

If $\varepsilon \leq d_0$ then $\bar{B}(x, \varepsilon)$ is contained in the edge and $\partial B(x, \varepsilon)$ consists of two points. If $d_0 < \varepsilon \leq d_1 \leq 1$, then the part of the edge between x and v_1 contains one border point and the rest of them are one at each edge adjacent to v_0 . If $\varepsilon > d_1 \geq d_0$, let $d'_0 = \varepsilon - d_0 - [\varepsilon - d_0]$ (where $[t]$ is the integer part of t) and $d'_1 = \varepsilon - d_1 - [\varepsilon - d_1]$. For every $z \in X$ such that $d(z, x) = \varepsilon$, since there is a path realizing the distance

in the graph, there must be a vertex $w \in X$ such that $d(z, w) = d'_0$ if the geodesic segments contain v_0 or $d(z, w) = d'_1$ if the geodesic segments contain v_1 .

Since the number of vertices and edges is finite, the number of points at distance d'_0 or d'_1 from any vertex is finite and so it is the number of points in $S(x, \varepsilon) = \partial B(x, \varepsilon)$. \square

Obviously, $\partial B(x, \varepsilon) \neq \emptyset$ if and only if $\forall \varepsilon' < \varepsilon \quad \bar{B}(x, \varepsilon') \neq X$.

Lemma 5.7. $\forall \varepsilon > 0$ there is a finite number of points z_1, \dots, z_n for which $\partial \bar{B}(z_i, \varepsilon)$ contains a vertex or the middle point of an edge.

Proof. Let $x \in X$ and let us denote for $x \in [v_0, v_1]$, $d_0 = d(x, v_0) \leq d_1 = d(x, v_1) = 1 - d_0$.

Suppose $\varepsilon > 1$. For any point $x \in X$, let z be a vertex or a middle point of an edge in the border of the ball of radius ε . Since the distance from z to any vertex or middle point is a multiple of $\frac{1}{2}$, considering the geodesic segment from x to z (which contains v_0 or v_1), then $|\varepsilon - d_0|$ or $|\varepsilon - d_1|$ is a multiple of $\frac{1}{2}$. There are at most two points holding this at each edge. Since the graph is finite, there is a finite number of points for which $\partial \bar{B}(z_i, \varepsilon)$ contains a vertex or a middle point of an edge.

If $\varepsilon \leq 1$ it suffices to consider the points at distance ε or $|\varepsilon - \frac{1}{2}|$ from the vertices which is a finite set. \square

Lemma 5.8. For any pair of points $x, y \in X$ there exists some $\delta > 0$ such that $\forall z \in B(x, \delta) \setminus \{x\}$, $d(z, y) \neq d(x, y)$. Moreover, we can choose $\delta > 0$ such that each connected component C_i of $B(x, \delta) \setminus \{x\}$ is contained in some edge and $\forall z \in C_i$ $d(z, y) = d(x, y) + d(x, z)$ or $d(z, y) = d(x, y) - d(x, z)$.

Proof. Let us divide the proof in two cases.

First when x is not a vertex. Let $x \in |e|$ for some edge e with vertices v_0, v_1 and $d_0 = d(x, v_0)$, $d_1 = d(x, v_1) = 1 - d_0$ with $d_0 \leq d_1$. If $y \in [v_0, v_1]$ let $\delta < \min\{d_0, d_1, d(x, y)\}$ and the result is obvious. So, let us assume that $y \notin [v_0, v_1]$. If there is a geodesic segment $[x, y]$ containing v_i , $i \in \{0, 1\}$ and $z \in (x, v_i)$ (the points in $|e|$ between x and v_i) then $d(z, y) = d(x, y) - d(x, z)$. If no geodesic segment $[x, y]$ contains v_i , $i \in \{0, 1\}$ it means that $d_i + d(v_i, y) > \varepsilon$. Then, let $0 < 2\delta < d_i + d(v_i, y) - \varepsilon$. It is immediate to see that $\forall z \in (x, v_i)$ such that $d(x, z) < \delta$, any geodesic segment $[z, y]$ still contains the opposite vertex and $d(z, y) = d(x, z) + d(x, y)$.

If x is a vertex of the graph, then let w_1, \dots, w_n all the adjacent vertices. If $y \in [x, w_i]$ for some i it suffices to take $\delta < d(x, y)$. If $y \notin [x, w_i]$ for every i , let w_1, \dots, w_k those w_i for which $d(w_i, y) = d(x, y) - 1$. Then, for any $i > k$, either $d(w_i, y) = d(x, y)$ or $d(w_i, y) = d(x, y) + 1$. Let $\delta < \frac{1}{2}$.

If $z \in (x, w_i)$ with $i \leq k$ then $d(z, y) = d(x, y) - d(x, z)$. If $z \in (x, w_i)$ with $i > k$ and $d(z, x) \leq \delta$, then any geodesic segment $[z, y]$ contains x and some w_i with $i \leq k$. Hence, $d(z, y) = d(x, y) + d(x, z)$. \square

Let \mathcal{V} be the set of vertices in X and \mathcal{M} the set of middle points of edges.

For every $\varepsilon > 0$ let $A_\varepsilon := \{x \in X \mid x \notin \mathcal{V}, x \notin \mathcal{M}, \partial B(x, \varepsilon) \cap \mathcal{V} = \emptyset, \partial B(x, \varepsilon) \cap \mathcal{M} = \emptyset \text{ and } \bar{B}(x, \varepsilon) \neq X\}$.

Proposition 5.9. $\forall \varepsilon > 0$ $p_\varepsilon(X) \setminus p_\varepsilon(A_\varepsilon)$ is a finite number of points.

Proof. $X \setminus A_\varepsilon$ consists of all the points in X for which the ball of radius ε is the total space together with a finite number of points by 5.7 and because the graph is finite. $p_\varepsilon(X) \setminus p_\varepsilon(A_\varepsilon)$ consist of the projection of that finite number of points together with the total space if there is such a ball. \square

Remark 5.10. For every $x \in A_\varepsilon$, if $\varepsilon > d_1$, $\varepsilon = d_0 + k + d'_0 = d_1 + k' + d'_1$ and $0 < d'_0 \neq \frac{1}{2}$. Then $d'_1 = d_0 - d_1 + k - k' + d'_0 = d_0 - 1 + d_0 + k - k' + d'_0 = 2d_0 + d'_0 + k''$ with k'' some integer, and since $2d_0$ is not an integer $d'_1 \neq d'_0$.

Lemma 5.11. Let $x \in A_\varepsilon$ with $d_1 < \varepsilon = d_0 + k + d'_0 = d_1 + k' + d'_1$ and $y \in \partial \bar{B}(x, \varepsilon) \cap cl(X \setminus \bar{B}(x, \varepsilon))$. Then there is an edge $e' = [w, w']$ such that $y \in e'$, $d(y, w) = d(x, y) - d(y, w)$ and $d(y, w') > d(x, y) - d(y, w')$. Moreover, either $d(w, y) = d'_0$ and any geodesic segment from x to y is $[x, v_0] \cup [v_0, w] \cup [w, y]$ with lengths d_0, k, d'_0 respectively or $d(w, y) = d'_1$ and it is $[x, v_1] \cup [v_1, w] \cup [w, y]$ with lengths d_1, k', d'_1 .

Proof. Since $y \in \partial \bar{B}(x, \varepsilon)$ there is a geodesic segment $[x, y]$ of length ε which contains one (and only one) of the vertices, let us consider it w , of e' (y is not a vertex because $x \in A_\varepsilon$). Since $y \in cl(X \setminus \bar{B}(x, \varepsilon))$, then $d(y, w') > d(x, y) - d(x, w')$. Otherwise $[y, w'] \cup [w', x]$ would be also a path of length ε and $|e'|$ would be contained in $\bar{B}(x, \varepsilon)$. This would be a contradiction because it would make $d(y, X \setminus \bar{B}(x, \varepsilon)) \geq \min\{d'_0, d'_1\} > 0$ and $y \notin cl(X \setminus \bar{B}(x, \varepsilon))$.

The distance between any two vertices is an integer and $d_0 < d_1$. Then $d(x, w)$ can be of the type $d_0 + k$ or $d_1 + k'$. The first case occurs if and only if $d(w, y) = d'_0$ and any geodesic segment $[x, y]$ would be $[x, v_0] \cup [v_0, w] \cup [w, y]$ with $d(v_0, w) = k$ and the second one occurs if and only if $d(w, y) = d'_1$ and the geodesic segment would be $[x, v_1] \cup [v_1, w] \cup [w, y]$ with $d(v_1, w) = k'$. \square

Remark 5.12. If we apply lemma 5.8 we obtain a ball about this point $y \in e'$ and both connected components $C_0 \subset (w_i, y)$ where $\forall z \in C_0 \quad d(z, x) = d(x, y) - d(z, y)$ and $C_1 \subset (y, w'_i)$ where $\forall z \in C_1 \quad d(z, x) = d(x, y) + d(z, y)$.

Lemma 5.13. For every $x \in A_\varepsilon$ and $\{y_1, \dots, y_n\} = \partial \bar{B}(x, \varepsilon) \cap cl(X \setminus \bar{B}(x, \varepsilon))$ there are two disjoint subsets $\{y_1, \dots, y_k\}$ and $\{y_{k+1}, \dots, y_n\}$ so that for any geodesic segment γ_i from x to y_i $[v_0, x] \cap \gamma_i \neq \{x\}$ for $i \leq k$ and $[v_1, x] \cap \gamma_i \neq \{x\}$ for $i > k$. In particular, if $d_1 < \varepsilon = d_0 + k + d'_0 = d_1 + k' + d'_1$, then for every $i \leq k$ there is a vertex w_i so that $d(w_i, y_i) = d'_0$ and $d(x, w_i) = d_0 + k$ and for every $i > k$ there is a vertex w_i so that $d(w_i, y_i) = d'_1$ and $d(x, w_i) = d_1 + k'$

Proof. The case when $\varepsilon \leq d_1$ is trivial. If $\varepsilon > d_1$ the proof follows easily from lemma 5.11. \square

The interesting case comes when we consider lemma 5.8 applied to a point in A_ε and the points in $\partial \bar{B}(x, \varepsilon) \cap cl(X \setminus \bar{B}(x, \varepsilon))$ using this partition.

Lemma 5.14. Let $x \in A_\varepsilon$ and $\{y_1, \dots, y_n\} = \partial \bar{B}(x, \varepsilon) \cap cl(X \setminus \bar{B}(x, \varepsilon))$ with the partition defined in Lemma 5.13. Then there is some $\delta > 0$ such that $B(x, \delta) \setminus \{x\}$ is contained in an edge and has two connected components $C_{0, \delta} \subset (v_0, x)$, $C_{1, \delta} \subset (v_1, x)$, and $\forall z \in C_{0, \delta}$, $d(z, y_i) = d(x, y_i) - d(x, z) \quad \forall i \leq k$, $d(z, y_i) = d(x, y_i) + d(x, z) \quad \forall i > k$ and $\forall z \in C_{1, \delta}$, $d(z, y_i) = d(x, y_i) - d(x, z) \quad \forall i > k$ and $d(z, y_i) = d(x, y_i) + d(x, z) \quad \forall i \leq k$.

Proof. The cases where $\varepsilon \leq d_1 < 1$ are quite trivial and it suffices to take $\delta < d_0, \varepsilon$. Let us study the case when $\varepsilon > d_1$. Let $x \in |e| = [v_0, v_1]$, $d_0 = d(x, v_0) < d(x, v_1) = d_1$ and $\varepsilon = d_0 + k + d'_0 = d_1 + k' + d'_1$ (remember that, since $x \in A_\varepsilon$, $d'_0, d'_1 \neq 0, \frac{1}{2}$).

By lemma 5.11, every y_i is contained in an edge $[w_i, w'_i]$ with $d(w_i, y_i) = d'_0 \forall i \leq k$ and $d(w_i, y_i) = d'_1 \forall i > k$.

Let $0 < 2\delta_i < d(w'_i, x) + d(w'_i, y_i) - \varepsilon$. Then, if $\delta_0 = \min\{\delta_i\}$, $\forall z \in B(x, \delta_0)$ any geodesic segment $[z, y_i]$ contains w_i and not w'_i .

If $\delta_1 < d_0$ there are two connected components in $B(x, \delta_1) \setminus \{x\}$: $C_{0, \delta_1} \subset (v_0, x)$ contained in the part of the edge e between v_0 and x , and $C_{1, \delta_1} \subset (v_1, x)$.

Finally, let $0 < 2\delta'_i < d(y_i, v_1) + d_1 - \varepsilon$ for $i \leq k$ and $0 < 2\delta'_i < d(y_i, v_0) + d_0 - \varepsilon$ for $i > k$, and $\delta_2 = \min\{\delta'_i, \delta_1\}$. Then $\forall z \in B(x, \delta_2)$ the geodesic segment $[z, y_i]$ still contains v_0 if $i \leq k$ and v_1 if $i > k$.

Then define $\delta = \min\{\delta_0, \delta_2\}$. If $z \in C_{0, \delta}$, $d(z, y_i) = d(z, v_0) + d(v_0, w_i) + d(w_i, y) = d(x, y_i) - d(x, z) \forall i \leq k$ and $d(z, y_i) = d(z, v_1) + d(v_1, w_i) + d(w_i, y) = d(x, y_i) + d(x, z) \forall i > k$ and if $z \in C_{1, \delta}$, $d(z, y_i) = d(z, v_1) + d(v_1, w'_i) + d(w'_i, y) = d(x, y_i) - d(x, z) \forall i > k$ and $d(z, y_i) = d(z, v_0) + d(v_0, w'_i) + d(w'_i, y) = d(x, y_i) + d(x, z) \forall i \leq k$. \square

Lemma 5.15. *Suppose that x is not a vertex nor a middle point and let $y' \in \partial \bar{B}(x, \varepsilon) \setminus cl(X \setminus \bar{B}(x, \varepsilon))$ so that y' is not a vertex. Let $[v_0, v_1]$ and $[u_0, u_1]$ be two edges such that $x \in [v_0, v_1]$ and $y' \in [u_0, u_1]$. Then, $[v_0, v_1]$ and $[u_0, u_1]$ are part of a minimal cycle of length $2\varepsilon \in \mathbb{N}$ composed by two geodesic segments from x to y' . Moreover, if 2ε is even, then $d_0 = d'_1$ and $d_1 = d'_0$ and if 2ε is odd then $d'_1 = d_0 + \frac{1}{2}$ and $d'_0 = d_1 - \frac{1}{2}$.*

Proof. Let $\varepsilon = d_0 + k + d'_0 = d_1 + k' + d'_1$. Let us assume, with no loss of generality, that $d_0 \leq d_1$, $d(y', u_0) = d'_0 > 0$, $d(y', u_1) = d'_1 = 1 - d'_0 > 0$, $d(x, u_0) = d_0 + k$ and $d(x, u_1) = d_1 + k'$. Since $y' \notin cl(X \setminus \bar{B}(x, \varepsilon))$, there exist two geodesic segments γ_0, γ_1 with length ε from x to y' , γ_0 containing v_0 and u_0 , and γ_1 containing v_1 and u_1 .

Consider the restriction γ'_0 of γ_0 joining v_0 and u_0 and the restriction γ'_1 of γ_1 joining v_1 and u_1 . If they are disjoint we are done. Otherwise, there would be a common vertex $z \in \gamma'_0 \cap \gamma'_1$ and $d_0 + n_1 = d(v_0, z) \neq d(v_1, z) = d_1 + n_2$ (see Figure 7).

If $d(v_0, z) \leq d(v_1, z)$ the vertices u_0, u_1 hold that $d(u_0, v_0) \leq d(u_0, v_1)$ and $d(u_1, v_0) \leq d(u_1, v_1)$ but this last inequality is not possible because there is a geodesic segment from x to u_1 containing v_1 (restriction of γ_1) and since $d_1 > d_0$ we would get $d(x, u_1) = d_1 + d(u_1, v_1) > d_0 + d(u_1, v_0) \geq d(x, u_1)$.

Otherwise $d(v_1, z) \leq d(v_0, z) - 1$ and then $d(v_1, u_0) \leq d(v_0, u_0) - 1$ and $d(v_1, u_1) \leq d(v_0, u_1) - 1$. Then $[x, v_1] \cup [v_1, u_0] \cup [u_0, y']$ defines a path of length $d_1 + d(v_1, u_0) + d'_0 \leq d_1 + d(v_0, u_0) - 1 + d'_0$ and since $d_1 < d_0 + 1$ this yields a path from x to y' shorter than γ_0 , this is, $d(x, y') < \varepsilon$ which is a contradiction. \square

Let us define

$$(1) \quad K_{x, \varepsilon} := \{x \in |e| \mid |e| \subset B(x, \varepsilon)\},$$

the set of points in X which belong to some edge entirely contained in the open ball $B(x, \varepsilon)$. Notice that, since X is a finite graph, $K_{x, \varepsilon}$ is compact.

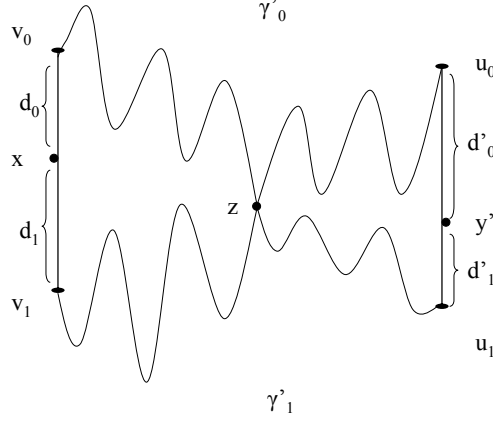

FIGURE 7. In the conditions of the Lemma, there is a contradiction if the geodesic segments γ'_0, γ'_1 intersect.

Lemma 5.16. *Let $x \in A_\varepsilon$, $\{y_1, \dots, y_n\} = \partial \bar{B}(x, \varepsilon) \cap cl(X \setminus \bar{B}(x, \varepsilon))$ the partition defined in Lemma 5.13. Then there exists $\delta > 0$ such that, $\forall z \in C_{0, \delta}$*

$$\bar{B}(z, \varepsilon) = \bar{B}(x, \varepsilon) \cup \{\cup_{i=1}^k \bar{B}(y_i, d(z, x))\} \setminus \cup_{i=k+1}^n B(y_i, d(z, x))$$

and $\forall z \in C_{1, \delta}$

$$\bar{B}(z, \varepsilon) = \bar{B}(x, \varepsilon) \cup \{\cup_{i=k+1}^n \bar{B}(y_i, d(z, x))\} \setminus \cup_{i=1}^k B(y_i, d(z, x))$$

In particular we can take δ small enough so that each ball $\bar{B}(y_i, d(z, x))$ is contained in some edge and it is disjoint from the other balls.

Proof. If $\varepsilon \leq d_1$ the lemma is immediate taking $\delta < \min\{d_0, \varepsilon\}$. Let us suppose $\varepsilon > d_1$.

Let $\delta_0 < d'_0, d'_1, 1 - d'_0, 1 - d'_1$.

The first two bounds are quite redundant with the next one, δ_1 , and may be eliminated from the proof but to justify how they follow from the other one is less clear than explicitly asking for them. The last two are unnecessary for the first part of this result but, later on, it will be useful to make sure that each ball $B(y_i, d(z, x))$ is contained in one edge.

Consider $\delta_1 > 0$ so that lemma 5.14 is satisfied.

Let $\varepsilon' = \max_{a \in K_{x, \varepsilon}} \{d(a, x)\}$. Since $K_{x, \varepsilon}$ is compact and it is contained in the open ball, $0 \leq \varepsilon' < \varepsilon$. Let $0 < \delta_2 < \varepsilon - \varepsilon'$ then $\forall z \in B(x, \delta_1)$, $K_{x, \varepsilon} \subset B(z, \varepsilon)$.

Thus, we only have to care about edges $|e_i| = [w_i, w'_i]$ containing $\{y_i\}$ for $i = 1, n$ and those e'_1, \dots, e'_r such that $|e'_j| \subset \bar{B}(x, \varepsilon)$ but there is a point y'_j of the border of the ball in them. Let us start with one of these $y'_j \in |e'_j|$ with $1 \leq j \leq r$.

Since $x \in A_\varepsilon$, $y' = y'_j$ is an interior point of $e'_j = [u_0, u_1]$. By Lemma 5.15, any border point y' in an edge entirely contained in the closed ball is in a cycle of length $2\varepsilon \in \mathbb{N}$ given by two geodesic segments from x to y' . Moreover if 2ε is even, then $k = k'$ and hence $d_0 = d'_1$ and $d_1 = d'_0$. If 2ε is odd then $k' = k + 1$ and $d_0 + d'_0 + 1 = d_1 + d'_1$ (other thing is not possible because $d_0 < d_1$), and since $d_1 = 1 - d_0$ and in this situation $d'_0 = 1 - d'_1$ it follows immediately that $d'_1 = d_0 + \frac{1}{2}$ and $d'_0 = d_1 - \frac{1}{2}$.

The important fact here for these points y'_i is that if we consider $\delta_3 < d_0 < d_1$, for any point $z \in B(x, \delta_3)$ the closed ball $\bar{B}(z, \varepsilon)$ also contains any cycle of length 2ε containing the edge $[v_0, v_1]$ and there would not be any difference between the balls centered in x and in z in those edges $|e'_i|$.

Hence if $0 < \delta < \delta_1, \delta_2, \delta_3$ the unique difference between those balls would be in those edges $[w_i, w'_i]$ which contain the points $\{y_1, \dots, y_n\}$ (not outside $\bar{B}(x, \varepsilon)$) either because $\delta < 1 - d'_0, 1 - d'_1$. (Note that two of these points y_i, y_j may be in the same edge if $2d'_0 < 1, 2d'_1 < 1$ or $d'_0 + d'_1 < 1$. This would mean in the notation that $w_i = w'_j$ and $w'_i = w_j$ and doesn't lead to any contradiction).

Let $0 < \delta_4 = \frac{1}{2} \min_{i \neq j} \{d(y_i, y_j)\}$. If $0 < \delta < \delta_4$, for any pair of border points y_i, y_j $\bar{B}(y_i, \delta) \cap \bar{B}(y_j, \delta) = \emptyset$.

Thus finally, let $0 < \delta < \min\{\delta_0, \delta_1, \delta_2, \delta_3, \delta_4\}$.

We are going to prove the equality for the case $z \in C_{0, \delta}$. If $z \in C_{1, \delta}$ is analogous:

$$\bar{B}(z, \varepsilon) = \bar{B}(x, \varepsilon) \cup_1^k \{\bar{B}(y_i, d(x, z))\} \setminus \cup_{i=k+1}^n \{B(y_i, d(x, z))\}.$$

As we said, $K_{x, \varepsilon}$ and $\{e'_1, \dots, e'_r\}$ are both contained in $\bar{B}(z, \varepsilon)$ and in $\bar{B}(x, \varepsilon) \cup_1^k \{\bar{B}(y_i, d(z, x))\} \setminus \cup_{i=k+1}^n \{B(y_i, d(z, x))\}$ since $\delta < \delta_1 < d'_0, d'_1$ and we are not removing any of those points with the balls $B(y_i, d(z, x))$ with $i > k$ because $\delta < d'_1$. To prove the equality it remains to see what happens on $|e_i|$.

The balls $B(y_i, \delta)$ are all disjoint and contained in an edge so we can study what happens around each border point independently.

If $i \leq k$ then $d(z, y_i) = \varepsilon - d(z, x)$ and hence the ball $\bar{B}(z, \varepsilon)$ includes $[w_i, y_i]$ and also around y_i exactly a ball $\bar{B}(y_i, d(x, z))$. If $i > k$ $d(z, y_i) = \varepsilon + d(z, x)$ and $d(z, x) < \delta < d'_1$ implies that $\bar{B}(z, \varepsilon) \cap [w_i, y_i] = [w_i, y_i] \setminus B(y_i, d(x, z))$. \square

Lemma 5.17. *Let $\bar{B}(x, \varepsilon) = X$ and let $\{y_1, \dots, y_n\} = \partial \bar{B}(x, \varepsilon)$. Let $\delta_1 > 0$ be such that $B(x, \delta_1)$ holds lemma 5.8 for every border point y_i . For any component $C_i \in B(x, \delta_1) \setminus \{x\}$ consider $\{y_1, \dots, y_k\}$ those border points such that $\forall z \in C_i$ $d(z, y_i) = d(x, y_i) + d(x, z)$. Then, there exists some $\delta < \delta_1$ such that $\forall z \in C_i \cap B(x, \delta)$, $\bar{B}(z, \varepsilon) = X \setminus \cup_{i=1}^k \{B(y_i, d(x, z))\}$.*

Proof. If $\varepsilon \leq 1$ then X consists of two vertices and a single edge or two edges and x is a common vertex. In both cases the proof is immediate. Let us suppose that there are at least two edges and $\varepsilon > 1$.

Let $x \in [v_0, v_1]$ with $0 \leq d_0 = d(x, v_0) < 1$ and $d_1 = d(x, v_1) = 1 - d_0$. Let $k = [\varepsilon - d_0]$, $k' = [\varepsilon - d_1]$, $d'_0 = \varepsilon - k - d_0$ and $d'_1 = \varepsilon - k' - d'_0$.

Let $\varepsilon' = \max_{a \in K_{x, \varepsilon}} \{d(a, x)\}$. Then $0 \leq \varepsilon' < \varepsilon$ since $K_{x, \varepsilon}$ is compact and it is contained in the open ball. Let $0 < \delta_2 < \varepsilon - \varepsilon'$ then $\forall z \in B(x, \delta_2)$, $K_{x, \varepsilon} \subset B(z, \varepsilon)$.

If $\{y_1, \dots, y_k\} \neq \emptyset$ and $\delta < \min\{\delta_1, \delta_2\}$ we only have to check those edges containing a border point y_i with $i \leq k$. Any geodesic segment $[x, y_i]$ has length ε and $\forall z \in C_i$, any geodesic segment $[z, y_i]$ has length $\varepsilon + d(z, x)$.

Thus, $d(z, x) = \varepsilon + d(z, x)$ implies that $\forall z' \in B(y_i, d(z, x))$, $d(z', z) > \varepsilon$. Then $B(y_i, d(x, z)) \cap \bar{B}(z, \varepsilon) = \emptyset$ and the ball $\bar{B}(z, \varepsilon) \subset X \setminus \cup_{i=1}^k \{B(y_i, d(x, z))\}$.

On the other hand, consider any point $z' \in X \setminus \cup_{i=1}^k \{B(y_i, d(x, z))\}$. If $z' \in K_{x, \varepsilon}$, then, since $d(x, z) < \delta, \delta_2$, $z' \in \bar{B}(z, \varepsilon)$. If $z' \notin K_{x, \varepsilon}$, then $z' \in [w_i, y]$ with $[w_i, w'_i]$ some edge such that $y_i \in [w_i, w'_i]$. Therefore, $d(z, z') \leq d(x, y) + d(x, z) - d(z', y) = \varepsilon + d(x, z) - d(z', y)$. But, since $z' \notin B(y_i, d(x, z))$, $d(z', y_i) \geq d(x, z)$ and therefore, $d(z, z') \leq \varepsilon$ and $z' \in \bar{B}(z, \varepsilon)$.

Thus, $\bar{B}(z, \varepsilon) = X \setminus \cup_{i=1}^k \{B(y_i, d(x, z))\}$. \square

Corollary 5.18. *Let $\bar{B}(x, \varepsilon) = X$ and let $\emptyset \neq \{y_1, \dots, y_n\} = \partial \bar{B}(x, \varepsilon)$. Then there is some $\delta > 0$ such that the restriction $p_\varepsilon|_{C_{i, \delta} \cup \{x\}} : C_{i, \delta} \cup \{x\} \rightarrow p_\varepsilon(C_{i, \delta} \cup \{x\})$ is an isometry when $p_\varepsilon(C_{i, \delta}) \neq \{X\}$.*

Proof. By the properties of the length metric $\forall z, z' \in X \quad d_H(\bar{B}(z, \varepsilon), \bar{B}(z', \varepsilon)) \leq d(z, z')$. Suppose $\delta > 0$ holding Lemma 5.17. If $p_\varepsilon(C_{i, \delta}) \neq \{X\}$ then, by Lemma 5.8, there is some y_j such that $\forall z \in C_{i, \delta} \quad d(z, y_j) = d(z, x) + d(x, y_j)$.

As we have just shown $\bar{B}(z, \varepsilon) \cap B(y_j, d(z, x)) = \emptyset$. Let $z' \in (z, x)$. $\bar{B}(z', \varepsilon) \cap S(y_j, d(z', x)) \neq \emptyset$ since $d(z', y_j) = \varepsilon + d(z', x)$.

Thus, any point $p \in \bar{B}(z', \varepsilon) \cap S(y_j, d(z', x))$ holds that $d(p, \bar{B}(z, \varepsilon)) \geq d(z, x) - d(z', x) = d(z, z')$ and hence $d_H(\bar{B}(z, \varepsilon), \bar{B}(z', \varepsilon)) \geq d(z, z')$ which proves the equality. \square

Proposition 5.19. *For any $x \in X$ such that $\bar{B}(x, \varepsilon) \neq X$, if x is not a vertex nor a middle point of an edge then there exists $\delta > 0$ such that the restriction $p_\varepsilon|_{B(x, \delta)} : B(x, \delta) \rightarrow p_\varepsilon(B(x, \delta))$ is an isometry.*

Proof. If $\varepsilon \leq d_1$ it is immediate.

Otherwise, let $y \in \partial \bar{B}(x, \varepsilon) \cap cl(X \setminus \bar{B}(x, \varepsilon))$ and $\delta_1 > 0$ such that Lemma 5.8 holds for x, y . Since x is not a vertex, $B(x, \delta_1) \setminus \{x\}$ decomposes in two connected components $C_{0, \delta_1}, C_{1, \delta_1}$ and, since x is not a middle point, $d_0 = d(x, v_0) \neq d(x, v_1) = d_1$. Therefore, y is contained in an edge $[w, w']$ with $d(w, x) = d(x, y) - d(w, y)$ (there is a geodesic segment $\gamma = [x, y]$ with $w \in \gamma$) and $d(w', x) > d(x, y) - d(w', y)$ (every geodesic segment $[x, y]$ must contain w because $y \in cl(X \setminus \bar{B}(x, \varepsilon))$).

Since $d_0 \neq d_1$, $0 < |d_0 - d_1| < 1$. As we saw in Lemma 5.6, the distance between vertices of the graph is an integer which now implies that $d(x, v_0) + d(v_0, w) \neq d(x, v_1) + d(v_1, w)$. Then suppose $\varepsilon = d(x, v_0) + d(v_0, w) + d(w, y) < d(x, v_1) + d(v_1, w) + d(w, y) = \varepsilon'$ and any geodesic segment γ contains v_0 . See Figure 8.

If we apply Lemma 5.8 on y, v_0 obtaining a ball around y , then there is a component D_{1, δ_2} contained in (y, w') and such that $d(z', v_0) = d(z', y) + d(y, v_0) \forall z' \in D_{1, \delta_2}$. If it were such that $d(z', v_0) = d(y, v_0) - d(z', y)$ there would be a path of length $\varepsilon - d_0$ given by $[v_0, z'] \cup [z', y]$ with $z' \in (y, w')$. The image of this path necessarily contains the vertex w' and we will arrive to a contradiction because $d(y, w') + d(w', v_0) + d(v_0, x) \geq d(y, w') + d(w', x) > d(y, w) + d(w, v_0) + d(v_0, x) = \varepsilon$ and hence $d(y, w') + d(w', v_0) > d(y, w) + d(w, v_0) = \varepsilon - d_0$ and there is no geodesic segment $[v_0, y]$ containing w' .

Let $\delta < \min\{\delta_1, \delta_2, \frac{1}{4}(\varepsilon - \varepsilon')\}$. Then $\forall z \in B(x, \delta)$ and $\forall z' \in B(y, \delta)$, $z \in [v_0, v_1]$ and any geodesic segment $\gamma = [z, z']$ contains v_0 since otherwise we would have a path from x to y across v_1 with length $\leq \varepsilon + 2\delta < \varepsilon'$.

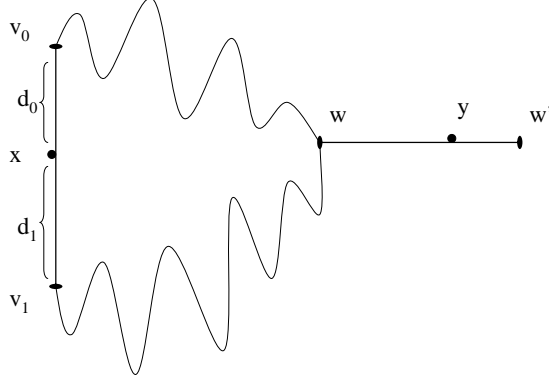

FIGURE 8. Every geodesic segment $[x, y]$ contains the same vertex v_0 or v_1 .

Then, if $z \in C_{0,\delta}$, $D_{0,\delta} \subset \bar{B}(z, \varepsilon)$ and $\bar{B}(z, \varepsilon) \cap D_{1,\delta} = \bar{B}(y, d(z, x)) \cap D_{1,\delta}$. If $z \in C_{1,\delta}$ $D_{1,\delta} \cap \bar{B}(z, \varepsilon) = \emptyset$ and $\bar{B}(z, \varepsilon) \cap D_{0,\delta} = D_{0,\delta} \setminus B(y, d(z, x))$. Thus, it is immediate to check that $\forall z_1, z_2 \in B(x, \delta)$ $d_H(\bar{B}(z_1, \varepsilon), \bar{B}(z_2, \varepsilon)) \geq d(z, z')$. \square

This holds, in particular, for any $x \in A_\varepsilon$. Nevertheless, the projection p_ε need not be open.

Example 5.20. Consider the graph in Figure 9 and the projection with $\varepsilon = 2 + \frac{3}{4}$.

In this case, p_ε is not open, not even restricted to $X \setminus p_\varepsilon^{-1}(X)$. If we consider some small enough δ around x , for instance $\delta \leq \frac{1}{8}$ it is immediate to see that $p_\varepsilon^{-1}(p_\varepsilon(B(x, \delta))) = B(x, \delta) \cup \{x'\}$, which is not open. This means that $p_\varepsilon(B(x, \delta))$ is not open since, as we showed above, p_ε is continuous.

Lemma 5.21. Let $\bar{B}(x, \varepsilon) \neq X$. Then there is some $\delta > 0$ such that for any connected component $C_i \in B(x, \delta) \setminus \{x\}$ the restriction $p_\varepsilon| : C_{i,\delta} \cup \{x\} \rightarrow p_\varepsilon(C_{i,\delta} \cup \{x\})$ is an isometry.

Proof. If $\varepsilon \leq d_1$ it is immediate.

Else, let $y \in \partial \bar{B}(x, \varepsilon) \cap cl(X \setminus \bar{B}(x, \varepsilon))$ and $\delta_1 > 0$ such that Lemma 5.8 holds for x, y . Any connected component C_{i,δ_1} of $B(x, \delta_1)$ holds that $\forall z \in C_{i,\delta_1}$ $d(z, y) = d(z, x) + d(x, y)$ or $d(z, y) = d(x, y) - d(x, z)$. In the first case, $\bar{B}(z, \varepsilon) \subset X \setminus B(y, d(x, z))$ and for any $z' \in (z, x)$, since there is a path of length $\varepsilon + d(z', y)$ from z' to y , $\bar{B}(z', \varepsilon)$ contains a point p such that $d(p, y) = d(z', x)$ and hence $d_H(\bar{B}(z, \varepsilon), \bar{B}(z', \varepsilon)) \geq d(z, z')$.

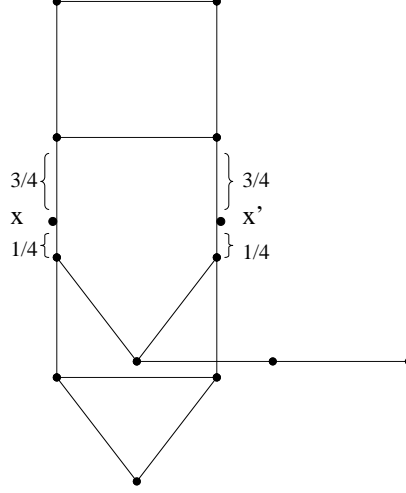

FIGURE 9. The projection need not be open.

Now, suppose that $\forall z \in C_{i,\delta_1} \quad d(z, y) = d(x, y) - d(x, z)$. Applying Lemma 5.8 on y, x we obtain a ball about y , $B(y, \delta_2)$ so that, since $y \in cl(X \setminus \bar{B}(x, \varepsilon))$, at least one of the components D_{1,δ_2} will be such that $d(z', x) = d(z', y) + d(y, x) \quad \forall z' \in D_{1,\delta_2}$. Let $\delta < \min\{\delta_1, \delta_2\}$. $\forall z \in C_{i,\delta} \quad d(z, y) = d(x, y) - d(x, z)$ and hence $\bar{B}(z, \varepsilon) \cap D_{1,\delta} = \bar{B}(y, d(x, z)) \cap D_{1,\delta}$. Thus $\forall z, z' \in C_{i,\delta} \quad d_H(\bar{B}(z, \varepsilon), \bar{B}(z', \varepsilon)) \geq d(z, z')$.

Hence, by the properties of the length metric, for any pair of points $z, z' \in X$ $d_H(\bar{B}(z, \varepsilon), \bar{B}(z', \varepsilon)) \leq d(z, z')$ finishing the proof. \square

Proposition 5.22. *Let X be a finite metric graph and let $x \in X$ and $\varepsilon > 0$ be such that $\bar{B}(x, \varepsilon) \neq X$. Then, $p_\varepsilon^{-1}(\bar{B}(x, \varepsilon))$ has a finite number of points.*

Proof. If $\bar{B}(x, \varepsilon) \neq X$, then there is a point $y \in \partial \bar{B}(x, \varepsilon) \cap cl(X \setminus \bar{B}(x, \varepsilon))$. For any point x' such that $\bar{B}(x', \varepsilon) = \bar{B}(x, \varepsilon)$ also $y \in \partial \bar{B}(x', \varepsilon) \cap cl(X \setminus \bar{B}(x', \varepsilon))$ and $d(x', y) = \varepsilon$. This means that $p_\varepsilon^{-1}(\bar{B}(x, \varepsilon))$ is contained in $S(y, \varepsilon)$ which is a finite number of points by Lemma 5.6. \square

Lemma 5.23. *Fixed any $\varepsilon > 0$, $\forall x \in X$ and $\forall \delta_0 > 0$ there exists some $\delta_1 > 0$ such that $\forall z \notin B(p_\varepsilon^{-1}(\bar{B}(x, \varepsilon)), \delta_0)$, $d_H(\bar{B}(z, \varepsilon), \bar{B}(x, \varepsilon)) > \delta_1$.*

Proof. Otherwise, there would be some $\delta_0 > 0$ such that for each $\delta_n = \frac{1}{n}$ there is a point $z_n \notin B(p_\varepsilon^{-1}(\bar{B}(x, \varepsilon)), \delta_0)$ for which $d_H(\bar{B}(z_n, \varepsilon), \bar{B}(x, \varepsilon)) \leq \frac{1}{n}$.

Since X is compact there is a cluster point z of (z_n) and obviously $\bar{B}(z, \varepsilon) = \bar{B}(x, \varepsilon)$. Thus $z \in p_\varepsilon^{-1}(\bar{B}(x, \varepsilon))$ and it is a cluster point of z_n which leads to a contradiction since $z_n \notin B(p_\varepsilon^{-1}(\bar{B}(x, \varepsilon)), \delta_0)$. \square

Proposition 5.24. *If X is a finite metric graph and $\varepsilon > 0$ is such that $X \in p_\varepsilon(X)$, then $p_\varepsilon^{-1}(X)$ is locally connected.*

Proof. Let $x \in p_\varepsilon^{-1}(X)$. If $\partial\bar{B}(x, \varepsilon) = \emptyset$ then, since X is compact, let $\varepsilon' := \max_{y \in X} \{d(x, y)\} < \varepsilon$. Hence, if $0 < \delta < \varepsilon - \varepsilon'$, then $\forall z \in B(x, \delta) \quad \bar{B}(z, \varepsilon) = X$.

If $\partial\bar{B}(x, \varepsilon) = \{y_1, \dots, y_k\}$ we use Lemma 5.8 with each y_i and we consider a minimum $\delta > 0$ for the k points such that each connected component C_i of $B(x, \delta) \setminus \{x\}$ is contained in some edge and $\forall z \in C_i$ and $\forall i$, $d(z, y_i) = d(x, y_i) + d(x, z)$ or $d(z, y_i) = d(x, y_i) - d(x, z)$. Consider C_1, \dots, C_r those components for which $d(z, y_i) = d(x, y_i) - d(x, z)$ for every i (if any). If we also impose that $0 < \delta < \varepsilon - \max_{a \in K_{x, \varepsilon}} \{d(a, x)\}$, then $\bar{B}(z, \varepsilon) = X \quad \forall z \in C_i$ with $i \leq r$.

If $z \in C_i$ with $i > r$, then at least for one of the border points y_j , $d(z, y_j) > \varepsilon$ and hence $\bar{B}(z, \varepsilon) \neq X$.

Thus, $B(x, \delta) \cap p_\varepsilon^{-1}(X) = \{x\} \cup C_1 \cup \dots \cup C_r$ and it is connected. \square

Proposition 5.25. *If X is a finite metric graph then for any $x \in X$ and any $\varepsilon > 0$, $p_\varepsilon^{-1}(\bar{B}(x, \varepsilon))$ has a finite number of connected components.*

Proof. If $\bar{B}(x, \varepsilon) \neq X$, then by Proposition 5.22, $p_\varepsilon^{-1}(\bar{B}(x, \varepsilon))$ has a finite number of points and we are done.

If $\bar{B}(x, \varepsilon) = X$, by Proposition 5.24, $p_\varepsilon^{-1}(X)$ is locally connected which implies that the connected components are open. Also, since p_ε is continuous, $p_\varepsilon^{-1}(X)$ is compact. Therefore, the connected components must be finite since they define an open covering of a compact set. \square

We take the following definitions and the characterization of a graph from chapter IX in [21]. $Bd(V)$ denotes the boundary of a set V , this is, $Bd(V) = \bar{V} \cap (\bar{V}^c)$.

Definition 5.26. *Let (X, T) a topological space, and let $A \subset X$. Let β be a cardinal number. We say that A is of order less than or equal to β in X , written*

$$\text{ord}(A, X) \leq \beta,$$

provided that for each $U \in T$ such that $A \subset U$, there exists $V \in T$ such that

$$A \subset V \subset U \text{ and } |Bd(V)| \leq \beta.$$

We say that A is of order β in X , written

$$\text{ord}(A, X) = \beta,$$

provided that $\text{ord}(A, X) \leq \beta$ and $\text{ord}(A, X) \not\leq \alpha$ for any cardinal number $\alpha < \beta$. If $A = \{p\}$ it is usually denoted $\text{ord}(p, X)$ instead of $\text{ord}(\{p\}, X)$.

Theorem 5.27. [21] *A continuum X (i.e. compact connected and metrizable) is a graph if and only if (1) and (2) below both hold:*

- (1) $\text{ord}(x, X) < \aleph_0$ for all $x \in X$;
- (2) $\text{ord}(x, X) \leq 2$ for all but finitely many $x \in X$.

Proposition 5.28. *If X is a finite metric graph, then $\forall p \in p_\varepsilon(X) \quad \text{ord}(p, p_\varepsilon(X)) < \aleph_0$.*

Proof. Let $p \in p_\varepsilon(X)$. If $p \neq \{X\}$, by Proposition 5.22, the inverse image is a finite number of points. Let $p_\varepsilon^{-1}(p) = \{x_1, \dots, x_n\}$. Let $\delta > 0$ such that Lemma 5.21 holds for x_1, \dots, x_n . Then, by Lemma 5.23 there exists some $\delta_1 > 0$ such that $\forall z \notin B(p_\varepsilon^{-1}(p), \delta)$ then $d_H(\bar{B}(z, \varepsilon), p) > \delta_1$. (Assume also $\delta < \frac{1}{2}d(x_i, x_j) \forall i \neq j$). So

let $\delta_0 < \delta_1, \delta$ and let us study the boundary $Bd(P(p, \delta_0))$ where $P(p, \delta_0)$ represents the ball about p of radius δ_0 in $p_\varepsilon(X)$ with the Hausdorff metric restricted from 2^X .

First, note that Lemma 5.23 means that $P(p, \delta_0) \subset p_\varepsilon(B(p_\varepsilon^{-1}(p), \delta))$. But there is a unique point at distance $\delta_0 < \delta$ from x_i in each connected component of $B(x_i, \delta)$ and then, by Lemma 5.21, since there is a finite number of points in $p_\varepsilon^{-1}(p)$ and the graph is locally finite, there will be a finite number of different balls $p_j \in p_\varepsilon(X)$ such that $d_H(p_j, p) = \delta_0$. Thus $|Bd(P(p, \delta_0))| < \aleph_0 \forall \delta_0 < \delta_1$ and $ord(p, p_\varepsilon(X)) < \aleph_0$.

Otherwise, suppose $p = \{X\}$. By Lemma 5.25 $p_\varepsilon^{-1}(X)$ has finitely many connected components. Then $Bd(p_\varepsilon^{-1}(X))$ has a finite number of points $\{x_1, \dots, x_n\}$ which hold that $\partial \bar{B}(x_i, \varepsilon) \neq \emptyset \forall i = 1, n$.

Let $\delta > 0$ such that Corolary 5.18 holds for x_1, \dots, x_n and apply Lemma 5.23 to get some $\delta_1 > 0$ such that $\forall z \notin B(p_\varepsilon^{-1}(X), \delta)$ then $d_H(\bar{B}(z, \varepsilon), p) > \delta_1$. Now let $\delta_0 < \delta_1, \delta$ and let us study the boundary $Bd(P(p, \delta_0))$. By Corolary 5.18, there is at most a finite number of points z_j in each ball $B(x_i, \delta)$ (assume also $\delta < \frac{1}{2}d(x_i, x_i) \forall i \neq j$) such that $d_H(\bar{B}(x_i, \varepsilon), \bar{B}(z_j, \varepsilon)) = \delta_0$ and, by Lemma 5.23, any point whose ball is in $P(X, \delta)$ must be in one of those $B(x_i, \delta)$. Hence $|Bd(P(X, \delta_0))| < \aleph_0 \forall \delta_0 < \delta_1$ and $ord(X, p_\varepsilon(X)) < \aleph_0$. \square

Using the inductive definition of dimension it is now immediate the following.

Corollary 5.29. *If X is a finite metric graph then $p_\varepsilon(X)$ is 1-dimensional for every ε .*

Proof. $\forall p \in p_\varepsilon(X)$ $ord(p, p_\varepsilon(X)) < \aleph_0$ which means that for any point p there are arbitrarily small neighborhoods whose boundary consists of finitely many points and these are obviously isolated. \square

We are going to use the following characterization of being a graph in terms of the order from [21, 9.10] stated in Theorem 5.27. Hence, by 5.29 we only need to prove that for every point in X but finitely many, the order is ≤ 2 , this is, that there are neighborhoods in $p_\varepsilon(X)$ arbitrarily close to the projection of that point whose boundary consists exactly on two points.

Theorem 5.30. *If X is a finite metric graph, then for any $\varepsilon > 0$ $p_\varepsilon(X)$ is a graph.*

Proof. First note that $p_\varepsilon(X)$ is a continuum since p_ε is continuous.

By Proposition 5.28, we know that $\forall p \in p_\varepsilon(X)$ $ord(p, p_\varepsilon(X)) < \aleph_0$.

By Proposition 5.9, $p_\varepsilon(X) \setminus p_\varepsilon(A_\varepsilon)$ consists of a finite number of points, so it suffices to check that $ord(\bar{B}(x, \varepsilon), p_\varepsilon(X)) = 2 \forall x \in A_\varepsilon$.

Let $x \in A_\varepsilon$. If there are not $x' \neq x$ such that $\bar{B}(x, \varepsilon) = \bar{B}(x', \varepsilon)$ or, equivalently, if $p_\varepsilon^{-1}(p_\varepsilon(x)) = \{x\}$, then there exists some $\delta > 0$ such that $\forall z \in B(x, \delta)$, $p_\varepsilon^{-1}(p_\varepsilon(z)) = \{z\}$. By Lemma 5.23 we know that there exists some δ_0 such that $P(p, \delta_0) \subset p_\varepsilon(B(p_\varepsilon^{-1}(p), \delta))$ (where $p = p_\varepsilon(x)$) and therefore, it is immediate to see that the order is 2.

Let $x \in A_\varepsilon$ and $x' \neq x$ such that $\bar{B}(x, \varepsilon) = \bar{B}(x', \varepsilon)$. Let $x \in [v_0, v_1]$, $d_0 = d(x, v_0)$, $d_1 = d(x, v_1)$ and $\{y_1, \dots, y_n\} = \partial \bar{B}(x, \varepsilon) \cap cl(X \setminus \bar{B}(x, \varepsilon))$. It is obviously necessary that $\varepsilon > d_1$ to allow the existence of such an x' . Since $\bar{B}(x, \varepsilon) \neq X$, $n \geq 1$ and there is some $y \in [w, w']$ such that $d(x, y) = d_0 + k + d'_0 = d_1 + k' + d'_1$ and hence any geodesic segment $[x, y]$ contains a vertex w with $d(w, y) = d'_0$ or $d(w, y) = d'_1$. Since y is also a point in $\bar{B}(x', \varepsilon) \cap cl(X \setminus \bar{B}(x', \varepsilon))$, any geodesic segment $[y, x']$ has

length ε and contains $[w, y]$. Then, $x' \in e' = [v'_0, v'_1]$ some edge with $d(x', v'_0) = d_0$ and $d(x', v'_1) = d_1$.

Let γ_i be a geodesic segment (of length ε) from x to y_i and γ'_i a geodesic segment (of length also ε) from x' to y_i . As we saw in Lemma 5.14, there is a partition of $\{y_1, \dots, y_n\}$ so that $y_i \in [w_i, w'_i]$ with $d(w_i, x) = \varepsilon - d(w_i, y_i)$ and $d(w_i, y_i) = d'_0$ if $i \leq k$ and $d(w_i, y_i) = d'_1$ if $i > k$. Since $d'_0 \neq d'_1$, by Lemma 5.10, γ'_i contains v'_0 for $i \leq k$ and γ'_i contains v'_1 for $i > k$.

If we apply now Lemma 5.14 to x' we will immediately see that the election of the subsets $\{y_1, \dots, y_k\}$ and $\{y_{k+1}, \dots, y_n\}$ from Lemma 5.13 is independent from the center of the ball we are considering and, assuming δ small enough so that Lemma 5.16 holds for both x and x' , then $\forall z \in B(x, \delta), z' \in B(x', \delta)$ such that $d(z, v_0) = d(z', v'_0)$, $B(z, \varepsilon) = B(z', \varepsilon)$. Note that the description of the ball in this lemma only depends on the initial ball, which is the same, on δ , and on the partition of the border points which also coincides.

By 5.22, $p_\varepsilon^{-1}(p_\varepsilon(x))$ consists of a finite number of points $\{x_1, \dots, x_n\}$ and, as we have just seen, $x_i \in [v'_0, v'_1]$ for some edge with $d(v'_0, x_i) = d_0$ and $d(x_i, v'_1) = d_1$. Now let $\delta_0 > 0$ be small enough so that Lemma 5.16 holds $\forall x_i$ and, by Lemma 5.23, let δ_1 be such that $\forall z \notin B(p_\varepsilon^{-1}(\bar{B}(x, \varepsilon)), \delta_0)$, $d_H(\bar{B}(z, \varepsilon), \bar{B}(x, \varepsilon)) > \delta_1$.

Consider any $\delta < \delta_0, \delta_1$ small enough so that Lemma 5.19 also holds. Assume also $\delta < \frac{1}{2}d(x_i, x_j) \forall i \neq j$. Then, any point z such that $d_H(\bar{B}(z, \varepsilon), \bar{B}(x, \varepsilon)) = \delta$ must be contained in $B(p_\varepsilon^{-1}(\bar{B}(x, \varepsilon)), \delta_0)$ and, by Lemma 5.19, $P(p_\varepsilon(x), \delta_0)$ is isometric to $B(x_i, \delta_0)$ for any $x_i \in p_\varepsilon^{-1}(\bar{B}(x, \varepsilon))$. Thus $d(z, x_i) = \delta$ for some $x_i \in p_\varepsilon^{-1}(\bar{B}(x, \varepsilon))$. But this gives us two possible balls: $\bar{B}(z_0, \varepsilon)$ with $z_0 \in [v_0, x]$ and $d(z_0, x) = \delta$ and $\bar{B}(z_1, \varepsilon)$ with $z_1 \in [v_1, x]$ and $d(z_1, x) = \delta$. Any other ball coincides with one of those since we saw before that for any other point $z_0^j \in [v_0^j, x_j]$ with $d(z_0^j, x_j) = \delta$ or $z_1^j \in [v_1^j, x_j]$ with $d(z_1^j, x_j) = \delta$ then $\bar{B}(z_0^j, \varepsilon) = \bar{B}(z_0, \varepsilon)$ and $\bar{B}(z_1^j, \varepsilon) = \bar{B}(z_1, \varepsilon)$.

Thus, $\forall x \in A_\varepsilon$ $ord(\bar{B}(x, \varepsilon), p_\varepsilon(X)) = 2$ and $p_\varepsilon(X)$ is a graph. \square

Now, to conclude this analysis of the semiflow for finite graphs we prove that through the different levels, the projection takes on a finite number of topological types. Therefore, every topological property is a Weierstrass type property. We also prove that the Euler characteristic is bounded for the evolution giving a lower bound for the projection (for which, as we show in Example 4.1, may be smaller than the initial). This bound depends only on the number of edges of the original graph.

For any finite graph X and any $0 < \varepsilon \leq diam(X)$ let us define a new graph X_ε as a subdivision of X as follows. Let $\varepsilon = k \cdot \frac{1}{2} + \varepsilon_0$ with $0 \leq \varepsilon_0 < \frac{1}{2}$ and $k \in \mathbb{N}$. If $\varepsilon_0 = 0$ we divide each edge in two and the middle points of the edges become vertices of X_ε . If $\varepsilon_0 = \frac{1}{4}$ we divide each edge in four, each of them with length $\frac{1}{4}$ adding three new vertices. If $0 < \varepsilon_0 < \frac{1}{4}$ we define 5 new vertices w_1, \dots, w_5 on each edge $[v, v']$ such that w_3 is the middle point of the edge, $[v, w_1], [w_2, w_3], [w_3, w_4]$ and $[w_5, v']$ have length ε_0 and $[w_1, w_2], [w_4, w_5]$ have length $\frac{1}{2} - 2\varepsilon_0$. Finally, if $\frac{1}{4} < \varepsilon_0$ we define 5 new vertices w_1, \dots, w_5 on each edge $[v, v']$ such that w_3 is the middle point of the edge, $[v, w_1], [w_2, w_3], [w_3, w_4]$ and $[w_5, v']$ have length $\frac{1}{2} - \varepsilon_0$ and $[w_1, w_2], [w_4, w_5]$ have length $2\varepsilon_0 - \frac{1}{2}$. In both cases we divide each edge $[v, v']$ in six parts. We obtain a new graph and a canonical isometry $i : X_\varepsilon \rightarrow X$.

Definition 5.31. Let $X_\varepsilon / \sim_\varepsilon$ the quotient space under the relation $x \sim_\varepsilon x'$ if and only if $\bar{B}(x, \varepsilon) = \bar{B}(x', \varepsilon)$.

Given two topological spaces A and B , $A \cong B$ will denote that A and B are homeomorphic.

Remark 5.32. Obviously, $X_\varepsilon / \sim_\varepsilon \cong p_\varepsilon(X)$.

Theorem 5.33. $X_\varepsilon / \sim_\varepsilon$ is a graph where the relation \sim_ε holds that:

- (a) A point x in the interior of an edge of X_ε such that $\bar{B}(x, \varepsilon) \neq X$ is related to another point if and only if both are in different edges and those edges are identified in the quotient.
- (b) A vertex v of X_ε such that $\bar{B}(v, \varepsilon) \neq X$ can only be related with another vertex.
- (c) If x is an interior point of an edge of X_ε such that $\bar{B}(x, \varepsilon) = X$, then $\bar{B}(y, \varepsilon) = X$ for every point y in that edge. In this case, that edge defines a vertex in $X_\varepsilon / \sim_\varepsilon \cong p_\varepsilon(X)$.

Proof. If $\varepsilon \leq 1$ it's readily seen that for any pair of points their balls only coincide if they contain the whole space and therefore the theorem holds.

Suppose $\varepsilon > 1$ and let $\varepsilon = k\frac{1}{2} + \varepsilon_0$ with $0 \leq \varepsilon_0 < \frac{1}{2}$. Let m the middle point of an edge and v one of its vertices. Any point in the interior of the half edge $z \in (v, m)$ immediately belongs to A_ε if $d(z, v) \neq \varepsilon_0$ and $d(z, m) \neq \varepsilon_0$. Consider the graph X_ε homeomorphic to X as it is described above.

If $\varepsilon_0 = 0$, then $(v, m) \subset A_\varepsilon$. If $\varepsilon_0 = \frac{1}{4}$ and x_1 represents the middle point of (v, m) , then $A_1 = (v, x_1) \subset A_\varepsilon$ and $A_2 = (x_1, m) \subset A_\varepsilon$. If $\varepsilon_0 \neq 0, \frac{1}{4}$, then there are two points $x_1, x_2 \in (v, m)$ such that, at least $A_1 = (v, x_1) \subset A_\varepsilon$, $A_2 = (x_1, x_2) \subset A_\varepsilon$ and $A_3 = (x_2, m) \subset A_\varepsilon$.

To prove (a), let $A_i \subset A_\varepsilon$ with $i \leq 3$ in any of the cases. Let $z \in A_i$ and $z' \in X$ such that $\bar{B}(z, \varepsilon) = \bar{B}(z', \varepsilon)$. As we saw in the proof of Theorem 5.30, z' is contained in some edge $[v_1, v_2]$ with $d(z', v_1) = d(z, v)$, and if we consider $[v_1, m']$ with m' the middle point, then $z' \in A'_i \subset A_\varepsilon$. Also, as we saw in the same proof, there exists some $\delta > 0$ such that for any $y \in B(z, \delta)$, $y' \in B(z', \delta)$, if $d(y, v) = d(y', v_1)$ the closed balls coincide, $\bar{B}(y, \varepsilon) = \bar{B}(y', \varepsilon)$. Thus, the points of A_i for which there exists a point in A'_i whose image by p_ε is the same, form an open set in A_i . On the other side, if $y_n \in A_i$ is a sequence convergent to y , $y'_n \in A'_i$ is a sequence convergent to y' and $\bar{B}(y_n, \varepsilon) = \bar{B}(y'_n, \varepsilon)$ for every n , obviously $\bar{B}(y, \varepsilon) = \bar{B}(y', \varepsilon)$ and therefore, the points in A_i for which there exist a point in A'_i whose image by p_ε coincides is open and closed in A_i with A_i connected. This implies that if there exists such a pair of points z, z' then $\forall y \in A_i$ y $\forall y' \in A'_i$ with $d(y, v) = d(y', v_1)$, $p_\varepsilon(y) = p_\varepsilon(y')$.

(b) is an immediate consequence from (a).

Let us check (c). Let $A_i \subset A_\varepsilon$ with $i \leq 3$ in any of the cases and suppose $z \in A_i$ such that $\bar{B}(z, \varepsilon) = X$. As we saw in the proof of Lemma 5.16, if z is contained in any cycle of length $\leq 2\varepsilon$ ($A_i \subset e$ is part of it) then the whole cycle is contained in the closed ball about any point of e and, in particular, about any point of A_i . Any other border point of $\bar{B}(z, \varepsilon) = X$ must be a middle point or a vertex but this is not possible for a point in A_i and we must conclude that $\forall z' \in A_i$ $\bar{B}(z', \varepsilon) = X$. \square

Proposition 5.34. $\forall \varepsilon > 0$ the Euler's characteristic of $p_\varepsilon(X)$ holds that $\aleph(p_\varepsilon(X)) \geq 1 - 6|\mathcal{E}|$ where $|\mathcal{E}|$ denotes the number of edges in X .

Proof. Let $\varepsilon \leq 1$. If X has at least two edges, then every pair of points have different balls. If X consists just of one edge, then $p_\varepsilon(X)$ is also contractible and the proposition holds.

Suppose $\varepsilon > 1$. Clearly, X and X_ε have the same Euler's characteristic. Let us check what happens with the possible identifications of $[v, m]$ in X/\sim as in Lemma 4.8. Since we have at most $6|\mathcal{E}|$ edges and at least 1 vertex, $\aleph(X/\sim) \geq 1 - 6|\mathcal{E}|$. In fact, if $N_0(\varepsilon)$ is the number of subsets $A_i(\varepsilon)$ such that $\forall z' \in A_i \quad \bar{B}(z', \varepsilon) = X$ then $\aleph(X/\sim) \geq 1 + 2N_0(\varepsilon) - 6|\mathcal{E}|$. \square

Corollary 5.35. *For every finite graph X , $H_1(p_\varepsilon(X)) = \mathbb{Z}^m$ with $m \leq 6|\mathcal{E}| - N_0(\varepsilon)$.*

Definition 5.36. *By a critical time we mean any ε for which there is a sequence $0 < t_1 < t_2 < \dots < \varepsilon$ convergent to ε and such that for every $i > 0$ $f_{t_i}(X)$ is not homeomorphic to $p_\varepsilon(X)$.*

Lemma 5.37. *Let C_1, C_2, \dots, C_k be the minimal cycles in X with lengths $l(C_1) = l_1, \dots, l(C_k) = l_k$. Let $\varepsilon' > 0$ such that $2\varepsilon' \neq l_i \forall i$ and $x \in A_{\varepsilon'}$. If $\{y_1, \dots, y_n\} = \partial\bar{B}(x, \varepsilon')$, then there exists some $\delta_0 > 0$ such that if $\varepsilon' - \varepsilon = \delta < \delta_0$ then $\bar{B}(x, \varepsilon) = \bar{B}(x, \varepsilon') \setminus \{\cup_{i=1}^n B(y_i, \delta)\}$.*

Proof. Claim. $\partial\bar{B}(x, \varepsilon') \subset cl(X \setminus \bar{B}(x, \varepsilon'))$.

Suppose $y \in \partial\bar{B}(x, \varepsilon') \setminus cl(X \setminus \bar{B}(x, \varepsilon'))$ with $x \in [v_0, v_1]$ and $y \in [u_0, u_1]$. Since $y \in \bar{B}(x, \varepsilon') \setminus cl(X \setminus \bar{B}(x, \varepsilon'))$, $[u_0, u_1] \subset \bar{B}(x, \varepsilon')$ and, in particular, there are two geodesic segments of length ε' , γ_0, γ_1 , such that $u_0 \in \gamma_0$ and $u_1 \in \gamma_1$.

If there is v_i with $i = 0, 1$ so that $v_i \in \gamma_0 \cap \gamma_1$ then $d(x, v_i) + d(v_i, u_0) + d(u_0, y) = \varepsilon' = d(x, v_i) + d(v_i, u_1) + d(u_1, y)$. Hence, $d(v_i, u_0) + d(u_0, y) = d(v_i, u_1) + d(u_1, y)$ and, since $d(v_i, u_j) \in \mathbb{Z}$ for $j = 0, 1$, then $|d(u_0, y) - d(u_1, y)|$ is an integer number which means that y is either a vertex or a middle point. This contradicts the fact that $x \in A_\varepsilon$ and, therefore, $d(y, u_i) \neq 0, \frac{1}{2}, 1$.

Thus, we may assume, relabelling u_0, u_1 if necessary, that $v_0, u_0 \in \gamma_0$ and $v_1, u_1 \in \gamma_1$. As we saw in Lemma 5.15, see Figure 7, this implies that γ_0, γ_1 form a minimal cycle of length $2\varepsilon'$ which is a contradiction. This proves the claim.

Let $\{y_1, \dots, y_n\} = \partial\bar{B}(x, \varepsilon') \subset cl(X \setminus \bar{B}(x, \varepsilon'))$. Let $\delta_0 < \delta_2$ be such that the balls $\bar{B}(y_i, \delta_0)$ are disjoint and contained in some edge. Suppose also that $\varepsilon' - \delta_0 > \max_{a \in K_{x, \varepsilon'}} \{d(a, x)\}$ (in particular, $\frac{l_i}{2} \notin (\varepsilon' - \delta_0, \varepsilon')$). It is immediate to check that if $\varepsilon = \varepsilon' - \delta$ for some $\delta < \delta_0$ $\bar{B}(x, \varepsilon) = \bar{B}(x, \varepsilon') \setminus \{\cup_{i=1}^n B(y_i, \delta)\}$. \square

The main point of this lemma is that for any ε' but a finite number and any $x \in A_{\varepsilon'}$ the ball about x of radius $\varepsilon = \varepsilon' - \delta$ (with δ small enough) is determined by the ball of radius ε' and the number δ independently of its center x .

Remark 5.38. *Let X be a finite metric graph and let $\varepsilon' > 0$ such that $\varepsilon' = k \cdot \frac{1}{2} + \varepsilon'_0$ with $0 < \varepsilon'_0 < \frac{1}{2}$ and $\varepsilon'_0 \neq \frac{1}{4}$. Suppose $\delta_0 < \varepsilon'_0, |\varepsilon'_0 - \frac{1}{4}|$. Then, for any $\varepsilon \in (\varepsilon' - \delta_0, \varepsilon')$ there is a canonical simplicial map $i_{\varepsilon, \varepsilon'}: X_\varepsilon \rightarrow X_{\varepsilon'}$ which is an isomorphism.*

Theorem 5.39. *For every finite metric graph X there is a finite number of critical times.*

Proof. Let C_1, \dots, C_k be the minimal cycles in X with lengths $l(C_1) = l_1, \dots, l(C_k) = l_k$. Let $\varepsilon' > 0$ be such that $2\varepsilon' \neq l_i \forall i$ and suppose $\varepsilon' = k \cdot \frac{1}{2} + \varepsilon'_0$ with $0 < \varepsilon'_0 < \frac{1}{2}$ and $\varepsilon'_0 \neq 0, \frac{1}{4}$. Note that this includes every possible $\varepsilon' \leq \text{diam}(X)$ but a finite number.

Now let $0 < \delta_0$ such that $\delta_0 < |2\varepsilon' - l_i| \forall i$ and $\delta_0 < \varepsilon'_0, |\varepsilon'_0 - \frac{1}{4}|$. Then we claim that there is some $\delta \leq \delta_0$ such that $\forall \varepsilon \in (\varepsilon' - \delta, \varepsilon')$, $p_\varepsilon(X) \cong p_{\varepsilon'}(X)$ and ε' is not a critical time. We are going to prove the existence of some δ for each edge and each vertex of $X_{\varepsilon'}$. Then, since they are a finite number, it suffices to take the minimum.

First, let us study the edges of $X_{\varepsilon'}$.

Case 1 Suppose $\varepsilon'_0 < \frac{1}{4}$. Let (v, m) half an edge with v a vertex and m a middle point. Consider the graph $X_{\varepsilon'}$ defined above and let $w_1, w_2 \in (v, m)$ be the points dividing (v, m) in three parts: $A_1^{\varepsilon'} = (v, w_1)$ of length ε'_0 , $A_2^{\varepsilon'} = (w_1, w_2)$ with length $\frac{1}{2} - 2\varepsilon'_0$ and $A_3^{\varepsilon'} = (w_2, m)$ with length ε'_0 .

Consider also the graph X_ε with $\varepsilon' - \varepsilon < \delta_0$. Then, by Remark 5.38, the half edge (v, m) is divided in three parts $A_1^\varepsilon, A_2^\varepsilon, A_3^\varepsilon$ and $i_{\varepsilon, \varepsilon'}: X_\varepsilon \rightarrow X_{\varepsilon'}$ holds that $i_{\varepsilon, \varepsilon'}(A_i^\varepsilon) = A_i^{\varepsilon'}$ for $i = 1, 2, 3$.

Since $\varepsilon' - \varepsilon < \delta_0$, there exists some $x_i \in A_i^{\varepsilon'} \cap A_i^\varepsilon \forall i = 1, 2, 3$. Clearly, either $x_i \in A_{\varepsilon'}$ or $\bar{B}(x_i, \varepsilon') = X$ with no vertices in the border.

If $x_i \in A_{\varepsilon'}$, then, by Lemma 5.37, there is some $\delta > 0$ such that if $\varepsilon' - \varepsilon < \delta$, then $x_i \sim_{\varepsilon'} x'_i$ if and only if $x_i \sim_\varepsilon x'_i$.

If $\bar{B}(x_i, \varepsilon') = X$ since $2\varepsilon' \neq l_i \forall i$, by Lemma 5.15, $\partial B(x_i, \varepsilon') = \emptyset$. Therefore, there exists $\delta > 0$ such that $\forall \varepsilon \in (\varepsilon' - \delta, \varepsilon)$, $\bar{B}(x_i, \varepsilon) = X$. The same holds for $x'_i \in A_i^{\varepsilon'}$ and, therefore, $x_i \sim_{\varepsilon'} x'_i$ if and only if $x_i \sim_\varepsilon x'_i$. By Theorem 5.33, $A_i^{\varepsilon'} \sim_{\varepsilon'} A_i^{\varepsilon}$ if and only if $A_i^\varepsilon \sim_\varepsilon A_i^{\varepsilon}$.

Hence, taking the minimum δ over all $A_i^{\varepsilon'}$, we conclude that the identification of edges in X_ε is the same as in $X_{\varepsilon'}$.

Case 2 If $\frac{1}{4} < \varepsilon'_0 < \frac{1}{2}$ the argument is analogous redefining the partitions A_i^ε and $A_i^{\varepsilon'}$.

Consider now any vertex: $w_0 = v, w_1, w_2$ or $w_3 = m$ of $X_{\varepsilon'}$.

If $w_i \not\sim_{\varepsilon'} w'_i$ then $w_i \not\sim_\varepsilon w'_i$ for any $\varepsilon < \varepsilon'$ since, in a length space, once the balls about two points coincide for some radius they coincide also for any bigger radius. Thus, it suffices to check that if $w_i \sim_{\varepsilon'} w'_i$, then there exists some $0 < \delta < \delta_0$ such that, $\forall \varepsilon \in (\varepsilon' - \delta, \varepsilon')$ the corresponding vertices in X_ε , $v_i = i_{\varepsilon, \varepsilon'}^{-1}(w_i), v'_i = i_{\varepsilon, \varepsilon'}^{-1}(w'_i)$ hold that $v_i \sim_\varepsilon v'_i$.

First note that for the condition to fail, the edges adjacent to w_i and w'_i can't be identified at level ε' . Otherwise, as we just saw, there would exist some δ so that for any $\varepsilon \in [\varepsilon' - \delta, \varepsilon']$ the corresponding edges are identified and, with them, the vertices in their closure.

Also, if every point in the border of the ball were in the interior of an edge of X different from the middle point, using the same argument from 5.37 and assuming δ small enough, we obtain that $w_i \sim_\varepsilon w'_i$ with w_i, w'_i contained in edges adjacent to v_i and v'_i . Therefore, those edges are identified at level ε and, with them, the vertices v_i and v'_i in their closure.

Thus, let us see the case where $\partial \bar{B}(w_i, \varepsilon') = \partial \bar{B}(w_i, \varepsilon')$ contains vertices or middle point of edges in X . Since we assumed that $0 < \varepsilon_0 < \frac{1}{2}$, it suffices to consider the vertices in $X_{\varepsilon'}$ which are not vertices nor middle points of edges in X .

So, let us suppose that w, w' are two vertices of $X_{\varepsilon'}$ which are not vertices nor middle point of edges in X , suppose that $w \sim_{\varepsilon'} w'$, suppose that no edge of $X_{\varepsilon'}$ adjacent to w is identified with any other edge adjacent to w' . Suppose $\partial \bar{B}(w, \varepsilon')$ and $\partial \bar{B}(w', \varepsilon')$ contain vertices or middle point of edges in X and suppose that for

every $0 < \delta < \delta_0$ there is some $\varepsilon \in (\varepsilon' - \delta, \varepsilon')$ such that $v = i_{\varepsilon, \varepsilon'}^{-1}(w), v' = i_{\varepsilon, \varepsilon'}^{-1}(w')$ hold that $v \sim_\varepsilon v'$. This will lead to contradiction.

Let us fix $[v, m]$ the middle edge in X containing w and $[v', m']$ the middle edge in X containing w' . Let us relabel $\{a, b\} = \{v, m\}$ so that $d(w, a) = \varepsilon'_0$, $d(w, b) = \frac{1}{2} - \varepsilon'_0$ and $\{a', b'\} = \{v', m'\}$ so that $d(w', a') = \varepsilon'_0$, $d(w', b') = \frac{1}{2} - \varepsilon'_0$. See figure 10.

This takes account of all the possible cases:

- a) If $0 < \varepsilon_0 < \frac{1}{4}$ and $d(w, v) = d(w', v') = \varepsilon_0$.
- b) If $0 < \varepsilon_0 < \frac{1}{4}$ and $d(w, m) = d(w', m') = \varepsilon_0$.
- c) If $\frac{1}{4} < \varepsilon_0 < \frac{1}{2}$ and $d(w, v) = d(w', v') = \frac{1}{2} - \varepsilon_0$.
- d) If $\frac{1}{4} < \varepsilon_0 < \frac{1}{2}$ and $d(w, v) = d(w', v') = \frac{1}{2} - \varepsilon_0$.

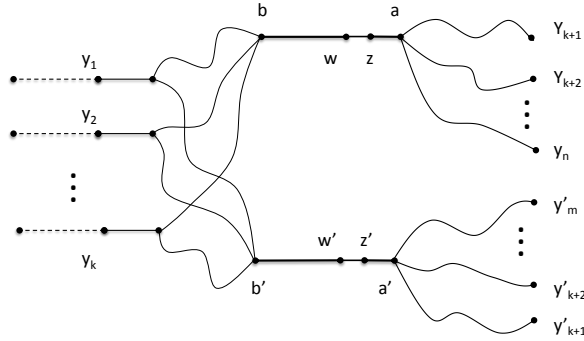

FIGURE 10. Ideal representation where all the border points are in different edges.

We are considering $\varepsilon'_0 \neq \frac{1}{4}$, $|\varepsilon'_0 - \frac{1}{2}| \neq k\frac{1}{2}$ for any $k \in \mathbb{Z}$. This means that there is a canonical partition of $\partial B(w, \varepsilon') = \{y_1, \dots, y_k\} \cup \{y_{k+1}, \dots, y_n\}$ where $\{y_1, \dots, y_k\}$ are the border points which are not vertices nor middle points, i.e., border points y_j so that the geodesic segment $[w, y_j]$ contains b , and $\{y_{k+1}, \dots, y_n\}$ are the border points which are vertices or middle points, i.e., border points y_j so that the geodesic segment $[w, y_j]$ contains a .

Also, it is immediate to check that $\{y_1, \dots, y_k\} \subset cl(X \setminus \bar{B}(w, \varepsilon))$.

The same argument works for w' and, since $cl(X \setminus \bar{B}(w, \varepsilon')) = cl(X \setminus \bar{B}(w', \varepsilon'))$ we obtain that $\partial B(w', \varepsilon') = \{y_1, \dots, y_k\} \cup \{y'_{k+1}, \dots, y'_m\}$ where $\{y_1, \dots, y_k\}$ are the border points which are not vertices nor middle points, i.e., border points so that the geodesic segment $[w', y_j]$ contains b' (and these are the same for w and w'), and $\{y'_{k+1}, \dots, y'_m\}$ are the border points which are vertices or middle points, i.e., border points y'_j so that the geodesic segment $[w', y'_j]$ contains a' . (Notice that

$\{y'_{k+1}, \dots, y'_m\}$ need not be equal to $\{y_{k+1}, \dots, y_n\}$ if there are border points which are not in $cl(X \setminus \bar{B}(w, \varepsilon'))$. See figure 9).

Let C be the set of edges in X contained in the open ball $B(w, \varepsilon')$ and C' be the set of edges in X contained in the open ball $B(w', \varepsilon')$. Since the realizations $|C|, |C'|$ are compact, there is some δ_1 such that $|C| \subset B(w, \varepsilon' - \delta_1)$ and $|C'| \subset B(w', \varepsilon' - \delta_1)$.

Let $\delta < \varepsilon_0, \delta_1$ be such that the balls $B(y_j, 2\delta)$ are disjoint and contained in the interior of half an edge of $X \forall 1 \leq j \leq k$. Let $z \in [a, w]$ so that $d(z, w) = \delta$ and $z' \in [a', w']$ so that $d(z', w') = \delta$.

Claim: $\bar{B}(z, \varepsilon' - \delta) = \bar{B}(w, \varepsilon') \setminus \left(\bigcup_{j=1}^k B(y_j, 2\delta) \right) = \bar{B}(w', \varepsilon') \setminus \left(\bigcup_{j=1}^k B(y_j, 2\delta) \right) = \bar{B}(z', \varepsilon' - \delta)$.

First, notice that $|C| \subset B(w, \varepsilon' - \delta)$ and $|C'| \subset B(w', \varepsilon' - \delta)$. By Lemma 5.8, it is immediate to check that $d(z, y_j) = d(w, y_j) - d(w, z) = d(w, y_j) - \delta$ for every $k+1 \leq j \leq n$ and $d(z', y'_j) = d(w', y'_j) - d(w', z') = d(w', y'_j) - \delta$ for every $k+1 \leq j \leq m$. Hence, for every edge e containing a point $y_j, k+1 \leq j \leq n$, the geodesic segment $\gamma = [w, y_j]$ holds that $\gamma \cap e \subset \bar{B}(z, \varepsilon' - \delta)$. Also, for any edge e' containing a point $y'_j, k+1 \leq j \leq m$, the geodesic segment $\gamma' = [w', y'_j]$ holds that $\gamma' \cap e' \subset \bar{B}(z', \varepsilon' - \delta)$. The only edges left are those containing the points $\{y_1, \dots, y_k\}$. Also, by Lemma 5.8, we have that $d(z, y_j) = d(w, y_j) + d(w, z) = d(w, y_j) + \delta$ and $d(z', y_j) = d(w', y_j) + d(w', z') = d(w', y_j) + \delta$ for every $1 \leq j \leq k$. Then, by the election of δ , it is clear that for any edge e containing a point $y_j, 1 \leq j \leq k$, and for any geodesic segment $\gamma = [w, y_j], (\gamma \cap e) \cap \bar{B}(z, \varepsilon' - \delta) = (\gamma \cap e) \setminus B(y_j, 2\delta)$ and for any geodesic segment $\gamma' = [w', y_j], (\gamma' \cap e) \cap \bar{B}(z', \varepsilon' - \delta) = (\gamma' \cap e) \setminus B(y_j, 2\delta)$. Therefore, we conclude the claim.

Hence, $\bar{B}(z, \varepsilon' - \delta) = \bar{B}(z', \varepsilon' - \delta)$. In particular, $z \sim_{\varepsilon'} z'$ and we obtain the contradiction since there are no adjacent edges identified. \square

Corollary 5.40. *For every finite metric graph X there is a finite number of possible topological types on the set of projections $\{p_\varepsilon(X) : \varepsilon > 0\}$.*

6. \mathbb{R} -TREES: GEOMETRICAL MODELS FOR THE SEMIFLOW

A *real tree* or \mathbb{R} -*tree* is a metric space (T, d) that is uniquely arcwise connected and $\forall x, y \in T$ the unique arc from x to y , denoted $[x, y]$, is isometric to the subinterval $[0, d(x, y)]$ of \mathbb{R} . In this section we are going to use \mathbb{R} -trees and their ends spaces, in the sense of [11] (see also [16] and [12]), to produce a geometrical model for the semiflow and use it to describe the identification process of the closed balls in the levels of the semiflow.

We propose here the idea that some properties of the semiflow can be reflected into geometrical properties of end spaces of certain \mathbb{R} -trees. We treat herein the property of being topologically robust. To do this we use Whitney functions on hyperspaces. Let us recall the definition from [20].

Definition 6.1. *Let $\mathcal{H} = 2^X$ or $C(X)$. A Whitney function in \mathcal{H} is a continuous function $w : \mathcal{H} \rightarrow [0, +\infty)$ satisfying:*

- (a) *If $A, B \in \mathcal{H}$ are such that $A \subset B$ and $A \neq B$ then $w(A) < w(B)$.*
- (b) *$w(\{x\}) = 0$ for every $x \in X$.*

It is well known the existence of a Whitney map $w : 2^X_H \rightarrow [0, \infty)$ for every nonempty compact metric space, see [20]. A natural way of defining levels on the

semiflow, instead of considering projections p_ε , would be to consider Whitney levels restricted to the semiflow $\mathcal{B} := \{\bar{B}(x, \varepsilon) \mid x \in X \text{ and } \varepsilon > 0\}$: $w^{-1}(t) \cap \mathcal{B}$.

Nevertheless, the behavior of those levels doesn't work for some of the results given here. For example, theorems 4.9 and 4.15 would fail even for very simple examples of Peano continua.

Let us define a projection $\pi_t : X \rightarrow w^{-1}(t) \cap \mathcal{B}$ sending each point $x \in X$ to the unique closed ball $\bar{B}(x, \varepsilon) \in \mathcal{B}$ such that $w(\bar{B}(x, \varepsilon)) = t$. This is well defined since w is continuous and strictly increasing.

First, let's see that if we try to do the same using levels defined by a Whitney function we lose information, specially with respect to the map relating the initial space with the corresponding level.

Example 6.2. *Let X be the $[0, 1]$ subinterval of the real line with the euclidean metric. For any Whitney function $w : 2^X_H \rightarrow [0, \infty)$ and for every $\varepsilon_0 > 0$ there exists $t < \varepsilon_0$ such that $\pi_t : X \rightarrow w^{-1}(t) \cap \mathcal{B}$ is not a homeomorphism.*

Let $0 < \varepsilon < 1$ such that $w(\bar{B}(0, \varepsilon)) = t$. Consider the closed ball $\bar{B}(\frac{\varepsilon}{2}, \frac{\varepsilon}{2})$. Clearly these two balls coincide and thus $\pi_t(0) = \pi_t(\frac{\varepsilon}{2})$ and π_t is not injective nor a homeomorphism.

Nevertheless we can establish some relation between Whitney levels and the levels defined in the semiflow.

Lemma 6.3. *For every $0 < \varepsilon_0$ there exists some $t_0 > 0$ such that $\forall t < t_0$ $w^{-1}(t) \cap \mathcal{B} \subset \cup_{\varepsilon \leq \varepsilon_0} p_\varepsilon(X)$.*

Proof. Since X is compact there exists $t_0 = \min_{x \in X} \{w(\bar{B}(x, \varepsilon_0))\}$. $\forall t < t_0$ and $\forall y \in X$ there exists some $\delta > 0$ such that $\pi_t(y) = \bar{B}(y, \delta)$ and, since the Whitney map is increasing on the trajectories, $\delta < \varepsilon_0$. \square

Lemma 6.4. *For every $0 < t_0$ there exists some $\varepsilon_0 > 0$ such that $\forall \varepsilon < \varepsilon_0$ and $\forall x \in X$ $w(\bar{B}(x, \varepsilon)) < t_0$.*

Proof. Since X is compact let $\varepsilon_0 = \min_{x \in X} \{\varepsilon \mid w(\bar{B}(x, \varepsilon)) = t_0\}$. \square

We may also give a Lyapunov function from the Whitney function, obtaining also that it takes value 1 on the single points:

Proposition 6.5. *For any compact length space (X, d) there exists a Lyapunov function $\Phi : C(X) \rightarrow [0, 1]$ with $\Phi(x) = 1 \forall x$ and $\Phi(X) = 0$.*

Proof. For any compact length space there exists $w : C(X) \rightarrow [0, 1]$ a Whitney map such that $w(x) = 0 \forall x \in X$ and $\Phi(X) = 1$. It suffices to define $\Phi(A) := 1 - w(A)$ to obtain such a Lyapunov function. Notice that we only need the function to be decreasing along trajectories and this comes from 3.3. \square

As we introduced above, now we are going to characterize the property of being topologically robust in terms of the geometry in the boundary of the \mathbb{R} -tree induced by the semiflow.

Lemma 6.6. [5] *A metric space (X, d) is an \mathbb{R} -tree if and only if it is connected and 0-hyperbolic.*

Definition 6.7. [8] *Given a base point x in a metric space (X, d) , the Gromov product of two points $y, z \in X$ is*

$$(y \cdot z)_x = \frac{1}{2} \{d(x, y) + d(x, z) - d(y, z)\}.$$

Let us define a subset $A \subset X \times [0, \text{diam}(X))$ where the pair $(x, t) \in A$ if $0 \leq t < t_x := \inf\{t : \bar{B}(x, t) = X\}$. Define an equivalence relation on A by $(x, t) \sim (y, t')$ if $\bar{B}(x, t_x - t) = \bar{B}(y, t_y - t')$. Note that if $(x, t) \sim (y, t')$, $\bar{B}(x, t_x - t) = \bar{B}(y, t_y - t')$ implies that $d_H(X, \bar{B}(x, t_x - t)) = t_x - (t_x - t) = t_y - (t_y - t') = d_H(X, \bar{B}(y, t_y - t'))$, and therefore, $t = t'$.

Let $S = A / \sim$ and let us endow S with the following metric. $D([x, t], [y, t']) = t_x - t + t_y - t' - 2\min\{t_x - t, t_y - t', l(x, y)\}$ where $l(x, y) = t_x - \inf\{s : \bar{B}(x, s) \cap \alpha_y \neq \emptyset\} = t_y - \inf\{s : \bar{B}(y, s) \cap \alpha_x \neq \emptyset\}$.

It can be seen with the same method used in Proposition 6.9 that the metric is well defined and (S, D) is an \mathbb{R} -tree. Then, fixing the class $v = [(x, 0)]$ which corresponds to the ball $\bar{B}(x, t_x) = X$ for every $x \in X$, (S, v) is a rooted tree. By a *branch* we mean any rooted non-extendable isometric embedding $f: [0, t] \rightarrow S$ (let us recall that rooted means that $f(0) = v$). Clearly, there exist a bijection between X and the branches of (S, v) . In fact, any branch $[x \times [0, t_x]]$ of (S, v) is isometric to the restriction of the hyperspace to the segment $(\alpha_x, d_H|_{\alpha_x})$ which Kelley called *segment from $\{x\}$ to $\{X\}$* , [14], or *order arc* according to [13] or [15]. Nevertheless, this tree is bounded and it is not geodesically complete. Hence, it is not suitable to represent the ramification process from a geometric point of view. Let us define it in such a way that the trajectories generate infinite branches.

Now, to define a geodesically complete \mathbb{R} -tree let us consider a Lyapunov function $\Phi: C(X) \rightarrow [0, 1]$ with $\Phi(x) = 1 \forall x$ and $\Phi(X) = 0$.

Let us parametrize α_x as follows: $\Phi_x^{-1}: [0, 1] \rightarrow X$ where $\Phi_x^{-1}(t) = \bar{B}(x, \varepsilon(x, t))$ such that $\Phi(\bar{B}(x, \varepsilon(x, t))) = 1 - t$. Note that this $\varepsilon(x, t)$ is uniquely determined by x and t .

Define an equivalence relation on $X \times [0, \infty)$ where (x, t) represents $\bar{B}(x, \varepsilon(x, e^{-t}))$ and $(x, t) \sim (y, t')$ if $\varepsilon(x, e^{-t}) = \varepsilon(y, e^{-t'})$ and $\bar{B}(x, \varepsilon(x, e^{-t})) = \bar{B}(y, \varepsilon(y, e^{-t'}))$. Note that when the balls coincide, the Lyapunov function on them will be $1 - e^{-t} = \Phi(\bar{B}(x, \varepsilon(x, e^{-t}))) = \Phi(\bar{B}(y, \varepsilon(y, e^{-t'}))) = 1 - e^{-t'}$ and hence, $t = t'$. Also note that when two balls with different radius coincide they are not identified in the tree, and the branches corresponding to their centers are disjoint from the root on.

Lemma 6.8. *If $(x, t) \sim (y, t)$ then $(x, t') \sim (y, t') \forall t' < t$.*

Proof. For any $t' < t$, $e^{-t'} > e^{-t}$ and let $\bar{B}(x, \varepsilon'_1) = \Phi_x^{-1}(e^{-t'})$ and $\bar{B}(y, \varepsilon'_2) = \Phi_y^{-1}(e^{-t'})$. By the properties of the length metric, since $\bar{B}(x, \varepsilon(x, e^{-t})) = \bar{B}(y, \varepsilon(y, e^{-t}))$, and $\varepsilon(x, e^{-t}) = \varepsilon(y, e^{-t}) = \varepsilon_0$, then $\forall \varepsilon' > \varepsilon_0$, $\bar{B}(x, \varepsilon') = \bar{B}(y, \varepsilon')$. Therefore, one of the balls $\bar{B}(x, \varepsilon'_1), \bar{B}(y, \varepsilon'_2)$ must be contained in the other and both are in the common part of the trajectories α_x, α_y ; but since the Lyapunov function on them takes the same value, $e^{-t'}$, those balls must coincide and with $\varepsilon'_i > \varepsilon_0$ and by lemma 3.3, this can only occur if $\varepsilon'_1 = \varepsilon'_2$ and thus, we finally obtain that $(x, t') \sim (y, t')$. \square

Let $T = X \times [0, \infty) / \sim$ and let us endow T with the following metric.

$D([x, t], [y, t']) = t + t' - 2\min\{t, t', m(x, y)\}$ where $m(x, y) = \sup\{s : (x, s) \sim (y, s)\}$.

Proposition 6.9. *D is a metric.*

Proof. D is Well defined. Suppose $[x, t] = [x', t]$, then we only need to show that $d([x, t], [y, t']) = d([x', t], [y, t'])$ for any $[y, t'] \in T$. We can distinguish two cases.

Case 1. $\sup\{s | (x, s) \sim (x', s)\} \geq \sup\{s | (x, s) \sim (y, s)\}$. Hence it is immediate to see that $m(x, y) = m(x', y)$ and the distance is the same.

Case 2. $t \leq \sup\{s|(x, s) \sim (x', s)\} < \sup\{s|(x, s) \sim (y, s)\}$. In this case, $t < m(x, y)$ and $t < m(x', y)$ and hence, $\min\{t, t', m(x, y)\} = \min\{t, t'\} = \min\{t, t', m(x', y)\}$ and the distance is the same.

D is a metric.

- 1) $D \geq 0$. It is clear that $t + t' - 2\min\{t, t', m(x, y)\} \geq |t - t'| \geq 0$.
- 2) $D([x, t], [y, t']) = 0 \Leftrightarrow [x, t] = [y, t']$. If $D([x, t], [y, t']) = 0$ then $t + t' - 2\min\{t, t', m(x, y)\} = 0 \Rightarrow \min\{t, t', m(x, y)\} = t = t'$ and since $m(x, y) \geq t = t'$ then $[x, t] = [y, t']$.
- 3) Symmetric. This is obvious since the definition is symmetric.
- 4) Triangle inequality, $D([x, s], [y, t]) \leq D([x, s], [z, u]) + D([z, u], [y, t])$. Clearly $t + s - 2\min\{s, t, m(x, y)\} \leq s + u - 2\min\{s, u, m(x, z)\} + u + t - 2\min\{u, t, m(z, y)\} \Leftrightarrow -\min\{s, t, m(x, y)\} \leq u - \min\{s, u, m(x, z)\} - \min\{u, t, m(z, y)\}$.

Let $a = m(x, z)$, $b = m(y, z)$, $c = m(x, y)$. Clearly $\min\{a, b\} \leq c$. Without loss of generality assume that $a \leq b$ and hence $a = \min\{a, b, c\}$.

Thus we need to show that $\min\{s, u, a\} + \min\{t, u, b\} \leq \min\{s, t, c\} + u$.

There are three cases to consider:

- (a) $u = \min\{s, u, a\}$. Then $u + \min\{t, u, b\} \leq \min\{s, t, c\} + u$ because $u \leq a \leq c$.
- (b) $s = \min\{s, u, a\}$. Then it suffices to check that $s + \min\{t, u, b\} \leq \min\{s, t\} + u$. This is readily seen considering the cases $t \leq s$ and $s \leq t$.
- (c) $a = \min\{s, u, a\}$. Then it is clear that $a + \min\{t, u, b\} \leq \min\{s, t, c\} + u$ considering the cases $t \leq a$ and $a \leq t$.

□

Proposition 6.10. (T, D) is a geodesically complete \mathbb{R} -tree.

Proof. By 6.6, it suffices to show that T is connected and 0-hyperbolic in the sense of Gromov. For every point there is a path connecting it to the root so the first part is obvious.

The Gromov product, 6.7, of $[x, t]$ and $[y, s]$ with respect to the root, $w = [x, 0]$ for any x , is given by

$$([x, t] \cdot [y, s])_w = \frac{1}{2}\{D([x, t], w) + D([y, s], w) - D([x, t], [y, s])\}$$

Since $D([x, t], w) = t$, this means that $([x, t] \cdot [y, s])_w = \min\{t, s, m(x, y)\}$. Given $[z, u] \in T$, this must be compared with $\min\{([x, t] \cdot [z, u])_w, ([z, u] \cdot [y, s])_w\} = \min\{\min\{t, u, m(x, z)\}, \min\{u, s, m(z, y)\}\} = \min\{t, u, s, m(x, z), m(z, y)\}$.

Thus, it suffices to check that $m(x, y) \geq \min\{m(x, z), m(z, y)\}$ which is obvious.

Finally, to see that (T, w) is geodesically complete let $\alpha : [0, t_0] \rightarrow (T, w)$ be an isometric embedding such that $\alpha(0) = w$. Then, $\alpha(t_0) = [x, t_0]$ for some $x \in X$ and by the uniqueness of arcs, $\alpha(t) = [x, t]$ for $0 \leq t \leq t_0$ and $\alpha(t) = [x, t] \forall t \geq 0$ gives the desired extension of α to a geodesic ray. □

The end space of this tree endows X with an ultrametric, d_U , where two points are near if there is some small radius ε such that the balls centered at both points coincide. This ultrametric endows X with a topology which is thinner than the initial, resulting a space which is not compact nor separable.

Proposition 6.11. *The identity map $id : (X, d_u) \rightarrow (X, d)$ is continuous.*

Proof. Consider any convergent sequence in (X, d_u) , $(x_n) \rightarrow x$. There must be some sequence of positive real numbers $(\varepsilon_n) \rightarrow 0$ such that $\bar{B}(x_n, \varepsilon_n) = \bar{B}(x, \varepsilon_n)$ and, in particular, $d(x_n, x) \leq \varepsilon_n$ converges to 0 and $(x_n) \rightarrow x$ in (X, d) . □

Proposition 6.12. *If (X, d) is a compact length space then (X, d_u) is not separable.*

Proof. Let $x, y \in X$ be any two points and $[x, y]$ a geodesic segment joining them. Let us see that $C = [x, y] \subset (X, d_u)$ is a closed subset and $(C, d_u|_C)$ is a discrete subset with cardinal $> \aleph_0$. It is closed since C is compact in (X, d) and $id : (X, d_u) \rightarrow (X, d)$ is continuous. Also, for any $\delta < \frac{d(x, y)}{2}$ and any $z, z' \in [x, y]$, $\bar{B}(z, \delta) \neq \bar{B}(z', \delta)$ and therefore the subspace $(C, d_u|_C)$ is uniformly discrete. \square

The condition of being topologically robust can be characterized as follows:

Proposition 6.13. *(X, d_u) is uniformly discrete if and only (X, d) is topologically robust.*

Proof. Suppose $\delta > 0$ such that $\forall x \in X, B_{d_u}(x, \delta) = \{x\}$. Then let $\varepsilon_0 = \min_{x \in X} \{\varepsilon_x \mid \Phi(\bar{B}(x, \varepsilon_x)) = 1 - \ln(\delta)\}$ which is reached since X is compact and obviously greater than 0 since the Lyapunov function value of the ball is $1 - \delta < 1$.

Conversely, if the projection is injective $\forall \varepsilon < \varepsilon_0$, let $\delta = \max_{x \in X} \{\Phi(\bar{B}(x, \varepsilon_0))\}$. Then $\delta < 1$ and it is well defined since X is compact. For any point $x \in X$, the class $[x, t]$ in the tree is not identified with any other class $[y, t]$ for any $t > -\ln(1 - \delta)$ and thus, $B_{d_u}(x, 1 - \delta) = \{x\} \forall x \in X$. \square

This, together with 4.9, 4.10, 4.11 respectively, implies the following corollaries.

Corollary 6.14. *If (X, d) is an r -perfectly geodesic compact length space then (X, d_u) is uniformly discrete.*

Corollary 6.15. *If (X, d) is a compact connected Riemannian manifold with the natural length metric then (X, d_u) is uniformly discrete.*

Corollary 6.16. *If (X, d) is a uniquely geodesic compact length space with curvature bounded below then (X, d_u) is uniformly discrete.*

REFERENCES

- [1] Bhatia, N.P., Szegő, G.P. *Stability theory of dynamical systems*. Springer-Verlag, New York, (1970).
- [2] Bing, R. H. *Partitioning a set*. Bull. Amer. Math. Soc. **55** (1949) 1101–1110.
- [3] Bridson, M., Haefliger, A. *Metric spaces of non-positive curvature*. Springer-Verlag, Berlin, (1999).
- [4] Burago, D., Burago, Y., Ivanov, S. *A course in metric geometry*. Graduate Studies in Mathematics. **33**, AMS, Providence, RI, (2001).
- [5] Chiswell, I. *Introduction to Λ -trees*. World Scientific, Singapore, (2001).
- [6] Cuchillo-Ibáñez, E., Dydak, J., Koyama, A., Morón, M.A. *C_0 -coarse geometry of complements of Z -sets in the Hilbert cube*. Trans. AMS. **360**, No.10 (2008), 5229–5246.
- [7] Curtis, D.W. and Schori, R. M. *Hyperspaces of Peano continua are Hilbert cubes*. Fund. Math. **101** (1) (1978) 19–38.
- [8] Gromov, M. *Hyperbolic groups*, in Essays in Group Theory, Mathematical Science Research Institute Publications, S.M. Gersten (Ed.), **8**, Springer, New York (1987) 75–263.
- [9] Hatcher, A. *Algebraic Topology*. Cambridge University Press, (2002).
- [10] Hopf, H., Rinow, W. *Über den Begriff der vollständigen differentialgeometrischen Flächen*. Comm. Math. Helv. **3** (1931) 209–225.
- [11] Hughes, B. *Trees and ultrametric spaces: a categorical equivalence*. Advances in Mathematics. **189** (2004) 148–191.
- [12] Hughes, B., Martínez-Pérez, B. and Morón, M.A. *Bounded distortion homeomorphisms on ultrametric spaces*. Ann. Acad. Sci. Fenn. **35** (2010) 473–492.
- [13] Illanes, A., Nadler S. B. *Hyperspaces. Fundamentals and Recent Advances*. Marcel Dekker, New York, (1999).

- [14] Kelley, J.L. *Hyperspaces of a Continuum*. Trans. AMS. **52**, No.1 (1942) 22–36.
- [15] Lynch, M. *Whitney levels and certain order arc spaces*. Top. and its Appl. **28**, No.2 (1991) 189–200.
- [16] Martinez-Perez, A. and Morón, M.A. *Uniformly continuous maps between ends of \mathbb{R} -trees*. Math. Z. **263**, No. 3 (2009) 583–606.
- [17] Michael, E. *Continuous selections. I* Annals of Mathematics. **63**, No.2 (Mar., 1956) 361–382.
- [18] Moise, E. E. *Grille decomposition and convexification theorems for compact metric locally connected continua*. Bull. Amer. Math. Soc. **55** (1949) 1111–1121.
- [19] Nadler, S. B. *A characterization of Locally Connected Continua by Hyperspace Retractions*. Proc. of the AMS. **67**, No.1 (1977) 167–176.
- [20] Nadler, S. B. *Hyperspaces of sets*. Pure and Applied Mathematics Series, **Vol.49**, Marcel Dekker, Inc. New York, (1978).
- [21] Nadler, S. B. *Continuum Theory: An Introduction*. Pure and Applied Mathematics Series, **Vol.158**, Marcel Dekker, Inc. New York, (1992).

DEPARTAMENTO DE ANÁLISIS ECONÓMICO Y FINANZAS, UNIVERSIDAD DE CASTILA-LA MANCHA,
AVDA REAL FÁBRICA DE SEDAS S/N. TALAVERA DE LA REINA, 45600, SPAIN, TELEPHONE: +34
902 204 100. FAX +34 902 204 130.

E-mail address: `alvaro.martinezperez@uclm.es`

DEPARTAMENTO DE GEOMETRÍA Y TOPOLOGÍA, UNIVERSIDAD COMPLUTENSE DE MADRID, MADRID,
28040, SPAIN

E-mail address: `mamoron@mat.ucm.es`