

Strong complexity bounds for levels based linear logic subsystems

Matthieu Perrinel

February 21, 2019

Contents

1	Introduction	2
1.1	The roots of complexity	4
1.2	Proof-nets, intuitively	4
1.3	Stratification and dependence control	5
2	Linear logic	5
3	Context semantics	10
3.1	Definition of contexts	11
3.2	Dealing with the digging	14
3.3	Context semantics and time complexity	14
3.4	Copymorphisms : motivations and definitions	17
3.5	Underlying formula of a context	19
3.5.1	Intuition of the proof	19
3.5.2	Substitution trees	20
3.6	Proof of Dal Lago’s weight theorem	24
3.7	The <i>ztrees</i> are finite	34
4	Stratification	35
4.1	History and motivations	35
4.2	Definition of “principal door” stratification	36
4.3	Cycles on potential boxes go by principal doors	39
4.4	Definition of \sim equivalence between contexts	39
5	Dependence control	43
6	Applications	47
6.1	Elementary bounds	47
6.1.1	ELL , the stratification through depth	47
6.1.2	L^3 , the stratification through levels	48
6.2	Polynomial bounds	50
6.2.1	LLL : ELL restricted to one auxiliary door boxes	50
6.2.2	L^4	50
6.2.3	L_a^3	50

arXiv:1201.2956v2 [cs.LO] 1 Feb 2013

7 Strong polynomial bound for L_0^4	51
7.1 η -expansion increases $T : T_{G_0} \leq T_{G_1}$	52
7.2 G is not much bigger than G_0	53

Abstract

Girard’s *LLL* characterized Ptime in the proof-as-program paradigm with a complexity bound on cut elimination. This logic relied on a stratification principle which Baillot and Mazza generalized by defining two variants L^4 and L_0^4 referred to as *light linear logic by levels*. However, for L^4 , a polynomial bound was given on cut elimination only for a specific reduction strategy. This limitation us a problem for defining a proper type system out of this logics. In this paper we overcome this problem by proving a polynomial time bound for cut elimination under any strategy(strong bound) for L^4 . The proof is based on an extension of Dal Lago’s context semantics, illustrating once again the usefulness of this tool.

1 Introduction

Implicit computational complexity For decades, computer scientists have tried to characterize complexity classes by restricting syntactically models of computation. This effort is known as implicit computational complexity. The main application is to achieve automated certification of the complexity of a program. Some consider also other goals for implicit computational complexity : to understand the root of complexity, as suggested by Dal Lago [19] or to create polytime mathematics, as suggested by Girard [10].

There are different approaches to implicit complexity, corresponding to different models of computation : restriction of recursion [5] [4] [20], non-size-increasing lambda calculus [1] [16], restriction of linear logic [18] [14] [10] [7]. One of the interests of the linear logic approach is the possibility to quantify over types (second order quantifiers). This allows, for example, to write a sorting algorithm which can be applied to any type of data, as soon as a comparison function is given. A milestone in that field was the creation of Light Linear Logic (*LLL*) by Girard [10] which characterizes polynomial time (Ptime). In the following study, we were mainly interested by systems based on *LLL* characterizing Ptime, with the perspective of automated inference of complexity bounds as a final goal.

Proofs as programs In the linear logic approach, the programs are proofs of linear logic formulae and the execution of programs is done by the elimination of the cut rule in the proof [9] [12]. Programming in such a system seems quite unnatural for most people. Fortunately, the proofs-as-programs correspondence [17] states that a logical system corresponds to a type system for λ -calculus. Thus, we would like to transform subsystems of linear logic into type systems for λ -calculus such that any typed λ -term reduces to its normal form in a number of steps bounded by a polynomial on its size (Ptime soundness). For any Ptime function ϕ , such a type system also has to type at least one λ -term computing ϕ (Ptime extensionnal completeness). λ -calculus is not used directly as a programming language but fonctionnal programming languages (such as Lisp, Haskell or Caml) are based on it. Thus, a type system for λ -calculus characterizing a class can be seen as a big step towards the creation of a real programming language characterizing the class. Such a transformation was done on *LLL* by Baillot and Terui, who transformed the logical system *LLL* into a type system *DLAL* for λ -calculus [3].

Weak and strong bounds A programming language comes with a reduction strategy, which determines the order of the reduction. For example : do we reduce the arguments before passing them to functions (call by value) or not (call by name)? We want this strategy to be simple enough to be understood by programmers. Thus a type system must enforce a polynomial bound for any strategy (strong bound) or at least for a simple strategy. That is why proving strong strong polynomial bounds for a system is significantly more interesting than proving a weak bound (bound holding for a simple strategy). But it is much more difficult to prove a strong bound than a weak bound. Before Terui [24] and Mazza [21] proved strong polynomial bounds for *LLL*, the bound was only proved for a farfetched strategy [10]. It seemed unlikely to find a simple evaluation λ -calculus strategy corresponding to the *LLL* strategy.

Intensional completeness *DLAL* is extensionally complete, so for every Ptime function $f : \mathbb{N} \rightarrow \mathbb{N}$, there exists a λ -term t computing f and typable by *DLAL*. However, there may be other λ -terms computing f which are not typable by *DLAL*. For example, there exists λ -terms computing multiplication and list sorting but neither the shortest (and most natural) λ -term for multiplication, merge sort nor quick sort are typable. So *DLAL* would not be really useful in practice because it would not recognize those simple programs as polynomial. We would like a type system typing more polynomial programs. If a type system recognize types all polynomial programs, it is *Ptime intensionally complete*. Thus, in our perspective, the perfect system would be both Ptime sound and Ptime intensionally complete, and decidable. However, it is proved that such a system can not exist, we will never reach the perfect system. But we could approach it. In [6], Dal Lago and Gaboardi approach this question by a top-down approach : they design a type system which is both sound and intensionally complete for Ptime. This type system is undecidable, but we might find heuristics which could solve the typability problem on most cases. Here, we will work in a bottom-up approach : we want to have a decidable system which is as close as possible to intensional completeness.

Linear logics by levels There has been some work in this direction. Baillot and Mazza created light linear logic by levels (with two variants : L^4 and L_0^4), Dorman and Mazza created asymmetric linear logic by levels (L^{3a}). The main novelty in those systems is that stratification and depth are no longer related (see section 6). L_0^4 is more general than L^4 which is more general than *LLL*. However, no meaningful program separating L^4 from *LLL* or L_0^4 from L^4 has been found yet, so the improvement in expressivity seems to be small. L^{3a} is also more general than *LLL*, but the expressivity gain does not seem really important. So, it is a small step on the path of expressivity. But no gain in expressivity were done in the 12 years separating *LLL* and L^4 . It seems it unblocked the situation, by bringing new ideas. Thus, proving strong polynomial bounds for L^4, L_0^4 and L_a^3 is interesting by itself (it would make type systems based on these systems possible). But such proofs would be all the more interesting if the methods used were general enough to be used on future systems, or if they revealed hints on a way to improve the expressivity of those systems.

context semantics The idea of geometry of interaction [13] and context semantics is to study the reduction of proof-nets (or λ -terms) by leaving the proof-net unchanged and analysing instead some paths in it. Context semantics has first been used to study qualitative properties [15]. In [19], Dal Lago adapted context semantics to study quantitative properties of cut-reduction. From this point of view an advantage of context semantics compared to the syntactic study of reduction is its genericity : some common results can be proven for different variants of linear logic, which allows to factor out proofs of complexity results for these various systems. Our framework is slightly different from Dal Lago’s context semantics. In particular, Dal Lago worked in intuitionistic linear logic, and we work in classical linear logic. So the results of [19] can not be directly applied. However most theorems of [19] have correspondents in our framework, with quite similar proofs.

This paper In this paper, we will define a “stratification criterion” and a “dependence control criterion” on proof-nets such that : if every proof-net of a given system satisfies the stratification criterion, then this system is elementary time (towers of exponentials of bounded height) sound, and if every proof-net of a given system satisfies both criteria, then this system is Ptime sound. We will then prove that *ELL* and L^3 satisfies the stratification criterion, and that *LLL*, L^4 and L^{3a} satisfy both criterion. This proves strong polynomial bounds L^4 and L^{3a} (for which only weak bounds were previously known). We also prove a strong polynomial bound for L_0^4 thanks to the L^4 strong bound.

Outline In the remaining of this introduction we will give an intuitive understanding of stratification and dependence control. In section [?], we present linear logic and proof-nets. In section [?], we present our version of context semantics and prove useful lemmas. The only significant results in this part which were not in [19] are those on “underlying formulae” (lemmas ?? and 15). Notice also the Dal Lago’s weight theorem, for which we give a more detailed and formal proof than the original. In sections 4 and 5, we give our stratification and dependence control conditions and prove that they imply polynomial soundness. In

section 6, we prove strong polynomial bounds for LLL , L^4 and L^{3a} (only the first being previously proved). In section 7, we prove a strong polynomial bound for L_0^4 for which no bound was previously known.

1.1 The roots of complexity

To investigate the roots of complexity, we begin by looking at the most notorious non-normalizing λ term : $t = (\lambda x.xx)(\lambda y.yy)$. It is often said that the cause of this divergence is the fact that x is applied to itself [22]. However the problem seems to be more subtle, because the λ term $u = (\lambda x.xx)(\lambda y.y)$ normalizes. The difference seems to be that in t , $\lambda y.yy$ will duplicate itself during reduction, whereas in u , $\lambda y.y$ is applied to itself without duplication. If we want to control complexity precisely, we will need to make a difference between self-application and self-duplication. The usual type systems for λ calculus, based on intuitionistic logic (Simple typing, System F) can not do this. This is why we will use a type system based on a logic which controls duplication : linear logic.

While highlighting the difference between self-application and self-duplication, this example was not really convincing. Indeed System F already accepts $(\lambda x.xx)(\lambda y.y)$ while refusing $(\lambda x.xx)(\lambda y.yy)$. Let's look at other examples to see the limits of system F.

Let us use the Church encoding for natural numbers : n is represented by $\lambda f.\lambda x. \underbrace{f(f(\dots(f x)))}_{n \text{ applications of } f} : \mathbb{N}$.

Then the following terms represent the functions $n \mapsto 2.n$, $n \mapsto 2^n$ and $n \mapsto Ackermann(n, n)$.

$$\begin{aligned} mult &:= \lambda n.n (\lambda a.\lambda f.\lambda x.f(f(ax))) 0 \\ exp &:= \lambda n.n (\lambda a.\lambda f.\lambda x.af(ax)) \\ ack &:= \lambda n.n (\lambda a.\lambda k.(Sk)a1) S n \end{aligned}$$

We can see that those three functions are built similarly : they are all based on the iteration of some auxiliary function. They all have a subterm of shape $n(\lambda a.t)b$ as a key component. In fact, System F makes no difference between those terms, typing each term with $\mathbb{N} \Rightarrow \mathbb{N}$. The complexity of those functions being quite different (linear, exponential and over-elementary), we would like to understand what makes their complexity so different and tell them apart.

When we reduce those terms, $n(\lambda a.t)b$ becomes $(\lambda a.t)(\lambda a.t) \dots (\lambda a.t)b$. So $\lambda a.t$ is self-applicating. Depending on the use of a in t , it might also be self-duplicating. This will tell apart the complex functions from the simple ones. Indeed, in $mult$, a is used only once. In exp , a is used twice, so $(\lambda a.t)$ is self-duplicating. But this duplication is bounded. In ack , a is itself iterated, and the number of times a is used during the i -th iteration of $\lambda a.\lambda k.(Sk)a1$, the number of times a is used is equal to $k + 1$ so depends on the next iteration. So, in ack , $(\lambda a.t)$ is self-duplicating in an unbounded way.

This analysis is quite informal. In order to forbid this notion of “self-duplication”, we will use linear logic. More precisely we will define a subset of linear logic in which self-duplication is impossible.

1.2 Proof-nets, intuitively

In the same way that λ -calculus computes functions with the β -reduction, linear logic computes functions with the *cut*-elimination. It is the elimination of the *cut*-rules in proofs of linear logic (the *Hauptsatz* of Gentzen). This elimination is more natural on *proof nets*, which are graphical representation of proofs. The proof nets for L^4 will be defined in section 2. Here, we will only give an intuitive understanding of proof-nets, necessary for 1.3.

Intuitively, the edges of a proof net correspond either to programs or to requests. For example the function $x \mapsto x + 2$ is a program. $x + 2$ alone is a program, but it comes with a request x^\perp for a parameter x . The program represented by the proof net, is the program labelling its dangling edge. \otimes can be thought of as an application and \wp as an abstraction.

Some programs ($x \mapsto x + x$ for example) need to duplicate a subprogram (x here). We want to control this operation. When we duplicate a program, we need to duplicate the requests associated to it (in $x \mapsto (x * y) + (x * y)$ we observe that to duplicate $x * y$ we need to request twice x and y). This is the purpose of boxes : a box is a part of the proof net with a principal door ($!P$) which is a program we want to duplicate, and optional auxiliary doors ($?P$) which are requests associated to the program. Only programs preceded by a $!$ can be duplicated. So, contracting various requests for a same program x in a single requests can only be done if x is preceded by a $!$. The right part of figure 1 is labelled corresponding to this intuitive understanding of proof nets.

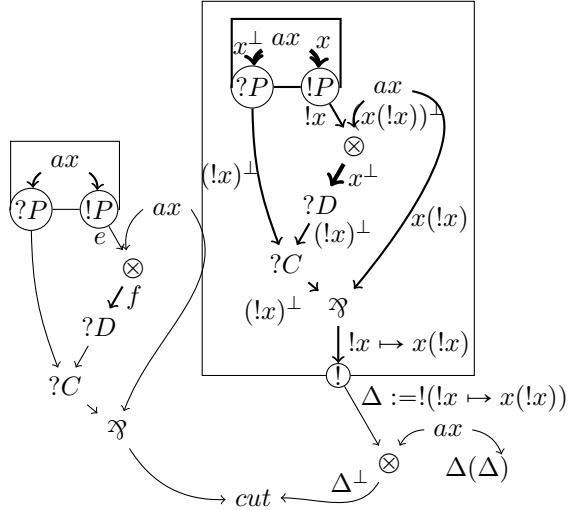

Figure 1: This proof net reduces to itself, it represents $(\lambda x.xx)(\lambda x.xx)$

1.3 Stratification and dependence control

To avoid the complexity explosion of *ack*, we want to forbid iteration of functions $\lambda x.t$ where the number of times x is used in $(t)u$ depends on u . The first such restriction was created by Girard. In *LLL*, he forbids the dereliction and digging principles ($!A \multimap A$ and $!A \multimap !A$). Such a restriction corresponds to elementary-time (tower of exponentials of fixed height) functions. For example, you can see in figure 1 that the proof-net corresponding to $(\lambda x.xx)(\lambda y.yy)$ is ruled out because it uses a dereliction (the $?D$ link). The proof-net corresponding to Ackermann is ruled out because it would use digging. We will call similar restrictions *stratification conditions* (more details in section 4).

Though stratification gives us a bound on the length of the reduction, elementary time is not considered as a reasonable bound. Figure 18 explains us how the complexity arises, despite stratification. On this proof net, the box A duplicates the box B. Each copy of B duplicates C, each copy of C,... To avoid it, Girard [10] limited the number of $?P$ -doors of each $!$ -boxes to 1. To keep some expressivity, he introduced a new modality \S with \S -boxes which can have an arbitrary number of $?P$ -doors. We will call *dependence control condition* any restriction preventing this kind of sequences (more details in section 5).

2 Linear logic

Linear logic (*LL*) [12], can be considered as a refinement of System F [23][11] where we focus especially on how the duplication of formulae is managed. In System F, $A \Rightarrow B$ means “with many proofs of A , I can create a proof of B ”. Linear logic decompose it into two connectives : $!A$ means “infinitely many proofs of A ”, $A \multimap B$ means “using exactly one proof of A , I can create a proof of B ”. We can notice that we can

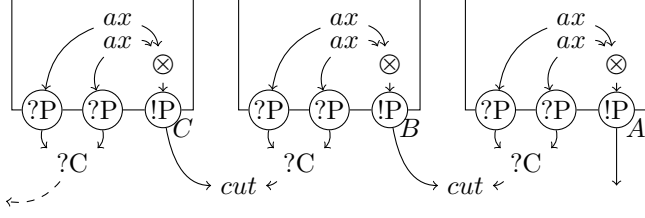

Figure 2: This proof net (if extended to n boxes) reduces in 2^n steps

represent $A \Rightarrow B$ with $(!A) \multimap B$. The disjunctions \vee and conjunction \wedge are also decomposed into two disjunctions (\wp and \oplus) and two conjunctions (\otimes and $\&$). In this paper, we will only use the “multiplicative” ones : \wp and \otimes .

Similarly to system F (or simpler logics) where $A \Rightarrow B$ is a synonym of $(\neg A) \vee B$, in linear logic $A \multimap B$ is a synonym of $A^\perp \wp B$. $(_)^\perp$ can be considered as a negation.

Finally \forall and \exists allow us, as in System F, to quantify over the sets of formulae. As examples, let us notice that $\forall X.X \multimap X$ is true (for any formula X , using exactly one proof of X , we can create a proof of X). On the contrary, $\forall X.X \multimap (X \otimes X)$ is false because, in the general case, we need two proofs of X to prove $X \otimes X$.

In the following paper, we will study variations of Linear Logic. These variations are not really subsystems of LL because we extend the language of formula with indexes on atomic formulae and a new connective \S . However, those variations all are subsystems of a same system, which we will call LL_0 . We will work inside LL_0 for the main results, keeping in mind that we are not interested in LL_0 itself but in its subsystems. We will call this system LL_0 . However, we are not interested in LL_0 itself but in its subsystems. The system LL_0 uses the following formulas, where X ranges over a denumerable set of variables (X, X^\perp are atomic formulae) and p ranges over \mathbb{Z} .

$$\mathcal{F}_{LL_0} = p.X \mid p.X^\perp \mid \mathcal{F}_{LL_0} \otimes \mathcal{F}_{LL_0} \mid \mathcal{F}_{LL_0} \wp \mathcal{F}_{LL_0} \mid \forall X \mathcal{F}_{LL_0} \mid \exists X \mathcal{F}_{LL_0} \mid !\mathcal{F}_{LL_0} \mid ?\mathcal{F}_{LL_0} \mid \S \mathcal{F}_{LL_0}$$

You can notice that $(_)^\perp$ is only defined on atomic formulae. We define inductively an involution $(_)^\perp$ on \mathcal{F}_{LL_0} , which can be considered as a negation : $(p.X)^\perp = p.X^\perp$, $(p.X^\perp)^\perp = p.X$, $(A \otimes B)^\perp = A^\perp \wp B^\perp$, $(A \wp B)^\perp = A^\perp \otimes B^\perp$, $(\forall X.A)^\perp = \exists X.A^\perp$, $(\exists X.A)^\perp = \forall X.A^\perp$, $(!A)^\perp = ?(A^\perp)$, $(?A)^\perp$ and $(\S A)^\perp = \S(A^\perp)$.

The \S is a connective introduced by Girard [10] to control complexity while keeping some expressivity. It is difficult to give it a meaning, and it has no real equivalent in usual logics. The integer p in atomic formula $p.X$ means $\underbrace{\S \S \dots \S}_p X$. In fact it was used by Baillot and Mazza [2] to replace the \S connective. In this paper

p symbols

we will prove results which stands for both systems, that is why we allow both notations in LL_0 . One of the particularity of the $p.X$ notation compared to the \S one is that the indexes can only be on atomic formulae. To change the indexes of all the atomic formulae of a formula, we define for any $q \in \mathbb{N}$ and $A \in \mathcal{F}_{LL_0}$ the formula $q.A$ as follows : $q.(p.X) = (q+p).X$, $q.(p.X^\perp) = (q+p).X^\perp$ and $q.(\)$ commutes with every other connective ($q.(A \otimes B) = (q.A) \otimes (q.B)$, $q.(A \wp B) = (q.A) \wp (q.B)$, $q.(\exists X.A) = \exists X.(q.A)$, ...).

We can observe that the formulae of linear logic F_{LL} form a subset of F_{LL_0} . We can define a forgetful mapping from F_{LL_0} to F_{LL} : $(p.X)_{/LL} = X$, $(p.X^\perp)_{/LL} = X^\perp$, $(\S A)_{/LL} = A_{/LL}$ and $(\)_{/LL}$ commutes with all other connectives. Similarly, we define $(\)_{/L^4}$ which erases the indexes on the atomic formulae and $(\)_{/L^4}$ which erases the \S connectives.

Proof-nets are the programs of linear logic. They are graph-like structures in which the links correspond to uses of logical rules. We can consider them as λ -terms, with added information on how the duplication of

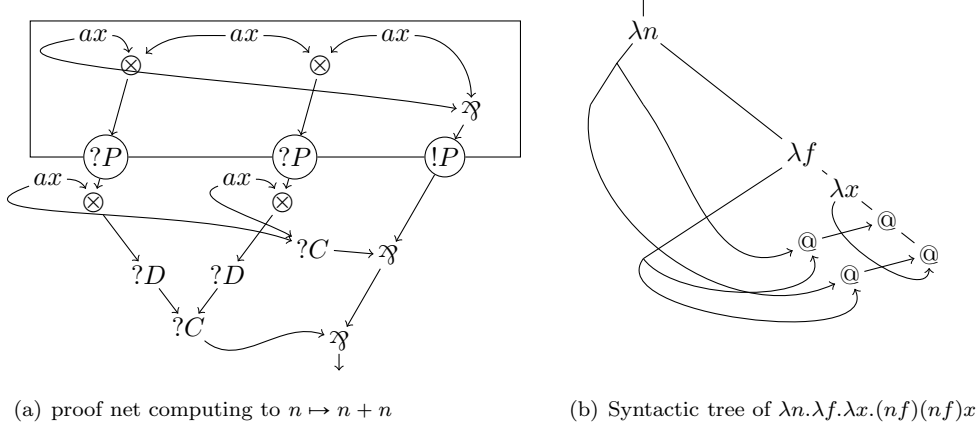

Figure 3: We can observe graphically the proofs-as-program correspondence : if we erase the $!P$, $?P$ and $?C$ of the proof net and reverse it, we obtain the syntactic tree of the corresponding λ -term

variables is managed. In fact the proofs-as-programs correspondence gives us a mapping from the intuitionistic fragment of proof-nets to λ -terms. As an example, you can observe in figure 3 a proof-net corresponding to the λ -term $\lambda n.\lambda f.\lambda x.(nf)(nf)x$ which computes the function $\begin{cases} \mathbb{N} & \mapsto \mathbb{N} \\ n & \mapsto n + n \end{cases}$. We can see that if we erase the exponential links ($?C$, $?P$ and $!P$) and reverse the proof net, we get the syntactic tree of the λ -term. The \otimes link corresponds to the application of a function and the λ link corresponds to the abstraction.

Definition 1 (proof-net). A proof-net is a graph-like structure defined inductively by the graphs of figure 4 (G and H being proof-nets). The vertices are called links, a link l is labelled by a connector $\alpha(l)$. The set of edges is written E_G . The edge e is labelled by a formula $\beta(e)$ in \mathcal{F}_{LL_0} .

Premises and conclusions For any link l , the incoming edges of l are called the *premises* of l . The outgoing edges of l are called the *conclusions* of l . $concl(l)$ refers to the set of conclusions of link l . If l has only one conclusion, we identify $concl(l)$ with its only element. The *tail* of edge (l, m) refers to l , while the head of (l, m) refers to m . If l is the head (resp. the tail) of a conclusion (resp. a premise) of m , then l is a direct successor (resp. predecessor) of m . Some edges have no successors. They are called the conclusions of the net, and by convention we say that their conclusion is \bullet .

Boxes The rectangle in the $?P, !P$ rule is called a box. Formally a box is a subset of the links of the proof-net. We say that an edge (l, m) belongs to box B if l is in B . We require the boxes to be arborescent : two boxes are either disjoint, or one contains the other. The number of boxes containing an element (box, link or edge) x is its depth written $\partial(x)$. $\partial(G)$ is the maximum depth of an edge of G . Similarly, $l(G)$ is the maximum level of an edge of G . The set of boxes of G is B_G .

Let us call B the box in figure 4. The link labelled $!P$ is the principal door of B , its outgoing edge is written $\sigma(B)$. The $?P$ links are the auxiliary doors of box B . The edge going out of the i -th auxiliary door (the count begins by 0) is written $\sigma_i(B)$. $D_G(B)$ is the set of doors of B . The doors of box B are not considered in box B , they are exactly the links which are not in B but whose direct predecessors are in B . P_G is the set of principal edges of G . $\rho_G(e)$ is the deepest box of G containing e .

Quantifiers We call *eigenvariables* of a proof-net, the variables Z replaced by a \forall link. We will always suppose that they are pairwise distinct. Any proof-net which does not respect this convention can be transformed in a proof-net with pairwise distinct eigenvariables by variables. This is possible because when we replace an eigenvariable with a \forall link, the eigenvariable can not be free in the other conclusions, so even

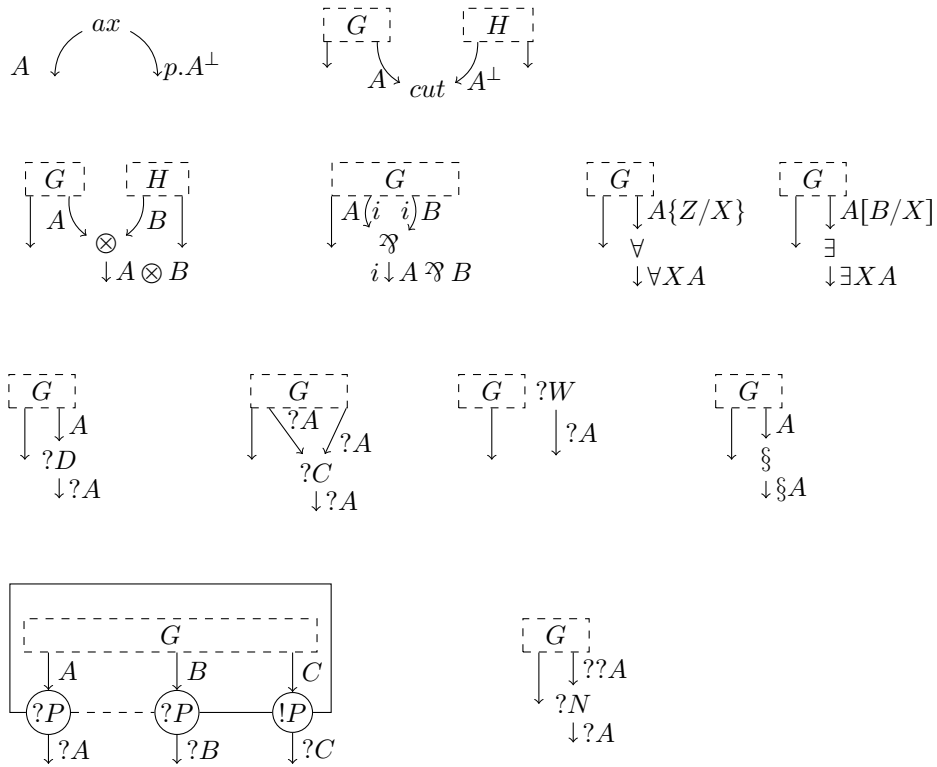

Figure 4: Construction of proof-nets. For the \forall rule, we require Z not to be free in the formulae labelling the other conclusions of G

if the eigenvariables are equal, they can not be related. This allows to refer to “*the* link associated to the eigenvariable Z ”.

Substitutions Let A be a formula and $\theta = \{(X_1, A_1); \dots (X_n, A_n)\}$ be a substitution, then $A[\theta]$ refers to $A[A_1/X_1 | \dots | A_n/X_n]$: the parallel substitution of the variables. Notice that we do not replace the occurrences of variables which are bound. Similarly, if $Y \in FV(\theta(X))$ and X appears in the scope of a $\exists Y$ or $\forall Y$, then we use α -conversion to distinguish those Y s.

Lists In the following, we will define many concepts based on lists (also called stacks). So, we will sometimes manipulate lists of lists of lists. Thus, it is important to make the difference between concatenation ($l_1 @ l_2$ denotes the list $[a_1; \dots; a_j; b_1; \dots; b_k]$ made of the elements (b_i) of l_2 following the elements (a_i) of l_1) and the insertion ($l_1.t_2$ denotes the list $[a_1; \dots; a_k; t_2]$ made of t_2 and the elements (b_i) of l_1). If I is a set, $|\{a_1; \dots; a_j\}|_I$ is the number of indices i such that a_i is in I .

Trees truncations Let I and L be two sets, we can define the set of (possibly infinite) trees whose leafs are labelled by L and internal nodes labelled by I as the set of directed connex acyclic graphs such that the leafs (nodes of outward arity 0) are labelled by an element of L and the internal nodes (nodes which are not leafs) are labelled by an element of I . If L is reduced to one element or $L = I$, we can define a truncation relation on trees: $T \triangleleft U$. If $L = I$, it means there is an injection ϕ from the nodes of T to the nodes of U such that

- The “son/father” relation is preserved
- For all nodes n of T , the outward arity of $\phi(n)$ is either 0 or the outward arity of t
- For all nodes n , the labels of t and $\phi(n)$ are equal.

In the case where L is reduced to one element, we do not require the labels to be equal when n is an internal node and $\phi(n)$ a leaf.

Other notations Whenever X is a set, $|X|$ is the cardinal of X . We will sometimes manipulate towers of exponentials, and will write a_b^c for $a \dots^{a^c} b$ successive exponentiation by a . Finally, if f is a mapping from E to F and $A \subseteq E$, then $f(A)$ refers to $\{f(x) | x \in E\}$

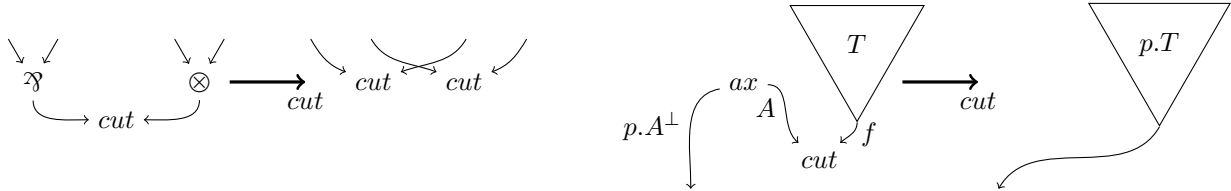

Figure 5: Multiplicative rules for cut elimination. Explanations for the axiom rule: for any edge h such that there is a directed path from e to h , we replace its formula $\beta(h)$ by $p.\beta(h)$

Cut elimination The proof-nets are the notion of programs of linear logic. We need a notion of computation to evaluate them. This is the role of *cut*-elimination, a binary relation \rightarrow_{cut} on proof-nets which corresponds to the β -reduction of λ -calculus. The rules of *cut*-elimination can be found in figures 5, 6 and 7.

Lemma 1. [2] L^A proof-nets are stable under cut-elimination.

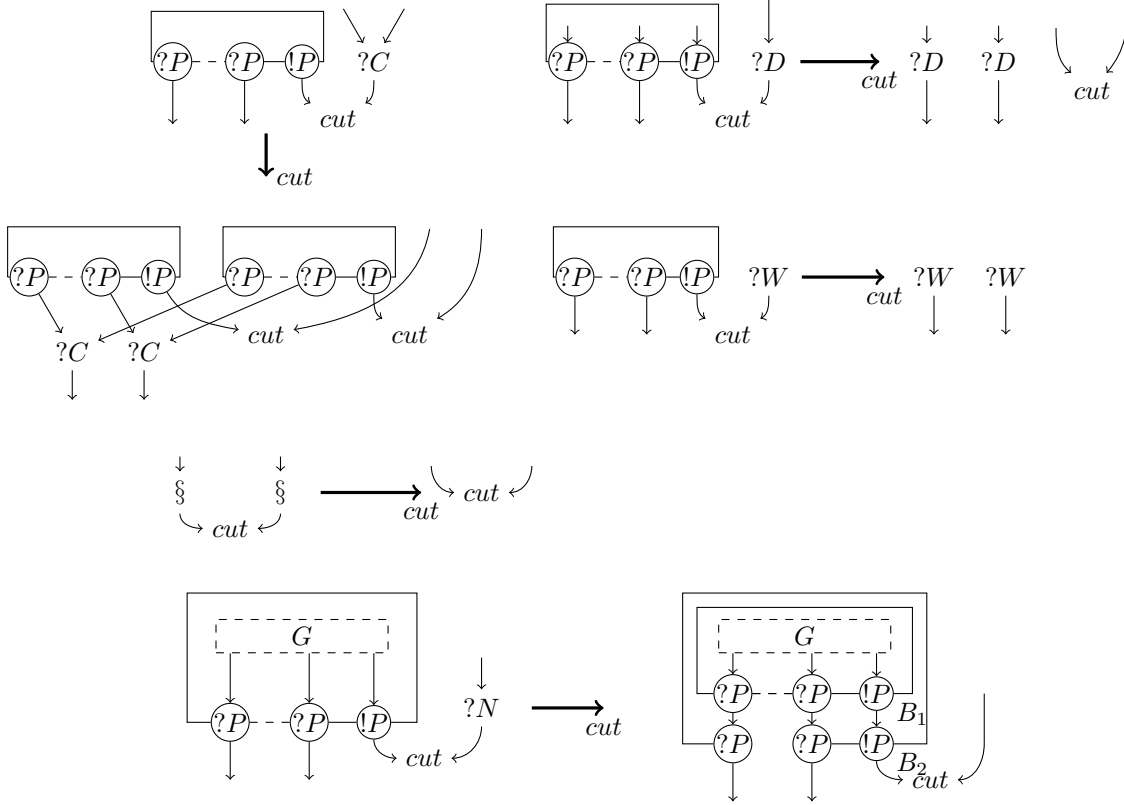

Figure 6: Exponential rules for cut elimination

Proof. The untyped version of the system corresponds exactly to the untyped version of *meLL* which is stable under cut reduction [2]. An analysis of the rules show that the types of the reduced nets are compatible with the rules. Most case are straightforward. The case of the axiom rule is not.

We have to verify that, given a proofnet G an edge f which has no head, if for all edges h such that we have a directed path from h to f we replace the type $\beta(h)$ by $p.\beta(c)$, the resulting graph is still a proofnet. We can do so by induction on the proofnet. If the proofnet is an axiom, then the only edge whose type is replaced is f itself and the axiom is still valid. Else, we can make a disjunction over the last rule used to build the proofnet, we apply the induction hypothesis to the subproofnet(s). The rule used on the original proofnet is still valid now, because each rule is stable by application of the $F \mapsto p.F$ transformation. More details on this rule can be found in [2]. \square

3 Context semantics

The idea of geometry of interaction and context semantics is to study the reduction of proof-nets (or λ -terms) by leaving the proof-net unchanged and analysing instead some paths in it. It has been a key tool for the study of optimal reduction in λ -calculus [15]. Dal Lago [19] adapted context semantics so as to use it to prove quantitative properties on proof-net reduction, and applies it to light logics. From this point of view an advantage of context semantics compared to the syntactic study of reduction is its genericity : some common results can be proven for different variants of linear logic, which allows to factor out proofs of complexity results for these various systems.

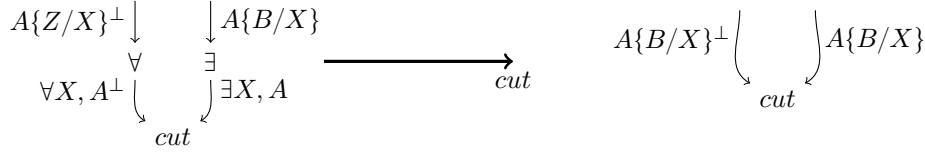

Figure 7: Quantifier rule for cut elimination. The substitution of the eigenvariable Z by B takes place on the whole net.

In the present work we will show that context semantics is a powerful method because it allows to prove strong bounds on reduction which we do not know (yet) how to prove directly by syntactical means. The usual method to prove that a given relation strongly normalizes in a bounded number of steps is to define a weight for every object and to show that the weight decreases along any step of the relation. In the case of cut elimination on linear logic proof-nets, we see that the contraction ($?C$ link) will be hard to handle. Indeed, we duplicate a whole box, which can contain an arbitrary proof-net. Whatever the weight associated to the proof-net inside the duplicated box is, it seems like we duplicate the weight when we duplicate the box. So, it seems hard to define any quantity which would decrease during cut elimination.

During a step of cut-elimination, most of the proof-net does not change. Most edges of the reduced net can be related with an edge from the original net. For example we want to say that e' of figure 8b comes from e of figure 8a. Similarly, $e1$ and $e2$ come from e' . We say that e' , $e1$ and $e2$ are reducts of e . The idea of context semantics is to anticipate cut elimination and speak of the future links and edges. If we consider the reduct of an edge e during a sequence of cut-elimination, we can observe that it forms a “reducts tree” : each reduct has 2 sons in the next proof-net if it is in a box which is duplicated during the cut-elimination step, 0 son if it is in a box which is deleted, 1 son instead. What we want to capture is the set of leafs of this tree. Indeed, when a box is duplicated, it may increase the number of links and edges, but for every duplicated edge e , the leafs of the reducts tree of e is splitted between the two immediate reducts of e . So the number of leafs of reducts trees does not increase. For the moment, we will call “duplicates” this informal notion of “leafs of reducts trees”. The following definitions will help us capturing it by formal definitions (duplicates will correspond to “canonical potential edges”).

3.1 Definition of contexts

The language *Sig* of *exponential signatures* is defined by induction by the following grammar:

$$Sig = e \mid l(Sig) \mid r(Sig) \mid p(Sig) \mid n(Sig, Sig)$$

An exponential signature corresponds to a list of choices of premises of $?C$ links. $r(t)$ means : “I choose the right premise, and in the next $?C$ links I will use t to make my choices”. The construction $n(t, u)$ allows to encapsulate two sequels of choices into one. It corresponds to the digging rule ($??A \vdash B \rightsquigarrow ?A \vdash B$, represented by the $?N$ link in proof-nets) which “encapsulates” two $?C$ modalities into one. The $p(t)$ construction is a degenerated case of the n construction. Intuitively, $p(t)$ corresponds to $n(\emptyset, t)$. In this paper, we will use the symbols t, u and v to denote exponential signatures.

A *potential* is a list of exponential signatures : an exponential signature corresponds to the duplication of one box, but a node is duplicated whenever any of the boxes containing it is cut with a $?C$ node. A potential is meant to represent all those possible duplications of a node, so there will be an exponential signature for each box containing it. The set of potentials is *Pot*. In this paper, we will use the symbols P, Q, R for potentials.

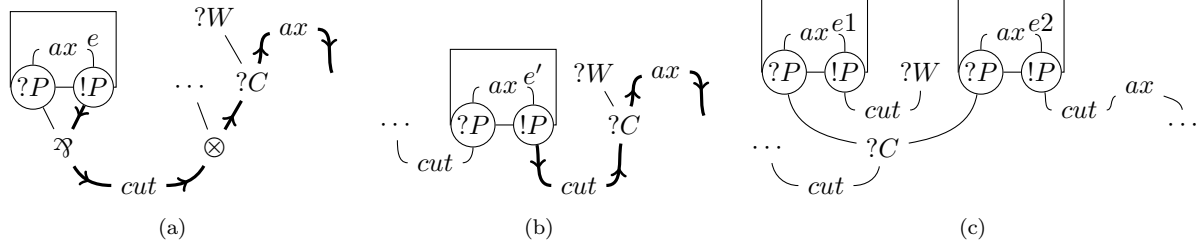

Figure 8: The path of subfigures (a) and (b) (from the principal door to the conclusion of the proof net) should lead to the same trace

A *potential box* is the couple of a box B and a potential of length $\partial(B)$. For any box B , we denote the set of potential boxes whose first component is B by $Pot(B)$. We define similarly the notions of potential edges (and the notation $Pot(e)$), potential links (and the notation $Pot(l)$) and so on. However, this notion does not capture the intuitive notion of “future duplicate”. Indeed, $(B, l(l(l(r(l(r(e)))))))$ is a potential box of figure 11, even if it does not correspond to a duplicate of B . In section 3.3, we will define the notion of canonical potential, which fixes this mismatch.

A trace element is one of the following characters : $\mathfrak{A}_l, \mathfrak{A}_r, \otimes_l, \otimes_r, \forall, \exists, \S, \dagger_t, ?_t$ with t a potential. A trace element means “I have crossed an element with this label, from that premise to its conclusion”. The set of trace elements is $TrEl$. ($TrEl = \S \mid \dagger_{Sig} \mid ?_{Sig} \mid \mathfrak{A}_l \mid \mathfrak{A}_r \mid \otimes_l \mid \otimes_r \mid \forall \mid \exists$)

A *trace* is a non-empty list of trace elements. The set of traces is Tra . A trace is a partial memory of the links we have crossed. Intuitively, it remembers the path crossed up to cut eliminations. For example, we want the traces of both path of figure 8 to be the same.

A *polarity* is either $+$ or $-$. It will tell us in which way are we crossing the arrows. The set of polarities is Pol . We will use the notation b^\perp for “the polarity dual to b ” ($+\perp = -$ and $-\perp = +$). Similarly, $\mathfrak{A}_x^\perp = \otimes_x$, $\otimes_x^\perp = \mathfrak{A}_x$, $\forall^\perp = \exists$, $\dagger_{i_1 \dots i_n}^\perp = ?_{i_1 \dots i_n}$. We extend the notion of dual on traces by $([e_1; \dots; e_k])^\perp = [e_1^\perp; \dots; e_k^\perp]$. We also define, for any formula A , A^b as $A^+ = A$ and $A^- = A^\perp$.

A *context* is an element (e, P, T, p) of $C_G = E_G \times Pot \times Tra \times Pol$. It can be seen as a token that will travel around the net. It is located on edge e (more precisely its future duplicate corresponding to P) with orientation p and carries information T about its past travel.

The vertices define two relations \rightsquigarrow and \leftrightarrow on contexts. The rules are presented in figures 9 and 10. For any rule $(e, P, T, p) \rightsquigarrow (g, Q, U, q)$ the dual rule $(g, Q, U^\perp, q^\perp) \rightsquigarrow (e, P, T^\perp, p^\perp)$ holds as well. For example, the first \mathfrak{A} rule also gives the following rule : $(c, P, T^\perp, \otimes_l, -) = (c, P, (T \cdot \mathfrak{A}_l)^\perp, +^\perp) \rightsquigarrow (a, P, T^\perp, +^\perp) = (a, P, T^\perp, -)$. So for any P, T , $(c, P, T \cdot \otimes_l, -) \rightsquigarrow (a, P, T \cdot \otimes_l, -)$.

\mapsto is the union of \rightsquigarrow and \leftrightarrow .

The behaviour induced by those rule can be understood by observing the path of figure 11. Crossing the \mathfrak{A} downward, we have to keep as an information that we come from the right premise of the \mathfrak{A} , so that we know which premise of the \otimes will be cut with a after the reduction of the left cut. In context semantics, the information about the past is contained in the trace, so we put \mathfrak{A}_r on the trace.

The jump from d to e can be surprising : indeed if we reduce cut the left cut, then the principal door of B is cut with the auxiliary door of B' . And if we reduce this cut, the boxes B and B' fuse. It seems that box B has disappeared and will never have any more duplicates. To understand why this jump is necessary, we can look at another sequence of cut eliminations : if we reduce both cuts, the principal door of B will be cut with a contraction link (which comes from d). To take all the possible future duplicates of B into account, we have to make this jump.

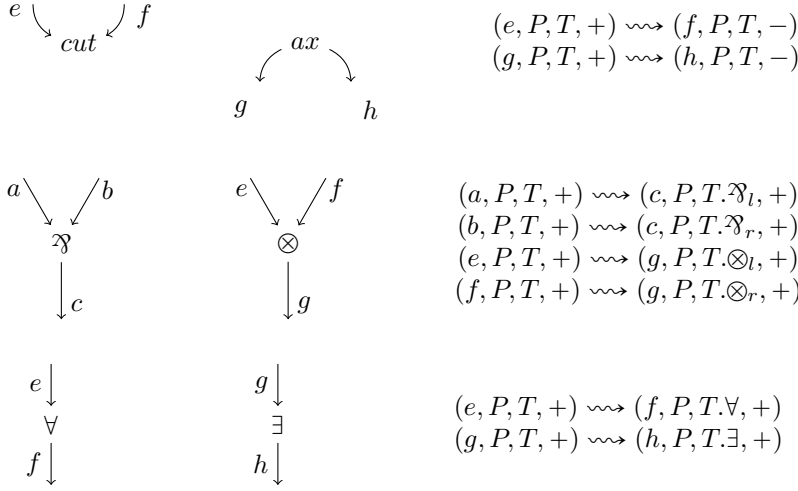

Figure 9: Multiplicative and quantifier rules of context semantics

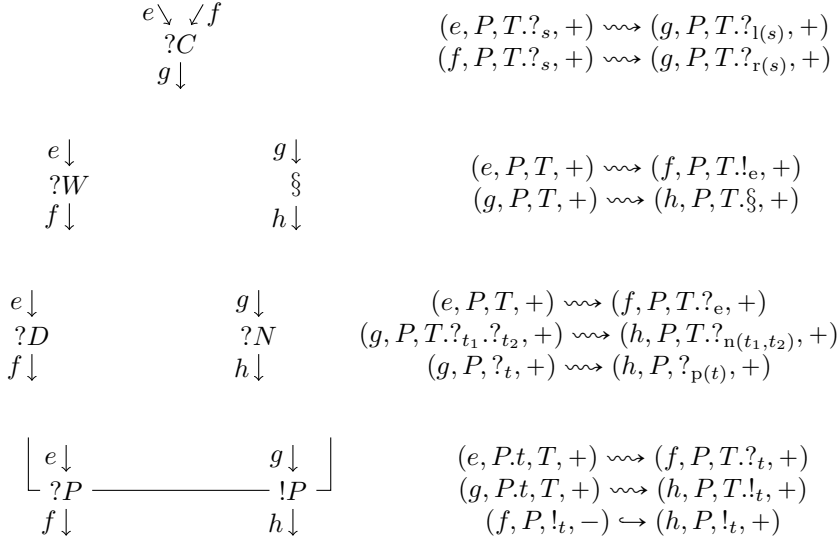

Figure 10: Exponential rules of the context semantics

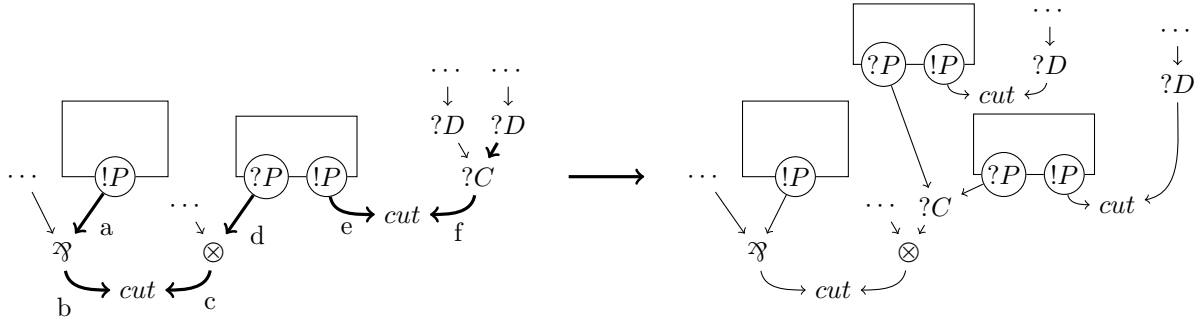

Figure 11: $(a, [], !_{[2]}, +) \rightsquigarrow (b, \epsilon, \mathfrak{A}_r, ::!_{[2]}, +) \rightsquigarrow (c, \epsilon, \mathfrak{A}_r, ::!_{[2]}, -) \rightsquigarrow (d, \epsilon, !_{[2]}, -) \leftrightarrow (e, \epsilon, !_{[2]}, +) \rightsquigarrow (f, \epsilon, !_{[2]}, -) \rightsquigarrow (g, \epsilon, !_e, -)$

3.2 Dealing with the digging

A *standard* exponential signature is one that does not contain the constructor p . An exponential signature t is *quasi-standard* iff for every subtree $n(t_1, t_2)$ of t , the exponential signature t_2 is standard. The $n(-, -)$ construction corresponds to the $?N$ cut elimination of figure 6 : we want to be able to speak about the duplicate of some edge in the duplicate t_1 of B_1 , which is itself in the duplicate t_2 of B_2 . But, if we are interested in the box B_2 , then the $n(-, -)$ construction has no meaning, because we are not in any duplicate of B_1 . When we are only interested in the duplicates of box B_2 , we use the $p(-)$ construction.

These two notions are quite related : if a potential node is in the $n(t_1, t_2)$ duplicate of box B , then it is somehow contained in the $p(t_2)$ duplicate of box B . The \sqsubseteq relation defined below formalizes this relation.

We can notice that if $n(s_1, s_2)$ is a duplicate box B then it means that s_2 is a valid duplicate of box B_2 . So $p(s_2)$ is a valid duplicate of box B . More generally if s is a duplicate of any box B , and $s \sqsubseteq s'$ then s' is a duplicate of box B . So it is enough to describe the duplicates of a box which are minimal for \sqsubseteq (which we call standard) to describe all its duplicates.

We can also notice that the $p(-)$ construction, has no meaning in potentials. If edge e of G is contained in box B , and we want to speak about a future duplicate of e in the normal form of G . Not only do we need to know in which duplicates of box B_2 this duplicate of e will be, but also in which duplicate of B_1 . So, only standard signatures will be used in potentials.

The binary relation \sqsubseteq on Sig is defined as follows:

$$\begin{array}{ll}
e \sqsubseteq e & \\
l(t) \sqsubseteq l(t') & \Leftrightarrow t \sqsubseteq t' \\
r(t) \sqsubseteq r(t') & \Leftrightarrow t \sqsubseteq t' \\
p(t) \sqsubseteq p(t') & \Leftrightarrow t \sqsubseteq t' \\
n(t_1, t_2) \sqsubseteq p(t') & \Leftrightarrow t_2 \sqsubseteq t' \\
n(t_1, t_2) \sqsubseteq n(t'_1, t'_2) & \Leftrightarrow t_1 \sqsubseteq t'_1 \text{ and } t_2 = t'_2
\end{array}$$

If $t \sqsubseteq t'$, then t is a simplification of t' . We also write $t \sqsubset t'$ for “ $t \sqsubseteq t'$ and $t \neq t'$ ”. We can observe that \sqsubseteq is an order and \sqsubset a strict order.

Our notation is reversed compared to Dal Lago’s notation. Intuitively, \sqsubseteq corresponds to an inclusion of future duplicates, but with the notation of [19], \sqsubseteq corresponds to \supseteq . We find this correspondence counter-intuitive, so we reversed the symbol. We found this change really important for the formalization of the “Dal Lago’s weight theorem” where we manipulate the \sqsubseteq relation really often. The correspondence is made precise through the \subseteq relation which encapsulates both \sqsubseteq and \sqsubset . We will later prove that the \subseteq relation is conserved during cut elimination.

We define \subseteq on $Pot(B_G) \times Sig$ by

$$(B, P, t) \subseteq (B', P', t') \Leftrightarrow \begin{cases} B \subset B' \text{ and } P = P' s' @ Q \text{ with } s' \sqsubseteq t' \\ \text{or} \\ B = B', U = U' \text{ and } t \sqsubset t' \end{cases}$$

3.3 Context semantics and time complexity

In this section we want to capture the potential boxes (resp. edges) which really correspond to duplicates of a box (resp. an edge). The definition can be difficult to understand. To give the reader an understanding of it, we will first try to capture intuitively this notion in the case of depth 0. We will do so by successive refinements.

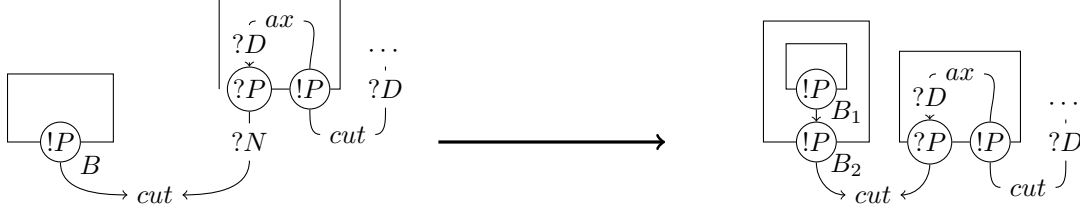

Figure 12: We do not want to consider $(B, n(e, l(r(l(e))))))$ as a valid duplicate of B

First, we could say that $(B, [s])$ corresponds to a duplicate iff t corresponds to a sequel of choices of duplicates along a *cut*-elimination sequel, and the duplicate we chose either will not be part of a *cut*, or the *cut* will open it. The relation on contexts which corresponds to *cut*-elimination is \rightsquigarrow . So, we could make the first following attempt : “ $(B, [s])$ corresponds to a duplicate iff $(\sigma(B), [], [!_s], +) \rightsquigarrow^* (e, P, T, -) \dashv\rightsquigarrow$. In figure 8, it gives $(B, [l(e)])$ and $(B, [r(e)])$ as valid duplicates for box, which is the expected result.

However figure 11 shows that sometimes, even if the only immediate *cut* on a box B would open it, reducing other cuts in the proof-net can change the type of *cut* elimination box B faces. In order to capture all the *cut*-elimination sequences, we must extend \rightsquigarrow . This is the exact purpose of \hookleftarrow and \hookrightarrow . Our second try would be “ $(B, [s])$ corresponds to a duplicate iff $(\sigma(B), [], [!_s], +) \mapsto^* (e, P, T, -) \dashv$ ”.

However, this definition would allow potential boxes which refuse choices : for example $(B, [e])$ in figure 11 satisfies this second definition. We would like the potentials of B in this figure to be $(B, [l(e)])$ and $(B, [r(e)])$. $(B, [e])$ is just an intermediary step. Thus, our third try would be “ $(B, [t])$ corresponds to a duplicate iff $(\sigma(B), [], [!_t], +) \mapsto^* (e, P, T, -) \dashv$ and no increase of t will allow a longer path after $(e, P, T, -)$ ”.

Similarly, we do not want the potential box to make choices on situations which will never happen. For example, we refuse $(B, [l(r(p(e, l(e))))])$. So we add the condition “Any truncation of t will stop before t does”.

Finally, figure 12 shows that those property must be true not only for t but also for all its simplifications. Indeed, we do not want to consider $(B, n(e, l(r(l(e)))))$ to be a valid potential box because $l(r(l(e)))$ do not correspond to a copy of B_1 .

If the depth of box B is > 0 , then $[t_1; \dots; t_n]$ can not be a valid duplicate for B if $[t_2; \dots; t_n]$ is not a valid duplicate for the box containing immediately B . What we have described for boxes at depth 0 will give the notion of copy. A potential corresponds to a duplicate if all its signatures are copies, in this case it will be called a canonical potential.

Lemma 2. *If $(e, [p_1; \dots; p_m], [!_s]@T, p) \mapsto^k (f, [q_1; \dots; q_n], [!_t]@U, q)$, s is a truncation of s' and for $1 \leq i \leq m$, $p_i \triangleleft p'_i$. Then $(e, [p'_1; \dots; p'_m], [!_{s'}]@T, p) \mapsto^k (f, [q'_1; \dots; q'_n], [!_{t'}]@U, q)$ with t a truncation of t' and for all $1 \leq i \leq n$, $q_i \triangleleft q'_i$.*

Proof. By induction on k . The statement is trivial for $k = 0$, and a case-by-case analysis of all \mapsto rules gives us that the statement is true for $k = 1$ and that the hypothesis are preserved. \square

A relation \rightarrow on contexts a “cut simulation” if :

- $\rightarrow \subseteq \mapsto$
- If $(e, P, T.t, -) \rightarrow (f, Q, T@U, q)$ and $|T| > 1$ then for every T' with $|T'| > 1$ and P' with $|P'| = |P|$, $(e, P', T'.t, p) \rightarrow$

- If $(e, P, T, +) \rightarrow (f, Q, T@U, q)$ and $|T| > 1$ then for every T' with $|T'| > 1$ and P' with $|P'| = |P|$, $(e, P', T', p) \rightarrow$

We now consider a cut simulation \rightarrow . In this section, the only cut simulation we use is \mapsto itself. However, in section 4, we will use other relations.

Copy simplification A context $(e, P, [!_t]@T, p)$ is a \rightarrow -copy context if

- $(e, P, [!_t]@T, p) \rightarrow (e_1, P_1, T_1, p_1) \cdots \rightarrow (e_n, P_n, T_n, p_n) \mapsto$
- If $(e, P, [!_u]@T, p) \rightarrow (e_1, Q_1, U_1, q_1) \cdots \rightarrow (e_n, Q_n, U_n, q_n)$, then $t \leq u$ and $(e_n, Q_n, U_n, q_n) \mapsto$

Definition 2 (Copy). A \rightarrow -copy of a potential box (B, P) is a standard exponential signature t such that for all $t \sqsubseteq u$, $(e, P, [!_u], +)$ is a \rightarrow -copy context.

The set of \rightarrow -copies of (B, P) is $C_{\rightarrow}(B, P)$. The set of simplifications of copies of (B, P) is $S_{\rightarrow}(B, P)$. Intuitively, $S_{\rightarrow}(B, P)$ corresponds to the duplicates of B , knowing the duplicates of the outer boxes we are in.

Definition 3 (Canonical potential). Let $e \in B_{\partial(e)} \subset \dots \subset B_1$, a \rightarrow -canonical potential for e is a potential $[s_1; \dots; s_{\partial(e)}]$ such that $\forall i \leq \partial(e), s_i \in C_{\rightarrow}(B_i, [s_1; \dots; s_{i-1}])$. The set of \rightarrow -canonical sequences for e is $L_{\rightarrow}(e)$. Intuitively, a \rightarrow -canonical potential for e is the choice, for all box B_i containing e , of a copy of B_i . $L_{\rightarrow}(e)$ corresponds to all the possible duplicates of e . We define $L_{\rightarrow}(B) = L_{\rightarrow}(\sigma(B))$. Let x be an edge or a box, we will write $Can(x)$ for $\{x\} \times L_{\rightarrow}(x)$.

Canonical context A context $(e, P, [!_t]@T, p) \in C_G$ is said \rightarrow -canonical if :

- $P \in L_G(e)$
- t is quasi standard and for every $t \sqsubseteq v$, $(e, P, [!_v]@T, p)$
- If $T = U.!_u@V$ then u is standard and there exists $v \leq u$ such that for every $v \sqsubseteq w$, $(e, P, [!_w]@V, p)$ is a \rightarrow -copy context
- If $T = U.?_u@V$ then u is standard and there exists $v \leq u$ such that for every $v \sqsubseteq w$, $(e, P, [!_w]@V^{\perp}, p^{\perp})$ is a \rightarrow -copy context

The only paths that interest us in this paper are those which correspond to copies or simplifications of copies of potential boxes. Those contexts have special properties, that we need in some lemmas. Therefore, we assume that all contexts in this paper are canonical (unless otherwise stated) this is possible thanks to lemma 4.

Lemma 3. If $C \rightarrow D$ then C is a \rightarrow -copy context if and only if D is a \rightarrow -copy context

Proof. Straightforward, by definition of \rightarrow -context □

Lemma 4. If C is \mapsto -canonical and $C \rightarrow D$ then D is canonical.

Proof. The proof is done by a straightforward case by case analysis. Here, we consider only one of the cases. We suppose that $C = (e, P.t', [!_t]@T, +) \rightarrow (f, P, [!_t]@T.?_{t'}, +) = D$, crossing an auxiliary door of a box B downwards. $P.t'$ is \rightarrow -canonical for e so by definition P is \rightarrow -canonical for $\sigma(B)$. $\sigma(B)$ and f belong to the same boxes so P is \rightarrow -canonical for f . t is quasi-standard, and for every $t \sqsubseteq u$, $(e, P.t', [!_u]@T, +)$ is a \rightarrow -copy context and $(e, P.t', [!_u]@T, +) \rightarrow (f, P, [!_u]@T.?_{t'}, +)$ (by definition of cut simulations) so $(f, P, [!_u]@T.?_{t'}, +)$ is a \rightarrow -copy context (lemma 3). Let us suppose that $T.?_{t'} = U.?_u@V$, then it depends whether $V = []$ or not. If V is not empty, $T = U.?_u@W$ for some W , so there exists $v \leq u$ such that for every $v \sqsubseteq w$, $(e, P.t', [!_w]@W^{\perp}, -)$, by lemma 3, we prove that $(f, P, [!_w]@V^{\perp}, +)$ is a \rightarrow -copy context. Else, we know that $P.t'$ is \rightarrow -canonical for e , so t' is a \rightarrow -copy of (B, P) . If $(f, P, !_v, -) \rightarrow (\sigma(B), P, !_v, +)$, we can take $v = t'$ and prove the needed properties with lemma 3. Else, we take $v = e$. The case $T.?_{t'} = U.!_u@V$ is treated in the same way but is simpler because $V \neq []$. □

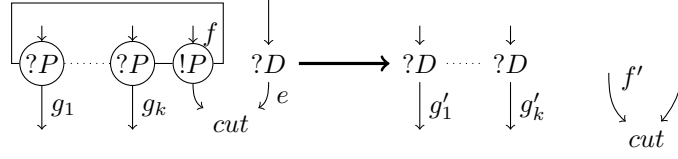

Figure 13: The dereliction elimination rules motivates the introduction of a second morphism to capture the relation between a proof net and its reduct

We define a weight T_G . In the following, we will prove that T_G is an upper bound on the length of the longest cut-reductions sequence. This result was already proved in [19] for a really similar framework. The proof of Dal Lago was quite convincing for people having a good intuition on proof-net. however it was not really formal. Here, we take a complementary approach : we propose a proof which is quite formal, with many details provided. The downside us that our proof is much more difficult to read than the one in [19].

Definition 4 (weights). *For every proof-net G , we define*

$$T_G = \sum_{e \in E_G} |L_{\mapsto}(e)| + 2 * \sum_{e \in P_G} \left(D_G(e) \sum_{P \in L_{\mapsto}(e)} \sum_{t \in S_{\mapsto}(e,P)} |t| \right)$$

Let G be a proof net. We say that G is cyclic if there exists $e \in E_G$, $P \in L_G(e)$, $b \in Pol$, $s, s' \in Sig$ such that $(e, P, !_s, b) \mapsto (e, P, !_{s'}, b)$. Otherwise, G is acyclic.

Intuitively, a cyclic proof structure may not normalize. In term of W_G and T_G : suppose that the cycle consumes some exponential signatures $(s_1 \cdots s_k)$ and that a path corresponding to a copy t of a potential box (B, P) passes through this cycle. Then we can insert $s_1 \cdots s_k$ as many times as we want in t , creating an infinity of copies for B , so T_G would be infinite. We will therefore prove that proof nets are acyclic.

3.4 Copymorphisms : motivations and definitions

The idea of context semantics is to anticipate the cut elimination. We said (e, P) and (e, Q) represent two future duplicates of the edge e . However, we have not made explicit the link between the potential edges and the duplicates of the edge. We would like to explicit, for all $G \rightarrow_{cut} H$ a mapping from potential edges of G to the potential edges of H .

Furthermore, we would like to use this mapping to prove that $T_H < T_G$ so this mapping must relate the copies and canonical potential of G and H . The copies are defined by paths, so we would like ϕ to keep \mapsto intact.

Looking at the rules of \rightarrow_{cut} we see that it will be impossible to have a complete mapping which “keeps \mapsto intact”. For example, in the \mathfrak{A}/\otimes case, what could be the image of the edges cut? So ϕ will be a partial mapping. The important paths are the paths corresponding to copies, such paths begin at principal doors, sno we would like all $(\sigma(B), P)$ (with $B \in B_G$) to be in the domain of ϕ . Conversely, we would like all the $(\sigma(B'), P')$ (with $B' \in B_H$) to be images of some $(\sigma(B), P)$ (with $B \in B_G$). Notice that it is not possible to ask the images of $(\sigma(B), P)$ ($B \in B_G$) to be principal doors of H because of the dereliction rule.

We will prove later that paths corresponding to \mapsto -copies end by “final contexts” as defined below. Here, we do not need the result but just the intuition to guide our definition. Notice that, in the definition of Dal Lago, the copies are defined by paths finishing by final-contexts. The Dal Lago’s definition is a theorem in our framework. This change of definition was necessary because, in the proofs of our main results, we will need to consider other copies for relations other than \mapsto .

Definition 5. A context $(e, P, [!_e]@T, p)$ is said final if either :

- $p = -$ and the tail of e is $?D$
- $p = -$ and the tail of e is $?W$
- $p = +$ and the head of e is \bullet

The set of final contexts of G is written F_G .

We would like paths finishing by final contexts to be preserved by ϕ . So we would like conclusions of $?D$ and $?W$ links, and pending edges of E_G to be in the domain of ϕ (for all potentials) and such edges of E_H to be in the codomain of ϕ (for all potentials). However, when we analyse the $?D$ and $?W$ cut elimination rules, we see that it will not be possible. In figure 13, edge e is intuitively transformed in many edges: $\{g'_1, \dots, g'_k\}$ and if we defined any of those to be the image of e , the \mapsto^* relation would not be kept intact (for example $(f, [e], T, +) \mapsto^* (e, [], T.!_e, -)$ but we can not have a similar relation between f' and g'_i). Does this mean that we can not explicit a correspondence between the copies of G and H ? In fact we just have to be more subtle. The paths we are interested in are those who begin by a principal door and finish by contexts $(e, P, [!_e], -)$. Such a context can not come from the interior of box B (it would have a longer trace) so either it comes from $\sigma(B)$ (in this case, the box being deleted we will deal with this copy in another way) or from a \hookrightarrow rule. In the latter case, we see that the corresponding path would be stopped by a g'_i . There is some correspondence between e and the g'_i , even if it can not be captured by ϕ . We will need another mapping ψ to capture it.

We gather all the properties written above into the concept of “copymorphism”:

Definition 6 (Copymorphism). Let G and H be two proof-nets, a partial Copymorphism from G to H is a tuple $(D_\phi, D'_\phi, \phi, \psi)$ with :

1. $D_\phi \subseteq E_G, D'_\phi \subseteq E_H$
2. ϕ a complete bijective mapping from $Pot(D_\phi) \times Sig$ to $Pot(D'_\phi) \times Sig$ such that :

(a) The paths are the same in G and H :

$$\text{If } \left. \begin{array}{l} \phi(e, P, t) = (e', P', t') \\ \phi(f, Q, u) = (f', Q', u') \end{array} \right\}, \text{ then } \forall T, U \in Tra, \forall p, q \in Pol \quad \begin{array}{l} (e, P, [!_t]@T, p) \mapsto^* (f, Q, [!_u]@U, q) \\ \Leftrightarrow \\ (e', P', [!_{t'}]@T, p) \mapsto^* (f', Q', [!_{u'}]@U, q) \end{array}$$

(b) ϕ preserves the inclusion of boxes :

$$\text{If } \left. \begin{array}{l} \phi(\sigma(B), P, t) = (\sigma(B'), P', t') \\ \phi(\sigma(C), Q, u) = (\sigma(C'), Q', u') \end{array} \right\}, \text{ then } \begin{array}{l} (B, P, t) \subseteq (C, Q, u) \\ \Leftrightarrow \\ (B', P', t') \subseteq (C', Q', u') \end{array}$$

(c) ϕ is boxwise :

$$\left. \begin{array}{l} B \text{ deepest box containing } e \text{ with } \sigma(B) \in D_\phi \\ \phi(\sigma(B), Q, t) = (\sigma(B'), Q', t') \\ \phi(e, Q.t@R, u) = (e', P', u') \\ \phi(e, Q.t@S, u) = (f', S', v') \end{array} \right\} \Rightarrow \left\{ \begin{array}{l} e' = f' \\ u' = v' \\ \rho(e' = f') = B' \\ P' = S' = Q'.t' \end{array} \right.$$

(d) All principal doors of H are in the image, by ϕ , of the principal doors of G :

$$\{\phi(\sigma(B), P, s) \mid \sigma(B) \in D_\phi, |P| = \partial(\sigma(B)), s \in Sig\} = \{(\sigma(B'), P', s') \mid B' \in B_H, |P'| = \partial(\sigma(B')), s' \in Sig\}$$

(e) Images of final contexts are final

$$\begin{aligned} & \{(e', P', [!_{t'}]@T, b) / \exists(e, P, [!_t]@T, b) \in F_G \quad \text{and} \quad \phi(e, P, t) = (e', P', t')\} \\ & \cup \\ & \{(e', P', [!_{t'}]@T, b) / \exists C, \exists(e, P, [!_t]@T, b) \in \psi(C) \quad \text{and} \quad \phi(e, P, t) = (e', P', t')\} = F_H \end{aligned}$$

(f) If $\phi(\sigma(B), P, t) = (\sigma(B'), P', t')$ and s is standard, then s' is standard.

(g) If $B \subset C$, $\sigma(B) \in D_\phi$ and $\sigma(C) \notin D_\phi$ then $\forall P \in L_G(C), C_G(C, P) \neq \emptyset$

3. ψ is a partial mapping from $D_\psi = ((E_G - D_\phi) \times \text{Pot} \times \text{Tra} \times \text{Pol}) \cap F_G$ to $\mathcal{P}(D'_\phi \times \text{Pot} \times \text{Tra} \times \text{Pol})$ such that $\forall(e, P, T, b) \in D_\psi$, there exists $k \in \mathbb{N}$ such that :

(a) $\forall j \leq k, ((f, Q, U, c) \mapsto^j (e, P, T, b)) \Rightarrow f \notin (\sigma(B_G) \cap D_\phi)$

(b) $((f, Q, U, c) \mapsto^k (e, P, T, b)) \Leftrightarrow (f, Q, U, c) \in \psi(e, P, T, b)$

In order to use this definition of copymorphism, we will have to prove that the paths corresponding to a copy (or simplification of a copy) indeed have a final context as last context. This is the goal of the next subsection.

3.5 Underlying formula of a context

3.5.1 Intuition of the proof

The idea of this subsection is to prove that, if a context C comes from an edge e with an empty trace, then C still has information about the formula $\beta_G(e)$. We can define an underlying formula for the contexts, and this underlying formula will be stable by \rightsquigarrow in typed proof-nets. A consequence from this, is that if we begin a path by a context with a “right trace”, then this path will never be blocked by a mismatch between the trace and the type of link above our edge (the tail of our edge). For example we will never have $(e, P, T, \forall, -)$ with the tail of e being a \otimes link. However, it does not prevent blocking situations such as $(e, P, T, !_e, -)$ with the tail of e being a $?C$ link.

Our first idea to define the underlying formula of $(e, P, T, +)$ would be to use T to prune the syntactic tree of $\beta_G(e)$. For example the underlying formula of $(e, P, !_{l(e)}. \forall_r, \forall, +)$ with $\beta_G(e) = \forall X.?(X \otimes X^\perp) \forall!(X^\perp \forall X)$ would be $X^\perp \forall X$. Noticing that crossing *cut* and *axiom* does not change the trace but transform the labelling formula into its dual, we would define the underlying formula of $(e, P, T, -)$ as $\beta_G(e)^\perp$ pruned using T .

However, there is a problem with this definition when we cross a \exists link downwards. For example if $(c, [], !_e. \otimes_r, +) \mapsto (d, [], !_e. \otimes_r. \exists, +)$ with $\beta_G(c) =?(X \otimes X^\perp) \otimes!(X^\perp \forall X)$ and $\beta_G(d) = \exists Y.Y \otimes Y^\perp$ (figure 14). The underlying formula of $(c, [], !_e. \otimes_r, +)$ is $X^\perp \forall X$, but $(c, [], !_e. \otimes_r. \exists, +)$ has no underlying formula : the trace is not compatible with the syntactic tree of $\beta_G(d)$. A solution would be to index the \exists with the formula they capture. During the paths, this index could be transferred to eigenvariables and \forall links as in figure 14.

In figure 14, we extend traces, and we insert substitutions in the contexts to deal with eigenvariables. If we defined the underlying formula of $(e, P, T, \theta, +)$ as $(\beta_G(e)|_T)[\theta]$ ($F|_T$ representing F pruned using the extended trace T , for example $(\exists X.F')|_{T.\exists_B} = (F'[B/X])|_T$) then we could hope that the underlying formula would not change along a \mapsto path (as in figure 14). However, with multiple crossing of \exists and \forall links, the situation becomes a bit more complicated, substitutions will not be precise enough to describe the situations.

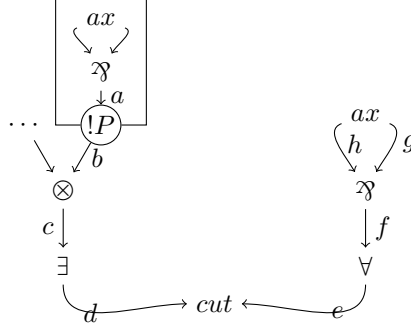

Figure 14: To keep the same underlying formula along the path, we would like to extend the contexts in the following way : $(a, [e], \mathfrak{A}_r, \emptyset, +) \mapsto^2 (c, [], \mathfrak{A}_r.!e.\otimes_r, \emptyset, +) \mapsto (d, [], \mathfrak{A}_r.!e.\otimes_r.\exists_l(Y^\perp \mathfrak{A} Y), \emptyset, +) \mapsto (e, [], \mathfrak{A}_r.!e.\otimes_r.\exists_l(Y^\perp \mathfrak{A} Y), \emptyset, -) \mapsto (f, [], \mathfrak{A}_r.!e.\otimes_r.\{Z \mapsto!(Y^\perp \mathfrak{A} Y)\}, -) \mapsto^3 (f, [], \mathfrak{A}_r.!e.\mathfrak{A}_l.\{Z \mapsto!(Y^\perp \mathfrak{A} Y)\}, +) \mapsto (e, [], \mathfrak{A}_r.!e.\mathfrak{A}_l.\forall_{Y^\perp \mathfrak{A} Y}, \emptyset, +) \mapsto (d, [], \mathfrak{A}_r.!e.\mathfrak{A}_l.\forall_{Y^\perp \mathfrak{A} Y}, \emptyset, -) \mapsto (c, [], \mathfrak{A}_r.!e.\mathfrak{A}_l, \emptyset, -)$

Indeed, let us suppose that $(e, P, T, \{Z \mapsto (Z_1^\perp \mathfrak{A} Z_1)\}, +) \mapsto (f, P, T, \exists_B, \{Z \mapsto (Z_1^\perp \mathfrak{A} Z_1)\}, +)$, crossing a \exists link whose associated formula $(Z \otimes A)$, for example, contains all the free Z of $\beta_G(e)$. How will we define B ? If we define the list of substitutions of eigenvariables as $\{Z \mapsto Z_1^\perp \mathfrak{A} Z_1, Y \mapsto Z \otimes A\}$, we will have to maintain an order of dependencies. If we define it as $\{Y \mapsto (Z_1^\perp \mathfrak{A} Z_1) \otimes A\}$ it will be harder to prove, when the path will come back to cross upwards the \exists link, that the formula associated to the \forall in the trace corresponds to the formula associated to the \exists link in the proof net. Our solution is to maintain a tree of substitutions which is a truncation of a “ztree”¹ which depends on the edge and potential of the context (not on the trace).

3.5.2 Substitution trees

Substitution trees are defined coinductively by : if $T_1 \dots T_k$ are substitution trees, $X_1 \dots X_k$ are distinct variables and B_1, \dots, B_k are formulae, then $\{(X_1, B_1, T_1) \dots (X_k, B_k, T_k)\}$ is a substitution tree. Substitution trees are potentially infinite (even if we will later prove that they are always finite).

Definition 7 (ztree). *Let (e, P) be a potential edge of G and $Z_1 \dots Z_k$ the eigenvariables of $\beta_G(e)$. The complete substitution of (e, P) (written $ztree(e, P)$) is defined coinductively by the following. Let f_i be the conclusion of the \forall link associated to Z_i , and Q_i be P restricted at f_i depth. Let E be $\{Z_i/\exists g_i, R_i, (f_i, Q_i, \forall, +) \mapsto^* (g_i, R_i, \forall, -)\}$ with g_i the conclusion of a \exists link l_i . Then,*

$$ztree(e, P) = \{(Z_i, B_i, ztree(h_i, R)) / Z_i \in E\}$$

with B_i the formula captured by l_i and h_i its premise.

This definition is quite formal. The idea is the following : if the eigenvariable Z is part of the formula labelling edge e and l is the \forall link associated with Z . Then, when l is cut with a \exists with associated formula B , then Z will be replaced by B in the formula labelling e . It may happen that l is duplicated during the *cut* elimination process, so Z would be replaced by different formulae in different duplicates of e . However, if we fix a potential P , then there is a unique potential \exists link (m, Q) so that (l, P) will be cut with (m, Q) during cut elimination. We can compute this (m, Q) (if there is one) using the paths of context semantics. There may be other eigenvariables inside B (the formula associated to the \exists link), but in the same way, we can compute by which formulae those eigenvariables will be replaced and so on. In the end we have a big tree which says Y will be replaced by B , Z will be replaced by C , but inside B the eigenvariable W will be replaced by the formula D , and inside D ... A node of this tree may have no child (it corresponds to an

¹The ztrees are trees dealing with eigenvariables, most often named Z in the litterature, hence the “z” of “ztree”

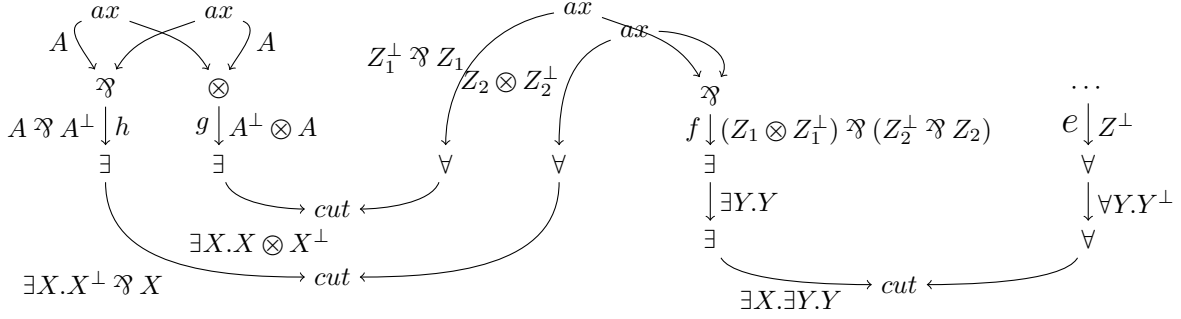

Figure 15:
$$\begin{aligned} ztree(e) &= \{(Z, (Z_1 \otimes Z_1^\perp) \wp (Z_2^\perp \wp Z_2), ztree(f))\} \\ &= \{(Z, (Z_1 \otimes Z_1^\perp) \wp (Z_2^\perp \wp Z_2), \{(Z_1, A^\perp, ztree(g)), (Z_2, A^\perp, ztree(h))\})\} \\ &= \{(Z, (Z_1 \otimes Z_1^\perp) \wp (Z_2^\perp \wp Z_2), \{(Z_1, A^\perp, \emptyset), (Z_2, A^\perp, \emptyset)\})\} \end{aligned}$$

edge without eigenvariables in its formula, or such that none of its eigenvariables will be replaced during cut-elimination). But, for the moment, we have no assurance that the tree is finite. The $ztree$ of (e, P) gives a substitution σ such that $\beta_G(e)[\sigma]$ is exactly the label of (e, P) in the normal form of the proof-net. To understand how it works, you can look at the example of figure 15.

Let Θ be a finite substitution tree, the substitution induced by Θ is defined inductively by : If $\Theta = \{(Z_1, B_1, \Theta_1) \cdots (Z_k, B_k, \Theta_k)\}$ then the substitution induced by Θ is $\theta_\Theta = \{Z_1 \mapsto B_1[\theta_{\Theta_1}] \mid \cdots \mid Z_k \mapsto B_k[\theta_{\Theta_k}]\}$.

Let $(e, P) \in Pot(E_G)$, $A \in \mathcal{F}_{LL_0}$ and T, T' be two lists of trace elements (traces or empty list) and p a polarity, $\beta_{\{\}}(A, e, P, T, T', p)$ is inductively defined by:

- If $T = []$, then $\beta_{\{\}}(A, e, P, T, T', p) = \{A\}$
- If $A = B \otimes C$ and $T = U.\otimes_l$, then $\beta_{\{\}}(A, e, P, T, T', p) = \beta_{\{\}}(B, e, P, U, [\otimes_l]@T', p)$
- If $A = B \otimes C$ and $T = U.\otimes_r$, then $\beta_{\{\}}(A, e, P, T, T', p) = \beta_{\{\}}(C, e, P, U, [\otimes_r]@T', p)$
- If $A = B \wp C$ and $T = U.\wp_l$, then $\beta_{\{\}}(A, e, P, T, T', p) = \beta_{\{\}}(B, e, P, U, [\wp_l]@T', p)$
- If $A = B \wp C$ and $T = U.\wp_r$, then $\beta_{\{\}}(A, e, P, T, T', p) = \beta_{\{\}}(C, e, P, U, [\wp_r]@T', p)$
- If $A = \forall X.B$ and $T = U.\forall$, then
 - If there exists a potential exists link (l, Q) (whose associated formula will be named C) such that $(e, P, [\forall]@T', p) \rightsquigarrow^* (concl(l), Q, \forall, -)$. Then

$$\beta_{\{\}}(A, e, P, T, T', p) = \bigcup_{\Theta \triangleleft ztree(prem(l), Q)} \beta_{\{\}}(B[(C[\theta_\Theta])_{/LLL}/X], e, P, U, [\forall]@T', p)$$

- If such a potential link does not exist, $\beta_{\{\}}(A, e, P, T, T', p) = \beta_{\{\}}(B, e, P, U, [\forall]@T', p)$.

- If $A = \exists X.B$ and $T = U.\exists$, then
 - If there exists a potential exists link (l, Q) (whose associated formula will be named C) such that $(concl(l), Q, \exists, +) \rightsquigarrow (e, P, T, T', p)$. Then

$$\beta_{\{\}}(A, e, P, T, T', p) = \bigcup_{\Theta \triangleleft ztree(prem(l), Q)} \beta_{\{\}}(B[(C[\theta_\Theta])_{/LLL}/X], e, P, U, [\exists]@T', p)$$

– If such a potential link does not exist, $\beta_{\{\}}(A, e, P, T, T', p) = \beta_{\{\}}(B[Y/X], e, P, U, [\exists]@T', p)$ with Y a variable which is not used yet.

- If $A = !B$ and $T = U.!_t$, then $\beta_{\{\}}(A, e, P, T, T', p) = \beta_{\{\}}(B, e, P, U, [!_t]@T', p)$
- If $A = ?B$ and $T = U.?_t$, then $\beta_{\{\}}(A, e, P, T, T', p) = \beta_{\{\}}(B, e, P, U, [?_t]@T', p)$
- If $A = \S B$ and $T = U.\S$, then $\beta_{\{\}}(A, e, P, T, T', p) = \beta_{\{\}}(B, e, P, U, [\S]@T', p)$
- Otherwise, it is undefined

Definition 8 (underlying formula). *Let (e, P, T, p) be a context of G . Then, the underlying formulae of (e, P, T, p) , written $\beta_{\{\}}(e, P, T, p)$, is the set $\bigcup_{\Theta_e \triangleleft \text{ztree}(e, P)} \beta_{\{\}}(\beta_G(e)^p_{/LLL}[\theta_{\Theta_e}], e, P, T, [], p)$.*

Lemma 5. *?? If $(e, P, T, p) \rightsquigarrow (f, Q, U, q)$, then for all $A \in \beta_{\{\}}(e, P, [s], +) \cup \beta_{\{\}}(f, Q, U, q)$ there exists $B \in \beta_{\{\}}(e, P, T, p) \cap \beta_{\{\}}(f, Q, U, q)$ and a substitution σ such that $B = A[\sigma]$.*

Proof. We make a disjunction on the \rightsquigarrow rule used.

If the rule is neither a \exists nor a \forall rule, then the proof is technical but straightforward. In these cases, we can prove that $\beta_{\{\}}(e, P, T, p) = \beta_{\{\}}(f, Q, U, q)$. Let us take a formula $A \in \beta_{\{\}}(e, P, T, p)$ and show that $\beta_{\{\}}(f, Q, U, q)$. It is important to notice that $\text{ztree}(e, P)$ and $\text{ztree}(f, Q)$ are equal on the intersection of their domains. And those are the only one interesting, since the other variables (or their replacement) will be deleted by the pruning. So we can take Θ_f to be Θ_e restricted to the eigenvariables which are free in $\beta_G(f)$.

We have to prove that $A \in \beta_{\{\}}(\beta_G(f)^q_{/LLL}, f, Q, U, [], q)$. The formulae $\beta_G(f)$ and $\beta_G(e)$ are almost the same. The only possible differences are the addition or suppression of the head connective and a translation of the index of ground variables (in the axiom case). The first kind of difference is erased during the computations of $\beta_{\{\}}(\beta(f)^q_{/LLL}, f, Q, U, [], q)$ and $\beta_{\{\}}(\beta(e)^p_{/LLL}, e, P, T, p)$. Indeed, we prune the syntactic tree of the formula using the trace, and when we delete the head connective, we also delete the first element of the trace. The second kind of difference is erased because the formula considered is not $\beta_G(e)$ but $\beta_G(e)_{/LLL}$. Notice that if $(e, P, T = T_1.\forall@T_2, p) \rightsquigarrow (f, Q, U = T_1.\forall@U_2, q)$, then when we compute $\beta_{\{\}}(e, P, T, p)$ and $\beta_{\{\}}(f, Q, U, q)$ we will have as inductive cases $\beta_{\{\}}(B, e, P, T_1.\forall, T_2, p)$ and $\beta_{\{\}}(B, f, Q, T_1.\forall, U_2, q)$ and the potential link $(l, _)$ mentioned in the rule will be the same. Same for the \exists induction cases. As a consequence $A \in \beta_{\{\}, \Theta}(f, Q, U, q)$. The other inclusion is done similarly.

Crossing an \exists link downward. $(e, P, T, +) \rightarrow (f, P, T.\exists, +)$.

$$\begin{array}{c} e \downarrow B[C/X] \\ \exists \\ f \downarrow \exists X.B \\ | \end{array}$$

$$\begin{aligned} \beta_{\{\}}(f, Q, U, q) &= \bigcup_{\Theta_f \triangleleft \text{ztree}(f, Q)} \beta_{\{\}}(\beta_G(f)^q_{/LLL}[\theta_{\Theta_f}], f, Q, U, [], q) \\ &= \bigcup_{\Theta_f \triangleleft \text{ztree}(f, Q)} \beta_{\{\}}(\exists X.B_{/LLL}[\theta_{\Theta_f}], f, P, T.\exists, [], +) \end{aligned}$$

$$\beta_{\{\}}(f, Q, U, q) = \bigcup_{\Theta_f \triangleleft \text{ztree}(f, Q)} \bigcup_{\Theta_e \triangleleft \text{ztree}(e, P)} \beta_{\{\}}(B_{/LLL}[\theta_{\Theta_f}][C_{/LLL}[\theta_{\Theta_e}]/X], f, P, T, [\exists], +)$$

$$\begin{aligned} \beta_{\{\}}(e, P, T, p) &= \bigcup_{\Theta_e \triangleleft \text{ztree}(e, P)} \beta_{\{\}}(\beta_G(e)^p_{/LLL}[\theta_{\Theta_e}], e, P, T, [], p) \\ &= \bigcup_{\Theta_e \triangleleft \text{ztree}(e, P)} \beta_{\{\}}(B[C/X]_{/LLL}[\theta_{\Theta_e}], e, P, T, [], +) \end{aligned}$$

The only difference between $ztree(e, P)$ and $ztree(f, Q)$ is that the domain of the former may be bigger because C may contain some eigenvariables. So the truncations of $ztree(f, Q)$ all are truncations of $ztree(e, P)$. The only difference between $\beta_{\Omega}(e, P, T, p)$ and $\beta_{\Omega}(f, Q, U, q)$ is that in the latter we can make a different truncation for the branch corresponding to an eigenvariable Z in Θ_e (for occurrences of Z in C) and in Θ_f (for occurrences of Z in B). However, even if we use this possibility to pick a formula A in $\beta_{\Omega}(f, Q, U, q)$ which is not in $\beta_{\Omega}(e, P, T, p)$, we can define Θ as the union of Θ_e and Θ_f . Then $B = \bigcup_{\Theta \triangleleft ztree(e, P)} \beta_{\Omega}(B[C/X]_{/LLL}[\theta_{\Theta}], e, P, T, [], +)$ is in the intersection of the two sets and $A \triangleleft B$.

Crossing a \forall link downward. $(e, P, T, +) \rightsquigarrow (f, P, T, \forall, +)$. There are two cases, whether the potential \forall link will be cut with an \exists link or not. However, only the first case is interesting. In the case where the link will not be cut, we can use the same argumentation as in the multiplicative and exponential links. Thus, here we will suppose that there exists a potential \exists link (l, R) such that $(f, P, T, \forall, +) \rightsquigarrow (concl(l), R, \forall, -)$. We will denote by C the formula associated to l .

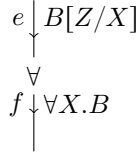

$$\begin{aligned}
\beta_{\Omega}(f, Q, U, q) &= \bigcup_{\Theta_f \triangleleft ztree(f, Q)} \beta_{\Omega}(\beta_G(f)^q_{/LLL}[\theta_{\Theta_f}], f, Q, U, [], q) \\
&= \bigcup_{\Theta_f \triangleleft ztree(f, Q)} \beta_{\Omega}(\forall X.B_{/LLL}[\theta_{\Theta_f}], f, P, T, \forall, [], +) \\
\beta_{\Omega}(f, Q, U, q) &= \bigcup_{\Theta_f \triangleleft ztree(f, Q)} \bigcup_{\Theta_l \triangleleft ztree(prem(e), R)} \beta_{\Omega}(B_{/LLL}[\theta_{\Theta_f}][C_{/LLL}[\theta_{\Theta_l}]/X], f, P, T, [\forall], +)
\end{aligned}$$

$$\begin{aligned}
\beta_{\Omega}(e, P, T, p) &= \bigcup_{\Theta_e \triangleleft ztree(e, P)} \beta_{\Omega}(\beta_G(e)^p_{/LLL}[\theta_{\Theta_e}], e, P, T, [], p) \\
&= \bigcup_{\Theta_e \triangleleft ztree(f, Q) \cup \{(Z, C, ztree(prem(l), R))\}} \beta_{\Omega}(B[Z/X]_{/LLL}[\theta_{\Theta_e}], e, P, T, [], +)
\end{aligned}$$

Here, the between $\beta_{\Omega}(e, P, T, p)$ and $\beta_{\Omega}(f, Q, U, q)$ is that in the latter the replacement of X is always done, whereas in the former, the truncation of $ztree(e, P)$ may delete this substitution. However, if we take a formula A of $\beta_{\Omega}(e, P, T, p)$, with a substitution tree Θ_e which does not make a substitution on Z , we can define the formula B obtained by extending Θ_e in Θ'_e which does not cut the edge (Z, C) but its successors. B belongs to both sets and $A \triangleleft B$.

The cases of crossing an \exists or a \forall link upwards are quite similar to the downwards cases, the roles of e and f are just swapped. \square

What this lemma means is that if we begin a path by a context whose trace corresponds to its formula (for example $(\sigma(B), P, !_t, +)$), the path will never be blocked by a mismatch between the top element of the trace and the link encountered. For instance, we will never reach a context $(e, Q, T, \forall, -)$ with $\beta_G(e) = A \otimes B$. This lemma will allow us to prove the corollary 1 which says that our copies are copies in the Dal Lago's definition. It will be important to prove the Dal Lago's weight theorem in our framework. But this is not the only purpose of this lemma. It will be used to prove the strong bound for L_0^4 .

Lemma 6 (Subtree property [19]). *For any exponential signature t and any $u \triangleleft t$, there exists v such that $t \sqsubseteq v$ and : If $\forall t \sqsubseteq w, \exists f, Q, T, q, (e, P, !_w, +) \mapsto^* (f, Q, [!_e]@T, q)$, Then there is (g, R) such that $(e, P, !_v, +) \mapsto^* (g, R, !_u, +)$.*

Definition 9. *The skeleton of a trace element is defined by : the skeleton of $!_t$ is $!$, the skeleton of $?_t$ is $?$, the skeleton of othes trace elements are themselves. We define the skeletons of a trace as the list of the skeletons of its trace elements*

Lemma 7. *If $(e_1, P_1, T_1, p_1) \mapsto (e_2, P_2, T_2, p_2) \cdots \mapsto (e_n, P_n, T_n, p_n)$, $(e_1, Q_1, U_1, p_1) \mapsto (e_2, Q_2, U_2, p_2) \cdots \mapsto (e_n, Q_n, U_n, p_n)$ and the skeletons of T_1 and U_1 are equal, then the skeletons of T_n and U_n are equal.*

Proof. It is enough to prove for the case $n = 1$, which can be done by analysis of all the \mapsto rules. \square

Definition 10. $t \leq^v u$ if we are in one of the following cases :

- $t = e$ and $u = v$
- $t = l(t')$, $u = l(u')$ and $t' \leq^v u'$
- $t = r(t')$, $u = r(u')$ and $t' \leq^v u'$
- $t = p(t')$, $u = p(u')$ and $t' \leq^v u'$
- $t = n(t', w)$, $u = r(u', w)$ and $t' \leq^v u'$

We also write $t \leq u$ for $\exists v, t \leq^v u$

Lemma 8. *If $u \leq^v u'$, T_n has the same skeleton as U_n and $(e_1, P_1, [!_{t=t_1}]@T_1, p_1) \mapsto (e_2, P_2, [!_{t_2}]@T_2, p_2) \mapsto \cdots \mapsto (e_n, P_n, [!_{u=t_n}]@T_n, p_n)$ then there exists $t \leq^v t'$ such that $(e_1, Q_1, [!_{t'=t'_1}]@U_1, p_1) \mapsto \cdots \mapsto (e_n, Q_n, [!_{u'=t'_n}]@U_n, p_n)$.*

If $u' \leq^v u$, U_n has the same skeleton as U_n and $(e_1, P_1, [!_{t=t_1}]@T_1, p_1) \mapsto (e_2, P_2, [!_{t_2}]@T_2, p_2) \mapsto \cdots \mapsto (e_n, P_n, [!_{u=t_n}]@T_n, p_n)$ then there exists $t' \leq^v t$ such that $(e_1, Q_1, [!_{t'=t'_1}]@U_1, p_1) \mapsto \cdots \mapsto (e_n, Q_n, [!_{u'=t'_n}]@U_n, p_n)$.

Lemma 9. *If $u \leq^v u'$, $(e_1, P_1, [!_{t=t_1}]@T_1, p_1) \mapsto (e_2, P_2, [!_{t_2}]@T_2, p_2) \mapsto \cdots \mapsto (e_n, P_n, [!_{u=t_n}]@T_n, p_n)$ and $(e_1, Q_1, [!_{t'=t'_1}]@U_1, p_1) \mapsto \cdots \mapsto (e_n, Q_n, [!_{u'=t'_n}]@U_n, p_n)$ then $t \leq^v t'$*

Theorem 1. *Let t be a standard exponential signature. $t \in C \rightarrow (B, P)$ if and only if for any $t \sqsubseteq u$, there exists a final context C_u such that $(\sigma(B), P, !_u, +) \rightsquigarrow^* C_u$.*

Proof. We will prove that u is a copy simplification if and only if there exists a final context C_u such that $(\sigma(B), P, !_u, +) \rightsquigarrow^* C_u$.

Let us suppose that $(\sigma(B), P, !_u, +) \mapsto (e_1, P_1, T_1, p_1) \cdots \mapsto (e_n, P_n, T_n, p_n) = C_u$ and C_u is final. Looking at the rule of \mapsto and the definition of final contexts, $C_u \dashv$. Let us suppose that there is an exponential signature v such that $(\sigma(B), P, !_v, +) \mapsto (e_1, Q_1, U_1, p_1) \cdots (e_n, Q_n, U_n, p_n)$. The skeletons of $!_u$ and $!_v$ are equal, so the skeletons of T_1 and U_1 are equal (lemma 7). Thus, no matter in kind case of final contexts are we, $(e_n, Q_n, U_n, p_n) \dashv$. T_n has the shape $[!_e]@T'$ so U_n has the shape $[!_w]@U'$. Notice that $e \leq^w w$. So, according to lemma 9, $u \leq^w v$. We have $u \triangleleft v$.

Now, let us suppose that u is a copy simplification, then $(\sigma(B), P, !_u, +) \mapsto (e_1, P_1, T_1, p_1) \cdots \mapsto (e_n, P_n, T_n, p_n) \dashv$ and for all v such that $(\sigma(B), P, !_v, +) \mapsto (e_1, Q_1, U_1, p_1) \cdots (e_n, Q_n, U_n, p_n)$, $u \triangleleft v$ and $(e_n, Q_n, U_n, p_n) \dashv$. We will show that (e_n, P_n, T_n, p_n) is final. Let us consider the last \hookrightarrow step in the path, $(e_j = \sigma_i(C), P_j, !_w, -) \hookrightarrow (e_{j+1} = \sigma(C), P_{j+1}, !_w, +)$. $\beta_{\{\}}(\sigma(C), P_{j+1}, !_w, +)$ is defined so not empty, so $\beta_{\{\}}(e_n, P_n, T_n, p_n)$ is not empty. So, knowing that $(e_n, P_n, T_n, p_n) \dashv$ and that the leftmost trace element is a $!$ element, the only possibilities for (e_n, P_n, T_n, p_n) are that $((-, \bullet), R, T, +)$ or $(e, R, !_y, -)$ with the tail of e being a $?C$, $?D$, $?N$ or $?W$ link.

If it was a $?C$ or $?N$ then notice that $e \leq y$ so there exists $u' <^y u$ such that $(\sigma(B), P, !_{u'}, +) \mapsto \cdots (e, R', !_e, -)$ (lemma 8). Notice that $e \leq l(e)$ and $e \leq p(e)$ so, by lemma 8, there exists v such that $(\sigma(B), P, !_v, +) \mapsto (e_1, Q_1, U_1, p_1) \cdots (e_n, Q_n, U_n, p_n) \mapsto$ which would contradict your assumption.

So the only fact left to prove is that the leftmost trace element is $!_e$. If it is not, we can find a $v < u$ such that $(\sigma(B), P, !_v, +) \mapsto (e_1, Q_1, U_1, p_1) \cdots (e_n, Q_n, U_n, p_n)$ (lemma 8). \square

3.6 Proof of Dal Lago's weight theorem

Lemma 10. *If $\phi(\sigma(B), P, s) = (\sigma(B'), P', s')$, $P \in L_G(B)$ and $s \in C_G(B, P)$, then $P' \in L_H(B')$ and $s' \in C_H(B', P')$*

Proof. We prove this statement by induction on the \subseteq -depth of (B, P, s) .

- Let us suppose that for all C, Q, t such that $(B, P, s) \subseteq (C, Q, t)$ and $t \in C_G(Q, t)$, $\sigma(C) \notin D_\phi$.

We can prove that B' has depth 0 by contradiction : let us suppose $B' \subset C'$. Then $(B', P', s') \subseteq (C', Q', t')$ for some Q' and t' . By rule **2d**, there exists some C, Q, t such that $\phi(\sigma(C), Q, t) = (\sigma(C'), Q', t')$. By rule **2b**, $(B, P, s) \subseteq (C, Q, t)$. Which contradicts our assumption. So B' has depth 0 and $P' = []$. P' is canonical for B' .

Now, we suppose that $s \in C_G(B, P)$ so for all $t \in Sig$ such that $s \sqsubseteq t$, $(\sigma(B), P, !_t, +) \mapsto^* (e, R, [!_e]@T, p)$ with $(e, R, [!_e]@T, p)$ a final context. We must prove that $s' \in C_H(B', P')$. Thanks to rule **2f**, we already know that s' is standard. Let $t' \in Sig$ such that $s' \sqsubseteq t'$, we need to prove that $(\sigma(B'), P', !_{t'}, +) \mapsto^* C'_f$ with C'_f a final context.

By rule **2d**, there exists (C, Q, t) such that $\phi(\sigma(C), Q, t) = (\sigma(B'), P', t')$. We also know that $s' \sqsubseteq t'$ so $(B', P', s') \subseteq (B', P', t')$. Then, by rule **2b**, $(B, P, s) \subseteq (C, Q, t)$. Either $(B, P) = (C, Q)$ and $s \sqsubseteq t$ or $B \subset C$ and $P = Q.u@Q'$ with $t \sqsubseteq u$. In both cases, we will prove that there exists $C_f = (e, R, [!_e]@T, p) \in F_G$ such that $(\sigma(C), Q, [!_t], +) \mapsto^* C_f$.

- In the first case, $B = C$, $P = Q$ and $s \sqsubseteq t$. And $s \in C_G(B, P)$ so, by definition of $C_G(B, P)$, there exists $C_f = (e, R, [!_e]@T, p) \in F_G$ such that $(\sigma(C), Q, [!_t], +) \mapsto^* C_f$.
- If $B \subset C$ and $P = Q.t@Q'$. We know that $P \in L_G(B)$ so the signature composing it are copies of their respective corresponding boxes. So $t \in C_G(C, Q)$. There exists $C_f = (e, R, [!_e]@T, p)$ such that $(\sigma(C), Q, [!_t], +) \mapsto^* C_f$.

So, there exists $C_f = (e, R, [!_e]@T, p) \in F_G$ such that $(\sigma(C), Q, [!_t], +) \mapsto^* C_f$

- If $e \in D_\phi$. Then $\phi(e, R, e) = (e', R', u')$. By rule **2a**, $(\sigma(B'), P', !_{t'}, +) \mapsto (e', R', [!_{u'}]@T, p)$. And by rule **2e**, $(e', R', [!_{u'}]@T, p)$ is a final context for H.
- Else, by rule **3**, $(e, R, [!_e]@T, p) \in D_\psi$. There exists k such that $\forall (f, S, [!_u]@U, q) \in C_G, (f, S, [!_u]@U, q) \mapsto^k (e, R, [!_e]@T, p) \Leftrightarrow (f, S, [!_u]@U, q) \in \psi(e, R, [!_e]@T, p)$ (rule **3b**) and if $j \leq k$, then $(f, S, [!_u]@U, q) \mapsto^j (e, R, [!_e]@T, p) \Rightarrow f \notin \sigma(B_G)$. So there is $(f, S, [!_u]@U, q) \in \psi(e, R, [!_e]@T, p)$ such that $(\sigma(C), Q, !_t, +) \mapsto^+ (f, S, [!_u]@U, q) \mapsto^k (e, R, [!_e], p)$. According to rule **2e**, $\phi(f, S, u) = (f', S', u')$ and $(f', S', [!_{u'}]@U, q)$ is final. According to rule **2a**, $(\sigma(B'), P', !_{s'}, +) \mapsto^* (f', S', [!_{u'}]@U, q)$.

So $s' \in C_H(B', P')$.

- If $(B, P, s) \subseteq (C, Q, t)$ (with $\sigma(B) \in D_\phi$, $\sigma(C) \in D_\phi$, $P \in L_G(B)$, $Q \in L_G(B)$, $s \in C_G(B, P)$ and $t \in C_G(C, Q)$) and for all $D, R \in L_G(D)$, u such that $u \in C_G(D, R)$ and $(B, P, s) \subseteq (D, R, u) \subseteq (C, Q, t)$, $\sigma(D) \notin D_\phi$. Let $(\sigma(B'), P', s') = \phi(\sigma(B), P, s)$ and $(\sigma(C'), Q', t') = \phi(\sigma(C), Q, t)$. According to rule **2b**, $(B', P', s') \subseteq (C', Q', t')$.

- If $(B', P') = (C', Q')$ (and $s' \sqsubseteq t'$). $P \in L_G(B)$, so by definition of canonical contexts $Q \in L_G(C)$ is canonical for C . By induction hypothesis, Q' is canonical for C' , so P' is canonical for B' .
- Else, $P' = Q'.t'@R'$. In fact, we show by contradiction that $|R'| = 0$ and t' is standard : else there exists $D' \in B_H$, S' and u' such that $(B', P', s') \subseteq (D', S', u') \subseteq (C', Q', t')$. By rule **2d**, there exists some D, S, u such that $\phi(\sigma(D), S, u) = (\sigma(D'), S', u')$. By rule **2b**, $(\sigma(B), P, s) \subseteq (\sigma(D), S, u) \subseteq (C, Q, t)$ and $\sigma(D)$ is in the domain of ϕ so in D_ϕ . Which contradicts our assumption. So $|R'| = 0$ and t' is standard. P is canonical for B , so Q is canonical for C . By induction hypothesis, Q' is canonical for C' .

$(B, P, s) \subseteq (C, Q, t)$ and t is standard. So $B \subset C$ and $P = Q.t@R$. By induction hypothesis, $t' \in C_H(C', Q')$. So $P' = Q'.t'$ is canonical for B' .

The proof of s' being in $C_H(B', P')$ is exactly the same as for the base case. □

Corollary 1. *If $\phi(e, P, s) = (e', P', s')$ and $P \in L_G(e)$, then $P' \in L_H(e')$*

Proof. Let us suppose that $\phi(e, P, s) = (e', P', s')$ and $P \in L_G(e)$. Then,

- If $P = []$ then $P' = []$ (by contradiction)
- Else, let B the deepest box including e such that $\sigma(B) \in D_\phi$. Then we have $Q.t@R = P$ with $Q \in L_G(B)$ and $t \in C_G(B, Q)$. According to the previous lemma, $\phi(\sigma(B), Q, t) = (\sigma(B'), Q', t')$ with $Q' \in L_H(B')$ and $t' \in C_H(B', Q')$. According to rule **2c**, $\rho(e') = B'$ and $P' = Q'.t'$ so P' is canonical for e' .

□

Lemma 11. *If $B' \in B_H$, $P' \in L_H(B')$ and t' is a copy simplification of (B', P') then there exists B, P and t such that $\phi(\sigma(B), P, t) = (\sigma(B'), P', t')$, $P \in L_G(B)$ and t is a copy simplification of (B, P) .*

Proof. • If $P' = []$, then there exists B, Q and t such that $\phi(\sigma(B), Q, t) = (\sigma(B'), [], t')$. None of the principal doors of boxes containing B are in D_ϕ (else rule **2b** gives us a box $(C', Q', u') \supseteq (B', [], t')$ with u' standard which is impossible) so rule **2c** says that for all P , $\phi(\sigma(B), P, t) = (\sigma(B'), [], t')$. We choose a $P \in L_G(\sigma(B))$ (we can prove it exists thanks to rule **2g**).

t' is a copy simplification of (B', P') so $(\sigma(B'), P', !_\nu, +) \mapsto^* (e', Q', [!_e]@T, b)$ with $(e', Q', [!_e]@T, b) \in F_H$. So, according to rule **2e**, either there exists e, Q, u such that $(e, Q, [!_u]@T, b) \in F_G$ and $\phi(e, Q, u) = (e', Q', e)$ or there exists e, Q, u and $(f, R, [!_v]@U, c) \in F_G$ such that $(e, Q, [!_u]@T, b) \in \psi(f, R, [!_v]@U, c)$ and $\phi(e, Q, u) = (e', Q', e)$. We examine both cases.

- If we suppose that there exists e, Q, u such that $(e, Q, [!_u]@T, b) \in F_G$ and $\phi(e, Q, u) = (e', Q', e)$. So, according to rule **2a**, $(\sigma(B), P, !_t, +) \mapsto^* (e, Q, [!_u]@T, b)$ and $(e, Q, [!_u]@T, b) \in F_G$ so t is a copy simplification of (B, P) .
- If we suppose that there exists e, Q, u and $(f, R, [!_v]@U, c) \in F_G$ such that $(e, Q, [!_u]@T, b) = \psi(f, R, [!_v]@U, c)$ and $\phi(e, Q, u) = (e', Q', e)$. According to rule **2a**, $(\sigma(B), P, !_s, t) \mapsto^* (e, Q, [!_u]@T, b)$. According to rule **3b**, $(e, Q, [!_u]@T, b) \mapsto^* (f, R, [!_v]@U, c)$ and $(f, R, [!_v]@U, c)$ is final. By transitivity $(\sigma(B), P, !_t, +) \mapsto^* (f, R, [!_v]@U, c)$ so t is a copy simplification of (B, P) .

- Else, let C' be the deepest box containing B' , $P' = Q'.u'$ with $Q' \in L_H(C')$ and $u' \in C_H(C', Q')$. Notice that $(\sigma(B'), P', t') \subseteq (\sigma(C'), Q', u')$. Then, by induction hypothesis, there exists $C \in B_G$, $Q \in L_G(C)$ and u simplification copy of (C, Q) such that $\phi(\sigma(C), Q, u) = (\sigma(C'), Q', u')$. According to rule **2d**, there exists B, R, t such that $\phi(\sigma(B), R, t) = (\sigma(B'), P', t')$. According to rule **2b**, $(\sigma(B), R, t) \subseteq (\sigma(C), Q, u)$. Either $B = C$ and $R = Q$ (so R is canonical for B) or $B \subset C$, $R = Q.v@R'$, $v \sqsubseteq u$ and none of the principal doors of the intermediary boxes are in D_ϕ . We will show that $u = v$ and u is a \mapsto copy of (C, Q) . Then, thanks to rule **2g**, we can extend $Q.u$ in a canonical potential $P = Q.u@P'$ for B . Then, according to rule **2c**, $\psi(\sigma(B), P, s) = (\sigma(B'), P', s')$.

So we need to prove that $u = v$, and that for all $u \sqsubseteq w$, w is a \mapsto -copy simplification of (C, Q) . If $u \neq v$, $v \sqsubset u$. Let $(\sigma(D'), S', v') = \phi(\sigma(C), Q, v)$. We know that $(\sigma(B), R, t) \subseteq (\sigma(C), Q, v) \subseteq (\sigma(C), Q, u)$ so $(\sigma(B'), Q'.u', t') \subseteq (\sigma(D'), S', v') \subseteq (\sigma(C'), Q', u')$. C' is the deepest box containing B' and u' is standard so $D' = B'$ and $t' \sqsubset v'$. However v is standard so, by rule **2f**, v' is standard. We have a contradiction, so our supposition was false, $u = v$.

Let us consider an exponential signature w such that $u \sqsubseteq w$. Let $(\sigma(D'), S', w') = \phi(\sigma(C), Q, w)$. Then $(\sigma(C'), Q', u') \subseteq (\sigma(D'), S', w')$ either $D' = C'$ and $u \sqsubseteq w$ or C' is included in D' . In either case, w' is a copy simplification for (D', S') . Using exactly the technique to show that t' is a copy simplification of (B, P) , we have that w is a copy simplification of (C, Q) .

Proving that s is a copy simplification of (B, P) is exactly the same as in the base case of the induction. □

Lemma 12. *If $e' \in D'_\phi$, $P' \in L_H(e')$, $s' \in Sig$ then there exists $e \in E_G$, $P \in L_G(e)$ and $s \in Sig$ such that $\phi(e, P, s) = (e', P', s')$.*

Proof. $e' \in D'_\phi$, so there exists $e \in E_G$, $P_0 \in Pot$ and $s \in Sig$ such that $\phi(e, P_0, s) = (e', P', s')$.

- If $\partial(e') > 0$, let B be the deepest box containing e . Then, $P = Q.t@R$ with $Q \in L_G(B)$ and $t \in C_G(B, Q)$. Let $(\sigma(B'), Q', t') = \phi(\sigma(B), Q, t)$. Then, according to rule **2c**, $\rho(e') = B'$ and $P' = Q'.t'$.
If $P' \in L_H(e')$, then $Q' \in L_H(B')$ and $t' \in C_H(B', Q')$. According to the preceding lemma, $Q \in L_G(B)$ and $t \in C_G(B, Q)$. We can complete $Q@t$ in a canonical potential P . According to rule **2c**, $\phi(e, P, s) = (e', P', s')$.
- If $\partial(e') = 0$ so none of the principal doors of boxes containing e are in D_ϕ . We can replace P_0 with any canonical potential P for e . Rule **2c** ensures that $\phi(e, P, s) = (e', P', s')$.

□

Let us suppose that there exists a copymorphism between two proof-nets G and H . If we compute the differences of weights between G and H ($W_G - W_H$ and $T_G - T_H$), there are many simplifications. So, the differences depends mostly on the edges of G (resp H) which are not in D_ϕ (resp D'_ϕ). In the cut reduction rules, most of the edges are in D_ϕ or D'_ϕ , so we have only a few edges to consider to compute those differences.

We will separate the weight T_G into two subweights $T_G^1 = \sum_{e \in E_G} |L_{\mapsto}(e)|$ and $T_G^2 = 2 \sum_{\substack{e \in P_G \\ P \in L_{\mapsto}(e) \\ t \in S_{\mapsto}(e, P)}} D_G(e) \cdot |t|$.

$$\begin{aligned}
T_G^1 - T_H^1 &= \sum_{e \in E_G} |L_{\mapsto}(e)| - \sum_{e \in E_H} |L_{\mapsto}(e)| \\
&= \sum_{\substack{e \in E_G \cap D_\phi \\ P \in L_G(e)}} 1 + \sum_{e \in E_G \cap \overline{D_\phi}} |L_G(e)| - \sum_{\substack{f \in E_H \cap D'_\phi \\ Q \in L_H(f)}} 1 - \sum_{f \in E_H \cap \overline{D'_\phi}} |L_H(f)| \\
&= \sum_{\substack{e \in E_G \cap D_\phi \\ P \in L_G(e)}} 1 - \sum_{\substack{f \in E_H \cap D'_\phi \\ Q \in L_H(f)}} |\{(e, P, t)/\phi(e, P, t) = (f, Q, e)\}| + \sum_{e \in E_G \cap \overline{D_\phi}} |L_G(e)| - \sum_{f \in E_H \cap \overline{D'_\phi}} |L_H(f)| \\
&= \sum_{\substack{e \in E_G \cap D_\phi \\ P \in L_G(e)}} 1 - \sum_{\substack{e \in E_G \cap D_\phi \\ P \in L_G(e)}} |\{t/\phi(e, P, t) = (-, -, e)\}| + \sum_{e \in E_G \cap \overline{D_\phi}} |L_G(e)| - \sum_{f \in E_H \cap \overline{D'_\phi}} |L_H(f)| \\
T_G^1 - T_H^1 &= \sum_{\substack{e \in E_G \cap D_\phi \\ P \in L_G(e)}} 1 - |\{t/\phi(e, P, t) = (-, -, e)\}| + \sum_{e \in E_G \cap \overline{D_\phi}} |L_G(e)| - \sum_{f \in E_H \cap \overline{D'_\phi}} |L_G(e)|
\end{aligned}$$

The formula of the last line may seem more complex than the first line. However, when we will use this formula, we will notice that most potential edges of G will have exactly one image in $Pot(E_H)$. So, we will immediately notice that most of the terms of the sum are equal to 0.

$$\begin{aligned}
T_G^2 - T_H^2 &= 2 \left(\sum_{\substack{e \in P_G \\ P \in L_G(e) \\ s \in S_G(e, P)}} D_G(e) \cdot |s| - \sum_{\substack{f \in P_H \\ Q \in L_H(f) \\ t \in S_H(f, Q)}} D_H(f) \cdot |t| \right) \\
&= 2 \left(\sum_{\substack{e \in P_G \cap D_\phi \\ P \in L_G(e) \\ s \in S_G(e, P) \\ (f, Q, t) = \phi(e, P, s)}} D_G(e) \cdot |s| - D_H(f) \cdot |t| + \sum_{\substack{e \in P_G \cap \overline{D_\phi} \\ P \in L_G(e) \\ s \in S_G(e, P)}} D_G(e) \cdot |s| \right)
\end{aligned}$$

Theorem 2 (Dal Lago's weight theorem). *Suppose that $G \rightarrow H$ then $T_G > T_H$*

Proof. We will examine every rule of reduction. For each rule, we will exhibit a copymorphism to prove the inequalities. We will only present the non trivial images. On the drawings, the edges of G (resp. H) which are not in D_ϕ (resp. D'_ϕ) will be drawn dashed. The edges of D_ϕ which have different images by ϕ in E_H depending on the associated potential and signature, will be drawn thicker.

For W_G and W_H , the result is immediate as long as there exists a copymorphism. $W_G - W_H = \sum_{\substack{e \in P_G \cap \overline{D_\phi} \\ P \in L_G(e)}} |S_{\rightarrow}(e, P)|$ and this sum is always positive.

•



$$T_G^1 - T_H^1 = \sum_{\substack{e \in E_G \cap D_\phi \\ P \in L_G(e)}} 1 - |\{t/\phi(e, P, t) = (-, -, e)\}| + \sum_{e \in E_G \cap \overline{D_\phi}} |L_G(e)| - \sum_{f \in E_H \cap \overline{D'_\phi}} |L_H(e)|$$

$$T_G^1 - T_H^1 = \sum_{\substack{e \in E_G \cap D_\phi \\ P \in L_G(e)}} (1 - 1) + \sum_{e \in \{c, d\}} |L_G(e)| - \sum_{f \in \emptyset} |L_H(e)|$$

$$T_G^1 - T_H^1 = |L_G(c)| + |L_G(d)|$$

$$T_G^2 - T_H^2 = 2 \left(\sum_{\substack{e \in P_G \cap D_\phi \\ P \in L_G(e) \\ s \in S_G(e, P) \\ (f, Q, t) = \phi(e, P, s)}} D_G(e).|s| - D_H(f).|t| + \sum_{\substack{e \in P_G \cap \overline{D_\phi} \\ P \in L_G(e) \\ s \in S_G(e, P)}} D_G(e).|s| \right)$$

$$T_G^2 - T_H^2 = 2 \left(\sum_{\substack{e \in P_G \cap D_\phi \\ P \in L_G(e) \\ s \in S_G(e, P) \\ (f, Q, t) = \phi(e, P, s)}} 0 + \sum_{\substack{e \in \emptyset \\ P \in L_G(e) \\ s \in S_G(e, P)}} D_G(e).|s| \right)$$

$$T_G^2 - T_H^2 = 0$$

So $T_G > T_H$.

•

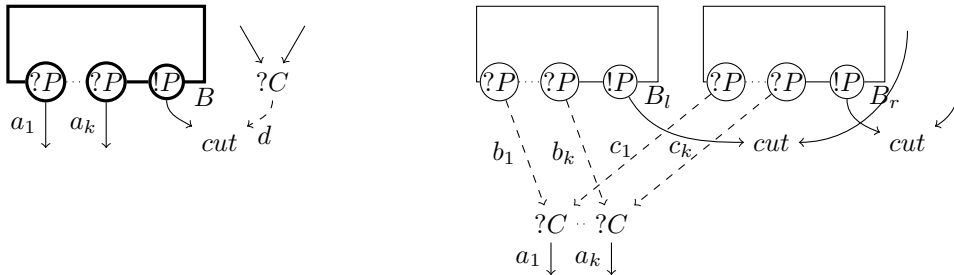

The only particular case is for $\sigma(B)$. We set : $\phi(\sigma(B), P, l(s)) = (\sigma(B_l), P, s)$ and $\phi(\sigma(B), P, r(s)) = (\sigma(B_r), P, s)$.

$$T_G^1 - T_H^1 = \sum_{\substack{e \in E_G \cap D_\phi \\ P \in L_G(e)}} 1 - |\{t/\phi(e, P, t) = (-, -, e)\}| + \sum_{e \in E_G \cap \overline{D_\phi}} |L_G(e)| - \sum_{f \in E_H \cap \overline{D_\phi}} |L_H(e)|$$

$$T_G^1 - T_H^1 = \sum_{P \in L_G(\sigma(B))} 1 - 2 + |L_G(d)| - \sum_{i=0}^{i \leq k} |L_H(b_i)| - \sum_{i=0}^{i \leq k} |L_H(c_i)|$$

$$T_G^1 - T_H^1 = -|L_G(\sigma(B))| + |L_G(\sigma(B))| - 2 * k |L_G(\sigma(B))|$$

$$T_G^1 - T_H^1 = -2 * k |L_G(\sigma(B))|$$

$$T_G^2 - T_H^2 = 2 \left(\sum_{\substack{e \in P_G \cap D_\phi \\ P \in L_G(e) \\ s \in S_G(e, P) \\ (f, Q, t) = \phi(e, P, s)}} D_G(e) \cdot |s| - D_H(f) \cdot |t| + \sum_{\substack{e \in P_G \cap \overline{D_\phi} \\ P \in L_G(e) \\ s \in S_G(e, P)}} D_G(e) \cdot |s| \right)$$

$$T_G^2 - T_H^2 = 2 \left(\sum_{\substack{P \in L_G(\sigma(B)) \\ s \in S_G(\sigma(B), P) \\ (f, Q, t) = \phi(\sigma(B), P, s)}} (k+1) \cdot |s| - (k+1) \cdot (|s| - 1) + \sum_{\substack{e \in \emptyset \\ P \in L_G(e) \\ s \in S_G(e, P)}} D_G(e) \cdot |s| \right)$$

$$T_G^2 - T_H^2 = 2 \left(\sum_{\substack{P \in L_G(\sigma(B)) \\ s \in S_G(\sigma(B), P)}} (k+1) + 0 \right)$$

$$T_G^2 - T_H^2 = 2(k+1) \left(\sum_{P \in L_G(\sigma(B))} |S_G(\sigma(B), P)| \right)$$

$$T_G - T_H = -2 * k |L_G(\sigma(B))| + 2(k+1) \left(\sum_{P \in L_G(\sigma(B))} |S_G(\sigma(B), P)| \right)$$

$$T_G - T_H \geq -2 * k |L_G(\sigma(B))| + 2(k+1) \left(\sum_{P \in L_G(\sigma(B))} 1 \right)$$

$$T_G - T_H \geq 2 |L_G(\sigma(B))| > 0$$

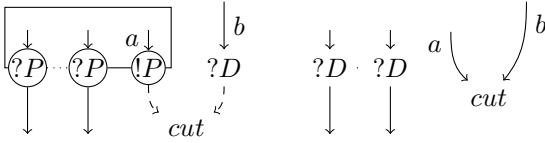

$$T_G^1 - T_H^1 = \sum_{\substack{e \in E_G \cap D_\phi \\ P \in L_G(e)}} 1 - |\{t/\phi(e, P, t) = (-, -, e)\}| + \sum_{e \in E_G \cap \overline{D_\phi}} |L_G(e)| - \sum_{f \in E_H \cap \overline{D_\phi}} |L_H(e)|$$

$$T_G^1 - T_H^1 = \sum_{\substack{e \in E_G \cap D_\phi \\ P \in L_G(e)}} (1 - 1) + 2 * |L_G(\sigma(B))| - 0$$

$$T_G^1 - T_H^1 = 2 |L_G(\sigma(B))|$$

$$T_G^2 - T_H^2 = 2 \left(\sum_{\substack{e \in P_G \cap D_\phi \\ P \in L_G(e) \\ s \in S_G(e,P) \\ (f,Q,t) = \phi(e,P,s)}} D_G(e).|s| - D_H(f).|t| + \sum_{\substack{e \in P_G \cap \overline{D_\phi} \\ P \in L_G(e) \\ s \in S_G(e,P)}} D_G(e).|s| \right)$$

$$T_G^2 - T_H^2 = 2 \left(\sum_{\substack{e \in P_G \cap D_\phi \\ P \in L_G(e) \\ s \in S_G(e,P) \\ (f,Q,t) = \phi(e,P,s)}} 0 + \sum_{\substack{P \in L_G(\sigma(B)) \\ s \in S_G(\sigma(B),P)}} D_G(\sigma(B)).|s| \right)$$

$$T_G^2 - T_H^2 = 2 \sum_{\substack{P \in L_G(\sigma(B)) \\ s \in S_G(\sigma(B),P)}} D_G(\sigma(B)).|s|$$

$$T_G - T_H = 2|L_G(\sigma(B))| + 2 \sum_{\substack{P \in L_G(\sigma(B)) \\ s \in S_G(\sigma(B),P)}} D_G(\sigma(B)).|s|$$

$$T_G - T_H > 0$$

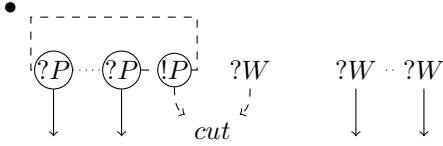

$$T_G^1 - T_H^1 = \sum_{\substack{e \in E_G \cap D_\phi \\ P \in L_G(e)}} 1 - |\{t/\phi(e,P,t) = (-, -, e)\}| + \sum_{e \in E_G \cap \overline{D_\phi}} |L_G(e)| - \sum_{f \in E_H \cap \overline{D'_\phi}} |L_H(e)|$$

$$T_G^1 - T_H^1 = \sum_{\substack{e \in E_G \cap D_\phi \\ P \in L_G(e)}} (1 - 1) + \sum_{e \in E_G \cap \overline{D_\phi}} |L_G(e)| - \sum_{f \in \emptyset} |L_H(e)|$$

$$T_G^1 - T_H^1 > 0$$

$$T_G^2 - T_H^2 = 2 \left(\sum_{\substack{e \in P_G \cap D_\phi \\ P \in L_G(e) \\ s \in S_G(e,P) \\ (f,Q,t) = \phi(e,P,s)}} D_G(e).|s| - D_H(f).|t| + \sum_{\substack{e \in P_G \cap \overline{D_\phi} \\ P \in L_G(e) \\ s \in S_G(e,P)}} D_G(e).|s| \right)$$

$$T_G^2 - T_H^2 = 2 \left(\sum_{\substack{e \in P_G \cap D_\phi \\ P \in L_G(e) \\ s \in S_G(e,P) \\ (f,Q,t) = \phi(e,P,s)}} D_G(e).|s| - D_G(e).|t| + \sum_{\substack{P \in L_G(\sigma(B)) \\ s \in S_G(\sigma(B),P)}} D_G(\sigma(B)).|s| \right)$$

$$T_G^2 - T_H^2 = 2 \left(0 + \sum_{\substack{P \in L_G(\sigma(B)) \\ s \in S_G(\sigma(B),P)}} D_G(\sigma(B)).|s| \right) T_G^2 - T_H^2 > 0$$

Donc $T_G > T_H$

•



$$T_G^1 - T_H^1 = \sum_{\substack{e \in E_G \cap D_\phi \\ P \in L_G(e)}} 1 - |\{t/\phi(e, P, t) = (-, -, e)\}| + \sum_{e \in E_G \cap \overline{D_\phi}} |L_G(e)| - \sum_{f \in E_H \cap \overline{D'_\phi}} |L_H(e)|$$

$$T_G^1 - T_H^1 = \sum_{\substack{e \in E_G \cap D_\phi \\ P \in L_G(e)}} (1 - 1) + \sum_{e \in E_G \cap \overline{D_\phi}} |L_G(e)| - \sum_{f \in \emptyset \cap \overline{D'_\phi}} |L_H(e)|$$

$$T_G^1 - T_H^1 = 0 + |L_G(a)| + |L_G(b)| - 0$$

$$T_G^1 - T_H^1 > 0$$

$$T_G^2 - T_H^2 = 2 \left(\sum_{\substack{e \in P_G \cap D_\phi \\ P \in L_G(e) \\ s \in S_G(e, P) \\ (f, Q, t) = \phi(e, P, s)}} D_G(e).|s| - D_H(f).|t| + \sum_{\substack{e \in P_G \cap \overline{D_\phi} \\ P \in L_G(e) \\ s \in S_G(e, P)}} D_G(e).|s| \right)$$

$$T_G^2 - T_H^2 = 2 \left(\sum_{\substack{e \in P_G \cap D_\phi \\ P \in L_G(e) \\ s \in S_G(e, P) \\ (f, Q, t) = \phi(e, P, s)}} 0 + \sum_{\substack{e \in \emptyset \\ P \in L_G(e) \\ s \in S_G(e, P)}} D_G(e).|s| \right)$$

$$T_G^2 - T_H^2 = 2(0 + 0) = 0$$

So $T_G > T_H$. The quantifier case is exactly the same, so we will not present it.

•

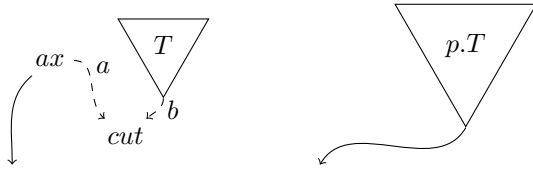

$$T_G^1 - T_H^1 = \sum_{\substack{e \in E_G \cap D_\phi \\ P \in L_G(e)}} 1 - |\{t/\phi(e, P, t) = (-, -, e)\}| + \sum_{e \in E_G \cap \overline{D_\phi}} |L_G(e)| - \sum_{f \in E_H \cap \overline{D'_\phi}} |L_H(e)|$$

$$T_G^1 - T_H^1 = \sum_{\substack{e \in E_G \cap D_\phi \\ P \in L_G(e)}} (1 - 1) + |L_G(a)| + |L_G(b)| T_G^1 - T_H^1 > 0$$

$$\begin{aligned}
T_G^2 - T_H^2 &= 2\left(\sum_{\substack{e \in P_G \cap D_\phi \\ P \in L_G(e) \\ s \in S_G(e, P) \\ (f, Q, t) = \phi(e, P, s)}} D_G(e).|s| - D_H(f).|t| + \sum_{\substack{e \in P_G \cap \overline{D}_\phi \\ P \in L_G(e) \\ s \in S_G(e, P)}} D_G(e).|s| \right) \\
T_G^2 - T_H^2 &= 2\left(\sum_{\substack{e \in P_G \cap D_\phi \\ P \in L_G(e) \\ s \in S_G(e, P) \\ (f, Q, t) = \phi(e, P, s)}} 0 + \sum_{\substack{e \in \emptyset \\ P \in L_G(e) \\ s \in S_G(e, P)}} D_G(e).|s| \right) \\
T_G^2 - T_H^2 &= 2(0 + 0) = 0
\end{aligned}$$

So $T_G > T_H$.

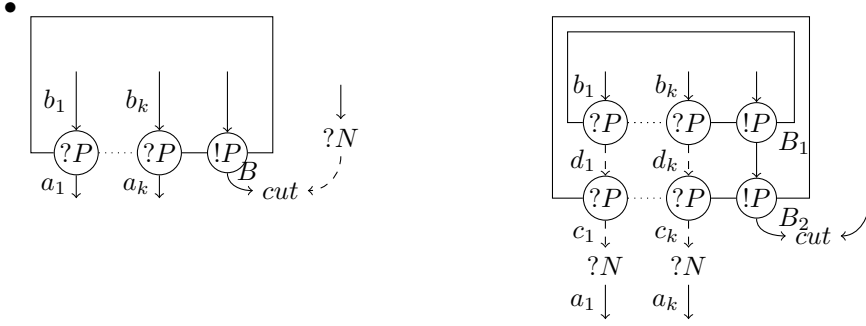

$$\phi(\sigma(B), P, n(t_1, t_2)) = (\sigma(B_1), P, t_2, t_1), \phi(\sigma(B), P, p(t)) = (\sigma(B_2), P, t).$$

$$T_G^1 - T_H^1 = \sum_{\substack{e \in E_G \cap D_\phi \\ P \in L_G(e)}} 1 - |\{t/\phi(e, P, t) = (_, _, e)\}| + \sum_{e \in E_G \cap \overline{D}_\phi} |L_G(e)| - \sum_{f \in E_H \cap \overline{D}'_\phi} |L_H(e)|$$

$$T_G^1 - T_H^1 = 0 - |L_G(\sigma(B))| + 0 - \sum_{i=1}^k |L_H(c_i)| - \sum_{i=1}^k |L_H(d_i)|$$

$$T_G^1 - T_H^1 = |L_G(\sigma(B))| - |L_H(\sigma(B_2))|.k - |L_H(\sigma(B_1))|.k$$

$$\begin{aligned}
T_G^2 - T_H^2 &= 2\left(\sum_{\substack{e \in P_G \cap D_\phi \\ P \in L_G(e) \\ s \in S_G(e, P) \\ (f, Q, t) = \phi(e, P, s)}} D_G(e).|s| - D_H(f).|t| + \sum_{\substack{e \in P_G \cap \overline{D_\phi} \\ P \in L_G(e) \\ s \in S_G(e, P)}} D_G(e).|s| \right) \\
T_G^2 - T_H^2 &= 2\left(\sum_{\substack{P \in L_G(\sigma(B)) \\ n(t_1, t_2) \in S_G(e, P)}} (k+1).(|t_1| + |t_2| + 1) - (k+1).|t_1| + \sum_{\substack{P \in L_G(\sigma(B)) \\ p(t) \in S_G(e, P)}} (k+1).(|t| + 1) - (k+1).|t| \right) \\
T_G^2 - T_H^2 &= 2\left(\sum_{\substack{P \in L_G(\sigma(B)) \\ n(t_1, t_2) \in S_G(e, P)}} (k+1).(|t_2| + 1) + \sum_{\substack{P \in L_H(\sigma(B_2)) \\ t \in S_H(\sigma(B_2), P)}} (k+1) \right) \\
T_G^2 - T_H^2 &\geq 2(|L_G(\sigma(B))|. (k+1).2 + \sum_{P, t \in L_H(\sigma(B_1))} (k+1)) \\
T_G^2 - T_H^2 &\geq 2(|L_H(\sigma(B_2))|. (k+1).2 + |L_H(\sigma(B_1))|. (k+1))
\end{aligned}$$

$$\begin{aligned}
T_G - T_H &\geq |L_G(\sigma(B))| - |L_H(\sigma(B_2))|.k - |L_H(\sigma(B_1))|.k + 2(|L_H(\sigma(B_2))|. (k+1).2 + |L_H(\sigma(B_1))|. (k+1)) \\
&T_G - T_H \geq |L_G(\sigma(B))| > 0
\end{aligned}$$

So $T_G > T_H$

□

Corollary 2. *If G is a proof-net, then the length of any path of reduction is bounded by T_G*

Proof. Suppose G is a proof-net and $G \mapsto G_1 \mapsto \dots \mapsto G_n$. Then, G_n is a proof-net (stability of proof nets modulo with respect to cut-reduction). Proof-net are strongly normalizing, so $G_n \mapsto G_{n+1} \mapsto \dots \mapsto G_{n'}$. According to the previous lemma, $T_G > T_{G_1} > \dots > T_{G_n} > \dots T_{G_{n'}} \geq 0$. So $n < T_G$. □

In [19], the acyclicity of proof nets is proved along with the decrease of T_G . Here, we chose to separate the two results because the acyclicity needs to define another relation. We define \Rightarrow_{cut} on proof-nets, which is the \rightarrow relation, where the $?W$ rewriting steps are allowed only if all the cuts of the nets are $?W/!P$ cuts.

Lemma 13. *If all the cuts of G are $?W/!P$ cuts, then G is acyclic*

Proof. Let us suppose that $(e, P, !_t, p) \mapsto^+ (e, P, !_u, p)$. By construction of proof-nets, there must be at least a change of direction to go back to the same edge. We return with the same direction. So there must have been at least two changes of direction. The $+$ to $-$ change has been done by crossing a cut, $(f, Q, T, +) \mapsto (g, Q, T, -)$. So either we go from a conclusion of a $!P$ link to a conclusion of a $?W$ link (in this case, the path can not continue so $(g, Q, T, -) = (e, P, !_u, p)$, but it is impossible because $(g, Q, !_t, -) \mapsto$) or we go from a conclusion of a $?W$ to a conclusion of a principal door (in this case this is the first step, so $(f, Q, T, +) = (e, P, !_t, p)$, but it is impossible because $\mapsto (f, Q, !_u, +)$). We have a contradiction, so there are no such cycle, G is acyclic. □

Lemma 14. *All proof-nets are acyclic*

Proof. Let G be a proof-net then, linear logic being strongly normalizing, there exists a sequence $G \Rightarrow G_1 \Rightarrow G_2 \Rightarrow \dots \Rightarrow G_n$. By lemma 13, G_n is acyclic. We now have to show that if $G \Rightarrow H$ and H is acyclic, then G is acyclic. If it is a $?W$ reduction, then the only cuts of G are $?W/!P$ cuts, so G is acyclic. Else, if G has a cycle, then it must be on an edge e which is not in the D_ϕ of the copymorphism associated to this cut elimination step or such that $\phi(e, P, t)$ depends on t , otherwise by rule 2a of the copymorphism definition,

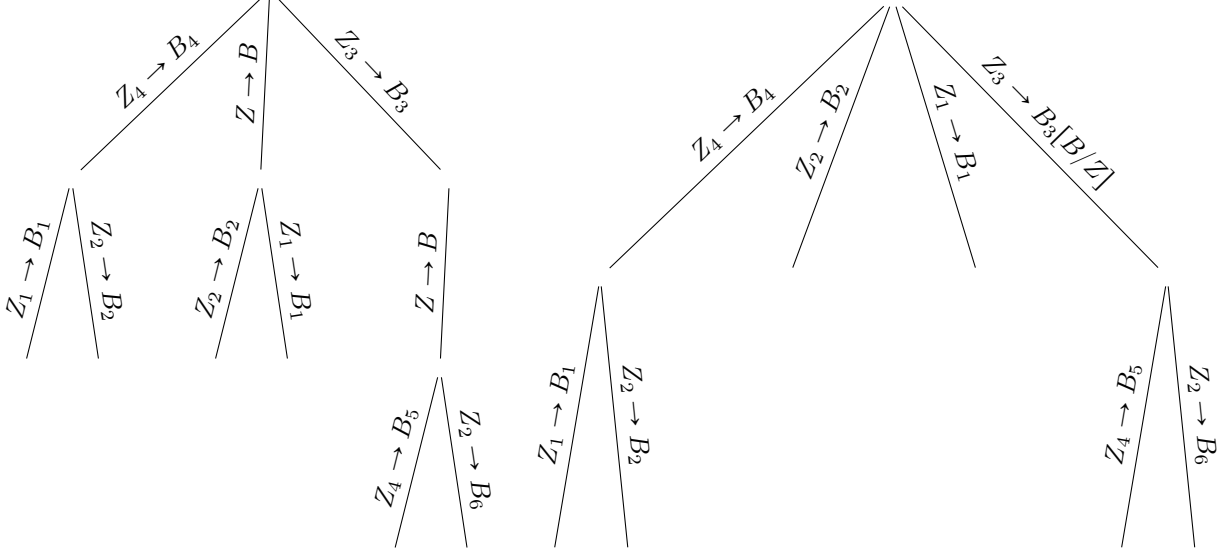

Figure 16: In case of a cut between the \forall link associated to the eigenvariable Z and a \exists link whose associated formula is B , we transform the left tree into the right tree

there would be a cycle in H . Almost all edges e which are not in D_ϕ are ruled out because $(e, P, !_t, p) \vdash^2$. The only remaining possible edges are : the premises of the cut in a $?C$ sep (but it would mean one of the premises of the $?C$ link is also part of a cycle which is impossible), the premises of the cut in an ax rule (but it would mean the other conclusion of the axiom is also part of a cycle which is impossible) or one of the premises of the cut in a $?N$ rule (but it would mean the premise of the $?N$ link is also part of a cycle which is impossible). \square

3.7 The z trees are finite

In subsection 3.5.2, we defined z trees of a potential edge as (potentially infinite) trees of substitutions. It allowed us to prove that the last contexts of paths corresponding to simplifications of copies are final contexts. Here, we will prove that those z trees are, in fact, always finite. It will allow us to define the formula associated to a context, as opposed to the set $\bigcup_{\Theta \prec ztree(C)} \beta_{\{\}, \Theta}(C)$ of formulae associated to the context. To define this formula, each time we are asked (in the definition of the previous set) to choose a truncation of a z tree, we will directly use the z tree (it is a finite truncation because the z trees will be proved to be finite).

Lemma 15. *If $G \rightarrow_{cut} H$, let $(D_\phi, D'_\phi, \phi, psi)$ be the copymorphism from G to H chosen in the proof of theorem 2 and $(e, P) \in Pot(D_\phi)$, $t \in Sig$ and $(e', P', t') = \phi(e, P, t)$.*

If $ztree(e', P')$ is finite, then $ztree(e, P)$ is finite.

Proof. We will only prove the statement in the case of a \exists/\forall cut elimination. All the other cases are simpler. Let Z be the eigenvariable corresponding to the reduced \forall link and B be the formula corresponding to the reduced \exists link. We prove by coinduction that, when $\phi(e, P, t) = (e', P', t')$, $ztree(e', P')$ is bisimilar to the tree obtained from $ztree(e, P)$ by contracting the branches whose label is a substitution on Z (as shown in figure 16).

Let $[p_0; \dots; p_{\partial(e)-1}]$ and E be the subset of the free eigenvariables of $\beta(e)$ whose associated \forall link has a corresponding \exists link : $E = \{Z_i \mid \exists g_i, R_i, (f_i, [p_0; \dots; p_{\partial(f_i)-1}], \forall, +) \mapsto^* (g_i, R_i, \forall, -)$ with g_i the conclusion of a \exists link $l_i\}$

with f_i the \forall link associated to eigenvariable Z_i . Then, by definition, $ztree(e, P, [!_i]@T, p) = \{(Z_i, B_i, ztree(h_i, R))/Z_i \in E\}$ with h_i the premise of the \exists link corresponding to $Z_i \in E$ and B_i the formula associated to this \exists link.

Let $Z_i \in E$,

- If $Z_i \neq Z$, then Z_i is a free variable of $\beta_H(e')$. The conclusion (c, S) of the \forall link associated to Z_i in G is in D_ϕ . Let $(c', S', e) = \phi(c, S, e)$, according to the definition of this copymorphism in the proof of ?? the tail of c' is the \forall link whose associated eigenvariable is Z_i . We also know that $(g_i, R_i, e) \in D_\phi$. So if we define $(g'_i, R'_i, u') = \phi(g_i, R_i, e)$, we have $(c', S', \forall, +) \rightsquigarrow^* (g'_i, R'_i, t')$. The tail of g'_i is an \exists link whose associated formula is B . So $(Z_i, B, ztree(g'_i, R'_i)) \in ztree(e', P')$. If we suppose $ztree(g'_i, R'_i)$ to be bisimilar to the substitution tree obtained from $ztree(g_i, R_i)$ by contracting the branches whose label is a substitution on Z .
- if $Z_i = Z$ then $Z_i \notin FV(\beta(e'))$, however Z being replaced by B in the whole net, all free eigenvariables of B are free variables of $\beta(e')$. By construction of the proof-nets, Z can not be a free eigenvariable of B . So we can use the arguments of the first case to prove the result we want.

If $ztree(e, P)$ is infinite, then there is an infinite branch path. The corresponding branch path in $ztree(e', P')$ is also infinite because at most one over two branch is contracted. \square

Definition 11. We define $\beta(e, P, T, p)$ as the element of $\beta_{\{\cdot, ztree(e, P)\}}(e, P, T, p)$ where, whenever we have to choose a truncation of a $ztree(f, Q)$, we choose $ztree(f, Q)$ itself.

Theorem 3. If $(e, P, [s], +) \rightsquigarrow^* (f, Q, U, q)$ (with s a trace element corresponding to the first connector of e), such that $(1 + l(e)) \cdot \beta_{ztree(e, P)}(e, P, [s], +) = (|U|_{!,?,\S} + l(f)) \cdot \beta_{ztree(f, Q)}(f, Q, U, q)$

Proof. In the induction proof, we observe that for the base case we can choose any truncation of $ztree(e, P)$ we want. So, in particular, we can choose $ztree(e, P)$ itself. The induction steps always extend the truncation, they never restrain it. \square

4 Stratification

4.1 History and motivations

A stratification designs a restriction of a framework, which forbids the contraction (or identification) of two objects belonging to two morally different “strata”. The notorious Russell’s paradox in naive set theory relies on the identification of two formulae which belong morally to different strata. The non-terminating λ -term $(\lambda x.xx)(\lambda x.xx)$ depends on the identification of an argument with the function duplicating it. In recursion theory, to create from the elementary sequences $\theta_m(n) = 2_m^n$ (tower of exponential of height m in n), the non elementary sequence $n \mapsto 2^n$, we also need to identify n and m which seem to belong to different strata. Stratification restrictions might be applied to those frameworks (naive set theory, linear logic, lambda calculus and recursion theory) to entail coherence or complexity properties [2].

The first example of a stratification in linear logic appears in [10], though Girard did not use the word “stratification” at that time. Girard’s inspiration came from a sharp analysis of Russell’s paradox in naive set theory. This paradox needs the contraction of two formulae, the second being obtained from the first by the application of a “specification rule”. Therefore, we can avoid the paradox if :

1. We index each formula in the sequents with a natural number (called the stratum of the formula)
2. The use of the specification rule on a formula increases its stratum
3. We only allow contraction between formulae with the same stratum

Concretely, in [10] and [7], the stratification condition is “use neither digging nor dereliction ($?N$ and $?D$ links)” and is presented as ELL , a subsystem of LLL . Any proof-net of ELL reduces to its normal form in a number of step bound by an elementary function of its size. In [10] and [7], the stratum of an occurrence of a formula in a proof is the depth of its corresponding edge (in the proof net corresponding to the proof) in terms of box inclusion. The name “stratification” is given in [7] for this technique, but in this work the only kind of stratification considered is still the one where strata correspond to depths. In [2], Baillot and Mazza present an analysis of the concept of stratification, and a generalization of the stratification of [10] and [7]. Their stratification condition is enforced by a labelling of edges. It also enforces elementary time.

In this paper, we present an even more general stratification. This generalization is not given by a new linear logic subsystem but by a criterion on proof-nets. Then, to prove that a system is elementary time sound, we only have to prove that all the proof-nets of the system satisfy the criterion. Here, we apply the criterion to ELL and L^3 , the only two linear logic subsystems discovered characterizing elementary time. However, if a better system was discovered, it is possible that it would satisfy our criterion. To prove the soundness of this new system, we would only have to prove that it satisfies our criterion. Our work may simplify proofs of soundness of several systems by factoring out a common part.

4.2 Definition of “principal door” stratification

We will define a relation $\rightsquigarrow_!$ between boxes of proof nets. Intuitively, $B \rightsquigarrow_! B'$ means that B can be duplicated before being passed to B' as an argument. In terms of context semantics paths, it means that there is a path beginning by the principal door of B which enters B' by its principal door.

$$B \rightsquigarrow_! B' \Leftrightarrow \exists P, P' \in Pot, s \in Sig, T \in Tra(\sigma(B), P, !_s, +) \rightsquigarrow^* (\sigma(B'), P', T, -)$$

This definition of stratification might not be the most general possible for linear logic. Maybe we will find better, more general, simpler conditions for elementary time based on a stratification condition. Because we anticipate future definitions, we will not name this particular version of stratification in linear logic “stratification” but “principal door stratification”.

Definition 12. *A proof net G is “principal door” stratified if $\rightsquigarrow_!$ is acyclic.*

In this section, we will assume that the proof-nets we work on are stratified. In order to prove elementary soundness for stratified proof-nets, we will make a careful analysis of paths of context semantics in stratified proof-nets. The weak bounds for systems such as ELL and L^3 were proved using a strata by strata strategy (our notion of strata corresponds to depths in ELL and corresponds to levels in L^3). They prove that reducing the cuts at strata $\leq i$ does not increase too much the size of the proof-net at stratum $i + 1$. Here we will prove the strong bound for stratified proof nets in a similar way : we will bound the number of copies of a box has when we only reduce cuts in the strata $\leq i + 1$ by the maximum number of copies of a box when reducing only cuts in strata $\leq i$. Thus we need to formally define what is the strata of a box. Moreover, we need a notion of copies telling us whether a copy still corresponds to a duplicate if we only fire exponential cuts in strata $\leq i$. This is exactly what a \mapsto_i -copy will be.

Definition 13 (strata of a box/context). *The strata of a box B , written $S(B)$, is the depth of B in terms of $\rightsquigarrow_!$. The strata of a proofnet is the maximum strata of one its boxes : $S(G) = \max_{B \in B_G} S(B)$. Let C be a canonical context, there is a unique context $(\sigma(B), P, !_s, +)$ such that $(\sigma(B), P, !_t, +) \rightsquigarrow^* C$ (definitions of canonical contexts and \mapsto relation) the strata of C (written $S(C)$) is the strata of B .*

Definition 14. *Let G be a stratified proof-net. For all $s \in \{0, \dots, n\}$, we define \mapsto_s as follows :*

$$C \mapsto_s D \Leftrightarrow \begin{cases} C \mapsto D \\ S(D) \leq s \end{cases}$$

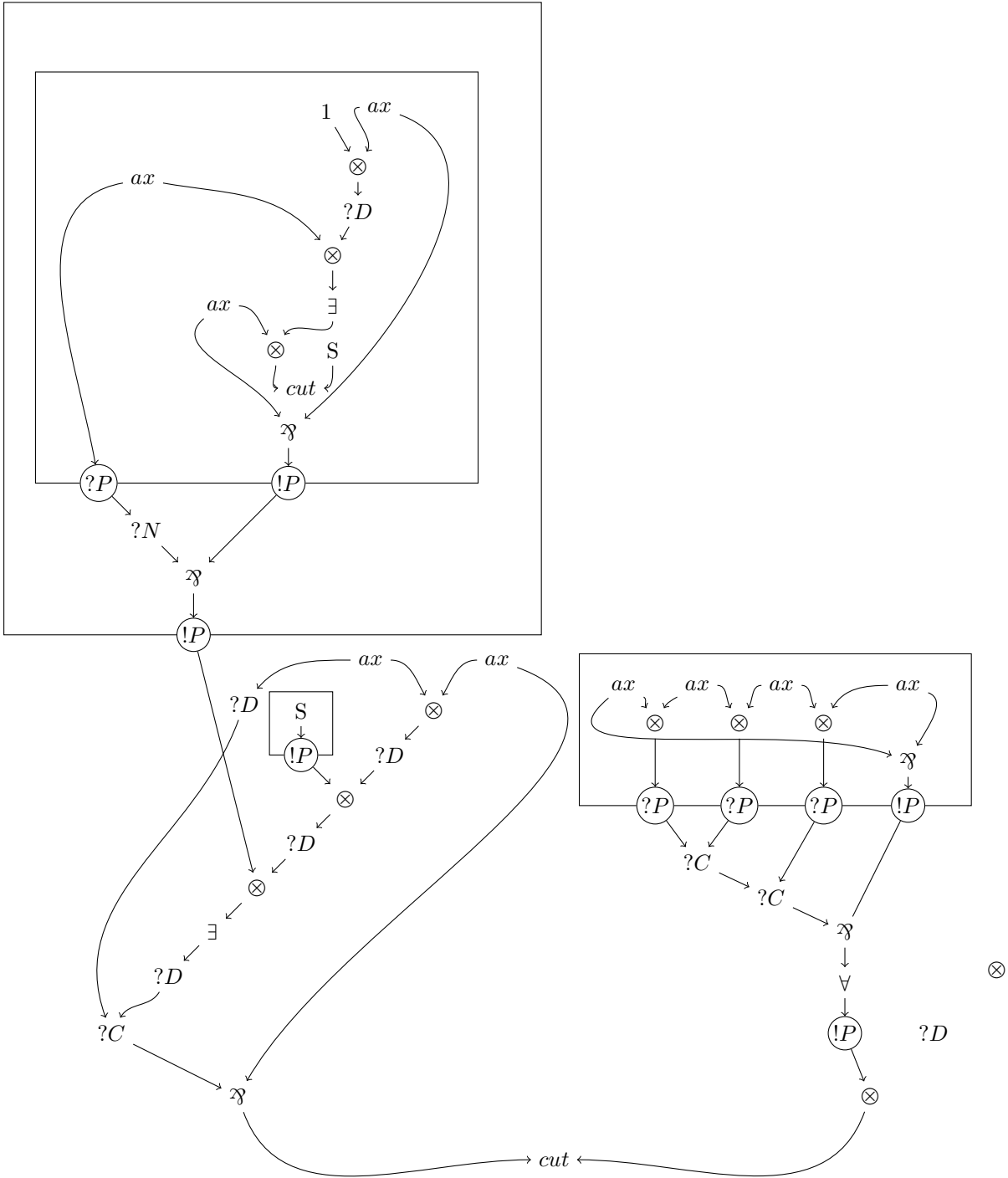

Concretely, it will prevent \hookrightarrow jumps over a box whose strata is too high. We define similarly \rightsquigarrow_s .

Lemma 16. *For all $B \in B_G$ and $s, s' \in \mathbb{N}$ with $s' \leq s$:*

- For all $P = [p_0; \dots; p_{\partial(B)-1}] \in L_{\mapsto_s}(B)$, there exists a unique $P^{/B, s'} = [p'_0; \dots; p'_{\partial(B)-1}] \in L_{\mapsto_{s'}}(B)$ such that for all $0 \leq i < \partial(B)$, $p'_i \triangleleft p_i$
- For all $P \in L_{\mapsto_s}(B)$ and t such that for all $t \sqsubseteq u$, u is a \mapsto_s -copy simplification of (B, P) , there exists a unique $t^{/B, P, s'} \triangleleft t$ such that for all $t^{/B, P, s'} \sqsubseteq u'$, u' is a $\mapsto_{s'}$ copy simplification.

Proof. We prove the statement by induction on $\partial(B)$.

- If $\partial(B) = 0$, then for all $P \in L_{\mapsto_s}(B)$, $P = []$. So we can take $[]^{/B, s'} = []$. Else, $P = Q.p_{\partial(B)-1}$ with $Q \in L_{\mapsto_s}(C)$ and C the deepest box containing B . By induction hypothesis, there exists a unique $Q^{/C, s'} = [p'_0; \dots; p'_{\partial(B)-2}] \in L_{\mapsto_{s'}}(C)$ such that $\forall 0 \leq i < \partial(B) - 1, p'_i \triangleleft p_i$. Moreover, $p_{\partial(B)-1} \in C_G(B, P)$, so by induction hypothesis there exists $p^{/C, Q, s'}_{\partial(B)-1} \triangleleft p_{\partial(B)-1}$ which is standard (the truncation of a standard signature is always standard) and such that all its simplifications are copy simplifications. So $p^{/C, Q, s'}_{\partial(B)-1} \in C_{\mapsto_{s'}}(C, Q^{/C, s'})$. So we can take $Q^{/C, s'} \cdot p^{/C, Q, s'}_{\partial(B)-1}$. If it was not unique, it would break one of the two unicity assumption.
- Now, we show the second property by induction on \sqsupseteq . Let us take t such that for all $t \sqsubseteq u$, u is a copy simplification of (B, P) . We build an exponential signature t'_0 in the following way :

- If t is minimal for \sqsupseteq , then $t'_0 = t$
- Else we consider t_0 the exponential signature obtained by transforming the deepest leftmost $n(v_l, v_r)$ of t into $p(v_r)$. Then, t'_0 is obtained by replacing in $t_0^{/B, P, s'}$ the $p(v'_r)$ corresponding to $p(v_r)$ (if it has not been cut) by $n(v_l, v'_r)$.

We now consider the path beginning by $(\sigma(B), P, !_{t'_0}, +)$. We can prove that for any context $(e, Q, [!_v]@U, p)$ of the path, Q is a canonical context for e and for any $v \sqsubset w$, $(e, Q, [!_w]@U, p)$ is a copy context. So, $(\sigma(B), P, !_{t'_0}, +) \mapsto^* (e, Q, [!_w]@W, p)$ with either $p = -$, and the tail of e is a $?_W$ link or $p = -$, $W = []$ and the tail of e is a $?_D$ link, or $p = +$ and the conclusion of e is \bullet . In each case, we know that there exists t' such that $t' \leq^w t'_0$ and $(\sigma(B), P, !_{t'_0}, +) \mapsto^* (e, Q, [!_e]@W, p)$.

□

For matters of readability, we will often write $L_s(x)$ for L_{\mapsto_s} and $C_s(x, P)$ for $C_{\mapsto_s}(x, P)$. We will also write $P^{/s}$ for $P^{/B, s}$ and $t^{/s}$ for $t^{/B, P, s}$ when the box B (and the potential P) can be guessed. Let us notice that if $s \geq S(G)$ then $\mapsto_s = \mapsto$. So the upper bounds on $L_{\mapsto_{S(G)}}(-)$ and $C_{\mapsto_{S(G)}}(-, -)$ will give us an upper bound on T_G , so on the maximum length of the reduction paths of G .

Theorem 4. *The maximal reduction length of a stratified proof net is bounded by an elementary function of its size. The height of the exponential tower depends only on the depth of $\rightsquigarrow_!$ and the depth of the proof net.*

Here is the sketch of the proof. The remaining of this section constitutes the complete proof.

First we will prove that, if $Q^{/s} = Q'^{/s}$ are two canonical potentials for edge f , $t \in Sig$ and $(f, Q, !_t, -)$ and $(f, Q', !_t, -)$ are canonical potentials. Then, there exists a box B and P, P' canonical potentials of B and $u \in Sig$ such that : $P^{/s} = P'^{/s}$, $(\sigma(B), P, !_u, +) \mapsto^* (f, Q, !_t, -)$ and $(\sigma(B), P', !_u, +) \mapsto^* (f, Q', !_t, -)$.

Let us consider two \mapsto_s -copies t, t' of a potential box (B, P) . Let us suppose that $(\sigma(B), P, !_t, +) \mapsto^* (e, Q, !_e, -)$ and $(\sigma(B), P, !_{t'}, +) \mapsto^* (e, Q', !_e, -)$ with $Q^{/s-1} = Q'^{/s-1}$. Then, the previous result gives us that the last \hookrightarrow rule (if it exists) of the two paths were respectively $(\sigma_i(C), R, !_u, -) \hookrightarrow (\sigma(C), R, !_u, +)$ and $(\sigma_{i'}(C), R', !_u, -) \hookrightarrow (\sigma(C), R', !_u, +)$ with $R^{/s} = R'^{/s}$. If we suppose moreover that $i = i'$, then we can go back to the previous \hookrightarrow rule, and so on until we reach the initial contexts $(\sigma(B), P, !_t, +)$ and $(\sigma(B), P, !_{t'}, +)$

with the additional information that $t = t'$. What we proved is that there is an injection from the \mapsto_s -copies of (B, P) to couples of \mapsto_{s-1} -potential edges with choices of auxiliary doors for all \hookrightarrow steps.

Finally, we will show that it is impossible to go twice through the same \mapsto_{s-1} -potential principal door. Thus, there are at most $|E_G| \times \max_{e \in E_G} |P^{s-1}(e)|$ choices of auxiliary door to make in the backward path of the previous paragraph. This gives us the following bound :

$$\max_{\substack{B \in B_G \\ P \in L_G(B)}} |C_{\mapsto_s}(B, P)| \leq |E_G| * \max_{B \in B_G} |L_{s-1}(B)| * (\max_{B \in B_G} |D_G(B)|)^{|E_G| * \max_{B \in B_G} |L_{s-1}(B)|}$$

We also know that $\max_{B \in B_G} |L_{s-1}(B)|$ is bound by $(\max_{B \in B_G // P \in L_{s-1}(B)} C_{s-1}(B, P))^{\delta(G)}$. So, an induction gives us a bound by a polynomial on $|E_G|$, as expected.

4.3 Cycles on potential boxes go by principal doors

Definition 15. We define the following relations :

$$\begin{array}{llllll} (B, P) \mapsto_! & (C, Q) \Leftrightarrow & (\sigma(B), P, !_t, +) \mapsto^* & (\sigma(C), Q, T, p) & \text{and } |T| \geq 2 \\ (B, P) \mapsto_? & (C, Q) \Leftrightarrow & (\sigma(B), P, !_t, +) \mapsto^* & (\sigma_i(C), Q, T, p) & \text{and } |T| \geq 2 \\ (B, P) \mapsto_< & (C, Q) \Leftrightarrow & B \subset C \text{ and } P = Q @ P' & & \\ (B, P) \mapsto & (C, Q) \Leftrightarrow & (\sigma(B), P, !_t, +) \mapsto^* & (e \in C, Q @ Q', T, p) & \\ (B, P) \rightsquigarrow_! & (C, Q) \Leftrightarrow & (\sigma(B), P, !_t, +) \rightsquigarrow^* & (\sigma(C), Q, T, p) & \text{and } |T| \geq 2 \\ (B, P) \rightsquigarrow_? & (C, Q) \Leftrightarrow & (\sigma(B), P, !_t, +) \rightsquigarrow^* & (\sigma_i(C), Q, T, p) & \text{and } |T| \geq 2 \\ (B, P) \rightsquigarrow_< & (C, Q) \Leftrightarrow & B \subset C \text{ and } P = Q @ P' & & \\ (B, P) \rightsquigarrow & (C, Q) \Leftrightarrow & (\sigma(B), P, !_t, +) \rightsquigarrow^* & (e \in C, Q @ Q', T, p) & \end{array}$$

Theorem 5. Let G be any proof-net. If $(B_1, P_1) \rightsquigarrow (B_2, P_2) \rightsquigarrow \dots \rightsquigarrow (B_m, P_m) \rightsquigarrow (B_1, P_1)$ then there exists a subsequence $(B_{i_1}, P_{i_1}) \rightsquigarrow_!(B_{i_2}, P_{i_2}) \rightsquigarrow_! \dots \rightsquigarrow_!(B_{i_n}, P_{i_n}) \rightsquigarrow_!(B_{i_1}, P_{i_1})$.

Proof. First let us suppose that there exist i, j such that $(B_i, P_i) \rightsquigarrow_<(B_j, P_j)$. Then :

$$(B_j, P_j) \rightsquigarrow (B_{j+1}, P_{j+1}) \rightsquigarrow \dots (B_{i-1}, P_{i-1}) \rightsquigarrow (B_j, P_j)$$

So, we can suppose that there is no such inclusion. Let us suppose that one of the steps is not $\rightsquigarrow_!$. We can suppose without loss of generality, that it is the last step : $(B_n, P_n) \rightsquigarrow_?(B_1, P_1)$. We will show that $(B_1, P_1, !_t, +) \mapsto^* (B_n, P_n, !_{t'}, +)$, which is impossible because proof-nets are acyclic.

We will show by induction on lexicographic order on (i, j) that if $(B_{n-i-1}, P_{n-i-1}) \rightsquigarrow^* (e, R, U, q) \rightsquigarrow^j (B_{n-i}, P_{n-i})$, then either :

- $U = U_1. !_u @ U_2$ with $(e, R, [!_u] @ U_2, q) \mapsto^* (\sigma(B_n), P_n, !_{t'}, +)$
- $e \in D, R = R_1.u @ R_2$ ($|R_1| = \delta(D)$) and $(\sigma(D), R_1, !_u, +) \mapsto^* (\sigma(B_n), P_n, !_{t'}, +)$

□

4.4 Definition of \sim equivalence between contexts

The idea of the injection lemma is the following. Suppose that two different \mapsto_s -copies of B (t and t') lead respectively to the final contexts $(g, P, !_e, -)$ and $(g, P', !_e, -)$ and $P^s = P'^s$. Let us go back from g to $\sigma(B)$ by the two paths. Because we are trying to recreate paths, beginning by their end, words like “beginning (or end) of the path” can be confusing : in which way are we taking the paths? If we go from $\sigma(B)$ to g we will talk about the “paths”, but if we go from g to $\sigma(B)$ we talk about the “antipaths”.

On the beginning of our antipaths, the contexts are on the same edge. The only way for the antipaths to separate is to cross a $?C, \wp$ or \otimes link upward with a different head of trace. The only way to have different traces between the two antipaths is to go out from a box and that the potentials of the two contexts for this box are different. The potential for boxes of stratum $< s$ are the same in the two antipaths. So the only way

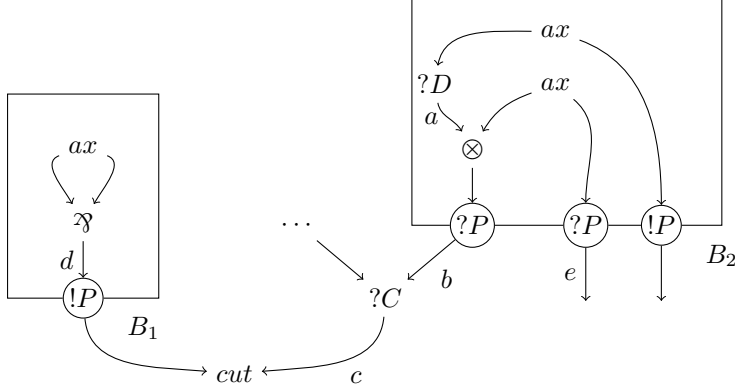

Figure 17: $(a, s, !_e, -) \leftarrow^2 (b, \square, !_e, \mathfrak{A}_l, !_s, -) \leftarrow (c, \square, !_e, \mathfrak{A}_l, !_{r(e)}, -) \leftarrow^2 (d, r(e), !_e, \mathfrak{A}_l, +) \leftarrow^5 (c, \square, !_e, \otimes_r, ?_{r(e)}, +) \leftarrow (b, \square, !_e, \otimes_r, ?_{r(e)}, +) \leftarrow^4 (e, \square, !_e, !_s, -)$

to have different traces between the two antipaths is to leave a box of stratum $\geq s$. It is only possible by their auxiliary door (the strata of the contexts are $< s$ along the path), so the only difference between the traces of the contexts is on exponential stacks of $!$ trace element. So, the paths will never separate (notice that for the antipaths to be separated by a $?C$ link, the difference must be on a $?$ signature), the two copies take exactly the same path, they are equal.

In fact, it is a little bit more complex, as we can see in figure 17 supposing $s(B_2) \geq s$ and $s(B_1) < s$. Indeed, a difference on the potential $[t]$ associated to a in the beginning of the antipath transforms into a difference on the signatures of a $!$ trace element (if we take another potential $[s']$ for a in the beginning of the antipath, it leads to a $!_{s'}$ in the b context). This difference can, in turn, lead to a difference in the potential of the context corresponding to a $\leq i$ -copy of a box (we would have $[r(s)]$ as a potential when entering B_1). This allows, by leaving the boxes by the principal door in the antipaths, to have different exponential signatures on $?$ trace element, so that the antipaths would separate on a $?C$. Although this possibility complexify the proof, the antipaths will not separate because the surface of both exponential signatures is the same and will lead them back into the box where the difference originated (whatever s' we chose, we always take the right premise of the contraction and go back to B_2). And, this box being in a strata $> s$, it is still impossible to leave the box by its principal door, hence impossible to have a difference on a $?$ trace element so to make the antipaths separate.

In order to prove that the antipaths never separate, we will prove that their contexts are pairwise equivalent for a complex equivalence relation \sim_s . The idea of the \sim_s equivalence between contexts is : their edges and their \mapsto_s canonical potential are equal. And, indeed, the actual \sim_s definition will be (almost) equivalent to this when the traces are reduced to one element. But, the actual definition must be a bit more complex because we want this equivalence to be stable under anti- \rightsquigarrow_s step. We will need two relations (\approx_s and \simeq_s) to define \sim_s

Let C and C' be two contexts, $C \approx_s C'$ means : "It is possible to make the same number of \mapsto_s steps in the two contexts and to reach contexts which have the same trace. The edges of the contexts in the paths must be pairwise equal". $(e, P) \simeq_s (e, Q)$ means : the exponential signatures of P and Q corresponding to box of stratum $< s$ must be either pairwise equal, or at least their surface is pairwise equal because a \mapsto_s path leaving this box will arrive at a context where the traces are equal. These definitions are made to take into account cases similar to figure 17 where a difference in a $\mapsto_{s' \geq s}$ potential is transformed into a harmless difference in a $\mapsto_{< s}$ potential.

Definition 16. Let (e, P, T, p) and (e, Q, U, p) be two contexts and $s \in \mathbb{N}$. $(e, P, T, p) \approx_s (e, Q, U, p)$ if one of the following conditions holds:

- $T = U$
- $(e, P, T, p) \dashv\rightsquigarrow_s$ and $(e, Q, U, p) \dashv\rightsquigarrow_s$, $(e, P, T, p) \dashv\rightarrow_{s-1}$ and $(e, Q, U, p) \dashv\rightarrow_{s-1}$
- $(e, P, T, p) \rightsquigarrow_s (e', P', T', p')$, $(e, Q, U, p) \rightsquigarrow_s (e', Q', U', p')$ and $(e', P', T', p') \approx_s (e', Q', U', p')$
- $(e, P, T, p) \hookrightarrow_{s-1} (e', P', T', p')$, $(e, Q, U, p) \hookrightarrow_{s-1} (e', Q', U', p')$ and $(e', P', T', p') \approx_s (e', Q', U', p')$

Definition 17. Let P, Q be canonical potentials of edge e and $s \in \mathbb{N}$. $(e, P) \simeq_s (e, Q)$ is defined by :

- If $P = Q = []$, $(e, P) \simeq_s (e, Q)$
- If $P = P'.t$, $Q = Q'.u$ and B is the deepest box containing e
 - If $S(B) \geq s$, then $(e, P) \simeq_s (e, Q) \Leftrightarrow (\sigma(B), P') \simeq_s (\sigma(B), Q')$
 - If $S(B) < s$, then $(e, P) \simeq_s (e, Q) \Leftrightarrow \begin{cases} (\sigma(B), P') \simeq_s (\sigma(B), Q') \\ (\sigma(B), P', !_t, +) \approx_s (\sigma(B), Q', !_u, +) \end{cases}$

We can notice that whenever e and f belong to the same boxes, $(e, P) \simeq_s (e, Q) \Leftrightarrow (f, P) \simeq_s (f, Q)$. We will often write $P \simeq_s Q$ for $(e, P) \simeq_s (e, Q)$ when the edge e we refer to (or at least the boxes containing it) can be deduced from the sentences around it.

The definition of \sim_s says : the contexts are the same except that the potentials and traces may differ on exponential signatures corresponding to boxes of strata $\geq s$ or on other exponential signatures in such a way that it will not make the antipaths separate until the respective signatures go in the potential of a $\geq s$ box.

Definition 18. $(e, P, !_t.T, p) \sim_s (e, P', !_{t'}.T', p)$ if all the following conditions stand:

1. $(e, P) \simeq_s (e, P')$
2. T differs from T' only on the exponential signatures of its $!$ and $?$ trace elements.
3. If $T = U.!_u.V$, $T' = U'.!_{u'}.V'$ and $|U| = |U'|$ then $(e, P, !_u.V, p) \approx_s (e, P', !_{u'}.V', p)$.
4. If $T = U.?_u.V$, $T' = U'.?_{u'}.V'$ and $|U| = |U'|$ then $(e, P, !_u.V^\perp, p^\perp) \approx_s (e, P', !_{u'}.V'^\perp, p'^\perp)$

Lemma 17. If $\left\{ \begin{array}{l} C_e \rightsquigarrow_s C_f \\ C'_e \rightsquigarrow_s C'_f \\ C_f \sim_s C'_f \end{array} \right\}$ then $C_e \sim_s C'_e$.

Moreover if the first element of the traces of C_f and C'_f are equal, then the first element of the traces of C_e and C'_e are equal.

Proof.

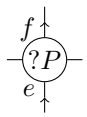

Suppose $C_e = (e, P, [!_t]@T.!_u, -) \rightsquigarrow (f, P.u, [!_t]@T, -) = C_f$ (crossing an auxiliary door of box B upwards). Then $C'_f = (f, P'.u', [!_{t'}]@T', -)$ with $P.u \simeq_s P'.u'$ and T differs from T' only on $!$ and $?$ trace elements (definition of \sim_s). The predecessor of C'_f is unique, so we have $C'_e = (e, P', !_t.T.!_{u'}, -)$. We can verify that $C_e \sim_s C'_e$. The only interesting point to prove is that $(e, P, !_u, -) \approx_s (e, P', !_{u'}, -)$ (for 3) :

- If $S(B) < s$, $(e, P, !_u, -) \mapsto_s (\sigma(B), P, !_u, +) = C_g$ and $(e, P', !_{u'}, -) \mapsto_s (\sigma(B), P', !_{u'}, +) = C'_g$. We know that $C_g \approx_s C'_g$ because $(f, P.u) \simeq_B (f, P'.u')$. So $(e, P, !_u, -) \approx_s (e, P', !_{u'}, -)$ (by rule 3 of the definition of \approx_s).
- If $S(B) \geq s$, $(e, P, !_u, -) \approx_s (e, P', !_{u'}, -)$ by point 2 of the definition of \approx_s

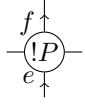

Suppose $C_e = (e, P, [!_t]@T.?_u, -) \rightsquigarrow (f, P.u, [!_t]@T, -) = C_f$ (crossing the principal door of B upwards). Because of the hypothesis and the stratification of the proof net, $S(B) < s$. So $C'_f = (f, P'.u', !_t.T', -)$ with $(e, P, !_u, +) \approx_s (e, P', !_u', +)$ (because $(f, P.u) \simeq (f, P'.u')$). So $(e, P, !_u, (-)^\perp) \approx_s (e, P', !_u', (-)^\perp)$. This gives us the **4** condition for the only new exponential signature on the trace. Because we know that $(f, P.u) \simeq_s (f, P'.u')$, we have that $(\sigma(f) = e, P) \simeq_s (\sigma(f) = e, P')$. The other conditions are straightforward.



Suppose $C_e = (e, P.u, [!_t]@T, +) \mapsto (f, P, [!_t]@T.?_u, +) = C_f$ (crossing an auxiliary door of box B downwards). Then C'_f has the shape : $C'_f = (f, P', [!_{t'}]@T'.?_{u'}, +)$. The only possibility for C'_e is $C'_e = (e, P'.u', [!_{t'}]@T', +)$. We will show that $C_e \sim_s C'_e$. Only the first points offer some difficulties, the others are straightforward.

- If $S(B) \geq s$, then we only have to show that $(\sigma(B), P) \simeq_s (\sigma(B), P')$. $\sigma(B)$ and f are included in the same boxes, so we only have to prove that $(f, P) \simeq_s (f, P')$. This is given by the hypothesis of $C_f \sim_s C'_f$
- If $S(B) < s$, then we have to show that $(\sigma(B), P) \simeq_s (\sigma(B), P')$ (which we can show as in the previous case) and that $(\sigma(B), P, !_u, +) \simeq_s (\sigma(B), P', !_u', +)$. We know that $C_f \sim_s C'_f$, so $(f, P, !_u, -) \approx_s (f, P', !_u', -)$. Which of the four possible conditions of the definition of \approx_s holds? It can not be the second or third one. So, this means that either $!_u = !_u'$ (and in this case $(\sigma(B), P, !_u, +) \simeq_s (\sigma(B), P', !_u', +)$ because of the first condition) or the \hookrightarrow_{s-1} successors of C_f and C'_f (which are respectively $(\sigma(B), P, !_u, +)$ and $(\sigma(B), P', !_u', +)$ are \approx_s equivalent which is the result needed.

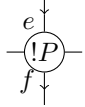

Suppose $C_e = (e, P.u, [!_t]@T, +) \mapsto_s (f, P, [!_t]@T.!_u, +) = C_f$ (crossing the principal door of box B downwards). We supposed that $C_f \sim_s C'_f$, so C'_f has shape $C'_f = (f, P', [!_{t'}]@T'.!_{u'}, +)$. We have $(f, P, !_u, +) \equiv_s (f, P', !_u', +)$ (condition 3 of the definition of \approx). Moreover we know that $(\sigma(B), P) \simeq_s (\sigma(B), P')$ (because of condition **1** of $C_f \sim_s C'_f$). So $(e, P.u) \simeq_s (e, P'.u')$. The other conditions are straightforward.

In the other cases, it is straightforward after unfolding the definitions. \square

In the sketch of the proof of elementary time soundness for stratified proof nets we wrote, we said that “there is an injection from the \mapsto_s -copies of (B, P) to couples of \mapsto_{s-1} potential edges with choices of auxiliary doors for all \hookrightarrow steps.” Copies and potential edges are objects we already defined. However, we never defined what was a “choice of auxiliary doors for all \hookrightarrow steps”. This is exactly what the following definition of an “itinerary” intends to do. The lemma just after is the formalization of the statement.

Definition 19. Let (B, P) be a potential box and $t \in S_s(B, P)$, the itinerary of t (written $I(B, P, t)$) is the list of natural numbers $i_1.i_2. \dots .i_n$ such that

$$\begin{aligned} & (\sigma(B), P, !_t, +) \rightsquigarrow^* (\sigma_{i_1}(B_1), P_1, !_t, -) \\ \hookrightarrow & (\sigma(B_1), P_1, !_t, +) \rightsquigarrow^* (\sigma_{i_2}(B_2), P_2, !_t, -) \\ \hookrightarrow & \dots \rightsquigarrow^* (\sigma_{i_n}(B_n), P_n, !_t, -) \\ \hookrightarrow & (\sigma(B_n), P_n, !_t, +) \rightsquigarrow^* C_f \end{aligned}$$

We will also write $I_s(B, P)$ for $\{I(B, P, t)/t \in S_{\mapsto_s}(B, P)\}$ and $I_s((B, P), (e, Q)) = \{I(B, P, t)/(\sigma(B), P, !_t, +) \mapsto^* (e, Q, !_e, -)\}$

Lemma 18. For all (B, P) , for all $s \in \mathbb{N}$, $|C_s(B, P)| \leq |Pot_{\mapsto_{s-1}}(E_G)| * |I_s(B, P)|$

Proof. Suppose $t \in S_s(B, P)$, then there exists $(B_i)_{i \leq n}, (P_i)_{i \leq n}, (t_i)_{i \leq n}$ suchh that $(\sigma(B), P, !_t, +) \rightsquigarrow^* (\sigma_{i_1}(B_1), P_1, !_t, -) \hookrightarrow (\sigma(B_1), P_1, !_t, +) \rightsquigarrow^* (\sigma_{i_2}(B_2), P_2, !_t, -) \hookrightarrow (\sigma(B_2), P_2, !_t, +) \dots (\sigma(B_n), P_n, !_t, +) \rightsquigarrow^* (e, Q, !_e, -)$. We will prove that the mapping from t to $(i_1, i_2, \dots, i_n, e, Q^s)$ is an injection.

Suppose that $(\sigma(B), P, !_t, +) \rightsquigarrow^* \dots \rightsquigarrow (\sigma_{i_n}(B_n), P_n, !_t, -) \hookrightarrow (\sigma(B_n), P_n, !_t, +) \dots (e, Q, !_e, -)$ and $(\sigma(B), P, !_t', +) \rightsquigarrow^* \dots \rightsquigarrow (\sigma_{i_n}(B'_n), P'_n, !_t', -) \hookrightarrow (\sigma(B'_n), P'_n, !_t', +) \rightsquigarrow^* (e, Q', !_e, -)$ with $Q^s = Q'^s$.

Then $(e, Q^{/s}) \simeq_s (e, Q'^{/s})$, so $(e, Q, !e, -) \sim_s (e, Q', !e, -)$. So we can prove by counter-induction on k that $(\sigma_{i_k}(B_k), P_k, !t_k, -) \sim_s (\sigma_{i_k}(B_k), P'_k, !t'_k, -)$ and $!t_k = !t'_k$.

Let us suppose, without loss of generality, that $n \geq n'$ then we have $(\sigma_{i_{n-n'}}(B_{n-n'}), P_{n-n'}, !t_{n-n'}, +) \sim_s (\sigma(B), P, !t, +)$. If $n \neq n'$, we could repeat this cycle an arbitrary number of times, in particular $> L_{\mapsto}(P)$, it contradicts the acyclicity of proof-nets. So $n = n'$ and $t = t'$. \square

Lemma 19. *For all $t \in \text{Sig}(B, P)$, the length of $I_s(B, P, t)$ is bound by $|\text{Pot}_{\mapsto s-1}(E_G)|$*

Proof. Let $[i_1; \dots; i_n] = I_s(B, P)$, then $(\sigma(B), P, !t, +) \rightsquigarrow^* (\sigma_{i_1}(B_1), P_1, !t_1, -) \hookrightarrow (\sigma(B_1), P_1, !t_1, +) \rightsquigarrow^* (\sigma_{i_2}(B_2), P_2, !t_2, -) \hookrightarrow \dots \hookrightarrow (\sigma_{i_n}(B_n), P_n, !t_n, -) \hookrightarrow (\sigma(B_n), P_n, !t_n, +) \rightsquigarrow C_f$.

Suppose there are $j < k$ such that $(B_j, P_j^{/s-1}) = (B_k, P_k^{/s-1})$. Then $C_0^j = (\sigma(B_j), P_j, !t_j, +) \sim_s (\sigma(B_k), P_k, !t_k, +) = C_0^k$ and $C_0^j \mapsto^l C_0^k$. As was shown by lemma 17, we can follow the antipaths beginning by those contexts. The contexts C_n^j and C_n^k of the n -th step of the antipaths will always satisfy $C_n^j \sim_s C_n^k$ and $C_n^k = C_{n-l}^j \leftarrow^l C_n^j$. So C_n^k has an antecedent by the \rightsquigarrow relation. So, C_n^j also has one. By induction, we can create an arbitrary long path with an arbitrary high number of \hookrightarrow steps in it. The number of potential boxes being finite, it would mean the proof net is cyclic, which was proved impossible. By Dal Lago's weight theorem. \square

Theorem 6. *If a proof net is stratified, then the length of its longest path of reduction is bound by $a_{S+4}^{E_G}$ with $S = \max_{B \in B_G} S(B)$, $d = \max_{B \in B_G} D_G(B)$, $\partial = \partial(G)$ and $a = \max(2, d^{2\partial})$*

Proof. Combining the two preceding lemmas, we have (with $d = \max_{B \in B_G} D_G(B)$, $S = \max_{B \in B_G} S(B)$ and $\partial = \partial(G)$):

$$\begin{aligned} |\text{Pot}_{\mapsto s}(e)| &\leq \left(\max_{\substack{e \in B \\ Q \in L_G(B)}} |C_{\mapsto s}(B, Q)| \right)^{\partial(e)} \\ |\text{Pot}_{\mapsto s}(e)| &\leq \left(\max_{(f, Q) \in \text{Pot}(E_G)} |C_{\mapsto s}(f, Q)| \right)^{\partial} \\ |\text{Pot}_{\mapsto s}(e)| &\leq \left(|\text{Pot}_{\mapsto s-1}(E_G)| * \max_{(B, P) \in \text{Pot}(B_G)} |I_s(B, P)| \right)^{\partial} \\ |\text{Pot}_{\mapsto s}(e)| &\leq \left(|\text{Pot}_{\mapsto s-1}(E_G)| * d^{|\text{Pot}_{\mapsto s-1}(E_G)|} \right)^{\partial} \end{aligned}$$

By induction, we can prove the following bound (with $a = \max(2, d^{2\partial})$),

$$\forall s \in \mathbb{N}, \forall e, |\text{Pot}_{\mapsto s}(e)| \leq a_s^{E_G}$$

So $\forall B \in B_G, |\text{Pot}(e)| \leq a_s^{E_G}$ and $\forall (B, P) \in \text{Pot}(E_G), |S(B, P)| \leq a_{s+1}^{E_G}$.

$$\begin{aligned} T_G &= \sum_{e \in E_G} |L_{\mapsto}(e)| + 2 * \sum_{e \in P_G} \left(D_G(e) \sum_{P \in L_{\mapsto}(e)} \sum_{t \in S_{\mapsto}(e, P)} |t| \right) \\ T_G &\leq |E_G| * a_{s+1}^{E_G} + 2 * |P_G| * d * a_{s+1}^{E_G} * a_{s+1}^{E_G} * a_{s+1}^{E_G} \\ T_G &\leq a_{s+4}^{E_G} \end{aligned}$$

\square

5 Dependence control

Though stratification gives us a bound on the length of the reduction, elementary time is not considered as a reasonable bound. Figure 18 explains us how the complexity arises, despite stratification. On this proof net, the box A duplicates the box B. Each copy of B duplicates C, each copy of C. We call “dependence control condition” any restriction on linear logic which aims to tackle this kind of “double joins” sequences. The solution chosen by Girard [10] was to limit the number of $?P$ -doors of each $!$ -boxes to 1. To keep some expressivity, he introduced a new modality ξ with ξ -boxes which can have an arbitrary number of $?P$ -doors.

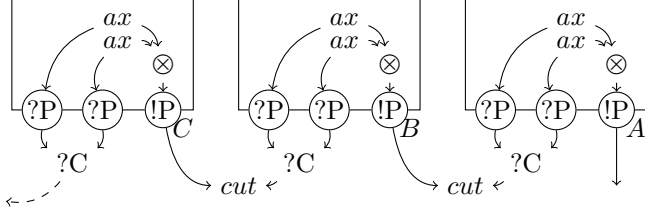

Figure 18: This proof net (if extended to n boxes) reduces in 2^n steps

However, this “one auxiliary door” condition forbids a great number of proof-nets where there are boxes with more than one auxiliary door but whose complexity is still polynomial. The complexity explosion in figure 18 comes from the fact that two copies of a box B fuse with the same box A . A box with several auxiliary doors is only harmful if two of its auxiliary edges are contracted as in figure 18. That is the reason why, in the system L^{3a} [8], Dorman and Mazza replaced the “one auxiliary door” condition by a looser dependence control condition : each edge is labelled with an integer, the label of an auxiliary door must be inferior or equal to the label of the principal door of the box, for a given box at most one auxiliary door can have the same label as the principal door.

The dependence control of L^{3a} seems to give a greater expressive power than the dependence control of LLL . However, it has two flaws. The main flaw is that L^{3a} use the same labels to control dependence and to enforce stratification. This entails useless constraints on the strata corresponding to the auxiliary doors of boxes. Next, there is a more subtle flaw. Let us notice that a proof-net can have figure 18 as a subproof-net and still reduce in a number of steps polynomial in the size of the input. Indeed, it only creates a box with 8 auxiliary doors, 8 is a constant, it does not depend on the input. In fact, what we do not want is to have a sequence of boxes similar to the one of figure 18 whose length could depend on the input.

Here we give a new dependence control condition which generalizes both the conditions of LLL and L^{3a} . We try to have as few false positives as possible, so we will only forbid proofnets where, along the cut elimination, two (or more) duplicates of a box B join the same duplicate of a box B . Indeed, suppose a sequence of double joins appears during cut elimination and that the boxes of the sequence are duplicates of pairwise distinct boxes of the original proofnet. Then, the length of the sequence is bounded by the number of boxes of the original proofnet, so the sequence would be harmless. Our condition is given in the following way : we first define a relation $B \succcurlyeq_k B'$ (B joins B') on boxes meaning that k duplicates of B join B' and we say that a proof net controls dependence if \succcurlyeq_2 is not reflexive.

Definition 20.

- We define (B, P) k -joins directly (B', Q) in stratum s as

$$(B, P) \succcurlyeq_k^s (B', Q) \Leftrightarrow k = |\{t \mid (\sigma(B), P, !_{t_i}, +) \rightsquigarrow^* (\sigma_i(B'), Q, !_e, -) \text{ with } t \text{ quasi-standard, } S(B) \leq s \text{ and } S(B') \leq s\}|.$$

- We define B k -joins B' in stratum s as :

$$B \succcurlyeq_k^s B' \Leftrightarrow k \geq \max_{\substack{P \in LG(B) \\ Q \in LG(B')}} \sum_{(B, P) \succcurlyeq_{k_1}^s (B_1, P_1) \succcurlyeq_{k_2}^s \dots \succcurlyeq_{k_n}^s (B', Q)} k_1 \cdots k_n$$

- If $B \succcurlyeq_2^s C$, then we say that B s -swarms B' .

Definition 21. A principal door stratified proof net G controls dependence if $\succcurlyeq_2^{S(G)}$ is irreflexive.

If a proof net controls dependence, then for all box B we define the nest of B at stratum s (written $N_s(B)$) as the depth of B in terms of the swarm relation. For any potential box (B, P) , we define the colonies of (B, P) at stratum s (written $Col_s(B, P)$) as

$$Col_s(B, P) = \left\{ \sigma_i(B'), P' \left| \begin{array}{l} (B, P) = (B_0, P_0) \geq_1^s (B_1, P_1) \geq_1^s \cdots \geq_1^s (B_n, P_n) \\ \forall i, S(B_i, P_i) \leq s \\ \exists t \in Sig, (\sigma(B_n), P_n, !_t, +) \rightsquigarrow^* (\sigma_i(B'), P', !_e, -) \\ N(B) = N(B_1) = \cdots = N(B_n) > N(B') \end{array} \right. \right\} \quad (1)$$

Lemma 20. *If a stratified proof net controls dependence, then for all $s \geq 0$, $|I_s((B, P), (e, W))| \leq (d.Pot_{s-1}(E_G))^{2 \cdot N(B)} * |Col_s(B, P)|$ with $d = \max_{B \in B_G} D_G(B)$.*

Proof. In fact we will prove $|I_s((B, P), (e, W))| \leq (d.l.Pot_{s-1}(E_G))^{N(B)} * |Col_s(B, P)|$ with $d = \max_{B \in B_G} D_G(B)$ and l the maximum length of a \geq_1^s sequence beginning by potential box (B, P) . The announced result is then immediate because, if we suppose there is a \geq_1^s path longer than $|Pot_{s-1}(E_G)|$, then the proof-net is cyclic which is impossible.

We will prove this by induction on l , the depth of (B, P) in terms of the \geq_1^s relation. The relation \geq may be cyclic on boxes. But it is acyclic on potential boxes (otherwise, the proof-net would be cyclic which was proved impossible). So the induction is well founded. Explanations of the calculations done between each line are given at the end of the calculation.

$$|I_s((B, P), (e, Q))| \leq 1 + \sum_{(B, P) \geq_j^1 (B', P')} j \cdot |I_s((B', P'), (e, Q))| \quad (2)$$

$$|I_s((B, P), (e, Q))| \leq 1 + \sum_{(B, P) \geq_j^1 (B', P')} j \cdot (d.(l-1).|Pot_{s-1}(E_G)|)^{N(B')} |Col_s(B', P')| \quad (3)$$

$$|I_s((B, P), (e, Q))| \leq 1 + A + B \quad (4)$$

With A and B quantities defined and bound below (the size of the expressions made it impossible to keep both on the same line). The previous calculus may need some explanations.

The first line is given by a counting argument. Let us choose an itinerary from (B, P) to (e, Q) . Either it has some \leftrightarrow rule in it, jumping over a (B', P') box, or it goes directly to (e, Q) . In the first case we still have to choose an itinerary from (B', P') to (e, Q) , in the second one there is only way because \rightsquigarrow is bideterministic.

The second line of the previous calculus was obtained by induction hypothesis, the last by the separation of the set of potential boxes (B', P') joined by (B, P) into two disjoint sets.

$$\begin{aligned} A &= \sum_{\substack{(B, P) \geq_j^1 (B', P') \\ N(B') = N(B)}} j \cdot (d.(l-1).|Pot_{s-1}(E_G)|)^{N(B')} |Col_s(B', P')| \\ &\leq \sum_{\substack{(B, P) \geq_j^1 (B', P') \\ (\sigma_i(C), Q) \in Col_s(B', P') \\ N(B') = N(B)}} j \cdot (d.(l-1).|Pot_{s-1}(E_G)|)^{N(B')} \\ &\leq \sum_{\substack{(B, P) \geq_1^1 (B', P') \\ (\sigma_i(C), Q) \in Col_s(B', P') \\ N(B') = N(B)}} (d.(l-1).|Pot_{s-1}(E_G)|)^{N(B')} && \text{if } j \text{ was } > 1, N(B') < N(B) \\ &\leq \sum_{\substack{(B, P) \geq_1^1 (B', P') \\ (\sigma_i(C), Q) \in Col_s(B', P') \\ N(B') = N(B) \\ (\sigma_i(C), Q) \in Col_s(B, P)}} (d.(l-1).|Pot_{s-1}(E_G)|)^{N(B)} \end{aligned} \quad (5)$$

$$(6)$$

To obtain the inequality 5, we notice that if $(\sigma_i(C), Q) \in Col_s(B', P')$, there is a sequence $(B', P') \succeq^1 (B_1, P_1) \succeq^1 \dots \succeq^1 (B_n, P_n)$ and $(\sigma(B_n), P_n, !t, +) \rightsquigarrow^* (\sigma_i(C), Q)$. We can extend the sequence in the following way : $(B, P) \succeq^1 (B', P') \succeq^1 (B_1, P_1) \succeq^1 \dots \succeq^1 (B_n, P_n)$. We know that $N(B) = N(B')$, so the condition on the nests is also respected and this sequence prove that $(\sigma_i(C), Q) \in Col_s(B, P)$.

$$\begin{aligned}
B &= \sum_{\substack{(B,P) \succeq_j^1 (B',P') \\ N(B') < N(B)}} j(d.(l-1).|Pot_{s-1}(E_G)|)^{N(B')} |Col_s(B', P')| \\
&\leq \sum_{\substack{(B,P) \succeq_j^1 (B',P') \\ N(B') < N(B)}} j(d.(l-1).|Pot_{s-1}(E_G)|)^{N(B)-1} |Col_s(B', P')| \quad (N(B') < N(B) \text{ so } N(B') \leq N(B) - 1) \\
&\leq \sum_{\substack{(B,P) \succeq_j^1 (B',P') \\ N(B') < N(B)}} j(d.(l-1).|Pot_{s-1}(E_G)|)^{N(B)-1} |Pot_{s-1}(E_G)| \tag{7}
\end{aligned}$$

$$B \leq \sum_{\substack{(B,P) \succeq_j^1 (B',P') \\ (\sigma_i(B'), P') \in Col_s(B,P)}} (d.(l-1).|Pot_{s-1}(E_G)|)^{N(B)} \tag{8}$$

To obtain the inequality 7, we need to prove that if $(\sigma_i(C), Q) \in Col_s(B', P')$, $(\sigma_i(C), Q') \in Col_s(B', P')$ and $Q'^s = Q^s$ then $Q = Q'$. By definition of $Col_s(-, -)$, the strata of the boxes corresponding to the \leftrightarrow along the path are inferior or equal to s . So, thanks to lemma 17, we can follow the path backward to show that they come from contexts $(\sigma(B'), P'_1, !t, +)$ and $(\sigma(B'), P'_2, !t, +)$, with $P'_1 \sim_s P'_2$. If $P'_1 \neq P'_2$ we can show that the proof-net is cyclic. Thus $P'_1 = P'_2 = P'$. The signatures in the two initial contexts are equal, so the paths are equal, so $Q = Q'$. Notice that there are no choices to do on the auxiliary door during backward \leftrightarrow steps, because $\forall i, N(B_i) = N(B')$.

Now, it is possible to assemble the two inequalities. Indeed, there can be considered as sums of the same term $(d(l-1).|Pot_{s-1}(E_G)|)^{N(B)}$ over disjoint sets. Suppose $(\sigma_i(B'), P') \in Col_s(B, P)$, let us consider the shortest sequence proving this belonging. Either it has length 1, in this case we are in the case of the 8 inequality. Or it has length > 1 , in this case we are in the case of the 5 inequality.

$$|I_s((B, P), (e, Q))| \leq 1 + \sum_{(\sigma_i(B'), P') \in Col_s(B, P)} (d.(l-1).|Pot_{s-1}(E_G)|)^{N(B)} \tag{9}$$

$$|I_s((B, P), (e, Q))| \leq 1 + (d.(l-1).|Pot_{s-1}(E_G)|)^{N(B)} |Col_s(B, P)| \tag{10}$$

$$|I_s((B, P), (e, Q))| \leq (d.l.|Pot_{s-1}(E_G)|)^{N(B)} |Col_s(B, P)| \tag{11}$$

□

Theorem 7. *The maximal reduction length of a stratified proof net which controls dependence is a polynomial of its size. The degree of the polynomial depends only on the depth of $>$ and \succeq_2 .*

Proof. Combining the two preceding lemmas, we have (with $d = \max_{B \in B_G} D_G(B)$, $S = \max_{B \in B_G} S(B)$,

$\partial = \partial(G)$ and $n = \max_{B \in B_G} N(B)$:

$$\begin{aligned}
|Pot_{\mapsto_s}(e)| &\leq \left(\max_{\substack{e \in B \\ Q \in L_G(B)}} |S_{\mapsto_s}(B, Q)| \right)^{\partial(e)} \\
|Pot_{\mapsto_s}(e)| &\leq \left(\max_{(f, Q) \in Pot(E_G)} |S_{\mapsto_s}(f, Q)| \right)^{\partial} \\
|Pot_{\mapsto_s}(e)| &\leq \left(|Pot_{\mapsto_{s-1}}(E_G)| * \max_{(B, P) \in Pot(B_G)} |I_s(B, P)| \right)^{\partial} \\
|Pot_{\mapsto_s}(e)| &\leq \left(|Pot_{\mapsto_{s-1}}(E_G)| * |Pot_{s-1}(E_G)| * (d \cdot |Pot_{s-1}(E_G)|)^{2 \cdot n} |Col_s(B, P)| \right)^{\partial} \\
|Pot_{\mapsto_s}(e)| &\leq d^{\partial \cdot 2n} |Pot_{s-1}(E_G)|^{\partial \cdot (n+3)} \\
|Pot_{\mapsto_s}(e)| &\leq d^{\sum_{i=0}^{s-1} (\partial \cdot (n+3))^i \partial \cdot 2n} |E_G|^{\partial \cdot (2n+3)^s} \\
|Pot_{\mapsto_s}(e)| &\leq (d \cdot |E_G|)^{s(\partial \cdot (2n+3))^s}
\end{aligned}$$

$$\begin{aligned}
T_G &= \sum_{e \in E_G} |L_{\mapsto}(e)| + 2 * \sum_{e \in P_G} \left(D_G(e) \sum_{P \in L_{\mapsto}(e)} \sum_{t \in S_{\mapsto}(e, P)} |t| \right) \\
T_G &\leq |E_G| (d \cdot |E_G|)^{s(\partial \cdot (2n+3))^s} + 2|P_G| \cdot d \cdot (d \cdot |E_G|)^{s(\partial \cdot (2n+3))^s} \cdot \left((d \cdot |E_G|)^{(s+1)(\partial \cdot (2n+3))^{s+1}} \right)^2 \\
T_G &\leq (|E_G| + 2|P_G| \cdot d) \left((d \cdot |E_G|)^{(s+1)(\partial \cdot (2n+3))^{s+1}} \right)^3 \\
T_G &\leq (3 \cdot d \cdot |E_G|) \left((d \cdot |E_G|)^{3(s+1)(\partial \cdot (2n+3))^{s+1}} \right) \\
T_G &\leq (d \cdot |E_G|)^{2+3(s+1)(\partial \cdot (2n+3))^{s+1}} \\
T_G &\leq (d \cdot |E_G|)^{(\partial \cdot (6n+11))^{s+1}}
\end{aligned}$$

□

6 Applications

6.1 Elementary bounds

6.1.1 *ELL*, the stratification through depth

ELL (Elementary Linear Logic) is the first defined subsystem of linear logic which characterizes elementary time (tower of exponential of fixed height). It was hinted by Girard [10] and made explicit by Danos and Joinet [7]. The principle of *ELL* is to forbid dereliction and digging. Therefore, the depth of any edge is not changed by cut elimination. We can reduce at depth 0, then at depth 1, then at depth 2, ... During one of those round, the size of the proof-net will at most be exponentiated : there are at most $|G|$ $?C$ nodes at depth i at the beginning of round i . In the “worst” case, each of these $?C$ nodes will double the size of the proof net. So at the end of the round, the size of the net is inferior to $2^{|G|}$. By induction on the depth, we have the elementary bound.

Definition 22. *ELL* is the fragment of LL_0 proof-nets where :

- There is neither \S , $?D$ nor $?N$ link
- There is no \S in the formulae labelling the edges
- All the indexes on the ground formulae are 0

The equivalent of the property “the depth is not changed by cut elimination” in context semantics is a property of conservation of some quantity (representing the depth of a context) through the \mapsto relation.

Lemma 21. [19] *If G is a ELL proof net and $(e, P, T, p) \mapsto_G^* (f, Q, U, q)$, then $\partial(e) + |T|_! + |T|_? = \partial(f) + |U|_! + |U|_?$*

Proof. The only transitions which break this property are crossing $?D$ or $?N$. There can be no such transitions in a ELL proof net \square

Lemma 22. *If G is a ELL proof net and $B \rightsquigarrow_! B'$ then $\partial(B) > \partial(B')$*

Proof. If $B \rightsquigarrow_! B'$, there exists $P, P' \in Pot$, $T' \in Tra$ and $s \in Sig$ such that $(\sigma(B), P, !_s, +) \rightsquigarrow_! (\sigma(B'), P', T', -)$. According to lemma 21, $\partial(\sigma(B)) + 1 = \partial(\sigma(B')) + |T'|_! + |T'|_?$.

The initial $!$ in the trace can not disappear along the path, so $|T'|_! \geq 1$. Moreover, the faithfulness of $(\sigma(B), P, !_s, +)$ is preserved along the path, so $(\sigma(B'), P', T', -)$ is faithful, the rightmost trace element of T' is a $?_t$ trace element, so $|T'|_? \geq 1$. So,

$$\begin{aligned} \partial(B) - 1 + 1 &\geq \partial(B') - 1 + 1 + 1 \\ \partial(B) &> \partial(B') \end{aligned}$$

\square

Theorem 8. *All ELL proof nets are principal door stratified, the strata of a box being bound by its depth (in terms of boxes inclusion).*

Proof. Let B be a box of G , a ELL proof net. Then the depth of B in terms of $\rightsquigarrow_!$ is finite and inferior or equal to $\partial(B)$. Indeed, let us suppose that $B \rightsquigarrow_! B_1 \rightsquigarrow_! \dots \rightsquigarrow_! B_n$, then $\partial(B) > \partial(B_1) > \dots > \partial(B_n) = 0$. So $n \leq \partial(B)$. \square

Thus, we can use theorem 6 to prove a strong elementary time bound on the reduction of ELL proof-net. This bound is not new. It was even already proved using context semantics [19]. However the stratification condition is much larger than ELL , as we will see in the next subsection with L^3 .

Notice that the strata only depends on the depth of the proof-net. So the height of the exponential tower depends only on the depth and maximal level of the proof-net. Moreover, the depth of a normalized proof-net representing a church numeral or a binary word are both bound by 1. So, if G is a proof-net whose only pending edge has type $!W_{LL} \multimap A$ (with $W_{LL} = \forall \alpha.!(\alpha \multimap \alpha) \multimap !(\alpha \multimap \alpha) \multimap !(\alpha \multimap \alpha)$ the type for binary words), then there exists an elementary function f such that **for all** normalized proof-net H of type $!W_{LL}$, the maximum number of steps to eliminate the *cut* in the application of G to H is bounded by $f(|E_H|)$. More details can be found in \square .

6.1.2 L^3 , the stratification through levels

L^3 (Linear Logic by Levels) is a system created by Baillot and Mazza [2] which generalizes ELL . The idea is that, to enforce an elementary bound on a proof-net, it is enough to show that some labelling (called levels) of the boxes is left unchanged by cut elimination. Thus, ELL is considered a special case where the levels are given by the depths of the box.

L^3 is the fragment of LL_0 containing exactly the proof-nets for which we can label each edge with an integer such that the labels verify the rules of figure 19.

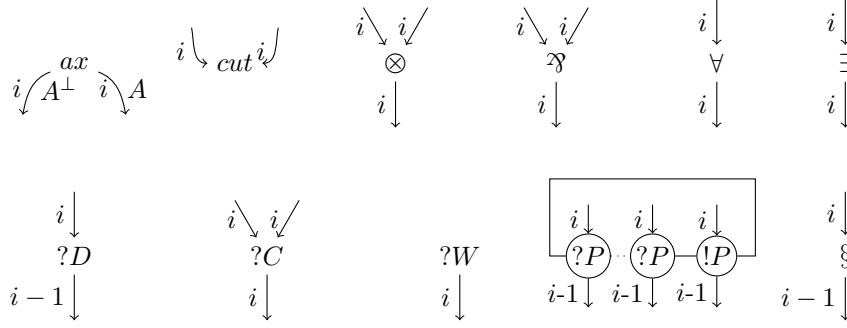

Figure 19: Relations between levels of neighbour edges in L^3

Similarly to the ELL case, the level of a box is unchanged through cut elimination. This property also has an equivalent in the context semantics presentation presented in lemma 23. Notice that the conservation of the quantity is only true for the \rightsquigarrow relation, not the \mapsto relation. This makes the reasonings on L^3 more complex and partly explains why there was no proof of a strong elementary bound for L^3 before this work.

Lemma 23. *If G is a L^3 proof net and $(e, P, T, p) \rightsquigarrow_G^* (f, Q, U, q)$, then $l(e) + |T|_! + |T|_? = l(f) + |U|_! + |U|_?$*

Proof. We can examine each \rightsquigarrow rule. It is straightforward to see that none of those rules break the property. \square

Lemma 24. *If G is a L^3 proof net and $B \rightsquigarrow_! B'$ then $l(\sigma(B)) > l(\sigma(B'))$*

Proof. If $B \rightsquigarrow_! B'$, there exists $P, P' \in Pot$, $T' \in Tra$ and $s \in Sig$ such that $(\sigma(B), P, !_s, +) \rightsquigarrow_! (\sigma(B'), P', T', -)$. According to lemma 23, $l(\sigma(B)) + 1 = l(\sigma(B')) + |T'|_! + |T'|_?$.

The initial $!$ in the trace can not disappear along the path, so $|T'|_! \geq 1$. Moreover, the faithfulness of $(\sigma(B), P, !_s, +)$ is preserved along the path, so $(\sigma(B'), P', T', -)$ is faithful, the rightmost trace element of T' is a $?_t$ trace element, so $|T'|_? \geq 1$. So,

$$\begin{aligned} l(\sigma(B)) + 1 &\geq l(\sigma(B')) + 1 + 1 \\ l(\sigma(B)) &> l(\sigma(B')) \end{aligned}$$

\square

Theorem 9. *All L^3 proof nets are stratified, the strata of a box being bound by the level of its principal door*

Proof. Let B be a box of G , a L^3 proof net. Then the depth of B in terms of $\rightsquigarrow_!$ is finite and inferior or equal to $l(B)$. Indeed, let us suppose that $B \rightsquigarrow_! B_1 \rightsquigarrow_! \dots \rightsquigarrow_! B_n$, then $l(B) > l(B_1) > \dots > l(B_n) = 0$. So $n \leq l(B)$. \square

Corollary 3. *Let G be a L^3 proof-net, the length of any cut elimination sequence is inferior to $a_{l(G)+4}^{|E_G|}$ with $a = \max(2, d^{\hat{c}(G)})$ and $d = \max_{B \in B_G} (D_G(B))$.*

As in the ELL case, the height of the tower only depends on a single parameter : the maximum level of the proof-net. The level of normalized proof-net representing natural numbers or binary numbers is exactly 1, so a proof-net of L^3 representing a function on natural numbers or binary words (in church encoding) normalizes indeed in an elementary function on the size of its argument.

Contrary to the *ELL* case, this result is new. There has been a weak elementary bound proved in [2] for a very particular strategy, but no strong bound. This strong bound is important if we want to base a type system for λ -calculus on L^3 , because it is unclear whether the strategy of [2] on proof nets could be translated into a β -reduction strategy for λ -calculus.

6.2 Polynomial bounds

6.2.1 *LLL* : *ELL* restricted to one auxiliary door boxes

LLL [10] is a milestone in the implicit complexity field. Though *BLL* [14] was the first subsystem of linear logic characterizing polynomial time, *BLL* was not totally implicit because it was based on polynomial indexing the formulae. So *LLL* is the first totally implicit characterization of polynomial time based on linear logic. In order to obtain polynomial time soundness, Girard restricts linear logic in multiple ways : $?N$ and $?D$ are forbidden (so *LLL* is a subsystem of *ELL*) and we allow at most one auxiliary door by box.

This system may be the most studied system among the linear logic based systems in implicit computational complexity. Therefore, there are already several proofs of the strong polynomial bound it entails. One of those is already done in the context semantics framework [19]. So, as in the *ELL* case, the following proof is not new at all. We include it because it is simpler (and easier to understand) than the next examples.

Lemma 25. *Let G be a *LLL* proof-net, $\forall B, C \in B_G, B \succ_k C \Rightarrow k \leq 1$*

Proof. As a first step, we will prove the following property : $\forall (C, Q) \in Pot(B_G), \sum_{(B, P) \succ_k^1 (C, Q)} k \leq 1$. Suppose there are two potential boxes (B_1, P_1) and (B_2, P_2) such that $(B_1, P_1) \succ_{k_1}^1$ and $(B_2, P_2) \succ_{k_2}^1$. Box C has only one auxiliary door (by definition of *LLL*) so, $(\sigma(B_1), P_1, !_{t_1}, +) \rightsquigarrow^* (\sigma_0(C), Q, !_e, -)$ and $(\sigma(B_2), P_2, !_{t_2}, +) \rightsquigarrow^* (\sigma_0(C), Q, !_e, -)$. However, \rightsquigarrow^* is bideterministic so $(B_1, P_1) = (B_2, P_2)$. To prove that k is always ≤ 1 , we use the same argument.

Then to prove the lemma, we suppose that there exists two sequels : $(B, P) \succ_{k_1}^1 \dots \succ_{k_n}^1 (B_n, P_n) \succ \dots \succ (C, Q)$ and $(B, P) \succ_{k'_1}^1 \dots \succ_{k'_{n'}}^1 (B'_{n'}, P'_{n'}) \succ (C, Q)$. We can prove by induction on i that $(B_{n-i}, P_{n-i}) = (B'_{n'-i}, P'_{n'-i})$ and $k'_{n'-i} = k_{n-i} = 1$. This proves that the sum in the definition of $B \succ C$ has at most one term and this term is 1. \square

It is then immediate that the *LLL* proof-nets finish in polynomial time. The polynome only depends on the depth of the proof net. The depth of cut-free binary words (in the church encoding) is bounded by 1, so for any proof-net G of *LLL* representing a function on binary words, there exists a polynomial p such that the number of steps to reduce G applied to H (H being a cut-free proof-net representing a word of size n) is inferior to $p(n)$.

6.2.2 L^4

L^4 [2] is to L^3 what *LLL* is to *ELL* : L^4 is defined as the fragment of L^3 where all the $!$ boxes have at most one auxiliary door. The proof-net are stratified because all L^3 proof-nets are, and the dependence control can be proved as in the *LLL* case, it gives us the following theorem :

Theorem 10. *Let G be a L^4 proof-net of maximal level l , then the length of the longest reduction path is inferior to $(d \cdot |E_G|)^{(\partial \cdot (6 \cdot l + 11))^{l+1}}$ with $d = \max_{B \in B_G} D_G(B)$, $\partial = \max_{e \in E_G} \partial(e)$ and $l = \max_{e \in E_G} l(e)$.*

6.2.3 L_a^3

L_a^3 was the first attempt to relax the “one auxiliary door” condition [8]. It is defined as the subset of L^3 where : the level of the auxiliary doors of a box are greater or equal to the level of the principal door (with a maximum of one auxiliary door at the same level than the principal door).

Lemma 26. *Let G be a L_a^3 proof-net and $B \in B_G$, then $N(B) \leq l(B)$*

Proof. We will prove that if $B \geq_2^s C$, then $l(B) > l(C)$. The lemma will follow by induction.

Let us suppose that $B \geq_2^s C$, then there exists $P \in L_G(B)$, $Q \in L_G(C)$ and two sequences of \geq^s : $(B, P) \geq^s (B_0, P_0) \geq^s \dots \geq^s (B_n, P_n) \geq^s (C, Q)$ and $(B, P) \geq (B'_0, P'_0) \geq^s \dots \geq^s (B_{n'}, P_{n'}) \geq^s (C, Q)$. Let $i = \max\{j \in \mathbb{N} \mid \forall k \leq j, (B_{n-k}, P_{n-k}) = (B'_{n-k}, P'_{n-k})\}$, then either $l(B_{n-k-1}) > l(B_{n-k})$ or $l(B'_{n-k-1}) > l(B'_{n-k})$. The level of boxes is decreasing or stable during the remaining of the sequence, so $l(B) > l(C)$. \square

7 Strong polynomial bound for L_0^4

When Baillot and Mazza created L^4 , they noticed that \S commuted with every other connective (for example $\forall X, \forall Y, \S(X \otimes Y) \multimap (\S X \otimes \S Y)$ and $\forall X, \forall Y, (\S X \otimes \S Y) \multimap \S(X \otimes Y)$ are provable in L^4). Therefore, it was a pity to differentiate proof-nets which had not any computational difference. They created L_0^4 which can be considered as a modification of L^4 where all the \S connectives of the formulae are pushed down to the ground formulae and where all the \S links of the proof-nets are pushed up to the axioms.

Definition 23. L_0^4 is the subsets of LL_0 proof-nets where there is no \S (neither as connectives in the formulae nor as links in the proof-nets) and where all the ! boxes have at most one auxiliary door.

The commuting diagram of figure 20 is used in [2] to prove that L_0^4 captures *Ptime* in some sense. In the following, we will use it to prove a strong polynomial bound for L_0^4 . Basically, it shows that a calculus in L_0^4 can be simulated in η -expanded L_0^4 and that a calculus in η -expanded L_0^4 is the same that a calculus in L^4 . The strong polynomial bound result from the following inequality :

$$T_{G_0} \leq T_{G_1} \leq T_G \leq \text{poly}(|G|) \leq \text{poly}(|G_0|) \quad (12)$$

The polynomial will only depend of the depth, level of G_0 , and the size and depth of its formulas. Thus, when a L_0^4 is applied to binary strings in normal form, the length of the reduction is bounded by a fixed polynomial on the size of the argument string.

The diagram of figure 20 uses several functions $(-)_0, (-)_1, (-)^-$ on proof-nets and a relation \rightarrow_η on proof-nets, which we will define below. $(-)_0$ and $(-)_1$ were first defined in [2] (along with the definition of L_0^4). As in the original paper, we will first define $(-)_0$ and $(-)_1$ on formulae :

- $X_0 = X$
- $X_0^\perp = X^\perp$
- $(\S A)_0 = 1.(A_0)$
- $(-)_0$ commutes with all the other connectives

Similarly,

- $(i.X)_1 = \S^i X$
- $(i.X^\perp)_1 = \S^i X^\perp$
- $(-)_1$ commutes with all the other connectives

We will prove the inequalities of 12 one by one. Here are the ideas of the proof. The proofs will be detailed in the following subsections.

- $T_{G_0} \leq T_{G_1}$: the η -expansion increase locally the net, leaving the rest unchanged. T_G is a sum over edges. η -expansion will leave most terms unchanged ($L_{G_0}(v) = L_{G_1}(v)$) and add some terms in the sum.

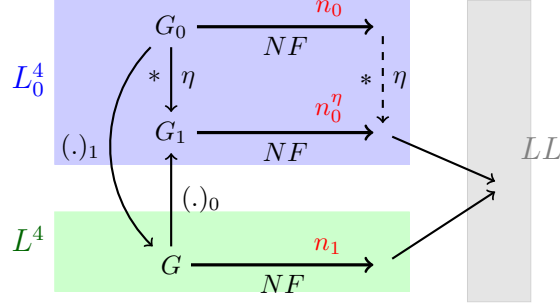

Figure 20: The computations of η -expanded L^4 and η -expanded L_0^4 are quite related.

- $T_{G_1} \leq T_G$: G_1 is exactly G without some ξ nodes. The reasoning is similar as above.
- $T_G \leq \text{poly}(|G|)$: theorem 10
- $\text{poly}(|G|) \leq \text{poly}(|G_0|)$: G is just G_0 η -expanded with ξ made explicit. We show that those operations do not increase the size of the net too much. The exact statement takes into account the level of G_0 , its depth and the maximum size of its formula.

7.1 η -expansion increases T : $T_{G_0} \leq T_{G_1}$

Lemma 27. *Let G_0 be a proof net. Suppose $G_0 \rightarrow_\eta G_1$, then $T_{G_0} \leq T_{G_1}$.*

Proof. We will define a copymorphism $(E_{G_0}, E'_{G_0}, \phi, \psi)$ from G_0 to G_1 . Were E'_{G_0} represent the edges of G_1 which have a canonical corresponding edge in E_{G_0} (the edges which are not dashed in figure ??). ϕ represents the canonical correspondence, and ψ is empty. We need to prove that this 4-uple is a copymorphism. All conclusions of $?D$ and $?W$ links of G_1 are in E'_{G_0} , as are the dangling edges of G_1 . So the only difficult point to prove is that the paths between canonical contexts are kept intact by ϕ . We have to prove that whenever $C = (e, P, T, -) \mapsto_{G_0} (f, P, T, +) = D$ (with e and f the two conclusions of the η -expanded axiom) then $(\phi(e), P, T, -) \mapsto_{G_1}^* (\phi(f), P, T, +)$.

If C is canonical, then $\beta(e, P, T, -)$ is well-defined. We will make a disjunction over the size of T :

- If it has length 1, then $T = !s$. So, $\beta(e) = ?A$ for some formula A (otherwise, $\beta(e, P, T, -)$ would be undefined). The η -expansion creates a box, and $(\phi(e), P, T, -) \leftrightarrow (\phi(f), P, T, +)$.
- Else, let's suppose the first element is \mathfrak{A}_l (the other cases are similar), then $\beta(e) = A_l \otimes A_r$ (otherwise $\beta(e, P, T, -)$ would be undefined). So $(e, P, T, -) \mapsto_{G_1}^3 (f, P, T, +)$.

As proved in the subsection ??, $T_{G_1} - T_{G_0} = (T_{G_1}^1 - T_{G_0}^1) + (T_{G_1}^2 - T_{G_0}^2)$ with

$$\begin{aligned}
T_{G_0}^1 - T_{G_1}^1 &= \sum_{\substack{e \in E_{G_0} \cap D_\phi \\ P \in L_{G_0}(e)}} 1 - |\{t/\phi(e, P, t) = (_, _, e)\}| + \sum_{e \in E_{G_0} \cap \overline{D}_\phi} |L_{G_0}(e)| - \sum_{f \in E_{G_1} \cap \overline{D}'_\phi} |L_{G_0}(e)| \\
T_{G_0}^1 - T_{G_1}^1 &= \sum_{\substack{e \in E_{G_0} \cap D_\phi \\ P \in L_{G_0}(e)}} 1 - 1 + \sum_{e \in \emptyset} |L_{G_0}(e)| - \sum_{f \in E_{G_1} \cap \overline{D}'_\phi} |L_{G_0}(e)| \\
T_{G_0}^1 - T_{G_1}^1 &= - \sum_{f \in E_{G_1} \cap \overline{D}'_\phi} |L_{G_0}(e)| \\
T_{G_0}^1 - T_{G_1}^1 &< 0
\end{aligned}$$

and

$$\begin{aligned}
T_{G_0}^1 - T_{G_1}^2 &= 2 \left(\sum_{\substack{e \in P_{G_0} \cap D_\phi \\ P \in L_{G_0}(e) \\ s \in S_{G_0}(e, P) \\ (f, Q, t) = \phi(e, P, s)}} D_{G_0}(e) \cdot |s| - D_{G_1}(f) \cdot |t| + \sum_{\substack{e \in P_{G_0} \cap \overline{D_\phi} \\ P \in L_{G_0}(e) \\ s \in S_{G_0}(e, P)}} D_{G_0}(e) \cdot |s| \right) \\
T_{G_0}^1 - T_{G_1}^2 &= 2 \left(\sum_{\substack{e \in P_{G_0} \\ P \in L_{G_0}(e) \\ s \in S_{G_0}(e, P) \\ (f, Q, t) = \phi(e, P, s)}} D_{G_0}(e) \cdot |s| - D_{G_0}(e) \cdot |s| + \sum_{\substack{e \in \emptyset \\ P \in L_{G_0}(e) \\ s \in S_{G_0}(e, P)}} D_{G_0}(e) \cdot |s| \right) \\
T_{G_0}^1 - T_{G_1}^2 &= 0
\end{aligned}$$

So we have, as expected, $T_{G_0} \leq T_{G_1}$ □

Lemma 28. *If $G_1 = (G)_0$, then $T_{G_1} \leq T_G$*

Proof. The proof is quite similar to the proof of lemma 27, but easier. We consider the canonical mapping from G_1 to G and show that this is a copymorphism. The main point being the conservation of paths. And this conservation is shown using the $\beta(-, -, -, -)$ function on contexts. □

7.2 G is not much bigger than G_0

For purposes of concision, we will define for any proof-net G , $\max F(G) = \max_{e \in E_G} |\beta_G(e)|$ and $\max P(G) = \max(\max_{\substack{e \in E_{G_1} \\ \beta_{G_1}(e) = C[p.X]}} , \max_{\substack{e \in E_{G_1} \\ \beta_{G_1}(e) = C[p.X^\perp]}})$.

Lemma 29. *If $G_0 \rightarrow_\eta^* G_1$, then :*

- $|E_{G_1}| \leq |E_{G_0}| + 3 * |E_{G_0}| * \max F(G_0)$
- $l(G_1) \leq l(G) + |G| * \max F(G_0)$
- $\partial(G_1) \leq \partial(G) + |G| * \max F(G_0)$
- $\max F(G_1) = \max F(G_0)$

Proof. We first prove the following properties :

- If $G_0 \rightarrow_\eta G_1$, then $|E_{G_1}| + \frac{3}{2} * \sum_{\alpha_{G_1}(l)=ax} |\beta_{G_1}(l, -)| \leq |E_{G_0}| + \frac{3}{2} * \sum_{\alpha_{G_0}(l)=ax} |\beta_{G_0}(l, -)|$
- If $G_0 \rightarrow_\eta G_1$, then $l(G_1) + \sum_{\alpha_{G_1}(l)=ax} \frac{|\beta_{G_1}(l, -)|}{2} \leq l(G_0) + \sum_{\alpha_{G_0}(l)=ax} \frac{|\beta_{G_0}(l, -)|}{2}$
- If $G_0 \rightarrow_\eta G_1$, then $\partial(G_1) + \sum_{\alpha_{G_1}(l)=ax} \frac{|\beta_{G_1}(l, -)|}{2} \leq \partial(G_0) + \sum_{\alpha_{G_0}(l)=ax} \frac{|\beta_{G_0}(l, -)|}{2}$
- If $G_0 \rightarrow_\eta G_1$, then $\max F(G_1) = \max F(G_0)$

The expected results are then obtained because each η -expansion step decreases by at least 1, the quantity $\sum_{\alpha_{G_1}(l)=ax} |\beta_{G_1}(l, -)|$. □

Lemma 30. *If $(G)_0 = G_1$, then :*

- $|E_G| \leq |E_{G_1}| + |E_{G_1}| \cdot \max P(G_1)$
- $l(G) \leq l(G_1) + \max P(G_1)$
- $\partial(G) \leq \partial(G_1) + \max P(G_1)$
- $\max F(G) \leq \max F(G_1) \cdot \max P(G_1)$

Proof. It is enough to notice that, along a directed path (from an axiom l to a cut or dangling edge) of G the number of § link is exactly the index p which is assigned to the variables of l_1 (the link of G_1 corresponding to l) □

Theorem 11. *Let G be a L_0^A proof net, any reduction of G terminates in at most $p_{\partial(G), l(G), f(G)}(|G|)$ steps, with $p_{a,b,c}$ being a fixed polynomial for any $a, b, c \in \mathbb{N}^3$ and $f(G) = \max_{F \in E_G} \partial(F)$*

Proof. For matters of readability, we will write ∂ for $\partial(G)$, l for $l(G)$, f for $\max_{F \in E_G} |F|$ and d for $\max_{F \in E_G} \partial(F)$. Adding $_0$ or $_1$ to those symbols designate the corresponding notions for G_0 or G_1 .

$$\begin{aligned}
T_{G_0} &\leq T_{G_1} \text{ (lemma27)} \\
&\leq T_G \text{ (lemma28)} \\
&\leq (\partial \cdot |E_G|)^{(\partial \cdot (6 \cdot l + 11))^{l+1}} \text{ (theorem??)} \\
&\leq (l_1 \cdot \partial_1 \cdot |E_{G_1}|)^{(\partial \cdot (6 \cdot l_1 + f_1 + 11))^{l_1 + f_1 + 1}} \\
&\leq ((l_0 + f_0) \cdot (\partial_0 + f_0) \cdot (1 + 3 \cdot f_0) \cdot |E_{G_0}|)^{(\partial \cdot (6 \cdot l_0 + 7 \cdot f_0 + 11))^{l_0 + 2 \cdot f_0 + 1}}
\end{aligned}$$

□

References

- [1] K. Aehlig and H. Schwichtenberg. A syntactical analysis of non-size-increasing polynomial time computation. *ACM Transactions on Computational Logic (TOCL)*, 3(3):383–401, 2002.
- [2] P. Baillot and D. Mazza. Linear logic by levels and bounded time complexity. *Theoretical Computer Science*, 411(2):470–503, 2010.
- [3] P. Baillot and K. Terui. Light types for polynomial time computation in lambda calculus. *Information and Computation*, 207(1):41–62, 2009.
- [4] S. Bellantoni and S. Cook. A new recursion-theoretic characterization of the polytime functions. *Computational complexity*, 2(2):97–110, 1992.
- [5] A. Cobham. The intrinsic computational difficulty of functions. In *Proceedings of the International Conference on Logic, Methodology, and Philosophy of Science*, pages 24–30, 1965.
- [6] U. Dal Lago and M. Gaboardi. Linear dependent types and relative completeness. In *Logic in Computer Science (LICS), 2011 26th Annual IEEE Symposium on*, pages 133–142. IEEE, 2011.
- [7] V. Danos and J.B. Joinet. Linear logic and elementary time. *Information and Computation*, 183(1):123–137, 2003.
- [8] A. Dorman and D. Mazza. Linear logic by asymmetric levels. <http://www-lipn.univ-paris13.fr/~dorman/docs/%5BDorman,09%5DLinLogByAsymmetricLevels.pdf>, 2009.
- [9] G. Gentzen. Untersuchungen über das logische schließen. i. *Mathematische zeitschrift*, 39(1):176–210, 1935.

- [10] Jean-Yves Girard. Light linear logic. *Inf. Comput.*, 143(2):175–204, 1998.
- [11] J.Y. Girard. Une extension de l’interprétation de gödel a l’analyse, et son application a l’élimination des coupures dans l’analyse et la théorie des types. *Studies in Logic and the Foundations of Mathematics*, 63:63–92, 1971.
- [12] J.Y. Girard. Linear logic* 1. *Theoretical computer science*, 50(1):1–101, 1987.
- [13] J.Y. Girard. Geometry of interaction 1: Interpretation of system f. *Studies in Logic and the Foundations of Mathematics*, 127:221–260, 1989.
- [14] J.Y. Girard, A. Scedrov, and P.J. Scott. Bounded linear logic: a modular approach to polynomial-time computability. *Theoretical computer science*, 97(1):1–66, 1992.
- [15] G. Gonthier, M. Abadi, and J.J. Lévy. The geometry of optimal lambda reduction. In *Proceedings of the 19th ACM SIGPLAN-SIGACT symposium on Principles of programming languages*, pages 15–26. ACM, 1992.
- [16] M. Hofmann. Linear types and non-size-increasing polynomial time computation. *Information and Computation*, 183(1):57–85, 2003.
- [17] W.A. Howard. The formulae-as-types notion of construction. *To HB Curry: essays on combinatory logic, lambda calculus and formalism*, 44:479–490, 1980.
- [18] Y. Lafont. Soft linear logic and polynomial time. *Theoretical Computer Science*, 318(1-2):163–180, 2004.
- [19] Ugo Dal Lago. Context semantics, linear logic, and computational complexity. *ACM Trans. Comput. Log.*, 10(4), 2009.
- [20] D. Leivant. Ramified recurrence and computational complexity i: Word recurrence and poly-time. *Feasible Mathematics II*, pages 320–343, 1994.
- [21] D. Mazza. Linear logic and polynomial time. *Mathematical Structures in Computer Science*, 16(6):947–988, 2006.
- [22] B.C. Pierce. *Types and programming languages*. The MIT Press, 2002.
- [23] J. Reynolds. Towards a theory of type structure. In *Programming Symposium*, pages 408–425. Springer, 1974.
- [24] K. Terui. Light affine lambda calculus and polytime strong normalization. In *Logic in Computer Science, 2001. Proceedings. 16th Annual IEEE Symposium on*, pages 209–220. IEEE, 2001.