

The tree model of a meromorphic plane curve

Abdallah Assi*

Abstract.¹ We associate with a plane meromorphic curve f a tree model $T(f)$ based on its contact structure. Then we give a description of the y -derivative of f (resp. the Jacobian $J(f, g)$) in terms of $T(f)$ (resp. $T(fg)$). We also characterize the regularity of f in terms of its tree.

Introduction

Let \mathbb{K} be an algebraically closed field of characteristic 0, and let f, g be two monic reduced polynomial of $\mathbb{K}((x))[y]$ of degrees n, m . Let f_x, g_x (resp. f_y, g_y) be the x -derivative (resp. the y -derivative) of f, g , and let $J(f, g) = f_x g_y - f_y g_x$. Let, by Newton Theorem,

$$f(x, y) = \prod_{i=1}^n (y - y_i(x)), \quad g(x, y) = \prod_{j=1}^m (y - z_j(x))$$

where $(y_i(x))_{1 \leq i \leq n}$ and $(z_j(x))_{1 \leq j \leq m}$ are meromorphic fractional series in x .

The main objective of this paper is to give a description of f_y (resp. $J(f, g)$) when the contact structure of f (resp. fg) is given. Let $H(x, y) = \prod_{i=1}^a (y - Y_i(x))$ and $\bar{H}(x, y) = \prod_{j=1}^b (y - Z_j(x))$ be two irreducible polynomials of $\mathbb{K}((x))[y]$ and define the contact $c(H, \bar{H})$ of H with \bar{H} to be

$$c(H, \bar{H}) = \max_{i,j} O_x(Y_i - Z_j)$$

where O_x denotes the x -order (in particular, $c(H, H) = +\infty$). Let f be as above and define the contact set of f to be

$$C(f) = \{O_x(y_i - y_j) | 1 \leq i \neq j \leq n\}$$

*Université d'Angers, Mathématiques, 49045 Angers ceded 01, France, e-mail:assi@univ-angers.fr
Visiting address: American University of Beirut, Department of Mathematics, Beirut 1107 2020, Lebanon

¹2000 Mathematical Subject Classification:14H50,1499

Let $f = f_1 \dots f_{\xi(f)}$ be the factorization of f into irreducible components in $\mathbb{K}((x))[y]$. Given $M \in C(f)$, we define $C_M(f)$ to be the set of irreducible components of f such that $f_i \in C_M(f)$ if and only if $c(f_i, f_j) \geq M$ for some j (with the understanding that $c(f_i, f_i) \geq M$ if and only if $M \geq O_x(y - y')$ for some roots $y \neq y'$ of $f_i(x, y) = 0$). Given $f_i, f_j \in C_M(f)$, we say that $f_i R_M f_j$ if and only if $c(f_i, f_j) \geq M$. This defines an equivalence relation in $C_M(f)$. The set of points of the tree of f at the level M is defined to be the set of equivalence classes of R_M . The set of points defined this way -where two close points are connected with a segment of line and top points are assigned with arrows- defines the tree $T(f)$ of f :

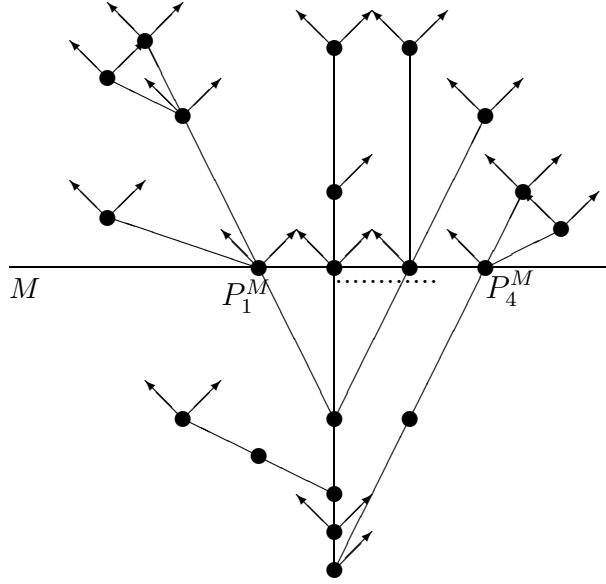

Let P_i^M be a point of the tree of f at the level M , and let \bar{f} be a monic polynomial of $\mathbb{K}((x))[y]$. We denote by $Q_{\bar{f}}(M, i)$ the product of irreducible components of \bar{f} whose contact with any element of P_i^M is M . It results from [8] that $\deg_y Q_{f_y}(M, i) > 1$, i.e. every point of $T(f)$ gives rise to a component of f_y . We give in Section 7., based on the results of Section 5., the y -degree of $Q_{f_y}(M, i)$ (see Proposition 7.6.), its intersection multiplicity as well as the contact of its irreducible components with $f_j, 1 \leq j \leq \xi(f)$ (see Theorem 7.7. and Theorem 8.9.). This result gives a generalization of Merle Theorem ($f \in \mathbb{K}[[x]][y]$ and $\xi(f) = 1$) (see Proposition 7.1.) and Delgado Theorem ($f \in \mathbb{K}[[x]][y]$ and $\xi(f) = 2$) (see Example 7.11.). These two results use the arithmetic of the semigroup associated with f , which does not help for meromorphic curves and, as shown by Delgado, does not seem to suffice when $f \in \mathbb{K}[[x]][y]$ and $\xi(f) \geq 3$.

Let $T(fg)$ be the tree of fg . A point P_i^M of $T(fg)$ is said to be an f -point (resp. a g -point) if P_i^M does not contain irreducible components of g (resp. f). A point of $T(fg)$ which is neither an f -point nor a g -point is called a mixed point. This gives us the following description of $T(fg)$:

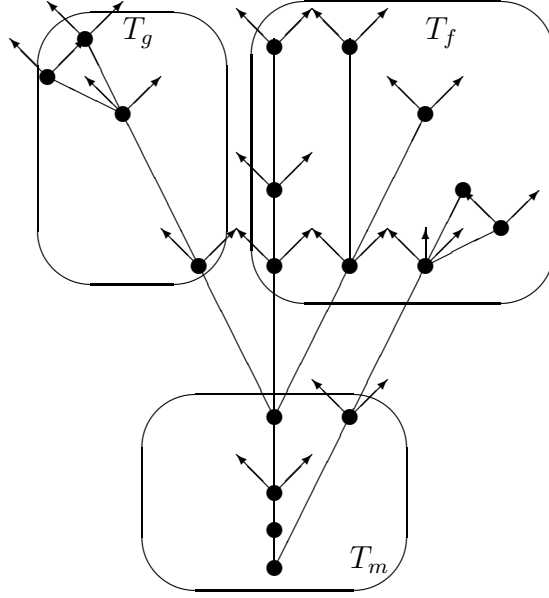

In Section 8, based on the results of Sections 4. and 5., we prove the following:

Theorem If P_i^M is an f -point (resp. a g -point), then $\deg_y Q_{J(f,g)}(M, i) > 1$.

We also give an explicit formula for $\deg_y Q_{J(f,g)}(M, i)$ and its intersection multiplicity as well as the contact of its irreducible components with each of the irreducible components of fg (see Theorem 8.4.).

As a consequence of this result, if $J(f, g) \in \mathbb{K}((x))$, then every point of $T(fg)$ is a mixed point.

Our explicit formulas for degrees, contacts and intersection multiplicities are given in terms of the invariants associated with the tree models of f, g and fg . They are obtained using the results of Section 5 and Section 6. Although these results are technical, we think that such precise formulas would be of interest for the study of problems such as the Jacobian conjecture in the plane.

The problem of the factorization of f_y and $J(f, g)$ has been considered by several authors, with a special attention to the analytical case. Beside the results of Merle and Delgado, García Barroso (see [7]) used the Eggers tree in order to get a decomposition of the generic polar of an analytic reduced curve (see [12] for the definition and the properties of the Eggers tree). In [9] and [10], Maugeudre computed the set of Jacobian quotients of a germ $(h_1, h_2) : (\mathbb{C}^2, 0) \mapsto (\mathbb{C}^2, 0)$ in terms of the minimal resolution of $h_1 h_2$.

Let the notations be as above, and assume that $f, g \in \mathbb{K}[x^{-1}][y]$. Let $F(x, y) = f(x^{-1}, y)$ and $G(x, y) = g(x^{-1}, y)$. For all $\lambda \in \mathbb{K}$, we denote by F_λ the polynomial $F - \lambda$. We say that the family $(F_\lambda)_{\lambda \in \mathbb{K}}$ is regular if the rank of the \mathbb{K} -vector space $\frac{\mathbb{K}[x, y]}{(F_\lambda, F_y)}$, denoted $\text{Int}(F - \lambda, F_y)$, does not depend on $\lambda \in \mathbb{K}$. When $(F_\lambda)_{\lambda \in \mathbb{K}}$ is not regular, there exists a finite number $\lambda_1, \dots, \lambda_s \in \mathbb{K}$

such that $\text{Int}(F - \lambda, F_y) > \text{Int}(F - \lambda_i, F_y)$ for λ generic and $1 \leq i \leq s$. The set $\{\lambda_1, \dots, \lambda_s\}$ is called the set of irregular values of $(F_\lambda)_{\lambda \in \mathbb{K}}$.

The regularity of a family of affine curves is related to many problems in affine geometry, in particular the plane Jacobian problem. If $(F_\lambda)_\lambda$ is regular and smooth, then F is equivalent to a coordinate of \mathbb{K}^2 . If $(F_\lambda)_\lambda$ is smooth with only one irregular value λ_1 , then $F - \lambda_1$ is reducible in $\mathbb{K}[x, y]$ and one of its irreducible components is equivalent to a coordinate of \mathbb{K}^2 . In general, nothing is known when $(F_\lambda)_\lambda$ has more than two irregular values (see [4] and references).

Suppose that F is generic in the family $(F_\lambda)_\lambda$. In particular, the intersection multiplicity of f with any irreducible component of f_y is less than 0. Let P_i^M be a point of $T(f)$. We say that P_i^M is a bad point if one of the irreducible components of $Q_{f_y}(M, i)$ has intersection multiplicity 0 with f . Otherwise, P_i^M is said to be a good point. Hence the tree $T(f)$ can be partitioned into bad and good points. In Section 9 we characterize the notion of regularity in terms of this partition. This, with the results of Section 2. is used in Section 10. in order to prove that the set of irregular values of f is bounded by the number of irreducible components $\xi(f)$ of f (or equivalently the set of irregular values of $(F_\lambda)_{\lambda \in \mathbb{K}}$ is bounded by the number of places of F at infinity).

The author would like to thank the referees for their valuable comments and suggestions.

1 Characteristic sequences

In this Section we shall recall some well known results about the theory of meromorphic curves (see [2] for example). Let

$$f = y^n + a_1(x)y^{n-1} + \dots + a_n(x)$$

be a monic irreducible polynomial of $\mathbb{K}((x))[y]$, where $\mathbb{K}((x))$ denotes the field of meromorphic series over \mathbb{K} . Let, by Newton Theorem, $y(t) \in \mathbb{K}((t))$ such that $f(t^n, y(t)) = 0$. If w is a primitive n th root of unity, then we have:

$$f(t^n, y) = \prod_{k=1}^n (y - y(w^k t)).$$

Write $y(t) = \sum_i a_i t^i$, and let $\text{supp}(y(t)) = \{i; a_i \neq 0\}$. Clearly $\text{supp}(y(t)) = \text{supp}(y(w^k t))$ for all $1 \leq k \leq n-1$. We denote this set by $\text{supp}(f)$ and we recall that $\text{gcd}(n, \text{supp}(f)) = 1$. If we write $x^{\frac{1}{n}}$ for t , then $y(x^{\frac{1}{n}}) = \sum a_i x^{\frac{i}{n}}$ and $f(x, y(x^{\frac{1}{n}})) = 0$, i.e. $y(x^{\frac{1}{n}})$ is a root of $f(x, y) = 0$. By Newton Theorem, there are n distinct roots of $f(x, y) = 0$, given by $y(w^k x^{\frac{1}{n}})$, $1 \leq k \leq n$. We denote the set of roots of f by $\text{Root}(f)$.

We shall associate with f its characteristic sequences $(m_k^f)_{k \geq 0}$, $(d_k^f)_{k \geq 1}$ and $(r_k^f)_{k \geq 0}$ defined by:

$|m_0^f| = d_1^f = |r_0^f| = n$, $m_1^f = r_1^f = \inf(\{i \in \text{supp}(f) \mid \gcd(i, n) < \min(i, n)\})$, and for all $k \geq 2$,
 $d_k^f = \gcd(m_0^f, \dots, m_{k-1}^f) = \gcd(d_{k-1}^f, m_{k-1}^f)$,
 $m_k^f = \inf\{i \in \text{supp}(f) \mid i \text{ is not divisible by } d_k^f\}$,

and $r_k^f = r_{k-1}^f \frac{d_{k-1}^f}{d_k^f} + m_k^f - m_{k-1}^f$.

Since $\gcd(n, \text{supp}(f)) = 1$, then there is $h_f \in \mathbb{N}$ such that $d_{h_f+1} = 1$. We denote by convention $m_{h_f+1}^f = r_{h_f+1}^f = +\infty$. The sequence $(m_k)_{0 \leq k \leq h_f}$ is also called the set of Newton-Puiseux exponents of f . We finally set $e_k^f = \frac{d_k^f}{d_{k+1}^f}$ for all $1 \leq k \leq h_f$.

Let H be a polynomial of $\mathbb{K}((x))[y]$. We define the intersection of f with H , denoted $\text{int}(f, H)$, by $\text{int}(f, H) = O_t H(t^n, y(t)) = n \cdot O_x H(x, y(x^{\frac{1}{n}}))$, where O_t (resp. O_x) denotes the order in t (resp. in x).

Let $p, q \in \mathbb{N}^*$, and let $\alpha(x) \in \mathbb{K}((x^{\frac{1}{p}}))$, $\beta(x) \in \mathbb{K}((x^{\frac{1}{q}}))$. We set

$$c(\alpha, \beta) = O_x(\alpha(x) - \beta(x))$$

and we call $c(\alpha, \beta)$ the contact of α with β . We define the contact of f with $\alpha(x)$ to be

$$c(f, \alpha) = \max_{1 \leq i \leq n} O_x(y_i(x) - \alpha(x))$$

where $\{y_1, \dots, y_n\} = \text{Root}(f)$.

Let $g = y^m + b_1(x)y^{m-1} + \dots + b_m(x)$ be a monic irreducible polynomial of $\mathbb{K}((x))[y]$ and let $\text{Root}(g) = \{z_1, \dots, z_m\}$. We define the contact of f with g to be

$$c(f, g) = c(f, z_1(x)).$$

Note that $c(f, g) = c(f, z_j(x)) = c(g, y_i(x))$ for all $1 \leq j \leq m$ and for all $1 \leq i \leq n$.

Remark 1.1 (see [1]) i) Let $f \in \mathbb{K}[[x]][y]$ (resp. $f \in \mathbb{K}[x^{-1}][y]$). The set of $\text{int}(f, g)$, $g \in \mathbb{K}[[x]][y]$ (resp. $g \in \mathbb{K}[x^{-1}][y]$) is a subsemigroup of \mathbb{Z} . We denote it by $\Gamma(f)$ and we call it the semigroup associated with f . With the notations above, $r_k^f > 0$ (resp. $r_k^f < 0$) for all $k = 0, \dots, h_f$, and $r_0^f, r_1^f, \dots, r_{h_f}^f$ generate $\Gamma(f)$. We write $\Gamma(f) = \langle r_0^f, r_1^f, \dots, r_{h_f}^f \rangle$.

ii) For all $1 \leq k \leq h_f$, e_k^f is the minimal integer such that $e_k^f r_k^f \in \langle r_0^f, r_1^f, \dots, r_{k-1}^f \rangle$.

iii) For all $1 \leq k \leq h_f$, there is a monic irreducible polynomial $g_k \in \mathbb{K}((x))[y]$ of degree $\frac{n}{d_k^f}$ in

y such that $c(f, g_k) = \frac{m_k^f}{n}$ and $\text{int}(f, g_k) = r_k^f$. Furthermore, $\Gamma(g_k) = \langle \frac{r_0^f}{d_k^f}, \frac{r_1^f}{d_k^f}, \dots, \frac{r_{k-1}^f}{d_k^f} \rangle$.

Lemma 1.2 (see [1]) Let $y(x) = \sum_i a_i x^{\frac{i}{n}} \in \text{Root}(f)$. Given $s \in \mathbb{N}^*$, let U_s denotes the group of the s th roots of unity in \mathbb{K} . Set

$$R(i) = \{w \in U_n | c(y(x), y(wx)) = O_x(y(x) - y(wx)) \geq \frac{m_i^f}{n}\}$$

$$S(i) = \{w \in U_n | c(y(x), y(wx)) = O_x(y(x) - y(wx)) = \frac{m_i^f}{n}\}.$$

We have the following:

- i) For all $1 \leq i \leq h_f + 1$, $R(i) = U_{d_i^f}$. In particular, $\text{card}(R(i)) = d_i^f$.
- ii) For all $1 \leq i \leq h_f$, $S(i) = R(i) - R(i+1) = U_{d_i^f} - U_{d_{i+1}^f}$. In particular, $\text{card}(S(i)) = d_i^f - d_{i+1}^f$.

Proof. Let $w \in U_n$, then $y(x) - y(wx) = \sum_k a_k (1 - w^k) x^{\frac{k}{n}}$. In particular, $O_x(y(x) - y(wx)) \geq \frac{m_i^f}{n}$ if and only if $w^k = 1$ for all $k < m_i^f$. This holds if and only if $w \in U_{d_i^f}$. ■

Remark 1.3 i) Let F be a nonzero monic polynomial of $\mathbb{K}((x))[y]$. Assume that F is reduced and let $F = F_1 \dots F_{\xi(F)}$ be the factorization of F into irreducible polynomials of $\mathbb{K}((x))[y]$. We define $\text{Root}(F)$ to be the union of $\text{Root}(F_i)$, $i = 1, \dots, \xi(F)$. Given a polynomial $G \in \mathbb{K}((x))[y]$, we set $\text{int}(F, G) = \sum_{i=1}^{\xi(F)} \text{int}(F_i, G)$.

ii) Let $p \in \mathbb{N}^*$, and let F be a nonzero monic polynomial of $\mathbb{K}((x^{\frac{1}{p}}))[y]$. Assume that F is reduced and let $x = X^p, y = Y$, and $\bar{F}(X, Y) = F(X^p, Y)$. The polynomial \bar{F} is a monic reduced polynomial of $\mathbb{K}((X))[Y]$. Let $\text{Root}(\bar{F}) = \{Y_1(X), \dots, Y_N(X)\}$. The set of roots of $F(x, y) = 0$ is $\{Y_1(x^{\frac{1}{p}}), \dots, Y_N(x^{\frac{1}{p}})\}$.

Let M be a given real number and consider the sequence $(m_k^f)_{1 \leq k \leq h_f + 1}$ of Newton-Puiseux exponents of f . We define the function $S(m^f, M)$ by putting

$$S(m^f, M) = \begin{cases} r_k^f d_k^f + (nM - m_k^f) d_{k+1}^f & \text{if } \frac{m_1^f}{n} \leq \frac{m_k^f}{n} \leq M < \frac{m_{k+1}^f}{n} \\ M d_1 & \text{if } M < \frac{m_1^f}{n} \end{cases}$$

Proposition 1.4 (see [1] or [8]) Let $g = y^m + b_1(x)y^{m-1} + \dots + b_m(x)$ be a monic irreducible polynomial of $\mathbb{K}((x))[y]$. We have the following:

$$\begin{aligned} c(f, g) = M & \quad \text{if and only if} \quad \text{int}(f, g) = S(m^f, M) \frac{m}{n} \\ c(f, g) < M & \quad \text{if and only if} \quad \text{int}(f, g) < S(m^f, M) \frac{m}{n} \\ c(f, g) > M & \quad \text{if and only if} \quad \text{int}(f, g) > S(m^f, M) \frac{m}{n} \end{aligned}$$

Let g_1, g_2 be two monic irreducible polynomials of $\mathbb{K}((x))[y]$ of degrees q_1 and q_2 respectively and let $(m_k^{g_i})_{1 \leq k \leq h_{g_i}}$ be the set of Newton-Puiseux exponents of g_i , $i = 1, 2$.

Lemma 1.5 (see [1]) Let $M = \min(c(f, g_2), c(f, g_1))$. We have the following:

- (i) $c(g_1, g_2) \geq M$.
- (ii) if $c(f, g_2) \neq c(f, g_1)$ then $c(g_1, g_2) = M$.

Lemma 1.6 Let the notations be as above and let $(m_k^g)_{1 \leq k \leq h_{g+1}}$ be the set of Newton-Puiseux exponents of g . Let $M = c(f, g)$ and assume that $M \geq \frac{m_1^f}{n}$. Let k be the greatest integer such

that $\frac{m_k^f}{n} = \frac{m_k^g}{m} \leq M$. We have the following:

- i) $\frac{n}{d_i^f} = \frac{m}{d_i^g}$ for all $i = 1, \dots, k + 1$.
- ii) $\frac{n}{d_{k+1}^f}$ divides m . In particular, if $k = h$ then n divides m .

Proof. ii) results from i), since by i), $m = \frac{n}{d_{k+1}^f} d_{k+1}^g$. On the other hand, let $1 \leq i \leq k$ and remark that $m \cdot n = n \cdot m, m \cdot m_1^f = n \cdot m_1^g, \dots, m \cdot m_{i-1}^f = n \cdot m_{i-1}^g$, in particular $m \cdot d_i^f = m \cdot \gcd(n, m_1^f, \dots, m_{i-1}^f) = n \cdot \gcd(q, m_1^g, \dots, m_{i-1}^g) = n \cdot d_i^g$. This proves i). ■

Lemma 1.7 Let the notations be as in Lemma 1.6. and let $y(x) \in \text{Root}(f)$ (resp. $z(x) \in \text{Root}(g)$) such that $c(y(x), z(x)) = M$. Write $y(x) = \sum_i c_i^f x^{\frac{i}{n}}$ and $z(x) = \sum_j c_j^g x^{\frac{j}{m}}$. If $M = \frac{m_{h_f}^f}{n}$ and $n \geq m$, then either c_{mM}^g -the coefficient of x^M in $z(x)$ - is 0, or $m = n$.

Proof. If $c_{mM}^g \neq 0$, then $M = \frac{m_{h_g}^g}{m}$, hence n divides m . This, with the hypotheses implies that $m = n$. ■

As a corollary we get the following:

Lemma 1.8 Let g_1, g_2 be two monic irreducible polynomials of $\mathbb{K}((x))[y]$ of degrees q_1, q_2 respectively, and assume that $c(g_1, f) = c(g_2, f) = \frac{m_{h(f)}^f}{n}$. If $q_1 < n$ and $q_2 < n$, then $c(g_1, g_2) > \frac{m_{h_f}^f}{n}$.

Proof. Let $y(x) \in \text{Root}(f)$ (resp. $z_1(x) \in \text{Root}(g_1)$, $z_2(x) \in \text{Root}(g_2)$) such that $c(y(x), z_1(x)) = c(y(x), z_2(x)) = \frac{m_{h_f}^f}{n}$. In particular $c(z_1(x), z_2(x)) \geq \frac{m_{h(f)}^f}{n}$. By Lemma 1.7., the coefficients $\frac{m_{h_f}^f}{n}$ of x in $z_1(x)$ and $z_2(x)$ are 0, which implies that $c(z_1(x), z_2(x)) > \frac{m_{h_f}^f}{n}$. This proves our assertion. ■

2 Equivalent and almost equivalent polynomials

Let f, g be two monic irreducible polynomials of $\mathbb{K}((x))[y]$, of degrees n, m in y . Let $(m_k^f)_{1 \leq k \leq h_f}$, $(d_k^f)_{1 \leq k \leq h_f}$, and $(r_k^f)_{0 \leq k \leq h_f}$ (resp. $(m_k^g)_{1 \leq k \leq h_g}$, $(d_k^g)_{1 \leq k \leq h_g}$, and $(r_k^g)_{0 \leq k \leq h_g}$) be the set of characteristic sequences of f (resp. of g).

Definition 2.1 i) We say that g is equivalent to f if the following holds:

- $h_f = h_g$
- $\frac{m_k^g}{m} = \frac{m_k^f}{n}$ for all $k = 1, \dots, h_f$.
- $c(f, g) \geq \frac{m_{h_f}^f}{n}$.

ii) We say that g is almost equivalent to f if the following holds:

- $h_f = h_g + 1$.
- $\frac{m_k^f}{n} = \frac{m_k^g}{m}$ for all $k = 1, \dots, h_g$.
- $c(f, g) = \frac{m_{h_f}^f}{n}$.

Lemma 2.2 Let the notations be as in Definition 2.1.

i) If g is equivalent to f , then $m = n$.

ii) If g is almost equivalent to f , then $m = \frac{n}{d_{h_f}^f}$. Furthermore, if $y(x) = \sum_p c_p x^{\frac{p}{m}} \in \text{Root}(g)$,

then $c_{\frac{m_{h_f}^f}{n}.m} = 0$.

Proof. i) results from Lemma 1.6. On the other hand, by the same Lemma, $m = a \frac{n}{d_{h_f}^f}$ for some $a \in \mathbb{N}^*$, but $\gcd(a \frac{n}{d_{h_f}^f}, \frac{a}{d_{h_f}^f} m_1^f, \dots, \frac{a}{d_{h_f}^f} m_{h_f-1}^f) = \frac{a}{d_{h_f}^f} d_{h_f}^f = 1$, hence $a = 1$. This proves the first assertion of ii). Now the least assertion results from Lemma 1.7. ■

Definition 2.3 Let $\{F_1, \dots, F_r\}$ be a set of monic irreducible polynomials of $\mathbb{K}((x))[y]$. Assume that $r > 1$ and let $n_{F_i} = \deg_y F_i$ for all $1 \leq i \leq r$.

- i) We say that the sequence (F_1, \dots, F_r) is equivalent if for all $1 \leq i \leq r$, F_i is equivalent to F_1 .
- ii) We say that the sequence (F_1, \dots, F_r) is almost equivalent if the following holds:
 - The sequence contains an equivalent subsequence of $r - 1$ elements.
 - The remaining element is almost equivalent to the elements of the subsequence.

Proposition 2.4 Let the notations be as in Definition 2.3. and let M be a rational number. If $c(F_i, F_j) = M$ for all $i \neq j$, then the sequence (F_1, \dots, F_r) is either equivalent or almost equivalent.

Proof. If $r = 1$, then there is nothing to prove. Assume that $r > 1$, and that $n_{F_1} = \max_{1 \leq k \leq r} n_{F_k}$.

- If $M > m_{h_{F_1}}^{F_1}$, then, by Lemma 1.6., ii), n_{F_1} divides n_{F_k} for all $1 \leq k \leq r$. In particular $n_{F_1} = n_{F_k}$ and F_k is equivalent to F_1 for all $1 \leq k \leq r$.

- Suppose that $M = \frac{m_{h_{F_1}}^{F_1}}{n_{F_1}}$, and that (F_1, \dots, F_r) is not equivalent. Suppose, without loss of generality, that F_2 is not equivalent to F_1 . By hypothesis, $M \geq \frac{m_{h_{F_2}}^{F_2}}{n_{F_2}}$ and $\frac{m_j^{F_1}}{n_{F_1}} = \frac{m_j^{F_2}}{n_{F_2}}$ for all $1 \leq j \leq h_{F_1} - 1$. Let $y(x) = \sum c_p x^{\frac{p}{n_{F_2}}} \in \text{Root}(F_2)$. If the coefficient of x^M in $y(x)$ is non zero, then n_{F_1} divides n_{F_2} , in particular $n_{F_2} = n_{F_1}$, and $\frac{m_{h_{F_1}}^{F_1}}{n_{F_1}} = \frac{m_{h_{F_2}}^{F_2}}{n_{F_2}}$. Hence F_1 is equivalent to F_2 , which is a contradiction. Finally $h_{F_2} = h_{F_1} - 1$, and $n_{F_2} = a \cdot \frac{n_{F_1}}{d_{h_{F_1}}^{F_1}}$, but $\gcd(n_{F_2}, m_1^{F_2}, \dots, m_{h_{F_2}}^{F_2}) = 1$, hence $a = 1$ and $n_{F_2} = \frac{n_{F_1}}{d_{h_{F_1}}^{F_1}}$. In particular F_2 is almost equivalent to F_1 . Let $k > 2$. If F_k is not equivalent to F_1 , then $n_{F_k} = n_{F_2} < n_{F_1}$ by the same argument as above. In particular, by Lemma 1.8., $c(F_1, F_2) > M$, which is a contradiction. Finally the sequence (F_1, \dots, F_r) is almost equivalent. ■

3 The Newton polygon of a meromorphic plane curve

In this Section we shall recall the notion of the Newton polygon of a meromorphic plane curve. More generally let $p \in \mathbb{N}$ and let $F = y^N + A_1(x)y^{N-1} + \dots + A_{N-1}(x)y + A_N(x)$ be a reduced polynomial of $\mathbb{K}((x^{1/p}))[y]$. For all $i = 0, \dots, N$, let $\alpha_i = O_x A_i(x)$. The Newton boundary of F is defined to be the boundary of the convex hull of $\bigcup_{i=1}^N (\alpha_i, i) + \mathbb{R}_+$.

Write $F(x, y) = \sum_{ij} c_{ij} x^{\frac{i}{p}} y^j$ and let $\text{Supp}(F) = \{(\frac{i}{p}, j) | c_{ij} \neq 0\}$, then the Newton boundary of

F is also the boundary of the convex hull of $\bigcup_{(\frac{i}{p}, j) \in \text{Supp}(F)} (\frac{i}{p}, j) + \mathbb{R}_+$.

We define the Newton polygon of F , denoted $N(F)$, to be the union of the compact faces of the Newton boundary of F . Let $\{P_k = (\alpha_{k_j}, k_j), k_0 > k_1 \dots > k_{v_F}\}$ be the set of vertices of $N(F)$. We denote this set by $V(F)$. We denote by $E(F) = \{\Delta_l^F = P_{k_{l-1}}P_{k_l}, l = 1, \dots, v_F\}$ the set of edges of $N(F)$. For all $1 \leq l \leq v_F$ we set $F_{\Delta_l^F} = \sum_{(\frac{i}{p}, j) \in \text{Supp}(F) \cap \Delta_l^F} c_{ij} x^{\frac{i}{p}} y^j$.

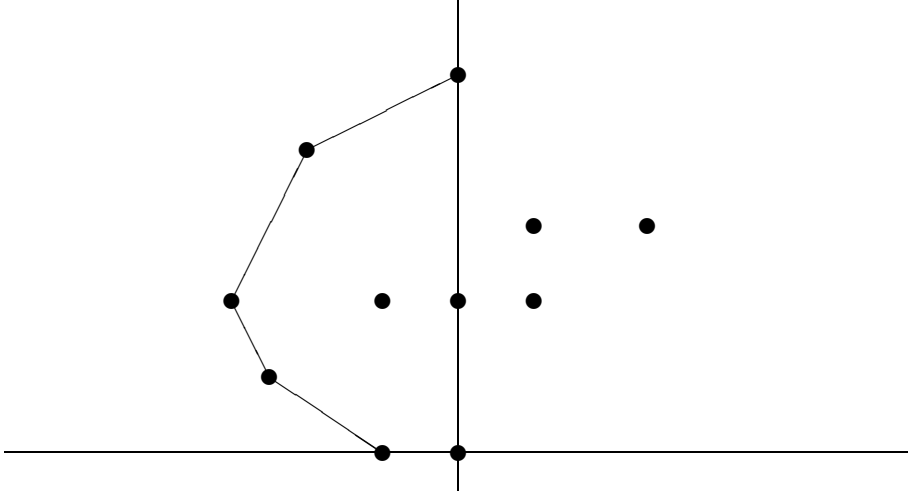

Lemma 3.1 Given $1 \leq l \leq v_F$, there is exactly $k_{l-1} - k_l$ elements of $\text{Root}(F)$, $y_j(x), 1 \leq j \leq k_{l-1} - k_l$, such that the following hold

i) $O_x(y_j(x)) = \frac{\alpha_{k_{l-1}} - \alpha_{k_l}}{k_{l-1} - k_l}$ for all j .

ii) The set of initial coefficients, denoted inco , of $y_1, \dots, y_{(k_{l-1}-k_l)}$ is nothing but the set of nonzero roots of $F_{\Delta_l^F}(1, y)$.

Conversely, given $y(x) \in \text{Root}(F)$, there exists Δ_l^F such that $O_x(y(x)) = \frac{\alpha_{k_{l-1}} - \alpha_{k_l}}{k_{l-1} - k_l}$.

We denote the set of x -orders of $\text{Root}(F)$ by $O(F)$, and we set $\text{Poly}(F) = \{F_{\Delta_l^F}(1, y) | 1 \leq l \leq v_F\}$.

Lemma 3.2 Let F be as above, and let M be a rational number. Define $L_M : \text{Supp}(F) \mapsto \mathbb{Q}$ by $L_M(\frac{i}{p}, j) = \frac{i}{p} + Mj$, and let $a_0 = \inf(L_M(\text{Supp}(F)))$. Let $\text{in}_M(F) = \sum_{\frac{i}{p} + Mj = a_0} c_{ij} x^{\frac{i}{p}} y^j$. We have the following:

i) $M \in O(F)$ if and only if $\text{in}_M(F)$ is not a monomial. In this case, $M = \frac{\alpha_{k_{l-1}} - \alpha_{k_l}}{k_{l-1} - k_l}$ for some $1 \leq l \leq v_F$, and $\text{in}_M(F) = F_{\Delta_l^F}$. Furthermore, $(a_0, 0)$ is the point where the line defined by $(\alpha_{k_{l-1}}, k_{l-1})$ and (α_{k_l}, k_l) intersects the x -axis.

ii) Consider the change of variables $x = X, y = X^M Y$ and let $\bar{F}(X, Y) = F(X, X^M Y)$. We have $\bar{F} = \sum c_{ij} x^{\frac{i}{p} + Mj} = x^{a_0} F_{\Delta_l^F}(1, y) + \sum_{a > a_0} x^a P_a(y)$.

Proof. Easy exercise. ■

The following two lemmas give information about the Newton polygons of the y -derivative (resp. the Jacobian) of a meromorphic curve (resp. the Jacobian of two meromorphic curves).

Lemma 3.3 Let F be as above and let $N(F)$ be the Newton polygon of F . Let $V(F) = \{P_k = (\alpha_{k_l}, k_l), k_0 > k_1 \dots > k_{v_F}\}$ be the set of vertices of F and assume that $k_{v_F} = 0$, i.e. $N(F)$ meets the x -axis. Assume that $(\alpha^1, 1) \in \text{Supp}(F_{\Delta_{v_F}^F})$ for some $\alpha^1 \in \mathbb{Q}$, and that $(\alpha^1, 1) \notin V(F)$. We have the following

- i) $(\alpha^1, 0) \in V(F_y)$.
- ii) $N(F_y)$ is the translation of $N(F)$ with respect to the vector $(0, -1)$.
- iii) $O(F_y) = O(F)$, $v_F = v_{F_y}$.
- iv) $\deg_y F_{\Delta_{v_F}^F} = \deg_y (F_y)_{\Delta_{v_F}^{F_y}} + 1$. In particular, if F has s roots whose order in x is $\frac{\alpha_{k_{v(F)-1}} - \alpha_{k_{v(F)}}}{k_{v_F-1}}$, then F_y has $s - 1$ roots with the same order in x .

Proof. The proof follows immediately from the hypotheses and Lemma 3.1. ■

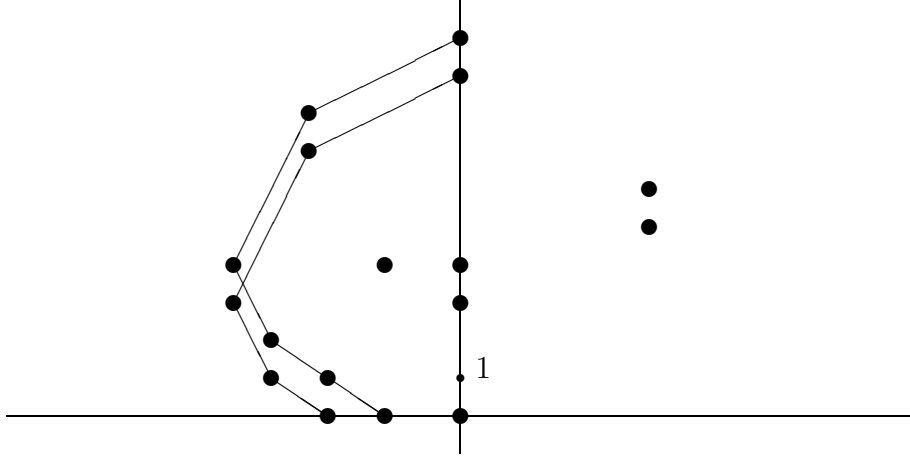

Lemma 3.4 Let $G = y^m + b_1(x)y^{m-1} + \dots + a_m(x)$ be a reduced polynomial of $\mathbb{K}((x^{\frac{1}{q}}))[y]$ and let $J = J(F, G) = F_x G_y - F_y G_x$ be the Jacobian of F and G . Let $V(G) = \{(\beta_{l_i}, l_i), l_0 > l_1 > \dots > l_{v_G}\}$ be the set of vertices of $N(G)$ and let $E(G) = \{\Delta_1^G, \dots, \Delta_{v_G}^G\}$ be the set of edges of $N(G)$. Assume that the following holds:

- i) $k_{v_F} = l_{v_G} = 0$, $\alpha_{v_F} \neq 0$ and $\beta_{v_G} \neq 0$, i.e. $N(F)$ and $N(G)$ meet the x -axis into points different from the origin.
- ii) $(\alpha^1, 1) \in \text{Supp}(F_{\Delta_{v_F}^F})$ (resp. $(\beta^1, 1) \in \text{Supp}(G_{\Delta_{v_G}^G})$) for some α^1 (resp. β^1) in \mathbb{Q} , and $(\alpha^1, 1) \notin V(F)$ (resp. $(\beta^1, 1) \notin V(G)$).
- iii) $\max(O(F)) > \max(O(G))$.

Then we have:

i) $\max(O(J)) = \max(O(F_y)) = \max(O(F))$.

ii) If $G_{\Delta_{v_G}^G}(x, 0) = ax^{\beta_{l_v G}}, a \in \mathbb{K}^*$, then $(\alpha^1 + \beta_{l_v G} - 1, 0) \in V(J)$ and $J_{\Delta_{v_J}^J} = (-F_y G_x)_{\Delta_{v_{F_y G_x}}^{F_y G_x}} = -a\beta_{l_r} \cdot x^{\beta_{l_r} - 1}(F_y)_{\Delta_{v_F}^{F_y}}$.

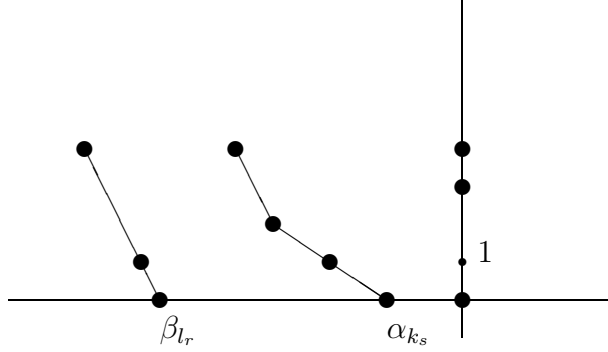

Proof. It follows from the hypotheses that $(\alpha_{v(F)} - 1, 0) \in V(F_x)$, $(\alpha^1, 0) \in V(F_y)$, $(\beta_{v(G)} - 1, 0) \in V(G_x)$, and $(\beta^1, 0) \in V(G_y)$. In particular $(\alpha_{v(F)} + \beta^1 - 1, 0) \in V(F_x G_y)$ and $(\beta_{v(G)} + \alpha^1 - 1, 0) \in V(F_y G_x)$. Since $\max(O(F)) > \max(O(G))$, then $\beta_{l_v G} - \beta^1 < \alpha_{k_{v(F)}} - \alpha^1$, in particular $\beta_{l_v G} + \alpha^1 - 1 < \alpha_{k_{v(F)}} + \beta^1 - 1$, and $(\beta_{l_v G} + \alpha^1 - 1, 0) \in V(J)$. A similar argument shows that the last edge of $J = F_x G_y - F_y G_x$ is nothing but the last edge of $-F_y G_x$, and that $(-F_y G_x)_{\Delta_{v_{F_y G_x}}^{F_y G_x}} = -a\beta_{l_r} \cdot x^{\beta_{l_r} - 1}(F_y)_{\Delta_{v_F}^{F_y}}$. ■

4 Deformation of Newton polygons and applications

Let $f = y^n + a_1(x)y^{n-1} + \dots + a_{n-1}(x)y + a_n(x)$ be a reduced monic polynomial of $\mathbb{K}((x))[y]$ and let $\text{Root}(f) = \{y_1, \dots, y_n\}$. Let $f_1, \dots, f_{\xi(f)}$ be the set of irreducible components of f in $\mathbb{K}((x))[y]$.

Definition 4.1 Let N be a nonnegative integer and let $\gamma(x) = \sum_{k \geq k_0} a_k x^{\frac{k}{N}} \in \mathbb{K}((x^{\frac{1}{N}}))$. Let M be a real number. We set

$$\gamma_{<M} = \begin{cases} \sum_{k \geq k_0, \frac{k}{N} < M} a_k x^{\frac{k}{N}} & \text{if } M > \frac{k_0}{N} \\ 0 & \text{otherwise} \end{cases}$$

and we call $\gamma_{<M}$ the $< M$ -truncation of $\gamma(x)$.

Let θ be a generic element of \mathbf{K} . We set

$$\gamma_{<M, \theta} = \begin{cases} \sum_{k \geq k_0, \frac{k}{N} < M} a_k x^{\frac{k}{N}} + \theta \cdot x^M & \text{if } M \geq \frac{k_0}{N} \\ \theta \cdot x^M & \text{otherwise} \end{cases}$$

and we call $\gamma_{<M,\theta}$ the M -deformation of $\gamma(x)$.

Let N be a nonnegative integer and let $\gamma(x) \in \mathbb{K}((x^{\frac{1}{N}}))$. Let M be a real number and let $\gamma_{<M}$ be the $< M$ -truncation of $\gamma(x)$. Consider the change of variables $X = x, Y = y - \gamma_{<M}$. The polynomial $F(X, Y) = f(X, Y + \gamma_{<M})$ is a monic polynomial of degree n in Y whose coefficients are fractional meromorphic series in X . Let $V(F) = \{P_i = (\alpha_{k_i}, k_i) | i = 1, \dots, v_F\}$ and let $E(F) = \{\Delta_1^F, \dots, \Delta_{v_F}^F\}$.

Lemma 4.2 Let the notations be as above. Assume that $\gamma \notin \text{Root}(f)$ and let $M = \max_{1 \leq j \leq n} c(\gamma, y_j)$. We have the following:

- i) $\text{Root}(F(X, Y)) = \{Y_k = y_k - \gamma_{<M}, k = 1, \dots, n\}$.
- ii) $O(F) = \{c(y_k, \gamma) | k = 1, \dots, n\}$.
- iii) There is exactly $k_i - k_{i+1}$ roots $y(x)$ of F whose contact with γ is $\frac{\alpha_i - \alpha_{i-1}}{k_i - k_{i-1}}$.
- iii) The initial coefficients of $\text{Root}(F)$, denoted $\text{inco}(F)$, is $= \{\text{inco}(y_k - \gamma) | k = 1, \dots, n\}$.

In particular, the Newton polygon $N(F)$ gives us a complete information about the relationship between $\gamma(x)$ with the roots of f . We call it the Newton polygon of f with respect to $\gamma(x)$, and we denote it by $N(f, \gamma)$.

Proof. We have

$$F(X, Y) = f(X, Y + \gamma(X)) = \prod_{k=1}^n (Y + \gamma(X) - y_k(X))$$

now use Lemma 3.1. ■

Lemma 4.3 Let $y_i(x)$ be a root of $f(x, y) = 0$ and let

$$M = \max_{j \neq i} c(y_i, y_j).$$

Let $\tilde{y}_i = y_{i < M, \theta} = (y_i)_{<M}(x) + \theta x^M$ be the M -deformation of y_i and consider the change of variables $X = x, Y = y - \tilde{y}_i(X)$. Let $F(X, Y) = f(X, Y + \tilde{y}_i(X))$. We have the following:

- i) $O(F) = \{c(y_j - y_i) | j \neq i\}$.
- ii) $M = \max(O(F))$.
- iii) The last vertex of $N(F)$ belongs to the x -axis.
- iv) Let $\Delta_{v_F}^F$ be the last edge of $N(F)$. We have $(\alpha^1, 1) \in \text{Supp}(F_{\Delta_{v_F}^F})$ for some α^1 . Furthermore, $(\alpha^1, 1) \notin V(F)$.

Proof. We have

$$F(X, Y) = f(X, Y + \tilde{y}_i(X)) = \prod_{k=1}^n (Y + (y_i)_{<M}(X) + \theta X^M - y_k(X))$$

and by hypothesis, $O((y_i)_{<M}(X) + \theta X^M - y_k(X)) = O(y_i(X) - y_k(X))$ for all $k \neq i$. Furthermore, $O((y_i)_{<M}(X) + \theta X^M - y_i(X)) = M = O(y_i(X) - y_j(X))$ for some $j \neq i$. This implies i) and ii). Now $F(X, 0) = \prod_{k=1}^n ((y_i)_{<M}(X) + \theta X^M - y_k(X)) \neq 0$, hence iii) follows. Let $\Delta_{v_F}^F$ be the last edge of $N(F)$ and let y_{j_1}, \dots, y_{j_l} be the set of roots of f such that $c(y_i - y_{j_k}) = M$ for all $k = 1, \dots, l$. Write $y_i = \sum_p c_p^i x^p$ and let $y_i - y_{j_k} = c_{a_k} x^M + \dots$ for all $k = 1, \dots, l$. It follows that $(Y_i)_{<M}(X) + \theta x^M - y_{j_k}(X) = (c_{a_k} + \theta)x^M + \dots$. Finally $F_{\Delta_{v_F}^F} = (y - (c_M + \theta)x^M) \prod_{k=1}^l (y - (c_{a_k} + \theta)x^M)$. Since θ is generic and $l \geq 1$, then iv) follows immediately. ■

In particular, using the results of Section 3., the last vertex of $N(F_Y)$ is $(\alpha^1, 0)$, $O(F) = O(F_y)$, and $\max(O(F_Y)) = M$. But $F_Y(X, Y) = f_y(X, Y + \tilde{y}_i(X))$. This with the above Lemma led to the following Proposition (see also [8], Lemma 3.3.):

Lemma 4.4 For $y_i(x), y_j(x), i \neq j$, there is a root $z_k(x)$ of $f_y(x, y) = 0$ such that

$$c(y_i(x), y_j(x)) = c(y_i(x), z_k(x)) = c(y_j(x), z_k(x)).$$

Conversely, given $y_i(x), z_k(x)$, there is $y_j(x)$ for which the above equality holds. Moreover, given $y_i(x)$ and $M \in \mathbb{R}$,

$$\text{card}\{y_j(x) | c(y_i(x), y_j(x)) = M\} = \text{card}\{z_k(x) | c(y_i(x), z_k(x)) = M\}.$$

Proof. Let $i \neq j$ and let $M = c(y_i - y_j)$. Let $\tilde{y}_i = (y_i)_{<M} + \theta x^M$ be the M -deformation of y_i . Consider, as in Lemma 4.3., the change of variables $X = x, Y = y - \tilde{y}_i(X)$ and let $F(X, Y) = f(X, Y + \tilde{y}_i(X))$. It follows from Lemma 4.3. that $F(X, 0) \neq 0$, and if $\deg_y F_{\Delta_{v_F}^F} = r + 1$, then there is r roots y_{j_1}, \dots, y_{j_r} of $f(x, y) = 0$ such that $c(y_i - y_{j_k}) = M$ for all $k = 1, \dots, r$. Since $(\alpha^1, 0) \in \text{Supp}(F_{\Delta_{v_F}^F})$ for some α^1 , then the cardinality of $E(F_y)$ is the same as the cardinality of $E(F)$. Furthermore, $N(F_y)$ is a translation of $N(F)$ with respect of the vector $(0, -1)$. Finally, $(F_y)_{\Delta_{v_F}^F} = (F_{\Delta_{v_F}^F})_y$ is a polynomial of degree r in y . In particular, by Lemma 4.3., there is r roots of $f_y(x, y) = 0$ whose contact with y_i is M . This completes the proof of the result. ■

Let $g = y^m + a_1(x)y^{m-1} + \dots + a_m(x)$ be a reduced monic polynomial of $\mathbb{K}((x))[y]$ and denote by z_1, \dots, z_m the set of roots of g . Let $y_i(x) \in \text{Root}(f)$ and let:

$$M = \max(\{c(y_i, y_j) | j \neq i\} \cup \{c(y_i, z_k) | k = 1, \dots, m\})$$

Lemma 4.5 Let the notations be as above, and assume that $M > \max_{1 \leq k \leq m} c(y_i, z_k)$. Let $\tilde{y}_i = (y_i)_{<M} + \theta x^M$ be the M -deformation of y_i and consider the change of variables $X =$

$x, Y = y - \tilde{y}_i(X)$. Let $F(X, Y) = f(X, Y + \tilde{y}_i(X))$, $G(X, Y) = g(X, Y + \tilde{y}_i(X))$. We have the following

i) $F(X, 0) \neq 0$ and $G(X, 0) \neq 0$, i.e. $N(F)$ and $N(G)$ meet the x -axis.

ii) $\max(O(F)) = M > \max(O(G))$

iii) If $\Delta_{v_F}^F$ (resp. $\Delta_{v_G}^G$) denotes the last edge of $N(F)$ (resp. $N(G)$) then $(\alpha^1, 1) \in \text{Supp}(F_{\Delta_{v_F}^F})$ (resp. $(\beta^1, 1) \in \text{Supp}(G_{\Delta_{v_G}^G})$) for some α^1 (resp. β^1), and $(\alpha^1, 1) \notin V(F)$ (resp. $(\beta^1, 1) \notin V(G)$).

Proof. Let $F(X, Y) = \prod_{j=1}^n (Y - Y_j(X))$ and $G(X, Y) = \prod_{k=1}^m (Y - Z_k(X))$. Clearly $Y_j(X) = y_j(X) - (y_i)_{<M}(X) + \theta X^M$, $Z_k(X) = z_k(X) - (y_i)_{<M}(X) + \theta X^M$. In particular, for all $k = 1, \dots, m$, $O(Z_k) = c(y_i, z_k) < M$. On the other hand, for all $j \neq i$, $O(Y_j) = c(y_i, y_j) \leq M$ with equality for at least one j , and $O(Y_i) = M$. This implies i) and ii). Now iii) follows by a similar argument as in Lemma 4.3. ■

Let $J = J(f, g)$, and note that $J(F, G) = J(X, Y)$. In particular, by the results of the previous Section we get the following:

Lemma 4.6 For $y_i(x), y_j(x), i \neq j$, if $c(y_i, y_j) > \max_{1 \leq k \leq m} c(y_i, z_k)$, then there is a root $u_l(x)$ of $J(x, y) = 0$ such that

$$c(y_i(x), y_j(x)) = c(y_i(x), u_l(x))$$

Conversely, given $y_i(x), u_l(x)$, if $c(y_i, u_l) > c(y_i, z_k), k = 1, \dots, m$, there is $y_j(x)$ for which the above equality holds. Moreover, given $y_i(x)$ and $M \in \mathbb{R}$, if $M > \max_{1 \leq k \leq m} c(y_i, z_k)$, then:

$$\text{card}\{y_j(x) | c(y_i(x), y_j(x)) = M\} = \text{card}\{u_l(x) | c(y_i(x), u_l(x)) = M\}.$$

Proof. Let $M = c(y_i, y_j)$ and consider the change of variables $X = x, Y = y - \tilde{y}_i(X)$, where $\tilde{y}_i = (y_i)_{<M} + \theta x^M$ is the M -deformation of y_i . Let $F(X, Y) = f(X, Y + \tilde{Y}_i(X))$ and $G(X, Y) = g(X, Y + \tilde{Y}_i(X))$. It follows from the hypotheses that F and G satisfies conditions i), ii), and iii) of Lemma 3.4. In particular $J(X, Y)_{\Delta_{v(J(X, Y))}^{J(X, Y)}} = (G_{\Delta_{v(G)}}(X, 0))_X \cdot (F_{\Delta_{v(F)}})_Y$. The proof follows now by a similar argument as in Lemma 4.4. ■

5 Five main results

Let $f = y^n + a_1(x)y^{n-1} + \dots + a_n(x)$ be a monic reduced polynomial of $\mathbb{K}((x))[y]$ and let $f = f_1 \cdot f_2 \cdot \dots \cdot f_{\xi(f)}$ be the decomposition of f into irreducible components of $\mathbb{K}((x))[y]$. Let f_y be the y -derivative of f and let $\text{Root}(f) = \{y_1(x), \dots, y_n(x)\}$.

For all $1 \leq i \leq \xi(f)$, set $n_{f_i} = \deg_y(f_i)$, and let $(m_k^{f_i})_{1 \leq k \leq h_{f_i}+1}, (d_k^{f_i})_{1 \leq k \leq h_{f_i}+1}, (e_k^{f_i})_{1 \leq k \leq h_{f_i}}, (r_k^{f_i})_{1 \leq k \leq h_{f_i}+1}$ be the set of characteristic sequences of f_i .

Proposition 5.1 Assume that $\xi(f) = 1$, i. e. $f = f_1$ is irreducible. For all $1 \leq k \leq h_f$, we have:

$$\text{card}\{z(x) \in \text{Root}(f_y) | c(f, z(x)) = \frac{m_k^f}{n_f}\} = (e_k^f - 1) \frac{n_f}{d_k^f}.$$

Proof. Note that, by Lemma 4.4., $c(f, z(x)) \in \{\frac{m_1^f}{n_f}, \dots, \frac{m_{h_f}^f}{n_f}\}$. Assume first that $k = h_f$ and fix a root y_p of f . By Lemma 1.2., y_p has the contact $\frac{m_{h_f}^f}{n_f}$ with exactly $d_{h_f}^f - d_{h_f+1}^f = d_{h_f}^f - 1 = e_{h_f}^f - 1$ roots of f , consequently, by Lemma 4.4., there is $e_{h_f}^f - 1$ roots of f_y whose contact with y_p is $\frac{m_{h_f}^f}{n_f}$. Denote the set of these roots by D_p . Each element of D_p has the contact $\frac{m_{h_f}^f}{n_f}$ with exactly $d_{h_f}^f$ roots of f (since we have to add y_p). Denote this set by C_p . Let $y_q \notin C_p$ be a root of f . Repeating with y_q what we did for y_p , we construct D_q and C_q in a similar way. Obviously $C_p \cap C_q = \emptyset$ (otherwise, $c(y_p, y_q) = \frac{m_{h_f}^f}{n_f}$, which is impossible because $y_q \notin C_p$). This implies that $D_p \cap D_q = \emptyset \dots$. This process divides the n_f roots of f into $\frac{n_f}{d_{h_f}^f}$ disjoint groups

$C_1, \dots, C_{\frac{n_f}{d_{h_f}^f}}$ such that for all $1 \leq p \leq \frac{n_f}{d_{h_f}^f}$, C_p contains the roots of f having the contact $\frac{m_{h_f}^f}{n_f}$

with the elements of D_p . For all $z(x) \in D_p, c(f, z(x)) = \frac{m_{h_f}^f}{n_f}$, in particular

$$\text{card}\{z(x) \in \text{Root}(f_y) | c(f, z(x)) = \frac{m_{h_f}^f}{n_f}\} = \sum_{p=1}^{\frac{n_f}{d_{h_f}^f}} \text{card} D_p = (e_{h_f}^f - 1) \frac{n_f}{d_{h_f}^f}.$$

Assume that the equality is true for $k = h_f, \dots, j+1$, then there is exactly $\sum_{i=j+1}^{h_f} (e_i^f - 1) \frac{n_f}{d_j^f} = n_f - \frac{n_f}{d_j^f}$ roots of f_y having the contact $\geq \frac{m_j^f}{n_f}$ with f . We now repeat the same argument

with $\frac{n_f}{d_j^f}, \frac{d_j^f}{d_{j+1}^f} - 1$ instead of n_f and $d_{h_f}^f - 1$. ■

Proposition 5.2 Let $M \in \mathbb{Q}$ and let $1 \leq i \leq \xi(f)$. Assume that $M \neq \frac{m_k^{f_i}}{n_{f_i}}$ for all $k = 1, \dots, h_{f_i}$. We have:

$$\text{card}\{z(x) \in \text{Root}(f_y) | c(f_i, z(x)) = M\} = \text{card}\{y(x) \in \text{Root}(f) | c(f_i, y(x)) = M\} = \sum_{c(f_i, f_k)=M} n_{f_k}.$$

Proof. Let, without loss of generality, $i = 1$ and let $k > 1$ be such that $c(f_1, f_k) = M$. Fix a root $y_p(x)$ of f_1 . Since $c(y_p(x), f_k) = M$, then there is a root $y(x)$ of f_k such that $c(y_p(x), y(x)) = M$.

Let $\theta \in \{0, \dots, h_{f_1}\}$ be the smallest integer such that $M < \frac{m_{\theta+1}^{f_1}}{n_{f_1}}$ and consider another root $y_j(x)$ of f_1 . We have:

$$c(y_j, y(x)) = O_x(y_j - y(x)) = O_x(y_j - y_p + y_p - y(x)) = \begin{cases} M & \text{if } O_x(y_j - y_p) \geq \frac{m_{\theta+1}^{f_1}}{n_{f_1}} \\ O_x(y_j - y_p) & \text{if } O_x(y_j - y_p) < \frac{m_{\theta+1}^{f_1}}{n_{f_1}} \end{cases}$$

By Lemma 1.2., there is exactly $d_{\theta+1}^{f_1} - 1$ roots of f_1 having a contact $\geq \frac{m_{\theta+1}^{f_1}}{n_{f_1}}$ with y_p , consequently, by the formula above, there is exactly $d_{\theta+1}^{f_1}$ roots of f_1 having the contact M with $y(x)$ (since we have to add y_p). Denote this set by C_p and let D_k^p be the set of roots of f_k having the contact M with y_p . In particular an element of D_k^p has the contact M with every element of C_p .

Let $y_q \notin C_p$ be a root of f_1 and repeat the same construction with y_q instead of y_p . It is clear that $C_p \cap C_q = \emptyset$ (otherwise, if $\bar{y} \in C_p \cap C_q$, then $c(\bar{y}, y_p) = c(\bar{y}, y_q) = M$, in particular $c(y_p, y_q) \geq M$, which is a contradiction since $y_q \notin C_p$), in particular $D_k^p \cap D_k^q = \emptyset$. This process

divides the set of roots of f_k into disjoint $\frac{n_{f_1}}{d_{\theta+1}^{f_1}}$ groups $D_k^1, \dots, D_k^{\frac{n_{f_1}}{d_{\theta+1}^{f_1}}}$: for all $1 \leq p \leq \frac{n_{f_1}}{d_{\theta+1}^{f_1}}$, D_k^p contains the roots of f having the contact M with the elements of C_p . Repeating what we did with another f_l , $l \neq k$, such that $c(f_1, f_l) = M$, then adding the D_k^p 's, We obtain disjoint $\frac{n_{f_1}}{d_{\theta+1}^{f_1}}$ groups $D_1, \dots, D_{\frac{n_{f_1}}{d_{\theta+1}^{f_1}}}$ such that D_p contains the roots of f having the contact M with the elements of C_p . We have, by Lemma 4.4.

$$\text{card}\{z(x) \in \text{Root}(f_y) | c(y_p(x), z(x)) = M\} = \text{card}\{y(x) \in \text{Root}(f) | c(y_p(x), y(x)) = M\} = \text{card}D_p$$

Let $z(x) \in \text{Root}(f_y)$ and assume that $c(z(x), y_p) = M$. If $y_q \in \text{Root}(f)$, $y_q \neq y_p$, since $c(y_p, y_q) \neq M$, then $c(z(x), y_q) \leq M$. In particular $c(f_1, z(x)) = M$. Finally

$$\text{card}\{z(x) \in \text{Root}(f_y) | c(f_1, z(x)) = M\} = \sum_{p=1}^{\frac{n_{f_1}}{d_{\theta+1}^{f_1}}} \text{card}D_p = \sum_{c(f_1, f_k)=M} n_{f_k}$$

This proves our assertion. ■

Proposition 5.3 For all $1 \leq i \leq r$ and for all $1 \leq \theta \leq h_{f_i}$, we have:

$$\begin{aligned} \text{card}\{z(x) \in \text{Root}(f_y) | c(f_i, z(x)) = \frac{m_\theta^{f_i}}{n_{f_i}}\} &= \text{card}\{y(x) \in \text{Root}(f) | c(f_i, y(x)) = \frac{m_\theta^{f_i}}{n_{f_i}}\} + (e_\theta^{f_i} - 1) \frac{n_{f_i}}{d_\theta^{f_i}} \\ &= \sum_{c(f_i, f_k) = \frac{m_\theta^{f_i}}{n_{f_i}}} n_{f_k} + (e_\theta^{f_i} - 1) \frac{n_{f_i}}{d_\theta^{f_i}}. \end{aligned}$$

Proof. Let, without loss of generality, $i = 1$ and assume that $c(f_1, f_k) = \frac{m_\theta^{f_1}}{n_{f_1}}$ for at least one $k > 1$. Let y_p be a root of f_1 . Since $c(f_k, y_p) = \frac{m_\theta^{f_1}}{n_{f_1}}$, then there is a root $y(x)$ of f_k such that $c(y_p(x), y(x)) = \frac{m_\theta^{f_1}}{n_{f_1}}$. By Lemma 1.2., there is exactly $d_\theta^{f_1} - 1$ roots of f_1 having a contact $\geq \frac{m_\theta^{f_1}}{n_{f_1}}$ with y_p . Let $y_j(x)$ be a root of f_1 such that $c(y_p, y_j) \geq \frac{m_\theta^{f_1}}{n_{f_1}}$, then $c(y_j, y(x)) = O_x(y_j - y(x)) = O_x(y_j - y_p + y_p - y(x)) \geq \frac{m_\theta^{f_1}}{n_{f_1}}$. On the other hand, $c(y_j(x), y(x)) \leq c(f_1, f_k) = \frac{m_\theta^{f_1}}{n_{f_1}}$, hence $c(y_j, y(x)) = \frac{m_\theta^{f_1}}{n_{f_1}}$. Consequently, there is exactly $d_\theta^{f_1}$ roots of f_1 having the contact $\frac{m_\theta^{f_1}}{n_{f_1}}$ with $y(x)$. Denote this set by C_p and let D_p^k be the set of roots of f_k such that for all $y(x) \in D_p^k$, $c(y_p(x), y(x)) = \frac{m_\theta^{f_1}}{n_{f_1}}$. In particular, an element of D_p^k has the contact $\frac{m_\theta^{f_1}}{n_{f_1}}$ with every element of C_p .

Let $y_q \notin C_p$ be a root of f_1 and repeat the same construction with y_q instead of y_p . We have, by a similar argument as in Proposition 5.2., $C_p \cap C_q = \emptyset$ and consequently $D_p^k \cap D_q^k = \emptyset$. This divides the set of roots of f_k into disjoint $\frac{n_{f_1}}{d_\theta^{f_1}}$ groups $D_k^1, \dots, D_k^{\frac{n_{f_1}}{d_\theta^{f_1}}}$. Each element of D_k^p has the contact $\frac{m_\theta^{f_1}}{n_{f_1}}$ with the elements of C_p . Repeating the same argument with the set of f_l such that $c(f_1, f_l) = \frac{m_\theta^{f_1}}{n_{f_1}}$, then adding the D_p^k 's, we obtain disjoint $\frac{n_{f_1}}{d_\theta^{f_1}}$ groups $D_1, \dots, D_{\frac{n_{f_1}}{d_\theta^{f_1}}}$ such

that for all $1 \leq p \leq \frac{n_{f_1}}{d_\theta}$, D_p contains the roots of $\frac{f}{f_1}$ having the contact $\frac{m_\theta^{f_1}}{n_{f_1}}$ with the elements of C_p . We have, by Lemma 2.2. and Lemma 4.4.:

$$\begin{aligned} \text{card}\{z(x) \in \text{Root}(f_y) | c(y_p, z(x)) = \frac{m_\theta^{f_1}}{n_{f_1}}\} &= \text{card}\{y(x) | c(y_p, y(x)) = \frac{m_\theta^{f_1}}{n_{f_1}}\} \\ &= \text{card}D_p + (e_\theta^{f_1} - 1) \frac{n_{f_1}}{d_\theta^{f_1}} \end{aligned}$$

And by a similar argument as in Proposition 5.2.,

$$\begin{aligned} \text{card}\{z(x) \in \text{Root}(f_y) | c(f_1, z(x)) = \frac{m_\theta^{f_1}}{n_{f_1}}\} &= \left(\sum_{1 \leq p \leq \frac{n_{f_1}}{d_\theta^{f_1}}} \text{card}D_p \right) + (e_\theta^{f_1} - 1) \frac{n_{f_1}}{d_\theta^{f_1}} \\ &= \left(\sum_{c(f_1, f_k) = \frac{m_\theta^{f_1}}{n_{f_1}}} n_{f_k} \right) + (e_\theta^{f_1} - 1) \frac{n_{f_1}}{d_\theta^{f_1}} \end{aligned}$$

This proves our assertion. ■

Let $g = y^m + b_1(x)y^{m-1} + \dots + b_m(x)$ be a monic reduced polynomial of $\mathbb{K}((x))[y]$ and let $g_1, \dots, g_{\xi(g)}$ be the set of irreducible components of g in $\mathbb{K}((x))[y]$. Let $\text{Root}(g) = \{z_1, \dots, z_m\}$, and let $J = J(f, g)$ be the Jacobian of f and g .

Proposition 5.4 Let $M \in \mathbb{Q}$ and assume that $c(y(x), y'(x)) = M$ for some $y(x), y'(x) \in \text{Root}(f)$, and that $M > \max_{1 \leq j \leq m} c(y(x), z_j(x))$. Let $1 \leq i \leq \xi(f)$, and assume that $M \neq \frac{m_k^{f_i}}{n_{f_i}}$ for all $k = 1, \dots, h_{f_i}$. We have the following

$$\text{card}\{u(x) \in \text{Root}(J) | c(f_i, u(x)) = M\} = \text{card}\{y_j(x) | c(f_i, y_j(x)) = M\} = \sum_{c(f_i, f_k) = M} n_{f_k}.$$

Proof. The proof is similar to the proof of Proposition 5.2., where Lemma 4.4. is replaced by Lemma 4.6. ■

Proposition 5.5 Let $1 \leq \theta \leq h_{f_i}$ and assume that $\frac{m_\theta^{f_i}}{n_{f_i}} > \max_{1 \leq j \leq n, 1 \leq k \leq m} c((y_j(x), z_k(x)))$. We have the following

$$\text{card}\{u(x) \in \text{Root}(J) | c(f_i, u(x)) = \frac{m_\theta^{f_i}}{n_{f_i}}\} = \text{card}\{y(x) \in \text{Root}(f) | c(f_i, y(x)) = \frac{m_\theta^{f_i}}{n_{f_i}}\} + (e_\theta^{f_i} - 1) \frac{n_{f_i}}{d_\theta^{f_i}}$$

$$= \sum_{c(f_i, f_k) = \frac{m_{f_i}^{f_i}}{n_{f_i}}} n_{f_k} + (e_{\theta}^{f_i} - 1) \frac{n_{f_i}}{d_{\theta}^{f_i}}.$$

Proof. The proof is similar to the proof of Proposition 5.3., where Lemma 4.4. is replaced by Lemma 4.6. ■

6 The tree of contacts

Let f be a monic reduced polynomial in $\mathbb{K}((x))[y]$ and let $f = f_1 \dots f_{\xi(f)}$ be the factorization of f into irreducible components of $\mathbb{K}((x))[y]$. We define the set of contacts of f to be the set:

$$C(f) = \{c(f_p, f_q) | 1 \leq p \neq q \leq \xi(f)\} \cup \bigcup_{k=1}^{\xi(f)} \left\{ \frac{m_1^{f_k}}{n_{f_k}}, \dots, \frac{m_{h_{f_k}}^{f_k}}{n_{f_k}} \right\}$$

Let $C(f) = \{M_1, \dots, M_{t_f}\}$. The tree associated with f is constructed as follows:

Let $M \in C(f)$ and define $C_M(f)$ to be the set of irreducible components of f such that

$$f_p \in C_M(f) \Leftrightarrow c(f_p, f_q) \geq M \text{ for some } 1 \leq q \leq \xi(f)$$

with the understanding that $c(f_k, f_k) \geq M$ if and only if $\frac{m_i^{f_k}}{n_{f_k}} \geq M$ for some $1 \leq i \leq h_{f_k}$.

We associate with M the equivalence relation on the set $C_M(f)$, denoted R_M , and defined as follows:

$$f_p R_M f_q \text{ if and only if } c(f_p, f_q) \geq M.$$

We define the points of the tree $T(f)$ at the level M to be the set of equivalence classes of R_M , and we denote this set by $P_1^M, \dots, P_{s_M}^M$. We shall say that P_j^N dominates P_i^M , and we write $P_j^N \geq P_i^M$, if $P_j^N \subseteq P_i^M$. We shall say that P_j^N strictly dominates P_i^M , and we write $P_j^N > P_i^M$, if P_j^N dominates P_i^M , $P_i^M \neq P_j^N$, and $C(f) \cap]M, N[= \emptyset$. This defines an order on the set of points of $T(f)$ with a unique minimal element, denoted $P_1^{M_1}$. A point P_i^M is called a top point of $T(f)$ if it is maximal with respect to this order. We denote by $\text{Top}(f)$ the set of top points of $T(f)$.

Let P_i^M be a point of $T(f)$, and let $P_{i_1}^{N_1}, \dots, P_{i_t}^{N_t}$ be the set of points that strictly dominate P_i^M . We set $D_i^M = P_i^M - \bigcup_{l=1}^t P_{i_l}^{N_l}$. Clearly $\{P_{i_1}^{N_1}, \dots, P_{i_t}^{N_t}, D_i^M\}$ is a partition of P_i^M . Furthermore, for all $F \in D_i^M$ and for all $F \neq G \in P_i^M$, $c(F, G) = M$. We also have the following:

- i) if $F \in D_i^M$, then $M \geq \frac{m_{h_F}^F}{n_F}$

ii) $P_i^M \in \text{Top}(f)$ if and only if $P_i^M = D_i^M$.

If P_j^N strictly dominates P_i^M , then we link these two points by a segment of line. We define the set of edges of $T(f)$ to be the set of these segments. Given a point P_i^M , if $D_i^M \neq \emptyset$, then we associate with each $F \in D_i^M$ an arrow starting at the point P_i^M . Let $P_1^{M_1}, P_2^{M_2}, \dots, P_k^{M_k}$ be a set of points of $T(f)$ such that $P_{i_2}^{M_2}$ strictly dominates $P_1^{M_1}$, $P_{i_k}^{M_k} \in \text{Top}(f)$, and $P_{i_j}^{M_j}$ strictly dominates $P_{i_{j-1}}^{M_{j-1}}$ for all $3 \leq j \leq k$. The union of edges linking these points is called a branch of $T(f)$. Clearly, there are as many branches of $T(f)$ as there are top points of $T(f)$.

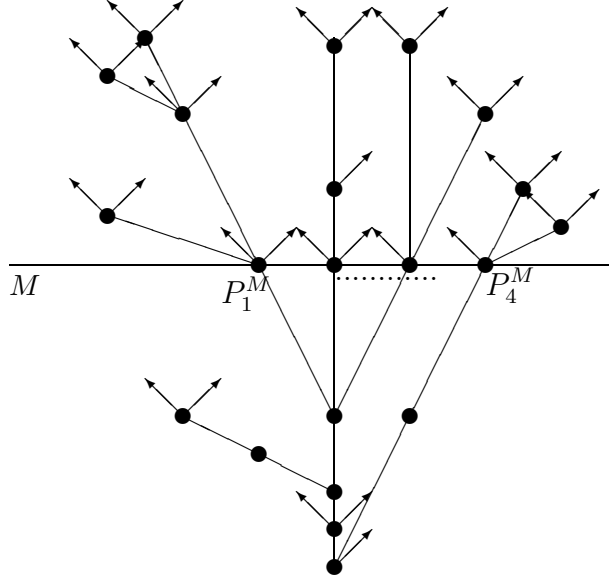

Lemma 6.1 Let P_i^M be a point of $T(f)$. We have the following:

- i) For all $F, G \in P_i^M$, $c(F, G) \geq M$.
- ii) For all $F \in P_i^M$ and for all $H \notin P_i^M$, $c(F, H) < M$.
- iii) For all $F, G \in P_i^M$ and for all $H \notin P_i^M$, $c(F, H) = c(G, H)$. We denote this rational by $c(H, P_i^M)$.
- iv) let $F \in P_i^M$ and let $1 \leq \theta \leq h_F + 1$ be the smallest integer such that $M \leq \frac{m_\theta^F}{n_F}$. If $\theta \geq 2$ then $\frac{m_k^G}{n_G} = \frac{m_k^F}{n_F}$ for all $G \in P_i^M$ and for all $1 \leq k \leq \theta - 1$. We denote this rational number by $\frac{m_k}{n}(P_i^M)$. As a consequence $\frac{n_G}{d_k^G}$ does not depend on $G \in P_i^M$ and $1 \leq k \leq \theta$. We denote this rational number by $\frac{n}{d_k}(P_i^M)$.

Proof. The proof is an easy application of Lemma 1.5. and Lemma 1.6. ■

Let P_i^M be a point of $T(f)$ and define the subsets $X_1(M, i), \dots, X_{s(M, i)}(M, i)$ of P_i^M as follows:

- For all k and for all $F, G \in X_k(M, i)$, $c(F, G) = M$.
- Given $F \in X_k(M, i)$ and $l \neq k$, if $F \notin X_l(M, i)$, then $c(F, G) > M$ for some $G \in X_l(M, i)$ (in particular $F, G \in P_j^N$ for some $P_j^N > P_i^M$).

The sets defined above satisfy the following property:

Lemma 6.2 The cardinality of $X_k(M, i)$ does not depend on $1 \leq k \leq s(M, i)$. We denote this cardinality by $c(M, i)$.

Proof. Assume that $s(M, i) \geq 2$ and let $1 \leq a \neq b \leq s(M, i)$. We shall construct a bijective map from $X_a(M, i)$ to $X_b(M, i)$. Let $F \in X_a(M, i)$. If $F \notin X_b(M, i)$, then there is $\tilde{F} \in X_b(M, i)$ such that $c(F, \tilde{F}) > M$. We claim that \tilde{F} is the only element with this property. In fact, if there is $\tilde{F} \neq G \in X_b(M, i)$ such that $c(F, G) > M$, then $M = c(\tilde{F}, G) \geq \min(c(F, \tilde{F}), c(F, G)) > M$, which is a contradiction. This defines a map

$$\begin{aligned} \phi_{a,b} : X_a(M, i) &\longmapsto X_b(M, i) \\ \phi_{a,b}(F) &= \begin{cases} F & \text{if } F \in X_b(M, i) \\ \tilde{F} & \text{if } F \notin X_b(M, i) \end{cases} \end{aligned}$$

This map is clearly bijective. This completes the proof of the Lemma. ■

Lemma 6.3 Let the notations be as above, and let $P_{i_1}^{N_1}, \dots, P_{i_t}^{N_t}$ be the set of points that strictly dominate P_i^M . We have the following:

- i) $D_i^M \subseteq X_k(M, i)$ for all $1 \leq k \leq s(M, i)$.
- ii) Given $1 \leq k \leq s(M, i)$, $(X_k(M, i) \cap P_{i_1}^{N_1}, \dots, X_k(M, i) \cap P_{i_t}^{N_t}, D_i^M)$ is a partition of $X_k(M, i)$.
- iii) Given $1 \leq k \leq s(M, i)$ and $1 \leq l \leq t$, $X_k(M, i) \cap P_{i_l}^{N_l}$ is reduced to one element.
- iv) $c(M, i) = t + \text{card}(D_i^M)$.

Proof. The first two assertions are clear, on the other hand 3. \implies 4. We shall consequently prove 3. Assume, without loss of generality, that $k = 1$, and let $1 \leq l \leq t$. Suppose that $X_1(M, i) \cap P_{i_l}^{N_l} = \emptyset$ and let $G \in P_{i_l}^{N_l}$. We have $c(F, G) = M$ for all $F \in X_1(M, i)$, in particular $G \in X_1(M, i)$, which is a contradiction. Consequently $X_1(M, i) \cap P_{i_l}^{N_l} \neq \emptyset$. Let G_1, G_2 be two polynomials of $X_1(M, i) \cap P_{i_l}^{N_l}$. We have $c(G_1, G_2) = M$ and $c(G_1, G_2) \geq N > M$. This is a contradiction if $G_1 \neq G_2$. ■

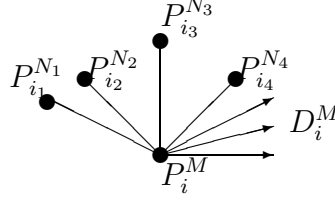

Let P_i^M be a point of $T(f)$ and assume that $D_i^M \neq \emptyset$. For all $F \in D_i^M$, $c(F, F) \leq M$, in particular $M \geq \frac{m_{h_F}^F}{n_F}$.

Lemma 6.4 Let the notations be as above. We have the following

i) If $M > \frac{m_{h_F}^F}{n_F}$ for all $F \in D_i^M$, then n_F does not depend on $F \in D_i^M$. We denote it by $n(D_i^M)$. We have $\sum_{F \in D_i^M} n_F = (c(M, i) - t)n(D_i^M)$.

ii) If $M = \frac{m_{h_F}^F}{n_F}$ for some $F \in D_i^M$, then one of the following hold

1_{ii}) $M = \frac{m_{h_F}^F}{n_F}$ for all $F \in D_i^M$. In this case, n_F does not depend on $F \in D_i^M$. We denote it by $n(D_i^M)$. We have $\sum_{F \in D_i^M} n_F = (c(M, i) - t)n(D_i^M)$.

1_{iii}) $M > \frac{m_{h_{F'}}^{F'}}{n_{F'}}$ for some $F' \in D_i^M$. In this case, $M = \frac{m_{h_F}^F}{n_F} > \frac{m_{h_{F'}}^{F'}}{n_{F'}}$ for all $F \in D_i^M$, $F \neq F'$, and $n_F, h_F, (d_k^F)_{1 \leq k \leq h_F}$ do not depend on $F \in D_i^M$, $F \neq F'$. We denote these integers by $n(D_i^M), h(D_i^M), d_k^{D_i^M}$. With these notations we have $n(F') = \frac{n(D_i^M)}{d_{h(D_i^M)}^{D_i^M}}$, and $\sum_{F \in D_i^M} n(F) =$

$$(c(M, i) - t - 1) \cdot n(D_i^M) + \frac{n(D_i^M)}{d_{h(D_i^M)}^{D_i^M}}.$$

Proof. By definition, for all $F, G \in D_i^M$, $c(F, G) = M$. Consequently our results follow from Proposition 3.4. ■

Let H be a monic polynomial of $\mathbf{K}((x))[y]$ and let $H_1, \dots, H_{\xi(H)}$ be the set of irreducible components of H in $\mathbb{K}((x))[y]$. Let P_i^M be a point of $T(f)$ and let $F \in P_i^M$. We set:

$$R_{=M}(F, H) = \prod_{c(F, H_k)=M} H_k$$

and

$$R_{>M}(F, H) = \prod_{c(F, H_k)>M} H_k$$

In other words, $R_{=M}(F, H)$ (resp. $R_{>M}(F, H)$) is the product of irreducible components of H whose contact with F is M (resp. $> M$).

Lemma 6.5 Suppose that $P_i^M \notin \text{Top}(f)$ and let $P_{i_1}^{N_1}, \dots, P_{i_t}^{N_t}$ be the set of points that strictly dominate P_i^M . Fix $1 \leq l \leq t$ and let $F \in P_{i_l}^{N_l}$. We have the following

i) For all $G \in P_{i_l}^{N_l}$, $R_{=M}(G, H) = R_{=M}(F, H)$ (resp. $R_{>M}(G, H) = R_{>M}(F, H)$). We denote this polynomial by $R_{=M}(P_{i_l}^{N_l}, H)$ (resp. $R_{>M}(P_{i_l}^{N_l}, H)$).

ii) For all $G \in P_{i_k}^{N_k}, k \neq l$, $R_{>M}(G, H)$ divides $R_{=M}(F, H)$.

iii) For all $G \in D_i^M$, $R_{>M}(G, H)$ divides $R_{=M}(F, H)$.

Proof. Let \bar{H} be an irreducible component of H . If $G \in P_{i_l}^{N_l}$, then $c(F, G) \geq N_l > M$. In particular, by Proposition 1.5., $c(G, \bar{H}) = M$ (resp. $c(G, \bar{H}) > M$) if and only if $c(F, \bar{H}) = M$ (resp. $c(F, \bar{H}) > M$). This proves i). If either $G \in P_{i_k}^{N_k}, k \neq l$ or $G \in D_i^M$, then $c(F, G) = M$. In particular, if $c(G, \bar{H}) > M$, then, by Lemma 1.5. $c(F, \bar{H}) = M$. This proves ii) and iii). ■

Let the notations be as above. It follows from ii), iii) of Lemma 6.5. that:

$$\prod_{k=2}^t R_{>M}(P_{i_k}^{N_k}, H) \cdot \prod_{F \in D_i^M} R_{>M}(F, H) \text{ divides } R_{=M}(P_{i_1}^{N_1}, H).$$

Set

$$\bar{Q}_H(M, i) = \frac{R_{=M}(P_{i_1}^{N_1}, H)}{\prod_{k=2}^t R_{>M}(P_{i_k}^{N_k}, H) \cdot \prod_{G \in D_i^M} R_{>M}(G, H)}$$

and let

$$Q_H(M, i) = \prod_{c(G, H_k) = M \forall G \in P_i^M} H_k$$

i.e. $Q_H(M, i)$ is the product of the irreducible components of H whose contact with all $G \in P_i^M$ is M .

Lemma 6.6 With the notations above, we have $Q_H(M, i) = \bar{Q}_H(M, i)$.

Proof. Let \bar{H} be an irreducible component of $Q_H(M, i)$. For all $G \in P_i^M, c(G, \bar{H}) = M$. In particular, since $\cup_{k=1}^t P_{i_k}^{N_k} \subseteq P_i^M$, then \bar{H} divides $R_{=M}(P_{i_1}^{N_1}, H)$ and \bar{H} does not divide $\prod_{k=2}^t R_{>M}(P_{i_k}^{N_k}, H) \cdot \prod_{G \in D_i^M} R_{>M}(G, H)$. Hence $Q_H(M, i)$ divides $\bar{Q}_H(M, i)$.

Let us prove that $\overline{Q}_H(M, i)$ divides $Q_H(M, i)$. Let $G \in P_i^M$ and let \bar{H} be an irreducible component of $\overline{Q}_H(M, i)$.

- If $G \in P_{i_1}^{N_1}$, then by Lemma 6.5. i), $R_{=M}(G, H) = R_{=M}(P_{i_1}^{N_1}, H)$, in particular $c(G, \bar{H}) = M$.

- If $G \in P_i^M - P_{i_1}^{N_1}$ then, by Lemma 6.3., $G \in D_i^M \cup (\cup_{k=2}^t P_{i_k}^{N_k})$. Suppose that $G \in D_i^M$. If $c(G, \bar{H}) > M$, then \bar{H} divides $R_{>M}(G, H) = R_{>M}(D_i^M, H)$. This contradicts the definition of $\overline{Q}_H(M, i)$. In particular $c(G, \bar{H}) = M$. By a similar argument we prove that if $G \in \cup_{k=2}^t P_{i_k}^{N_k}$, then $c(G, \bar{H}) = M$. This implies our assertion. ■

Lemma 6.7 Suppose that $P_i^M \in \text{Top}(f)$, and recall that in this case $P_i^M = D_i^M$. Let F be an element of D_i^M . We have

$$Q_H(M, i) = \frac{R_{=M}(F, H)}{\prod_{G \in D_i^M, G \neq F} R_{>M}(G, H)}$$

Proof. The proof is similar to the proof of Lemma 6.6. ■

7 Factorization of the y -derivative

7.1 The irreducible case

Let f be a monic irreducible polynomial of $\mathbb{K}((x))[y]$ of degree n_f in y and consider the characteristic sequences associated with f as in Section 1. We have the following:

Proposition 7.1 $f_y = P_1 \dots P_{h_f}$ and for all $k = 1, \dots, h_f$:

i) $\deg_y P_k = (e_k^f - 1) \frac{n_f}{d_k^f}$.

ii) $\text{int}(f, P_k) = (e_k^f - 1)r_k^f$.

iii) For all irreducible component P of P_k , $c(f, P) = \frac{m_k^f}{n_f}$.

Proof. i) and iii) result from Proposition 5.1. and ii) results from Proposition 1.4. ■

7.2 The general case

Let the notations be as in Section 5. In particular f is a monic reduced polynomial of $\mathbb{K}((x))[y]$ and $f_1, \dots, f_{\xi(f)}$ are the irreducible components of f in $\mathbb{K}((x))[y]$. Consider the characteristic sequences associated with $f_1, \dots, f_{\xi(f)}$ and let $T(f)$ be the tree of f . Fix a point P_i^M of $T(f)$.

Lemma 7.2 Let the notations be as above and let $P_i^M \in T(f) - \text{Top}(f)$. If $D_i^M \neq \emptyset$, then $\deg_y(R_{>M}(F, f_y)) = 0$ for all $F \in D_i^M$.

Proof. Suppose that $P_i^M \notin \text{Top}(f)$, and that $D_i^M \neq \emptyset$. Let $F \in D_i^M$. If $\deg_y(R_{>M}(F, f_y)) \neq 1$, then $c(F, H) = N > M$ for some irreducible component H of f_y . In particular, by Lemma 4.4., $c(F, \bar{F}) = N$ for some irreducible component \bar{F} of f , hence $F \in P_j^N$ for some point $P_j^N \in T(f)$, $N > M$. This is a contradiction because $F \in D_i^M$. ■

Lemma 7.3 Suppose that $P_i^M \notin \text{Top}(f)$ and let $P_{i_1}^{N_1}, \dots, P_{i_t}^{N_t}$ be the set of points of $T(f)$ that strictly dominate P_i^M . We have:

$$Q_{f_y}(M, i) = \frac{R_{=M}(P_{i_1}^{N_1}, f_y)}{\prod_{l=2}^t R_{>M}(P_{i_l}^{N_l}, f_y)}$$

Proof. We have, by Lemma 6.6.:

$$Q_{f_y}(M, i) = \frac{R_{=M}(P_{i_1}^{N_1}, f_y)}{\prod_{l=2}^t R_{>M}(P_{i_l}^{N_l}, f_y) \cdot \prod_{G \in D_i^M} R_{>M}(G, f_y)}$$

On the other hand, by Lemma 7.2., if $G \in D_i^M$, then $\deg_y(R_{>M}(G, f_y)) = 0$. This proves our assertion. ■

Fix a polynomial $F_l \in P_{i_l}^{N_l}$ for all $1 \leq l \leq t$. By Lemma 6.6., $R_{=M}(P_{i_l}^{N_l}, f_y) = R_{=M}(F_l, f_y)$ (resp. $R_{>M}(P_{i_l}^{N_l}, f_y) = R_{>M}(F_l, f_y)$). In particular we have:

$$Q_{f_y}(M, i) = \frac{R_{=M}(F_1, f_y)}{\prod_{l=2}^t R_{>M}(F_l, f_y)}$$

The following Lemmas give the degrees of the two polynomials describing $Q_{f_y}(M, i)$.

Lemma 7.4 Let P_i^M be a point of $T(f)$ and let θ be the smallest integer such that $M \leq \frac{m_\theta^F}{n_F}$ for all $F \in P_i^M$. Let $(P_{i_l}^{N_l})_{1 \leq l \leq t}$ be the set of points that strictly dominate P_i^M . Let $F_1 \in P_{i_1}^{N_1}$. We have:

$$\deg_y R_{=M}(F_1, f_y) = \begin{cases} \sum_{l=2}^t \left(\sum_{F \in P_{i_l}^{N_l}} n_F \right) + \sum_{F \in D_i^M} n_F & \text{if } M \neq \frac{m_\theta^{F_1}}{n_{F_1}} \\ \sum_{l=2}^t \left(\sum_{F \in P_{i_l}^{N_l}} n_F \right) + \sum_{F \in D_i^M} n_F + (e_\theta^{F_1} - 1) \frac{n_{F_1}}{d_\theta^{F_1}} & \text{if } M = \frac{m_\theta^{F_1}}{n_{F_1}} \end{cases}$$

Proof. This results from Propositions 5.2. and 5.3. ■

Lemma 7.5 Let the notations and the hypotheses by as in Lemma 7.4. We have:

$$\deg_y R_{>M}(F_1, f_y) = \sum_{F \in P_{i_1}^{N_l} - \{F_1\}} n_F + \sum_{M < \frac{m_j^{F_1}}{n_{F_1}}} (e_j^{F_1} - 1) \frac{n_{F_1}}{d_j^{F_1}}$$

Proof. This results from Propositions 5.2. and 5.3. ■

As a corollary we have the following:

Proposition 7.6 Let the notations and the hypotheses by as in Lemma 7.4. and fix $F_l \in P_i^{N_l}$ for all $2 \leq l \leq t$. We have:

$$\deg_y Q_{f_y}(M, i) = \begin{cases} \sum_{F \in D_i^M} n_F + \sum_{l=2}^t [n_{F_l} - \sum_{M < \frac{m_j^{F_l}}{n_{F_l}}} (e_j^{F_l} - 1) \frac{n_{F_l}}{d_j^{F_l}}] & \text{if } M \neq \frac{m_\theta^{F_1}}{n_{F_1}} \\ \sum_{F \in D_i^M} n_F + \sum_{l=2}^t [n_{F_l} - \sum_{M < \frac{m_j^{F_l}}{n_{F_l}}} (e_j^{F_l} - 1) \frac{n_{F_l}}{d_j^{F_l}}] + (e_\theta^{F_1} - 1) \frac{n_{F_1}}{d_\theta^{F_1}} & \text{if } M = \frac{m_\theta^{F_1}}{n_{F_1}} \end{cases}$$

Proof. This results from Lemmas 7.4. and 7.5., since $\gcd(R_{=M}(F_1, f_y), R_{>M}(F_l, f_y)) = 1$ for all $2 \leq l \leq t$. ■

Note that with the hypotheses of Proposition 7.6.,

$$n_{F_l} - \sum_{M < \frac{m_j^{F_l}}{n_{F_l}}} (e_j^{F_l} - 1) \frac{n_{F_l}}{d_j^{F_l}} = \begin{cases} n_{F_l} - \sum_{j=\theta}^{h_{F_l}} (e_j^{F_l} - 1) \frac{n_{F_l}}{d_j^{F_l}} = \frac{n_{F_l}}{d_\theta^{F_l}} & \text{if } M \neq \frac{m_\theta^{F_l}}{n_{F_l}} \\ n_{F_l} - \sum_{j=\theta+1}^{h_{F_l}} (e_j^{F_l} - 1) \frac{n_{F_l}}{d_j^{F_l}} = \frac{n_{F_l}}{d_{\theta+1}^{F_l}} & \text{if } M = \frac{m_\theta^{F_l}}{n_{F_l}} \end{cases}$$

Let A (resp. B) be the set of $1 \leq l \leq t$ for which $M = \frac{m_\theta^{F_l}}{n_{F_l}}$ (resp. $M < \frac{m_\theta^{F_l}}{n_{F_l}}$). It follows that:

$$\deg_y Q_{f_y}(M, i) = \begin{cases} \sum_{l \in A} \frac{n_{F_l}}{d_{\theta+1}^{F_l}} + \sum_{l \in B - \{1\}} \frac{n_{F_l}}{d_\theta^{F_l}} + \sum_{F \in D_i^M} n_F & \text{if } 1 \in A \\ \sum_{l \in A - \{1\}} \frac{n_{F_l}}{d_{\theta+1}^{F_l}} + \sum_{l \in B} \frac{n_{F_l}}{d_\theta^{F_l}} + (e_\theta^{F_1} - 1) \frac{n_{F_1}}{d_\theta^{F_1}} + \sum_{F \in D_i^M} n_F & \text{if } 1 \in B \end{cases}$$

Let $(l_1, l_2) \in A \times B$ and recall that $\frac{n_F}{d_{\theta+1}^F}$ (resp. $\frac{n_F}{d_{\theta}^F}$) does not depend on $F \in \cup_{l \in A} P_i^{N_l}$ (resp. $F \in \cup_{l \in B} P_i^{N_l}$). In particular, if we denote by a (resp. b) the cardinality of A (resp. B), then we have:

$$\deg_y Q_{f_y}(M, i) = \begin{cases} a \frac{n_{F_{l_1}}}{d_{\theta+1}^{F_{l_1}}} + (b-1) \frac{n_{F_{l_2}}}{d_{\theta}^{F_{l_2}}} + \sum_{F \in D_i^M} n_F & \text{if } 1 \in B \\ (a-1) \frac{n_{F_{l_1}}}{d_{\theta+1}^{F_{l_1}}} + b \frac{n_{F_{l_2}}}{d_{\theta}^{F_{l_2}}} + (e_{\theta}^{F_1} - 1) \left(\frac{n_{F_1}}{d_{\theta}^{F_1}} \right) + \sum_{F \in D_i^M} n_F & \text{if } 1 \in A \end{cases}$$

Note also that if $B \neq \emptyset$ then $\frac{n_{F_{l_2}}}{d_{\theta}^{F_{l_2}}} = \frac{n_{F_1}}{d_{\theta}^{F_1}}$, on the other hand, if $B = \emptyset$, then $1 \in A$. In particular we get the following:

$$\deg_y Q_{f_y}(M, i) = a \frac{n_{F_{l_1}}}{d_{\theta+1}^{F_{l_1}}} + (b-1) \frac{n_{F_1}}{d_{\theta}^{F_1}} + \sum_{F \in D_i^M} n_F$$

The above results can be stated as follows:

Theorem 7.7 Let P_i^M be a point of $T(f)$ and assume that $P_i^M \notin \text{Top}(f)$. Let $(P_i^{N_l})_{1 \leq l \leq t}$ be the set of points that strictly dominate P_i^M and let θ be the smallest integer such that for all $F \in P_i^M$, $M \leq \frac{m_{\theta}^F}{n_F}$. Fix $F_l \in P_i^{N_{l_i}}$ for all $1 \leq l \leq t$ and let A (resp. B) be the set of $1 \leq l \leq t$ for which $M = \frac{m_{\theta}^F}{n_F}$ (resp. $M < \frac{m_{\theta}^F}{n_F}$) for all $F \in \cup_{l \in A} P_i^{N_l}$ (resp. $F \in \cup_{l \in B} P_i^{N_l}$). Let $(l_1, l_2) \in A \times B$. Let $F_{l_1} \in P_i^{N_{l_1}}$ and $F_{l_2} \in P_i^{N_{l_2}}$. If a (resp. b) denotes the cardinality of A (resp. B) then the component $Q_{f_y}(M, i)$ of f_y satisfies the following:

i) $\deg_y Q_{f_y}(M, i) = a \frac{n_{F_{l_1}}}{d_{\theta+1}^{F_{l_1}}} + (b-1) \frac{n_{F_{l_2}}}{d_{\theta}^{F_{l_2}}} + \sum_{F \in D_i^M} n_F$, and $\sum_{F \in D_i^M} n_F$ is given by the formula of

Lemma 6.4., where if $F \in D_i^M$, then h_F is either $\theta - 1$ or θ depending on $M > \frac{m_{h_F}^F}{n_F}$ or $M = \frac{m_{h_F}^F}{n_F}$.

ii) For all irreducible component P of $Q_{f_y}(M, i)$ and for all $F \in P_i^M$, $c(F, P) = M$.

iii) For all irreducible component P of $Q_{f_y}(M, i)$ and for all $F \notin P_i^M$, $c(F, P) = c(F, P_i^M) < M$, where we recall that $c(F, P_i^M)$ is the contact of F with any element of P_i^M .

iv) For all $1 \leq k \leq \xi(f)$:

- If $f_k \in P_i^M$ then $\text{int}(f_k, Q_{f_y}(M, i)) = S(m^{f_k}, M) \frac{\deg_Q f_y(M, i)}{n_{f_k}}$.

- If $f_k \notin P_i^M$ then $\text{int}(f_k, Q_{f_y}(M, i)) = S(m^{f_k}, c(f_k, P_i^M)) \frac{\deg_Q f_y(M, i)}{n_{f_k}}$, where $c(f_k, P_i^M)$ is the contact of f_k with any $F \in P_i^M$. ■

In the following we shall consider the case where P_i^M is a top point of $T(f)$.

Lemma 7.8 Suppose that $P_i^M = D_i^M \in \text{Top}(f)$, and let $F \in P_i^M$. We have the following:

$$Q_{f_y}(M, i) = R_{=M}(F, f_y)$$

Proof. By Lemma 7.2., $\deg_y R_{>M}(G, f_y) = 1$ for all D_i^M . Our assertion follows from Lemma 6.7. ■

Let $P_i^M = D_i^M = \{F_1, \dots, F_r\}$, and recall, by Proposition 2.4., that the sequence (F_1, \dots, F_r) is either equivalent, or almost equivalent.

Theorem 7.9 Let $P_i^M = \{F_1, \dots, F_r\} \in \text{Top}(f)$ and assume that $n_{F_1} = \max_{1 \leq k \leq r} n_{F_k}$. We have the following:

- i) If (F_1, \dots, F_r) is equivalent with $M > \frac{m_{h_{F_1}}^{F_1}}{n_{F_1}}$, then $\deg_y Q_{f_y}(M, i) = (r-1)n_{F_1}$.
- ii) If (F_1, \dots, F_r) is equivalent with $M = \frac{m_{h_{F_1}}^{F_1}}{n_{F_1}}$, then $\deg_y Q_{f_y}(M, i) = (r-1)n_{F_1} + (e_{h_{F_1}}^{F_1} - 1) \frac{n_{F_1}}{d_{h_{F_1}}^{F_1}}$.
- iii) If (F_1, \dots, F_r) is almost equivalent, then $\deg_y Q_{f_y}(M, i) = (r-1)n_{F_1}$.

Proof. It follows from Lemma 7.8. that $\deg_y Q_{f_y}(M, i) = \deg_y R_{=M}(F_1, f_y)$. Now the hypothesis of i) and ii) implies that $n_{F_k} = n_{F_1}$ for all $k = 2, \dots, r$. Hence i) results from Proposition 5.2. and ii) results from Proposition 5.3. Assume that (F_1, \dots, F_r) is almost equivalent, and that, without loss of generality, (F_1, F_3, \dots, F_r) is equivalent. Since $Q_{f_y}(M, i) = R_{=M}(F_1, f_y) = R_{=M}(F_2, f_y)$, then iii) results from Proposition 5.2. ■

Remark 7.10 When $P_i^M = D_i^M \in \text{Top}(f)$, the numbers a and b of Theorem 7.7. are zero. The reader may verify that the two formulas of Theorem 7.7. and Theorem 7.9. coincide. ■

Example 7.11 i) Delgado's result: Let $f = f_1.f_2$. In [5], in order to generalize Merle's Theorem, F. Delgado uses the arithmetic of the semi-group of f . His result is a particular case of Theorem 7.7. More precisely, let $n_i = \deg_y f_i, i = 1, 2$ and let $M = c(f_1, f_2)$, $I = \text{int}(f_1, f_2)$. Let θ be the smallest integer such that $M \leq \frac{m_i^\theta}{n_i}, i = 1, 2$. We have:

$$f_y = \left(\prod_{k=1}^{\theta-1} Q_{f_y} \left(\frac{m_k^1}{n_{f_1}}, 1 \right) \right) \cdot \bar{f}_y$$

where the properties $Q_{f_y} \left(\frac{m_k^1}{n_{f_1}}, 1 \right)$ are given in the table 0), while those of the components of \bar{f}_y are given in the tables 1), 2), 3), depending on the position of M on $T(f)$. Note that $c(f_j, P)$ means the contact of f_j with an irreducible component of $Q_{f_y}(M, i)$.

0)

Q	$Q_{f_y}(\frac{m_1^1}{n_1}, 1)$...	$Q_{f_y}(\frac{m_{\theta-1}^1}{n_1}, 1)$
$\deg_y Q$	$(e_1^1 - 1) \frac{n_1}{d_1^{f_1}}$...	$(e_{\theta-1}^1 - 1) \frac{n_1}{d_{\theta-1}^{f_1}}$
$c(f_1, P), \text{int}(f_1, Q)$	$\frac{m_1^{f_1}}{n_1}, (e_1^1 - 1)r_1^1$...	$\frac{m_{\theta-1}^{f_1}}{n_1}, (e_{\theta-1}^1 - 1)r_{\theta-1}^1$
$c(f_2, P), \text{int}(f_2, Q)$	$\frac{m_1^{f_1}}{n_1}, (e_1^1 - 1)r_1^2$...	$\frac{m_{\theta-1}^{f_1}}{n_1}, (e_{\theta-1}^1 - 1)r_{\theta-1}^2$

$$\frac{m_i^1}{n_1}$$

With the notations of Theorem 7.7., for all $1 \leq i \leq \theta - 1$, we have: $P_1^{n_1} = \{f_1, f_2\}, a = 1, b = 0$.

1) $M \neq \frac{m_\theta^i}{n(f_i)}, i = 1, 2$.

Q	$Q_{f_y}(M, 1)$	$Q_{f_y}(\frac{m_k^{f_1}}{n_1}, *), \theta \leq k \leq h_{f_1}$	$Q_{f_y}(\frac{m_k^{f_2}}{n_2}, *), \theta \leq k \leq h_{f_2}$
$\deg_y Q$	$\frac{n_1}{d_\theta^{f_1}} = \frac{n_2}{d_\theta^{f_2}}$	$(e_k^{f_1} - 1) \frac{n_1}{d_k^{f_1}}$	$(e_k^{f_2} - 1) \frac{n_2}{d_k^{f_2}}$
$c(f_1, P), \text{int}(f_1, Q)$	$M, \frac{I}{d_\theta^{f_1}} \frac{n_1}{n_2}$	$\frac{m_k^{f_1}}{n_1}, (e_k^{f_1} - 1)r_k^{f_1}$	$M, (e_k^{f_2} - 1) \frac{I}{d_k^{f_2}}$
$c(f_2, P), \text{int}(f_2, Q)$	$M, \frac{I}{d_\theta^{f_2}} \frac{n_2}{n_1}$	$M, (e_k^{f_1} - 1) \frac{I}{d_k^{f_1}}$	$\frac{m_k^{f_2}}{n_2}, (e_k^{f_2} - 1)r_k^{f_2}$

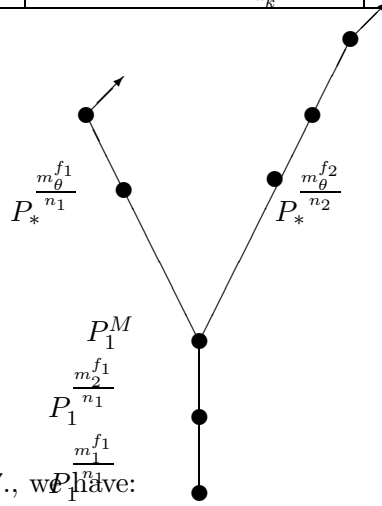

With the notations of Theorem 7.7., we have:

$$P_1^M = \{f_1, f_2\}, A = \{f_1\}, B = \{f_2\}, a = b = 1$$

$$P_*^{\frac{m_k^{f_1}}{n_1}} = \{f_1\}, \theta \leq k \leq h_{f_1} : a = 1, b = 0, P_*^{\frac{m_k^{f_2}}{n_2}} = \{f_2\}, \theta \leq k \leq h_{f_2} : a = 1, b = 0$$

2) $M = \frac{m_\theta^{f_1}}{n_1} < \frac{m_\theta^{f_2}}{n_2}$.

Q	$Q_{f_y}(M, 1)$	$Q_{f_y}(\frac{m_k^{f_1}}{n_1}, *), \theta + 1 \leq k \leq h_{f_1}$	$Q_{f_y}(\frac{m_k^{f_2}}{n_2}, *), \theta \leq k \leq h_{f_2}$
$\deg_y Q$	$\frac{n_1}{d_{\theta+1}^{f_1}} = \frac{n_2}{d_\theta^{f_2}} + (e_\theta^{f_1} - 1) \frac{n_1}{d_\theta^{f_1}}$	$(e_k^{f_1} - 1) \frac{n_1}{d_k^{f_1}}$	$(e_k^{f_2} - 1) \frac{n_2}{d_k^{f_2}}$
$c(f_1, P), \text{int}(f_1, P_i)$	$M, e_\theta^{f_1} r_\theta^{f_1}$	$\frac{m_k^{f_1}}{n_1}, (e_k^{f_1} - 1)r_k^{f_1}$	$M, (e_k^{f_2} - 1) \frac{I}{d_k^{f_2}}$
$c(f_2, P), \text{int}(f_2, P_i)$	$M, \frac{I}{d_{\theta+1}^{f_1}} = e_\theta^{f_1} r_\theta^{f_1} \frac{n_2}{n_1}$	$M, (e_k^{f_1} - 1) \frac{I}{d_k^{f_1}}$	$\frac{m_k^{f_2}}{n_2}, (e_k^{f_2} - 1)r_k^{f_2}$

With the notations of Theorem 7.7., we have $P_1^M = \{f_1, f_2\}, P_*^{\frac{m_k^{f_1}}{n_1}} = \{f_1\}$ for all $\theta + 1 \leq k \leq h_{f_1}$, and $P_*^{\frac{m_k^{f_2}}{n_2}} = \{f_2\}$ for all $\theta \leq k \leq h_{f_2}$.

$$3) M = \frac{m_\theta^{f_1}}{n_1} = \frac{m_\theta^{f_2}}{n_2}.$$

Q	$Q_{f_y}(M, 1)$	$Q_{f_y}(\frac{m_k^{f_1}}{n_1}, *), \theta + 1 \leq k \leq h_{f_1}$	$Q_{f_y}(\frac{m_k^{f_2}}{n_2}, *), \theta + 1 \leq k \leq h_{f_2}$
$\deg_y Q$	$\frac{n_1}{d_{\theta+1}^{f_1}} + (e_\theta^{f_1} - 1) \frac{n_1}{d_\theta^{f_1}}$	$(e_k^{f_1} - 1) \frac{n_1}{d_k^{f_1}}$	$(e_k^{f_2} - 1) \frac{n_2}{d_k^{f_2}}$
$c(f_1, P), \text{int}(f_1, Q)$	$M, (2e_\theta^{f_1} - 1)r_\theta^{f_1}$	$\frac{m_k^{f_1}}{n_1}, (e_k^{f_1} - 1)r_k^{f_1}$	$M, (e_k^{f_2} - 1) \frac{I}{d_k^{f_2}}$
$c(f_2, P), \text{int}(f_2, Q)$	$M, (2e_\theta^{f_2} - 1)r_\theta^{f_2}$	$M, (e_k^{f_1} - 1) \frac{I}{d_k^{f_1}}$	$\frac{m_k^{f_2}}{n_2}, (e_k^{f_2} - 1)r_k^{f_2}$

With the notations of Theorem 7.7., we have $P_1^M = \{f_1, f_2\}, P_*^{\frac{m_k^{f_1}}{n_1}} = \{f_1\}$ for all $\theta + 1 \leq k \leq h_{f_1}$, and $P_*^{\frac{m_k^{f_2}}{n_2}} = \{f_2\}$ for all $\theta + 1 \leq k \leq h_{f_2}$.

Example 7.12 i) $f = f_1.f_2$ and $f_1 = (y^2 - x^3)^2 - x^5y, f_2 = (y^2 - x^3)^2 + x^5y$. We have $n_{f_1} = n_{f_2} = n = 4, \underline{r}^{f_1} = \underline{r}^{f_2} = \underline{r} = (4, 6, 13), \underline{d}^{f_1} = \underline{d}^{f_2} = \underline{d} = (4, 2, 1), \underline{m}^{f_1} = \underline{m}^{f_2} = \underline{m} = (4, 6, 7)$, and $c(f_1, f_2) = \frac{7}{4}$. The tree model of f is given by:

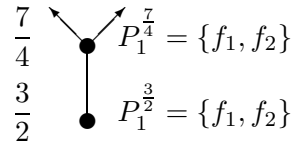

Note that $X(\frac{3}{2}, 1) = \{f_1\}, X(\frac{3}{2}, 2) = \{f_2\}$, and $X(\frac{7}{4}, 1) = P_1^{\frac{7}{4}} = \{f_1, f_2\}$. In particular $c(\frac{3}{2}, 1) = 1$ and $c(\frac{7}{4}, 1) = 2$. With the notations of Theorem 7.7., $f_y = Q(\frac{3}{2}, 1)Q(\frac{7}{4}, 1) = Q_1Q_2$, where:

$$\deg_y Q_1 = \frac{n}{d_2} - \frac{n}{d_1} = 1 \quad (a = 1, b = 0)$$

$$\deg_y Q_2 = \frac{n}{d_3} - \frac{n}{d_2} + n = 2.4 - 2 = 6 \quad (a = 1, b = 0).$$

Furthermore, for all irreducible component P of Q_1 (resp. Q_2), $c(f_1, P) = c(f_2, P) = \frac{3}{2}$ (resp. $c(f_1, P) = c(f_2, P) = \frac{7}{4}$). Finally, $\text{int}(f_1, Q_1) = (e_1 - 1)r_1 = r_1 = 6 = \text{int}(f_2, Q_1)$ and $\text{int}(f_1, Q_2) = \text{int}(f_1, f_2) + (e_2 - 1)r_2 = 39 = \text{int}(f_2, Q_2)$.

ii) $f = f_1.f_2.f_3.f_4$ and $f_1 = (y^2 - x^3)^2 - x^5y, f_2 = (y^2 - x^3)^2 + x^5y, f_3 = (y^2 - x^3)^2 + x^5y - x^7$, and $f_4 = (y^2 + x^3)^2 - x^5y$: $\Gamma(f_i) = \langle 4, 6, 13 \rangle = \langle n, r_1, r_2 \rangle, i = 1, 2, 3, 4, m_1 = 6, m_2 = 7$, and

$c(f_1, f_2) = c(f_1, f_3) = \frac{7}{4}, c(f_1, f_4) = \frac{3}{2}, c(f_2, f_3) = \frac{9}{4}, c(f_2, f_4) = \frac{3}{2}, c(f_3, f_4) = \frac{3}{2}$. The tree model of f is given by:

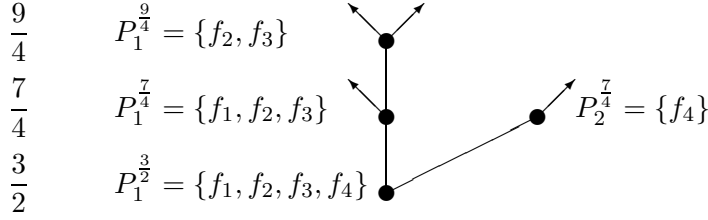

Note that $X_i(\frac{3}{2}, 1) = \{f_i\}, i = 1, \dots, 4, X_1(\frac{7}{4}, 1) = \{f_1, f_2\}, X_2(\frac{7}{4}, 1) = \{f_1, f_3\}, D_1^{\frac{7}{4}} = \{f_1\}, X_2(\frac{7}{4}, 2) = P_2^{\frac{7}{4}}$ and $X_1(\frac{9}{4}, 1) = \{f_2, f_3\}$. In particular, $c(\frac{3}{2}, 1) = 1, c(\frac{7}{4}, 1) = 2 = c(\frac{9}{4}, 1), c(\frac{7}{4}, 2) = 1,$ Theorem 7.7. implies that $f_y = Q(\frac{3}{2}, 1)Q(\frac{7}{4}, 1)Q(\frac{7}{4}, 2)Q(\frac{9}{4}, 1) = Q_1Q_2Q_3Q_4$ with the following properties:

$Q_i, \deg_y Q_i$	$Q_1, 3$	$Q_2, 6$	$Q_3, 2$	$Q_4, 4$
$c(f_1, P), \text{int}(f_1, Q_i)$	$\frac{3}{2}, 18$	$\frac{7}{4}, 39$	$\frac{3}{2}, 12$	$\frac{7}{4}, 26$
$c(f_2, P), \text{int}(f_2, Q_i)$	$\frac{3}{2}, 18$	$\frac{7}{4}, 39$	$\frac{3}{2}, 12$	$\frac{9}{4}, 28$
$c(f_3, P), \text{int}(f_3, Q_i)$	$\frac{3}{2}, 18$	$\frac{7}{4}, 39$	$\frac{3}{2}, 12$	$\frac{9}{4}, 28$
$c(f_4, P), \text{int}(f_4, Q_i)$	$\frac{3}{2}, 18$	$\frac{3}{2}, 36$	$\frac{7}{4}, 13$	$\frac{3}{2}, 24$

Where $c(F, P)$ means the contact of F with an irreducible component P of Q_i .

iii) Let $f = f_1.f_2.f_3$, where $f_1 = (y^2 - x^3)^2 - x^5y, f_2 = y^2 - x^3$ and $f_3 = y^2 + x^3$. We have $c(f_1, f_2) = \frac{7}{4}, c(f_1, f_3) = \frac{3}{2} = c(f_2, f_3), \text{int}(f_1, f_2) = 13, \text{int}(f_1, f_3) = 12$ and $\text{int}(f_2, f_3) = 6$. The tree model of f is given by:

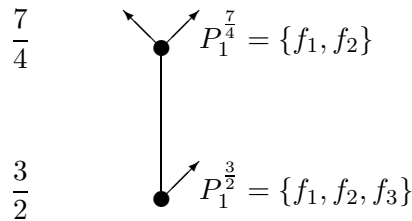

With the notations of Theorem 7.7., we have:

$$X\left(\frac{3}{2}, 1\right) = \{f_1, f_2\}, X\left(\frac{3}{2}, 2\right) = \{f_2, f_3\}, D_1^{\frac{3}{2}} = \{f_3\}, c\left(\frac{3}{2}, 1\right) = 2.$$

$$X\left(\frac{7}{4}, 1\right) = \{f_1, f_2\}, c\left(\frac{7}{4}, 1\right) = 2.$$

This gives us the following description:

$Q, \deg_y Q$	$Q_{f_y}\left(\frac{3}{2}, 1\right), 5$	$Q_{f_y}\left(\frac{7}{4}, 1\right), 2$
$c(f_1, P), \text{int}(f_1, Q)$	$\frac{7}{4}, 26$	$\frac{3}{2}, 18$
$c(f_2, P), \text{int}(f_2, Q)$	$\frac{7}{4}, 13$	$\frac{3}{2}, 9$
$c(f_3, P), \text{int}(f_3, Q)$	$\frac{3}{2}, 12$	$\frac{3}{2}, 9$

Where $c(F, P)$ means the contact of F with an irreducible component P of Q_i .

iv) $f = f_1 \cdot f_2$, where $f_1 = ((y^2 - x^3)^2 - x^5 y)^2 + x^{10}(y^2 - x^3)$ and $f_2 = ((y^2 + x^3)^2 - x^5 y)^2 + x^{22}(y^2 + x^3)$. We have $\Gamma(f_1) = \langle 8, 12, 26, 53 \rangle$, $\Gamma(f_2) = \langle 8, 12, 26, 57 \rangle$, $M = c(f_1, f_2) = \frac{3}{2}$ and $I = \text{int}(f_1, f_2) = 96$. The tree model of f is given by:

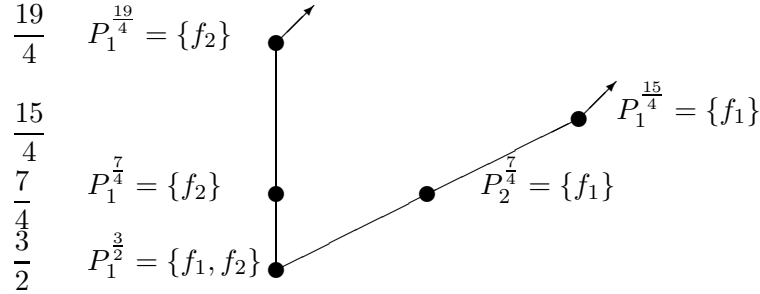

With the notations of Theorem 7.7., we have:

$$X\left(\frac{3}{2}, 1\right) = \{f_1\}, X\left(\frac{3}{2}, 2\right) = \{f_2\}, c\left(\frac{3}{2}, 1\right) = 1.$$

$$X\left(\frac{7}{4}, 1\right) = \{f_2\}, c\left(\frac{7}{4}, 1\right) = 1, X\left(\frac{7}{4}, 2\right) = \{f_1\}, c\left(\frac{7}{4}, 2\right) = 1$$

$$X\left(\frac{15}{4}, 1\right) = \{f_1\}, c\left(\frac{15}{4}, 1\right) = 1, X\left(\frac{19}{4}, 1\right) = \{f_2\}, c\left(\frac{19}{4}, 1\right) = 1$$

This gives us the following description:

$Q, \deg_y Q$	$Q_{f_y}\left(\frac{3}{2}, 1\right), 3$	$Q_{f_y}\left(\frac{7}{4}, 1\right), 2$	$Q_{f_y}\left(\frac{7}{4}, 2\right), 2$	$Q_{f_y}\left(\frac{15}{4}, 1\right), 4$	$Q_{f_y}\left(\frac{19}{4}, 1\right), 4$
$c(f_1, P), \text{int}(f_1, Q)$	$\frac{3}{2}, 36$	$\frac{3}{2}, 24$	$\frac{7}{4}, 26$	$\frac{15}{4}, 53$	$\frac{3}{2}, 48$
$c(f_2, P), \text{int}(f_2, Q)$	$\frac{3}{2}, 36$	$\frac{7}{4}, 26$	$\frac{3}{2}, 24$	$\frac{3}{2}, 48$	$\frac{19}{4}, 57$

Where $c(F, P)$ means the contact of F with an irreducible component P of Q .

8 Factorization of the Jacobian

Let $f = y^n + a_1(x)y^{n-1} + \dots + a_n(x)$ and $g = y^m + b_1(x)y^{m-1} + \dots + b_m(x)$ be two monic reduced polynomials of $\mathbb{K}((x))[y]$ and consider the Jacobian $J = J(f, g)$ of f and g . The aim of this Section is to give a factorization theorem of J in terms of the tree of $f.g$. Let to this end $T(f.g)$ be the tree of $f.g$ and let $f_1, \dots, f_{\xi(f)}$ (resp. $g_1, \dots, g_{\xi(g)}$) be the irreducible components of f (resp. g) in $\mathbb{K}((x))[y]$.

Definition 8.1 Let $P_i^M \in T(f.g)$.

i) We say that P_i^M is an f -point if for all $1 \leq k \leq \xi(g)$, $g_k \notin P_i^M$ (equivalently P_i^M is an f -point if for all $F \in P_i^M$ and for all $1 \leq k \leq \xi(g)$, $c(g_k, F) < M$).

ii) We say that P_i^M is a g -point if for all $1 \leq k \leq \xi(f)$, $f_k \notin P_i^M$ (equivalently P_i^M is a g -point if for all $F \in P_i^M$ and for all $1 \leq k \leq \xi(f)$, $c(f_k, F) < M$).

iii) We say that the point P_i^M is a mixed point if it is neither an f -point nor a g -point.

We denote by T_f (resp. T_g , resp. T_m) the set of f -points (resp. g -points, resp. mixed points) of $T(f.g)$. Clearly $T(f.g) = T_f \cup T_g \cup T_m$.

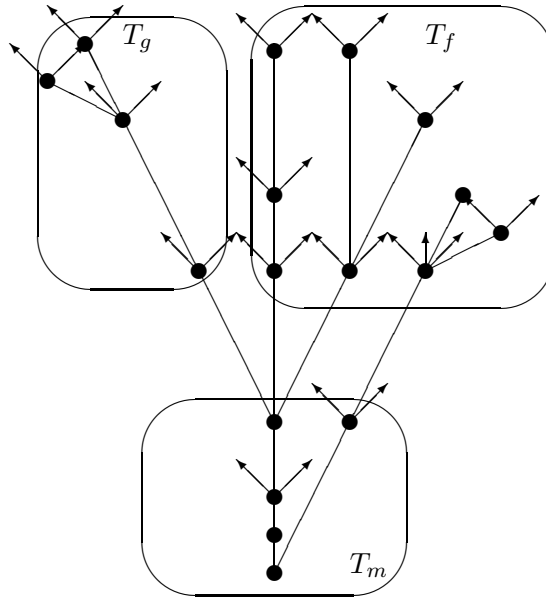

Lemma 8.2 Let $P_i^M, P_j^N \in T(f.g)$, and assume that $P_j^N \geq P_i^M$.

i) If $P_i^M \in T_f$ (resp. $P_i^M \in T_g$) then $P_j^N \in T_f$ (resp. $P_j^N \in T_g$).

ii) if $P_j^N \in T_m$, then $P_i^M \in T_m$.

Proof. Easy exercise. ■

Lemma 8.3 Let the notations be as above. If $T_f \neq \emptyset$ (resp. $T_g \neq \emptyset$), then $\text{Root}(J) \neq \emptyset$.

Proof. Assume that $T_f \neq \emptyset$, and let $P = P_i^M \in T_f$. Let $F \in P$ and let $y_i(x), y_j(x) \in \text{Root}(f)$ such that $c(y_i, y_j) = M$. By hypothesis, $M > \max_{z(x) \in \text{Root}(g)} c(y_i, z)$. Now use Lemma 4.6. ■

More generally, assume that $T_f \cup T_g \neq \emptyset$, Propositions 5.3. and 5.4. and similar arguments as in Section 7. led to the following factorization theorem of J .

Theorem 8.4 $J = \bar{J} \cdot \prod_{P_i^M \in T_f} Q_J(M, i) \cdot \prod_{P_i^M \in T_g} Q_J(M, i)$, where for all $P_i^M \in T_f \cup T_g$, $\deg_y Q_J(M, i) >$

1. More precisely, assume, without loss of generality, that $P = P_i^M \in T_f$ and let $(P_{i_l}^{N_{l_1}})_{1 \leq l \leq t}$ be the set of points that strictly dominate P_i^M . Let θ be the smallest integer such that $M \leq \frac{m_\theta^F}{n_F}$ for all $F \in P_i^M$. Let A (resp. B) be the set of $1 \leq l \leq t$ for which $M = \frac{m_\theta^F}{n_F}$ (resp. $M < \frac{m_\theta^F}{n_F}$) for all $F \in \cup_{l \in A} P_{i_l}^{N_{l_1}}$ (resp. $F \in \cup_{l \in B} P_{i_l}^{N_{l_1}}$) and let $(l_1, l_2) \in A \times B$. Let $F_{l_1} \in P_{i_{l_1}}^{N_{l_1}}$ and $F_{l_2} \in P_{i_{l_2}}^{N_{l_2}}$. If a (resp. b) denotes the cardinality of A (resp. B) then the following hold:

i) $\deg_y Q_J(M, i) = a \cdot \frac{n_{F_{l_1}}}{d_{\theta+1}^{F_{l_1}}} + (b-1) \cdot \frac{n_{F_{l_2}}}{d_\theta^{F_{l_2}}} + \sum_{F \in D_i^M} n_F$, and $\sum_{F \in D_i^M} n_F$ is given by the formula of

Lemma 5.6., where if $F \in D_i^M$, then h_F is either $\theta - 1$ or θ depending on $M > \frac{m_{h_F}^F}{n_F}$ or $M = \frac{m_{h_F}^F}{n_F}$.

ii) For all irreducible component P of $Q_J(M, i)$ and for all $F \in P_i^M$, $c(F, P) = M$.

iii) For all irreducible component P of $Q_J(M, i)$ and for all $F \notin P_i^M$ (this holds in particular when $F = g_k, 1 \leq k \leq \xi(g)$), $c(F, P) = c(F, P_i^M) < M$.

iv) For all $1 \leq k \leq \xi(f)$:

- If $f_k \in P_i^M$ then $\text{int}(f_k, Q_J(M, i)) = S(m^{f_k}, M) \frac{\deg_y Q_J(M, i)}{n_{f_k}}$.

- If $f_k \notin P_i^M$ then $\text{int}(f_k, Q_J(M, i)) = S(m^{f_k}, c(f_k, P_i^M)) \frac{\deg_y Q_J(M, i)}{n_{f_k}}$.

Proof. The proof is similar to the proof of Theorem 7.7. ■

Corollary 8.5 Assume that $\xi(f) = 1$, i.e. $f = f_1$ is an irreducible polynomial of $\mathbb{K}((x))[y]$, and let $M = \max_{k=1}^{\xi(g)} c(f, g_k)$. Let θ be the smallest integer such that $M < \frac{m_\theta^f}{n_f}$. If $\theta < h_f$, then $J = J(f, g) = \bar{J} \cdot \prod_{k=\theta}^{h_f} J_k$, where for all $\theta \leq k \leq h_f$,

i) $\deg_y J_k = (e_k^f - 1) \frac{n_f}{d_k^f}$.

ii) $\text{int}(f, J_k) = (e_k^f - 1) r_k^f$.

iii) For all irreducible component P of J_k , $c(f, P) = \frac{m_k^f}{n_f}$.

iv) For all $1 \leq j \leq \xi(g)$ and for all irreducible component P of J_k , $c(g_j, P) = c(g_j, f)$

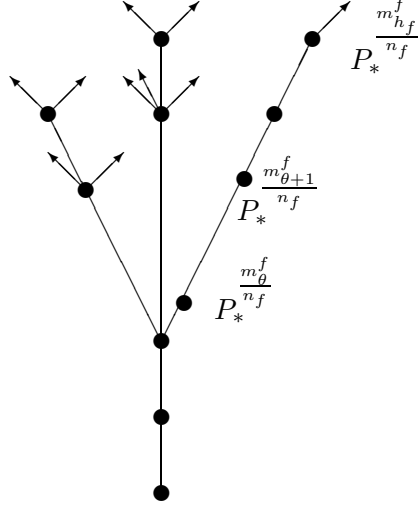

Proof. In fact, $T_f = \{P_1^{\frac{m_{\theta}^f}{n_f}}, \dots, P_1^{\frac{m_{h_f}^f}{n_f}}\}$. The result is consequently a particular case of Theorem 8.4. ■

9 Bad and good points on the tree of f

Let $f = y^n + a_1(x)y^{n-1} + \dots + a_n(x)$ be a monic reduced polynomial of $\mathbb{K}((x))[y]$, and let $f = f_1 \dots f_{\xi(f)}$ be the factorization of f into irreducible components in $\mathbb{K}((x))[y]$. We shall assume that f is generic in the following sense: for all irreducible component H of f_y , $\text{int}(f, H) \leq 0$.

Definition 9.1 Let F, G be two monic polynomials of $\mathbb{K}((x))[y]$, and let H be an irreducible monic polynomial of $\mathbb{K}((x))[y]$. We say that H is regular (resp. irregular) with respect to F if $\text{int}(F, H) \neq 0$ (resp. $\text{int}(F, H) = 0$). We define $\text{Reg}(G, F)$ (resp. $\text{Irreg}(G, F)$) to be the set of regular (resp. irregular) components of G with respect to F . Let $\gamma(x) \in \mathbb{K}((x^{\frac{1}{p}}))$, $p \in \mathbb{N}$. We say that γ is regular (resp. irregular) with respect to F if $O_x F(x, \gamma(x)) \neq 0$ (resp. $O_x F(x, \gamma(x)) = 0$). If $G = F_y$, then we write $\text{Reg}(F)$ (resp. $\text{Irreg}(F)$) for $\text{Reg}(F_y, F)$ (resp. $\text{Irreg}(F_y, F)$).

Lemma 9.2 We have $\text{Irreg}(f, f_y) = \emptyset$.

Proof. Let $1 \leq j \leq \xi(f)$ and let $y(x) \in \text{Root}(f_j)$. Let $M = \max_{k \neq j} c(f_j, f_k)$. By Lemma 4.4., $M = \max c(f_j, H)$, where H runs over the set of irreducible components of f_y . Since f is generic, then $\sum_{y \neq \bar{y} \in \text{Root}(f)} O_x(y - \bar{y}) + M \leq 0$. If $M < 0$, then $O_x(y - \bar{y}) \leq M < 0$ for all $\bar{y} \in \text{Root}(f)$, $\bar{y} \neq y$, in particular $\sum_{y \neq \bar{y} \in \text{Root}(f)} O_x(y - \bar{y}) < 0$. If $M > 0$, then $\sum_{y \neq \bar{y} \in \text{Root}(f)} O_x(y - \bar{y}) \leq -M < 0$. Finally $O_x f_y(x, y(x)) = \sum_{y \neq \bar{y} \in \text{Root}(f)} O_x(y - \bar{y}) < 0$, in particular $\text{int}(f_j, f_y) < 0$. This proves our assertion. ■

Definition 9.3 Let F, G be two monic polynomials of $\mathbb{K}((x))[y]$, and let H be an irreducible component of G . Assume that $H \in \text{Irreg}(G, F)$ and let $\gamma \in \text{Root}(H)$. We have $F(x, \gamma(x)) = \lambda + u(x)$ where $\lambda \in \mathbb{K}^*$ and $u(0) = 0$. In particular, $\text{int}(F - \lambda, H) > 0$, hence $H \in \text{Reg}(G, F - \lambda)$. We say that λ is an irregular value of F with respect to G . We define $\text{irreg}(F, G)$ to be the set of irregular values of F with respect to G . If $G = F_y$, then we write $\text{reg}(F)$ (resp. $\text{irreg}(F)$) for $\text{reg}(F_y, F)$ (resp. $\text{irreg}(F_y, F)$).

Definition 9.4 Let P_i^M be a point of $\text{Top}(f)$.

- i) We say that P_i^M is a good point if $H \in \text{Reg}(f)$ for some irreducible component H of $Q_{f_y}(M, i)$.
- ii) We say that P_i^M is a bad point if $H \in \text{Irreg}(f)$ for some irreducible component H of $Q_{f_y}(M, i)$.

Lemma 9.5 Let P_i^M be a point of $\text{Top}(f)$.

- i) If P_i^M is a good point, then for all irreducible component H of $Q_{f_y}(M, i)$, $H \in \text{Reg}(f)$.
- ii) If P_i^M is a bad point, then for all irreducible component H of $Q_{f_y}(M, i)$, $H \in \text{Irreg}(f)$.

Proof. i) By hypothesis, there is an irreducible component \bar{H} of $Q_{f_y}(M, i)$ such that $\text{int}(f, \bar{H}) < 0$. Let H be an irreducible component of $Q_{f_y}(M, i)$, and let $\gamma(x)$ (resp. $\bar{\gamma}(x)$) be a root of H (resp. \bar{H}) such that $\max_{i=1}^n c(\gamma, y_i) = M = \max_{i=1}^n c(\bar{\gamma}, y_i)$. We have:

$$O_x f(x, \gamma(x)) = \sum_{i=1}^n c(\gamma(x), y_i(x)) = \sum_{i=1}^n c(\bar{\gamma}(x), y_i(x)) = O_x f(x, \bar{\gamma}(x))$$

in particular $\text{int}(f, H) = \frac{1}{n_H} O_x f(x, \gamma(x)) < 0$.

- ii) The proof is similar to the proof of i). ■

10 Irregular values of a meromorphic curve

Let the notations be as in Section 9, and let $P_i^M = \{F_1, \dots, F_r\}$ be a bad point of $\text{Top}(f)$. For all irreducible component H of $Q_{f_y}(M, i)$, $\text{int}(f, H) = 0$, in particular, if $\gamma(x) \in \text{Root}(H)$, then $f(x, \gamma(x)) = \lambda + u(x)$, where $\lambda \in \mathbb{K}^*$ and $u(0) = 0$. In particular, $\lambda \in \text{irreg}(f)$. Let $\{\lambda_1(M, i), \dots, \lambda_{p(M, i)}(M, i)\}$ be the set of irregular values of f obtained from the components of $Q_{f_y}(M, i)$ as above -more precisely $\{\lambda_1(M, i), \dots, \lambda_{p(M, i)}(M, i)\} = \{\text{inco}(f(x, \gamma(x))) | \gamma(x) \in \text{Root}(Q_{f_y}(M, i))\}$. We have the following:

Proposition 10.1 Assume that $n_{F_1} = \max_{1 \leq i \leq r} n_{F_i}$.

- i) If (F_1, \dots, F_r) is equivalent and $M > \frac{m_{h_{F_1}}^{F_1}}{n_{F_1}}$, then $p(M, i) \leq r - 1$.
- ii) If (F_1, \dots, F_r) is equivalent and $M = \frac{m_{h_{F_1}}^{F_1}}{n_{F_1}}$, then $p(M, i) \leq r$.
- iii) If (F_1, \dots, F_r) is almost equivalent, then $p(M, i) \leq r - 1$.

Proof. i) Let H be an irreducible component of $Q_{f_y}(M, i)$. Since $c(H, F_1) = M > \frac{m_{h_{F_1}}^{F_1}}{n_{F_1}}$, then n_{F_1} divides n_H . On the other hand, by Theorem 7.9., $\deg_y Q_{f_y}(M, i) = (r - 1)n_{F_1}$. In particular, $\xi(Q_{f_y}(M, i)) \leq r - 1$. This proves our assertion.

ii) Let H be an irreducible component of $Q_{f_y}(M, i)$. Since $c(H, F_1) = \frac{m_{h_{F_1}}^{F_1}}{n_{F_1}}$, then $\frac{n_{F_1}}{d_{h_{F_1}}^{F_1}}$ divides n_H . More precisely, let $\gamma(x) = \sum_p c_p x^{\frac{p}{n_H}} \in \text{Root}(H)$, then one of the following holds:

- The coefficient of x^M in $\gamma(x)$ is nonzero, hence n_{F_1} divides n_H . In this case, we say that H is of type I.

- The coefficient of x^M in $\gamma(x)$ is zero, then we say that H is of type II.

Let H_1, H_2 be two irreducible components of type II of $Q_{f_y}(M, i)$. If $\gamma_1(x) \in \text{Root}(H_1)$ (resp. $\gamma_2(x) \in \text{Root}(H_2)$), then $c(y_i, \gamma_1) = c(y_i, \gamma_2)$, and $\text{inco}(y_i - \gamma_1) = \text{inco}(y_i - \gamma_2)$ for all $y_i \in \text{Root}(f)$. In particular, H_1 and H_2 give rise to the same irregular value of f . On the other hand, by Theorem 7.9., $\deg_y Q_{f_y}(M, i) = (r-1)n_{F_1} + (e_{h_{F_1}}^{F_1} - 1)\frac{n_{F_1}}{d_{h_{F_1}}^{F_1}}$, hence the number of irreducible components of $Q_{f_y}(M, i)$ of type I is bounded by $r-1$. This proves our assertion.

iii) The proof is similar to the proof of ii). ■

Corollary 10.2 Let f be as above. The number of irregular values of f is bounded by $\xi(f)$.

Proof. This results from Proposition 10.1. ■

Remark 10.3 Let the notations be above. If $\text{irreg}(f)$ has exactly $\xi(f)$ elements, then for all $P_i^M \notin \text{Top}(f)$, $D_i^M = \emptyset$. More precisely, it follows from the proof of Proposition 10.1. that the cardinality of $\text{irreg}(f)$ is bounded by

$$\sum_{P_i^M \in \text{Top}(f)} \text{card}(P_i^M)$$

In particular, if $\text{card}(\text{irreg}(f)) = \xi(f)$ then for all $1 \leq i \leq \xi(f)$, $f_i \in P_i^M$ for some bad point $P_i^M \in \text{Top}(f)$. Furthermore, given a bad point $P_i^M = \{F_1, \dots, F_r\} \in \text{Top}(f)$, the following holds:

i) (F_1, \dots, F_r) is equivalent, and $M = \frac{M_{h_{F_1}}^{F_1}}{n_{F_1}}$.

ii) $Q_{f_y}(M, i) = H_1 \dots H_{r+1}$ and for all $i = 1, \dots, r$, H_i is irreducible of degree n_{F_1} and H_i is equivalent to F_1 . Furthermore, $\text{int}(H_{r+1}, F_1 \dots F_r) = (e_{h_{F_1}}^{F_1} - 1)r_{h_{F_1}}^{F_1}$.

We do not have examples of meromorphic plane curve satisfying the properties above, and we think that such an example does not exist. More precisely, we think that the tree of a meromorphic plane curve which is generic in its family must have at least one good point.

Remark 10.4 Suppose that $T(f)$ has only one bad point P_i^M , and that $\text{irreg}(f)$ has $\xi(f)$ elements (in particular $P_i^M = \{f_1, \dots, f_{\xi(f)}\}$). With the notations of Remark 10.3., if $\xi(f) > 1$ (resp. $\xi(f) = 1$), then we have $\text{int}(H_1, f) = 0 = \xi(f)r_{h_{f_1}}^{f_1}$ (resp. $\text{int}(H_1, f) = 0 = (e_{h_{f_1}}^{f_1} - 1)r_{h_{f_1}}^{f_1}$), which is a contradiction. This implies that if f has only one bad point, then $\text{card}(\text{irreg}(f)) \leq \xi(f) - 1$, and this bound is sharp (let $f = y^4 + x^{-1}y^2 + y + 1 : \xi(f) = 2$, $T(f)$ has one bad point and one good point, and $\text{card}(\text{irreg}(f)) = 1$).

As a particular case, if f is irreducible, then $\text{irreg}(f) = \emptyset$. Note that if $f \in \mathbb{K}[x^{-1}, y]$, then f is irreducible in $\mathbb{K}((x))[y]$ if and only if $f(x^{-1}, y) \in \mathbb{K}[x, y]$ has one place at infinity. In this case, the assertion above is a consequence of the Abhyankar-Moh theory.

References

- [1] S.S. Abhyankar.- On the semigroup of a meromorphic curve, Part 1, in Proceedings, International Symposium on Algebraic Geometry, Kyoto (1977), pp. 240-414.
- [2] S.S. Abhyankar and A. Assi.- Jacobian of meromorphic curves, Proc. Indian Acad. Sci. Math. Sci. 109, no. 2 (1999), 117-163.
- [3] A. Assi.- Sur l'intersection des courbes méromorphes, C. R. Acad. Sci. Paris Sér. I Math. 329 (1999), n^o 7, 625-628.
- [4] A. Assi.- Meromorphic plane curves, Math. Z. 230 (1999), no. 1, 16-183.
- [5] F. Delgado de la Mata.- A factorization theorem for the polar of a curve with two branches, Compositio Mathematica, 92 (1994), pp. 327-375.
- [6] F. Delgado de la Mata.- An arithmetical factorization for the critical point set of some map germs from \mathbb{C}^2 to \mathbb{C}^2 , London Math. Soc., Lecture Note Ser., 201 (1994), pp. 61-100.
- [7] E.R. García Barroso.- Sur les courbes polaires d'une courbe plane réduite, Proc. London Math. Soc. (3), 81, no.1 (2000) pp. 1-28.
- [8] T.C. Kuo and Y.C. Lu.- On analytic function germs of two complex variables, Topology 16 (1977), pp. 299-310.
- [9] H. Maugendre.- Discriminant of a germ $\mathbb{C}^2 \mapsto \mathbb{C}^2$ and Seifert brief manifolds, J. London Math. Soc. (2), vol 59, no. 1 (1999), pp. 207-226.
- [10] H. Maugendre.- Discriminant d'un germe $(g, f) : (\mathbb{C}^2, 0) \mapsto (\mathbb{C}^2, 0)$ et quotients de contact dans la résolution de fg , Ann. Fac. Sci. Toulouse Math. (6) 7, no. 3 (1998), pp. 497-525.
- [11] M. Merle.- Invariants polaires des courbes planes, Inventiones Mathematics 41 (1977), pp. 299-310.
- [12] C.T.C. Wall.- Singular points of plane curves, LMS Student Texts, 63, Cambridge University Press, 2004.
- [13] O. Zariski.- Le probleme des modules pour les branches planes, Lectures at Centre de Mathématiques, Ecole Polytechnique, Notes by F. Kmety and M. Merle, 1973.