

Neuron as an emotion-modulated combinatorial switch and a model of human and animal learning behavior

Marat M. Rvachev *

March 5, 2012

Abstract

This theoretical paper proposes a neuronal circuitry layout and synaptic plasticity principles that allow the (pyramidal) neuron to act as a combinatorial switch, whereby the neuron learns to be more prone to generate spikes given those combinations of firing input neurons for which a previous spiking of the neuron had been followed by a positive emotional response; the emotional response is mediated by certain modulatory hormones or neurotransmitters, e.g., the dopamine. More generally, a trial-and-error learning paradigm is suggested in which the purpose of emotions is to trigger long-term enhancement or weakening of a neuron's spiking response to the preceding synaptic input firing pattern. Thus, emotions provide a feedback pathway that informs neurons whether their spiking was beneficial or detrimental for a particular input combination. The neuron's ability to discern specific combinations of firing input neurons is achieved through a random or predetermined spatial distribution of input synapses on dendrites that creates synaptic clusters that represent various permutations of input neurons. The corresponding dendritic segments, or the enclosed individual spines, are capable of being particularly excited, due to local sigmoidal thresholding involving voltage-gated channel conductances, if the segment's excitatory and absence of inhibitory inputs are temporally coincident. Such nonlinear excitation corresponds to a particular firing combination of input neurons, and it is posited that the excitation strength reflects the combinatorial memory and is regulated by long-term plasticity mechanisms. It is also suggested that the spine calcium influx that may result from the spatiotemporal synaptic input coincidence may cause the spine head actin filaments to undergo mechanical (muscle-like) contraction, with the ensuing cytoskeletal deformation transmitted to the axon initial segment where it may modulate the global neuron firing threshold. Relation between the emotion-modulated multi-neuron combinatorial switching and cognitive tasks such as the associative grouping and abstract deduction is discussed.

1 Introduction

The field of reinforcement learning (RL) solves the problem of sequential decision making by an agent receiving delayed numerical rewards [1]. The field can be viewed as originating from two major threads: the idea of learning by trial and error that started in the psychology of animal learning (e.g., [2]), and the problem of optimal control and its solution using value

*Address: 677 Washington Blvd., Stamford, CT 06901, USA. Email: rvachev@alum.mit.edu

functions and dynamic programming [3]. An important application of the RL theory is the temporal difference (TD) class models for the phasic activity of midbrain dopamine neurons [4, 5, 6]. The dopamine activity is believed to encode a reward prediction error (RPE) signal that guides learning in the frontal cortex and the basal ganglia [7, 8, 9, 10]. Most scholars active in dopamine studies believe that the dopamine signal adjusts synaptic strengths in a quantitative manner until the subject’s estimate of the value of current and future events is accurately encoded in the frontal cortex and basal ganglia [11].

In contrast to the RL field, this paper considers the problem of instantaneous decision making by an agent receiving immediate rewards. A trial-and-error learning paradigm is suggested in which the reward signal modulates memory in (cortical) neurons that act as combinatorial switches. The reward signal may come from an "elementary" reward generator such as that reflecting pain or satisfaction of hunger; it may also involve an RPE-type signal mediated by dopamine and/or other agents that could convey positive as well as negative reward components as was first suggested in [12].

The first contributing thread to the presented model, as in the RL field, is the idea of learning by trial and error and reinforcement of favorable outcomes. The idea, as expressed in Edward Thorndike’s "Law of Effect" [2], is: "Of several responses made to the same situation those which are accompanied or closely followed by satisfaction to the animal will, other things being equal, be more firmly connected with the situation, so that, when it recurs, they will be more likely to recur; those which are accompanied or closely followed by discomfort to the animal will, other things being equal, have their connections to the situation weakened, so that, when it recurs, they will be less likely to occur. The greater the satisfaction or discomfort, the greater the strengthening or weakening of the bond." This idea is widely regarded as a basic principle underlying much behavior [13, 14, 15, 16]. In this paper, the "satisfaction" and "discomfort" are collectively referred to as the "emotional response".

The second contributing thread is a novel idea that, given proper neural circuitry layout, pyramidal neurons can process information by switching the neuron output based on active input neuron combinations. Additional computational advantages that could make this possible may be provided by mechanical force generated at the dendritic spines and stretch-activation of Na^+ channels at the axon initial segment. An interesting feature of the presented framework is its ability to distil reusable abstract concepts about the environment, making learning with a low-dimensional feedback signal (the emotional response) efficient.

1.1 Problem formulation

The following organism-level learning problem is posed. For simplicity, the neuronal activity states are considered to be binary: "firing" or "not firing". Given an arbitrary combination S of firing neurons in a (perhaps sensory) neuronal layer L_1 , activate a corresponding "optimal" combination $R^*(S)$ of firing neurons in a (perhaps motor) neuronal layer L_2 (Fig. 1(a)). The optimal combination $R^*(S)$ is defined as one that produces the motor behavior that results in a positive emotional response E in the organism. As such, $R^*(S)$ can be an arbitrary combination of firing L_2 neurons from a combinatorics perspective. The emotional response E , in biological terms, is posited to be mediated by certain modulatory neurotransmitters or hormones that are diffusely delivered to a large number of generally trainable neurons. It is assumed that E can be activated by evolutionarily hardwired circuits, such as when hunger is

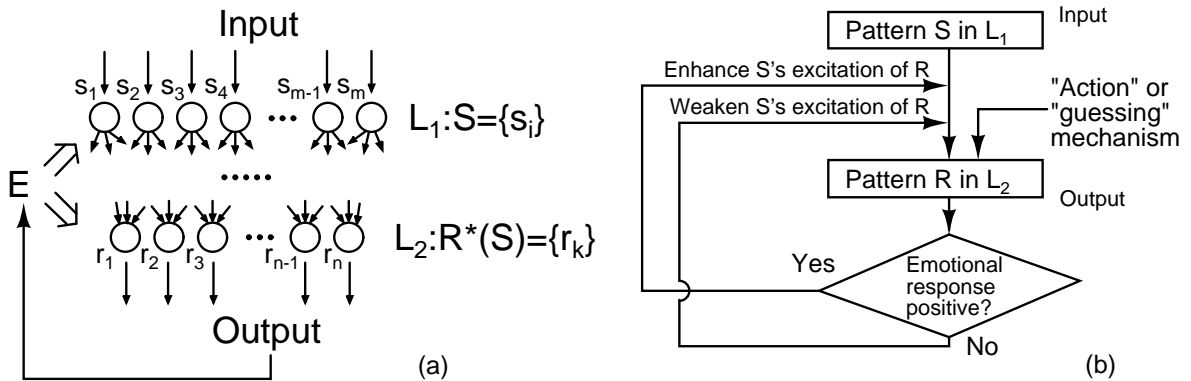

Figure 1: The organism-level learning problem and an outline of the suggested solution. (a) Formulation of the problem. Neurons s_i , $i = 1, \dots, m$ in layer L_1 connect to neurons r_k , $k = 1, \dots, n$ in layer L_2 . A pattern of excitations $S = \{s_i\}$, if responded to by a pattern of excitations $R = \{r_k\}$, elicits a positive or negative emotional response E resulting from the interaction of the generated motor behavior with the environment. The problem is: given an arbitrary S , excite $R^*(S)$ that would lead to positive E . (b) Outline of the suggested solution. Learning proceeds by trial and error. Excitation of pattern S excites a pattern $R(S)$, possibly with the help of an "action" mechanism (e.g., depolarization to all L_2 neurons until a certain level of the aggregate L_2 output activity is achieved, as discussed in Sec. 2.3). A "guessing" mechanism introduces variations in the excited patterns R . S 's excitation of those R that lead to positive (negative) E is enhanced (weakened).

satisfied, as well as by higher mental processes, e.g., due to the organisms' subjective evaluation of the motor behavior as satisfactory given the sensory inputs.

It is suggested that the learning process proceeds in a trial-and-error fashion. Given a firing combination S in L_1 , variations are introduced in the firing combination R in L_2 , with the S 's excitation of those R that lead to positive E being enhanced while S 's excitation of those R that lead to negative E being weakened (Fig. 1(b)). Details of this suggested process are discussed in more detail in Sec. 5. First, a more elementary learning task is considered: given an arbitrary combination S of firing neurons in a (perhaps sensory) neuronal layer L_1 , long-term strengthen activation of a neuron r_k , specifically by S , in a (perhaps motor) neuronal layer L_2 , if the subsequent emotional response E is positive. Conversely, long-term weaken activation of r_k , specifically by S , if E is negative (Fig. 2).

2 Solution to the single-neuron combinatorial switching problem

2.1 Local dendritic integration as the basis for combinatorial memory

The following mechanism is posited as the solution and is illustrated in Figs. 3 and 4. L_1 neurons connect to the r_k dendrites at random or predetermined locations, forming spatially

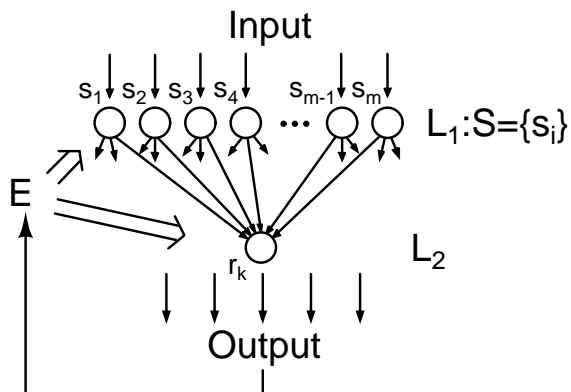

Figure 2: The single-neuron learning problem. L_1 neurons s_i connect to an L_2 neuron r_k . Enhance (weaken) r_k excitation by those combinations S for which the following r_k excitation resulted in a positive (negative) E .

localized (and possibly overlapping) "synapse neighborhoods" N_j that contain various permutations of input neurons (Fig. 3). Sufficient depolarization of the dendritic and/or spine interior within the j th neighborhood, caused by the temporal coincidence of the neighborhood's excitatory and absence of inhibitory inputs, produces the memory factor M_j that can meaningfully contribute to the r_k excitation relative to the other drivers of neuronal stimulation. The M_j magnitude is modifiable by long-term potentiation (LTP)-related plasticity mechanisms that are regulated by, in addition to the known LTP-modulating factors such as back-propagating action potentials (BPAPs) [17, 18], the emotional response E received by the cell following the local N_j excitation. More specifically, it is suggested that the receipt of positive (negative) E at N_j , if it was closely preceded by a BPAP at N_j that itself immediately followed the local N_j excitation, results in a long-term enhancement (inhibition) of the M_j magnitude via the LTP (long-term depression, LTD) induction in the activated spines. That is, a positive (negative) E signals to induce LTP (LTD) in the spines that had collectively contributed to the local N_j excitation that itself contributed to the r_k firing.

Two possible physical realizations of the combinatorial memory (i.e., the memory of the r_k 's response to a specific combination of firing input neurons) are considered next. The memory mechanism can be predominantly electrical, that is, related to the local electrical synaptic integration in dendrites [19, 20], and/or mechanical. Regardless of the mechanisms, what is essential for the presented model is that 1) the memory factor M_j is specifically expressed given the spatiotemporal coincidence of inputs, conferring M_j the combinatorial nature, 2) compared to the other drivers of neuron stimulation, M_j can substantially contribute to the r_k excitation and 3) long-term regulation of M_j magnitude is critically dependent on the type of E received by the cell immediately following the M_j expression.

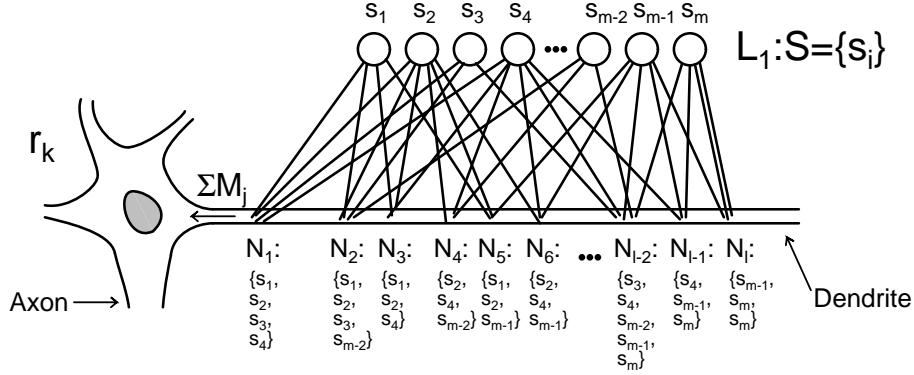

Figure 3: Solution to the single-neuron learning problem shown in Fig. 2. Synapses from neurons s_i form spatially localized clusters, or "neighborhoods", N_j on the r_k dendrites. In the figure, a collection of s_i s below an N_j denotes neurons projecting into the cluster. Activation of excitatory synapses simultaneous with a lack of activation of inhibitory synapses in a cluster N_j produces the memory factor M_j that can significantly contribute to the r_k excitation. Factors M_j generated at all r_k neighborhoods superimpose. M_j expression is regulated as suggested in Fig. 4.

2.2 Possible physical realizations of the combinatorial memory

2.2.1 Mechanical (muscle-like) mechanism

An interesting M_j realization is possible if the free calcium entering a spine during a spatiotemporal synaptic input coincidence event elicits spine actin filament contraction, e.g., through calcium-activated actin interaction with myosin or another actin-binding protein. The ensuing cytoskeletal and cytoplasmic stresses, the magnitudes of which could encode the combinatorial memory, could be transmitted along the dendritic shaft to the r_k 's axon initial segment (Fig. 5). At the initial segment these stresses, superimposed with those generated at other dendritic sites, could regulate the global r_k excitation threshold via stretch-modulating Na^+ voltage-gated ion channels (Nav) [21, 22]. The use of mechanical force would provide a second dimension to the neuron's computational machinery, disentangling the spatiotemporal coincidence detection mechanism, which would be electrical and based on local nonlinear voltage summation, from the M_j readout mechanism, which would be mechanical. The spine head volume and the associated quantity of actin filaments would then reflect the M_j magnitude, rather similarly to how the muscle cell volume and strength reflects the memory of previous exercise.

Several observations favor the mechanical model for pyramidal neurons. Morphologically, unlike many other neuron types, pyramidal neurons have rather straight dendrites that tend to branch at small angles. This should facilitate the transmission of the cytoskeletal and cytoplasmic deformation via the microtubule tug and cytoplasmic pressure spread, respectively. Interestingly, the dendritic shaft microtubules invade the spines, where they likely link to the actin cytoskeleton [23, 24]. This structural linkage, together with the rigid linear structure of

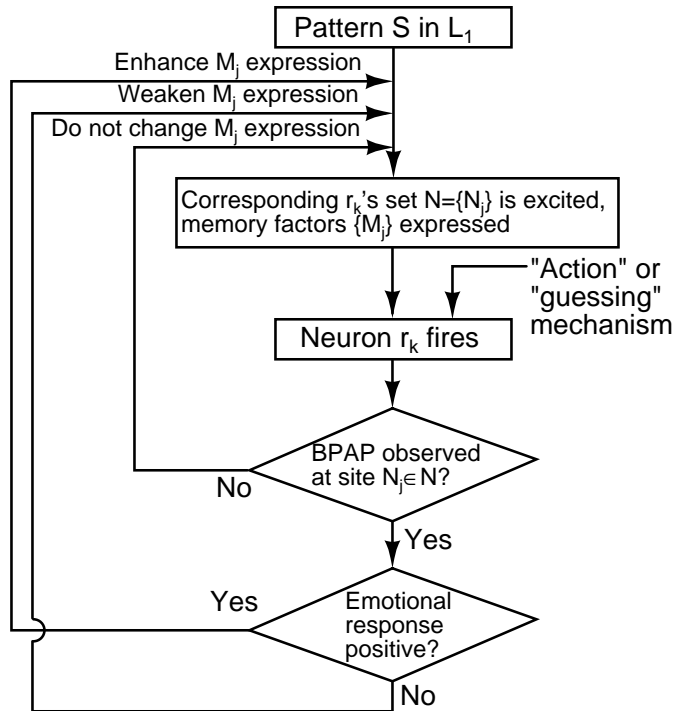

Figure 4: Suggested learning rules for the memory factors M_j . The excitation of a neuronal firing pattern S in L_1 leads to the excitation of the corresponding set of neighborhoods N_j in r_k . A memory factor M_j is long-term enhanced (weakened) if the neighborhood N_j is excited by the firing of the corresponding combination of input neurons, this is closely followed by a BPAP at N_j , and the following E is positive (negative).

the microtubules, may also facilitate the transmission of the cytoskeletal stresses originating in the spines. The number of spines involved can potentially range from as little as one to as many as hundreds if the whole thin terminal dendrite branches participate in the local postsynaptic integration [19, 25, 26, 27]. The resulting stretch activation at the axon initial segment may act in a digital manner, providing a feedback signal that a structural modification has occurred somewhere in the dendritic tree, much like a back-propagating action potential is thought to tell the neuron the axon has fired. This could in principle solve the problem of distance-dependent synaptic integration [28].

A pressure wave packet of 1 ms duration propagating in the cytoplasm of an unmyelinated axon of 1 μm diameter has the velocity of 1.1 m/s and decay length of 0.18 mm [22]. For a cytoplasmic pressure wave packet of 1 ms duration propagating in a dendrite of 1 μm diameter the velocity and decay length should be similar, assuming that the specific mechanical properties for the unmyelinated axon and the dendrite are close. The pressure wave velocity and decay length should scale with the wave frequency ω and the dendrite diameter d as $\sqrt{\omega d}$ and $\sqrt{\frac{d}{\omega}}$, respectively [22] (see also [29]). Therefore, a 10 ms pressure pulse in a 1 μm -diameter

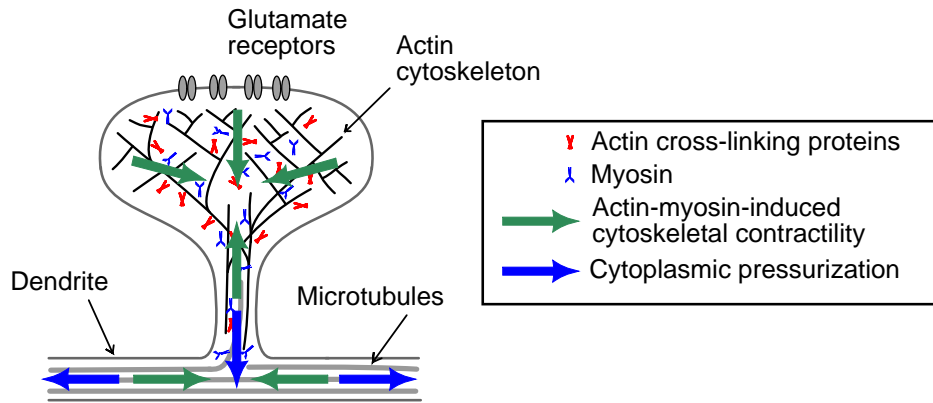

Figure 5: The influx of Ca^{2+} into a spine could elicit (muscle-like) contraction in the spine’s actin cytoskeleton. The ensuing cytoskeletal stresses are shown as green arrows, and the cytoplasmic pressure gradient as blue arrows. The mechanical deformations could propagate along the dendrite, as shown. At the axon initial segment, the deformations could modulate the global neuron firing threshold.

dendrite should propagate at 0.35 m/s and with 0.57 mm decay length; a 100 ms pressure pulse should have 0.11 m/s velocity and 1.8 mm decay length. These values are consistent with the idea that mechanical forces can be transferred through the lengths of the pyramidal neuron dendrites and that the forces can be produced and transmitted sufficiently rapidly so as to be associated with the spike initiating event.

Given these observations, it is suggested that the mechanical model for the combinatorial memory (i.e., the mechanical modulation of the global neuron firing threshold using the local voltage summation nonlinearity for the spatiotemporal synaptic input coincidence detection), may have evolved relatively recently, culminating in the pyramidal neuron in higher animals, to enable the neuron to more specifically respond to the combinatorial aspects of inputs. It is also suggested that the spine actin cytoskeleton contractility may be local to the spine or the neighborhood, where it may effect the readout of the combinatorial memory by stretch-modulation of gating of the membrane ion channels. Note that the mechanical memory readout model confers functional roles to the spine head volume and the high actin content of the spine, which are still enigmatic [28, 24, 30].

2.2.2 Electrical mechanism

The memory factors M_j can also be interrelated with the sigmoidal thresholding of the locally summed postsynaptic potentials (PSPs) [19, 25, 26]. The sigmoidal thresholding results from the activation of voltage-gated calcium channels (Cav) and/or N-methyl-D-aspartate (NMDA) receptor calcium conductances [19, 25, 26]. Here, the memory factors M_j can be somewhat loosely defined as the excess of the local supralinear input summation over an “untrained” summation (Fig. 6).

It has been shown in vitro that the spine calcium influx via NMDA receptors (NMDAR),

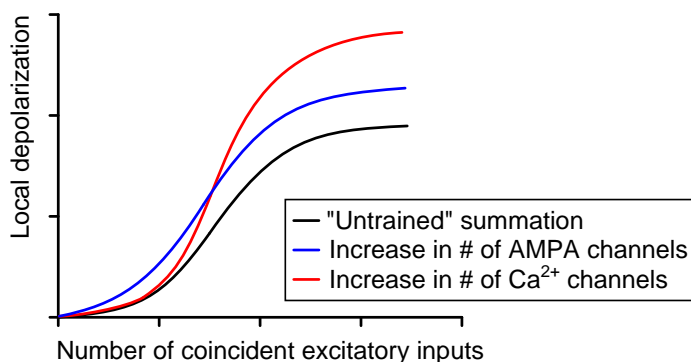

Figure 6: Local electrical summation of PSPs. Black curve: local depolarization as a function of the number of coincident excitatory inputs for "untrained" summation. The nonlinear boosting is due to the activation of local voltage-gated conductances [19, 25, 26]. Blue: the boosting threshold is lowered and the summation plateau is raised as a result of the LTP-associated increase in the number of AMPA receptors in a neighborhood synapse. Red: the boosting threshold is little changed while the summation plateau is raised as a result of the LTP-associated increase in the number of Cav channels in a neighborhood synapse.

when closely followed by postsynaptic spikes mimicking BPAPs, causes LTP induction that enlarges the spine [17]. Although these experiments used single-spine stimulation, it is likely that the NMDAR calcium influx caused by a spatiotemporal synaptic input coincidence should also elicit LTP and enlargement in the affected spines, when closely followed by a BPAP.

The LTP and the associated spine enlargement could confer the combinatorial memory in two ways. First, the LTP-associated increase in synapse efficacy, via an increase in the number of α -amino-3-hydroxy-5-methyl-4-isoxazole propionic acid (AMPA) glutamate receptors [28], should lower the local boosting threshold and raise its summation plateau (Fig. 6). Second, the summation plateau should be raised as the peak Cav conductance is increased due to the greater numbers of Cav channels in the non-synaptic-cleft spine membrane given that the linear spine dimensions are enlarged. In the latter case, the sigmoidal summation threshold is not likely to be significantly altered, as the Cav conductance is activated only given the threshold Cav depolarization is reached. It should be noted that the spines in which the combinatorial memory M_j can be structurally realized via LTP should probably be located centrally in the neighborhood N_j , so that their boosted excitation is more likely to be indicative of a synaptic input coincidence in the neighborhood.

2.3 Neuronal circuitry layout

Within the framework outlined above, the output of r_k can be approximately described as

$$y = r_k \left(\left(\sum_i w_i x_i \right) + \sum_j w'_j \left(F_j \left(\sum_i v_{ij} x_i \right) + M_j^{(e)} \left(\sum_i v_{ij} x_i \right) \right) \right. \\ \left. \sum_j w''_j M_j^{(m)} \left(\sum_i v_{ij} x_i \right) \right), \quad (1)$$

where x_i represents the i th neuron input, w_i its linear weight in the r_k 's initial segment depolarization, v_{ij} the weight of x_i in the N_j depolarization, $F_j()$ the excess of the "untrained" local sigmoidal voltage summation at the neighborhood N_j over the linear summation ($F_j()$ is negative in the sublinear regime), $M_j^{(e)}()$ the "electrical" combinatorial memory factor contribution to the N_j depolarization, w'_j the weight of F_j and $M_j^{(e)}$ in the r_k 's initial segment depolarization, $M_j^{(m)}()$ the "mechanical" combinatorial memory factor generated at the neighborhood N_j and w''_j the weight of $M_j^{(m)}$ in the modulation of the initial segment ion channels. As a function of its first argument, $r_k()$ behaves similarly to a two-layer neural network with a global sigmoidal output nonlinearity [19, 25, 26] while the second argument modulates the global sigmoid shape and threshold position. In the following, $M_j^{(e)}$ and $M_j^{(m)}$ are collectively referred to as M_j .

Fig. 7(a) shows suggested neuronal circuitry layout for the r_k learning process and the combinatorial memory readout. It is assumed that in an untrained organism presented with an S in L_1 , the classical postsynaptic integration coupled with the factors M_j does not suffice to excite r_k . In a learning trial, r_k is activated by additional depolarization created by increased excitation or reduced inhibition from one or more "guess" (G) or "action" (A) neurons that connect to r_k in dominant positions, such as near the axon initial segment. Alternatively, the "guess" or "action" neurons could connect to r_k at the apical tuft, where they could generate the Ca^{2+} dendritic spikes propagating towards the soma and driving initiation of the action potentials [28]. It is suggested that each of the "motor" neurons L_2 is structurally connected to L_1 in a similar, although not necessarily identical, manner, such as when closely spaced L_2 neurons sprawl basal dendrites in the same plane, into which L_1 axons diffusely and randomly project (Fig. 7(a)). This connectivity would be conducive to increasing the learning power of the system, as each L_2 neuron would roughly be equal in its ability to learn how to react to an arbitrary combination S . In an untrained system, given an S in L_1 , all L_2 neurons should be similarly close to the activation threshold as described by Eq. 1. Following learning, the L_2 neurons trained to react positively to S should be closer to the activation threshold than others. The actual combinatorial memory readout could proceed using the "action" neurons that deliver similar rising levels of depolarization to all L_2 neurons, e.g., via somatic or apical tuft connections, until a certain level of the aggregate L_2 output activity is achieved.

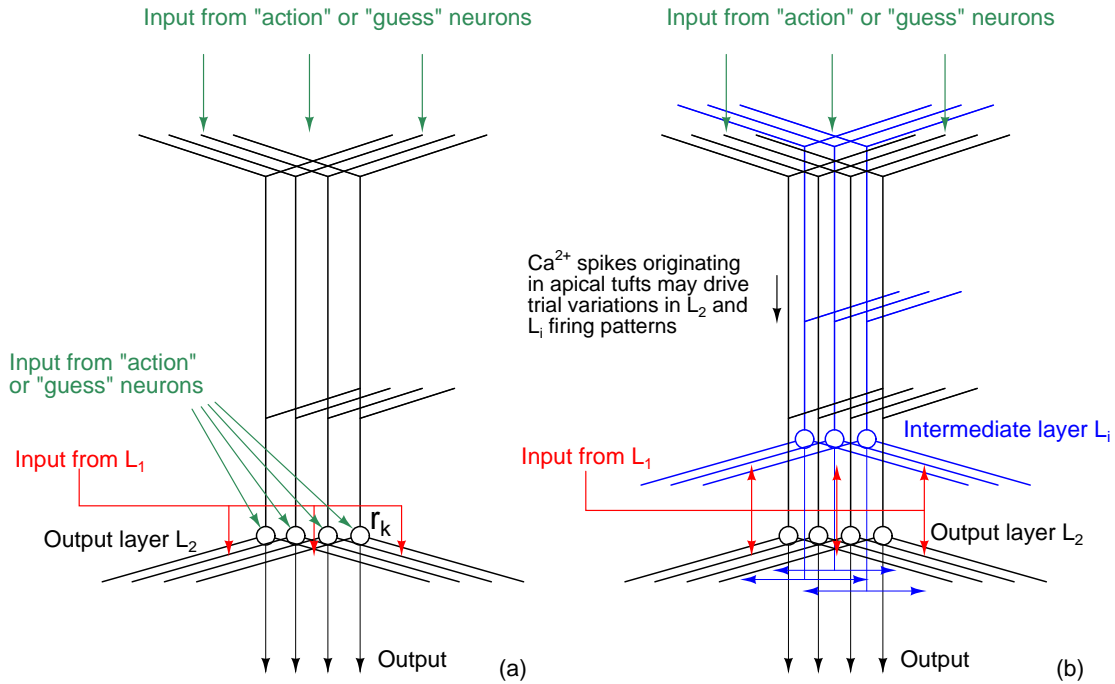

Figure 7: Suggested neuronal architecture for the learning process and the combinatorial memory readout. (a) Learning with two layers, L_1 (red) and L_2 (black). Input from L_1 diffusely projects into L_2 dendrites that are arranged in a layer. The "guess" and "action" inputs (green) connect at the soma or the apical tufts. (b) Learning with an added intermediate layer L_i (blue). Layer L_1 diffusely projects into both L_2 and L_i while L_i diffusely projects into L_2 . The "guess" and "action" neurons connect at the apical tufts. First, L_i neurons learn to fire for the important to the organism combinations S in L_1 . The reduced dimensionality signals are then used in further L_2 learning. In the neocortex, L_2 could correspond to the layer V pyramidal neurons, while L_i to the layer II/III pyramidal neurons.

3 Abstract deduction and associative grouping stemming from combinatorial switching

Consider a situation in which L_1 contains m excitatory neurons, each of which drives excitation of a corresponding inhibitory neuron in layer L'_1 , and both L_1 and L'_1 neurons innervate L_2 . Then, for an arbitrary L_1 combination $S_i^{(p)}$ consisting of p neurons with q firing neurons and $p - q$ silent neurons ($m \geq p \geq q \geq 1$), in principle, it is possible to construct a local synaptic neighborhood N_j that expresses the nonlinear memory factor M_j given $S_i^{(p)}$ and only $S_i^{(p)}$ is realized in the p neurons. In its simplest form, such N_j consists of q excitatory connections from the q firing neurons and $p - q$ inhibitory connections from the L'_1 neurons that are driven by the $p - q$ silent L_1 neurons, with the neighborhood geometry and membrane conductances tuned such that the memory factor M_j is expressed only when all excitatory and no inhibitory synapses are active in N_j .

More generally, it is evident that the neighborhoods N_j can be the sites of deduction and storage of information about combinatorial aspects of inputs. Suppose that the combinations $S_1^{(p)}, S_2^{(p)}, \dots, S_t^{(p)}$, realized in a certain set of p neurons in L_1 , if responded to by r_k activation, elicit positive E while some other combinations $S_{t+1}^{(p)}, S_{t+2}^{(p)}, \dots$ in the p neurons, if responded to by r_k activation, elicit negative E . Further, suppose that the combinations $S_1^{(m-p)}, S_2^{(m-p)}, \dots$ in the remaining $m-p$ neurons in L_1 do not affect E , if responded to by r_k activation. It is easy to show that, after a series of learning trials when r_k is activated (e.g., by G) following the presentation of random sets of inputs (i.e., random $S \in S_{i'}^{(p)} \times S_{i''}^{(m-p)}$), those M_j that reflect the features of $S_1^{(p)}, S_2^{(p)}, \dots, S_t^{(p)}$ are likely to be the most strengthened while those M_j that reflect the features of $S_{t+1}^{(p)}, S_{t+2}^{(p)}, \dots$ are likely to be the most weakened.

Indeed, if all possible combinations $S_{i'}^{(p)} \times S_{i''}^{(m-p)}$ are presented to the organism sequentially, each followed by the r_k activation, from the suggested rules for M_j plasticity it follows that those M_j that reflect the features of $S_1^{(p)}, S_2^{(p)}, \dots, S_t^{(p)}$ will be the most strengthened while those M_j that reflect the features of $S_{t+1}^{(p)}, S_{t+2}^{(p)}, \dots$ will be the most weakened. Therefore, if the random sampling of $S \in S_{i'}^{(p)} \times S_{i''}^{(m-p)}$ is unbiased, the above probabilistic statement regarding r_k learning is true.

In the above example, the strengthening of the factors M_j corresponding to, e.g., the pattern $S_1^{(p)}$ can be considered a form of abstract deduction, or deductive reasoning, about which elements of the inputs $S_{i'}^{(p)} \times S_{i''}^{(m-p)}$ need to be responded to by the r_k activation in order to achieve a positive E . Note that the pattern $S_1^{(p)}$ may not be realizable in L_1 without some context provided by $S_{i''}^{(m-p)}$. Therefore, $S_1^{(p)}$ and the corresponding $\{M_j\}$ may represent an abstract concept that does not occur on its own in the input environment. Also, the training of r_k creates a form of associative grouping, or pattern classification. Indeed, $S_1^{(p)}, S_2^{(p)}, \dots, S_t^{(p)}$ is a group of L_1 excitation patterns that become associated in their excitatory action on r_k . It is interesting that the same cell r_k can learn how to respond to a variety of unrelated input combinations, as each neighborhood N_j is structurally independent.

The more specific M_j s exist for a pattern $S_1^{(p)}$, the more specific the memory of $S_1^{(p)}$ can be. Lets assume that the r_k 's clusters N_j consist of excitatory synapses only and that in order to express a cluster's memory factor M_j all the cluster's synapses have to be excited. The following question is posed: for L_1 consisting of p excitatory neurons, q typical firing pattern size ($q < p$), C synapses per cluster and random L_1 to r_k connectivity, what is the frequency ν of occurrence of clusters that completely represent a particular L_1 excitation pattern? Approximately, the frequency of occurrence of clusters that consist of inputs all belonging to a particular pattern of size q is $(\frac{q}{p})^C$, while one needs at least $\frac{q}{C}$ clusters to encode a pattern of size q , leading to $\nu \approx \frac{C}{q} (\frac{q}{p})^C$. Note that, as expected, for $C = 1$, i.e., non-clustered inputs, this leads to $\frac{C}{\nu} = p$ synapses needed to represent an arbitrary pattern. For $q = C$, i.e., exact pattern encoding, one needs $\frac{C}{\nu} = q(\frac{p}{q})^q$ synapses.

Using the above formulas and assuming, for the sake of argument, $p = 100$ and $q = 10$, the number of a neuron's input synapses needed to fully represent an arbitrary pattern is 10^{C+1} . Comparing this to $I = 50,000$, the number of contacting synapses for a pyramidal neuron [28], would suggest the cluster size of not more than 3 to 4. Note that for $p = 100$, $q = 10$ and

$C = 3$, roughly $\frac{50,000}{C}(\frac{q}{p})^C \approx 16.7$ clusters are excited on average on a single output neuron for the typical L_1 firing pattern. For larger cluster sizes, one would need roughly $\frac{C}{q}(\frac{p^C}{Iq^{C-1}})^{\frac{q}{C}}$ output neurons similarly connected to L_1 in order for at least one of them to have a full representation of an input firing pattern of size q .

On the other hand, as discussed in Sec. 6, most of the learned activity of higher organisms could be considered a form of combinatorial switching if the combinatorial switching idea is taken to its logical extreme. Then, the language, as an artificial human construct designed for ease of communication, should reflect the switching dynamics that the involved neurons and their neighborhoods are "comfortable" operating on. There are about 40-50 sounds in a typical language and 4-5 sounds in a typical word, which may suggest, roughly, 4-5 as the typical pattern size (q), and 40-50 as the number of input neurons (p). Here for simplicity the issue of sound ordering within words is ignored. Using the formulas above with $q = 5$ and $p = 50$, the approximate number of contacting synapses per neuron needed to represent an arbitrary word is $5 \cdot 10^C$. Again, comparing this to the experimentally observed 50,000 synapses per neuron suggests the cluster size of not more than 4. Note that one could also hypothesize that q (and p) can be related to the number of syllables comprising a typical word, the number of words in a typical sentence, and the number of the elements in the writing of a typical letter.

4 Training of intermediate layers

To further reduce the dimensionality of inputs, through encoding of frequently occurring and significant to the organism neuronal excitation patterns, an intermediate layer L_i could be trained using the neuronal architecture suggested in Fig. 7(b). The "sensory" layer L_1 axons randomly project into the basal (and possibly proximal apical) dendrites of both the intermediate layer L_i and the "motor" layer L_2 while the L_i axons randomly project into the L_2 basal (and possibly proximal apical) dendrites. The apical tufts of both L_i and L_2 receive the guessing and action driving signals emanating from distal brain areas. Note that the sprawling planar arrangement of basal dendrites of L_i and L_2 neurons and a random distribution of contacting synapses should increase the learning power of the system, as discussed in Sec 2.3.

First, some L_2 neurons are trained to respond to certain L_1 combinations of firing neurons. As a side effect, some L_i neurons learn to become more responsive to the frequently occurring L_1 patterns that are followed by positive E . This learning could occur even in the absence of BPAP in the L_i neurons if the LTP can be induced only by the local (e.g., NMDA-recruiting) postsynaptic boosting and the subsequent receipt of positive E . Then, the trained L_i neurons could themselves be fired by the guessing or action mechanisms given the presentation of the learned L_1 patterns and thus make the reduced dimensionality inputs available to L_2 neurons for further learning.

5 Solution to the multi-neuron combinatorial switching problem

As suggested in Sec. 1, the organism-level learning problem (finding optimal $R^*(S)$, Fig. 1(a)) is solved using a trial-and-error search as variations are introduced in the firing combination R . As discussed in Sec 2.3, the signals driving the trial variations could come in the form of the Ca^{2+} dendritic spikes originating in the apical tufts. The apical tufts of pyramidal neurons in cortical layers II/III and V are known to receive input from distal cortical areas and nonspecific thalamic projections, with the inputs generally having different origins than those that form synapses with more proximal apical or basal dendrites [28].

It is evident that a proper allocation of behaviors to various L_2 neurons (or groups of neurons) can increase learning efficiency. For example, assume that L_2 has n trainable binary-state neurons. Random search for an optimal combination $R^*(S)$ for a certain S , assuming for simplicity that only a single $R^*(S)$ exists, would consume an order of magnitude 2^n trials. This compares to only n trials if one neuron can be trained at a time in any order, or roughly $\frac{n(n+1)}{2}$ trials if one neuron can be trained at a time, but in a particular order that also has to be found by trial and error. The latter training strategies would be possible if L_2 neurons drove complementary motor behaviors, such as movements of legs and arms, or rough movements of a leg and finer movements of a leg. The optimal for learning layout of L_2 and L_i neurons should certainly be subject to major evolutionary pressures. It has so far been assumed that each neuron r_k is learning independently, however, the excitation of patterns in L_2 could be more coordinated. For example, L_i neurons could drive excitation of multiple L_2 neurons.

In mammals, it is evident that the "combinatorially trainable" layer L_2 and L_i neurons are likely primarily located in the neocortex where they can store complex behaviors. It is suggested that the hippocampus, situated at the edges of the neocortex and indirectly projected into by it, is one of the major sites of generation of basic cognitive and higher emotions based on its observation of the neocortical and other brain activity, including the more "primary" emotions generated in other brain regions. The emotions generated in the hippocampus should include the positive emotion, or internal feeling, associated with "understanding", or "realization", of something, expression of which modulates the memorization of the immediately preceding behaviors (i.e., L_2 and L_i excitation patterns) in the neocortex (Fig. 8). The mechanism of generation of emotions, which probably involves an RPE-type signal [7, 8, 9, 10] in humans and higher animals, is not the main subject of this paper. However, several possible motives are discussed below.

In one of its simpler forms, the emotion accompanying "understanding" could be elicited following the accomplishment, for the first time, of a behavior that leads to a positive emotion. For example, a toddler may accidentally (or through the built-in "guessing", or "creativity" mechanism) realize how to turn on a television. In agreement with the suggested model, the child then becomes very likely to turn on the television each time he/she sees it turned off. The most practical way of interrupting this behavior is to elicit negative emotions in the child via punishment.

A more complicated form of "understanding" may be expressed when an organism, given a situation it is in, arrives at a more positive emotion than in a previous experience, or arrives at the same positive emotion as before, but in a simpler, faster, or, more generally, less negatively

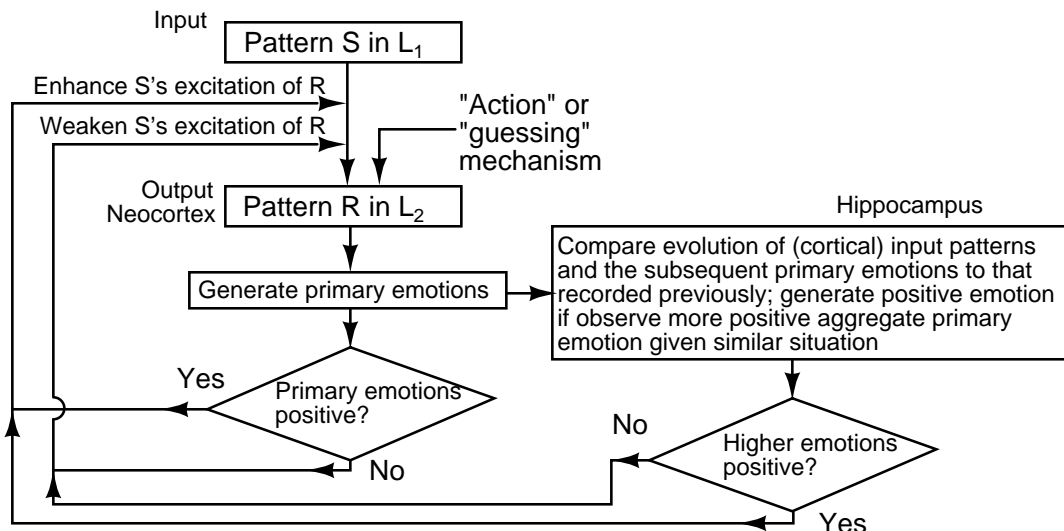

Figure 8: The suggested process of learning in mammals. The diagram is an elaboration of the process described in Fig. 1(b). The hippocampus plays a role of an "observing body" that generates higher emotions. The "primary" emotions shown may also be partly generated in the hippocampus. The framework suggests that higher emotions may have structurally evolved as an extension of more elementary feelings such as pain or hunger.

perceived way. For example, it may be a dog discovering that in a certain circumstance there is a simpler, or faster, way to obtain food than what had been usually achievable before. If the physical effort or the time spent waiting for food is perceived as an added negative emotion, all these scenarios can be considered part of a general scenario wherein an organism, given a situation, arrives at a more positive "aggregate" emotion than previously.

From the perspective of hippocampus, the above dog's discovery may be describable as: given the pattern of neocortical and other synaptic inputs that represents the situation the dog is in, observe a more positive aggregate "primary" emotion associated with food than in the previous experience. Note that the hippocampus does not need to be aware of the trial excitation of various behaviors, but can only act as a spectator that compares the evolution of emotions that accompany the current situation to those recorded previously in similar situations. Whenever a particular circumstance is followed by a more positive aggregate primary emotion than had been recorded previously, an added positive emotion such as "surprise" or "understanding" is generated, to memorize and use in the future any action the organism may have taken to cause that effect, as well as to possibly draw the attention to the action that enabled the effect. Conversely, negative emotions are generated if the circumstance does not result in a similar positive primary emotion within a comparable amount of time or effort spent. The hippocampus may employ the combinatorial switching principles discussed here to classify synaptic input patterns. However, the ability to evaluate the temporal relationships between inputs and gauge the magnitude of primary emotions would also be needed.

The higher human emotion associated with finding a solution to a problem, e.g., a math-

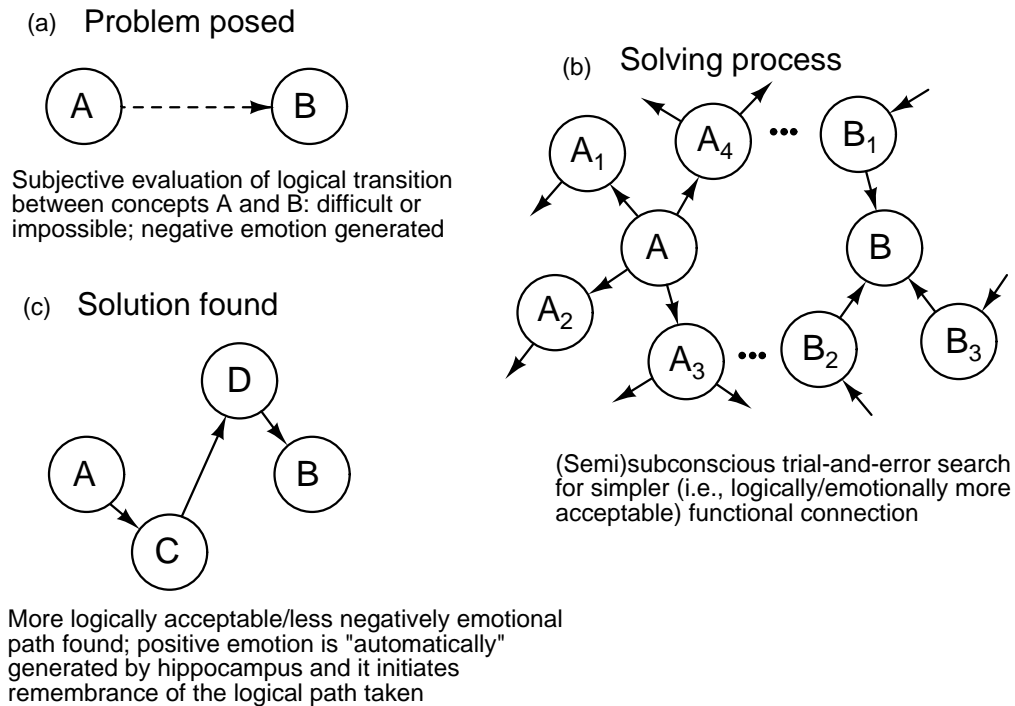

Figure 9: The suggested process of finding solution to a problem, such as a mathematical problem. Circles correspond to concepts that are physically represented as neuronal excitation patterns. Arrows represent functional connections between the neuronal excitation patterns. The solving process consists of a (semi)subconscious search for simpler than previously known functional connections between various concepts. The randomized trials are driven by the "guess" and "action" neurons. If the sought for connection between A and B is found, the hippocampus generates a positive emotion that causes memorization of the logical path taken.

emational problem, may be generated rather similarly. It is suggested that humans think, including solve problems such as mathematical problems, by a subconscious or nearly subconscious trial-and-error search for functional connections, or simpler than previously known functional connections, between various concepts that are represented as neuronal excitation patterns. When the sought for logical connection or result is found (in other words, when the connection or result that had previously appeared impossible or difficult to achieve is found), the positive emotion is "automatically" generated by an observing body such as the hippocampus to solidify the logical path taken in memory, as well as possibly to draw the attention to the found solution (Fig. 9). Greater simplifications achieved, e.g., when a law of nature is discovered, likely lead to more positive emotions and better memorization, consistent with the Law of Effect [2]. Here the emotions generated in the hippocampus modulate the storage of logical transitions (thoughts) in the neocortex.

In the presented framework, the main role of (conscious) emotions is to regulate the processes of learning and long-term memory; this is a much deeper role for emotions than is

currently accepted. Indeed, emotions seem to accompany all conscious learning experiences, with all new things learned accompanied by positive emotions and unsuccessful actions or failures to understand an idea by negative emotions. An interesting corollary of the above is that the more neurons a biological system has and the more its learning abilities, the more emotions or feelings the system should be able to experience on a physiological level. On a more philosophical note, it can also be said that emotions, or feelings, are probably tightly related to consciousness. In fact, the only "real" or "tangible" objects from the subjective perspective may be feelings and emotions. Therefore, the conscious mind and self-perception probably exist not in the commonly familiar three-dimensional space, but in the learning-oriented space of feelings and emotions.

6 Discussion

Many actions of humans and higher animals seem to fit into the following paradigm: given a combination of sensory inputs, generate an appropriate for the combination action that can be altered through learning. It would be an elegant solution of nature if individual neurons, with some help of auxiliary neuronal circuitry, in fact exhibited this basic behavior—at the single-neuron level expressed as the combinatorial switching of the neuron's output. Indeed, pyramidal neuron connectivity suggests just that: barring necessity for system redundancy, why would a neuron's axon make multiple seemingly randomly distributed connections with another neuron's dendrites, unless there was a combinatorial aspect that is used?

On the other hand, it is widely accepted that higher organisms try to learn to respond to the environment's inputs to achieve positive and avoid negative feelings and emotions [2, 13, 14, 15, 16]; and that following these subjective learning goals is ultimately connected to the achievement of the organisms' survival and evolutionary objectives.

The idea that emotions play a critical role in learning can be demonstrated with the following example. Consider a toddler learning how to kick a ball to hit a real or imaginary target (creating an implicit, or procedural, memory) by repeatedly kicking the ball and observing its trajectory. What is the mechanism that causes the motor activity associated with more successful trials to be memorized better than that associated with less successful trials, thus allowing the technique improvement? One could suggest that the child consciously and voluntarily, using some mental picture of the process, chooses to remember the movements associated with more successful trials. This would likely require a corresponding cognitive mechanism implemented at the neural level. However, this paper suggests that the positive emotions that accompany the child's realization that an attempt was successful already provide a convenient mechanism for relaying the signal of long-term memorization of the preceding spiking response to the neurons responsible for the more advantageous behavior. Indeed, the reason that emotional responses in humans and higher animals are delivered to a large number (or all, via hormones) of trainable neurons [9] may be that the exact site of the neurons being trained, given the complexities of the sensory-motor signal flows, is not easily locatable from the perspective of the emotion generating systems, which themselves may be scattered throughout the nervous system.

An interesting question is: why would the paradigm of combinatorial switching, in which the ability to classify input patterns into output patterns can be considered a multi-neuron

implementation, be successful in our world? The answer appears to be that, from a fundamental perspective, the world around us is indeed usefully classifiable, which is in large part driven by the repeating motives in the terrestrial environment and the life organization into similarly behaving species as well as the similarities across the species. (On an even deeper level, these may be viewed as stemming from the invariance of the physical laws in space and time.) A wolf that has learned how to catch a rabbit is more likely to catch a second rabbit, as well as another alike animal, in a similar terrestrial environment. The key to efficient learning with a low-dimensional feedback signal (the emotional response) may be the ability to distil reusable concepts in relatively few learning trials.

As an illustration of these ideas consider the following simple learning model. An untrained and hungry test subject has 12 sensory neurons connecting to 3 motor neurons. All the neurons operate in an "on" or "off" regime. The subject is seated at a table on which apples (rounded symmetrical shape, stem on top, smooth surface) or stones (rounded symmetrical shape, no stem on top, rough surface) are placed one at a time. The apples and stones can be of 1 of 3 sizes (small, medium or large) and 1 of 3 colors (red, yellow or green). Each of the 3 motor neurons drives an action: eating the object on the table, pushing it off the table, or doing nothing, in which case the object is removed from the table following a delay. Each of the sensory neurons fires if its assigned object feature is present: rounded shape, symmetrical shape, stem on top, no stem on top, smooth surface, rough surface, red, yellow or green color, small, medium or large size (the total of 12 features, one feature per sensory neuron).

The sensory neurons connect to the motor neuron dendrites at random locations, forming N clusters of C excitatory synapses on each motor neuron. A cluster is defined as being excited if all C its synapses are excited. Each cluster is initially assigned a memory weight of 0. A neuron fires in a "learned" excitation if at least M its clusters with memory weights of at least 1 are excited. A memory weight of 0.25 is added to a cluster for eating an apple, and 0.1 for pushing an object off the table, if 1) all the cluster's synapses are excited, 2) this is immediately followed by a trial firing of the cluster's neuron and 3) this is immediately followed by a positive emotional response. A cluster's memory weight is reset to 0 if 1) all the cluster's synapses are excited, 2) this is immediately followed by a trial or nontrial (learned) firing of the cluster's neuron and 3) this is immediately followed by a negative emotional response. Positive emotional response is generated for eating an apple or pushing an object off the table; negative emotional response is generated for eating a stone, doing nothing, or doing more than one action simultaneously (i.e., at least two motor neurons fire). After an object is placed on the table, the subject attempts to execute a memorized action. If there is no memorized action (i.e., less than M clusters with the memory weight of at least 1 are excited on each of the motor neurons) a random motor neuron fires in a trial firing.

A computer program AECLS (Autonomous Emotional Combination Learning System) implemented the above learning algorithm. To complicate the problem for the subject and to test its deductive reasoning, no green or large apples and no small or red stones were presented during learning, while green large apples and small red stones were presented during testing. Specifically, the subject was presented with a random sequence of 8 objects: small red apple, small yellow apple, medium red apple, medium yellow apple, medium yellow stone, medium green stone, large yellow stone, large green stone. The objects were presented until the subject would have had a learned response, if tested, to each of the 4 test objects: large green apple,

large red apple, small red stone, medium yellow stone. At this point it was recorded whether the responses to the test objects would have been correct, i.e., eating apples and pushing off stones. In some cases the system was not able to learn responses to all 4 test objects even after a large number of trials.

For $C = 4$, $N = 10,000$ and $M = 70$, the subjects learned to pass all the tests correctly in 93.9% of cases (41.3 trial neuron firings on average prior to learning). In the other 6.1% of cases the subjects typically learned the response of pushing both apples and stones off the table. This usually occurred when "pushing off" was, at random, tried many more times than "eating" when an apple was presented; therefore, the subjects had learned to "push off" apples before having tried to "eat" many of them. To make the trial neuron firings more regular the algorithm was modified to select the firing neurons sequentially in a round-robin. Then, the subjects learned to pass the tests correctly in 98.9% of cases (39.8 trials on average before learning).

For $C = 4$, $N = 10,000$ and $M = 1$ (with the round-robin motor neuron trials), the subjects learned the 4 correct responses in only 53.6% of cases. The most common reason for failing a test was due to motor neurons being excited by rarely occurring clusters that represented low-dimensional object features. For example, a cluster with 2 inputs coming from the "rounded shape" sensory neuron and 2 inputs from the "red" sensory neuron would cause all rounded red objects to be classified as edible if the training object sequence happened to have many red apples. Note that out of the $12^4 = 20,736$ clusters representing all possible ordered permutations of 4 out of 12 inputs, 1 cluster encodes the excitation of 1 chosen sensory neuron, 14 clusters encode the excitation of 2 chosen sensory neurons, 36 the excitation of 3 chosen sensory neurons, and 24 the excitation of 4 chosen sensory neurons. Therefore, requiring a minimum number of excited clusters to fire a neuron assigned lower importance to one- and two-dimensional object features.

Next, for each C from 1 to 4 (and the round-robin motor neuron trials) the optimal for learning M was searched for, using $N = 4 \cdot 12^C$ so that all possible input combinations were likely to occur in the clusters. For $C = 1$, the test performance was best when M was equal to 1, with the 4 correct test responses generated in only 56.1% of cases; for $C = 2$, >97% correct responses were generated for M from 29 to 35 (which represented 5-6.1% of all clusters); for $C = 3$, >97% correct responses were for M from 89 to 194 (1.3-2.8% of clusters); and for $C = 4$, >97% correct responses were for M from 286 to 897 (0.34-1.08% of clusters). Clearly, the systems with combinatorial memory ($C > 1$) performed much better than those without. It is interesting that the range of $\frac{M}{N}$ when the test success rate was greater than 97% was rather similar for all C from 2 to 4. As expected, if N was significantly decreased the test performance deteriorated. For example, for $C = 4$, $N = 1,000$ and $M = 7$ the correct responses to the 4 tests were learned in 87.1% of cases.

Although the AECLS algorithm is simple, it does suggest that learning in the emotion-modulated combinatorial switching framework can be rather efficient, via deduction of reusable abstract concepts. In order to deduce the reusable abstract concepts the system needs to learn in situations that display both these concepts and variability in other features. The system deduces the reusable concepts by accumulating weights for the synapse clusters that represent the concept features. Note that the resulting behavior can be described as "deductive reasoning" and will probably appear intelligent to an external observer. It is evident that in

real neuronal systems the analogs of parameters C , M and N should tend to evolve to suit a particular neuron's operating environment.

In summary, it is suggested that pyramidal neurons can process information by switching the neuron output based on active input neuron combinations. A trial-and-error learning paradigm is presented in which an (RPE-type) reward signal that itself may adjust over time modulates the combinatorial memory that stores learned behaviors. An experimental verification of the proposed mechanisms, including the putative mechanical or muscle-like contributions that can provide computational advantages to the single-neuron combinatorial switching, is needed.

Acknowledgments

The author gratefully thanks Prof. Michael A. Rvachov for prompting exploration of this subject and for many useful discussions.

References

- [1] R. S. Sutton, A. G. Barto, Reinforcement Learning: An Introduction (MIT Press, Cambridge, MA, 1998).
- [2] E. L. Thorndike, Animal Intelligence (Hafner, Darien, CT, 1911), p. 244.
- [3] R. E. Bellman, Dynamic Programming (Princeton University Press, Princeton, 1957).
- [4] P. R. Montague, P. Dayan, C. Person, T. J. Sejnowski, Bee foraging in uncertain environments using predictive hebbian learning, *Nature* 377 (1995) 725–728.
- [5] P. R. Montague, P. Dayan, T. J. Sejnowski, A framework for mesencephalic dopamine systems based on predictive Hebbian learning, *J Neurosci* 16 (1996) 1936–1947.
- [6] W. Schultz, P. Dayan, P. R. Montague, A neural substrate of prediction and reward, *Science* 275 (1997) 1593–1599.
- [7] R. R. Bush, F. Mosteller, A mathematical model for simple learning, *Psychol Rev* 58 (1951) 313–323.
- [8] R. R. Bush, F. Mosteller, A model for stimulus generalization and discrimination, *Psychol Rev* 58 (1951) 413–423.
- [9] W. Schultz, Predictive reward signal of dopamine neurons, *J Neurophysiol* 80 (1998) 1–27.
- [10] W. Schultz, Behavioral theories and the neurophysiology of reward, *Annu Rev Psychol* 57 (2006) 87–115.
- [11] P. W. Glimcher, Understanding dopamine and reinforcement learning: the dopamine reward prediction error hypothesis, *Proc Natl Acad Sci USA* 108 (Suppl 3) (2011) 15647–15654.

- [12] N. D. Daw, S. Kakade, P. Dayan, Opponent interactions between serotonin and dopamine, *Neural Netw* 15 (2002) 603–616.
- [13] E. R. Hilgard, G. H. Bower, *Theories of Learning*, 4th edn. (Prentice Hall, Englewood Cliffs, NJ, 1975).
- [14] D. C. Dennett, *Brainstorms: Philosophical Essays on Mind and Psychology* (MIT Press, Cambridge, MA, 1981).
- [15] D. T. Campbell, Blind variation and selective survival as a general strategy in knowledge processes, in *Self-Organizing Systems*, eds. M. C. Yovits and S. Cameron (Pergamon, New York, 1960), pp. 205–231.
- [16] G. Cziko, *Without Miracles: Universal Selection Theory and the Second Darwinian Revolution* (MIT Press, Cambridge, MA, 1995).
- [17] J. Tanaka, Y. Horiike, M. Matsuzaki, T. Miyazaki, G. Ellis-Davies, H. Kasai, Protein synthesis and neurotrophin-dependent structural plasticity of single dendritic spines, *Science* 319 (5870) (2008) 1683–1687.
- [18] H. Kasai, M. Fukuda, S. Watanabe, A. Hayashi-Takagi, J. Noguchi, Structural dynamics of dendritic spines in memory and cognition, *Trends Neurosci* 33 (3) (2010) 121–129.
- [19] A. Polsky, B. Mel, J. Schiller, Computational subunits in thin dendrites of pyramidal cells, *Nat Neurosci* 7 (6) (2004) 621–627.
- [20] R. A. Silver, Neuronal arithmetic, *Nat Rev Neurosci* 11 (2010) 474–489.
- [21] M. M. Rvachev, Alternative model of propagation of spikes along neurons, (2003) arXiv:physics/0301063v2 .
- [22] M. M. Rvachev, On axoplasmic pressure waves and their possible role in nerve impulse propagation, *Biophys Rev Lett* 5 (2) (2010) 73–88.
- [23] F. Korobova, T. Svitkina, Molecular architecture of synaptic actin cytoskeleton in hippocampal neurons reveals a mechanism of dendritic spine morphogenesis, *Mol Biol Cell* 21 (1) (2010) 165–176.
- [24] P. Hotulainen, C. Hoogenraad, Actin in dendritic spines: connecting dynamics to function, *J Cell Biol* 189 (4) (2010) 619–629.
- [25] M. Häusser, B. Mel, Dendrites: bug or feature?, *Curr Opin Neurobiol* 13 (3) (2003) 372–383.
- [26] P. Poirazi, T. Brannon, B. Mel, Pyramidal neuron as two-layer neural network, *Neuron* 37 (6) (2003) 989–999.
- [27] M. London, M. Häusser, Dendritic computation, *Annu Rev Neurosci* 28 (2005) 503–532.
- [28] N. Spruston, Pyramidal neurons: dendritic structure and synaptic integration, *Nat Rev Neurosci* 9 (2008) 206–221.

- [29] P. Ciarletta, M. B. Amarb, Peristaltic patterns for swelling and shrinking of soft cylindrical gels, *Soft Matter*, 8 (2012) 1760–1763.
- [30] H. Kasai, T. Hayama, M. Ishikawa, S. Watanabe, S. Yagishita, J. Noguchi, Learning rules and persistence of dendritic spines, *Eur J Neurosci* 32 (2) (2010) 241–249.