

Time series irreversibility: a visibility graph approach

Lucas Lacasa^{1*}, Angel Nuñez¹, Édgar Roldán², Juan M.R. Parrondo², and Bartolo Luque^{1*}

¹*Departamento de Matemática Aplicada y Estadística,*

ETSI Aeronáuticos, Universidad Politécnica de Madrid, Spain

²*Departamento de Física Atómica, Molecular y Nuclear and GISC, Universidad Complutense de Madrid, Spain*

(Dated: October 24, 2018)

We propose a method to measure real-valued time series irreversibility which combines two different tools: the horizontal visibility algorithm and the Kullback-Leibler divergence. This method maps a time series to a directed network according to a geometric criterion. The degree of irreversibility of the series is then estimated by the Kullback-Leibler divergence (i.e. the distinguishability) between the *in* and *out* degree distributions of the associated graph. The method is computationally efficient, does not require any *ad hoc* symbolization process, and naturally takes into account multiple scales. We find that the method correctly distinguishes between reversible and irreversible stationary time series, including analytical and numerical studies of its performance for: (i) reversible stochastic processes (uncorrelated and Gaussian linearly correlated), (ii) irreversible stochastic processes (a discrete flashing ratchet in an asymmetric potential), (iii) reversible (conservative) and irreversible (dissipative) chaotic maps, and (iv) dissipative chaotic maps in the presence of noise. Two alternative graph functionals, the degree and the degree-degree distributions, can be used as the Kullback-Leibler divergence argument. The former is simpler and more intuitive and can be used as a benchmark, but in the case of an irreversible process with null net current, the degree-degree distribution has to be considered to identify the irreversible nature of the series.

PACS numbers: 05.45.Tp, 05.45.-a, 89.75.Hc

I. INTRODUCTION

A stationary process $X(t)$ is said to be statistically time reversible (hereafter time reversible) if for every N , the series $\{X(t_1), \dots, X(t_N)\}$ and $\{X(t_N), \dots, X(t_1)\}$ have the same joint probability distributions [1]. Roughly, this means that a reversible time series and its time reversed are, statistically speaking, equally probable. Reversible processes include the family of Gaussian linear processes (as well as Fourier-transform surrogates and nonlinear static transformations of them), and are associated with processes at thermal equilibrium in statistical physics. Conversely, time series irreversibility is indicative of the presence of nonlinearities in the underlying dynamics, including non-Gaussian stochastic processes and dissipative chaos, and are associated with systems driven out-of-equilibrium in the realm of thermodynamics [2, 3]. Time series irreversibility is an important topic in basic and applied science. From a physical perspective, and based on the relation between statistical reversibility and physical dissipation [2, 3], recent work uses the concept of time series irreversibility to derive information about the entropy production of the physical mechanism generating the series, even if one ignores any detail of such mechanism [4, 5]. In a more applied context, it has been suggested that irreversibility in complex physiological series decreases with aging or pathology, being maximal in young and healthy subjects [6–8], rendering this feature important for noninvasive diagnosis. As complex signals pervade natural and social sciences, the topic of time series reversibility is indeed relevant for scientists aiming to understand and model the dynamics behind complex signals.

The definition of time series reversibility is formal and therefore there is not an *a priori* optimal algorithm to quantify it in practice. Recently, several methods to measure time irreversibility have been proposed [6, 7, 9–15]. The majority of them perform a time series symbolization, typically making an empirical partition of the data range [9] (note that such a transformation does not alter the reversible character of the output series [10]) and subsequently analyze the symbolized series, through statistical comparison of symbol strings occurrence in the forward and backwards series or using compression algorithms [5, 10, 16]. The first step requires an extra amount of *ad hoc* information (such as range partitioning or size of the symbol alphabet) and therefore the output of these methods eventually depend on these extra parameters. A second issue is that since typical symbolization is local, the presence of multiple scales (a signature of complex signals) could be swept away by this coarse-graining: in this sense multi-scale algorithms have been proposed recently [7, 8].

*Electronic address: lucas.lacasa@upm.es

Motivated by these facts, here we explore the usefulness of the horizontal visibility algorithm in such context. This is a time series analysis method which was proposed recently [17]. It makes use of graph theoretical concepts, and it is based on the mapping of a time series to a graph and the subsequent analysis of the associated graph properties [17–20]. Here we propose a *time directed* version of the horizontal visibility algorithm, and we show that it is a simple and well defined tool for measuring time series irreversibility. More precisely, we show that the Kullback-Leibler divergence [16] between the *out* and *in* degree distributions, $D[P_{\text{out}}(k)||P_{\text{in}}(k)]$, is a simple measure of the irreversibility of real-valued stationary stochastic series. Analytical and numerical results support our claims, and the presentation is as follows: The method is introduced in section II. In section III we analyze reversible time series generated from linear stochastic processes, which yield $D[P_{\text{out}}(k)||P_{\text{in}}(k)] = 0$. As a further validation, in section IV we report the results obtained for irreversible series. We first analyze a thermodynamic system (a discrete flashing ratchet) which shows time irreversibility when driven out of equilibrium. Its amount of irreversibility can be increased continuously tuning the value of a parameter of the system, and we find that the method can, not only distinguish, but also quantify the degree of irreversibility. We also study the effect of applying a stalling force in the opposite direction of the net current of particles in the ratchet. In this case the benchmark measure fails predicting reversibility whereas a generalized measure based on degree-degree distributions $D[P_{\text{out}}(k, k')||P_{\text{in}}(k, k')]$ goes beyond the phenomenon associated to physical currents and still detects irreversibility. We extend this analysis to chaotic signals, where our method distinguishes between dissipative and conservative chaos, and we analyze chaotic signals polluted with noise. Finally, a discussion is presented in section V.

II. THE METHOD

A. The horizontal visibility graph

The family of visibility algorithms is a collection of methods that map series to networks according to specific geometric criteria [17, 18]. The general purpose of such methods is to accurately map the information stored in a time series into an alternative mathematical structure, so that the powerful tools of graph theory may eventually be employed to characterize time series from a different viewpoint, bridging the gap between nonlinear time series analysis, dynamical systems, and graph theory [19, 21–24].

We focus here on a specific subclass called horizontal visibility algorithm, firstly proposed in [17], and defined as follows: Let $\{x_t\}_{t=1, \dots, N}$ be a real-valued time series of N data. The algorithm assigns each datum of the series to a node in the *horizontal visibility graph* (HVg). Then, two nodes i and j in the graph are connected if one can draw a *horizontal* line in the time series joining x_i and x_j that does not intersect any intermediate data height (see figure 1). Hence, i and j are two connected nodes if the following geometrical criterion is fulfilled within the time series:

$$x_i, x_j > x_n, \forall n \mid i < n < j \quad (1)$$

Some results regarding the characterization of stochastic and chaotic series through this method have been put forward recently [17, 20], and the first steps for a mathematically sound characterization of horizontal visibility graphs have been established [25]. Interestingly, a very recent work suggests that the method can be used in practice to characterize not only time series but generic nonlinear discrete dynamical systems, sharing similarities with the theory of symbolic dynamics [21].

B. Directed HVg

So far in the literature the family of visibility graphs are undirected, as visibility did not have a predefined temporal arrow. However, as already suggested in the seminal paper [18], such a directionality can be made explicit by making use of directed networks or digraphs [26]. We address such directed version, defining a *Directed Horizontal Visibility graph* (DHVg) as a HVg, where the degree $k(t)$ of the node t is now splitted in an *ingoing* degree $k_{\text{in}}(t)$, and an *outgoing* degree, such that $k(t) = k_{\text{in}}(t) + k_{\text{out}}(t)$. The ingoing degree $k(t)$ is defined as the number of links of node t with other *past* nodes associated with data in the series (that is, nodes with $t' < t$). Conversely, the outgoing degree $k_{\text{out}}(t)$, is defined as the number of links with *future* nodes.

For a graphical illustration of the method, see figure 1. The degree distribution of a graph describes the probability of an arbitrary node to have degree k (i.e. k links) [26]. We define the *in* and *out* (or ingoing and outgoing) degree distributions of a DHVg as the probability distributions of k_{out} and k_{in} of the graph which we call $P_{\text{out}}(k) \equiv P(k_{\text{out}} = k)$ and $P_{\text{in}}(k) \equiv P(k_{\text{in}} = k)$, respectively.

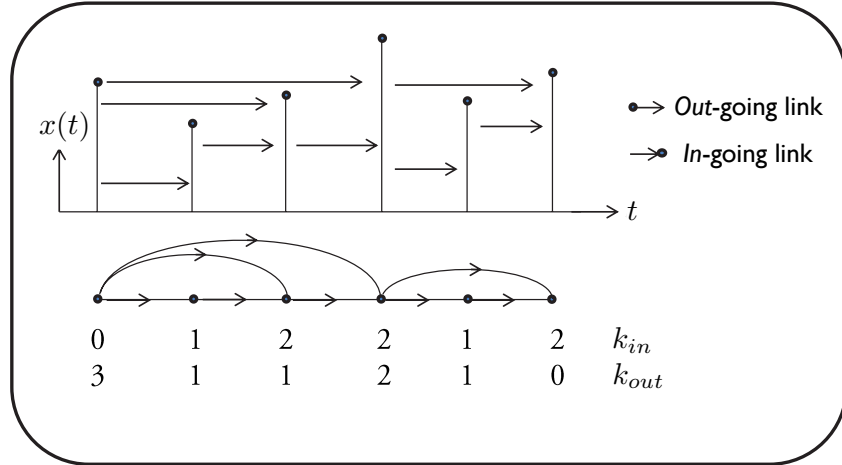

FIG. 1: Graphical illustration of the method. In the top we plot a sample time series $\{x(t)\}$. Each datum in the series is mapped to a node in the graph. Arrows, describing allowed directed visibility, link nodes. The associated directed horizontal visibility graph is plotted below. In this graph, each node has an ingoing degree k_{in} , which accounts for the number of links with *past* nodes, and an outgoing degree k_{out} , which in turn accounts for the number of links with *future* nodes. The asymmetry of the resulting graph can be captured in a first approximation through the invariance of the outgoing (or ingoing) degree series under time reversal.

C. Quantifying irreversibility: DHVg and Kullback-Leibler divergence

The main conjecture of this work is that the information stored in the *in* and *out* distributions take into account the amount of time irreversibility of the associated series. More precisely, we claim that this can be measured, in a first approximation, as the distance (in a distributional sense) between the *in* and *out* degree distributions ($P_{in}(k)$ and $P_{out}(k)$). If needed, higher order measures can be used, such as the corresponding distance between the *in* and *out* degree-degree distributions ($P_{in}(k, k')$ and $P_{out}(k, k')$). These are defined as the *in* and *out* joint degree distributions of a node and its first neighbors [26], describing the probability of an arbitrary node whose neighbor has degree k' to have degree k .

We make use of the Kullback-Leibler divergence [16] as the distance between the *in* and *out* degree distributions. Relative entropy or Kullback-Leibler divergence (KLD) is introduced in information theory as a measure of distinguishability between two probability distributions. Given a random variable x and two probability distributions $p(x)$ and $q(x)$, KLD between p and q is defined as follows:

$$D(p||q) \equiv \sum_{x \in \mathcal{X}} p(x) \log \frac{p(x)}{q(x)}, \quad (2)$$

which vanishes if and only if both probability distributions are equal $p = q$ and it is bigger than zero otherwise. Unlike other measures used to estimate time irreversibility [6, 9, 10, 13], the KLD is statistically significant, as it is proved by the Chernoff-Stein lemma: The probability of incorrectly guessing (via hypothesis testing) that a sequence of n data is distributed as p when the true distribution is q tends to $e^{-nD(p||q)}$ when $n \rightarrow \infty$. The KLD is then related to the probability to fail when doing an hypothesis test, or equivalently, it is a measure of distinguishability: the more distinguishable are p and q with respect to each other, the larger is $D(p||q)$.

In statistical mechanics, the KLD can be used to measure the time irreversibility of data produced by nonequilibrium processes but also to estimate the average entropy production of the physical process that generated the data [2, 4]. Irreversibility can be assessed by the KLD between probability distributions associated to observables in the process and in its time reversal. These measure gives lower bounds to the entropy production, whose accuracy increases as the observables contain a more detailed description of the system. The measure that we present in this work has this limitation: it takes the information from the degree, which is a partial description of the process. Consequently, our technique does not give a tight bound to the entropy production.

Nevertheless, as we will show in several examples, the information of the outgoing degree distribution k_{out} is sufficient to distinguish between reversible and irreversible stochastic stationary series which are real-valued but discrete in time $\{x_t\}_{t=1,\dots,N}$. We compare the outgoing degree distribution in the actual (forward) series $P_{k_{\text{out}}}(k|\{x(t)\}_{t=1,\dots,N}) = P_{\text{out}}(k)$ with the corresponding probability in the time-reversed (or backward) time series, which is equal to the probability distribution of the ingoing degree in the actual process $P_{k_{\text{out}}}(k|\{x(t)\}_{t=N,\dots,1}) = P_{\text{in}}(k)$. The KLD between these two distributions is

$$D[P_{\text{out}}(k)||P_{\text{in}}(k)] = \sum_k P_{\text{out}}(k) \log \frac{P_{\text{out}}(k)}{P_{\text{in}}(k)}. \quad (3)$$

This measure vanishes if and only if the outgoing and ingoing degree probability distributions of a time series are identical, $P_{\text{out}}(k) = P_{\text{in}}(k)$, and it is positive otherwise. We will apply it to several examples as a measure of irreversibility.

Notice that previous methods to estimate time series irreversibility generally proceed by first making a (somewhat *ad hoc*) local symbolization of the series, coarse-graining each of the series data into a symbol (typically, an integer) from an ordered set. Then, they subsequently perform a statistical analysis of word occurrences (where a word of length n is simply a concatenation of n symbols) from the forward and backwards symbolized series [14, 15]. Time series irreversibility is therefore linked to the difference between the word statistics of the forward and backwards symbolized series. The method presented here can also be considered as a symbolization if we restrict ourselves to the information stored in the series $\{k_{\text{out}}(t)\}_{t=1,\dots,N}$ and $\{k_{\text{in}}(t)\}_{t=1,\dots,N}$. However, at odds with other methods, here the symbolization process (i) lacks *ad hoc* parameters (such as number of symbols in the set or partition definition), and (ii) it takes into account *global* information: each coarse-graining $x_t \rightarrow (k_{\text{in}}(t), k_{\text{out}}(t))$ is performed using information from the whole series, according to the mapping criterion (1). Hence, this symbolization naturally takes into account multiple scales, which is desirable if we want to tackle complex signals [7, 8].

III. REVERSIBILITY

A. Uncorrelated stochastic series

For illustrative purposes, in figure 2 we have plotted the *in* and *out* degree distributions of the visibility graph associated to an uncorrelated random series $\{x_t\}_{t=1,\dots,N}$ of size $N = 10^6$: the distributions cannot be distinguished and KLD vanishes (the numerical value of KLD is shown in table I) which is indicative of a reversible series. In what follows we provide an exact derivation of the associated outgoing and ingoing degree distributions associated to this specific process, showing that they are indeed identical in the limit of infinite size series.

Theorem 1. Let $\{x_t\}_{t=-\infty,\dots,\infty}$ be a bi-infinite sequence of independent and identically distributed random variables extracted from a continuous probability density $f(x)$. Then, both the *in* and *out* degree distributions of its associated directed horizontal visibility graph are

$$P_{\text{in}}(k) = P_{\text{out}}(k) = \left(\frac{1}{2}\right)^k, \quad k = 1, 2, 3, \dots \quad (4)$$

Proof (out-distribution). Let x be an arbitrary datum of the aforementioned series. The probability that the horizontal visibility of x is interrupted by a datum x_r on its right is independent of $f(x)$,

$$\Phi_1 = \int_{-\infty}^{\infty} \int_x^{\infty} f(x) f(x_r) dx_r dx = \int_{-\infty}^{\infty} f(x) [1 - F(x)] dx = \frac{1}{2},$$

where $F(x) = \int_{-\infty}^x f(x') dx'$.

The probability $P(k)$ of the datum x being capable of exactly seeing k data may be expressed as

$$P(k) = Q(k) \Phi_1 = \frac{1}{2} Q(k), \quad (5)$$

where $Q(k)$ is the probability of x seeing at least k data. $Q(k)$ may be recurrently calculated via

$$Q(k) = Q(k-1)(1 - \Phi_1) = \frac{1}{2} Q(k-1), \quad (6)$$

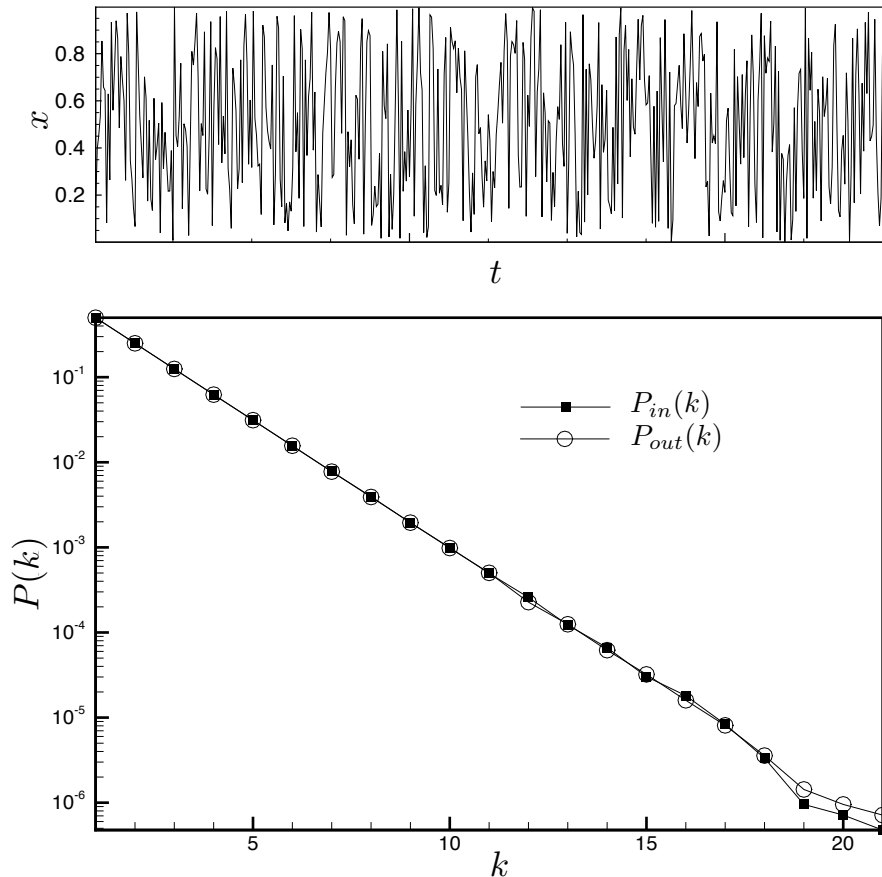

FIG. 2: *Top*: A sample uncorrelated random time series extracted from a uniform distribution $U[0,1]$. *Bottom*: The *in* and *out* degree distributions of the DHVg associated to the random series. The process is reversible and the graph degree distributions are, besides finite size effects, equivalent. The deviation is measured through their KLD (see table I).

from which, with $Q(1) = 1$, the following expression is obtained

$$Q(k) = \left(\frac{1}{2}\right)^{k-1}, \quad (7)$$

which together with equation (5) concludes the proof. An analogous derivation holds for the *in* case.

Note that this result is independent of the underlying probability density $f(x)$: it holds not only for Gaussian or uniformly distributed random series, but for any series of independent and identically distributed (i.i.d.) random variables extracted from a continuous distribution $f(x)$. A trivial corollary of this theorem is that the KLD between the *in* and *out* degree distributions associated to a random uncorrelated process tends asymptotically to zero with the series size, which correctly suggests that the series is time reversible.

B. Correlated stochastic series

In the last section we considered uncorrelated stochastic series which are our first example of a reversible series with $D[P_{out}(k)||P_{in}(k)] = 0$. As a further validation, here we focus on linearly correlated stochastic processes as additional examples of reversible dynamics [1]. We use the *minimal subtraction procedure* [20] to generate such correlated series. This method is a modification of the standard Fourier filtering method, which consists in filtering a series of uncorrelated random numbers in Fourier space. We study time series whose correlation is exponentially decaying $C(t) \sim \exp(-t/\tau)$ (akin to an Ornstein-Uhlenbeck process) and power law decaying $C(t) \sim t^{-\gamma}$. In table I we show

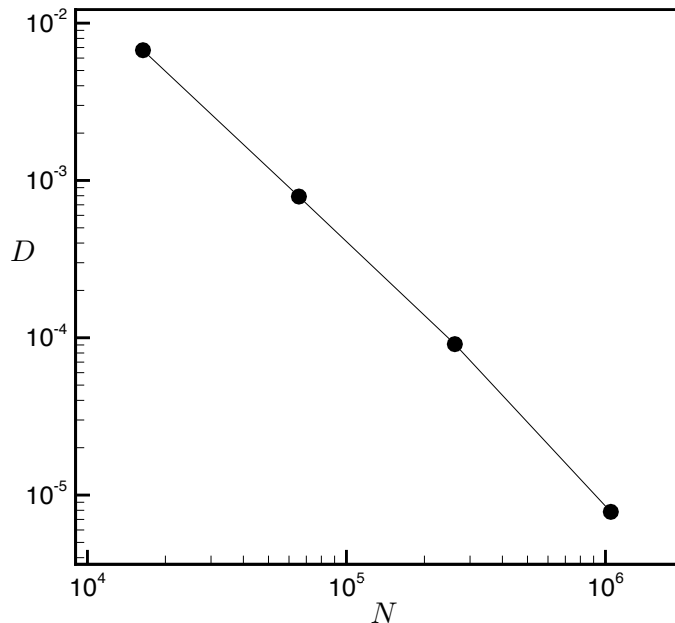

FIG. 3: Log-log plot of $D[P_{\text{out}}(k)||P_{\text{in}}(k)]$ of the graph associated to an Ornstein-Uhlenbeck process as a function of the series size N (dots are the result of an ensemble average over several realizations). Note that KLD decreases with series size and tends to zero asymptotically.

that the KLD of these series are all very close to zero, and its deviation from zero is originated by finite size effects, as it is shown in figure 3.

IV. IRREVERSIBILITY

A. Discrete flashing ratchet

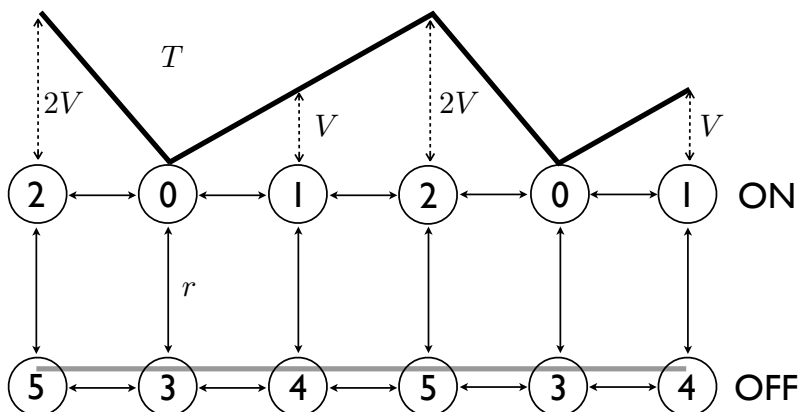

FIG. 4: Discrete flashing ratchet scheme. Particles are at temperature T moving in a periodic linear asymmetric potential of height $2V$. The potential is switched on and off at a constant rate r , which originates a net current of particles to the left. If the potential is ON, the state of the potential is represented by its position $x = \{0, 1, 2\}$, and if it is OFF by $x + 3 = \{3, 4, 5\}$.

We now study a thermodynamic system which can be smoothly driven out of equilibrium by modifying the value of

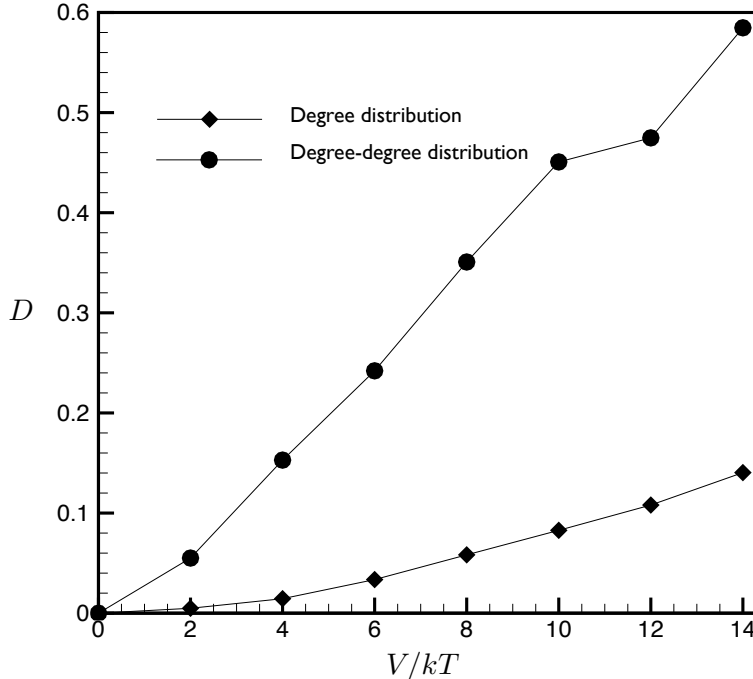

FIG. 5: $D[P_{\text{out}}(k)||P_{\text{in}}(k)]$ and $D[P_{\text{out}}(k, k')||P_{\text{in}}(k, k')]$ for a discrete flashing ratchet ($r = 1$) as a function of V/kT . For each value of V we generate a stationary time series of $N = 10^6$ steps described with full information (position and state of the potential). The system is in equilibrium for $V = 0$, and it is driven out of equilibrium for $V > 0$.

a physical parameter. We make use of the time series generated by a discrete flashing ratchet model introduced in [4]. The ratchet consists of a particle moving in a one dimensional lattice. The particle is at temperature T and moves in a periodic asymmetric potential of height $2V$, which is switched on and off at a rate r (see Figure 4 for details). The switching rate is independent of the position of the particle, breaking detailed balance [4, 5]. Hence, switching the potential drives the system out of equilibrium resulting in a directed motion or net current of particles. When using full information of the process, trajectories of the system are described by two variables: the position of the particle $x = \{0, 1, 2\}$ and the state of the potential, $y = \{\text{ON}, \text{OFF}\}$. The time series are constructed from x and y variables as follows: $(x, y) = x$ if $y = \text{ON}$ and $(x, y) = x + 3$ if $y = \text{OFF}$.

The dynamics of the system is described by a six-state Markov chain with transition probabilities $p_{i \rightarrow j} = \Gamma_{i \rightarrow j} / \sum_j \Gamma_{i \rightarrow j}$, where $\Gamma_{i \rightarrow j}$ is the transition rate from i to j and the sum \sum_j runs over the accessible states from i (see figure 4). All transition rates satisfy the detailed balance condition with respect to the thermal bath at temperature T , except the switches between ON and OFF. When the potential is on, $i, j = \{0, 1, 2\}$ and $\Gamma_{i \rightarrow j} = \exp[-(V_j - V_i)/kT]$. When it is off, $i, j = \{3, 4, 5\}$ and $\Gamma_{i \rightarrow j} = 1$. On the other hand, switches are implemented with rates that do not depend on the position of the particle and therefore do not satisfy detail balance condition [5]: $\Gamma_{i \rightarrow i+3} = \Gamma_{i+3 \rightarrow i} = r$, for $i = \{0, 1, 2\}$.

In Figure 5 we depict the values of $D[P_{\text{out}}(k)||P_{\text{in}}(k)]$ and $D[P_{\text{out}}(k, k')||P_{\text{in}}(k, k')]$ as a function of V/kT , for 6-state time series of 2^{19} data. Note that for $V = 0$ detailed balance condition is satisfied, the system is in equilibrium and trajectories are statistically reversible. In this case both KLD using degree distributions and degree-degree distributions vanish. On the other hand, if V is increased, the system is driven out of equilibrium, what introduces a net statistical irreversibility which increases with V [4]. The amount of irreversibility estimated with KLD increases with V for both measures, therefore the results produced by the method are qualitatively correct. Interestingly enough, the tendency holds even for high values of the potential, where the statistics are poor and the KLD of sequences of symbols usually fail when estimating irreversibility [4]. However the values of the KLD that we find are far below the KLD per step between the forward and backward trajectories, which is equal to the dissipation as reported in [4]. The degree distributions capture the irreversibility of the original series but it is difficult to establish a quantitative relationship between (3) and the KLD between trajectories.

On the other hand, the measure based on the degree-degree distribution $D[P_{\text{out}}(k, k')||P_{\text{in}}(k, k')]$ takes into account more information of the visibility graph structure than the KLD using degree distributions, providing a closer bound to the physical dissipation as it is expected by the chain rule [16], $D[P_{\text{out}}(k, k')||P_{\text{in}}(k, k')] \geq D[P_{\text{out}}(k)||P_{\text{in}}(k)]$. The

improvement is significant in some situations. Consider for instance the flashing ratchet with a force opposite to the net current on the system [4]. The current vanishes for a given value of the force usually termed as *stalling force*. When the force reaches this value, the system is still out of equilibrium ($V > 0$) and it is therefore time irreversible, but no current of particles is observed if we describe the dynamics of the ratchet with partial information given by the position x .

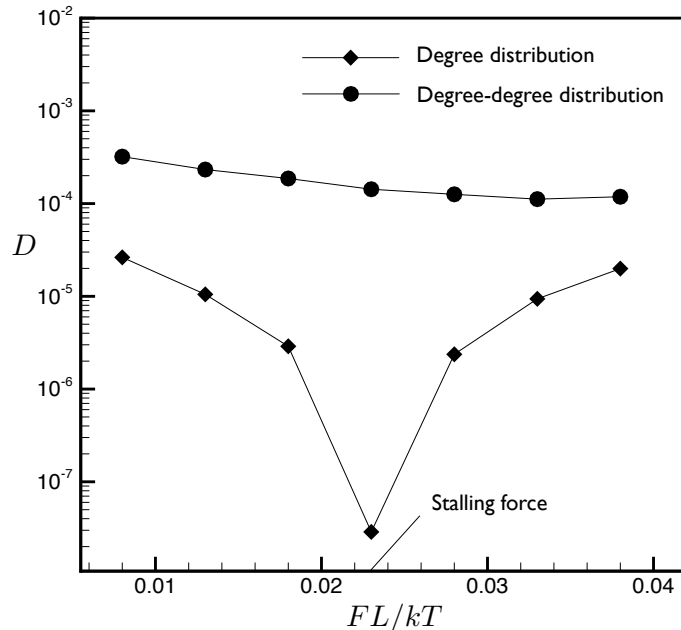

FIG. 6: Irreversibility measures $D[P_{\text{out}}(k)||P_{\text{in}}(k)]$ and $D[P_{\text{out}}(k, k')||P_{\text{in}}(k, k')]$ in the flashing ratchet ($r = 2, V = 2kT$) as a function of FL/kT . Here, F is the applied force and L is the spatial period of the ratchet, which in this case is equal to 1. For each value of the force, we make use of a single stationary series of size $N = 10^6$ containing partial information (the state information is removed).

In Fig. 6 we show how $D[P_{\text{out}}(k)||P_{\text{in}}(k)]$ tends to zero when the force approaches to the stalling value. Therefore, our measure of irreversibility (3) fails in this case, as do other KLD estimators based on local flows or currents [4]. However, $D[P_{\text{out}}(k, k')||P_{\text{in}}(k, k')]$ captures the irreversibility of the time series, and yields a positive value at the stalling force.

B. Chaotic series

We have applied our method to several chaotic series and found that it is able to distinguish between dissipative and conservative chaotic systems. Dissipative chaotic systems are those that do not preserve the volume of the phase space, and they produce irreversible time series. This is the case of chaotic maps in which entropy production via instabilities in the forward time direction is quantitatively different to the amount of past information lost. In other words, those whose positive Lyapunov exponents, which characterize chaos in the forward process, differ in magnitude with negative ones, which characterize chaos in the backward process [10]. In this section we analyze several chaotic maps and estimate the degree of reversibility of their associated time series using our measure, showing that for dissipative chaotic series it is positive while it vanishes for an example of conservative chaos.

1. The Logistic map at $\mu = 4$ is irreversible: analytical derivations

For illustrative purposes, in figure 7 we have plotted the *in* and *out* degree distributions of the DHVg associated to a paradigmatic dissipative chaotic system: the Logistic map at $\mu = 4$. There is a clear distinction between both

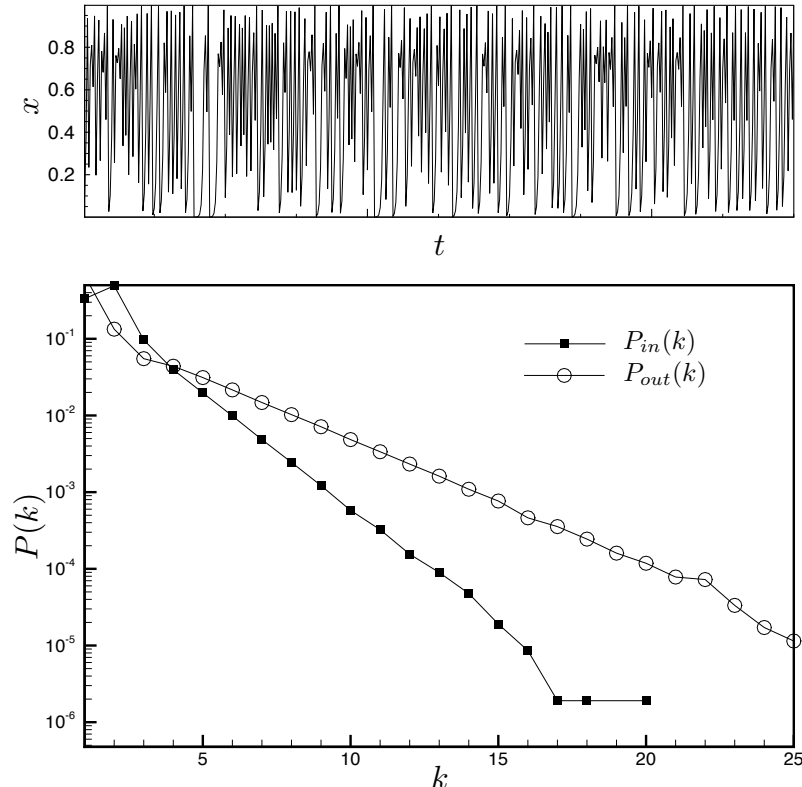

FIG. 7: *Top*: A sample chaotic time series extracted from a fully chaotic Logistic map $x_{t+1} = 4x_t(1 - x_t)$. *Bottom*: The *in* and *out* degree distributions of the DHVg associated to the chaotic series. The process is irreversible and the graph degree distributions are clearly different. The deviation is measured through the KLD, which is positive in this case (see table I).

distributions, as it is quantified by the KLD, which in this case is positive both for degree and degree-degree cases (see table I). Furthermore, in figure 8 we make a finite size analysis in this particular case, showing that our measure quickly converges to an asymptotic value which clearly deviates from zero, at odds with reversible processes.

Recall that in section III we proved analytically that for a random uncorrelated process $D[P_{\text{out}}(k)||P_{\text{in}}(k)] = 0$, since $P_{\text{in}}(k) = P_{\text{out}}(k)$. Proving a similar result for a generic irreversible process is a major challenge, since finding out exact results for the entire degree distributions is in general difficult [20]. However, note that the KLD between two distributions is zero if and only if the distributions are the same in the entire support. Therefore, if we want to prove that this measure is strictly positive, it is sufficient to find that $P_{\text{in}}(k) \neq P_{\text{out}}(k)$ for some value of the degree k . Here we take advantage of this fact to provide a rather general recipe to prove that a chaotic system is irreversible.

Consider a time series $\{x_t\}_{t=1,\dots,N}$ with a joint probability distribution $f(x_1, x_2, \dots, x_N)$ and support (a, b) , and denote x_{t-1}, x_t, x_{t+1} three (ordered) generic data of the series. By construction,

$$\begin{aligned} P_{\text{out}}(k=1) &= P(x_t \leq x_{t+1}) = \int_a^b dx_t \int_{x_t}^b dx_{t+1} f(x_t, x_{t+1}), \\ P_{\text{in}}(k=1) &= P(x_{t-1} > x_t) = 1 - P_{\text{out}}(k=1). \end{aligned} \quad (8)$$

The probability that $k_{\text{out}} = 1$ ($k_{\text{in}} = 1$) is actually the probability that the series increases (decreases) in one step. This probability is independent of time, because we consider stationary series. If the chaotic map is of the form $x_{t+1} = F(x_t)$, it is Markovian, and the preceding equations simplify:

$$P_{\text{out}}(k=1) = \int_a^b dx_t \int_{x_t}^b dx_{t+1} f(x_t) f(x_{t+1}|x_t). \quad (9)$$

For chaotic dynamical systems whose trajectories are in the attractor, there exists an invariant probability measure that characterizes the long-term fraction of time spent by the system in the various regions of the attractor. In the

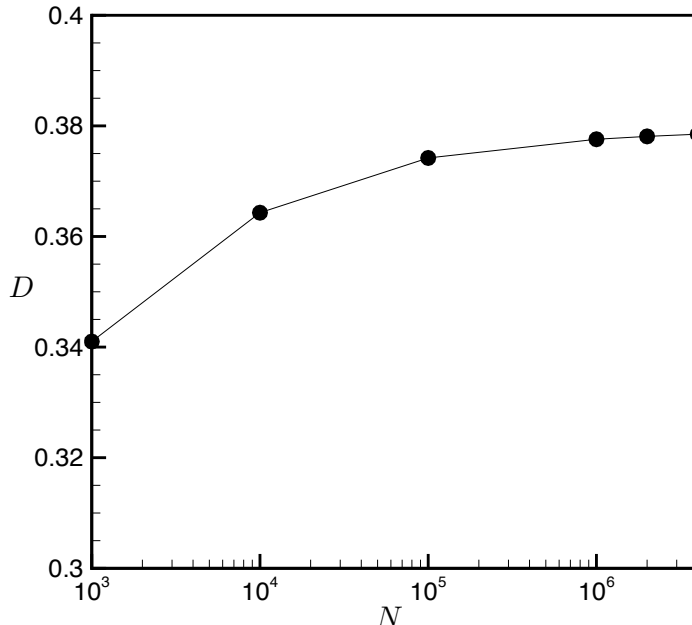

FIG. 8: Log-log plot of $D[P_{\text{out}}(k)||P_{\text{in}}(k)]$ of the graph associated to a fully chaotic Logistic map $x_{t+1} = 4x_t(1 - x_t)$, as a function of the series size N (dots are the result of an ensemble average over different realizations). Our irreversibility measure converges with series size to an asymptotical nonzero value.

case of the Logistic map

$$F(x_t) = \mu x_t(1 - x_t) \quad (10)$$

with parameter $\mu = 4$, the attractor is the whole interval $[0, 1]$ and the probability measure $f(x)$ corresponds to

$$f(x) = \frac{1}{\pi \sqrt{x(1-x)}}. \quad (11)$$

Now, for a deterministic system, the transition probability is simply

$$f(x_{t+1}|x_t) = \delta(x_{t+1} - F(x_t)), \quad (12)$$

where $\delta(x)$ is the Dirac delta distribution. Equations (9) for the Logistic map with $\mu = 4$ and $x \in [0, 1]$ reads

$$P_{\text{out}}(k=1) = \int_0^1 dx_t \int_{x_t}^1 dx_{t+1} f(x_t) \delta(x_{t+1} - F(x_t)). \quad (13)$$

Notice that, using the properties of the Dirac delta distribution, $\int_{x_t}^1 \delta(x_{t+1} - F(x_t)) dx_{t+1}$ is equal to one iff $F(x_t) \in [x_t, 1]$, what happens iff $0 < x_t < 3/4$, and it is zero otherwise. Therefore the only effect of this integral is to restrict the integration range of x_t to be $[0, 3/4]$. Equation (13) reduces to

$$P_{\text{out}}(k=1) = \int_0^{3/4} dx_t f(x_t) = 2/3, \quad (14)$$

and $P_{\text{in}}(k=1) = 1/3$. We conclude that $P_{\text{out}}(k) \neq P_{\text{in}}(k)$ for the Logistic map and hence the KLD measure based on degree distributions is positive. Recall that $P_{\text{out}}(k=1) = 2/3$ is the probability that the series exhibits a positive jump ($x_t > x_{t-1}$) once in the attractor. These positive jumps must be smaller in size than the negative jumps

Series description	$D[P_{\text{out}}(k) P_{\text{in}}(k)]$	$D[P_{\text{out}}(k, k') P_{\text{in}}(k, k')]$
<i>Reversible Stochastic Processes</i>		
$U[0, 1]$ uncorrelated	$3.88 \cdot 10^{-6}$	$2.85 \cdot 10^{-4}$
Ornstein-Uhlenbeck ($\tau = 1.0$)	$7.82 \cdot 10^{-6}$	$1.52 \cdot 10^{-4}$
Long-range correlated stationary process ($\gamma = 2.0$)	$1.28 \cdot 10^{-5}$	$2.0 \cdot 10^{-4}$
<i>Dissipative Chaos</i>		
Logistic map ($\mu = 4$)	0.377	2.978
α map ($\alpha = 3$)	0.455	3.005
α map ($\alpha = 4$)	0.522	3.518
Henon map ($a = 1.4, b = 0.3$)	0.178	1.707
Lozi map	0.114	1.265
Kaplan Yorke map	0.164	0.390
<i>Conservative Chaos</i>		
Arnold Cat map	$1.77 \cdot 10^{-5}$	$4.05 \cdot 10^{-4}$

TABLE I: Values of the irreversibility measure associated to the degree distribution $D[P_{\text{out}}(k)||P_{\text{in}}(k)]$ and the degree-degree distribution $D[P_{\text{out}}(k, k')||P_{\text{in}}(k, k')]$ respectively, for the visibility graphs associated to series of 10^6 data generated from reversible and irreversible processes. In every case chain rule is satisfied, since $D[P_{\text{out}}(k, k')||P_{\text{in}}(k, k')] \geq D[P_{\text{out}}(k)||P_{\text{in}}(k)]$. Note that that the method correctly distinguishes between reversible and irreversible processes, as KLD vanishes for the former and it is positive for the latter.

because, once in the attractor, $\langle x_t \rangle$ is constant. The irreversibility captured by the difference between $P_{\text{out}}(k = 1)$ and $P_{\text{in}}(k = 1)$ is then the asymmetry of the probability distribution of the slope $x_t - x_{t-1}$ of the original time series. The KLD of the degree distributions given by (3) clearly goes beyond this simple signature of irreversibility and can capture more complex and long-range traits.

2. Other chaotic maps

For completeness, we consider other examples of dissipative chaotic systems analyzed in [27]:

1. *The α -map*: $x_{t+1} = 1 - |2x_t - 1|^\alpha$, which reduces to the Logistic and tent maps in their fully chaotic region for $\alpha = 2$ and $\alpha = 1$ respectively. We analyze this map for $\alpha = 3, 4$.
2. *The 2D Hénon map*: $x_{t+1} = 1 + y_t - ax_t^2$, $y_{t+1} = bx_t$, in the fully chaotic region ($a = 1.4, b = 0.3$).
3. *The Lozi map*: a piecewise-linear variant of the Hénon map given by $x_{t+1} = 1 + y_n - a|x_t|$, $y_{t+1} = bx_t$ in the chaotic regime ($a = 1.7$ and $b = 0.5$).
4. *The Kaplan-Yorke map*: $x_{t+1} = 2x_t \bmod(1)$, $y_{t+1} = \lambda y_t + \cos(4\pi x_t) \bmod(1)$.

We generate stationary time series with these maps and take data once the system is in the corresponding attractor. In table I we show the value of the KLD between the in and out degree and degree-degree distributions for these series. In every case, we find an asymptotic positive value, in agreement with the conjecture that dissipative chaos is indeed time irreversible.

Finally, we also consider the *Arnold cat map*: $x_{t+1} = x_t + y_t \bmod(1)$, $y_{t+1} = x_t + 2y_t \bmod(1)$. At odds with previous dissipative maps, this is an example of a *conservative* (measure-preserving) chaotic system with integer Kaplan-Yorke dimension [27]. The map has two Lyapunov exponents which coincide in magnitude $\lambda_1 = \ln(3 + \sqrt{5})/2 = 0.9624$ and $\lambda_2 = \ln(3 - \sqrt{5})/2 = -0.9624$. This implies that the amount of information created in the forward process (λ_1) is equal to the amount of information created in the backwards process ($-\lambda_2$), therefore the process is time reversible. In figure 9 we show that $D[P_{\text{out}}(k)||P_{\text{in}}(k)]$ for a time series of this map asymptotically tends to zero with series size, and the same happens with the degree-degree distributions (see table I). This correctly suggests that albeit chaotic, the map is statistically time reversible.

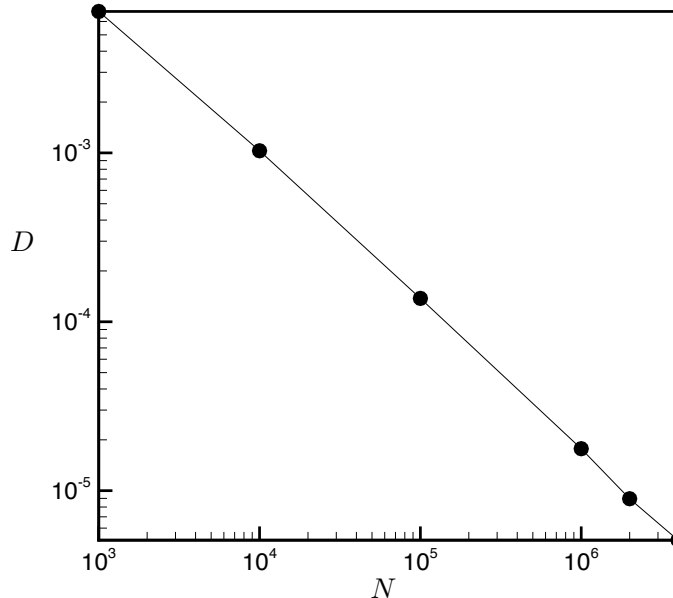

FIG. 9: Log-log plot of $D[P_{\text{out}}(k)||P_{\text{in}}(k)]$ of the graph associated to the Arnold cat map as a function of the series size N (dots are the result of an ensemble average over different realizations). Note that the irreversibility measure decreases with series size, and asymptotically tends to zero, which suggests that this chaotic map is reversible.

C. Irreversible chaotic series polluted with noise

Standard time series analysis methods evidence problems when noise is present in chaotic series. Even a small amount of noise can destroy the fractal structure of a chaotic attractor and mislead the calculation of chaos indicators such as the correlation dimension or the Lyapunov exponents [28]. In order to check if our method is robust, we add an amount of white noise (measurement noise) to a signal extracted from a fully chaotic Logistic map ($\mu = 4.0$). In figure 10 we plot $D[P_{\text{out}}(k)||P_{\text{in}}(k)]$ of its associated visibility graph as a function of the noise amplitude (the value corresponding to a pure random signal is also plotted for comparison). The KLD of the signal polluted with noise is significantly greater than zero, as it exceeds the one associated to the noise in four orders of magnitude, even when the noise reaches the 100% of the signal amplitude. Therefore our method correctly predicts that the signal is irreversible even when adding noise.

V. DISCUSSION

In this paper we have introduced a new method to measure time irreversibility of real valued stationary stochastic time series. The algorithm proceeds by mapping the series into an alternative representation, the directed horizontal visibility graph. We have shown that the Kullback-Leibler divergence (KLD) between the *in* and *out* degree distributions calculated on this graph is a measure of the irreversibility of the series.

We have shown that the difference between the *in* and *out* distributions at $k = 1$ measures the asymmetry in the PDF of the slope of the series. The degree, however, contains information of long-range correlations and structures in the series. In particular, the degree-degree distribution can detect the irreversibility in a series with a symmetric slope, as we have shown for the flashing ratchet at stall force.

Our technique discriminates between conservative and dissipative chaotic maps. The method has been validated by studying both reversible (uncorrelated and linearly correlated stochastic processes as well as conservative chaotic maps) and irreversible (out-of-equilibrium physical processes and dissipative chaotic maps) series.

We have also shown that the method is robust against noise, in the sense that irreversible signals are well characterized even when these signals are polluted with a significant amount of (reversible) noise. It is also worth emphasizing that it lacks a symbolization process, and hence it can be applied directly to any kind of real-valued time series.

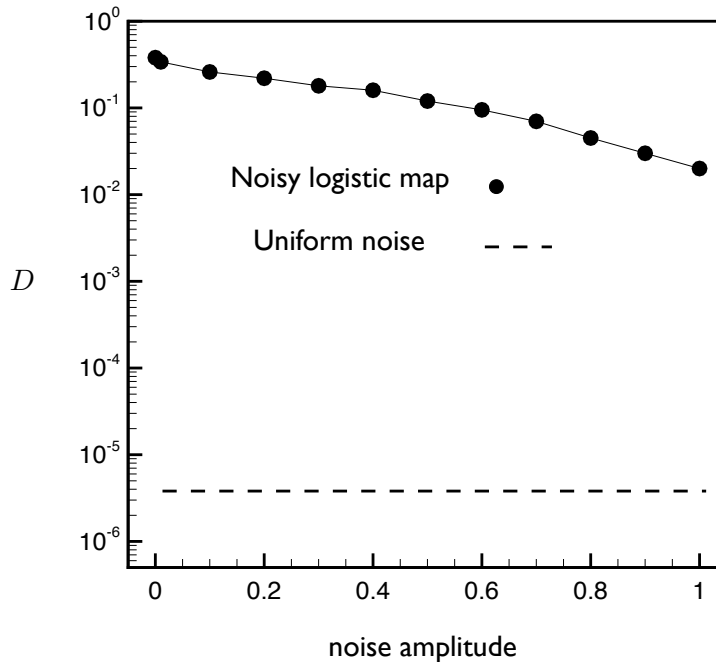

FIG. 10: Semi-log plot of $D[P_{\text{out}}(k)|P_{\text{in}}(k)]$ of the graph associated to series of 10^6 data extracted from a fully chaotic Logistic map $x_{t+1} = 4x_t(1 - x_t)$ polluted with extrinsic white uniform noise $U[-0.5, 0.5]$, as a function of the noise amplitude. The corresponding KLD value of a uniform series is plotted for comparison, which is five orders of magnitude smaller even when the chaotic signal is polluted with an amount of noise of the same amplitude. This suggests that our measure is robust against noise.

This makes our technique of potential interest for several communities. This includes for instance biological sciences, where there is not such a simple tool to discriminate between time series generated by active (irreversible) and passive (reversible) processes.

Acknowledgments We acknowledge financial support from grants MODELICO, Comunidad de Madrid; FIS2009-13690 (LL, AN and BL) and MOSIACO (ER and JMRP), Ministerio de Educación.

-
- [1] G. Weiss, Time-reversibility of linear stochastic processes, *J. Appl. Prob.* **12**, 831-836 (1975).
 - [2] R. Kawai, JMR Parrondo and C Van den Broeck, Dissipation: the phase-space perspective, *Phys. Rev. Lett.* **98**, 080602 (2007).
 - [3] JMR Parrondo, C Van den Broeck and R Kawai, Entropy production and the arrow of time, *New. J. Phys.* **11** (2009) 073008.
 - [4] E. Roldan and JMR Parrondo, Estimating dissipation from single stationary trajectories, *Phys. Rev. Lett.* **105**, 15 (2010).
 - [5] E. Roldan and JMR Parrondo, Dissipation and relative entropy in discrete random stationary states, *in preparation*.
 - [6] A.C. Yang, S.S. Hseu, H.W. Yien, A.L. Goldberger, and C.-K. Peng, Linguistic analysis of the human heartbeat using frequency and rank order statistics, *Phys. Rev. Lett.* **90**, 10 (2003).
 - [7] M. Costa, A.L. Goldberger, and C.-K. Peng, Broken Asymmetry of the Human Heartbeat: Loss of Time Irreversibility in Aging and Disease, *Phys. Rev. Lett.* **95**, 198102 (2005).
 - [8] M.D. Costa, C.K. Peng and A.L. Goldberger, Multiscale Analysis of Heart Rate Dynamics: Entropy and Time Irreversibility Measures, *Cardiovasc Eng* **8** (2008).
 - [9] C.S. Daw, C.E.A. Finney, and M.B. Kennel, Symbolic approach for measuring temporal 'irreversibility', *Phys. Rev. E* **62**, 2 (2000).
 - [10] MB Kennel, Testing time symmetry in time series using data compression techniques, *Phys. Rev. E* **69**, 056208 (2004).
 - [11] C. Diks, J.C. van Houwelingen, F. Takens, and J. DeGoede, Reversibility as a criterion for discriminating time series, *Phys. Lett. A* **201** (1995), 221-228.
 - [12] P. Gaspard, Time-reversed dynamical entropy and irreversibility in markovian random processes, *J. Stat. Phys.* **117** (2004).

- [13] C. Cammarota and E. Rogora, Time reversal, symbolic series and irreversibility of human heartbeat *Chaos, Solitons and Fractals* **32** (2007) 1649-1654.
- [14] D. Andrieux, P. Gaspard, S. Ciliberto, N. Garnier, S. Joubaud, and A. Petrosyan, Entropy production and time asymmetry in nonequilibrium fluctuations, *Phys. Rev. Lett.* **98**, 150601 (2007).
- [15] Q. Wang, S. R. Kulkarni and S. Verdú, Divergence estimation of continuous distributions based on data-dependent partitions, *IEEE Transactions on Information Theory*, **51**, 9 (2005).
- [16] T.M. Cover and J.A. Thomas, *Elements of Information Theory* (Wiley, New Jersey, 2006).
- [17] B. Luque, L. Lacasa, J. Luque & F. Ballesteros, Horizontal visibility graphs: exact results for random time series, *Phys. Rev. E* **80**, 046103 (2009).
- [18] L. Lacasa, B. Luque, F. Ballesteros, J. Luque & J.C. Nuno, From time series to complex networks: the visibility graph. *Proc. Natl. Acad. Sci. U.S.A.* **105**, 13 (2008) 4973.
- [19] L. Lacasa, B. Luque, J. Luque, & J.C. Nuno, The Visibility Graph: a new method for estimating the Hurst exponent of fractional Brownian motion. *EPL* **86** (2009) 30001.
- [20] L. Lacasa & R. Toral, Description of stochastic and chaotic series using visibility graphs. *Phys. Rev. E* **82**, 036120 (2010).
- [21] B. Luque, L. Lacasa, F.J. Ballesteros & A. Robledo, Feigenbaum graphs: a complex network perspective of chaos *PLoS ONE* (in press 2011).
- [22] Elsner J.B., Jagger T.H. , and Fogarty E.A., Visibility network of United States hurricanes. *Geophys. Res. Lett.* **36**, 16 (2009).
- [23] Liu C., Zhou W-X, and Yuan W-K, Statistical properties of visibility graph of energy dissipation rates in three-dimensional fully developed turbulence. *Physica A* (in press 2010).
- [24] Yang Y., Wang J., Yang H., Mang J., Visibility graph approach to exchange rate series. *Physica A* **388**, 20 (2009), Pages 4431-4437
- [25] Gutin, G., Mansour, T. & Severini, S. A characterization of horizontal visibility graphs and combinatorics on words. arXiv:1010.1850v1.
- [26] M.E.J. Newmann, The structure and function of complex networks, *SIAM Review* **45**, 167-256 (2003).
- [27] Sprott J.C., and Rowlands G., Improved correlation dimension calculation, *International Journal of Bifurcation and Chaos* **11**, 7 (2001) 1865-1880.
- [28] E.J. Kostelich and T. Schreiber, Noise reduction in chaotic time-series data: A survey of common methods, *Phys. Rev. E* **48**, 1752 (1993).