

Input-Output Finite-Time Stability

G. De Tommasi[†], R. Ambrosino[‡], G. Carannante[†],
C. Cosentino[§], A. Pironti[†], F. Amato[§]

Abstract—This paper introduces the extension of Finite-Time Stability (FTS) to the input-output case, namely the Input-Output FTS (IO-FTS). The main differences between classic IO stability and IO-FTS are that the latter involves signals defined over a finite time interval, does not necessarily require the inputs and outputs to belong to the same class of signals, and that quantitative bounds on both inputs and outputs must be specified. This paper revises some recent results on IO-FTS, both in the context of linear systems and in the context of switching systems. In the final example the proposed methodology is used to minimize the maximum displacement and velocity of a building subject to an earthquake of given magnitude.

Keywords: Linear systems; Switching systems; IO-FTS; D/DLMI.

I. INTRODUCTION

The concept of input-output finite time stability (IO-FTS) has been recently introduced in [1]; roughly speaking, a system is said to be IO-FTS if, given a class of norm bounded input signals defined over a specified time interval T , the outputs of the system do not exceed an assigned threshold during T .

In order to correctly frame the definition of IO-FTS in the current literature, we recall that a system is said to be IO \mathcal{L}_p -stable [2, Ch. 5] if for any input of class \mathcal{L}_p , the system exhibits a corresponding output which belongs to the same class. The main differences between *classic* IO stability and IO-FTS are that the latter involves signals defined over a finite time interval, does not necessarily require the inputs and outputs to belong to the same class, and that *quantitative* bounds on both inputs and outputs

must be specified. Therefore, IO stability and IO-FTS are independent concepts. Furthermore, while IO stability deals with the behavior of a system within a sufficiently long (in principle infinite) time interval, IO-FTS is a more practical concept, useful to study the behavior of the system within a finite (possibly short) interval. Indeed, IO-FTS finds application whenever it is desired that the output variables do not exceed a given threshold during the transients, given a certain class of input signals.

It is important to remark that the definition of IO-FTS given in [1] is fully consistent with the definition of (state) FTS, where the state of a zero-input system, rather than the input and the output, are involved. The concept of FTS dates back to the Fifties, when it was introduced in the Russian literature ([3], [4]); later during the Sixties this concept appeared in the western control literature [5], [6]. Recently, sufficient conditions for FTS and finite-time stabilization (the corresponding design problem) have been provided in the control literature, see for example [7], [8], [9] in the context of linear systems, and [10], [11], [12] in the context of impulsive and hybrid systems.

In this paper first the definition of IO-FTS is recalled, and then some recent results are revised.

The definition of IO-FTS was originally introduced in [1], where two sufficient conditions to check IO-FTS when the classes of \mathcal{L}_2 and \mathcal{L}_∞ inputs were considered, respectively. Both conditions required the solution of a feasibility problem involving differential linear matrix inequalities (DLMI). In this paper we show that, in the case of \mathcal{L}_2 signals, the condition given in [1] is also necessary. Furthermore we also provide an alternative necessary and sufficient condition for this class of input signals, which requires that a certain Differential Lyapunov Equation (DLE) admits a positive definite solution. The efficiency of the two conditions is discussed by means of a numerical example.

Sufficient conditions for IO-FTS of a class

[†] G. De Tommasi, G. Carannante and A. Pironti are with the Dipartimento di Informatica e Sistemistica, Università degli Studi di Napoli Federico II, Via Claudio 21, 80125 Napoli, Italy.

[‡] R. Ambrosino is with Dipartimento per le Tecnologie, Università degli Studi di Napoli Parthenope, Napoli, Italy

[§] C. Cosentino and F. Amato are with the School of Computer and Biomedical Engineering, Università degli Studi Magna Græcia di Catanzaro, Campus di Germaneto “Salvatore Venuta”, 88100 Catanzaro, Italy.

of hybrid systems, namely *Switching Linear Systems* (SLSs), are also presented. SLSs are linear continuous-time systems with isolated discrete switching events, and whose state can undergo finite jump discontinuities ([13], [14]). In particular, we consider the case of *time-dependent* SLSs (TD-SLSs); for this class of switching systems the state jump and the change in the continuous dynamic is driven by time.

For the sake of completeness, it should be mentioned that a different concept of IO-FTS has been recently given for nonlinear systems. In particular, the authors of [15] consider systems with a norm bounded input signal over the interval $[0, +\infty]$ and a nonzero initial condition. In this case, the finite-time input-output stability is related to the property of a system to have a norm bounded output that, after a finite time interval T , does not depend anymore on the initial state. Hence, the concept of IO-FTS introduced in [1] and the one in [15] are different. Note, also, that the definition of IO-FTS given in [15] would not be well posed in the context of linear systems, since the output of a zero-input linear system cannot go to zero in finite time. Furthermore, input-output stabilization of time-varying systems on a finite time horizon is tackled also in [16]. However, as for classic IO stability, their concept of IO stability over a finite time horizon does not give explicit bounds on input and output signals, and does not allow the input and output to belong to different classes.

In [17] the problem of robust finite-time stabilization in the sense of [18] has been framed in the context of switched systems. However, in this paper the author consider uncertainty on the nonlinear dynamic, rather than uncertainty on the resetting times set, as it is considered in this paper.

The paper is organized as follows: in Section II the concept of IO-FTS of linear systems is introduced, and both analysis and synthesis results are presented. Section III presents result for the IO-FTS of time-dependent switching linear systems. Eventually, the design of a controller that minimizes the maximum displacement and velocity of a building subject to an earthquake of given magnitude is presented in Section IV.

Notation. Given a vector $v \in \mathbb{R}^n$ and a matrix $A \in \mathbb{R}^{n \times n}$, we will denote with $|v|$ the euclidian

norm of v , and with $|A|$ the induced matrix norm

$$|A| = \sup_{v \neq 0} \frac{|Av|}{|v|}.$$

Given the set $\Omega = [t_0, t_0 + T]$, with $t_0 \in \mathbb{R}$ and $T > 0$, the symbol $\mathcal{L}_p(\Omega)$ denotes the space of vector-valued signals for which¹

$$s(\cdot) \in \mathcal{L}_p(\Omega) \iff \left(\int_{\Omega} |s(\tau)|^p d\tau \right)^{\frac{1}{p}} < +\infty,$$

Given a symmetric positive definite matrix valued function $R(\cdot)$, bounded on Ω , and a vector-valued signal $s(\cdot) \in \mathcal{L}_p(\Omega)$, the weighted signal norm

$$\left(\int_{\Omega} [s(\tau)^T R(\tau) s(\tau)]^{\frac{p}{2}} d\tau \right)^{\frac{1}{p}},$$

will be denoted by $\|s(\cdot)\|_{p,R}$. If $p = \infty$

$$\|s(\cdot)\|_{\infty,R} = \text{ess sup}_{t \in \Omega} [s^T(t) R(t) s(t)]^{\frac{1}{2}}.$$

When the weighting matrix $R(\cdot)$ is constant and equal to the identity matrix I , we will use the simplified notation $\|s(\cdot)\|_p$.

II. IO-FTS OF LINEAR SYSTEMS

In this section we introduce the definition of IO-FTS and we revise both analysis and controller synthesis results.

A. Problem Statement

In general, $w(\cdot) \in \mathcal{L}_p$ does not guarantee that $y(\cdot) \in \mathcal{L}_p$; therefore it makes sense to give the definition of IO \mathcal{L}_p -stability. Roughly speaking (the precise definition is more involved, and the interested reader is referred to [2, Ch. 5]), system (1) is said to be \mathcal{L}_p -stable, if $w(\cdot) \in \mathcal{L}_p$ implies $y(\cdot) \in \mathcal{L}_p$. The most popular cases are the ones with $p = 2$ and $p = \infty$.

The concept of \mathcal{L}_p -stability is generally referred to an infinite interval of time. In this paper we are interested to study the input-output behavior of the system over a finite time interval.

Let us consider a linear time-varying (LTV) system in the form

$$\dot{x}(t) = A(t)x(t) + G(t)w(t), \quad x(t_0) = 0 \quad (1a)$$

$$y(t) = C(t)x(t), \quad (1b)$$

¹For the sake of brevity, we denote by \mathcal{L}_p the set $\mathcal{L}_p([0, +\infty))$.

where $A(\cdot) : \Omega \mapsto \mathbb{R}^{n \times n}$, $G(\cdot) : \Omega \mapsto \mathbb{R}^{n \times r}$, and $C(\cdot) : \Omega \mapsto \mathbb{R}^{m \times n}$, are continuous matrix-valued functions.

For the class of systems in the form (1), let us consider the following definition.

Definition 1 (IO-FTS of LTV systems): Given a positive scalar T , a class of input signals \mathcal{W} defined over $\Omega = [t_0, t_0 + T]$, a continuous and positive definite matrix-valued function $Q(\cdot)$ defined in Ω , system (1) is said to be IO-FTS with respect to $(\mathcal{W}, Q(\cdot), \Omega)$ if

$$w(\cdot) \in \mathcal{W} \Rightarrow y^T(t)Q(t)y(t) < 1, \quad t \in \Omega.$$

In this paper we consider the following two classes of input signals, which will require different analysis and synthesis techniques:

- i) the set \mathcal{W} coincides with the set of norm bounded square integrable signals over Ω , defined as

$$\mathcal{W}_2(\Omega, R(\cdot)) := \{w(\cdot) \in \mathcal{L}_2(\Omega) : \|w\|_{2,R} \leq 1\}.$$

- ii) The set \mathcal{W} coincides with the set of the uniformly bounded signals over Ω , defined as

$$\mathcal{W}_\infty(\Omega, R(\cdot)) := \{w(\cdot) \in \mathcal{L}_\infty(\Omega) : \|w\|_{\infty,R} \leq 1\}.$$

where $R(\cdot)$ denotes a continuous positive definite matrix-valued function. In the rest of the paper we will drop the dependency of \mathcal{W} on Ω and $R(\cdot)$ in order to simplify the notation.

Section II-B provides conditions for IO-FTS when the classes of \mathcal{W}_2 and \mathcal{W}_∞ inputs are considered. These conditions are then exploited in Section II-C to solve the following design problem, namely the problem of *input-output finite-time stabilization via dynamic output feedback*.

Problem 1: Consider the LTV system

$$\dot{x}(t) = A(t)x(t) + B(t)u(t) + G(t)w(t), \quad x(t_0) = 0 \quad (2a)$$

$$y(t) = C(t)x(t) \quad (2b)$$

where $u(\cdot)$ is the control input and $w(\cdot)$ is the exogenous input. Given the class of signals \mathcal{W} , and a continuous positive definite matrix-valued

function $Q(\cdot)$ defined over Ω , find a dynamic output feedback controller in the form

$$\dot{x}_c(t) = A_K(t)x_c(t) + B_K(t)y(t), \quad (3a)$$

$$u(t) = C_K(t)x_c(t) + D_K(t)y(t) \quad (3b)$$

where $x_c(t)$ has the same dimension of $x(t)$, such that the closed loop system obtained by the connection of (2) and (3) is IO-FTS with respect to $(\mathcal{W}, Q(\cdot), \Omega)$. In particular, the closed loop system is in the form

$$\begin{pmatrix} \dot{x}(t) \\ \dot{x}_c(t) \end{pmatrix} = \begin{pmatrix} A + BD_KC & BC_K \\ B_KC & A_K \end{pmatrix} \begin{pmatrix} x(t) \\ x_c(t) \end{pmatrix} + \begin{pmatrix} G \\ 0 \end{pmatrix} w(t) \\ =: A_{CL}(t)x_{CL}(t) + G_{CL}(t)w(t) \quad (4a)$$

$$y(t) = (C \ 0) x_{CL}(t) =: C_{CL}(t)x_{CL}(t) \quad (4b)$$

▲ where all the considered matrices depends on time, even when not explicitly written. ▲

B. Main Results

In this section we provide a number of conditions to check IO-FTS of linear systems. In particular, Theorem 1 provides two necessary and sufficient conditions for IO-FTS when \mathcal{W}_2 inputs are considered, while a sufficient condition for the class of \mathcal{W}_∞ signals is given in Theorem 2. These results are then extended to the case of non-strictly proper systems, and to the framework of uncertain systems, respectively.

Theorem 1 ([1] and [19]): Given system (1), the class of inputs \mathcal{W}_2 , a continuous positive definite matrix-valued function $Q(\cdot)$, and the time interval Ω , the following statements are equivalent:

- i) System (1) is IO-FTS with respect to $(\mathcal{W}_2, Q(\cdot), \Omega)$.
- ii) The inequality

$$\lambda_{\max}(Q^{\frac{1}{2}}(t)C(t)W(t, t_0)C^T(t)Q^{\frac{1}{2}}(t)) < 1 \quad (5)$$

holds for all $t \in \Omega$, where $\lambda_{\max}(\cdot)$ denotes the maximum eigenvalue, and $W(\cdot, \cdot)$ is the positive semidefinite solution of

$$\dot{W}(t, t_0) = A(t)W(t, t_0) + W(t, t_0)A^T(t) + G(t)R(t)^{-1}G^T(t) \quad (6a)$$

$$W(t_0, t_0) = 0 \quad (6b)$$

- iii) The coupled DLMI/LMI

$$\begin{pmatrix} \dot{P}(t) + A(t)^T P(t) + P(t)A(t) & P(t)G(t) \\ G(t)^T P(t) & -R(t) \end{pmatrix} < 0 \quad (7a)$$

$$P(t) > C(t)^T Q(t) C(t), \quad (7b)$$

admits a positive definite solution $P(\cdot)$ over Ω . ■

Remark 1: Theorem 1 holds also when the system matrices in (1) are piecewise continuous matrix-valued functions, provided that there exists an arbitrarily small $\epsilon > 0$ such that

$$\lambda_{\max}\left(Q^{\frac{1}{2}}(t)C(t)W(t, t_0)C^T(t)Q^{\frac{1}{2}}(t)\right) < 1 - \epsilon,$$

when checking **ii**), or that exists $\xi > 1$ such that

$$P(t) > \xi C^T(t)Q(t)C(t),$$

when checking **iii**).

The case of piecewise continuous system matrices allows to give a necessary and sufficient condition for IO-FTS for the special case of switching linear systems with known resetting times, and without state jumps (see Section III-B). ▲

In the next example we compare the numerical efficiency when applying the two necessary and sufficient conditions of Theorem 1 to check IO-FTS of LTV systems.

Example 1: Let us consider the system

$$\begin{aligned} A(t) &= \begin{pmatrix} 0.5 + t & 0.1 \\ 0.4 & -0.3 + t \end{pmatrix}, \quad G = \begin{pmatrix} 1 \\ 1 \end{pmatrix}, \\ C &= \begin{pmatrix} 1 & 1 \end{pmatrix}. \end{aligned} \quad (8)$$

together with the following IO-FTS parameters:

$$R = 1, \quad \Omega = [0, 0.5].$$

The conditions stated in Theorem 1 are, in principle, necessary and sufficient. However, due to the time-varying nature of the involved matrices, the numerical implementation of such conditions introduces some conservativeness.

In order to compare each other, from the computational point of view, the conditions stated in Theorem 1, the output weighting matrix is left as a free parameter. More precisely, we introduce the parameter Q_{max} , defined as the maximum value of the matrix Q such that system (8) is IO-FTS, and use the conditions stated in Theorem 1 to obtain an estimate of Q_{max} .

To recast the DLMI condition (7) in terms of LMIs, the matrix-valued functions $P(\cdot)$ has been assumed piecewise linear. In particular, the time interval Ω has been divided in $n = T/T_s$ subintervals,

and the time derivatives of $P(t)$ have been considered constant in each subinterval. It is straightforward to recognize that such a piecewise linear function can approximate at will a given continuous matrix function, provided that T_s is sufficiently small.

Given a piecewise linear function $P(\cdot)$, the feasibility problem (7) has been solved by exploiting standard optimization tools such as the Matlab LMI Toolbox® [20].

Since the equivalence between IO-FTS and condition (7) holds when $T_s \mapsto 0$, the maximum value of Q satisfying condition (7), namely Q_{max} , has been evaluated for different values of T_s . The obtained estimates of Q_{max} , the corresponding values of T_s and of the computation time are shown in Table I. These results have been obtained by using a PC equipped with an Intel®i7-720QM processor and 4 GB of RAM.

We have then considered the problem of finding the maximum value of Q satisfying condition (5), where $W(\cdot, \cdot)$ is the positive semidefinite solution of (6). In particular, equation (6) has been firstly integrated, with a sample time $T_s = 0.003$ s, by using the Euler forward method, and then the maximum value of Q satisfying condition (5) has been evaluated by means of a linear search. As a result, it has been found the estimate $Q_{max} = 0.345$, with a computation time of about 6 s, as it is shown in the last row of Table I.

We can conclude that the necessary and sufficient condition based on the reachability Gramian is much more efficient with respect to the solution of the DLMI when considering the IO-FTS analysis problem; however, the DLMI feasibility problem is necessary in order to solve the stabilization problem, as it is discussed in Section II-C. ▲

Theorem 2 ([1]): Let $\tilde{Q}(t) = tQ(t)$ and assume that the coupled DLMI/LMI

$$\begin{pmatrix} \dot{P}(t) + A^T(t)P(t) + P(t)A(t) & P(t)G(t) \\ G^T(t)P(t) & -R(t) \end{pmatrix} < 0 \quad (9a)$$

$$P(t) > C(t)^T \tilde{Q}(t) C(t), \quad (9b)$$

admits a positive definite solution $P(\cdot)$ over Ω , then system (1) is IO-FTS with respect to $(\mathcal{W}_\infty, Q(\cdot), \Omega)$. ■

If system (1) is non-strictly-proper, i.e. if

$$y(t) = Cx(t) + Dw(t), \quad (10)$$

TABLE I
MAXIMUM VALUES OF Q SATISFYING THEOREM 1 FOR THE LTV SYSTEM (8).

IO-FTS condition	Sample Time (T_s)	Maximum value of Q	Computation time [s]
DLMI (7)	0.05	0.2	2.5
	0.025	0.25	12.7
	0.0125	0.29	257
	0.00833	0.3	1259
Solution of (6) and inequality (5)	0.003	0.345	6

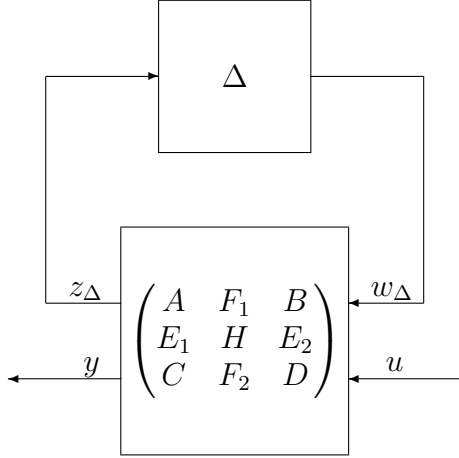

Fig. 1. The uncertain system (12).

then the following sufficient condition hold when \mathcal{W}_2 signals are considered.

Theorem 3 ([21] and [22]): If there exist a positive definite matrix-valued function $P(\cdot)$ and a scalar $\theta > 1$ that solve the coupled DLMI/LMI

$$\begin{pmatrix} \dot{P}(t) + A^T(t)P(t) + P(t)A(t) & P(t)G(t) \\ G^T(t)P(t) & -R(t) \end{pmatrix} < 0, \quad (11a)$$

$$\theta R(t) - R(t) > 2\theta D^T(t)Q(t)D(t) \quad (11b)$$

$$P(t) > 2\theta C^T(t)Q(t)C(t) \quad (11c)$$

over the time interval Ω , then the non-strictly-proper system (1a)-(10) is IO-FTS with respect to $(\mathcal{W}_2, Q(\cdot), \Omega)$. ■

Starting from Theorem 3, a sufficient condition for IO-FTS of non-strictly-proper systems when dealing with \mathcal{W}_∞ input signals can be derived letting $\tilde{Q}(t) = tQ(t)$, and replacing (19c) with

$$P(t) \geq 2\theta C^T(t)^T \tilde{Q}(t) C(t).$$

The previous results can be used to tackle the problem of IO-FTS of uncertain dynamical systems.

In particular let us consider the uncertain version of system (1), represented in Fig. 1 and described by the following equations

$$\dot{x}(t) = A(t)x(t) + F_1(t)w_\Delta(t) + B(t)u(t) \quad (12a)$$

$$z_\Delta(t) = E_1(t)x(t) + H(t)w_\Delta(t) + E_2(t)u(t) \quad (12b)$$

$$y(t) = C(t)x(t) + F_2(t)w_\Delta(t) + D(t)u(t) \quad (12c)$$

$$w_\Delta(t) = \Delta(t)z_\Delta(t), \quad (12d)$$

where $F_1(\cdot)$, $F_2(\cdot)$, $E_1(\cdot)$, and $E_2(\cdot)$ are continuous matrix-valued functions of compatible dimensions; finally the uncertainty $\Delta(\cdot)$ is any Lebesgue measurable matrix-valued function of compatible dimensions with $\|\Delta(t)\| \leq 1$, when $t \in \Omega$.

We know extend the definition of IO-FTS to the uncertain system (12).

Definition 2 (Robust IO-FTS of linear systems): Given a interval Ω , a class of input signals \mathcal{W} defined over Ω , a positive definite matrix-valued function $Q(\cdot)$, the uncertain system (12) is said to be robustly IO-FTS with respect to $(\mathcal{W}, Q(\cdot), \Omega)$ if for any admissible uncertainty realization $\Delta(\cdot)$ the resulting linear system is IO-FTS with respect to $(\mathcal{W}, Q(\cdot), \Omega)$. ▲

The following theorem gives a sufficient condition for IO-FTS with respect to \mathcal{W}_2 . In order to avoid awkward notation, when possible we will discard the time dependence of the matrix-valued functions.

Theorem 4 ([22]): If the following DLMI/LMI

$$\begin{pmatrix} \Psi_{11} & \Psi_{12} & \Psi_{13} & \Psi_{14} \\ \Psi_{12}^T & \Psi_{22} & 0 & \Psi_{24} \\ \Psi_{13}^T & 0 & \Psi_{33} & 0 \\ \Psi_{14}^T & \Psi_{24}^T & 0 & \Psi_{44} \end{pmatrix} < 0 \quad (13a)$$

$$\begin{pmatrix} 2\theta D^T Q D + R - \theta R + c_3 E_2^T E_2 & 2\theta D^T Q F_2 + c_3 E_2^T H \\ 2\theta F_2^T Q D + c_3 H^T E_2 & 2\theta F_2^T Q F_2 - c_3 (I - H^T H) \end{pmatrix} < 0 \quad (13b)$$

$$\begin{pmatrix} -P + 2\theta C^T Q C + c_4 E_1^T E_1 & 2\theta C^T Q F_2 + c_4 E_1^T H \\ 2\theta F_2^T Q C + c_4 H^T E_1 & 2\theta F_2^T Q F_2 - c_4 (I - H^T H) \end{pmatrix} < 0, \quad (13c)$$

where

$$\Psi_{11} = \dot{P} + A^T P + P A + c_1 E_1^T E_1 \quad (14a)$$

$$\Psi_{12} = P B \quad (14b)$$

$$\Psi_{13} = P F_1 + c_1 E_1^T H \quad (14c)$$

$$\Psi_{14} = P F_1 \quad (14d)$$

$$\Psi_{22} = -R + c_2 E_2^T E_2 \quad (14e)$$

$$\Psi_{24} = c_2 E_2^T H \quad (14f)$$

$$\Psi_{33} = -c_1 (I - H^T H) \quad (14g)$$

$$\Psi_{44} = -c_2 (I - H^T H) \quad (14h)$$

admits a positive definite solution $P(\cdot)$ in Ω for a given $c_1, c_2, c_3, c_4 > 0$, and $\theta > 1$, then system (12) is IO-FTS with respect to $(\mathcal{W}_2, Q(\cdot), \Omega)$. ■

C. IO Finite-Time Stabilization via Dynamic Output Feedback

We now exploit Theorem 1 to solve Problem 1. In particular, when dealing with \mathcal{W}_2 signals, a necessary and sufficient condition for the IO finite-time stabilization of system (1) via dynamic output feedback is provided in terms of a DLMI/LMI feasibility problem.

Theorem 5 ([23]): Given the exogenous input $w(t) \in \mathcal{W}_2$, Problem 1 is solvable if and only if there exist two continuously differentiable symmetric matrix-valued functions $S(\cdot), T(\cdot)$, a nonsingular matrix-valued function $N(\cdot)$ and matrix-valued functions $\hat{A}_K(\cdot), \hat{B}_K(\cdot), \hat{C}_K(\cdot)$ and $D_K(\cdot)$ such that the following DLMIs are satisfied

$$\begin{pmatrix} \Theta_{11}(t) & \Theta_{12}(t) & 0 \\ \Theta_{12}^T(t) & \Theta_{22}(t) & T(t)G(t) \\ 0 & G^T(t)T(t) & -R(t) \end{pmatrix} < 0, \quad t \in \Omega \quad (15a)$$

$$\begin{pmatrix} \Xi_{11}(t) & \Xi_{12}(t) & 0 \\ \Xi_{12}^T(t) & S(t) & S(t)C^T(t) \\ 0 & C(t)S(t) & Q^{-1}(t) \end{pmatrix} > 0, \quad t \in \Omega \quad (15b)$$

where

$$\Theta_{11}(t) = -\dot{S}(t) + A(t)S(t) + S(t)A^T(t) + B(t)\hat{C}_K(t) + \hat{C}_K^T(t)B^T(t) + G(t)R^{-1}(t)G^T(t)$$

$$\Theta_{12}(t) = A(t) + \hat{A}_K^T(t) + B(t)D_K(t)C(t) + G(t)R^{-1}(t)G^T(t)T(t)$$

$$\Theta_{22}(t) = \dot{T}(t) + T(t)A(t) + A^T(t)T(t) + \hat{B}_K(t)C(t) + C^T(t)\hat{B}_K^T(t)$$

$$\Xi_{11}(t) = T(t) - C^T(t)Q(t)C(t)$$

$$\Xi_{12}(t) = I - C^T(t)Q(t)C(t)S(t)$$

■
Remark 2 (Controller design): Assuming that the hypotheses of Theorem 5 are satisfied, in order to design the controller, the following steps have to be followed:

- i) Find $S(\cdot), T(\cdot), \hat{A}_K(\cdot), \hat{B}_K(\cdot), \hat{C}_K(\cdot)$ and $D_K(\cdot)$ such that (15) are satisfied.
- ii) Let $M(t) = [I - T(t)S(t)]N^{-T}(t)$.
- iii) Obtain $A_K(\cdot), B_K(\cdot)$ and $C_K(\cdot)$ by inverting

$$\begin{pmatrix} S(t) & I \\ I & T(t) \end{pmatrix} > 0 \quad (16a)$$

$$\hat{B}_K(t) = M(t)B_K(t) + T(t)B(t)D_K(t) \quad (16b)$$

$$\hat{C}_K(t) = C_K(t)N^T(t) + D_K(t)C(t)S(t) \quad (16c)$$

$$\begin{aligned} \hat{A}_K(t) &= \dot{T}(t)S(t) + \dot{M}(t)N^T(t) \\ &+ M(t)A_K(t)N^T(t) + T(t)B(t)C_K(t)N^T(t) \\ &+ M(t)B_K(t)C(t)S(t) + T(t)(A(t) \\ &+ B(t)D_K(t)C(t))S(t). \end{aligned} \quad (16d)$$

It is important to remark that, in order to invert (16), we need to preliminarily choose the value of $N(t)$. The only constraint for $N(t)$ is to be a non singular matrix. ▲

III. IO-FTS OF SWITCHING LINEAR SYSTEMS

This section firstly introduces the class switching linear systems we are dealing with in this paper, namely the time-dependent Switching Linear Systems (TD-SLS). Sufficient conditions for the IO-FTS of TD-SLS are presented, which require to check the feasibility of a Difference-Differential Linear Matrix Inequality (D/DLMI). In particular, we consider three different cases, depending on the

knowledge of the resetting times in the time interval Ω . In Section III-B we assume that the resetting times are perfectly known. Afterwards we derive a sufficient condition for IO-FTS when no information about the resetting times are available, i.e. the case of arbitrary switching signal $\sigma(\cdot)$. Eventually, in Section III-D we consider the case of uncertain resetting times. All the results in this section are given for \mathcal{W}_2 signals; however, by exploiting similar arguments as in Section II, similar conditions can be derived when \mathcal{W}_∞ signals are considered.

Sufficient conditions for finite-time stabilization of SLS via static output feedback when the resetting times are perfectly known can be derived from the results given in [24], where also the case of state-dependent switchings has been considered.

A. Time-dependent Switching Linear Systems

Let us consider the family of linear systems:

$$\dot{x}(t) = A_p(t)x(t) + G_p(t)w(t), \quad (17a)$$

$$y(t) = C_p(t)x(t) \quad (17b)$$

with $p \in \mathcal{P} = \{1, \dots, l\}$, and $A_p(\cdot) : \mathbb{R}_0^+ \mapsto \mathbb{R}^{n \times n}$, $G_p(\cdot) : \mathbb{R}_0^+ \mapsto \mathbb{R}^{n \times r}$, and $C_p(\cdot) : \mathbb{R}_0^+ \mapsto \mathbb{R}^{m \times n}$ are continuous matrix-valued functions.

To define a switching linear system generated by the family (17), the notion of *switching signal* $\sigma(\cdot)$ is needed (see [13]). In particular, $\sigma(\cdot) : \mathbb{R}_0^+ \mapsto \mathcal{P}$ is a piecewise constant function, where the discontinuities are called *resetting times*; we denote with $\mathcal{T} = \{t_1, t_2, \dots\} \subset \mathbb{R}_0^+$ the set of resetting times. Furthermore, the switching signal is assumed to be right-continuous everywhere.

Given the family (17) and the switching signal $\sigma(\cdot)$, the class of TD-SLS is given by

$$\dot{x}(t) = A_{\sigma(t)}(t)x(t) + G_{\sigma(t)}(t)w(t), \quad x(t_0) = 0, \quad t \notin \mathcal{T} \quad (18a)$$

$$x(t^+) = J(t)x(t), \quad t \in \mathcal{T} \quad (18b)$$

$$y(t) = C_{\sigma(t)}(t)x(t) \quad (18c)$$

where $J(\cdot) : \mathbb{R}_0^+ \mapsto \mathbb{R}^{n \times n}$ is a matrix-valued function. In particular (18a) describes the *continuous-time* dynamics of the TD-SLS, while (18b) represents the *resetting law*. The function $\sigma(t)$ specifies, at each time instant t , the linear system currently being *active*.

Note that, in the definition given above, all the linear systems in the family (17) have the same order. Although this could not be necessarily true, we make this assumption for the sake of simplicity. How to include the possibility of considering systems of different order is briefly discussed in Remark 3.

Without loss of generality, we assume that the first resetting time $t_1 \in \mathcal{T}$ is such that $t_1 > t_0$. Indeed, the case $t_1 = t_0$ is equivalent to a change of the initial state that will be in any case equal to 0, since $x(t_0) = 0$.

It is worth to notice that TD-SLSs include the case of time-dependent *impulsive dynamical linear systems* (TD-IDLS, [14], [25], [24]), where a single continuous dynamic is considered. Indeed, for TD-IDLS, the switching signal $\sigma(t)$ is constant for all t and can be discarded, while the resetting times set \mathcal{T} corresponds to the set of times where the state jumps.

Since we are interested in the behavior of TD-SLS in a given time interval, we assume that

$$\Omega \cap \mathcal{T} = \{t_1, t_2, \dots, t_h\},$$

i.e., only a finite number of *switches* occurs in (18). This also prevents the TD-SLS (18) from exhibiting Zeno behavior ([26]).

In the following we drop the dependency of σ on t , in order to simplify the notation.

B. IO-FTS of TD-SLS with Known Resetting Times

We first consider the case of known resetting times with \mathcal{W}_2 input signals.

Theorem 6 ([25] and [27]): Assume that the following D/DLMI

$$\begin{pmatrix} \dot{P}(t) + A_\sigma^T(t)P(t) + P(t)A_\sigma(t) & P(t)G_\sigma(t) \\ G_\sigma^T(t)P(t) & -R(t) \end{pmatrix} < 0, \quad \forall t \in \Omega, \tau \notin \mathcal{T} \quad (19a)$$

$$J^T(t_k)P(t_k^+)J(t_k) - P(t_k) \leq 0, \quad \forall t_k \in \Omega \cap \mathcal{T} \quad (19b)$$

$$P(t) > C_\sigma^T(t)Q(t)C_\sigma(t), \quad \forall t \in \Omega \quad (19c)$$

admits a positive definite piecewise differentiable matrix-valued solution $P(\cdot)$, then system (18) is IO-FTS with respect to $(\mathcal{W}_2, Q(\cdot), \Omega)$. ■

Remark 3: It should be noticed that when family (17) is made of systems with different dimensions, Theorem 6 still holds. Indeed, if this is the case inequality (19b) can still be defined by choosing $P(\cdot)$ with the same dimension of $A_\sigma(\cdot)$ for all t , and by noticing that, in general, $J(t_k)$ is not a square matrix. \blacktriangle

C. IO-FTS of TD-SLS under Arbitrary Switching

The case of no knowledge of the resetting times, i.e. arbitrary switching (AS), is tackled in this section. The main difference between the AS case and the certain case presented in the previous section is that the optimization matrix $P(\cdot)$ cannot exhibit any jumps in Ω , since the resetting times are unknown. It turns out that in the AS case $P(\cdot)$ must be a differentiable matrix-valued function.

Theorem 7 ([27]): Assume that the following D/DLMI

$$\begin{pmatrix} \dot{P}(t) + A_i^T(t)P(t) + P(t)A_i(t) & P(t)G_i(t) \\ G_i^T(t)P(t) & -R(t) \end{pmatrix} < 0 \quad (20a)$$

$$J^T(t)P(t)J(t) - P(t) \leq 0 \quad (20b)$$

$$P(t) \geq C_i^T(t)Q(t)C_i(t) \quad (20c)$$

admits a positive definite and continuous solution $P(\cdot)$ in Ω and for all $i \in \mathcal{P}$, then system (18) is IO-FTS wrt $(\mathcal{W}_2, Q(\cdot), \Omega)$ under arbitrary switching. \blacksquare

Although conditions (20) are similar to the ones given in Theorem 6, they have to be checked for each linear system in (17) in the whole time interval. This unavoidably leads to more conservatism. In particular, since $P(\cdot)$ must be continuous, inequality (20b) implies $J(\cdot)$ to be Schur for all t in Ω . Hence, due to the lack of knowledge on the resetting times, it is necessary to have *stable* resetting laws in order to meet conditions (20).

D. IO-FTS of TD-SLS under Uncertain Switching

Let us now consider TD-SLS with uncertain switching (US), i.e. the case where the k -th resetting time is known with a given uncertainty $\pm\Delta T_k$.

Even in the US case, the sufficient condition to be checked to assess IO-FTS turns out to be more conservative with respect to the one derived in Section III-B. Furthermore a trade-off between

uncertainty on the resetting times and additional constraints to be added in order to check IO-FTS clearly appears. In particular, the less is the uncertainty on the resetting times, the fewer are the additional constraints to be verified.

Since we still consider $\sigma(\cdot)$ piecewise constant with discontinuities in correspondence of $t_k \in \mathcal{T}$, it is useful to introduce the following definitions to describe the uncertainty on the resetting times

$$\begin{aligned} \Psi_1 &=]t_0, t_1 + \Delta T_1[, \\ \Psi_j &=]t_{j-1} - \Delta T_{j-1}, t_j + \Delta T_j[, \quad j = 2, \dots, h \\ \Psi_{h+1} &=]t_h - \Delta T_h, t_0 + T[\\ \Gamma_j &= [t_j - \Delta T_j, t_j + \Delta T_j], \quad j = 1, \dots, h \end{aligned}$$

with

$$\bigcap_{j=1}^h \Gamma_j = \emptyset, \quad (21)$$

which implies the knowledge of the resetting times order.

Theorem 8 ([27]): If there exist $h + 1$ positive definite matrix-valued functions $P_j(\cdot)$, $j = 1, \dots, h + 1$, that satisfy the following D/DLMI

$$\begin{pmatrix} \dot{P}_j(t) + A_{\sigma(t_{j-1})}^T(t)P_j(t) + P_j(t)A_{\sigma(t_{j-1})}(t) & P_j(t)G_{\sigma(t_{j-1})}(t) \\ G_{\sigma(t_{j-1})}^T(t)P_j(t) & -R(t) \end{pmatrix} < 0 \quad (22a)$$

$$t \in \Psi_j, \quad j = 1, \dots, h + 1$$

$$J^T(t)P_{j+1}(t)J(t) - P_j(t) \leq 0, \quad (22b)$$

$$t \in \Gamma_j, \quad j = 1, \dots, h$$

$$P_j(t) \geq C_{\sigma(t_j)}^T(t)Q(t)C_{\sigma(t_j)}(t), \quad (22c)$$

$$t \in \Psi_j, \quad j = 1, \dots, h + 1$$

then system (18) is IO-FTS wrt $(\mathcal{W}_2, Q(\cdot), \Omega)$ under uncertain switching defined by ΔT_k , $k = 1, \dots, h$. \blacksquare

It should be noted that the length of Ψ_j and Γ_j decreases when the uncertainties get smaller, leading us to the same result of Theorem 6 when $\Delta T_k = 0$ for all k . Eventually, note that even the partial knowledge of the resetting times allows us to check the IO-FTS of the TD-SLS system (18) without requiring the different linear systems in the family (17) to be IO-FTS.

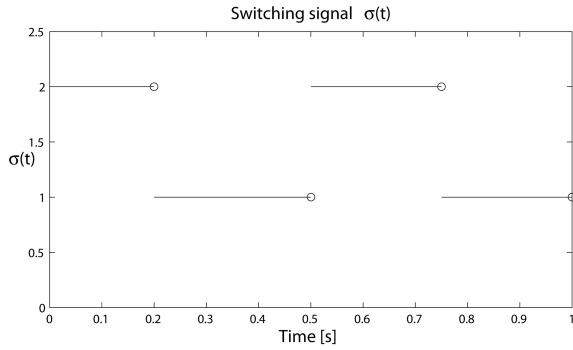

Fig. 2. Switching signal for the TD-SLS considered in Example 2.

Example 2: The following numerical example shows the effectiveness of the proposed approach when checking IO-FTS of TD-SLS in the case of different levels of knowledge on the resetting times. In particular, we focus our attention on input signals belonging to the class \mathcal{W}_∞ .

Let us consider the second order TD-SLS given by the following two linear systems

$$A_1 = \begin{pmatrix} 0.5 + \rho t & 0.1 \\ 0.4 & -0.3 + \rho t \end{pmatrix},$$

$$G_1 = \begin{pmatrix} 1 \\ 1 \end{pmatrix}, C_1 = (1 \ 1),$$

$$A_2 = \begin{pmatrix} 0.15 + \rho t & 0.2 \\ 1 & -0.25 - \rho t \end{pmatrix},$$

$$G_2 = \begin{pmatrix} 1 \\ 0 \end{pmatrix}, C_2 = (2 \ 1),$$

with $\rho = 0.5$. The value of the switching signal $\sigma(\cdot)$ in the time interval $\Omega = [0, 1]$ is shown in Fig. 2, hence

$$[0, 1] \cap \mathcal{T} = \{0.2, 0.5, 0.75\}.$$

The resetting law is defined by

$$J = \begin{pmatrix} -1.1 & 0 \\ 0 & 0.1 \end{pmatrix}.$$

As for the IO-FTS we consider

$$w(\cdot) = 1, R = 1, t_0 = 0, \text{ and } T = 1. \quad (23)$$

Note that the two considered linear systems are both unstable. Furthermore, they are also IO finite-time unstable when considering the parameters specified in (23) and when $Q \geq 0.12$, as shown in Fig. 3.

Let now consider the case of uncertain switching with $\Delta T_j = 0.03$ s for all j . The D/DLMI needed

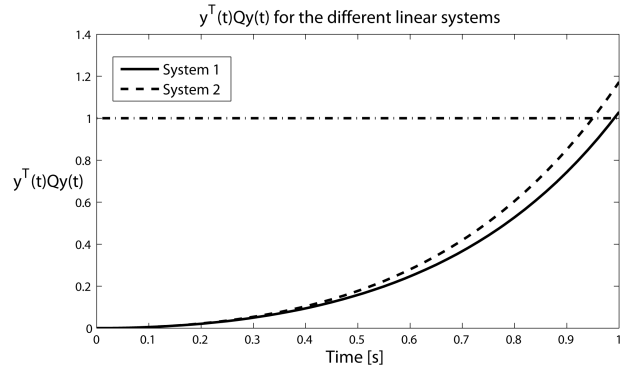

Fig. 3. Weighted output for the different linear systems defined in Example 2 when $Q = 0.12$.

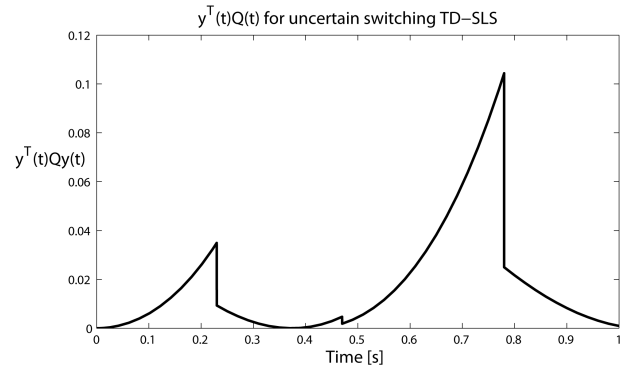

Fig. 4. Worst case weighted output for the uncertain switching when $Q = 0.14$.

to be solved to check IO-FTS can be recast into LMIs by choosing the $h+1$ piecewise linear matrix-valued function $P_i(\cdot)$. By exploiting the Matlab LMI Toolbox, it turns out that the considered system is IO-FTS wrt $(\mathcal{W}_\infty, Q, [0, 1])$ for all $Q \leq 0.14$. Fig. 4 shows the worst case output. \blacktriangle

IV. EXAMPLE

In this section we consider, as an example of application, an N-story building subject to an earthquake. The building lumped parameters model is reported in Fig. 5. The control system is made by a base isolator together with an actuator that generates a control force on the base floor.

The aim of the isolator is to produce a dynamic decoupling of the structure from its foundation. If this is the case, the inter-story drifts are reduced and the building behavior can be approximated by the one of a rigid body ([28]). Furthermore, the description of the system in terms of absolute coordinates, i.e., when the displacement is defined

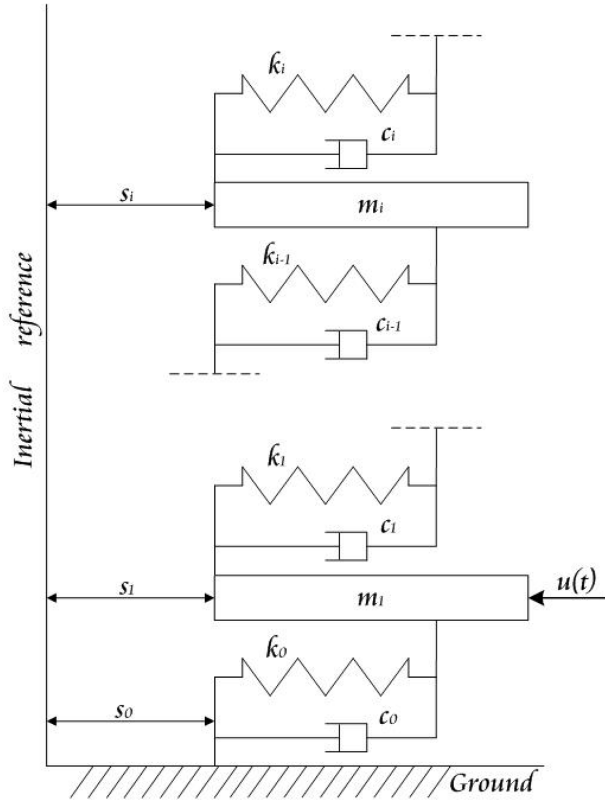

Fig. 5. Lumped parameters model of a N -story building.

with respect to an inertial reference, ensures that the disturbances act only at the base floor ([29]).

It turns out that it is sufficient to provide an actuator only on the base floor in order to keep the displacement and velocity of the structure under a specified boundary. Indeed, the goal of the control system is to overcome the forces generated by the isolation system at the base floor, in order to minimize the absolute displacement and velocity of the structure.

The state-space model of the considered system is

$$\dot{x}(t) = Ax(t) + Bu(t) + Gw(t) \quad (24a)$$

$$y(t) = Cx(t) \quad (24b)$$

If we denote with $s_0(\cdot)$ and $\dot{s}_0(\cdot)$ the displacement and the velocity of the ground and with $s_i(\cdot)$ and $\dot{s}_i(\cdot)$ the displacement and the velocity of the i -th floor, then the state vector can be defined as $x(\cdot) = [x_1(\cdot) \ x_2(\cdot) \ \dots \ x_{2N}^T(\cdot)]$, where $x_i(\cdot) = \dot{s}_i(\cdot)$ and $x_{i+N}(\cdot) = s_i(\cdot)$, $i = 1, \dots, N$. The vector $w(\cdot) = [s_0(\cdot) \ \dot{s}_0^T(\cdot)]$ represents the exogenous input and $u(t)$ is the control force applied to the base floor.

The model matrices in (24) are equal to

$$A = \begin{pmatrix} A_1 & A_2 \\ I & 0 \end{pmatrix}, \quad B = \begin{pmatrix} 1/m_1 \\ 0 \end{pmatrix},$$

$$G = \begin{pmatrix} k_0/m_1 & c_0/m_1 \\ 0 & 0 \end{pmatrix},$$

$$C = \begin{pmatrix} \frac{-(c_0+c_1)}{m_1} & \frac{c_1}{m_1} & \underbrace{0 \ \dots \ 0}_{N-2} & \frac{-(k_0+k_1)}{m_1} & \frac{k_1}{m_1} & \underbrace{0 \ \dots \ 0}_{N-2} \end{pmatrix},$$

where A_1 and A_2 are $N \times N$ tridiagonal matrices defined in (25).

The model parameters are reported in Table II for the six story building considered in this example.

Taking into account the presence of the isolator and given the choice of the C matrix, the controlled output is related to the acceleration at the ground floor. Concerning the choice of the IO-FTS parameters, for a given geographic area these can be chosen starting from the worst earthquakes on record. Indeed, from the time trace of the ground acceleration, velocity and displacement of the *El Centro* earthquake (May 18, 1940) reported in Fig. 6, the following IO-FTS parameters have been considered

$$R = I, \quad Q = 0.1, \quad \Omega = [0, 35]. \quad (26)$$

Exploiting Theorem 5 it is possible to find the controller matrix-valued functions $A_k(\cdot)$, $B_k(\cdot)$, $C_k(\cdot)$, and $D_k(\cdot)$ that make system (24) IO-FTS with respect to the parameters given in (26), when \mathcal{W}_2 disturbances are considered.

Fig. 7 shows the base floor velocity and displacement histories for the uncontrolled building with base isolation system, under the assumed earthquake excitation. As it can be seen in Fig. 8, the control system manages to keep very small both the velocity and the displacement of the structure. The relative control force is depicted in Fig. 9.

CONCLUSIONS

The concept of IO-FTS is useful to deal with the input-output behavior of dynamical linear systems, when the focus is on the boundedness of the output signal over a finite interval of time. In this paper some recent results on IO-FTS of both linear and switching systems have been revised.

$$A_1 = \begin{pmatrix} -\frac{(c_0+c_1)}{m_1} & \frac{c_1}{m_1} & 0 & \dots & \dots & \dots & 0 \\ 0 & \dots & \frac{c_{i-1}}{m_i} & -\frac{(c_{i-1}+c_i)}{m_i} & \frac{c_i}{m_i} & \dots & 0 \\ 0 & \dots & \dots & \dots & 0 & \frac{c_{N-1}}{m_N} & -\frac{c_{N-1}}{m_N} \end{pmatrix}, \quad (25a)$$

$$A_2 = \begin{pmatrix} -\frac{(k_0+k_1)}{m_1} & \frac{k_1}{m_1} & 0 & \dots & \dots & \dots & 0 \\ 0 & \dots & \frac{k_{i-1}}{m_i} & -\frac{(k_{i-1}+k_i)}{m_i} & \frac{k_i}{m_i} & \dots & 0 \\ 0 & \dots & \dots & \dots & 0 & \frac{k_{N-1}}{m_N} & -\frac{k_{N-1}}{m_N} \end{pmatrix}. \quad (25b)$$

TABLE II
MODEL PARAMETERS FOR THE CONSIDERED N-STORY BUILDING.

Mass [kg]	Spring coefficient [kN/m]	Damping coefficient [kNs/m]
	$k_0=1200$	$c_0=2.4$
$m_1=6800$	$k_1=33732$	$c_1=67$
$m_2=5897$	$k_2=29093$	$c_2=58$
$m_3=5897$	$k_3=28621$	$c_3=57$
$m_4=5897$	$k_4=24954$	$c_4=50$
$m_5=5897$	$k_5=19059$	$c_5=38$
$m_6=5897$		

REFERENCES

- [1] F. Amato, R. Ambrosino, C. Cosentino, and G. De Tommasi, "Input-output finite-time stabilization of linear systems," *Automatica*, vol. 46, no. 9, pp. 1558–1562, Sep. 2010.
- [2] H. K. Khalil, *Nonlinear Systems*, 3rd ed. Prentice Hall, 2001.
- [3] A. Lebedev, "The problem of stability in a finite interval of time [in Russian]," *Journal of Applied Math. and Mechanics*, vol. 18, pp. 75–94, 1954.
- [4] —, "On stability of motion during a given interval of time [in Russian]," *Journal of Applied Math. and Mechanics*, vol. 18, pp. 139–148, 1954.
- [5] P. Dorato, "Short time stability in linear time-varying systems," in *Proc. IRE International Convention Record Part 4*, 1961, pp. 83–87.
- [6] A. Michel and D. Porter, "Practical stability and finite-time stability of discontinuous systems," *IEEE Trans. Circuit Theory*, vol. CT-19, pp. 123–129, 1972.
- [7] F. Amato, M. Ariola, and C. Cosentino, "Finite-time stabilization via dynamic output feedback," *Automatica*, vol. 42, pp. 337–342, 2006.
- [8] G. Garcia, S. Tarbouriech, and J. Bernussou, "Finite-time stabilization of linear time-varying continuous systems," *IEEE Trans. Auto. Contr.*, vol. 54, no. 4, pp. 861–865, Apr. 2009.
- [9] Y. Shen, "Finite-time control of linear parameter-varying systems with norm-bounded exogenous disturbance," *J. Contr. Theory Appl.*, vol. 6, no. 2, pp. 184–188, 2008.

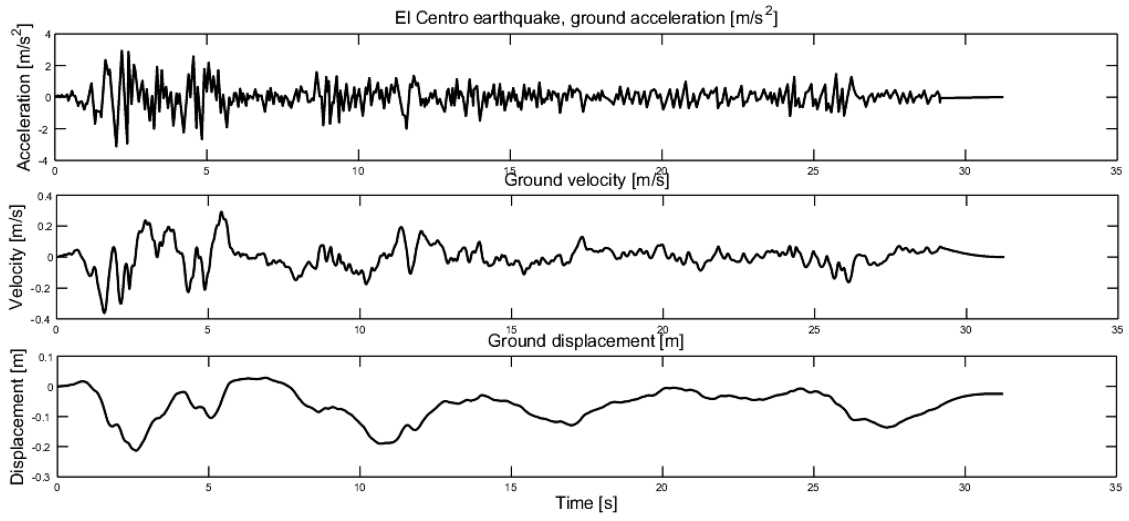

Fig. 6. Ground acceleration, velocity and displacement of El Centro earthquake.

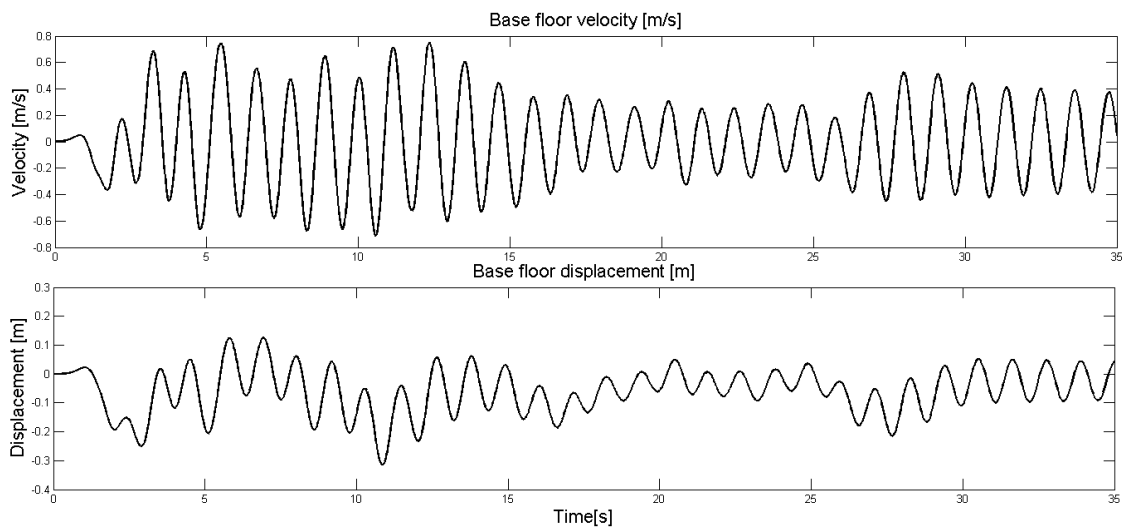

Fig. 7. Uncontrolled base floor velocity and displacement.

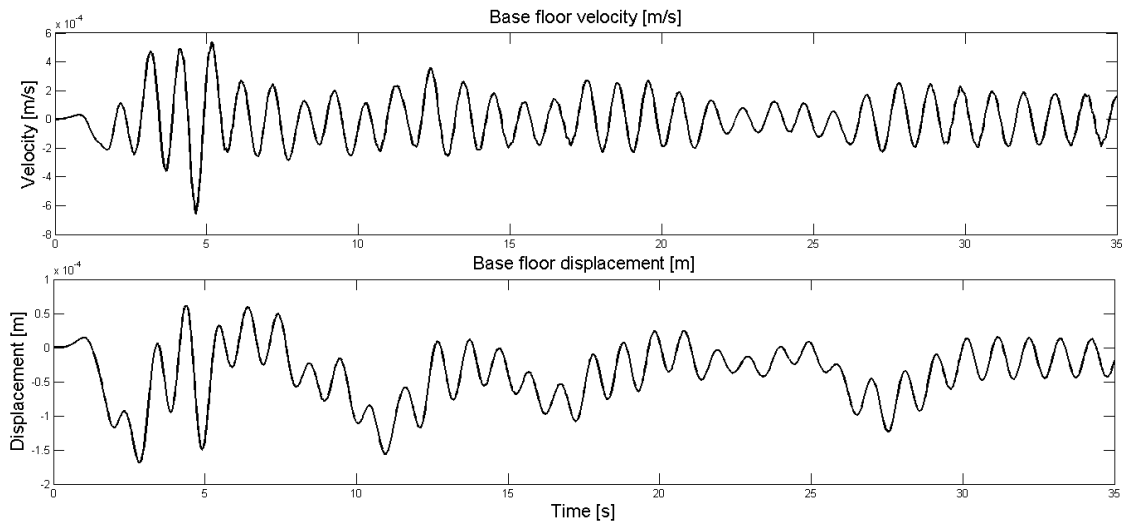

Fig. 8. Controlled base floor velocity and displacement.

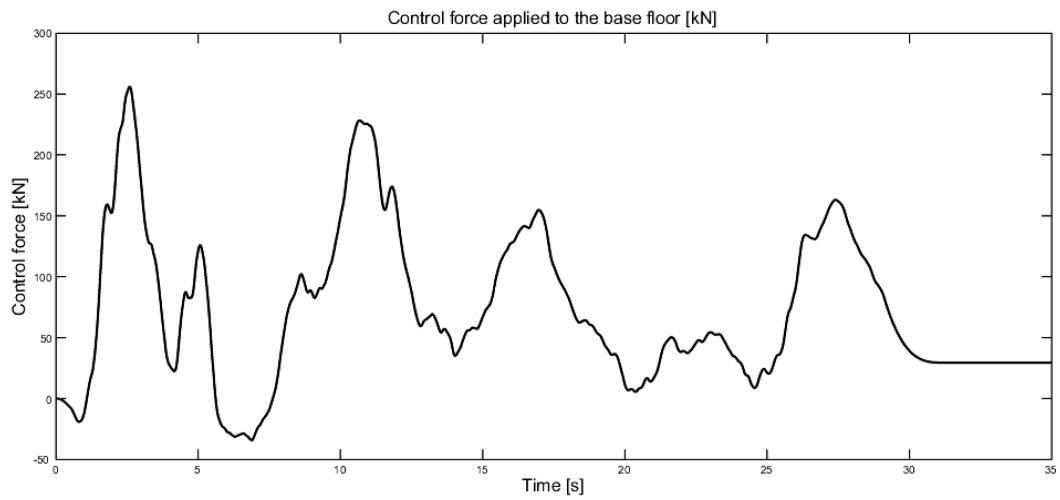

Fig. 9. Control force applied to the base floor.

- [10] S. Zhao, J. Sun, and L. Liu, "Finite-time stability of linear time-varying singular systems with impulsive effects," *Int. J. Control*, vol. 81, no. 11, pp. 1824–1829, 2008.
- [11] R. Ambrosino, F. Calabrese, C. Cosentino, and G. De Tommasi, "Sufficient conditions for finite-time stability of impulsive dynamical systems," *IEEE Trans. Auto. Contr.*, vol. 54, no. 4, pp. 364–369, Apr. 2009.
- [12] H. Du, X. Lin, and S. Li, "Finite-time stability and stabilization of switched linear systems," in *Proc. Joint 48th IEEE Conference on Decision and Control and 28th Chinese Control Conference*, Shanghai, P.R. China, Dec. 2009, pp. 1938–1943.
- [13] D. Liberzon, *Switching in Systems and Control*. Birkhäuser, 2003.
- [14] W. Haddad, V. Chellaboina, and S. Nersisov, *Impulsive and Hybrid Dynamical Systems*. Princeton University Press, 2006.
- [15] Y. Hong, Z. Jiang, and G. Feng, "Finite-Time Input-to-State Stability and Applications to Finite-Time Control Design," *SIAM J. Control Optim.*, vol. 48, no. 7, pp. 4395–4418, 2010.
- [16] U. Shaked and V. Suplin, "A new bounded real lemma representation for the continuous-time case," *IEEE Trans. Auto. Contr.*, vol. 46, no. 9, pp. 1420–1426, Sep. 2001.
- [17] Y. Orlov, "Finite time stability and robust control synthesis of uncertain switched systems," *SIAM J. Control Optim.*, vol. 43, no. 4, pp. 1253–1271, 2005.
- [18] S. Bhat and D. Bernstein, "Finite-time stability of continuous autonomous systems," *SIAM J. Control Optim.*, vol. 38, no. 3, pp. 751–766, 2000.
- [19] F. Amato, G. Carannante, G. De Tommasi, and A. Pironti, "Necessary and Sufficient Conditions for Input-Output Finite-Time Stability of Linear Time-Varying Systems," in *accepted for presentation to 50th IEEE Conference on Decision and Control and European Control Conference*, 2011.
- [20] P. Gahinet, A. Nemirovski, A. J. Laub, and M. Chilali, *LMI Control Toolbox*. The Mathworks Inc, 1995.
- [21] F. Amato, R. Ambrosino, M. Ariola, and G. De Tommasi, "Input to output finite-time stabilization of discrete-time linear systems," in *18th IFAC World Congress*, Milano, Italy, September 2011.
- [22] F. Amato, C. Cosentino, and G. De Tommasi, "Sufficient Conditions for Robust Input-Output Finite-Time Stability of Linear Systems in Presence of Uncertainties," in *18th IFAC World Congress*, Milano, Italy, September 2011.
- [23] F. Amato, G. Carannante, G. De Tommasi, and A. Pironti, "Input-output finite-time stabilization of LTV systems via dynamic output feedback," in *accepted for presentation to 50th IEEE Conference on Decision and Control and European Control Conference*, 2011.
- [24] F. Amato, G. Carannante, and G. De Tommasi, "Input-output finite-time stabilisation of a class of hybrid systems via static output feedback," *Int. J. Control*, vol. 84, no. 6, pp. 1055–1066, Jun. 2011.
- [25] F. Amato and G. De Tommasi, "Input-output finite-time stabilization for a class of hybrid systems," in *Proc. 4th IFAC Symposium on System, Structure and Control*, Ancona, Italy, Sept. 2010.
- [26] A. Ames *et al.*, "Is there life after Zeno? Taking executions past the breaking (Zeno) point," in *Proc. American Control Conference*, Minneapolis, MN, Jun. 2006.
- [27] F. Amato, G. Carannante, and G. De Tommasi, "Input-output Finite-Time Stability of Switching Systems with Uncertainties on the Resetting Times," in *19th Mediterranean Conference on Control and Automation*, Corfu, Greece, June 2011.
- [28] F. Pozo, L. Acho, J. Rodellar, and J. M. Rossell, "A velocity-based seismic control for base-isolated building structures," in *Proc. American Control Conference*, St. Louis, MO, USA, June 2009.
- [29] J. M. Kelly, G. Leitmann, and A. Soldatos, "Robust control of base-isolated structures under earthquake excitation," *Journal of Optimization Theory and Applications*, vol. 53, no. 1, 1987.