

Partially traced categories*

Octavio Malherbe, Philip J. Scott and Peter Selinger

Abstract

This paper deals with questions relating to Haghverdi and Scott’s notion of partially traced categories. The main result is a representation theorem for such categories: we prove that every partially traced category can be faithfully embedded in a totally traced category. Also conversely, every symmetric monoidal subcategory of a totally traced category is partially traced, so this characterizes the partially traced categories completely. The main technique we use is based on Freyd’s paracategories, along with a partial version of Joyal, Street, and Verity’s Int-construction.

1 Introduction

Partially traced monoidal categories were introduced by Haghverdi and Scott [10, 11] as a general framework for modelling a typed categorical version of Girard’s Geometry of Interaction. The Geometry of Interaction (GoI) was developed by Girard in a series of influential works that examine dynamical models of proofs in linear logic and their evaluation under normalization, using operator algebras and functional analysis [4, 5, 6, 7]. This program has recently received increased attention as also having connections with quantum computation and quantum protocols [1, 21, 22].

One of the objectives of this article is to systematically explore the Haghverdi-Scott notion of partially traced categories by providing a representation theorem which establishes a precise correspondence between partially traced and totally traced categories.

2 Background

To fix the notation for this paper, we briefly recall some basic notions from monoidal category theory. For more details, see e.g. [2, 16, 17].

2.1 Monoidal categories

Definition 2.1. A *monoidal* category, also sometimes called *tensor* category, is a category \mathcal{C} with a bifunctor $\otimes : \mathcal{C} \times \mathcal{C} \rightarrow \mathcal{C}$ together with a unit object $I \in \mathcal{C}$ and natural isomorphisms $\rho_A : A \otimes I \xrightarrow{\cong} A$, $\lambda_A : I \otimes A \xrightarrow{\cong} A$, and $\alpha_{A,B,C} : A \otimes (B \otimes C) \xrightarrow{\cong} (A \otimes B) \otimes C$, satisfying some coherence axioms [17]. The monoidal category is *strict* if ρ , λ , and α are identities. It is well-known that every monoidal category is equivalent to a strict one [17]. Here, and throughout the paper, we often omit the subscripts from notations such as $\alpha_{A,B,C}$ when they are clear from the context.

Definition 2.2. A *symmetric* monoidal category consists of a monoidal category \mathcal{C} with a chosen natural isomorphism $\sigma_{A,B} : A \otimes B \xrightarrow{\cong} B \otimes A$, called *symmetry*, which satisfies $\sigma_{B,A} \circ \sigma_{A,B} = 1_{A \otimes B}$, $\lambda_A \circ \sigma_{A,I} = \rho_A$, and $\alpha_{C,A,B} \circ \sigma_{A \otimes B, C} \circ \alpha_{A,B,C} = (\sigma_{A,C} \otimes 1_B) \circ \alpha_{A,C,B} \circ (1_A \otimes \sigma_{B,C})$.

Definition 2.3. A *monoidal functor* $(F, m_{A,B}, m_I)$ between monoidal categories $(\mathcal{C}, \otimes, I, \alpha, \rho, \lambda)$ and $(\mathcal{D}, \otimes', I', \alpha', \rho', \lambda')$ is a functor $F : \mathcal{C} \rightarrow \mathcal{D}$ equipped with:

*This research was supported by NSERC.

- morphisms $m_{A,B} : F(A) \otimes' F(B) \rightarrow F(A \otimes B)$ natural in A and B ,
- a morphism $m_I : I' \rightarrow F(I)$,

which satisfy some coherence axioms preserving the symmetric monoidal structure [17]. A monoidal functor is *strong* when m_I and all the $m_{A,B}$ are isomorphisms. It is *strict* when m_I and all the $m_{A,B}$ are identities.

If in addition, \mathcal{C} and \mathcal{D} are symmetric monoidal with respective symmetries σ and σ' , then F is a *symmetric* monoidal functor if for all A, B ,

$$\begin{array}{ccc} FA \otimes' FB & \xrightarrow{\sigma'} & FB \otimes' FA \\ m \downarrow & & \downarrow m \\ F(A \otimes B) & \xrightarrow{F(\sigma)} & F(B \otimes A). \end{array}$$

2.2 Traced monoidal categories

Traced monoidal categories were introduced by Joyal, Street and Verity [15] as an attempt to model an abstract notion of trace arising in different fields of mathematics, such as algebraic topology, knot theory, and theoretical computer science. In computer science, this abstraction has been particularly useful in the description of feedback, fixed-point operators, the execution formula in Girard's Geometry of Interaction [4], etc.

Definition 2.4. A *trace* for a symmetric monoidal category $(\mathcal{C}, \otimes, I, \rho, \lambda, \sigma)$ consists of a family of functions

$$\mathrm{Tr}_{A,B}^U : \mathcal{C}(A \otimes U, B \otimes U) \rightarrow \mathcal{C}(A, B),$$

natural in A, B , and dinatural in U , satisfying the following axioms. Here we write without loss of generality as if \mathcal{C} were strict.

- **Strength:** For all $f : A \otimes U \rightarrow B \otimes U$ and $g : C \rightarrow D$,

$$g \otimes \mathrm{Tr}_{A,B}^U(f) = \mathrm{Tr}_{C \otimes A, D \otimes B}^U(g \otimes f).$$

- **Vanishing I:** For all $f : A \otimes I \rightarrow B \otimes I$,

$$f = \mathrm{Tr}_{A,B}^I(f).$$

- **Vanishing II:** For all $f : A \otimes U \otimes V \rightarrow B \otimes U \otimes V$,

$$\mathrm{Tr}_{A,B}^U(\mathrm{Tr}_{A \otimes U, B \otimes U}^V(f)) = \mathrm{Tr}_{A,B}^{U \otimes V}(f).$$

- **Yanking:** For all A ,

$$\mathrm{Tr}_{A,A}^A(\sigma_{A,A}) = 1_A.$$

Because we need them later, we explicitly spell out the conditions of naturality and dinaturality:

- **Naturality:** For all $f : A \otimes U \rightarrow B \otimes U$, $g : A' \rightarrow A$, and $h : B \rightarrow B'$,

$$h \circ \mathrm{Tr}_{A,B}^U(f) \circ g = \mathrm{Tr}_{A',B'}^U((h \otimes 1_U) \circ f \circ (g \otimes 1_U)).$$

- **Dinaturality:** For all $f : A \otimes U \rightarrow B \otimes U'$ and $g : U' \rightarrow U$,

$$\mathrm{Tr}_{A,B}^U((1_B \otimes g) \circ f) = \mathrm{Tr}_{A,B}^{U'}(f \circ (1_A \otimes g)).$$

Definition 2.5. Let $(\mathcal{C}, \mathrm{Tr})$ and $(\mathcal{D}, \mathrm{Tr}')$ be traced monoidal categories. We say that a strong symmetric monoidal functor $(F, m) : \mathcal{C} \rightarrow \mathcal{D}$ is *traced monoidal* when it preserves the trace operator in the following sense: for all $f : A \otimes U \rightarrow B \otimes U$,

$$\mathrm{Tr}'_{FA,FB}^{FU}(m_{A,U}^{-1} \circ F(f) \circ m_{A,U}) = F(\mathrm{Tr}_{A,B}^U(f)) : FA \rightarrow FB.$$

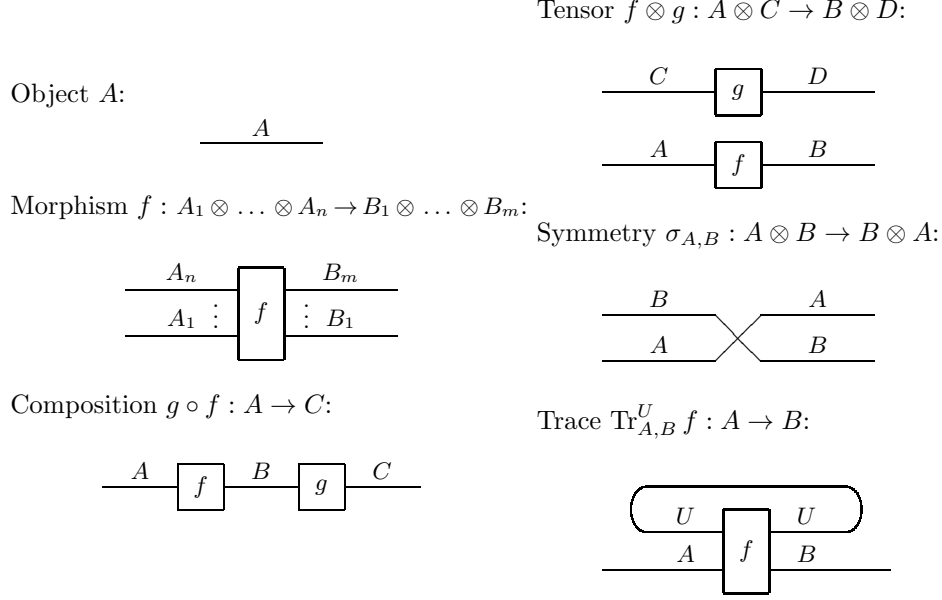

Table 1: The graphical language of traced monoidal categories

2.3 Graphical language

Graphical calculi are a useful tool for reasoning about monoidal categories, dating back at least to the work of Penrose [19]. There are various graphical languages that are provably sound and complete for equational reasoning in different kinds of monoidal categories. They allow efficient geometrical and topological insights to be used in a kind of calculus of “wirings”, which simplifies diagrammatic reasoning. See [23] for a detailed survey of such graphical languages.

In particular, there is a graphical language for traced monoidal categories, which was already used in Joyal, Street, and Verity’s original paper [15]. As shown in Table 1, wires represent objects, boxes represent morphisms, composition is represented by connecting the outgoing wires of one diagram to the incoming wires of another, and tensor product is represented by stacking wires and boxes vertically. Finally, trace is represented by a loop. The axioms of traced (symmetric) monoidal categories are illustrated in Table 2.

We say that a diagram is *expanded* if all its wires are labelled by object variables and all its boxes are labelled by morphism variables (as opposed to composite object and morphism terms). Thus, for example, a wire labelled $A \otimes B$ is not expanded, but a pair of wires labelled A and B is expanded. Each non-expanded diagram can be converted to an equivalent expanded diagram. The following theorem shows the validity of diagrammatic reasoning in traced monoidal categories.

Theorem 2.6 (Coherence, see [23]). *A well-formed equation between morphisms in the language of symmetric traced monoidal categories follows from the axioms of symmetric traced monoidal categories if and only if it holds, up to isomorphism of expanded diagrams, in the graphical language.*

2.4 Compact closed categories

Definition 2.7. A *compact closed* category is a symmetric monoidal category \mathcal{C} in which for every object A , there is a given object A^* , called the *dual* of A , and a given pair of arrows $\eta : I \rightarrow A^* \otimes A$ (called the *unit*), $\varepsilon : A \otimes A^* \rightarrow I$ (called the *counit*) such that the following are identities:

$$A \xrightarrow{\rho^{-1}} A \otimes I \xrightarrow{1 \otimes \eta} A \otimes (A^* \otimes A) \xrightarrow{\alpha} (A \otimes A^*) \otimes A \xrightarrow{\varepsilon \otimes 1} I \otimes A \xrightarrow{\lambda} A = 1_A,$$

$$A^* \xrightarrow{\lambda^{-1}} I \otimes A^* \xrightarrow{\eta \otimes 1} (A^* \otimes A) \otimes A^* \xrightarrow{\alpha^{-1}} A^* \otimes (A \otimes A^*) \xrightarrow{1 \otimes \varepsilon} A^* \otimes I \xrightarrow{\rho} A^* = 1_{A^*}.$$

Naturality:

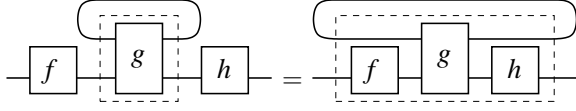

Vanishing I:

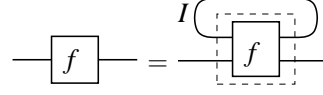

Dinaturality:

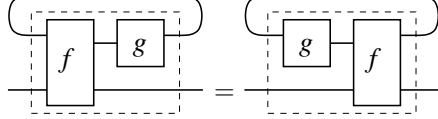

Vanishing II:

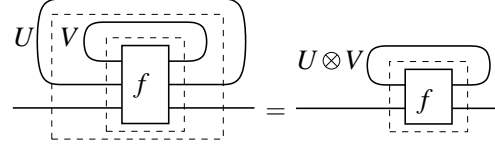

Strength:

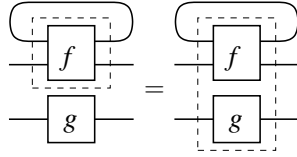

Yanking:

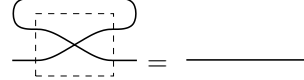

Table 2: The axioms of traced monoidal categories

Proposition 2.8. *Let \mathcal{C} be a compact closed category. Then \mathcal{C} has a unique trace, which we call the canonical trace. It is defined as follows (here we write without loss of generality as if the category were strict):*

$$\mathrm{Tr}_{A,B}^U(f) = A \xrightarrow{1 \otimes \eta} A \otimes U^* \otimes U \xrightarrow{1 \otimes \sigma} A \otimes U \otimes U^* \xrightarrow{f \otimes 1} B \otimes U \otimes U^* \xrightarrow{1 \otimes \varepsilon} B.$$

Moreover, every strong symmetric monoidal functor between compact closed categories preserves the compact closed structure, and therefore the canonical trace.

Proof. See [15]. For uniqueness of the trace, see [12, Appendix B]. □

3 Partially traced categories

Partially traced symmetric monoidal categories were introduced by Haghverdi and Scott [10] as part of a categorical framework for a typed version of the Geometry of Interaction (GoI).

An important aspect of modelling the dynamics of proofs in Girard’s concrete models of GoI is that proofs are interpreted as operators, and cut-elimination (normalization) is interpreted in terms of feedback (the “execution formula”). Haghverdi and Scott [10] used a partial trace to define a categorical version of the execution formula. This execution formula is (for large classes of sequents) an invariant of the cut-elimination process. Types are given by an abstract orthogonality relation in the sense of Hyland and Schalk [14]. Such an orthogonality relation arises naturally in the partially traced setting, and yields the required convergence properties of Girard’s execution formula. Thus, partially traced categories (with additional structure) provide the necessary ingredients for running Girard’s GoI machinery.

We note that, while totally traced categories are a special case of partially traced categories, partiality was important in constructing nontrivial types in the typed version of GoI in [10]. Indeed, if one assumes a total trace in this setting, the type structure collapses. By contrast, the earlier analysis of GoI in [9] used a *total* categorical trace, but required the category to be equipped with a reflexive object satisfying appropriate domain equations, which is a very strong assumption.

In this section, we recall the definition of a partially traced category, and give some examples. We also show that each symmetric monoidal subcategory of a (totally or partially) traced category is partially traced, which gives rise to many more examples.

3.1 Definition of partially traced categories

We recall the definition of a partially traced (symmetric monoidal) category from [10]. We begin with some notation for partial functions.

Definition 3.1. Let f and g be partially defined operations. We write $f(x)\downarrow$ if $f(x)$ is defined, and $f(x)\uparrow$ if it is undefined. Following Freyd and Scedrov [3], we also write $f(x) \asymp g(x)$ if $f(x)$ and $g(x)$ are either both undefined, or else they are both defined and equal. The relation “ \asymp ” is known as *Kleene equality*. We also write $f(x) \rhd g(x)$ if either $f(x)$ is undefined, or else $f(x)$ and $g(x)$ are both defined and equal. The relation “ \rhd ” is known as *directed Kleene equality*.

Definition 3.2 ([10, 11]). Suppose $(\mathcal{C}, \otimes, I, \rho, \lambda, \sigma)$ is a symmetric monoidal category. A *partial trace* is given by a family of partial functions $\text{Tr}_{A,B}^U : \mathcal{C}(A \otimes U, B \otimes U) \rightarrow \mathcal{C}(A, B)$, satisfying the following axioms. Once again, we write the axioms as if \mathcal{C} were strict.

- **Naturality:** For all $f : A \otimes U \rightarrow B \otimes U$, $g : A' \rightarrow A$, and $h : B \rightarrow B'$,

$$h \circ \text{Tr}_{A,B}^U(f) \circ g \rhd \text{Tr}_{A',B'}^U((h \otimes 1_U) \circ f \circ (g \otimes 1_U)).$$

- **Dinaturality:** For all $f : A \otimes U \rightarrow B \otimes U'$ and $g : U' \rightarrow U$,

$$\text{Tr}_{A,B}^U((1_B \otimes g) \circ f) \asymp \text{Tr}_{A,B}^{U'}(f \circ (1_A \otimes g)).$$

- **Strength:** For all $f : A \otimes U \rightarrow B \otimes U$ and $g : C \rightarrow D$,

$$g \otimes \text{Tr}_{A,B}^U(f) \rhd \text{Tr}_{C \otimes A, D \otimes B}^U(g \otimes f).$$

- **Vanishing I:** For all $f : A \otimes I \rightarrow B \otimes I$,

$$f \asymp \text{Tr}_{A,B}^I(f).$$

- **Vanishing II:** For all $f : A \otimes U \otimes V \rightarrow B \otimes U \otimes V$,

$$\text{Tr}_{A \otimes U, B \otimes U}^V(f)\downarrow \text{ implies } \text{Tr}_{A,B}^U(\text{Tr}_{A \otimes U, B \otimes U}^V(f)) \asymp \text{Tr}_{A,B}^{U \otimes V}(f).$$

- **Yanking:** For all A ,

$$\text{Tr}_{A,A}^A(\sigma_{A,A}) \asymp 1_A.$$

A *partially traced category* is a symmetric monoidal category with a partial trace.

Note that in the vanishing I axiom, the left-hand side is always defined, so Kleene equality in this case just means that $\text{Tr}_{A,B}^I(f)$ is always defined and equals f . A similar remark applies to the yanking axiom.

Remark 3.3. Comparing this to Definition 2.4, we see that a traced monoidal category is just a partially traced category where the trace operation happens to be total. We sometimes refer to traced monoidal categories as *totally traced categories*, when we want to emphasize that they are not partial.

Definition 3.4. The subset of $\mathcal{C}(A \otimes U, B \otimes U)$ where $\text{Tr}_{A,B}^U$ is defined is sometimes called the *trace class*, and is written

$$\mathbb{T}_{A,B}^U = \{f : A \otimes U \rightarrow B \otimes U \mid \text{Tr}_{A,B}^U(f)\downarrow\}.$$

Remark 3.5. In case g and h are isomorphisms, by naturality we have

$$h^{-1} \circ \text{Tr}_{A,B}^U(f') \circ g^{-1} \doteq \text{Tr}_{A',B'}^U((h^{-1} \otimes 1_U) \circ f' \circ (g^{-1} \otimes 1_U)),$$

and therefore

$$\text{Tr}_{A',B'}^U((h \otimes 1_U) \circ f \circ (g \otimes 1_U)) \doteq h \circ \text{Tr}_{A,B}^U(f) \circ g,$$

where $f' = (h \otimes 1_U) \circ f \circ (g \otimes 1_U)$. Therefore, the naturality axiom holds with Kleene equality when g and h are isomorphisms.

Remark 3.6. The precondition to the vanishing II axiom is redundant for the left-to-right direction. In other words, we have the directed Kleene equality

$$\text{Tr}_{A,B}^U(\text{Tr}_{A \otimes U, B \otimes U}^V(f)) \doteq \text{Tr}_{A,B}^{U \otimes V}(f)$$

regardless of whether $\text{Tr}_{A \otimes U, B \otimes U}^V(f)$ is defined or not. However, the assumption $\text{Tr}_{A \otimes U, B \otimes U}^V(f) \downarrow$ is of course critical for the right-to-left direction.

Lemma 3.7. *The strength axiom in the context of Definition 3.2 is equivalent to the following axiom (see also [15]):*

- **Superposing:** For all $f : A \otimes U \rightarrow B \otimes U$ and $g : C \rightarrow D$,

$$\text{Tr}_{A,B}^U(f) \otimes g \doteq \text{Tr}_{A \otimes C, B \otimes D}^U((1_B \otimes \sigma_{U,D}) \circ (f \otimes g) \circ (1_A \otimes \sigma_{C,U})).$$

Proof. By the axioms of symmetric monoidal categories, we have $(1_B \otimes \sigma_{U,D}) \circ (f \otimes g) \circ (1_A \otimes \sigma_{C,U}) = (\sigma \otimes 1_U) \circ (g \otimes f) \circ (\sigma \otimes 1_U)$. From this and Remark 3.5, it follows that the right-hand sides of the superposing and strength axioms are related by conjugation with σ :

$$\begin{aligned} \text{Tr}_{A \otimes C, B \otimes D}^U((1_B \otimes \sigma_{U,D}) \circ (f \otimes g) \circ (1_A \otimes \sigma_{C,U})) &\doteq \text{Tr}_{A \otimes C, B \otimes D}^U((\sigma \otimes 1_U) \circ (g \otimes f) \circ (\sigma \otimes 1_U)) \\ &\doteq \sigma \circ \text{Tr}_{C \otimes A, D \otimes B}^U(g \otimes f) \circ \sigma. \end{aligned}$$

On the other hand, the left-hand sides of the superposing and strength axioms are also related by conjugation with σ :

$$\text{Tr}_{A,B}^U(f) \otimes g \doteq \sigma \circ (g \otimes \text{Tr}_{A,B}^U(f)) \circ \sigma.$$

The claim then follows. □

3.2 Graphical language

Because a morphism such as

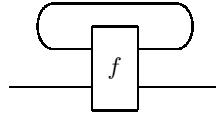

may be undefined in a partially traced category, we may not a priori assume that the graphical language of Section 2.3 is sound for partially traced categories, or even that every diagram describes a unique morphism. For example, both sides of the naturality axiom correspond, up to isomorphism of diagrams, to the same diagram

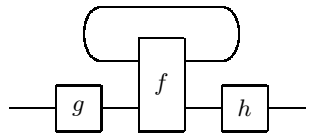

However, one side of the axiom may be undefined and the other defined, so the diagram does not have a unique meaning.

Nevertheless, we wish to use graphical reasoning to simplify our exposition, particularly in Section 5. The following standard trick will allow us to do this. Whenever we take the trace of a composite diagram, we will draw a special box around the portion of the diagram that is being traced, like this:

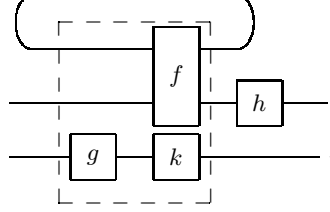

Note that, since every partially traced category is a symmetric monoidal (total) category, the graphical language of symmetric monoidal categories is still *sound* for partially traced categories, and therefore any symmetric monoidal portion of a graphical diagram can be soundly manipulated up to graph isomorphism. This means that one can soundly manipulate the inside of a box, as well as the box as a whole, up to graph isomorphism. With this convention, any diagram (up to box-respecting graph isomorphism) has a unique meaning (up to Kleene equality) in a partially traced category.

3.3 Examples: partial traces on (\mathbf{Vect}, \oplus)

It is well-known that the category \mathbf{Vect}_{fin} of finite dimensional vector spaces (over any field k), with the symmetric monoidal structure given by the tensor product \otimes , is totally traced. In fact, this category is compact closed.

On the other hand, with respect to the monoidal structure given by the biproduct \oplus , neither \mathbf{Vect} nor \mathbf{Vect}_{fin} is totally traced. However, it is possible to define a partial trace on these categories. In fact, this can be done in more than one way, as we will now discuss.

Recall that in a category with biproducts, a morphism $f : A \oplus U \rightarrow B \oplus U$ is characterized by the matrix $\begin{bmatrix} f_{11} & f_{12} \\ f_{21} & f_{22} \end{bmatrix}$, where $f_{ij} = \pi_i \circ f \circ \text{in}_j$. Composition corresponds to multiplication of matrices. Also recall that an *additive category* is a category with finite biproducts and where each morphism $f : A \rightarrow B$ has an additive inverse $g : A \rightarrow B$ such that $f + g = 0$.

3.3.1 Non-examples: Kleene trace and sum trace

A first attempt to define a partial trace with respect to biproducts on vector spaces is by summing over all paths in the graph

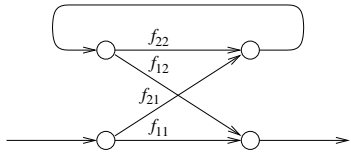

We consider two variants:

Definition 3.8 (Kleene trace [20]). The *Kleene trace* is the following partial operation on (\mathbf{Vect}, \oplus) . For $f : A \oplus U \rightarrow B \oplus U$, define

$$\text{Tr}_k^U(f) = f_{11} + f_{12} \left(\sum_{n \geq 0} f_{22}^n \right) f_{21}, \quad (3.1)$$

if this sum exists, and $\text{Tr}_k^U(f)$ is undefined otherwise.

To give the summation an unambiguous meaning, let us assume here that the vector spaces are over the real or complex numbers, and that convergence is taken with respect to some convenient topology, such as the weak operator topology, where $X_n \rightarrow X$ iff for all $v \in A$ and $w \in B^*$, $wX_nv \rightarrow wXv$. We also consider:

Definition 3.9 (Sum trace). On (\mathbf{Vect}, \oplus) , for $f : A \oplus U \rightarrow B \oplus U$, define the *sum trace*

$$\mathrm{Tr}_s^U(f) = f_{11} + \sum_{n \geq 0} (f_{12} f_{22}^n f_{21}), \quad (3.2)$$

if this sum exists, and $\mathrm{Tr}_s^U(f)$ is undefined otherwise.

Proposition 3.10. *Neither (3.1) nor (3.2) is a partial trace in the sense of Definition 3.2. Both operations satisfy naturality, dinaturality, strength, vanishing I, and yanking. However, both fail to satisfy vanishing II.*

Proof. Naturality, dinaturality, strength, vanishing I, and yanking are straightforward to check. To show that the sum trace does not satisfy vanishing II, consider $A = B = U = V = k$ and $f : A \oplus U \oplus V \rightarrow B \oplus U \oplus V$ given by

$$\begin{bmatrix} 1 & 1 & 0 \\ 1 & -2 & 1 \\ 0 & 1 & 1/2 \end{bmatrix}.$$

Then

$$\mathrm{Tr}_s^V f = \begin{bmatrix} 1 & 1 \\ 1 & -2 \end{bmatrix} + \sum_{n \geq 0} \begin{bmatrix} 0 \\ 1 \end{bmatrix} \left(\frac{1}{2}\right)^n \begin{bmatrix} 1 & 1 \end{bmatrix} = \begin{bmatrix} 1 & 1 \\ 1 & 0 \end{bmatrix}.$$

In particular, this sum exists, so the hypothesis of vanishing II is satisfied. Now $\mathrm{Tr}_s^U \mathrm{Tr}_s^V f$ exists and is equal to

$$\mathrm{Tr}_s^U \mathrm{Tr}_s^V f = 1 + \sum_{m \geq 0} 1 \cdot 0^m \cdot 1 = 2.$$

On the other hand,

$$\mathrm{Tr}_s^{U \oplus V} f = 1 + \sum_{n \geq 0} \begin{bmatrix} 1 & 0 \end{bmatrix} \begin{bmatrix} -2 & 1 \\ 1 & 1/2 \end{bmatrix}^n \begin{bmatrix} 1 \\ 0 \end{bmatrix},$$

which does not converge, contradicting the vanishing II axiom. The same counterexample also applies to the Kleene trace. \square

3.3.2 Haghverdi and Scott's partial trace on (\mathbf{Vect}, \oplus)

One of the motivating examples of a partially traced category in [10, 8, 11] is the following partial trace on (\mathbf{Vect}, \oplus) . It can be seen as an effort to make the Kleene trace (3.1) more often defined by replacing the sum $\sum_{n \geq 0} f_{22}^n$ by its limit $(I - f_{22})^{-1}$. The following definition makes sense in finite or infinite dimensions and over any base field, or indeed in any additive category.

Definition 3.11 (Haghverdi-Scott trace [10]). On $(\mathbf{Vect}, \oplus, \mathbf{0})$, or on any additive category, we define a partial trace as follows: for $f : A \oplus U \rightarrow B \oplus U$, let

$$\mathrm{Tr}_{\mathrm{hs}}^U(f) = f_{11} + f_{12}(I - f_{22})^{-1}f_{21}, \quad (3.3)$$

if $I - f_{22}$ is invertible, and $\mathrm{Tr}_{\mathrm{hs}}^U(f)$ is undefined otherwise. Here, $I = 1 : U \rightarrow U$ is the identity map on U .

Proposition 3.12. *The Haghverdi-Scott trace is a partial trace.*

Proof. [10, 8, 11]. \square

Remark 3.13. Both the sum trace and the Haghverdi-Scott trace are strictly more defined than the Kleene trace, in the sense that for all f , $\mathrm{Tr}_k^U(f) \preceq \mathrm{Tr}_s^U(f)$ and $\mathrm{Tr}_k^U(f) \preceq \mathrm{Tr}_{\mathrm{hs}}^U(f)$. Moreover, it appears that when the sum trace and the Haghverdi-Scott trace are both defined, then they coincide¹. However, the sum trace and the Haghverdi-Scott trace can each be defined without the other being defined. For example, for $f = \begin{bmatrix} 1 & 0 \\ 0 & 1 \end{bmatrix}$, the sum trace is defined but the Haghverdi-Scott trace is not, whereas for $f = \begin{bmatrix} 1 & 1 \\ 1 & 2 \end{bmatrix}$, the Haghverdi-Scott trace is defined and the sum trace is not. In fact, as the following proposition shows, there is no partial trace (and hence definitely no total trace) on $(\mathbf{Vect}, \oplus, \mathbf{0})$ that simultaneously generalizes the sum trace and the Haghverdi-Scott trace.

¹We know this for certain only in the finite dimensional case.

Proposition 3.14. *There exists no partial trace Tr on (\mathbf{Vect}, \oplus) , such that for all $f : A \oplus U \rightarrow B \oplus U$,*

$$\text{Tr}_s^U(f) \stackrel{!}{=} \text{Tr}^U(f) \quad \text{and} \quad \text{Tr}_{\text{hs}}^U(f) \stackrel{!}{=} \text{Tr}^U(f).$$

Proof. Suppose there is such a partial trace Tr . Let $A = B = U = k$, $X = \begin{bmatrix} 0 & 1 \\ 1 & 0 \end{bmatrix}$ and consider $f, g : A \oplus U \oplus U \rightarrow B \oplus U \oplus U$ given by

$$f = \begin{bmatrix} 0 & 1 & 1 \\ 0 & 2 & 1 \\ 1 & -1 & 0 \end{bmatrix} \quad \text{and} \quad g = (1 \oplus X)f(1 \oplus X^{-1}) = \begin{bmatrix} 0 & 1 & 1 \\ 1 & 0 & -1 \\ 0 & 1 & 2 \end{bmatrix}.$$

By direct calculation, one can verify that both $\text{Tr}_s^U \text{Tr}_{\text{hs}}^U(f)$ and $\text{Tr}_s^U \text{Tr}_{\text{hs}}^U(g)$ are defined and

$$\text{Tr}_s^U \text{Tr}_{\text{hs}}^U(f) = 1 \quad \text{and} \quad \text{Tr}_s^U \text{Tr}_{\text{hs}}^U(g) = 0.$$

By assumption,

$$\text{Tr}^U \text{Tr}^U(f) = 1 \quad \text{and} \quad \text{Tr}^U \text{Tr}^U(g) = 0,$$

hence by vanishing II,

$$\text{Tr}^{U \oplus U}(f) = 1 \quad \text{and} \quad \text{Tr}^{U \oplus U}(g) = 0.$$

On the other hand, dinaturality requires $\text{Tr}^{U \oplus U}(f) \stackrel{!}{=} \text{Tr}^{U \oplus U}(g)$, a contradiction. □

3.3.3 The kernel-image partial trace on (\mathbf{Vect}, \oplus)

The following definition generalizes the Haghverdi-Scott partial trace, and is defined on slightly more morphisms.

Definition 3.15 (Kernel-image trace). We define another partial trace on (\mathbf{Vect}, \oplus) , or indeed on any additive category, called the *kernel-image trace*. Given a map $f : A \oplus U \rightarrow B \oplus U$, we say $\text{Tr}_{\text{ki}}^U(f) \downarrow$ iff there exist morphisms $i : A \rightarrow U$ and $k : U \rightarrow B$ such that the following commutes:

$$\begin{array}{ccc} A & \xrightarrow{i} & U \\ & \searrow f_{21} & \downarrow I - f_{22} \\ & & U \\ & & \searrow f_{12} \\ & & B \\ & & \xleftarrow{k} \end{array}$$

Whenever this condition is satisfied we define

$$\text{Tr}_{\text{ki}}^U(f) = f_{11} + k \circ f_{21} = f_{11} + f_{12} \circ i : A \rightarrow B. \quad (3.4)$$

To show that this is well-defined, note that $k \circ f_{21}$ does not depend on i and $f_{12} \circ i$ does not depend on k , so $\text{Tr}_{\text{ki}}^U(f)$ is independent of the choice of both i and k .

Remark 3.16. In \mathbf{Vect} , the existence of i and k is equivalent to the following two conditions, respectively:

$$\begin{aligned} \text{im } f_{21} &\subseteq \text{im}(I - f_{22}), \\ \ker(I - f_{22}) &\subseteq \ker f_{12}. \end{aligned}$$

This explains the name “kernel-image trace”.

Proposition 3.17. *The kernel-image trace is a partial trace.*

Proof. The proof for \mathbf{Vect} can be found in [18]. Here, we prove it in the case of a general additive category. Let us say that (k, i) witnesses the existence of $\text{Tr}(f)$ if the condition of Definition 3.15 holds, i.e., $f_{12} = k \circ (I - f_{22})$ and $f_{21} = (I - f_{22}) \circ i$. In this case, we also write $(k, i) \Vdash \text{Tr}(f)$.

- To prove naturality, assume $(k, i) \Vdash \text{Tr}(f)$. Then $(h \circ k, i \circ g) \Vdash \text{Tr}((h \oplus 1_U) \circ f \circ (g \oplus 1_U))$, and $\text{Tr}((h \oplus 1_U) \circ f \circ (g \oplus 1_U)) = h \circ f_{11} \circ g + h \circ k \circ f_{21} \circ g = h \circ \text{Tr}(f) \circ g$.

$$\begin{array}{ccccccc}
 A' & \xrightarrow{g} & A & \dashrightarrow^i & U & & \\
 & & \searrow^{f_{21}} & & \downarrow^{I-f_{22}} & \searrow^{f_{12}} & \\
 & & & & U & \dashrightarrow^k & B \xrightarrow{h} B'
 \end{array}$$

- To prove dinaturality, assume $(k, i) \Vdash \text{Tr}((1_B \oplus g) \circ f)$:

$$\begin{array}{ccccccc}
 A & \dashrightarrow^i & U & & & & \\
 & \searrow^{f_{21}} & & & \downarrow^{I-g \circ f_{22}} & \searrow^{f_{12}} & \\
 & & U' & \xrightarrow{g} & U & \dashrightarrow^k & B
 \end{array}$$

Let $j = f_{21} + f_{22} \circ i$ and note that $(I - g \circ f_{22}) \circ i = g \circ f_{21}$ implies $i - g \circ f_{22} \circ i = g \circ f_{21}$, hence $i = g \circ (f_{21} + f_{22} \circ i) = g \circ j$. Consider the diagram

$$\begin{array}{ccccccc}
 A & \dashrightarrow^j & U' & \xrightarrow{g} & U & & \\
 & \searrow^{f_{21}} & \downarrow^{I-f_{22} \circ g} & & \downarrow^{I-g \circ f_{22}} & \searrow^{f_{12}} & \\
 & & U' & \xrightarrow{g} & U & \dashrightarrow^k & B
 \end{array}$$

The left triangle commutes because $(I - f_{22} \circ g) \circ j = j - f_{22} \circ g \circ j = j - f_{22} \circ i = f_{21}$. The center square commutes because both sides are equal to $g - g \circ f_{22} \circ g$. Therefore $(k \circ g, j) \Vdash \text{Tr}(f \circ (1_A \oplus g))$ and $\text{Tr}(f \circ (1_A \oplus g)) = f_{11} + k \circ g \circ f_{21} = \text{Tr}((1_B \oplus g) \circ f)$. This proves one direction of dinaturality; the opposite direction is dual.

- To prove strength, assume $(k, i) \Vdash \text{Tr}(f)$. Then $(\text{in}_2 \circ k, i \circ \pi_2) \Vdash \text{Tr}(g \oplus f)$ and $\text{Tr}(g \oplus f) = (g \oplus f_{11}) + \text{in}_2 \circ k \circ f_{21} \circ \pi_2 = g \oplus \text{Tr}(f)$.

$$\begin{array}{ccccccc}
 C \oplus A & \xrightarrow{\pi_2} & A & \dashrightarrow^i & U & & \\
 & & \searrow^{f_{21}} & & \downarrow^{I-f_{22}} & \searrow^{f_{12}} & \\
 & & & & U & \dashrightarrow^k & B \xrightarrow{\text{in}_2} B \oplus D
 \end{array}$$

- To prove yanking, notice that $(1, 1) \Vdash \text{Tr}(\sigma_U)$, and $\text{Tr}(\sigma_U) = 0 + 1 = 1$.

$$\begin{array}{ccccccc}
 U & \dashrightarrow^1 & U & & & & \\
 & \searrow^1 & \downarrow^{I-0} & & \searrow^1 & & \\
 & & U & \dashrightarrow^1 & U
 \end{array}$$

- To prove vanishing I, consider $f : A \oplus 0 \rightarrow B \oplus 0$. Then $(0, 0) \Vdash \text{Tr}(f)$ and, writing as if the monoidal structure were strict, we have $\text{Tr}(f) = f_{11} + 0 = f$.

$$\begin{array}{ccccccc}
 A & \dashrightarrow^0 & U & & & & \\
 & \searrow^0 & \downarrow^{I-0} & & \searrow^0 & & \\
 & & U & \dashrightarrow^0 & B
 \end{array}$$

- Finally, to prove vanishing II, consider

$$f = \begin{bmatrix} L & M & N \\ P & A & B \\ Q & C & D \end{bmatrix} : A \oplus U \oplus V \rightarrow B \oplus U \oplus V.$$

Assume $\text{Tr}^V(f)$ is defined and witnessed by some (k, i) . We write $i = [E \ F]$ and $k = \begin{bmatrix} G \\ H \end{bmatrix}$.

$$\begin{array}{ccc} A \oplus U & \xrightarrow{[E \ F]} & V \\ & \searrow [Q \ C] & \downarrow I-D \\ & & V \xrightarrow{[G \ H]} B \oplus U. \end{array}$$

For greater brevity, let us write $D' = I - D$ and $A' = I - A$. We have $HD' = B$, $GD' = N$, $D'F = C$, and $D'E = Q$. Also,

$$\text{Tr}^V(f) = \begin{bmatrix} L + GQ & M + GC \\ P + HQ & A + HC \end{bmatrix} = \begin{bmatrix} L + NE & M + NF \\ P + BE & A + BF \end{bmatrix}.$$

What we must show is that some (k', i') witnesses $\text{Tr}^U \text{Tr}^V(f)$ if and only if some (k'', i'') witnesses $\text{Tr}^{U \oplus V}(f)$, and in this case, $\text{Tr}^U \text{Tr}^V(f) = \text{Tr}^{U \oplus V}(f)$. Let us write $k'' = [R \ S]$ and $i'' = \begin{bmatrix} J \\ K \end{bmatrix}$, and consider the corresponding diagrams

$$\begin{array}{ccc} A & \xrightarrow{i'} & U \\ & \searrow P+BE & \downarrow I-A-BF \\ & & U \xrightarrow{k'} B, \end{array} \quad \begin{array}{ccc} A & \xrightarrow{[J \ K]} & U \oplus V \\ & \searrow [P \ Q] & \downarrow I - \begin{bmatrix} A & B \\ C & D \end{bmatrix} \\ & & U \oplus V \xrightarrow{[R \ S]} B. \end{array}$$

We note that (a) commutes iff $P + BE = A'i' - BFi'$ iff $P = A'i' - B(E + Fi')$, and (c) commutes iff $P = A'J - BK$ and $Q = D'K - CJ$. Now given i' such that (a) commutes, we can set $J = i'$ and $K = E + Fi'$. Then $P = A'i' - B(E + Fi') = A'J - BK$, and $Q = D'E = D'(K - Fi') = D'K - D'FJ = D'K - CJ$, and therefore (c) commutes. Conversely, given J and K such that (c) commutes, we can set $i' = J$, and we have: $P = A'J - BK = A'i' - HD'K = A'i' - H(Q + CJ) = A'i' - HD'E - HD'FJ = A'i' - HD'(E + Fi') = A'i' - B(E + Fi')$, and therefore (a) commutes. The proof for (b) and (d) is dual. Finally, if both diagrams are witnessed, with $J = i'$ and $K = E + Fi'$, then we have $\text{Tr}^U \text{Tr}^V(f) = L + NE + MJ + NFJ$ and $\text{Tr}^{U \oplus V}(f) = L + MJ + NK$; the two are equal because $NE + NFJ = N(E + Fi') = NK$. □

Remark 3.18. Notice that the kernel-image partial trace generalizes the Haghverdi-Scott trace. Indeed, if $I - f_{22}$ is invertible, then one can take $i = (I - f_{22})^{-1} \circ f_{21}$ and $k = f_{12} \circ (I - f_{22})^{-1}$, in which case $\text{Tr}_{\text{ki}}^U(f) = f_{11} + f_{12}(I - f_{22})^{-1}f_{21}$. Therefore $\text{Tr}_{\text{hs}}^U(f) = \text{Tr}_{\text{ki}}^U(f)$. Moreover, the kernel-image trace is strictly more general, because for the identity map $f = \begin{bmatrix} 1 & 0 \\ 0 & 1 \end{bmatrix}$, the kernel-image trace is defined but the Haghverdi-Scott trace is not. However, although the kernel-image trace is more defined than the Haghverdi-Scott trace, because of Proposition 3.14, it still does not subsume the sum trace. For example, for $f = \begin{bmatrix} 0 & 1 \\ 0 & 1 \end{bmatrix}$, the sum trace is defined and the kernel-image trace is not.

Remark 3.19. Let $U = V \oplus W$ be a finite dimensional Hilbert space and consider a hermitian positive operator $A : U \rightarrow U$. Then A is characterized by its unit ball $\mathcal{B} = \{u \in U \mid \langle u, Au \rangle \leq 1\}$. Let $\mathcal{B}' \subseteq V$ be

the orthogonal projection of \mathcal{B} to the subspace V . Then \mathcal{B}' is the unit ball of a hermitian positive operator $A' : V \rightarrow V$, which can be explicitly defined by $\langle v, A'v \rangle := \min\{\langle v+w, A(v+w) \rangle \mid w \in W\}$. This construction is intimately related to the kernel-image trace in the following way: If A is positive, then $\text{Tr}_{\text{ki}}^W(I - A)$ always exists and is equal to $I - A'$. Such a property fails to hold for the sum-trace (e.g., $A = \begin{bmatrix} 1 & 1 \\ 1 & 2 \end{bmatrix}$) and the Haghverdi-Scott trace (e.g., $A = \begin{bmatrix} 1 & 0 \\ 0 & 0 \end{bmatrix}$).

3.4 Partial trace in a symmetric monoidal subcategory of a partially traced category

The aim of this section is to show that any symmetric monoidal subcategory of a partially (or totally) traced category is partially traced. Suppose $(\mathcal{D}, \otimes, I, \sigma, \text{Tr})$ is a partially traced category with trace

$$\text{Tr}_{A,B}^U : \mathcal{D}(A \otimes U, B \otimes U) \rightarrow \mathcal{D}(A, B).$$

Given a symmetric monoidal subcategory $\mathcal{C} \subseteq \mathcal{D}$, we get a partial trace on \mathcal{C} , defined by $\widehat{\text{Tr}}_{A,B}^U(f) = \text{Tr}_{A,B}^U(f)$ if $\text{Tr}_{A,B}^U(f)$ exists and is an element of $\mathcal{C}(A, B)$, and undefined otherwise.

Slightly more generally, we have the following:

Proposition 3.20. *Let $F : \mathcal{C} \rightarrow \mathcal{D}$ be a faithful strong symmetric monoidal functor from a symmetric monoidal category $(\mathcal{C}, \otimes, I, \sigma)$ to a partially traced category $(\mathcal{D}, \otimes, I, \sigma, \text{Tr})$. Then we obtain a partial trace $\widehat{\text{Tr}}$ on \mathcal{C} as follows. For $f : A \otimes U \rightarrow B \otimes U$, we define $\widehat{\text{Tr}}_{A,B}^U(f) = g$ if there exists some (necessarily unique) $g : A \rightarrow B$ such that $F(g) = \text{Tr}_{FA,FB}^{FU}(m_{B,U}^{-1} \circ F(f) \circ m_{A,U})$ is defined, and $\widehat{\text{Tr}}_{A,B}^U(f)$ undefined otherwise.*

Proof. The details can be found in [18]. □

Remark 3.21. This yields a large class of examples of partially traced categories that are related to known totally traced categories. For example, consider the category $\mathbf{SRel}_{\text{fin}}$ of finite sets and stochastic maps. Here, a stochastic map from A to B is a function from A to sub-probability distributions on B , with the obvious identities and composition. In elementary terms, this is a $[0, 1]$ -valued matrix whose columns have sum ≤ 1 . With the tensor \oplus (disjoint union), this category is totally traced. With the tensor \otimes (cartesian product), it is not totally traced; however, $(\mathbf{SRel}_{\text{fin}}, \otimes)$ can be regarded as a symmetric monoidal subcategory of the totally traced category $(\mathbf{Vect}_{\text{fin}}, \otimes)$ of finite dimensional real vector spaces and linear functions. Therefore it inherits a partial trace.

Other examples of partial traces arise in this way from the models for quantum computing considered in [21], for example on completely positive maps and on superoperators. Such examples are described in detail in [18].

4 Paracategories and their completion

The goal of the remainder of this paper is to prove a strong converse to Proposition 3.20, i.e.: every partially traced category arises as a symmetric monoidal subcategory of a totally traced category. More precisely, we show that every partially traced category can be faithfully embedded in a compact closed category in such a way that the trace is preserved and reflected.

Our construction uses a partial version of the Int-construction of Joyal, Street, and Verity [15]. When we try to apply the Int-construction to a partially traced category \mathcal{C} , we find that composition in $\text{Int}(\mathcal{C})$ is in general only partially defined. We therefore consider a notion of “categories” with partially defined composition, namely, Freyd’s paracategories [13]. Specifically, we introduce the notion of a strict symmetric compact closed paracategory.

We first show in Section 4 that every partially traced category can be fully and faithfully embedded in a compact closed paracategory, by an analogue of the Int-construction. We then show in Section 5 that every compact closed paracategory can be embedded (faithfully, but not necessarily fully) in a compact closed

(total) category, using a construction similar to that of Freyd. Finally, every compact closed category is (totally) traced, yielding the desired result in Section 6.

4.1 Paracategories

We recall Freyd's notion of paracategory. A reference on this subject is [13]. Informally, a paracategory is a category with partially defined composition.

Definition 4.1. A (*directed*) graph \mathcal{C} consists of:

- a class of *objects* $\text{obj}(\mathcal{C})$, and
- for every pair of objects A, B , a set $\mathcal{C}(A, B)$ of *arrows* from A to B .

If \mathcal{C}, \mathcal{D} are graphs, a *graph homomorphism* $F : \mathcal{C} \rightarrow \mathcal{D}$ is given by a (total) function $F : \text{obj}(\mathcal{C}) \rightarrow \text{obj}(\mathcal{D})$ and a family of (total) functions $F : \mathcal{C}(A, B) \rightarrow \mathcal{D}(FA, FB)$. We say that F is *faithful* if $F : \mathcal{C}(A, B) \rightarrow \mathcal{D}(FA, FB)$ is one-to-one for all A, B .

Definition 4.2. Let \mathcal{C} be a graph. We define $\mathcal{P}(\mathcal{C})$, the *path category* of \mathcal{C} , by $\text{obj}(\mathcal{P}(\mathcal{C})) = \text{obj}(\mathcal{C})$ and arrows from A_0 to A_n are finite sequences $(A_0, f_1, A_1, f_2, \dots, f_n, A_n)$ of alternating objects and arrows of the graph \mathcal{C} , where $n \geq 0$ and $f_i : A_{i-1} \rightarrow A_i$ for all i . We say that n is the *length* of the path. To be clear, equality of arrows is literal equality of sequences. Composition is defined by concatenation, and the identity arrow at an object A is the path (A) of length zero.

Notation. For the sake of simplicity, we often write $\vec{f} = f_1, f_2, \dots, f_n$ for a path, when the objects are understood. We use the comma “,” for concatenation. We also write $\epsilon_A = (A)$ for the path of length zero at A , so that $\epsilon_A, \vec{f} = \vec{f} = \vec{f}, \epsilon_B$ for a path $\vec{f} : A \rightarrow B$.

Recall the definition of Kleene equality “ \asymp ” and directed Kleene equality “ \rhd ” from Definition 3.1.

Definition 4.3. A *paracategory* $(\mathcal{C}, [-])$ consists of a directed graph \mathcal{C} and a family of partial operations $[-]_{A,B} : \mathcal{P}(\mathcal{C})(A, B) \rightarrow \mathcal{C}(A, B)$, called (*partial*) *composition*, which satisfies the following axioms. We usually omit the subscripts.

- for all A , $[\epsilon_A] \downarrow$, i.e., $[-]$ is a total operation on empty paths;
- for paths of length one, $[f] \downarrow$ and $[f] = f$ (or equivalently, using Kleene equality, $[f] \asymp f$);
- for all paths $\vec{r} : A \rightarrow B$, $\vec{f} : B \rightarrow C$, and $\vec{s} : C \rightarrow D$,

$$[\vec{f}] \downarrow \text{ implies } [\vec{r}, [\vec{f}], \vec{s}] \asymp [\vec{r}, \vec{f}, \vec{s}].$$

Remark 4.4. Every category \mathcal{C} can be regarded as a paracategory with $[f_1, \dots, f_n] = f_n \circ \dots \circ f_1$. In this case, composition is a totally defined operation.

Remark 4.5 (Identity). In any paracategory, we will write $1_A = [\epsilon_A]$. Note that by (a) and (c), it follows that $[\vec{r}, 1_A, \vec{s}] \asymp [\vec{r}, \vec{s}]$ for all \vec{r}, \vec{s} , so the arrow 1_A indeed behaves like an identity.

Remark 4.6 (Inverses). If there are two arrows $b : A \rightarrow B$ and $b^{-1} : B \rightarrow A$ in a paracategory such that $[b, b^{-1}] = 1_A$ and $[b^{-1}, b] = 1_B$, then for all arrows $f : X \rightarrow A$ and $g : X \rightarrow B$, $[f, b] = g$ iff $f = [g, b^{-1}]$. Namely, from the assumption $[f, b] = g$, we can deduce $[g, b^{-1}] \asymp [[f, b], b^{-1}] \asymp [f, b, b^{-1}] \asymp [f, [b, b^{-1}]] \asymp [f, 1] \asymp [f] = f$, and the proof of the converse is similar.

Convention 4.7. We extend any graph homomorphism $F : \mathcal{C} \rightarrow \mathcal{D}$ to paths by the following slight abuse of notation: for any path $\vec{f} = f_1, \dots, f_n$, we write

$$F\vec{f} := Ff_1, \dots, Ff_n.$$

Definition 4.8. Let $(\mathcal{C}, [-])$ and $(\mathcal{D}, [-]')$ be paracategories. A *functor* of paracategories is a graph homomorphism $F : \mathcal{C} \rightarrow \mathcal{D}$ such that for all \vec{p} ,

$$F[\vec{p}] \simeq [F\vec{p}]'.$$

We note that functors of paracategories preserve identities. Indeed, since $[\epsilon_A] \downarrow$, we have $F(1_A) = F[\epsilon_A] = [F\epsilon_A] = [\epsilon_{FA}] = 1_{FA}$.

Definition 4.9. Let $(\mathcal{C}, [-])$ and $(\mathcal{D}, [-]')$ be paracategories. Then the paracategory $\mathcal{C} \times \mathcal{D}$ has $\text{obj}(\mathcal{C} \times \mathcal{D}) := \text{obj}(\mathcal{C}) \times \text{obj}(\mathcal{D})$ and $(\mathcal{C} \times \mathcal{D})((A, A'), (B, B')) := \mathcal{C}(A, B) \times \mathcal{D}(A', B')$, and $[(f_1, g_1), \dots, (f_n, g_n)] \simeq ([f_1, \dots, f_n], [g_1, \dots, g_n])$. Then $\mathcal{C} \times \mathcal{D}$ is a categorical product in the category of paracategories and functors.

4.2 Symmetric monoidal paracategories

Definition 4.10. A *strict symmetric monoidal paracategory* $(\mathcal{C}, [-], \otimes, I, \sigma)$ consists of:

- (a) a paracategory $(\mathcal{C}, [-])$;
- (b) a functor of paracategories $\otimes : \mathcal{C} \times \mathcal{C} \rightarrow \mathcal{C}$, and an object I , satisfying
 - $(A \otimes B) \otimes C = A \otimes (B \otimes C)$ on objects and $(f \otimes g) \otimes h = f \otimes (g \otimes h)$ on arrows (associativity);
 - $A \otimes I = A = I \otimes A$ on objects and $f \otimes 1_I = f = 1_I \otimes f$ on arrows (unit laws);
- (c) for all objects A and B , an arrow $\sigma_{A,B} : A \otimes B \rightarrow B \otimes A$ such that:
 - for every $f : X \otimes B \otimes A \rightarrow Y$, $g : Y \rightarrow X \otimes A \otimes B$, $[1_X \otimes \sigma_{A,B}, f] \downarrow$ and $[g, 1_X \otimes \sigma_{A,B}] \downarrow$ (totality);
 - for every $f : A \rightarrow A'$ and $g : B \rightarrow B'$: $[f \otimes 1_B, \sigma] = [\sigma, 1_B \otimes f]$ and $[1_A \otimes g, \sigma] = [\sigma, g \otimes 1_A]$ (naturality);
 - for every A and B : $[\sigma_{A,B}, \sigma_{B,A}] = 1_{A \otimes B}$ (symmetry);
 - for every A, B , and C : $\sigma_{A, B \otimes C} = [\sigma_{A,B} \otimes 1_C, 1_B \otimes \sigma_{A,C}]$ (“hexagon” axiom).

The assumption that \otimes is a functor of paracategories explicitly means that it is a graph homomorphism satisfying

$$[f_1, \dots, f_n] \otimes [g_1, \dots, g_n] \simeq [f_1 \otimes g_1, \dots, f_n \otimes g_n]. \quad (4.1)$$

Lemma 4.11. For arrows $p : A \rightarrow B$, $q : C \rightarrow D$ of a strict symmetric monoidal paracategory \mathcal{C} , we have that $[p \otimes 1_C, 1_B \otimes q]$ and $[1_A \otimes q, p \otimes 1_D]$ are both defined and equal to $p \otimes q$. Moreover, for any paths \vec{f} and \vec{g} , we have $[\vec{f}, p \otimes 1, 1 \otimes q, \vec{g}] \simeq [\vec{f}, p \otimes q, \vec{g}] \simeq [\vec{f}, 1 \otimes q, p \otimes 1, \vec{g}]$.

Proof. Let $p : A \rightarrow B$ and $q : C \rightarrow D$. By Remark 4.5 and functoriality, $p \otimes q = [p, 1_B] \otimes [1_C, q] \simeq [p \otimes 1_C, 1_B \otimes q]$ and $p \otimes q = [1_A, p] \otimes [q, 1_D] \simeq [1_A \otimes q, p \otimes 1_D]$. But $p \otimes q$ is totally defined, so all of the above terms are defined and equal. Using this and axiom (c) of paracategories, we have for any paths \vec{f} and \vec{g} ,

$$[\vec{f}, p \otimes 1, 1 \otimes q, \vec{g}] \simeq [\vec{f}, [p \otimes 1, 1 \otimes q], \vec{g}] \simeq [\vec{f}, p \otimes q, \vec{g}],$$

and similarly for $[\vec{f}, 1 \otimes q, p \otimes 1, \vec{g}]$. □

Lemma 4.12. In the definition of a strict symmetric monoidal paracategory, condition (4.1) is equivalent to the following pair of conditions:

- (a) $[f, f'] \otimes [g, g'] \simeq [f \otimes g, f' \otimes g']$ where f, g, f', g' are arrows of \mathcal{C} ; and
- (b) $1 \otimes [\vec{p}] \simeq [1 \otimes \vec{p}]$ and $[\vec{p}] \otimes 1 \simeq [\vec{p} \otimes 1]$.

Note that in stating (b), we have used Convention 4.7, so by definition, $1 \otimes \vec{p} = 1 \otimes p_1, \dots, 1 \otimes p_n$.

Proof. Clearly (4.1) implies (a). Also, by Remark 4.5 and (4.1), we have $1 \otimes [\vec{p}] \asymp [1, \dots, 1] \otimes [\vec{p}] \asymp [1 \otimes \vec{p}]$, and similarly $[\vec{p}] \otimes 1 \asymp [\vec{p} \otimes 1]$, so (4.1) implies (b). For the converse, first note that the proof of Lemma 4.11 only uses property (a). Assume $[\vec{f}]$ and $[\vec{g}]$ are defined. Then by Lemma 4.11 and (b), we have $[\vec{f}] \otimes [\vec{g}] = [[\vec{f}] \otimes 1, 1 \otimes [\vec{g}]] \asymp [\vec{f} \otimes 1, 1 \otimes \vec{g}] \asymp \dots \asymp [f_1 \otimes 1, 1 \otimes g_1, \dots, f_n \otimes 1, 1 \otimes g_n] \asymp [f_1 \otimes g_1, \dots, f_n \otimes g_n]$. \square

Definition 4.13. Let $(\mathcal{C}, [-], \otimes, I, \sigma)$ and $(\mathcal{D}, [-]', \otimes', I', \sigma')$ be strict symmetric monoidal paracategories. A functor between them is *strict symmetric monoidal* when $F(A) \otimes' F(B) = F(A \otimes B)$ and $F(I) = I'$ on objects, and $F(f) \otimes' F(g) = F(f \otimes g)$ and $F(\sigma) = \sigma'$ on arrows.

4.3 The completion of symmetric monoidal paracategories

In this section, we will prove that every strict symmetric monoidal paracategory can be faithfully embedded in a strict symmetric monoidal category. From now on, \mathcal{C} denotes a strict symmetric monoidal paracategory.

Definition 4.14. A *congruence relation* \mathcal{S} on $\mathcal{P}(\mathcal{C})$ is given as follows: for every pair of objects A, B , an equivalence relation $\sim_{\mathcal{S}}^{A,B}$ on the hom-set $\mathcal{P}(\mathcal{C})(A, B)$, satisfying the following axioms. We usually omit the superscripts when they are clear from the context.

- (1) If $\vec{p} \sim_{\mathcal{S}} \vec{p}'$ and $\vec{q} \sim_{\mathcal{S}} \vec{q}'$, then $\vec{p}, \vec{q} \sim_{\mathcal{S}} \vec{p}', \vec{q}'$.
- (2) Whenever $[\vec{p}] \downarrow$, then $\vec{p} \sim_{\mathcal{S}} [\vec{p}]$.
- (3) If $\vec{p} \sim_{\mathcal{S}} \vec{q}$, then $\vec{p} \otimes 1 \sim_{\mathcal{S}} \vec{q} \otimes 1$ and $1 \otimes \vec{p} \sim_{\mathcal{S}} 1 \otimes \vec{q}$.

Definition 4.15. We define a particular congruence relation $\hat{\mathcal{S}}$ as follows: $\vec{p} \sim_{\hat{\mathcal{S}}} \vec{q}$ if and only if for all objects A, B and all \vec{r}, \vec{s} ,

$$[\vec{r}, 1_A \otimes \vec{p} \otimes 1_B, \vec{s}] \asymp [\vec{r}, 1_A \otimes \vec{q} \otimes 1_B, \vec{s}].$$

Remark 4.16. It should be observed that $\vec{p} \sim_{\hat{\mathcal{S}}} \vec{q}$ implies $[\vec{p}] \asymp [\vec{q}]$ by letting $A = B = I$ and \vec{r}, \vec{s} be empty lists.

Lemma 4.17. $\hat{\mathcal{S}}$ is a congruence relation.

Proof. We need to show axioms (1)–(3). To show (1), note that $\vec{p} \sim_{\hat{\mathcal{S}}} \vec{p}'$ and $\vec{q} \sim_{\hat{\mathcal{S}}} \vec{q}'$ implies

$$\begin{aligned} [\vec{r}, 1_A \otimes (\vec{p}, \vec{q}) \otimes 1_B, \vec{s}] &\asymp [\vec{r}, 1_A \otimes \vec{p} \otimes 1_B, 1_A \otimes \vec{q} \otimes 1_B, \vec{s}] \\ &\asymp [\vec{r}, 1_A \otimes \vec{p}' \otimes 1_B, 1_A \otimes \vec{q} \otimes 1_B, \vec{s}] \\ &\asymp [\vec{r}, 1_A \otimes \vec{p}' \otimes 1_B, 1_A \otimes \vec{q}' \otimes 1_B, \vec{s}] \\ &\asymp [\vec{r}, 1_A \otimes (\vec{p}', \vec{q}') \otimes 1_B, \vec{s}], \end{aligned}$$

where the first and last equation is just the definition of \otimes on paths. Therefore $\vec{p}, \vec{q} \sim_{\hat{\mathcal{S}}} \vec{p}', \vec{q}'$. To show (2), assume $[\vec{p}] \downarrow$. Then by Lemma 4.12(b), $1_A \otimes [\vec{p}] \otimes 1_B = [1_A \otimes \vec{p} \otimes 1_B]$ is defined, and from the laws of paracategories,

$$[\vec{r}, 1_A \otimes \vec{p} \otimes 1_B, \vec{s}] \asymp [\vec{r}, [1_A \otimes \vec{p} \otimes 1_B], \vec{s}] \asymp [\vec{r}, 1_A \otimes [\vec{p}] \otimes 1_B, \vec{s}].$$

Property (3) is immediate from the definition of $\hat{\mathcal{S}}$. \square

Definition 4.18. Let \sim be the smallest congruence relation on $\mathcal{P}(\mathcal{C})$, i.e., the intersection of all congruence relations.

Lemma 4.19. $\vec{p} \sim \vec{q}$ implies $[\vec{p}] \asymp [\vec{q}]$.

Proof. Since \sim is the smallest congruence relation, $\vec{p} \sim \vec{q}$ implies $\vec{p} \sim_{\hat{\mathcal{S}}} \vec{q}$, which implies $[\vec{p}] \asymp [\vec{q}]$ by Remark 4.16. \square

Corollary 4.20. If $\vec{p}, q : A \rightarrow B$ are paths where q is of length 1, then $\vec{p} \sim q$ iff $[\vec{p}] \downarrow$ and $[\vec{p}] = q$.

Proof. The left-to-right direction is obvious from Lemma 4.19 and axiom (b) of paracategories. The right-to-left direction is Definition 4.14(2). \square

Corollary 4.21. *If $p, q : A \rightarrow B$ are paths of length 1, then $p \sim q$ iff $p = q$.*

Proof. From Lemma 4.19 and axiom (b) of paracategories. \square

Definition 4.22. We now introduce the following notation, where \vec{f} and \vec{g} are paths, not necessarily of the same length.

$$\vec{f} \boxtimes \vec{g} := (\vec{f} \otimes 1), (1 \otimes \vec{g}). \quad (4.2)$$

Note that, as a path, this is not equal to $(1 \otimes \vec{g}), (\vec{f} \otimes 1)$. However, we will show that they are congruent.

Lemma 4.23. *Let \mathcal{S} be a congruence relation on $\mathcal{P}(\mathcal{C})$. Then $\vec{f} \sim_{\mathcal{S}} \vec{f}'$ and $\vec{g} \sim_{\mathcal{S}} \vec{g}'$ implies $\vec{f} \boxtimes \vec{g} \sim_{\mathcal{S}} \vec{f}' \boxtimes \vec{g}'$.*

Proof. Assuming $\vec{f} \sim_{\mathcal{S}} \vec{f}'$ and $\vec{g} \sim_{\mathcal{S}} \vec{g}'$, we immediately have $(\vec{f} \otimes 1), (1 \otimes \vec{g}) \sim_{\mathcal{S}} (\vec{f}' \otimes 1), (1 \otimes \vec{g}')$ by Definition 4.14(1) and (3). \square

Lemma 4.24. *Let \mathcal{S} be a congruence relation of $\mathcal{P}(\mathcal{C})$. Then*

$$(\vec{f} \otimes 1), (1 \otimes \vec{g}) \sim_{\mathcal{S}} (1 \otimes \vec{g}), (\vec{f} \otimes 1).$$

Proof. First, consider arrows f, g of \mathcal{C} . By Lemma 4.11, we have $[f \otimes 1, 1 \otimes g] = f \otimes g = [1 \otimes g, f \otimes 1]$, and in particular, these terms are defined. Therefore by Definition 4.14(2),

$$f \otimes 1, 1 \otimes g \sim_{\mathcal{S}} [f \otimes 1, 1 \otimes g] = [1 \otimes g, f \otimes 1] \sim_{\mathcal{S}} 1 \otimes g, f \otimes 1.$$

The general claim follows by induction, using Definition 4.14(1) and transitivity. \square

Proposition 4.25. *Let \mathcal{C} be a strict symmetric monoidal paracategory, and let \mathcal{S} be a congruence relation on $\mathcal{P}(\mathcal{C})$. Then the quotient $\mathcal{P}(\mathcal{C})/\mathcal{S}$ is a strict symmetric monoidal category.*

Proof. $\mathcal{P}(\mathcal{C})/\mathcal{S}$ is evidently a category; its objects are those of \mathcal{C} and its morphisms $\vec{f} = \overline{f_1, \dots, f_n}$ are \mathcal{S} -equivalence classes of paths. Composition is given by concatenation of paths, and is well-defined by Definition 4.14(1). A bifunctor $\bar{\boxtimes} : \mathcal{P}(\mathcal{C})/\mathcal{S} \times \mathcal{P}(\mathcal{C})/\mathcal{S} \rightarrow \mathcal{P}(\mathcal{C})/\mathcal{S}$ is defined by $\vec{f} \bar{\boxtimes} \vec{g} = \overline{\vec{f} \boxtimes \vec{g}}$, and is well-defined by Lemma 4.23. The symmetry is given by $\overline{\sigma_{A,B}} : A \otimes B \rightarrow B \otimes A$. The laws of strict symmetric monoidal categories are easily verified. \square

From now on, we also write “;” to denote composition in the quotient category written in diagrammatic order, i.e., concatenation of (equivalence classes of) paths. Also, by a slight abuse of notation, we write $1_A = \overline{1_A}$ for the identities in $\mathcal{P}(\mathcal{C})/\mathcal{S}$, i.e., this is the equivalence class of the empty path at A .

We are now ready to prove that every strict symmetric monoidal paracategory can be faithfully embedded in a strict symmetric monoidal category.

Definition 4.26. If \mathcal{C} is a strict symmetric monoidal paracategory, \mathcal{S} a congruence, and $\mathcal{P}(\mathcal{C})/\mathcal{S}$ is the quotient category, we define a functor of paracategories $F : \mathcal{C} \rightarrow \mathcal{P}(\mathcal{C})/\mathcal{S}$, where the category $\mathcal{P}(\mathcal{C})/\mathcal{S}$ is understood as a (total) paracategory, as follows.

- on objects, F is the identity, and
- on arrows, $F(f) = \vec{f}$, the equivalence class of a path of length 1.

Proposition 4.27. *$F : \mathcal{C} \rightarrow \mathcal{P}(\mathcal{C})/\mathcal{S}$ is a well-defined functor of symmetric monoidal paracategories. Moreover, if \mathcal{S} is the smallest congruence relation \sim , then F is faithful.*

Proof. Observe that F is indeed a functor of paracategories as in Definition 4.8: when $[\vec{f}]$ is defined, then by Definition 4.14(2) $[\vec{f}] \sim_{\mathcal{S}} \vec{f}$, hence

$$F[\vec{f}] = \overline{[\vec{f}]} = \overline{\vec{f}} = \overline{f_1, \dots, f_n} = \overline{f_1}; \dots; \overline{f_n} = Ff_1; \dots; Ff_n.$$

Moreover, F is strictly monoidal: by Lemma 4.11, Definition 4.14(2), Definition 4.22 and by definition of the tensor on $\mathcal{P}(\mathcal{C})$, we have

$$F(f \otimes g) = \overline{f \otimes g} = \overline{[f \otimes 1_B, 1_C \otimes g]} = \overline{f \otimes 1_B, 1_C \otimes g} = \overline{f} \boxtimes \overline{g} = Ff \boxtimes Fg.$$

Also, trivially, $F(\sigma) = \overline{\sigma}$.

For general \mathcal{S} , the functor F may not be faithful. For a trivial example, consider the maximal relation $\mathcal{S} = \mathcal{P}(\mathcal{C}) \times \mathcal{P}(\mathcal{C})$, which is always a congruence. However, if \mathcal{S} is the smallest congruence relation, then F is faithful by Corollary 4.21. Indeed, by Remark 4.16, this is true for any congruence relation satisfying $\mathcal{S} \subseteq \hat{\mathcal{S}}$. \square

4.4 Compact closed paracategories

Definition 4.28. A (strict symmetric) compact closed paracategory $(\mathcal{C}, [-], \otimes, I, \sigma, \eta, \varepsilon)$ is a strict symmetric monoidal paracategory, equipped for every object A with a given object A^* and given arrows $\eta_A : I \rightarrow A^* \otimes A$, $\varepsilon_A : A \otimes A^* \rightarrow I$, such that

- $[1_A \otimes \eta_C, f \otimes 1_C]$, $[g \otimes 1_{C^*}, 1_B \otimes \varepsilon_C]$, $[\eta_A \otimes 1_B, 1_{A^*} \otimes h]$, and $[1_A \otimes k, \varepsilon_A \otimes 1_C]$ are defined, for all $f : A \otimes C^* \rightarrow B$, $g : A \rightarrow B \otimes C$, $h : A \otimes B \rightarrow C$, and $k : B \rightarrow A^* \otimes C$ (totality);
- $[1_A \otimes \eta_A, \varepsilon_A \otimes 1_A] = 1_A$ and $[\eta_A \otimes 1_{A^*}, 1_{A^*} \otimes \varepsilon_A] = 1_{A^*}$.

Theorem 4.29. If \mathcal{C} is a compact closed paracategory, then $\mathcal{P}(\mathcal{C})/\mathcal{S}$ is a compact closed category. In particular, every compact closed paracategory can be faithfully embedded in a compact closed category.

Proof. We must show that $\mathcal{P}(\mathcal{C})/\mathcal{S}$, with $\eta' = \overline{\eta}$ and $\varepsilon' = \overline{\varepsilon}$, is compact closed. This is easily verified. For example, the condition $[1 \otimes \eta, \varepsilon \otimes 1] \downarrow$ implies:

$$\begin{aligned} 1_A \boxtimes \overline{\eta}; \overline{\varepsilon} \boxtimes 1_A &= \overline{1_A \otimes \eta; \varepsilon \otimes 1_A} \\ &= \overline{1_A \otimes \eta, \varepsilon \otimes 1_A} \\ &= \overline{[1_A \otimes \eta, \varepsilon \otimes 1_A]} \\ &= \overline{1_A} = 1_A. \end{aligned}$$

The proof of $\overline{\eta} \boxtimes 1_{A^*}; 1_{A^*} \boxtimes \overline{\varepsilon} = 1_{A^*}$ is similar. \square

Remark 4.30. By analogy with Proposition 2.8, in any compact closed paracategory, we can define the trace of an arrow $f : A \otimes U \rightarrow B \otimes U$ to be

$$\mathrm{Tr}_{A,B}^U(f) \stackrel{U}{\asymp} [1_A \otimes \eta_U, 1_A \otimes \sigma_{U^*,U}, f \otimes 1_{U^*}, 1_B \otimes \varepsilon_U] : A \rightarrow B.$$

Then $\mathrm{Tr}_{A,B}^U$ is of course a partially defined operation.

Recall from Definition 4.18 that \sim is the smallest congruence relation on $\mathcal{P}(\mathcal{C})$.

Theorem 4.31. The functor $F : \mathcal{C} \rightarrow \mathcal{P}(\mathcal{C})/\sim$ preserves and reflects the trace. This means that for all $f : A \otimes U \rightarrow B \otimes U$ and $g : A \rightarrow B$ in \mathcal{C} , we have $\mathrm{Tr}^U(f) = g$ iff $\mathrm{Tr}^{FU} F(f) = F(g)$.

Proof. By definition, we have $\mathrm{Tr}^{FU} F(f) = F(g)$ in $\mathcal{P}(\mathcal{C})/\sim$ if and only if $1_A \otimes \eta_U, 1_A \otimes \sigma_{U^*,U}, f \otimes 1_{U^*}, 1_B \otimes \varepsilon_U \sim g$ is an equivalence of paths in $\mathcal{P}(\mathcal{C})$. By Corollary 4.20, this is the case iff $[1_A \otimes \eta_U, 1_A \otimes \sigma_{U^*,U}, f \otimes 1_{U^*}, 1_B \otimes \varepsilon_U] = g$ in \mathcal{C} , i.e., $\mathrm{Tr}^U(f) = g$. \square

4.5 The universal property of $\mathcal{P}(\mathcal{C})/\sim$

We can strengthen Proposition 4.27 by noting that the faithful embedding satisfies a universal property when \mathcal{S} is the smallest congruence relation.

Theorem 4.32. *Let \mathcal{C} be a strict symmetric monoidal paracategory, and let \sim be the smallest congruence relation on $\mathcal{P}(\mathcal{C})$. Then the category $\mathcal{P}(\mathcal{C})/\sim$ satisfies the following property: for any strict symmetric monoidal category \mathcal{D} and any strict symmetric monoidal functor $G : \mathcal{C} \rightarrow \mathcal{D}$ of paracategories, there exists a unique strict symmetric monoidal functor $L : \mathcal{P}(\mathcal{C})/\sim \rightarrow \mathcal{D}$ such that $L \circ F = G$, where F is the canonical functor as in Definition 4.26.*

$$\begin{array}{ccc} \mathcal{C} & \xrightarrow{F} & \mathcal{P}(\mathcal{C})/\sim \\ & \searrow G & \downarrow L \\ & & \mathcal{D} \end{array}$$

Proof. For consistency of notation, let us write “;” for composition in \mathcal{D} in diagrammatic order. Define a family of relations \mathcal{S} on $\mathcal{P}(\mathcal{C})$ by:

$$\vec{f} \sim_{\mathcal{S}} \vec{g} \quad :\iff \quad G(f_1); \dots; G(f_n) = G(g_1); \dots; G(g_m),$$

where $\vec{f} = f_1, \dots, f_n$ and $\vec{g} = g_1, \dots, g_m$. We claim that \mathcal{S} is a congruence relation. Clearly, it is an equivalence relation. Properties (1) and (3) of Definition 4.14 are trivialities; for (2), note that when $[\vec{f}] \downarrow$, then $G[\vec{f}] = Gf_1; \dots; Gf_n$ by Definition 4.8, hence $[\vec{f}] \sim_{\mathcal{S}} \vec{f}$.

We define L as follows:

$$L(A) = G(A) \text{ on objects and } L(\vec{p}) = G(p_1); \dots; G(p_n), \text{ where } \vec{p} = p_1, \dots, p_n.$$

L is well-defined because $\vec{p} \sim \vec{q}$ implies $\vec{p} \sim_{\mathcal{S}} \vec{q}$, and this implies $L(\vec{p}) = L(\vec{q})$. L is easily seen to be a strict symmetric monoidal functor satisfying $L \circ F = G$.

For uniqueness, consider any other such functor L' . Then $L'(A) = L'(FA) = GA = LA$ and $L'(\vec{p}) = L'(\vec{p}_1; \dots; \vec{p}_n) = L'(Fp_1, \dots, Fp_n) = L'(Fp_1); \dots; L'(Fp_n) = G(p_1); \dots; G(p_n) = L(\vec{p})$, so $L' = L$. \square

An analogous result holds with respect to compact closed paracategories and compact closed categories.

5 The Int-construction for partially traced categories

Joyal, Street, and Verity proved in [15] that every (totally) traced monoidal category \mathcal{C} can be faithfully embedded in a compact closed category $\text{Int}(\mathcal{C})$. Here we show, by a similar construction, that every *partially* traced category \mathcal{C} can be faithfully embedded in a compact closed *paracategory* $\text{Int}^p(\mathcal{C})$. We call the corresponding construction the *partial Int-construction*. We assume without loss of generality that \mathcal{C} is strictly monoidal.

5.1 The definition of $\text{Int}^p(\mathcal{C})$

Definition 5.1. To any partially traced symmetric strictly monoidal category \mathcal{C} , we associate a graph $\text{Int}^p(\mathcal{C})$ as follows.

- an object is a pair (A^+, A^-) of objects of the category \mathcal{C} .
- an arrow $f : (A_0^+, A_0^-) \rightarrow (A_1^+, A_1^-)$ is an arrow $f : A_0^+ \otimes A_1^- \rightarrow A_1^+ \otimes A_0^-$ in the category \mathcal{C} .

To make $\text{Int}^p(\mathcal{C})$ into a paracategory, we need to define a partial composition operation $[-]$ on paths. Before giving the formal definition, we first illustrate the idea in the case of a path $\vec{p} = p_1, p_2, p_3$ of length 3, where

$$(A_0^+, A_0^-) \xrightarrow{p_1} (A_1^+, A_1^-) \xrightarrow{p_2} (A_2^+, A_2^-) \xrightarrow{p_3} (A_3^+, A_3^-).$$

In this case, the partial composition $[\vec{p}] : (A_0^+, A_0^-) \rightarrow (A_3^+, A_3^-)$ is defined as follows:

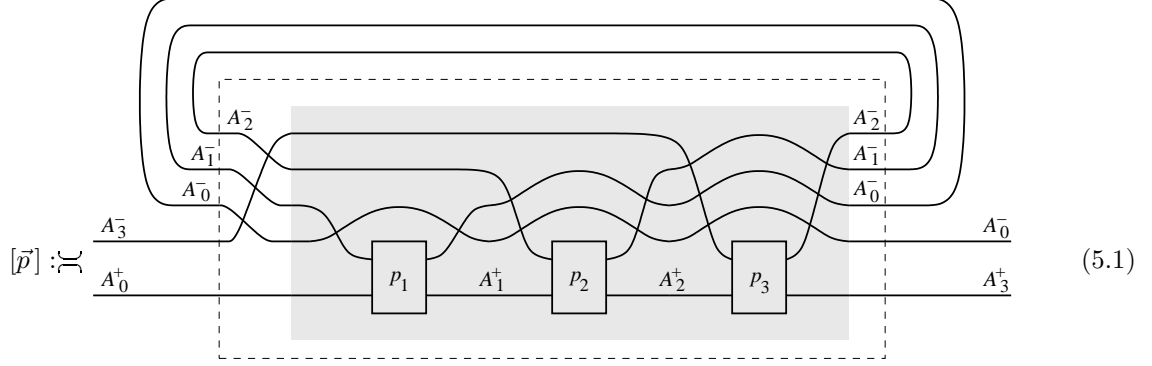

See Section 3.2 for our conventions regarding the graphical language. In particular, the trace shown is a single trace over the object $A_0^- \otimes A_1^- \otimes A_2^-$. Note that this trace may be undefined, and therefore $[\vec{p}]$ is a partial operation.

To define $[\vec{p}]$ for paths of arbitrary length, we give a recursive definition. We first recursively define an auxiliary operation, corresponding to the contents of the shaded area in (5.1).

Definition 5.2. We define an auxiliary (total) operation $\llbracket - \rrbracket$, called *precomposition*. This operation assigns to each path $\vec{p} = p_1, \dots, p_n : (A_0^+, A_0^-) \rightarrow (A_n^+, A_n^-)$, with $n \geq 0$ and $p_i : (A_{i-1}^+, A_{i-1}^-) \rightarrow (A_i^+, A_i^-)$, a morphism

$$\llbracket \vec{p} \rrbracket : A_0^+ \otimes \mathbf{A}^- \otimes A_n^- \rightarrow A_n^+ \otimes A_0^- \otimes \mathbf{A}^-,$$

where $\mathbf{A}^- = A_0^- \otimes \dots \otimes A_{n-1}^-$. Precomposition is defined by recursion on paths. The base case is a path of length 0:

$$\llbracket \varepsilon_{(A_0^+, A_0^-)} \rrbracket = 1_{A_0^+ \otimes A_0^-} = \begin{array}{c} A_0^- \text{ --- } A_0^- \\ A_0^+ \text{ --- } A_0^+ \end{array}.$$

And when $\vec{p} = p_1, \dots, p_n$ as above is a path of length n , we define

$$\llbracket \vec{p}, p_{n+1} \rrbracket = \begin{array}{c} A_{n+1}^- \\ A_n^- \\ \mathbf{A}^- \\ A_0^+ \end{array} \text{ --- } \boxed{\llbracket \vec{p} \rrbracket} \text{ --- } \begin{array}{c} A_n^- \\ A_n^+ \\ p_{n+1} \\ A_{n+1}^+ \end{array}.$$

Here, a thick line represents the object \mathbf{A}^- , which really consists of n parallel lines.

Definition 5.3. For any path $\vec{p} = p_1, \dots, p_n$, with $n \geq 0$ and $p_i : (A_{i-1}^+, A_{i-1}^-) \rightarrow (A_i^+, A_i^-)$, the partial composition $[\vec{p}]$ is defined as

$$[\vec{p}] := \text{Tr}^{\mathbf{A}^-} (\llbracket \vec{p} \rrbracket \circ (A_0^+ \otimes \sigma_{A_n^-, \mathbf{A}^-})) \cong \begin{array}{c} \mathbf{A}^- \\ A_n^- \\ A_0^+ \end{array} \text{ --- } \boxed{\llbracket \vec{p} \rrbracket} \text{ --- } \begin{array}{c} A_0^- \\ A_n^+ \end{array}.$$

The reader is invited to verify that in case $n = 3$, this definition indeed coincides with (5.1).

5.2 $\text{Int}^P(\mathcal{C})$ is a paracategory

We start with a lemma that will be useful in the proof of the paracategory properties for $\text{Int}^P(\mathcal{C})$.

Lemma 5.4. For all paths $\vec{p}: (A^+, A^-) \rightarrow (B^+, B^-)$ and $\vec{q}: (B^+, B^-) \rightarrow (C^+, C^-)$,

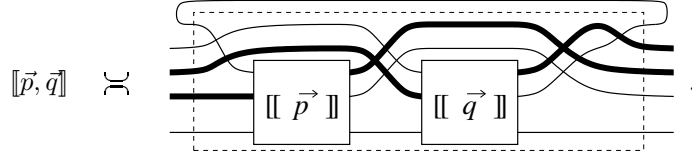

In particular, the diagram is always defined.

Proof. Since the left-hand side is always defined, it suffices to prove “ \supseteq ”. We do this by induction on \vec{q} . For the base case, we have by yanking, strength, and naturality:

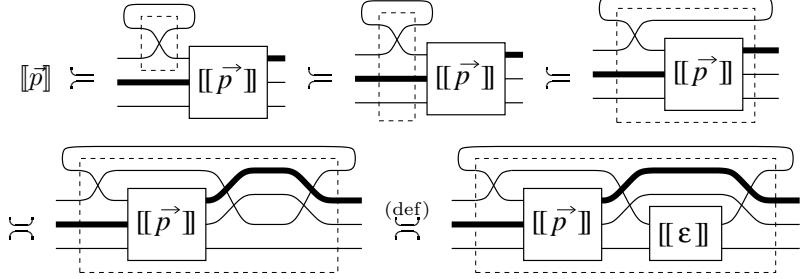

For the induction step, we have by superposing and naturality:

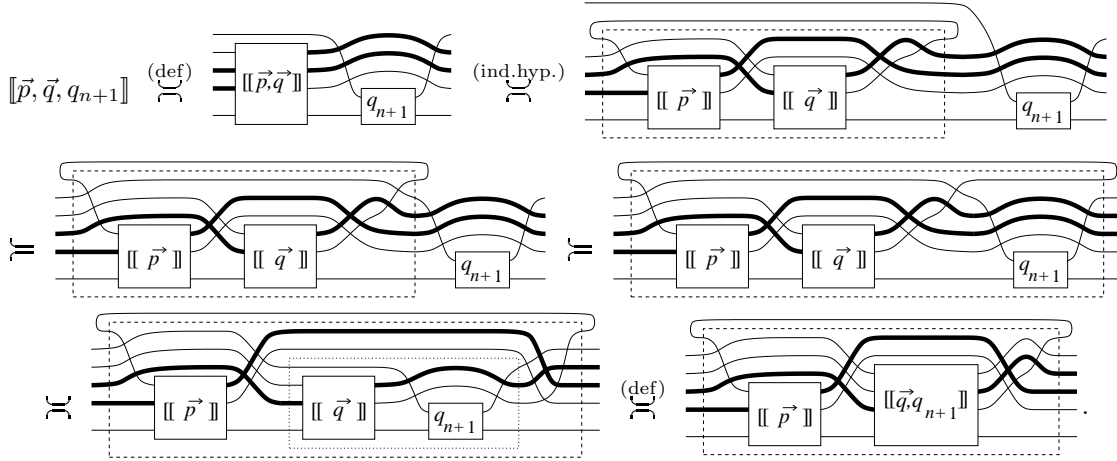

□

The above proof illustrates that the strength, superposing, and naturality axioms all serve to “enlarge” the dashed boxes under directed Kleene equality. To save space, in the following we often combine these axioms, as well as the left-to-right direction of vanishing II, into a single graphical step.

Lemma 5.5. Let \mathcal{C} be a partially traced symmetric (strictly) monoidal category. With the partial composition $[-]$ defined in Definition 5.3, $\text{Int}^P(\mathcal{C})$ is a paracategory.

Proof. (a) By vanishing I, it follows immediately that $[\epsilon_{(A^+, A^-)}] = [\epsilon_{(A^+, A^-)}] = 1_{(A^+, A^-)}$. In particular, $[\epsilon_{(A^+, A^-)}] \downarrow$.

(b) For a path $f: (A_0^+, A_0^-) \rightarrow (A_1^+, A_1^-)$ of length 1, we have by yanking, strength, and naturality:

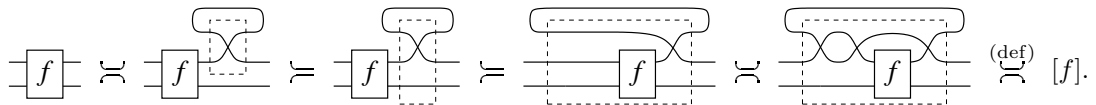

In particular, the right-hand side is defined.

(c) We must show that whenever $[\vec{q}]$ is defined, then $[\vec{p}, [\vec{q}], \vec{r}] \simeq [\vec{p}, \vec{q}, \vec{r}]$. First, by Lemma 5.4, superposing, naturality, and vanishing II, we have

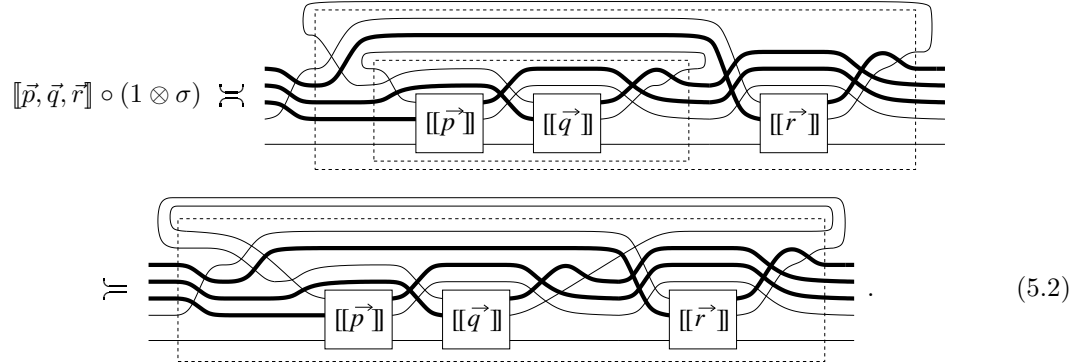

Second, assume that $[\vec{q}]$ is defined. By definition of $[\vec{q}]$, Lemma 5.4, superposing, naturality, and vanishing II, we have

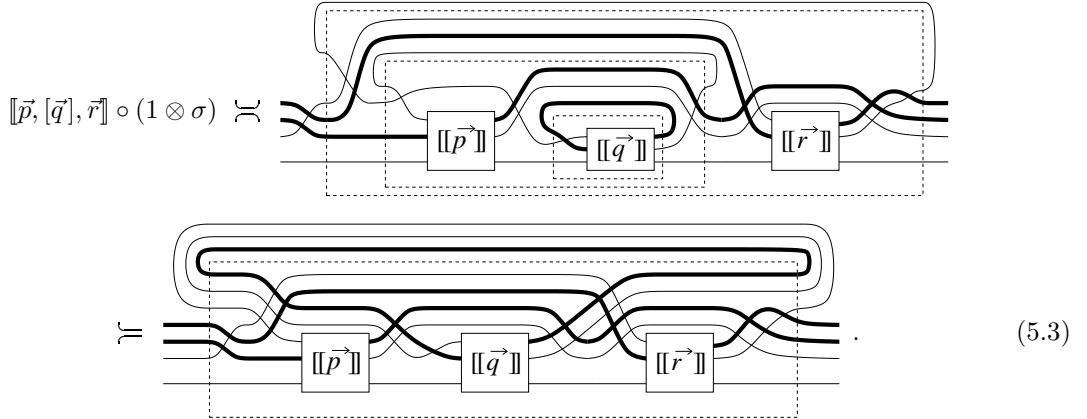

Note that every morphism mentioned so far is defined. Recall that by definition, $[\vec{p}, \vec{q}, \vec{r}]$ and $[\vec{p}, [\vec{q}], \vec{r}]$ are the trace of (5.2) and (5.3), respectively, where the trace is taken on the “fat” wires. The fact that $[\vec{p}, \vec{q}, \vec{r}] \simeq [\vec{p}, [\vec{q}], \vec{r}]$ then follows immediately from vanishing II and dinaturality. \square

Lemma 5.6. *For paths of length 2, we have*

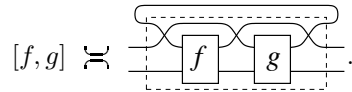

Proof. By yanking, strength, and naturality, we have

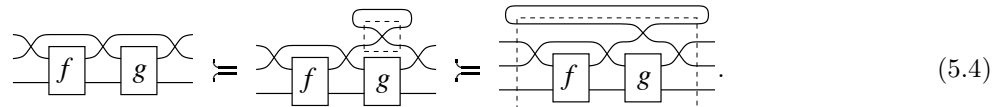

Since the left-hand side is defined, so is the right-hand side. This justifies the application of vanishing II in the following:

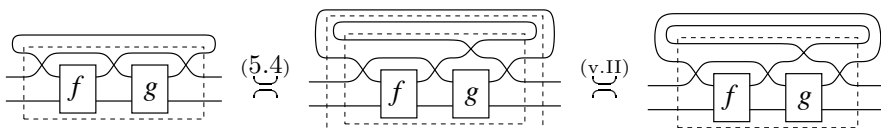

$$\stackrel{\text{(dinat.)}}{\cong} \left[\text{diagram with } f, g \text{ and a loop} \right] \cong \left[\text{diagram with } f, g \text{ and a loop} \right] \stackrel{\text{(def)}}{\cong} [f, g].$$

□

5.3 $\text{Int}^p(\mathcal{C})$ is symmetric monoidal

Next, we wish to show that the paracategory $\text{Int}^p(\mathcal{C})$ is strictly monoidal.

Definition 5.7. The tensor on the paracategory $\text{Int}^p(\mathcal{C})$ is defined as follows:

- on objects: $(A^+, A^-) \otimes (B^+, B^-) = (A^+ \otimes B^+, B^- \otimes A^-)$;
- on arrows: given $f^{\text{Int}^p} : (A^+, A^-) \rightarrow (C^+, C^-)$ and $g^{\text{Int}^p} : (B^+, B^-) \rightarrow (D^+, D^-)$, then $(f \otimes g)^{\text{Int}^p} : (A^+, A^-) \otimes (B^+, B^-) \rightarrow (C^+, C^-) \otimes (D^+, D^-)$ is defined by

$$\begin{array}{c} C^- \\ D^- \\ B^+ \\ A^+ \end{array} \begin{array}{c} \text{---} \\ \text{---} \\ \text{---} \\ \text{---} \end{array} \begin{array}{c} \text{---} \\ \text{---} \\ \text{---} \\ \text{---} \end{array} \begin{array}{c} A^- \\ B^- \\ D^+ \\ C^+ \end{array}$$

We also define the tensor unit to be (I, I) .

Lemma 5.8. The operation \otimes is a functor of paracategories.

Proof. We have to show the two conditions from Lemma 4.12.

- (a) We show $[f, f'] \otimes [g, g'] \cong [f \otimes g, f' \otimes g']$. By Lemma 5.6, strength, superposing, naturality, the left-to-right direction of vanishing, and the laws of symmetric monoidal categories, we have:

$$\begin{array}{c} [f, f'] \otimes [g, g'] \cong \left[\text{diagram with } f, f', g, g' \text{ and loops} \right] \\ \cong \left[\text{diagram with } f, f', g, g' \text{ and loops} \right] \cong \left[\text{diagram with } f, g, f', g' \text{ and loops} \right] \end{array}$$

and the final diagram is just the definition of $[f \otimes g, f' \otimes g']$.

- (b) We will only show $1 \otimes [\vec{p}] \cong [1 \otimes \vec{p}]$; the proof of the other property $[\vec{p}] \otimes 1 \cong [\vec{p} \otimes 1]$ is similar. Since the proof by induction is long and not very interesting, we will only consider the representative case when $\vec{p} = p_1, p_2, p_3$. Using superposing, yanking, strength, naturality, vanishing II, and dinaturality, we have:

$$\begin{array}{c} [\vec{p}] \otimes 1 \stackrel{\text{(def)}}{\cong} \left[\text{diagram with } p_1, p_2, p_3 \text{ and loops} \right] \cong \left[\text{diagram with } p_1, p_2, p_3 \text{ and loops} \right] \\ \cong \left[\text{diagram with } p_1, p_2, p_3 \text{ and loops} \right] \stackrel{\text{(def)}}{\cong} [\vec{p} \otimes 1]. \end{array}$$

□

Lemma 5.9. *With the tensor product from Definition 5.7, $\text{Int}^P(\mathcal{C})$ is a strict monoidal paracategory in the sense of Definition 4.10(b).*

Proof. The conditions $(A \otimes B) \otimes C = A \otimes (B \otimes C)$, $A \otimes I = A = I \otimes A$, and $f \otimes 1_I = f = 1_I \otimes f$ follow immediately from the strictness of \mathcal{C} . The condition $(f \otimes g) \otimes h = f \otimes (g \otimes h)$ holds because both sides are equal to the diagram

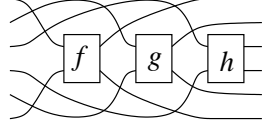

□

Next, we will equip the category $\text{Int}^P(\mathcal{C})$ with a symmetry.

Definition 5.10. The symmetry $\sigma : (A^+, A^-) \otimes (B^+, B^-) \rightarrow (B^+, B^-) \otimes (A^+, A^-)$ in $\text{Int}^P(\mathcal{C})$ is given by $\sigma_{A^+, B^+} \otimes \sigma_{A^-, B^-} : (A^+ \otimes B^+) \otimes (B^- \otimes A^-) \rightarrow (B^+ \otimes A^+) \otimes (A^- \otimes B^-)$.

Lemma 5.11. *With this structure, $\text{Int}^P(\mathcal{C})$ is a strict symmetric monoidal paracategory.*

Proof. We must show that σ satisfies the conditions of Definition 4.10(c). To prove totality, consider any $f : X \otimes B \otimes A \rightarrow Y$, where $A = (A^+, A^-)$, $B = (B^+, B^-)$, $X = (X^+, X^-)$, and $Y = (Y^+, Y^-)$. We must prove that $[1_X \otimes \sigma_{A,B}, f]$ is defined. But using yanking, strength, naturality, and Lemma 5.6, we have

Since the left-hand side is defined, so is the right-hand side. One similarly proves that $[g, 1_X \otimes \sigma_{A,B}] \downarrow$. By setting $X = 1$ in (5.5) and the corresponding property for g , we get the identities

$$[\sigma_{A,B}, f] = \text{diagram with box } f \text{ and crossing} \quad \text{and} \quad [g, \sigma_{A,B}] = \text{diagram with box } g \text{ and crossing}. \quad (5.6)$$

The remaining laws follow from (5.6). We have:

$$[f \otimes g, \sigma] \stackrel{(5.6)}{=} \text{diagram with boxes } f, g \text{ and crossing} = \text{diagram with boxes } g, f \text{ and crossing} \stackrel{(5.6)}{=} [\sigma, g \otimes f]. \quad (5.7)$$

$$[\sigma, \sigma] \stackrel{(5.6)}{=} \text{diagram with two crossings} = 1 \quad (5.8)$$

$$[\sigma_{A, B \otimes C}, 1_B \otimes \sigma_{C, A}] \stackrel{(5.6)}{=} \text{diagram with boxes } \sigma, 1, \sigma \text{ and crossings} \stackrel{(5.6)}{=} \text{diagram with boxes } \sigma, 1, \sigma \text{ and crossings} \stackrel{(5.6)}{=} \sigma_{A, B} \otimes 1_C. \quad (5.9)$$

Naturality is (5.7), symmetry is (5.8), and the hexagon axiom is equivalent to (5.9) by Remark 4.6. □

5.4 $\text{Int}^P(\mathcal{C})$ is compact closed

Definition 5.12. On $\text{Int}^P(\mathcal{C})$, we define the dual of an object to be $(A, B)^* = (B, A)$. Using strictness, we define the unit and counit morphisms $\eta_{(A,B)} : I \rightarrow (A, B)^* \otimes (A, B)$ and $\varepsilon_{(A,B)} : (A, B) \otimes (A, B)^* \rightarrow I$ to be the morphisms $\eta_{(A,B)} = 1 : B \otimes A \rightarrow B \otimes A$ and as $\varepsilon_{(A,B)} = 1 : A \otimes B \rightarrow A \otimes B$ in \mathcal{C} .

Lemma 5.13. *With this structure, $\text{Int}^P(\mathcal{C})$ is a compact closed paracategory.*

Proof. Let $f : A \otimes C^* \rightarrow B$. We must show that $[1_A \otimes \eta_C, f \otimes 1_C]$ is defined. We have:

and since the left-hand side is defined, so is the right-hand side. The proofs for the definedness of $[g \otimes 1_C, 1_B \otimes \varepsilon_C]$, $[\eta_A \otimes 1_B, 1_{A^*} \otimes h]$, and $[1_A \otimes k, \varepsilon_A \otimes 1_C]$ are similar. We prove that $[1_A \otimes \eta_A, \varepsilon_A \otimes 1_A] = 1_A$ by setting $C = A$, $B = I$, and $f = \varepsilon_A$ in the above, and recalling that $\varepsilon_A = 1_{A^+ \otimes A^-} = 1_A$ as morphisms of \mathcal{C} . The proof of $[\eta_A \otimes 1_{A^*}, 1_{A^*} \otimes \varepsilon_A] = 1_{A^*}$ is analogous. \square

5.5 An embedding of \mathcal{C} in $\text{Int}^P(\mathcal{C})$

Definition 5.14. In a similar way as done in [15], we define a full and faithful functor of paracategories $N : \mathcal{C} \rightarrow \text{Int}^P(\mathcal{C})$. It is given on objects by $N(A) = (A, I)$ and (using strictness of the category \mathcal{C}) on morphisms by $N(f) = f$.

Theorem 5.15. *N is a full and faithful functor of strict symmetric monoidal paracategories. In particular, every partially traced (strictly monoidal) category can be fully and faithfully embedded in a compact closed paracategory.*

Proof. To prove functoriality, note that we are considering the category \mathcal{C} as a paracategory with composition $[f_1, \dots, f_n] = f_n \circ \dots \circ f_1$. It follows immediately from the definition of composition on $\text{Int}^P(\mathcal{C})$, strictness, and vanishing I that $[N(f_1), \dots, N(f_n)] \asymp [f_1, \dots, f_n] = \llbracket f_1, \dots, f_n \rrbracket = f_n \circ \dots \circ f_1 = N(f_n \circ \dots \circ f_1)$, so N is a functor. The fact that N is full and faithful is also obvious, as is the fact that it preserves tensor and symmetry. \square

Theorem 5.16. *The functor $N : \mathcal{C} \rightarrow \text{Int}^P(\mathcal{C})$ preserves and reflects the trace, i.e., for all morphisms $f : A \otimes U \rightarrow B \otimes U$ and $g : A \rightarrow B$ in \mathcal{C} , we have $\text{Tr}^U(f) = g$ iff $\text{Tr}^{NU} N(f) = N(g)$.*

Proof. Recall that the trace on $\text{Int}^P(\mathcal{C})$ is defined as in Remark 4.30. Because N is full and faithful, the claimed property is equivalent to $N(\text{Tr}^U(f)) \asymp \text{Tr}^{NU} N(f)$. Using similar methods as in previous proofs, we have:

□

5.6 The universal property of $\text{Int}^P(\mathcal{C})$

The category $\text{Int}^P(\mathcal{C})$ is in fact the free compact closed paracategory over a given partially traced category. To be able to state this theorem, we first need to define the notation of a (non-strict) functor of compact closed paracategories.

Definition 5.17. An isomorphism $m : A \rightarrow B$ in a symmetric monoidal paracategory is said to be *total* if $[1_C \otimes m, f]$, $[g, 1_C \otimes m]$, $[1_C \otimes m^{-1}, h]$, and $[k, 1_C \otimes m^{-1}]$ are defined, for all $f : C \otimes B \rightarrow D$, $g : D \rightarrow C \otimes A$, $h : C \otimes A \rightarrow D$, and $k : D \rightarrow C \otimes B$.

Definition 5.18. Let \mathcal{D} and \mathcal{D}' be compact closed paracategories. A (non-strict) functor of compact closed paracategories $K : \mathcal{D} \rightarrow \mathcal{D}'$ is a functor of paracategories that is equipped with total natural isomorphisms $m_{A,B} : K(A) \otimes' K(B) \rightarrow K(A \otimes B)$, $m_I : I' \rightarrow K(I)$, and $m_* : (KA)^* \rightarrow K(A^*)$, respecting all the structure.

Remark 5.19. In the presence of $m_{A,B}$ and m_I , a unique coherent isomorphism $m_* : (KA)^* \rightarrow K(A^*)$ automatically exists, but its totality is an additional property that must be required.

Theorem 5.20. Let \mathcal{C} be a partially traced symmetric (strictly) monoidal category, \mathcal{D} a compact closed paracategory, and $G : \mathcal{C} \rightarrow \mathcal{D}$ a trace-preserving functor of symmetric monoidal paracategories. Then there exists an essentially unique (non-strict) functor of compact closed paracategories $K : \text{Int}^P(\mathcal{C}) \rightarrow \mathcal{D}$ such that

$$\begin{array}{ccc} \mathcal{C} & \xrightarrow{N} & \text{Int}^P(\mathcal{C}) \\ & \searrow G & \downarrow K \\ & & \mathcal{D} \end{array}$$

Proof. Without loss of generality we write as if \mathcal{D} were also strictly monoidal. Let us also write $G(A) = \bar{A}$. The construction of the functor $K : \text{Int}^P(\mathcal{C}) \rightarrow \mathcal{D}$ is similar to that of Joyal, Street, and Verity in [15]. On objects, it is defined as $K(A, B) = \bar{A} \otimes \bar{B}^*$. A morphism $f : (A, B) \rightarrow (C, D)$ is given by $f : A \otimes D \rightarrow C \otimes B$ in \mathcal{C} , and we have $G(f) : \bar{A} \otimes \bar{D} \rightarrow \bar{C} \otimes \bar{B}$. Then $K(f) : \bar{A} \otimes \bar{B}^* \rightarrow \bar{C} \otimes \bar{D}^*$ is defined as

$$K(f) := [1_{\bar{A}} \otimes \eta_{\bar{D}} \otimes 1_{\bar{B}^*}, 1_{\bar{A}} \otimes \sigma_{\bar{D}^*, \bar{D}} \otimes 1_{\bar{B}^*}, G(f) \otimes \sigma_{\bar{D}^*, \bar{B}^*}, 1_{\bar{C}} \otimes \varepsilon_{\bar{B}} \otimes 1_{\bar{D}^*}].$$

It follows from the axioms of compact closed paracategories that $K(f) \downarrow$. The remaining properties are tedious but routine to verify. □

Remark 5.21. Even when \mathcal{C} , \mathcal{D} , and G are strict, one cannot in general expect K to be strict. This is because the objects of the category $\text{Int}^P(\mathcal{C})$ satisfy special equations, such as $A \otimes B^* = B^* \otimes A$ for all A, B in the image of N . Since one cannot expect \mathcal{D} to satisfy such equations, K cannot in general be strictly monoidal.

6 Representation theorem for partially traced categories

By combining the results of the previous sections, we arrive at the main theorem of this paper.

Theorem 6.1. *Every partially traced category can be faithfully embedded in a totally traced category. Moreover, the embedding is trace preserving and reflecting.*

Proof. Let \mathcal{C} be a partially traced category. We may without loss of generality assume that \mathcal{C} is strictly monoidal. By Theorems 5.15 and 5.16, there is a full and faithful, trace preserving and reflecting embedding $N : \mathcal{C} \rightarrow \text{Int}^P(\mathcal{C})$ of \mathcal{C} in a compact closed paracategory. By Theorem 4.29, there is a faithful embedding $F : \text{Int}^P(\mathcal{C}) \rightarrow \mathcal{P}(\text{Int}^P(\mathcal{C})) / \sim$ of $\text{Int}^P(\mathcal{C})$ in a compact closed category. Since $\mathcal{P}(\text{Int}^P(\mathcal{C})) / \sim$ is compact closed, it is totally traced, and by Theorem 4.31, F is trace preserving and reflecting. □

Corollary 6.2. *Every partially traced category arises from a totally traced category by the construction of Proposition 3.20.*

Corollary 6.3. *Any equational law of totally traced categories also holds in all partially traced categories, provided that the left-hand side and right-hand side are both defined. In particular, reasoning in the graphical language of traced monoidal categories is sound for proving the equality of two morphisms in partially traced categories, provided both morphisms are defined. The morphisms used in intermediate steps do not need to be defined.*

Proof. Via the faithful embedding in a totally traced category, the reasoning really takes place in that category. \square

Moreover, the category $\mathcal{P}(\text{Int}^p(\mathcal{C}))/\sim$ satisfies the following universal property.

Theorem 6.4. *Let \mathcal{C} be a partially traced category and \mathcal{D} a compact closed category. If $G : \mathcal{C} \rightarrow \mathcal{D}$ is a traced symmetric monoidal functor, then there exists an essentially unique strong symmetric monoidal functor $L : \mathcal{P}(\text{Int}^p(\mathcal{C}))/\sim \rightarrow \mathcal{D}$ such that*

$$\begin{array}{ccc} \mathcal{C} & \xrightarrow{N} & \text{Int}^p(\mathcal{C}) & \xrightarrow{F} & \mathcal{P}(\text{Int}^p(\mathcal{C}))/\sim \\ & \searrow G & & & \downarrow L \\ & & & & \mathcal{D}. \end{array}$$

Proof. By combining Theorems 5.20 and 4.32.

$$\begin{array}{ccc} \mathcal{C} & \xrightarrow{N} & \text{Int}^p(\mathcal{C}) & \xrightarrow{F} & \mathcal{P}(\text{Int}^p(\mathcal{C}))/\sim \\ & \searrow G & \searrow K & & \downarrow L \\ & & & & \mathcal{D}. \end{array}$$

\square

7 Discussion and future work

We established that the partially traced categories, in the sense of Haghverdi and Scott, are precisely the monoidal subcategories of totally traced categories. This was proved by a partial version of Joyal, Street, and Verity’s Int-construction, and by considering a strict symmetric compact closed version of Freyd’s paracategories.

Some readers may wonder whether we have stated these results at the right level of generality. It has been suggested that one could start from partially traced paracategories, or perhaps even partially traced paramonoidal paracategories, and still get an analogous result. Indeed, this can probably be done. One can a priori aim for a representation theorem of the form “every partially traced paracategory can be faithfully embedded in a totally traced category, in such a way that the operations are preserved and reflected”. This uniquely determines the notion of partially traced paracategory, namely, they are precisely the reflexive monoidal subgraphs of totally traced categories. One may then go through the exercise of axiomatizing this notion. We remark that such an axiomatization is necessarily quite strange; for example, it can happen that $\text{Tr}([\bar{p}])$ is defined even when $[\bar{p}]$ is undefined. Whatever axiomatization one discovers will immediately be rendered obsolete by the representation theorem, because it is in any case easier to reason in the larger totally traced category. Thus, in the absence of natural examples of such paracategories, it is an essentially futile exercise to try to axiomatize them.

By contrast, the notion of partially traced category, while also made somewhat obsolete by our representation theorem, is a pre-existing notion that had been studied in the literature and for which many

interesting examples exist, including some examples that do not *obviously* arise as subcategories of a totally traced category. Thus we believe this is indeed a good level of generality.

One question that we did not answer is whether specific partially traced categories can be embedded in totally traced categories in a “natural” way. For example, the category of finite dimensional vector spaces, with the biproduct \oplus as the tensor, can be equipped with a natural partial trace in several ways. By our proof, it follows that it can be faithfully embedded in a totally traced category. However, we do not know any concrete “natural” description of such a totally traced category (i.e., other than the free one constructed in our proof).

References

- [1] S. Abramsky and B. Coecke. A categorical semantics of quantum protocols. In *Proceedings of the 19th Annual IEEE Symposium on Logic in Computer Science (LICS 2004)*, pages 415–425. IEEE Computer Society Press, 2004.
- [2] F. Borceux. *Handbook of Categorical Algebra 1*. Cambridge University Press, 1994.
- [3] P. J. Freyd and A. Scedrov. *Categories, Allegories*. North-Holland, 1989.
- [4] J.-Y. Girard. Geometry of interaction I: interpretation of system F. In *Logic Colloquium '88*, Studies in Logic 127, pages 221–260. North Holland, 1989.
- [5] J.-Y. Girard. Geometry of interaction III: accommodating the additives. In *Advances in Linear Logic*, London Mathematical Society Lecture Note Series 222, pages 325–389. Cambridge University Press, 1995.
- [6] J.-Y. Girard. Geometry of interaction IV: the feedback equation. In *Logic Colloquium '03*, Lecture Notes in Logic, pages 76–117. Association for Symbolic Logic, 2006.
- [7] J.-Y. Girard. Geometry of interaction V: logic in the hyperfinite factor. *Theoretical Computer Science*, 412(20):1860–1883, 2011.
- [8] E. Haghverdi. Typed GoI for exponentials. In M. Bugliesi, B. Preneel, V. Sassone, and I. Wegener, editors, *Automata, Languages and Programming (ICALP 2006), Part II*, Springer LNCS 4052, pages 384–395, 2006.
- [9] E. Haghverdi and P. J. Scott. A categorical model for the geometry of interaction. *Theoretical Computer Science*, 350(2-3):252–274, 2006.
- [10] E. Haghverdi and P. J. Scott. Towards a typed geometry of interaction. *Mathematical Structures in Computer Science*, 20(3):1–49, 2010. Preliminary Version in: *CSL2005 (Computer Science Logic)*, SLNCS 3634, pp. 216–231.
- [11] E. Haghverdi and P. J. Scott. Geometry of interaction and the dynamics of proof reduction: a tutorial. In B. Coecke, editor, *New Structures for Physics*, Lecture Notes in Physics 813, pages 357–417. Springer, 2011.
- [12] M. Hasegawa. On traced monoidal closed categories. *Mathematical Structures in Computer Science*, 19(2):217–244, 2009.
- [13] C. Hermida and P. Mateus. Paracategories I: internal paracategories and saturated partial algebras. *Theoretical Computer Science*, pages 135–156, 2003.
- [14] M. Hyland and A. Schalk. Glueing and orthogonality for models of linear logic. *Theoretical Computer Science*, 294:183–231, 2003.

- [15] A. Joyal, R. Street, and D. Verity. Traced monoidal categories. *Mathematical Proceedings of the Cambridge Philosophical Society*, 119:447–468, 1996.
- [16] J. Lambek and P. J. Scott. *Introduction to Higher Order Categorical Logic*. Cambridge University Press, 1986.
- [17] S. M. Lane. *Categories for the Working Mathematician*. Graduate Texts in Mathematics. Springer, 2nd edition, 1998.
- [18] O. Malherbe. *Categorical models of computation: partially traced categories and presheaf models of quantum computation*. PhD thesis, Department of Mathematics and Statistics, University of Ottawa, 2010.
- [19] R. Penrose. Applications of negative dimensional tensors. In D. J. A. Welsh, editor, *Combinatorial Mathematics and its Applications*, pages 221–244. Academic Press, 1971.
- [20] G. Plotkin. Trace ideals. Invited lecture at MFPS 2003, Montreal, 2003.
- [21] P. Selinger. Towards a quantum programming language. *Mathematical Structures in Computer Science*, 14(4):527–586, 2004.
- [22] P. Selinger. Towards a semantics for higher-order quantum computation. In *Proceedings of the 2nd International Workshop on Quantum Programming Languages*, TUCS General Publication No 33, pages 127–143. Turku Centre for Computer Science, 2004.
- [23] P. Selinger. A survey of graphical languages for monoidal categories. In B. Coecke, editor, *New Structures for Physics*, Lecture Notes in Physics 813, pages 289–355. Springer, 2011.