

EXCHANGE MOVES AND BRAID REPRESENTATIONS OF LINKS

REIKO SHINJO AND ALEXANDER STOIMENOW

ABSTRACT. We prove that under fairly general conditions an iterated exchange move gives infinitely many non-conjugate braids. As a consequence, every knot has infinitely many conjugacy classes of n -braid representations if and only if it has one admitting an exchange move.

1. INTRODUCTION

The *braid groups* B_n were introduced in the 1930s in the work of Artin [2]. An element $b \in B_n$ is called an n -*braid*. Alexander [1] related braids to *links* in real 3-dimensional space, by means of a *closure* operation $\hat{}$. In that realm, it became important to understand the *braid representations* of a given link L , i.e. those b with $L = \hat{b}$. *Markov's theorem* relates these representations by two moves, the *conjugacy* in the braid group, and *(de)stabilization*, which passes between $b \in B_n$ and $b\sigma_n^{\pm 1} \in B_{n+1}$ (see e.g. [16]). Conjugacy is, starting with Garside's [11], and later many others' work, now relatively well group-theoretically understood. In contrast, the effect of (de)stabilization on conjugacy classes of braid representations of a given link is in general difficult to understand. Only in very special situations can these conjugacy classes be well described, e.g. [6].

In this paper we are concerned with the question when infinitely many conjugacy classes of n -braid representations of a given link occur. Birman and Menasco [5] introduced a move called *exchange move*, and proved that it necessarily underlies the switch between many conjugacy classes of braid representations of L . We will prove here that it is also sufficient for generating infinitely many such classes, under a very mild restriction.

Theorem 1.1. *Let a link L have an n -braid representation b admitting an exchange move, such that the permutation $\pi(b)$ satisfies $\pi(b)(1) \neq 1$ and $\pi(b)(n) \neq n$. Then iterated exchange moves on b generate infinitely many non-conjugate braids of L .*

Among the different braid representations of a link L the one with the fewest strands is called a *minimal braid*. The number of strands of a minimal braid is called the *braid index* $b(L)$ of L . Combining our result with the work of Birman and Menasco, we obtain then:

Corollary 1.2. *Let L be a knot, or a link without trivial components, and let $n \geq b(L)$. Then L has infinitely many conjugacy classes of n -braid representations if and only if it has one admitting an exchange move.*

Some non-conjugate braids close to isotopic links. Birman had observed [3] that stabilizations of different sign are non-conjugate, because of different exponent sum. However, the exponent sum is

2000 *AMS Subject Classification:* Primary 57M25, Secondary 20F36, 57M27.

The second author was supported by BK21 Project.

too weak to distinguish infinitely many conjugacy classes of n -braid representations for any n and L . It was also known from [6] that only finitely many conjugacy classes occur when $n \leq 3$.

In the case $n > b(L)$ of non-minimal braids, Morton [14] discovered an infinite sequence of conjugacy classes of 4-braids with closure being the unknot. Further examples were exhibited more recently by Fukunaga [9, 10] and the first author [20]. For every link, there are obvious (stabilized) non-minimal braid representations admitting an exchange move. Thus corollary 1.2 can always be applied (for knots). The first author obtained this special case of the theorem in her previous paper [21]. Her result for knots was later generalized by the second author to links. This was done for many links first in [23], using mostly the first author’s own methods, and later rather completely in [24], by an entirely different (Lie group theoretic) approach.

In the case $n = b(L)$ of minimal braids, Birman had conjectured that there would always be a single conjugacy class of minimal braids representing a link. However, K. Murasugi and R. S. D. Thomas [18] disproved Birman’s conjecture, exhibiting some counterexamples in B_4 . (They claim also such examples in higher B_n , but this is not justified from their proof, which uses the homomorphism $B_4 \rightarrow B_3$.) Our result can be seen as such a construction of nearly exhaustive generality. The few remaining braids are more subtle, and we discuss them briefly at the end of the paper.

2. PRELIMINARIES

2.1. Braids and closures.

Definition 2.1. The *braid group* B_n on n strands can be defined by

$$B_n = \left\langle \sigma_1, \dots, \sigma_{n-1} \mid \begin{array}{l} [\sigma_i, \sigma_j] = 1 \quad |i - j| > 1 \\ \sigma_j \sigma_i \sigma_j = \sigma_i \sigma_j \sigma_i \quad |i - j| = 1 \end{array} \right\rangle.$$

The σ_i are called *Artin standard generators*. An element $b \in B_n$ is an *n -braid*.

There is a graphical representation of braids, where in σ_i strands i and $i + 1$ cross, and multiplication is given by stacking. (We number strands from left to right and orient them downward.)

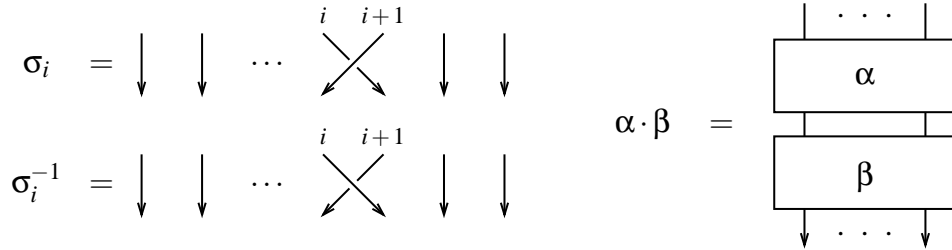

The *closure* \hat{b} of a braid b is a knot or link (with orientation) in S^3 :

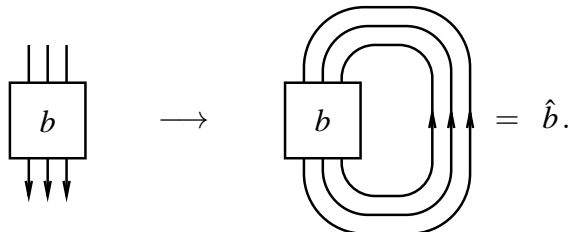

There is a permutation homomorphism of B_n ,

$$\pi : B_n \rightarrow S_n, \quad \text{given by} \quad \pi(\sigma_i) = (i, i + 1).$$

(The permutation on the right is a transposition.) We call $\pi(b)$ the *braid permutation* of b . We call b a *pure braid* if $\pi(b) = Id$.

Let b be an n -braid with numbered endpoints as in Figure 1. Suppose that b has its strings connected as follows: 1 to i_1 , 2 to i_2 , ..., n to i_n , i.e. $\pi(b)(k) = i_k$. Then we write

$$\pi(b) = \begin{pmatrix} 1 & 2 & \dots & n \\ i_1 & i_2 & \dots & i_n \end{pmatrix}.$$

For example the braid b_1 in Figure 1 has the permutation

$$\begin{pmatrix} 1 & 2 & 3 & 4 \\ 2 & 4 & 1 & 3 \end{pmatrix} = (1 \ 2 \ 4 \ 3),$$

where $(1 \ 2 \ 4 \ 3)$ means a cyclic permutation. The braid b_2 in the figure has the permutation $(1 \ 3 \ 5)(2 \ 4)$. We remark that when the closure of b is a k -component link, the braid permutation of b is a product of k disjoint cycles. The length of each cycle is equal to the number of strings of b which make up a component of \hat{b} .

When we choose a (non-empty) subset C of $\{1, \dots, n\}$ whose elements form a subset of the cycles of $\pi(b)$, we can define a *subbraid* b' of b by choosing only strings numbered in C . For subbraids b' and b'' of b one can define the (*strand*) *linking number* $lk(b', b'')$ by the linking number $lk(\hat{b}', \hat{b}'')$ between sublinks of \hat{b} . For example, in b_2 of Figure 1, we have $lk(b'_2, b''_2) = 0$.

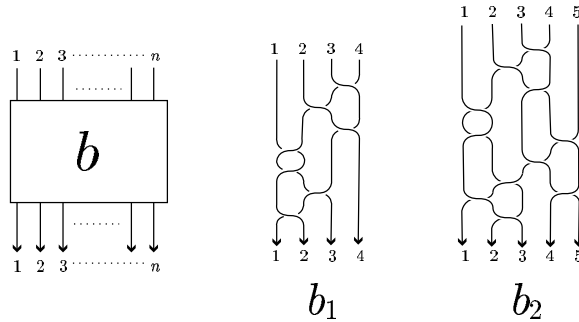

FIGURE 1. An n -braid

2.2. **Exchange moves.** Let

$$\Delta_n^2 = (\sigma_1 \cdot \dots \cdot \sigma_{n-1})^n$$

be the (right-handed) full twist on n strands. The *center* of B_n (elements that commute with all B_n) is infinite cyclic and generated by Δ_n^2 . Let similarly

$$\Delta_{[i,j]}^2 = (\sigma_i \cdot \dots \cdot \sigma_{j-1})^{j-i+1}$$

be the restricted full twist on strands i to j .

We say that $b \in B_n$ admits an exchange move, if b is as illustrated in Figure 2, where $\alpha, \beta \in B_{n-1}$. It makes sense to assume $n > 3$.

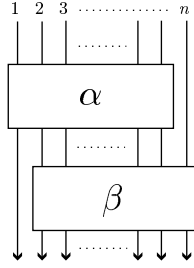

FIGURE 2. The n -braid b .

An *exchange move* [5] is the transformation between the braids b and b_m shown in Figure 3. Here m is some non-zero integer, and the boxes labeled $\pm m$ represent the full twists $\Delta_{[2, n-1]}^{\pm 2m}$ respectively, acting on the middle $n - 2$ strands. (Thus a positive number of full twists are understood to be right full twists, and $-m$ full twists mean m full left-handed twists.)

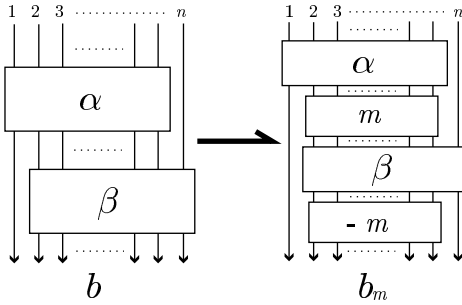

FIGURE 3. The braid b_m

There is another, more common, way to describe the exchange move, namely by

$$(2.1) \quad \alpha\beta \longleftrightarrow \alpha\kappa^m\beta\kappa^{-m}, \quad \text{where } \kappa = (\sigma_1 \cdots \sigma_{n-2})(\sigma_{n-2} \cdots \sigma_1).$$

This description is equivalent to the previous one, because $\kappa \cdot \Delta_{[2, n-1]}^2 = \Delta_{[1, n-1]}^2$, and this element commutes with α .

The exchange move underlies the switch between conjugacy classes with the same closure link, in a universal way.

Theorem 2.2. (Birman-Menasco [5]) *The n -braid representations of a given link decompose into a finite number of classes under the combination of exchange moves and conjugacy.*

2.3. Axis link and Conway polynomial.

Definition 2.3. The *axis (addition) link* of a braid b , denoted by L_b , is the oriented link consisting of the closure of b and an unknotted curve k , the axis of the closed braid, as in Figure 4.

We remark that the axis-addition links of conjugate braids are ambient isotopic. Thus for a proof of non-conjugacy we will study invariants of the axis link. As such an invariant we will employ the

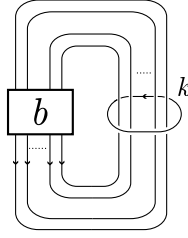

FIGURE 4. The axis-addition link of b

Conway polynomial ∇ . It takes values in $\mathbb{Z}[z]$ and is given by the value 1 on the unknot and the relation

$$(2.2) \quad \nabla(L_+) - \nabla(L_-) = z\nabla(L_0).$$

This relation involves three links with diagrams

$$(2.3) \quad \begin{array}{ccc} \begin{array}{c} \nearrow \searrow \\ \swarrow \nearrow \\ L_+ \end{array} & \begin{array}{c} \nearrow \nearrow \\ \swarrow \swarrow \\ L_- \end{array} & \begin{array}{c} \left. \vphantom{\int} \right) \left(\\ L_0 \end{array} \end{array}$$

differing just at one crossing. They are called a *skein triple*.

We write $[P]_m$ for the coefficient of z^m in $P \in \mathbb{Z}[z]$, and more shortly $a_m = [\nabla]_m$ for the coefficient of z^m in the Conway polynomial.

It is well-known that for an n -component link L , all coefficients of ∇ in z -degree m vanish when $m < n - 1$ or $m + n$ is even.

We denote the *linking number* of two components of L by $lk(\cdot, \cdot)$. Now we recall a formula, given by Hoste [12], which expresses the lowest non-trivial coefficient a_{n-1} of $\nabla(L)$ in terms of component linking numbers.

Theorem 2.4. (see [12]) *Let $L = L_1 \cup \dots \cup L_p$ be a p -component link of components L_1, \dots, L_p . Let $l_{k,m} = lk(L_k, L_m)$. Then the coefficient a_{p-1} of the Conway polynomial in degree $p - 1$ is*

$$(2.4) \quad a_{p-1}(L) = \sum_T \prod_{(k,m) \in T} l_{k,m}.$$

Herein the sum ranges over spanning trees T of the complete graph G on the vertex set $\{1, \dots, p\}$, and (k, m) denotes the edge in G connecting the k -th and m -th vertex.

Proof of corollary 1.2. The ‘only if’ part in corollary 1.2 immediately follows from Theorem 2.2. The ‘if’ part is a consequence of theorem 1.1, because under the assumed conditions of L , whatever braid representation b of L satisfies $\pi(b)(k) \neq k$ for $k = 1, n$. \square

Proof of theorem 1.1. We start now the proof of theorem 1.1, which will extend over several sections until the end of the paper.

In order to exhibit braids b_m in Figure 3 as non-conjugate, we will follow the approach in [21], and evaluate the second coefficient of ∇ on the axis addition link of b . We will show that an exchange move alters this coefficient except in a situation described in the following proposition.

Proposition 2.5. *Let $n \geq 4$, and K be a knot represented as the closure of an n -braid b admitting an exchange move as in Figure 3. Write the braid permutation $\pi(b) = (x_1, x_2, \dots, x_n)$, where we fix the cyclic ambiguity of x_i by letting the cycle end on $x_n = n$. Then, unless $n = 2n' + 1$ (for $n' \in \mathbb{N}$) and $x_{n'+1} = 1$, all links L_{b_m} , for b_m as in Figure 3, are distinguished by a_3 .*

In the next section we will be concerned with proving this proposition. The remaining, and more complicated, cases will be settled in §4 by looking at the axis addition link L_{b^2} of the square of b .

3. PROOF OF PROPOSITION 2.5

First, we give a lemma needed later. A *delta move* is a local move defined in [17], and this move is equivalent to the move in Figure 5. We consider the delta move on the left-hand side in Figure 6, where the dotted arcs show how the strands connect.

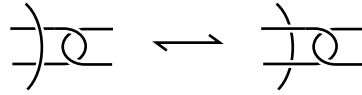

FIGURE 5. A delta move

In a way similar to the proof of Lemma 2.2 in [21] we can prove the following lemma using theorem 2.4. (We remind that the linking number and i -th coefficient of the Conway polynomial are written $lk(\cdot, \cdot)$ and $a_i(\cdot)$, respectively.)

Lemma 3.1. Let L, L' and $l = k_1 \cup k_2 \cup k_3$ be oriented links related by the local moves as in Figure 6. Then $a_3(L) - a_3(L') = lk(k_2, k_3) - lk(k_3, k_1)$.

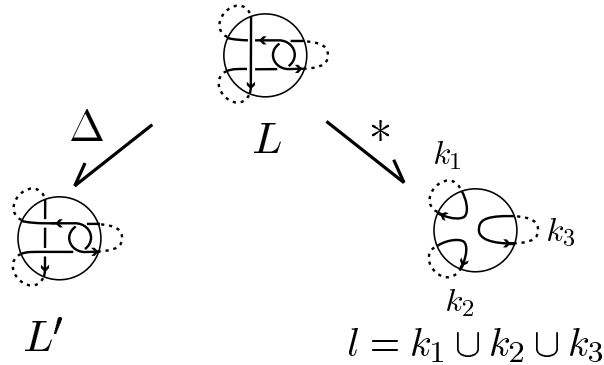

FIGURE 6. Three links related by local moves

Now we are ready to start the proof of the first partial case of Theorem 1.1.

Proof of Proposition 2.5. We set $b_0 = b$. From a braid b , we construct an infinite sequence of braids $\{b_m, m \in \mathbb{Z}\}$ as in Figure 3 where m and $-m$ represent m and $-m$ full twists respectively. The closures

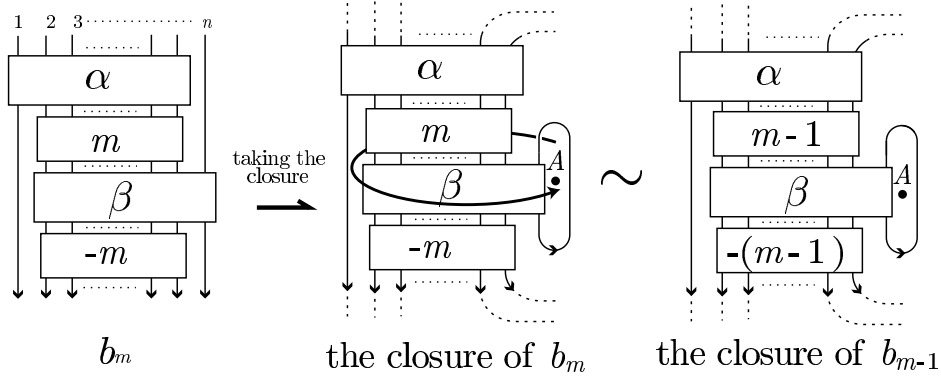

FIGURE 7. Braids with the same closure

of b_m and b_{m-1} ($m \in \mathbb{N}$) are related by ambient isotopy as in Figure 7 where A denotes the braid axis. This means that all braids in the sequence close to K .

Since a full twist of n strings can be deformed as in Figure 8 up to ambient isotopy, the axis addition link L_{b_m} of b_m , which is the leftmost diagram in Figure 9, can be deformed into the rightmost link in the figure, still denoted by L_{b_m} . Here k is the component corresponding to the braid axis and the boxes m and $-m$ represent m -full twists and $-m$ -full twists respectively.

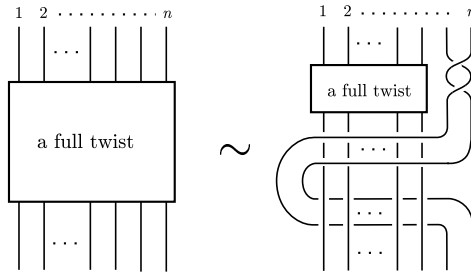

FIGURE 8. A full twist of n -strings

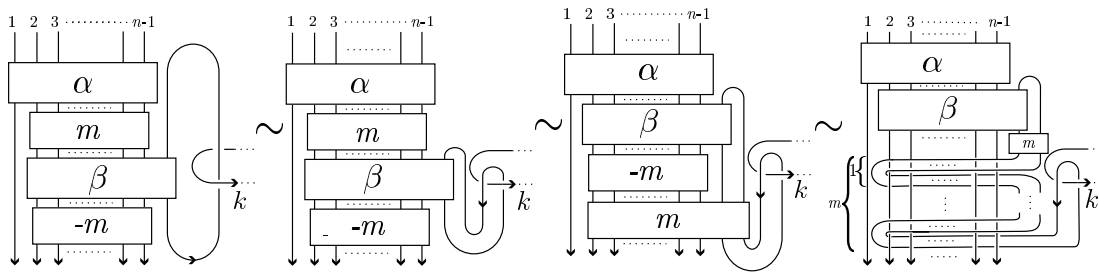

FIGURE 9. L_{b_m}

Then there are sequences of links $L_{b_m} = L^0, L^1, L^2, \dots, L^{n-1} = L_{b_{m-1}}$ and $l^0, l^1, l^2, \dots, l^{n-1}$ such that L^{i+1} and l^i are obtained from L^i by the delta move Δ_i and the move $*_i$ illustrated in Figure 10 ($i = 0$)

and 11 ($i = 1, \dots, n - 2$). By Lemma 3.1, the change in a_3 resulting from Δ_0 can be obtained as follows:

$$a_3(L^1) - a_3(L^0) = lk(l_1^0 \cup l_3^0) - lk(l_2^0 \cup l_3^0) = n - 1,$$

where $l^0 = l_1^0 \cup l_2^0 \cup l_3^0$ is the 3-component link illustrated in Figure 10.

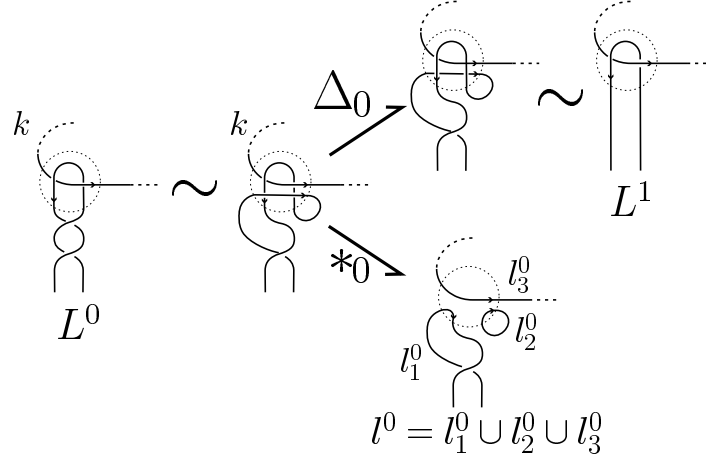

FIGURE 10. The moves Δ_0 and $*_0$

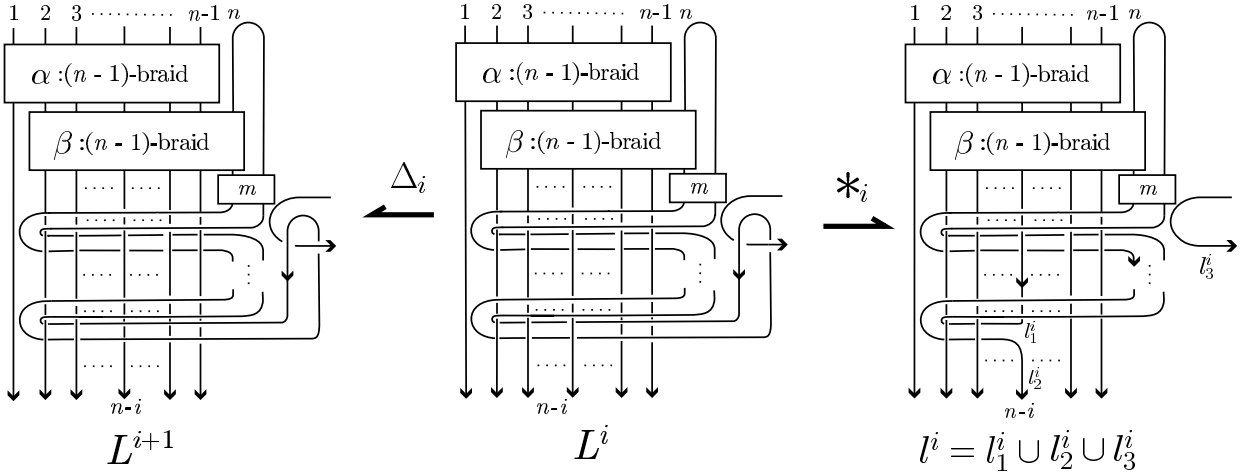

FIGURE 11. The local moves on L^i

Next we consider the change in a_3 resulting from Δ_i illustrated in the Figure 11 ($i = 1, 2, \dots, n - 2$). Let S_{L^i} (resp. S_{l^i}) be a part of L^i (resp. l^i) as in the left (resp. right) diagram of Figure 12. Namely S_{L^i} and S_{l^i} are the unions of n strings and an unknotted component. Some of these $(n - 1)$ strings of S_{l^i} belong to l_1^i and the other belong to l_2^i . The numbers of strings determine $lk(l_1^i \cup l_3^i)$ and $lk(l_2^i \cup l_3^i)$.

By considering how $S_{l^i} - l_3^i$ has its strings connected, permutations of the n down going strings can be assigned to S_{L^i} and S_{l^i} , similarly to a braid permutation. We call these the permutations of S_{L^i} and

S_{L^i} . Note that the permutation assigned to S_{L^i} is the same as the braid permutation $\pi(b)$ of b . Since $l^i - l_3^i$ is a 2 component link, the permutation of S_{L^i} consists of 2 cycles. To determine the length of these cycles, we observe that the move $*_i$ corresponds to taking the product of a transposition $(n-i, n)$ with the permutation of S_{L^i} .

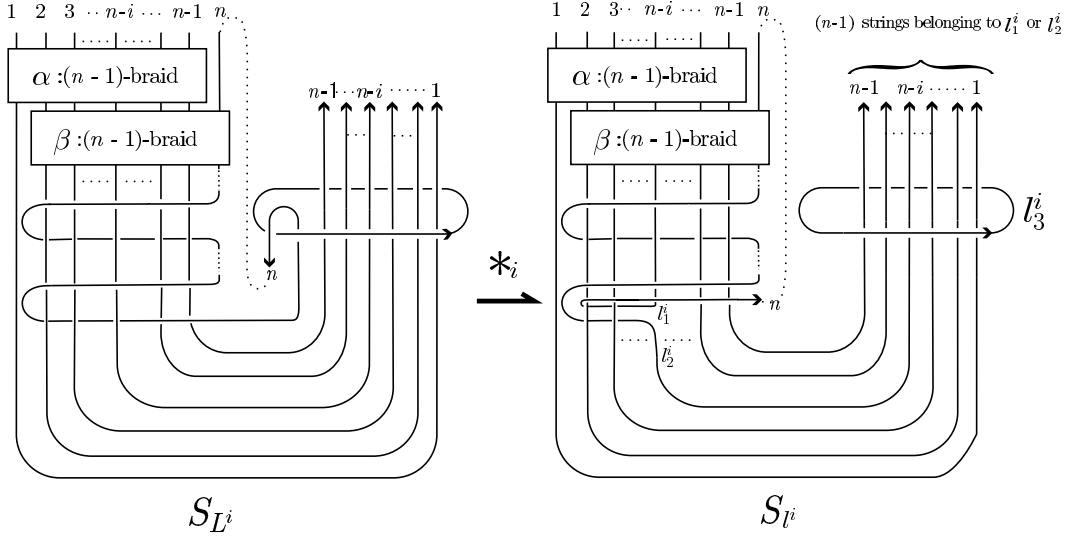

FIGURE 12.

Let $n-i = x_j$. Then

$$(x_j, n)(x_1, x_2, \dots, x_{n-1}, n) = (x_1, x_2, \dots, x_{j-1}, n)(x_j, \dots, x_{n-2}, x_{n-1}).$$

The cyclic permutations $(x_1, x_2, \dots, x_{j-1}, n)$ and $(x_j, \dots, x_{n-2}, x_{n-1})$ correspond to l_1^i and l_2^i , respectively. Remark that the string of S_{L^i} with lower end point n belongs to l_1^i , and it does not contribute now to $lk(l_1^i \cup l_3^i)$. By Lemma 3.1,

$$\begin{aligned} a_3(L^i) - a_3(L^{i-1}) &= lk(l_1^i \cup l_3^i) - lk(l_2^i \cup l_3^i) \\ &= (j-1) - (n-j) = 2j - n - 1. \end{aligned}$$

Suppose that $x_l = 1$, then

$$\begin{aligned} a_3(L_{b_{m+1}}) - a_3(L_{b_m}) &= \{\text{the change in } a_3 \text{ resulting from } \Delta_0\} \\ &\quad + \sum_{k=1}^{n-2} \{\text{the change in } a_3 \text{ resulting from } \Delta_k\} \\ &= (n-1) + \sum_{j=1}^{n-1} (2j - n - 1) - (2l - n - 1) = -2l + n + 1. \end{aligned}$$

The difference $-2l + n + 1$ is a constant which does not depend on m . If it is non-zero, the sequence $\{a_3(L_{b_p}), p \in \mathbb{N}\}$ forms an arithmetic progression with non zero common difference. When n is even, $-2l + n + 1$ is odd. This means that $-2l + n + 1 \neq 0$. When n is odd, namely $n = 2n' + 1$ for some

$n' \in \mathbb{N}$, then $-2l + n + 1 = 2(n' - l + 1)$. Unless $l = n' + 1$, we have $-2l + n + 1 \neq 0$. The equation $l = n' + 1$ means that $x_{n'+1} = 1$. Therefore $a_3(L_{b_{m+1}}) - a_3(L_{b_m})$ is non-zero and independent of m , unless $n = 2n' + 1$ ($n' \in \mathbb{N}$) and $x_{n'+1} = 1$. This completes the proof of Proposition 2.5. \square

4. REMAINING KNOT CASES

From now on we assume that $n = 2n' + 1$ and $\pi(b) = (x_1, x_2, \dots, x_{n-1}, n)$ with $x_{n'+1} = 1$. To prove that b_m are non-conjugate, we will look at b_m^2 : if two braids are conjugate, so are their squares. Note that, when n is odd and $\pi(b)$ is a cycle, so is $\pi(b^2)$. Thus $L_{b_m^2}$ are again 2-component links. We will show the following:

Proposition 4.1. *Let b be an n -braid admitting an exchange move. If $n = 2n' + 1 > 3$ odd and $\pi(b) = (x_1, x_2, \dots, x_{n-1}, n)$ with $x_{n'+1} = 1$, then $a_3(L_{b_m^2})$ is a quadratic polynomial in m with non-zero quadratic term.*

In particular, there are at most two $L_{b_m^2}$ with equal a_3 , and so at most two of b_m are conjugate. Thus with proposition 4.1, the proof of theorem 1.1 for knots will be complete.

Proof of proposition 4.1. Let us first simplify the form of α and β in Figure 2.

First, every permutation of $2, \dots, n-1$ applied on either side of $\pi(\alpha)$ can be realized by a braid which can be moved into β . Thus we can achieve that $\pi(\alpha) = (1, 2)$. So

$$(4.1) \quad \alpha = \alpha' \cdot \sigma_1^{-1}$$

for some pure braid α' on strands $1, \dots, n-1$.

Then $\pi(\beta) = (x'_1, x'_2, \dots, x'_{n-2}, n)$ is a cycle with $x'_{n'} = 2$ and $n > x'_j > 2$ otherwise. Now, any permutation of these $x'_j \neq 2, n$ can be realized by conjugating β with a permutation of $3, \dots, n-1$. Since we achieved that $\pi(\alpha)$ fixes all of these, the permutation of $x'_j \neq 2, n$ in $\pi(\beta)$ can be achieved by a conjugation of $b = \alpha \cdot \beta$, at the cost of multiplying α by some pure braid on strands $1, \dots, n-1$, which we can absorb into α' of (4.1).

This means that we can assume that we can write

$$\beta = \beta' \cdot \beta_0,$$

for some pure braid β' on strands $2, \dots, n$, as long as β_0 is a braid on strands $2, \dots, n$ with $\pi(\beta)$ being a cycle with $x'_{n'} = 2$ when $x'_{n-1} = n$. In the following we will choose and fix

$$\beta_0 = \sigma_3^{-1} \sigma_5^{-1} \cdot \dots \cdot \sigma_{n-2}^{-1} \cdot \sigma_2^{-1} \sigma_4^{-1} \cdot \dots \cdot \sigma_{n-1}^{-1}.$$

Lemma 4.2. We have $a_3(L_{b_m^2}) - a_3(L_{b^2}) = Am^2 + Bm + C$ for some (rational) numbers A, B, C (depending, *a priori*, on n and b). Moreover, A does not depend on the braids α', β' in the presentation

$$(4.2) \quad b = \alpha' \cdot \sigma_1^{-1} \cdot \beta' \cdot \beta_0.$$

Proof. The axis link of $L_{b_m^2}$ can be simplified similarly to Figure 9. In this case we involve the up going strand also on the left of b . Now we can cancel the full twists on $n - 2$ strands in b_m^2 by creating pairs of bands that circle, in the opposite way, around the middle $n - 2$ strands. See Figure 13. It shows the case $n = 7$ and $m = 1$. (One of the pairs of circling bands, the one at the bottom, untangles, so we have 3 such pairs.) We indicate the braids α' and β' just by a dashed line, showing where they have to be inserted.

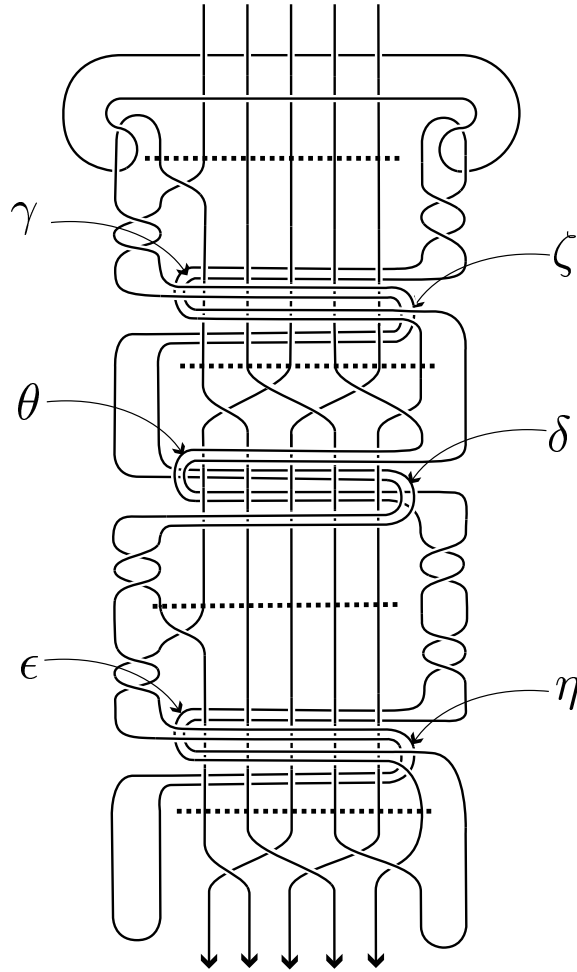
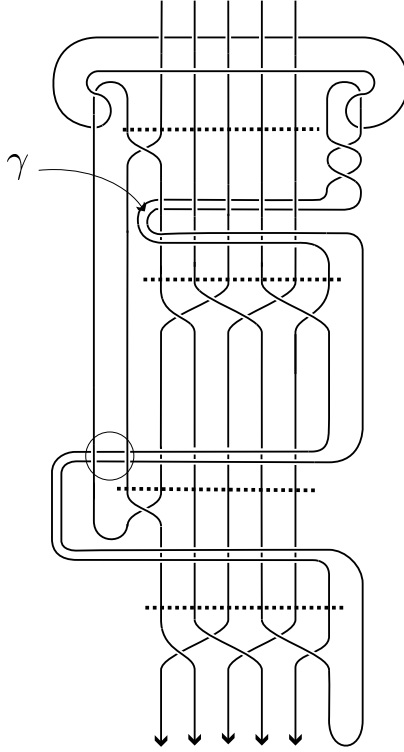

FIGURE 13. $L_{b_m^2}$ (for $m = 1$)

Now the bands δ and ζ cancel, and η trivializes. Then, θ and ϵ cancel by a half-turn (and all their internal twists cancel), but to cancel them further, we need to move the band past $\delta\zeta$ in the encircled region of Figure 14. (For general m , the parts δ and ζ will have $|m| - 1$ full turns of the band around the other $n - 2$ strings in the opposite direction.

Next, γ can be deleted at the cost of changing a_3 by a quantity linear in m (whose linear terms may depend on n , α' and β'). This can be seen from lemma 3.1, in the way we applied it in §3. It must be realized that, in spite of the bands δ and ζ in the lower part of the figure, the linking number of l_1^i and

FIGURE 14. Simplified $L_{b_m^2}$ (for $m = 1$)

l_2^i with l_3^i does not depend on m . Thus the change of a_3 under undoing one full twist of γ does not depend on m either.

This means that, for the purpose of proving lemma 4.2, we can disregard the band γ , and so we assume that it is trivial. Then we obtain from $L_{b_m^2}$ the links K_m as shown (for $m = 1$ and $n = 7$) in Figure 15.

Using the relation (2.2), we can write

$$(4.3) \quad a_3(K_{m+1}) - a_3(K_m) = a_2(L_1) - a_2(L_2) - a_2(L_3) + a_2(L_4),$$

where $L_i = L_{m,i}$ are 3-component links obtained from K_{m+1} by changing some and smoothing exactly one of the 4 crossings in the encircled part.

Now, it is easy to observe that among the 3 linking numbers between the components of each L_i , only one (the one not involving the braid axis) depends, linearly, on m (a dependence which holds for either signs of m), and α' and β' affect all 3 linking numbers only by some additive constant.

It follows then from theorem 2.4 that $a_3(K_{m+1}) - a_3(K_m)$ is a linear expression in m with a linear term independent on α' and β' . By inductive iteration, we obtain the claim of lemma 4.2. \square

With lemma 4.2, for the proof of proposition 4.1, it is legitimate to assume that α' and β' are trivial, and (4.2) becomes

$$\beta_0 = \sigma_1^{-1} \sigma_3^{-1} \cdots \sigma_{n-2}^{-1} \cdot \sigma_2^{-1} \sigma_4^{-1} \cdots \sigma_{n-1}^{-1}.$$

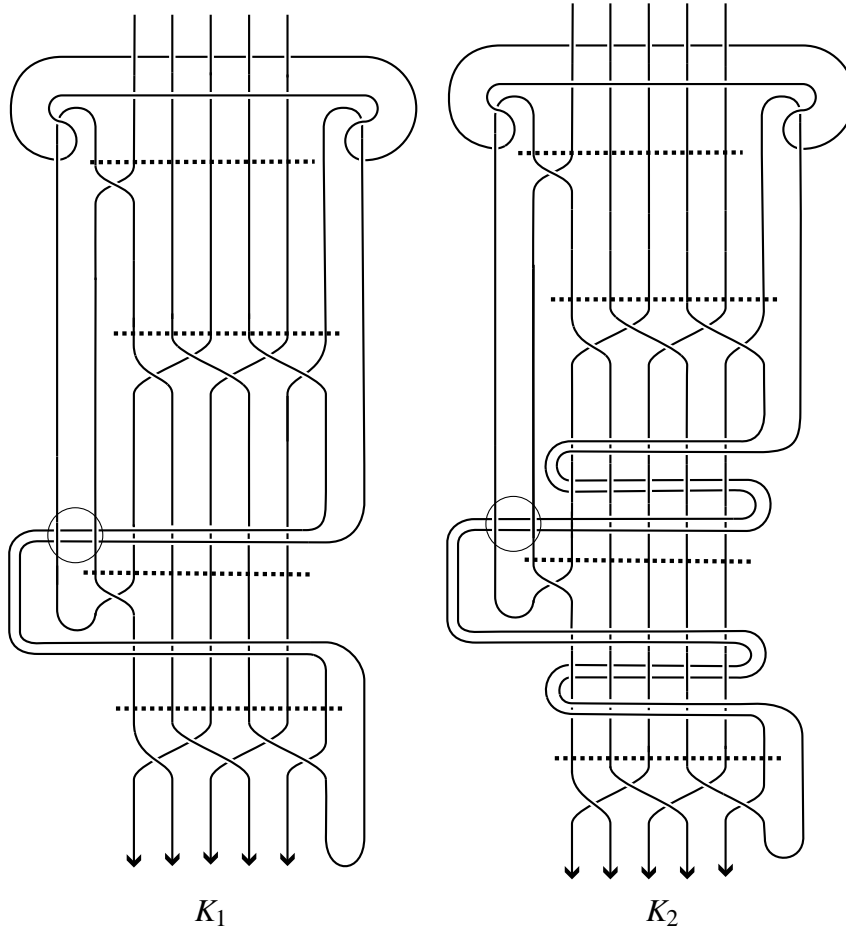

FIGURE 15. K_m

It is not difficult to evaluate the quadratic coefficient A in the lemma for this special case.

Now,

$$2A = a_3(K_1) + a_3(K_{-1}) - 2a_3(K_0),$$

and so it is enough to show that the r.h.s. of this equation, call it D_n , does not vanish for any odd $n \geq 5$.

Again, one can express $a_3(K_1) - a_3(K_0)$ and $a_3(K_0) - a_3(K_{-1})$ using (4.3). Next, observe that, essentially because the action of $\pi(b^2)$ on intermediate strands is to shift by 4 to left or right, the replacement of any odd $n \geq 5$ by $n + 4k$ alters the component linking numbers of the links L_i in (4.3) by multiples of k .

It follows then that D_{n+4k} is a certain quadratic expression in $k \geq 0$ for $n = 5$ and $n = 7$. To determine these expressions, one can make a direct calculation using (4.3) and theorem 2.4. This is, however, somewhat tedious and error-prone. Thus we used also a different method for verification.

We drew, as in Figure 16, the links $K_{\pm 1}$ and K_0 for $k = 0, 1, 2$ in either case (i.e. $n = 5, 7, \dots, 15$), and calculated $c_i = a_3(K_i)$ by computer.

The most complicated diagrams have 118 crossings, but it took a total of 10.5 seconds to evaluate a_3 on all 18 diagrams using the skein polynomial truncation algorithm of [25]. The result is shown

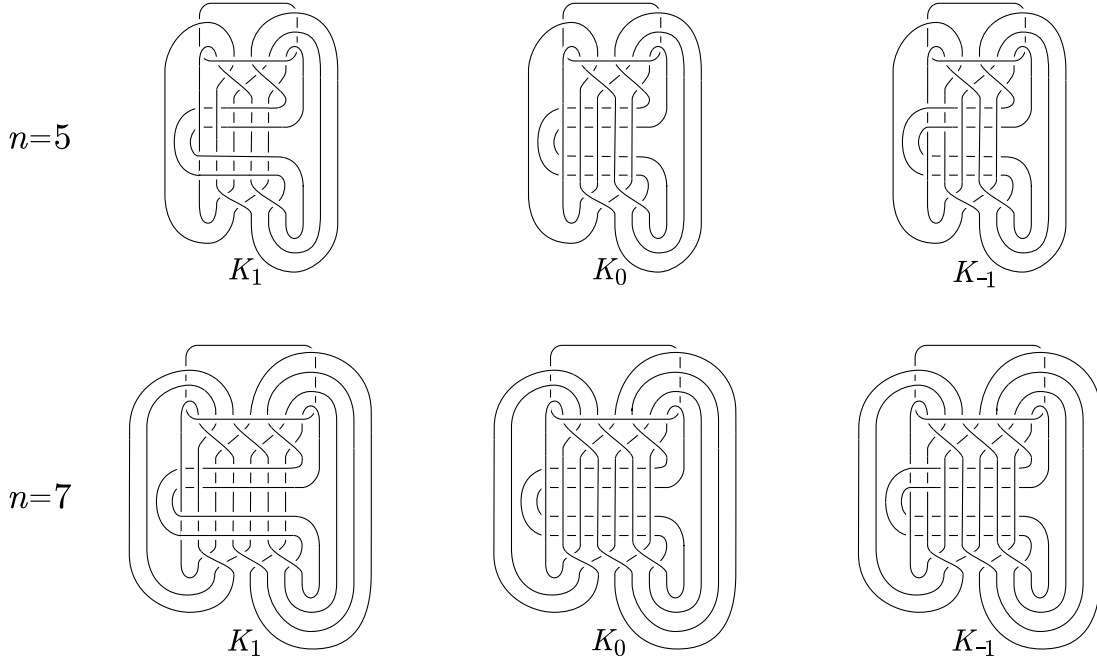
FIGURE 16. K_m for $|m| \leq 1$ and $n = 5, 7$

below:

n	5	9	13	7	11	15
c_1	-13	-38	-59	38	137	312
c_0	5	30	91	14	55	140
c_{-1}	-17	-46	-71	46	149	328

From this one determines that

$$D_n = \begin{cases} -40 - 72k - 32k^2 & \text{if } n = 5 + 4k \\ 56 + 88k + 32k^2 & \text{if } n = 7 + 4k \end{cases}.$$

This is never zero for any $k \geq 0$. (It vanishes, however, for $k = -1$, which is in nice accordance with the triviality of the cases $n = 1, 3$.) With this the proof of proposition 4.1, and therefore also of theorem 1.1 for knots, is concluded. \square

5. THE FIRST CASE OF LINKS

We now move to the case of links in theorem 1.1. A few of the links can be dealt with by a sublink argument, but the situation seems more complicated in general. We split the treatment of links into two major cases, depending on whether 1 and n belong to the same or to distinct cycles of $\pi(b)$.

Theorem 5.1. *Assume a braid $b \in B_n$ admits an exchange move, and 1 and n belong to the same cycle of $\pi(b)$. Then the link \hat{b} has infinitely many non-conjugate n -braid representations.*

The following is an analogue of lemma 3.1.

Lemma 5.2. Let $a_{[k]}(L) = a_{n(L)+k}(L)$, with $n(L)$ being the number of components of L . We have then

$$a_{[1]} \left(\left(\text{Diagram 1} \right) \right) = a_{[1]} \left(\left(\text{Diagram 2} \right) \right),$$

where we allow further components to be placed (entirely) outside the encircled spot.

Proof. By switching the negative crossings on the strands in the tangle on either side, we see that the claimed equality is equivalent to

$$a_{[1]} \left(\left(\text{Diagram 3} \right) \right) = a_{[1]} \left(\left(\text{Diagram 4} \right) \right).$$

By switching one positive crossing in the clasp on either side, we see that this is in turn equivalent to

$$a_{[-1]} \left(\left(\text{Diagram 5} \right) \right) = a_{[-1]} \left(\left(\text{Diagram 6} \right) \right).$$

This now follows from theorem 2.4, since the linking numbers of all components are the same on either side. \square

Proof of theorem 5.1. It is easy to see from the shape in Figure 2 that the cycle C of $\pi(b)$ containing 1 and n cannot be a transposition. If it is has length > 3 , then looking at a sublink of L_{b_m} or $L_{b_m^2}$ and using the argument in the proof of theorem 1.1 for knots, we are done. So assume that C is of length 3.

We will choose a subbraid of b by taking the strands corresponding to elements in C and one other cycle of $\pi(b)$. We can choose this cycle C' arbitrarily, and forget about the other components of \hat{b} . It is enough to show that the so constructed b_m are non-conjugate.

One can see with the help of lemma 5.2 that a_4 will not be helpful in distinguishing L_{b_m} , and we turn to $L_{b_m^2}$. Now, in the case of n odd, C' is an even (length) cycle, and we choose again one of the two components in the closure of the subbraid b'^2 of b^2 whose permutation is C'^2 . This requires to treat the cases n even and odd with a little difference. Let K' be the component of \hat{b}'^2 for n even, or the one chosen component for n odd. And let $L'_{b_m^2}$ be the result of deleting the one component in $L'_{b_m^2}$ for n odd and $L_{b_m^2}$ for n even.

We then use the argument in the proof of proposition 4.1, which must be modified followingly.

Similarly to (4.2), we can achieve the form

$$(5.1) \quad b = \alpha' \cdot \sigma_1 \cdot \beta' \cdot \beta_0,$$

with β_0 being now a ‘band braid’ between strands 2 and n

$$(5.2) \quad \beta_0 = \sigma_2 \cdots \sigma_{n-2} \cdot \sigma_{n-1} \cdot \sigma_{n-2}^{-1} \cdots \sigma_2^{-1}.$$

Next, the bands of $L'_{b'_m}$ can be eliminated and ignored (for γ now with the additional help of lemma 5.2) as before, except that the band switch between $\theta\epsilon$ and $\delta\zeta$ in Figure 14 requires a more careful analysis.

Now the links L_1 to L_4 (for fixed m) on the right of (4.3) have 4 components (and indices of a_* have shifted up by one). Let (for fixed m and i) K_1 and K_2 be the components of L_i at the smoothed crossing, K_0 be the axis, and $K_3 = K'$ the other component (coming from the second cycle in $\pi(b)$). Then the graph of linking numbers of L_i looks like:

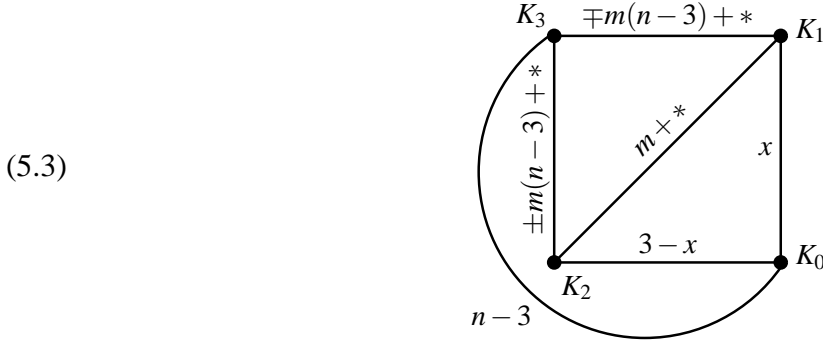

Herein $0 \leq x \leq 3$ is independent on m and n , and ‘*’ means a (possibly different at every occurrence) term of the sort

$$\alpha_0 + \sum_{k=1}^6 \alpha_k \lambda_k,$$

where α_i are independent on m and n , and λ_i are certain linking numbers in α' and β' , which we will specify shortly.

Let s_1, s_2, s_n be the strands 1, 2, n in b in the parts which enter in α' and β' .

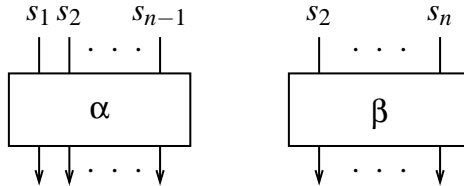

(That is, the strand numbering is given at the place of α' and β' , and s_2 in α' and β' may be different strands of b .) There are 6 types of linking numbers referred to above:

$$\begin{aligned} \lambda_1 &:= lk(s_1, K') \text{ in } \alpha', & \lambda_2 &:= lk(s_1, s_2) \text{ in } \alpha', & \lambda_3 &:= lk(s_2, K') \text{ in } \alpha', \\ \lambda_4 &:= lk(s_2, K') \text{ in } \beta', & \lambda_5 &:= lk(s_n, K') \text{ in } \beta', & \lambda_6 &:= lk(s_2, s_n) \text{ in } \beta'. \end{aligned}$$

Here K' means the strands of b closing to K' in the parts within α' and β' , and the linking number is as explained in §2.1.

One can easily conclude from (5.3), and because the signs of $a_3(L_i)$ on the right of (4.3) are opposite in pairs, that $a_4(L'_{b'_m}) - a_4(L'_{b_2})$ for fixed n , α' and β' is a quadratic polynomial in m , with a quadratic term of the form

$$\sum_{j=0}^2 \left(\alpha_{j,0} + \sum_{k=1}^6 \alpha_{j,k} \lambda_k \right) n^j,$$

where $\alpha_{j,k}$ do not depend on m and n .

One can determine $\alpha_{j,k}$ by explicit calculation of $a_4(L'_{b_m})$ for small n and m . We have to distinguish between even and odd n . We have then to realize seven 6-tuples $(\lambda_k)_{k=1}^6 = (\delta_{k,l})_{k=1}^6$ (with Kronecker's delta) for $l = 0, \dots, 6$ by simple braids α' and β' , and for n odd take care how the component deletion between L_{b_m} and L'_{b_m} affects these braids (the result is no longer always a braid square).

We need to take 3 different n of either parity, and $|m| \leq 1$, but we calculated many additional links for consistency checks. The outcome of this calculation is, with $\lambda := \lambda_1 + \lambda_3 + \lambda_4 + \lambda_5$,

$$(5.4) \quad [a_4(L'_{b_m})]_{m^2} = \begin{cases} 2(k+1)^2 + (4+5k+k^2)\lambda & \text{if } n = 5+2k \\ 2(2k+1)^2 + (8+20k+8k^2)\lambda & \text{if } n = 4+2k \end{cases}.$$

Now we are done, unless this term becomes zero for some integer value of λ . (By asymptotics, this cannot occur for large n , but it does occur for $n = 9$.)

To get disposed of these final cases, we consider the mirrored braids of b_m . (Or alternatively, we reverse the orientation of the braid axis.) This mirrors the braids α' and β' , but up to a correction factor needed to restore the shape (5.1) with β_0 in (5.2). In total, mirroring b changes λ_i to $c_i - \lambda_i$, where $c_1 = c_3 = 0$, $c_2 = c_5 = c_6 = -1$ and $c_4 = 1$. (The c_i are the linking numbers of the strands within these correction factors.) Therefore, λ just changes sign.

Now for either mirroring (or orientations of the braid axis) the expression in (5.4) vanishes, only if the absolute term in λ does so. But this is clearly never the case. Thus up to mirroring we achieve the desired distinction, and the proof is concluded. \square

6. THE SECOND CASE OF LINKS

The situation when 1 and n belong to distinct cycles of $\pi(b)$ is the final case needed to complete the proof of theorem 1.1.

Theorem 6.1. *Let $b \in B_n$ admit an exchange move, and let 1 and n belong to distinct non-trivial cycles of $\pi(b)$. Then infinitely many of the b_m are non-conjugate.*

Proof. Let n_1 be the length of the cycle of $\pi(b)$ containing 1, and n_2 the length of the cycle containing n .

By a sublink argument, and by adjusting the permutations of the cycles involving 1 and n , it is enough to consider b in Figure 2, where α, β are given by

$$(6.1) \quad \alpha = \sigma_1 \cdots \sigma_{n_1-1} \cdot \alpha' \quad \text{and} \quad \beta = \sigma_{n_1+1} \cdots \sigma_{n-1} \cdot \beta',$$

and α' and β' are pure braids. In particular, $n_1 + n_2 = n$, that is, $\pi(b)$ has only the two relevant cycles.

We will evaluate $a_4(L_{b_m})$ for fixed α and β as a (polynomial) function in m . (Note that L_{b_m} is a 3-component link.) Let us from the outset take the attitude that the linear and absolute term in m are irrelevant.

Throughout the treatment of this final case, we use the description of the exchange move in (2.1).

Lemma 6.2. The function $m \mapsto a_4(L_{b_m})$ is a cubic polynomial in m . The cubic term does not depend on α, β . The quadratic term depends on α, β only via linear combinations of linking numbers of strands in α', β' .

Proof. It is enough to work with $m > 0$. Otherwise we can multiply α and β by a proper power of κ . The argument we give below for $m > 0$ applied on the modified α and β will give the result for the original α and β for $m > -k$, where k can be chosen arbitrarily. Thus the property holds then for all integers m .

We describe a method for doing a recursive skein calculation of $a_4(L_{b_m})$, which will be relevant also after the proof of the lemma. This calculation will be crucial throughout the treatment, and we will gradually refine it.

We consider $a_4(L_{b_m}) - a_4(L_{b_{m-1}})$, where by (2.1)

$$b_m = \alpha \kappa^m \beta \kappa^{-m}.$$

Now we can write

$$(6.2) \quad \begin{aligned} b_m &= \alpha \kappa^{m-1} (\sigma_1 \cdots \sigma_{n-2} \sigma_{n-1}) (\underline{\sigma_{n-1}^{-1}} \sigma_{n-2} \cdots \sigma_1) \beta \\ &= (\sigma_1^{-1} \cdots \sigma_{n-2}^{-1} \sigma_{n-1}^{-1}) (\underline{\sigma_{n-1}} \sigma_{n-2} \cdots \sigma_1) \kappa^{1-m}. \end{aligned}$$

Then we have by the skein relation (2.3)

$$(6.3) \quad a_4(L_{b_m}) - a_4(L_{b_{m-1}}) = -a_3(L_{m-1,1}) + a_3(L_{m-1,2}),$$

where $L_{m-1,i}$ is the axis link of the braid obtained from the word on the right of (6.2) by omitting the underlined occurrences of σ_{n-1}^{-1} resp. σ_{n-1} . Let us write $[b]$ for L_b . Then

$$(6.4) \quad \begin{aligned} L_{m,1} &= [\alpha \kappa^m (\sigma_1 \cdots \sigma_{n-2} \sigma_{n-1}) (\sigma_{n-2} \cdots \sigma_1) \beta \\ &\quad (\sigma_1^{-1} \cdots \sigma_{n-2}^{-1} \sigma_{n-1}^{-1}) (\sigma_{n-1} \sigma_{n-2} \cdots \sigma_1) \kappa^{-m}]. \end{aligned}$$

$$(6.5) \quad \begin{aligned} L_{m,2} &= [\alpha \kappa^m (\sigma_1 \cdots \sigma_{n-2} \sigma_{n-1}) (\sigma_{n-1} \sigma_{n-2} \cdots \sigma_1) \beta \\ &\quad (\sigma_1^{-1} \cdots \sigma_{n-2}^{-1} \sigma_{n-1}^{-1}) (\sigma_{n-2} \cdots \sigma_1) \kappa^{-m}]. \end{aligned}$$

The complication now is that the links $L_{m,1}$ have two components. We need to apply the skein relation once more before we can use Hoste's formula.

We will calculate instead of $a_3(L_{m-1,i})$ the difference

$$(6.6) \quad a_3(L_{m-1,i}) - a_3(L_{0,i}).$$

The extra terms $a_3(L_{0,i})$ contribute only something absolute in m to $a_4(L_{b_m}) - a_4(L_{b_{m-1}})$, and hence only something linear in m to $a_4(L_{b_m})$, which we decided to ignore.

It is clear that one can determine (6.6) by evaluating

$$a_3(L_{m,i}) - a_3(L_{m-1,i}).$$

For this we turn around two groups of $n-2$ crossings, namely those needed to trivialize the last of the m copies of κ before β in (6.2) (note that we shifted $m-1$ to m) and the first of the m copies of κ^{-1} after β . We obtain

$$(6.7) \quad a_3(L_{m,i}) - a_3(L_{m-1,i}) = \sum_{l=2}^{n-1} a_2(L_{m,i,l}) - a_2(L_{m,i,\bar{l}}).$$

The link $L_{m,i,l}$ is the axis link of the braid obtained from the braid in (6.4) (for $i = 1$) or (6.5) (for $i = 2$) by replacing the last copy of κ before β by

$$(6.8) \quad \sigma_1 \dots \sigma_{l-2} \sigma_{l-1} \sigma_{l-2} \dots \sigma_1,$$

and $L_{m,i,\bar{l}}$ is the axis link of the braid obtained from the braid in (6.4) resp. (6.5) by replacing the first copy of κ^{-1} after β by the inverse of the braid in (6.8).

Now $L_{m,i,l}$ and $L_{m,i,\bar{l}}$ have three components, and their a_2 can be evaluated by Hoste's formula.

Two of the linking numbers of the components of $L_{m,i,l}$ and $L_{m,i,\bar{l}}$ are independent of m , and the third one is linear in m , with linear term independent of α' , β' . From this the claim of the lemma follows. \square

Lemma 6.3. In the function $m \mapsto a_4(L_{b_m})$ of lemma 6.2, the cubic term vanishes.

Proof. By lemma 6.2, it is enough to prove this when α' and β' are trivial. Under this assumption, we claim the following:

$$(6.9) \quad L_{b_m} \simeq L_{b_{-m}}$$

up to switching orientation (of *all* components simultaneously). With (6.9) the lemma follows, since the function given there is even.

To see (6.9), note that

$$\alpha = \sigma_1 \dots \sigma_{n_1-1}$$

can be conjugated to its word-reverse *without using* σ_1 and σ_{n_1-1} , and similarly β . Then κ commutes with the subgroup generated by $\sigma_2, \dots, \sigma_{n_1-2}$. After α and β were reversed, flip the braid axis link by π along the horizontal axis in projection plane, conjugate by α to move it to the top, and reverse all orientations (including of the axis) to have strands pointing downward. \square

We thus now are led to look at $[a_3(L_{b_m})]_{m^2}$, and our goal is to prove that it does not vanish. The skein calculation in the proof of lemma 6.2 would be unwieldy. However, we help ourselves again by taking also the mirrored braids into account.

Let \bar{b} be b where all σ_i and σ_i^{-1} are interchanged. Mirroring is an automorphism of B_n , so if two braids are conjugate, so are their mirror images. We will thus complete the proof of theorem 6.1, and hence also of theorem 1.1, by the following lemma.

Lemma 6.4. We have

$$[a_4(L_{b_m})]_{m^2} + [a_4(L_{\bar{b}_m})]_{m^2} = 2(n_1 - 1)(n_2 - 1).$$

Proof. By lemma 6.2 we have that

$$[a_4(L_{b_m})]_{m^2}$$

depends only linearly on the linking numbers of α' and β' . Now, changing a linking number in α' for the representation (6.1) of α changes this linking number oppositely in the representation of $\bar{\alpha}$. We see again that the expression

$$(6.10) \quad [a_4(L_{b_m})]_{m^2} + [a_4(L_{\bar{b}_m})]_{m^2}$$

does not depend on α and β . We will thus evaluate it when α and β are trivial.

We have by (6.9) then

$$(6.11) \quad L_{\bar{b}_m} = L_{\bar{b}_{-m}} = L_{\overline{b_m}}.$$

Now we will follow the skein calculation of the proof of lemma 6.2, simultaneously for b_m and $\overline{b_m}$. In order to distinguish the links occurring in the calculations for b_m and $\overline{b_m}$, we will write in the latter case \bar{L}_{\dots} , with the proper subscript, for what would have been L_{\dots} in the case of b_m .

The skein calculation could be summarized by saying that we expressed $a_4(L_{b_m}) - a_4(L_{b_{m-1}})$ by a linear combination of terms

$$(6.12) \quad a_2(L_{m',i,l}) \quad \text{and} \quad a_2(L_{m',i,\bar{l}})$$

for $i = 1, 2$; $0 \leq m' < m$; and $2 \leq l \leq n - 1$, up to absolute terms in m . If we sum this up to express $a_4(L_{b_m})$, then we have something linear in m , and then for each of the 4 families in (6.12):

$$(6.13) \quad (1) = L_{m',1,\bar{l}}, \quad (2) = L_{m',2,l}, \quad (3) = L_{m',2,\bar{l}}, \quad (4) = L_{m',1,l}$$

(determined by the choice $i = 1, 2$ and between l and \bar{l}), there are

$$(6.14) \quad \frac{m^2}{2} + O(m)$$

terms.

Then each of the terms

$$a_2(\bar{L}_{m',i,l}) \quad \text{and} \quad a_2(\bar{L}_{m',i,\bar{l}})$$

enters into the skein calculation for $\overline{b_m}$ with the same sign as does its analogue in (6.12) for the calculation for b_m . This is because every time a crossing is smoothed out, the sign changes between b_m and $\overline{b_m}$, but to get (6.12) we smoothed out two crossings in b_m resp. $\overline{b_m}$. Combining the signs in (6.3) and (6.7), we see that the signs of families (1) and (2) in (6.13) are positive, for families (3) and (4) negative.

Now, the component linking numbers of $\bar{L}_{m',i,l}$ with the axis are the same as for $L_{m',i,l}$, and the remaining one linking number is opposite.

By Hoste's formula, it becomes clear that one half of (6.10) can be evaluated by doing again the skein calculation for b_m only, and therein replacing $a_3(L_{\dots})$ by

$$(6.15) \quad \langle \pi(b_{\dots}) \rangle,$$

where b_{\dots} is the braid whose axis link is L_{\dots} , and $\langle \sigma \rangle$ is the product of the (here always two) cycle lengths of σ .

Now this simplifies the calculation considerably. Note first that $\langle \pi(b_{\dots}) \rangle$ does not depend on m or m' . Thus we can evaluate all four families in (6.13) just by looking at their permutations. We have then to divide by 2 following (6.14) to get the m^2 -term. This can be compensated by the factor 2 explained in the application of Hoste's formula above (6.15).

From here there are two ways to get done. A "philosophical" way is to observe that by the skein calculation, the expression (6.10) must be some polynomial in n_1 and n_2 . By using that L_{b_m} has $O(m(n_1 + n_2))$ crossings, that a_4 is a Vassiliev invariant of degree 4, and the extension of the Lin-Wang

conjecture to links in [26], we can conclude that the polynomial is of degree at most 4. Moreover, the triviality of the cases $n_i = 1$ explains the factor $(n_1 - 1)(n_2 - 1)$. The polynomial must also be symmetric in n_1 and n_2 . From this one can get the formula in the lemma by calculating the value of the polynomial for a few explicit (n_1, n_2) . (In the realm of ascertaining the result, we did a few such checks which, via this argument, would establish the formula alternatively.)

Nevertheless, it is possible to make exact calculation. Now let us write (1), ..., (4) in (6.13) for the contribution (6.15) of the link in question to $a_4(L_{b_m})$ according to (6.3) and (6.7).

Let $[x, y]$ be the cycle $(y, y - 1, \dots, x)$ and $\sigma\tau = \tau \circ \sigma$ be the composite multiplication of permutations. We have

$$\begin{aligned}
(1) &= \langle (1, n)[n_1 + 1, n](1, l)[1, n_1] \rangle \\
&= \left\langle \begin{pmatrix} l+1 & \text{if } n \geq n_1 + 1 \\ l & \text{if } l \leq n_1 \end{pmatrix}, n \right\rangle (1, n)\pi(\beta) \rangle \\
(2) &= \langle (1, l)[n_1 + 1, n](1, n)[1, n_1] \rangle \\
&= \left\langle \begin{pmatrix} l & \text{if } l \leq n_1 \\ 1, n & \text{if } l = n_1 + 1 \\ l-1 & \text{if } l > n_1 \end{pmatrix} \right\rangle (1, n)\pi(\beta) \rangle \\
(3) &= \langle [n_1 + 1, n](1, n)(1, l)[1, n_1] \rangle \\
&= \langle (l, n)(1, n)\pi(b) \rangle, \\
(4) &= \langle (1, l)(1, n)\pi(b) \rangle.
\end{aligned}$$

Then for $l \leq n_1$ we have (1) = (3) and (2) = (4), and in the sum over $l > n_1$ of (1) – (3) terms cancel with a shift of 1. Similarly for (2) – (4).

We have then

$$\sum_l (1) + (2) - (3) - (4) = (1)_{l=n-1} - (3)_{l=n_1+1} + (2)_{l=n_1+1} - (4)_{l=n-1}.$$

The two permutations with positive sign are equal to $\pi(b)$, while the other two have a fixpoint (and a cycle of length $n - 1$), and the result follows. \square

With lemma 6.4, theorem 6.1, and therewith also theorem 1.1, is proved. \square

7. EXAMPLES, APPLICATIONS AND PROBLEMS

As a consequence of theorem 5.1, we obtain the following result in [24].

Corollary 7.1. *Let L be a composite link of braid index $b(L) \geq 4$, which factors as $L_1 \# L_2$ in such a way, that the components of either $L_{1,2}$ the connected sum is performed at are knotted. (E.g. any composite knot L will do.) Then L has infinitely many non-conjugate minimal braid representations.*

Proof. By the 1-subadditivity of the braid index under connected sum proved by Birman and Menasco [4], L has a composite minimal braid representation b , of the sort illustrated in Figure 17 (where $\hat{b}_i = L_i$). Such a representation admits an exchange move if it has $n = b(L) \geq 4$ strands. By assumption, the component of the common strand of b_1 and b_2 has at least one other strand in either of these. By

conjugation of b_i it can be made to be strand 1 and n (in b), so that the cycle condition of theorem 5.1 also holds. \square

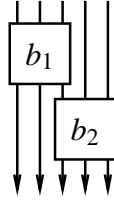

FIGURE 17. A composite braid

Example 7.2. We found that most prime knots K of crossing number $c(K) \leq 10$ and $b(K) \geq 4$, except 7 knots for $c(K) = 9$ and 15 knots for $c(K) = 10$, have a minimal representation admitting an exchange move. (See the table in §8.) So these knots have infinitely many conjugacy classes of minimal braid representations.

Note that the exchange move in Figure 3 is trivial when the leftmost strand of α or the rightmost strand of β are isolated. We do not know if under exclusion of these obvious cases, the move can always yield infinitely many conjugacy classes. Certainly, theorem 1.1 gives the weakest condition in terms of $\pi(b)$ alone under which the exchange move can work.

If one likes to investigate the remaining braids, one must be aware that a construction of Stanford [22] allows one to ‘approximate’ these cases of failure by others which cannot be distinguished by any number of Vassiliev invariants (including coefficients of ∇). With this insight in advance, we expect little decent outcome in trying to apply our approach in the excluded case.

In [24] we used some Lie group approach which covers some of these braids when in Figure 3 we have $\beta = \sigma_n^{\pm 1}$. This approach promises no satisfactory adaptation to exchange moves.

Apart from these difficulties, we conclude with two more remaining problems.

Problem 7.3. Theorem 1.1 suggests to seek braids admitting exchange moves, but the identification what links have such (minimal) braids is still difficult.

Problem 7.4. We do not know how to construct *Markov irreducible* $b \in B_n$ with $n > b(L)$, i.e. such not conjugate to stabilizations $b\sigma_{n-1}^{\pm 1}$ for $b \in B_{n-1}$. The only examples known, due to Morton and Fiedler [15, 8], are for $n = 4$ and $K = \hat{b}$ being the unknot.

8. TABLE

The below list gives 4-braid representations admitting an exchange move for 95 knots of braid index 4 (up to mirroring) in the tables of [19, appendix]. An integer $i > 0$ means σ_i , an $i < 0$ stands for σ_{-i}^{-1} . Note that an n -braid word admits an exchange move up to cyclic permutation if and only if it has no (cyclic) subword of the form

$$(8.1) \quad \sigma_1^{\pm 1} \cdots \sigma_{n-1}^{\pm 1} \cdots \sigma_1^{\pm 1} \cdots \sigma_{n-1}^{\pm 1} \cdots$$

We shifted, as in [7], indices down by 1 for $10_{163}, \dots, 10_{166}$ to discard Perko's duplication. Thus, e.g., the knot written below as 10_{162} is Rolfsen's 10_{163} .

A further mistake in Rolfsen's tables is that therein 10_{83} and 10_{86} are swapped: the Conway notation and Alexander polynomial for each one refers to the diagram of the other. The convention taken here is that we interchange Conway notations and Alexander polynomials to fix the mismatch (as in the corrected reprinting of Rolfsen's book), and *not* the diagrams (as, e.g., in [13]).

6_1	-3 -3 -2 1 1 2 -1 3 -2	10_{14}	-3 -3 -3 -3 -3 -2 1 -2 1 3 -2
7_2	-3 -3 -3 -1 -1 -2 1 3 -2	10_{15}	-3 -3 -3 -3 -1 2 1 1 -3 2 2
7_4	-3 -3 -2 -1 -1 -2 1 3 -2	10_{19}	-3 -3 -3 -3 -1 2 1 1 2 -3 2
7_6	-3 -3 -3 -1 2 -1 2 3 -2	10_{21}	-3 -3 -2 -2 -2 -2 1 -2 1 3 -2
7_7	-3 -3 -2 1 -2 1 3 2 2	10_{22}	-3 -3 -3 -3 1 -2 1 1 1 3 -2
8_4	-3 -3 -3 -1 2 1 1 -3 2	10_{23}	-3 -3 -2 -2 -2 1 -2 1 1 3 -2
8_6	-3 -3 -3 -3 1 -2 1 3 -2	10_{25}	-3 -3 -3 -3 -2 -2 1 -2 1 3 -2
8_8	-3 -3 -3 1 -2 1 1 3 -2	10_{26}	-3 -3 -3 -1 2 1 1 2 2 -3 2
8_{11}	-3 -3 -2 -2 1 -2 1 3 -2	10_{27}	-3 -3 -3 -3 -2 1 -2 1 1 3 -2
8_{13}	-3 -3 -2 1 -2 1 1 3 -2	10_{32}	-3 -3 -3 -2 1 -2 1 1 1 3 -2
8_{14}	-3 -3 -3 -2 1 -2 1 3 -2	10_{39}	-3 -3 -3 -2 -2 -2 1 -2 1 3 -2
8_{15}	-3 -3 -2 -2 -3 -1 -1 2 -1	10_{40}	-3 -3 -3 -2 -2 1 -2 1 1 3 -2
9_4	-3 -3 -3 -3 -3 -1 -1 -2 1 3 -2	10_{49}	-3 -3 -3 -3 -2 -2 -3 -1 -1 2 -1
9_7	-3 -3 -3 -3 -2 -2 3 -1 -1 -2 1	10_{50}	-3 -3 -2 -2 1 -2 -2 -2 1 3 -2
9_{10}	-3 -3 -2 -2 -2 -1 -1 -2 1 3 -2	10_{51}	-3 -3 -2 -2 1 -2 -2 1 1 3 -2
9_{11}	-3 -3 -3 -3 -1 2 -1 -3 2	10_{52}	-3 -3 -3 -1 2 1 1 2 -3 -3 2
9_{13}	-3 -3 -3 -3 -2 -1 -1 -2 1 3 -2	10_{54}	-3 -3 -3 -1 2 1 1 -3 -3 2 2
9_{17}	-3 -1 2 -1 2 2 2 -3 2	10_{56}	-3 -3 -3 -2 1 -2 -2 -2 1 3 -2
9_{18}	-3 -3 -3 -2 -2 -1 -1 -2 1 3 -2	10_{57}	-3 -3 -3 -2 1 -2 -2 1 1 3 -2
9_{20}	-3 -3 -3 -1 -1 2 -1 -3 2	10_{61}	-3 -3 -3 -1 2 1 1 -3 -3 -3 2
9_{22}	-3 -1 2 -1 2 -3 2 2 2	10_{65}	-3 -3 -2 1 -2 -2 -2 1 1 3 -2
9_{23}	-3 -3 -3 -2 -2 -1 -1 2 -1 3 -2	10_{66}	-3 -3 -3 -2 -2 -2 -3 -1 -1 2 -1
9_{24}	-3 -3 -1 2 -1 -3 2 2 2	10_{72}	-3 -3 -3 -3 -2 -2 3 -2 1 -2 1
9_{26}	-3 -3 -3 -1 2 -1 2 -3 2	10_{76}	-3 -3 -3 -3 -2 -2 -2 3 1 -2 1
9_{27}	-3 -3 -1 2 -1 2 2 -3 2	10_{77}	-3 -3 -3 -3 -2 -2 3 1 -2 1 1
9_{28}	-3 -3 -1 -1 2 -1 -3 2 2	10_{80}	-3 -3 -3 -2 -2 -3 -3 -1 -1 2 -1
9_{30}	-3 -3 -1 2 -1 2 -3 2 2	10_{83}	-3 -3 -2 1 -2 -2 1 -2 1 3 -2
9_{31}	-3 -3 -1 -1 2 -1 2 -3 2	10_{84}	-3 -3 -3 1 -2 -2 1 -2 1 3 -2
9_{32}	-3 -3 -1 2 -1 -3 2 -3 2	10_{86}	-3 -3 -2 1 -2 1 -2 1 1 3 -2
9_{33}	-3 -1 2 -1 -3 2 -3 2 2	10_{87}	-3 -3 -3 1 -2 1 -2 1 1 3 -2
9_{36}	-3 -3 -3 -1 2 -1 -3 -3 2	10_{90}	-3 -3 1 -2 -2 1 1 -2 1 3 -2
9_{42}	-3 -3 -3 -1 2 -1 3 3 2	10_{93}	-3 -3 -1 2 1 1 -3 2 -3 -3 2
9_{43}	-3 -3 -3 1 -2 1 -3 -3 -2	10_{102}	-3 -3 -1 2 1 1 -3 2 -3 2 2
9_{44}	-3 -3 -3 1 -2 1 3 3 -2	10_{103}	-3 -3 1 -2 -2 1 -2 -2 1 3 -2
9_{45}	-3 -3 -2 -2 -3 -1 2 -1 2	10_{108}	-3 -3 -1 2 1 1 -3 -3 2 -3 2
9_{49}	-3 -3 -2 -2 -3 -3 -1 2 -1 3 -2	10_{114}	-3 -3 1 -2 1 -2 1 -2 1 3 -2
10_6	-3 -3 -3 -3 -3 -3 1 -2 1 3 -2	10_{128}	-3 -3 -3 -2 -2 -3 -1 2 -1 -3 -2
10_8	-3 -3 -3 -3 -3 -1 2 1 1 -3 2	10_{129}	-3 -3 -3 2 2 3 -1 2 -1 3 2
10_{12}	-3 -3 -3 -3 -3 1 -2 1 1 3 -2	10_{130}	-3 -3 -3 -1 2 1 1 2 3 3 2

10_{131}	-3	-3	-3	-2	-1	-1	-2	1	3	3	-2	10_{151}	-3	-3	-3	-1	2	-1	2	2	-1	3	-2
10_{132}	-3	-3	-3	-1	-1	-2	1	1	1	3	-2	10_{153}	-3	-3	-3	1	-2	1	-3	-3	2	2	2
10_{133}	-3	-3	-3	-2	-2	3	-1	2	-1	3	-2	10_{154}	-3	-3	-2	-2	-3	-1	-2	-2	-1	-1	2
10_{134}	-3	-3	-3	-2	-2	-3	-3	-1	-1	-2	1	10_{156}	-3	-3	-3	-1	2	-1	3	3	-2	3	-2
10_{135}	-3	-3	-3	-2	1	1	2	2	1	3	-2	10_{158}	-3	-3	-3	1	-2	1	3	-2	3	2	2
10_{140}	-3	-3	-3	-1	-1	-2	1	3	3	3	-2	10_{160}	-3	-3	-3	-2	-2	-3	2	-3	1	-2	1
10_{142}	-3	-3	-2	-2	-3	-3	-1	2	-1	-3	-2	10_{162}	-3	-3	-2	-2	-3	2	-3	-1	2	1	1
10_{144}	-3	-3	-2	-2	-3	-1	2	1	1	-3	2	10_{163}	-3	-3	-2	-2	3	-2	3	3	-1	2	-1
10_{150}	-3	-3	-3	-2	-2	-2	3	3	-1	2	-1												

The 22 knots of braid index 4 for which we could not find a 4-braid admitting an exchange move are:

9_{29} ,	9_{34} ,	9_{38} ,	9_{40} ,	9_{46} ,	9_{47} ,
9_{48} ,	10_{92} ,	10_{95} ,	10_{98} ,	10_{111} ,	10_{113} ,
10_{117} ,	10_{119} ,	10_{121} ,	10_{122} ,	10_{136} ,	10_{145} ,
10_{146} ,	10_{147} ,	10_{164} ,	10_{165} .		

Among the 5- and 6-braid knots in the table, all have a minimal braid admitting an exchange move. This can be checked from the representations given in [27]. It is easy to see that the (cyclic) shape (8.1) (with $n = 5, 6$) can be avoided after possibly applying some commutativity relations.

ACKNOWLEDGMENTS

This work was carried out under support by the Brain Korea 21 (BK21) Project of the Ministry of Education & Human Resources Development of the Republic of Korea. The authors are grateful to KAIST, Daejeon, Korea for its hospitality.

REFERENCES

- [1] J. W. Alexander, *A lemma on systems of knotted curves*, Proc. Nat. Acad. Sci. U.S.A. **9** (1923), 93–95.
- [2] E. Artin, *Theory of braids*, Ann. of Math. **48** (1947), 101–126.
- [3] J. S. Birman, *Non conjugate braids can define isotopic knots*, Comm. Pure Appl. Math. **22** (1969), 239–242.
- [4] J. S. Birman and W. W. Menasco, *Studying links via closed braids IV. Composite links and split links*, Invent. Math. **102** (1990), no. 1, 115–139.
- [5] ———, *Studying links via closed braids VI. A nonfiniteness theorem*, Pacific J. Math. **156** (1992), no. 2, 265–285.
- [6] ———, *Studying links via closed braids III. Classifying links which are closed 3-braids*, Pacific J. Math. **161** (1993), no. 1, 25–113.
- [7] G. Burde and H. Zieschang, *Knots*, de Gruyter, Berlin, 1986.
- [8] T. Fiedler, *A small state sum for knots*, Topology **32** (1993), no. 2, 281–294.
- [9] E. Fukunaga, *Infinite sequences of braids representing a single link type*, "Topology of Knots V", Waseda Univ., 2002, proceedings.
- [10] ———, *An infinite sequence of conjugacy classes in the 4-braid group representing a torus link of type $(2, k)$* , preprint.
- [11] F. Garside, *The braid group and other groups*, Q. J. Math. Oxford **20** (1969), 235–264.
- [12] J. Hoste, *The first coefficient of the Conway polynomial*, Proc. Amer. Math. Soc. **95** (1985), no. 2, 299–302.
- [13] A. Kawauchi, *A survey of Knot Theory*, Birkhäuser, Basel-Boston-Berlin, 1991.

- [14] H. R. Morton, *Infinitely many fibred knots having the same Alexander polynomial*, *Topology* **17** (1978), no. 1, 101–104.
- [15] ———, *An irreducible 4-string braid with unknotted closure*, *Math. Proc. Cambridge Philos. Soc.* **93** (1983), no. 2, 259–261.
- [16] ———, *Threading knot diagrams*, *Math. Proc. Camb. Philos. Soc.* **99** (1986), 247–260.
- [17] H. Murakami and Y. Nakanishi, *On a certain move generating link-homology*, *Math. Ann.* **284** (1989), 75–89.
- [18] K. Murasugi and R. S. D. Thomas, *Isotopic closed nonconjugate braids*, *Proc. Amer. Math. Soc.* **33** (1972), 137–139.
- [19] D. Rolfsen, *Knots and links*, Publish or Perish, 1976.
- [20] R. Shinjo, *An infinite sequence of non-conjugate 4-braids representing the same knot of braid index 4*, *Intelligence of Low Dimensional Topology 2006, Ser. Knots Everything*, **40**, World Sci. Publ. (2007), 293–297.
- [21] ———, *Non-conjugate braids whose closures result in the same knot*, *J. Knot Theory Ramifications* **19** (2010), no. 1, 117–124.
- [22] T. Stanford, *Braid commutators and Vassiliev invariants*, *Pacific Jour. of Math.* **174** (1996), no. 1, 269–276.
- [23] A. Stoimenow, *On non-conjugate braids with the same closure link*, *Jour. of Geometry* **96** (2010), no. 1, 179–186.
- [24] ———, *Non-conjugate braids with the same closure link from density of representations*, *Journal de Mathématiques Pures et Appliquées* **94** (2010), no. 5, 470–496.
- [25] ———, *Tabulating and distinguishing mutants*, *Internat. Jour. Algebra Comput.* **20** (2010), no. 4, 525–559, DOI: 10.1142/S0218196710005789
- [26] ———, *Application of braiding sequences I: On the characterization of Vassiliev and polynomial link invariants*, *Comm. Contemp. Math.* **12** (2010), no. 5, 681–726.
- [27] ———, *Knot data tables*, <http://stoimenov.net/stoimeno/homepage/ptab/braid.out>

OSAKA CITY UNIVERSITY ADVANCED MATHEMATICAL INSTITUTE,
3-138 SUGIMOTO 3-CHOME, SUMIYOSHI-KU, OSAKA 558-8585, JAPAN

E-mail address: reiko@suou.waseda.jp

DEPARTMENT OF MATHEMATICS,
KEIMYUNG UNIVERSITY, DAEGU 704-701, KOREA

E-mail address: stoimeno@stoimenov.net

URL: <http://stoimenov.net/stoimeno/homepage/>