

ORGANISATION EUROPÉENNE POUR LA RECHERCHE NUCLÉAIRE  
**CERN** EUROPEAN ORGANIZATION FOR NUCLEAR RESEARCH

**Sir John Adams: his legacy to the world of particle accelerators**

John Adams Memorial Lecture 2009

E. J. N. Wilson

John Adams Institute, University of Oxford, UK

ISBN 978-92-9083-356-7

ISSN 0007-8328

Copyright © CERN, 2011

 Creative Commons Attribution 3.0

Knowledge transfer is an integral part of CERN's mission.

CERN publishes this report Open Access under the Creative Commons Attribution 3.0 license (<http://creativecommons.org/licenses/by/3.0/>) in order to permit its wide dissemination and use.

This monograph should be cited as:

E. J. N. Wilson, Sir John Adams: his legacy to the world of particle accelerators, John Adams Memorial Lecture, 2009, CERN-2011-001 (CERN, Geneva, 2011).

## **Abstract**

John Adams acquired an unrivalled reputation for his leading part in designing and constructing the Proton Synchrotron (PS) in CERN's early days. In 1968, and after several years heading a fusion laboratory in the UK, he came back to Geneva to pilot the Super Proton Synchrotron (SPS) project to approval and then to direct its construction. By the time of his early death in 1984 he had built the two flagship proton accelerators at CERN and, during the second of his terms as Director-General, he laid the groundwork for the proton–antiproton collider which led to the discovery of the intermediate vector boson. How did someone without any formal academic qualification achieve this? What was the magic behind his leadership? The speaker, who worked many years alongside him, will discuss these questions and speculate on how Sir John Adams might have viewed today's CERN.



## Contents

1	Introduction . . . . .	1
2	How John Adams viewed building accelerators . . . . .	1
3	His first success . . . . .	1
4	Telecommunications Research Establishment Malvern—his university . . . . .	3
5	Harwell . . . . .	3
6	CERN . . . . .	5
6.1	The PS Parameter Committee . . . . .	7
7	Plasma research—the move to Culham . . . . .	8
8	The 300 GeV machine and the ISR . . . . .	9
8.1	Redesigning the 300 GeV machine . . . . .	9
8.2	Difficulties with the 300 GeV Project . . . . .	11
8.3	Designing the new machine . . . . .	12
8.4	Design improvements . . . . .	14
8.5	Bringing the 300 back to CERN—‘Project B’ . . . . .	16
8.6	Highlights of SPS construction . . . . .	17
8.7	Magnet problems . . . . .	19
8.8	Commissioning . . . . .	19
8.9	He becomes Director-General a second time . . . . .	20
8.10	R. R. Wilson . . . . .	21
9	Since he left us . . . . .	22
10	Conclusion . . . . .	23
	References . . . . .	23



## 1 Introduction

Twenty-five years ago, in the year of John Adams's death, Edoardo Amaldi gave the first talk in this series of John Adams Memorial Lectures [1]. Amaldi's subject was, like mine, the life of this great man. In 1959, in the very early days of CERN, Amaldi had recruited John Adams to build the Proton Synchrotron (PS) and had remained his friend and supporter throughout his career. His account was from the viewpoint of a senior figure in European accelerator science.

My own account is written from the very different viewpoint of a member of John Adams's team. My personal experience of the man dates from 1969 when he returned to CERN for a second time as Project Leader Designate of the 300 GeV Machine (or Super Proton Synchrotron (SPS) as it was to become). I was a research fellow at CERN when he recruited me as his technical assistant. I was given the job of adapting the lattice of the SPS and coordinating its design to the point that, in 1971, CERN's Member States were finally able to approve the project and agree that it should be built at CERN. I then continued to work in day-to-day contact with John Adams as his Head of Parameters during the design of the SPS and throughout its commissioning in 1976. I was therefore fortunate enough to see him mastermind a huge project and deal with the many obstacles that must be overcome in such an endeavour. It is my hope that these two accounts complement each other to give a full picture of the ingredients of his greatness.

John Adams was at the heart of CERN's proud boast that its accelerators are finished on time and work reliably, and he should be remembered as an example for all future machine builders and project directors. In the course of writing this account, several questions occurred to me. How did someone like John Adams without any formal academic qualification achieve this? What was the style and method behind his leadership? How did he achieve political success with the Member States of CERN in turning the almost hopeless quest for approval of the SPS to CERN's advantage? I will also attempt to compare him with his US counterpart R. R. Wilson, and imagine what he would now have to say about CERN's last 25 years. I believe the answers to these questions will go a long way to understanding his mastery of the field and I will therefore use italics to emphasize them.

## 2 How John Adams viewed building accelerators

Let me return to the matter of John Adams's style of building machines that were reliable and which cost no more than promised. He attempted to summarize how he achieved this in some of his final words to the CERN Council:

*... The question of how much flexibility to build into a machine is obviously a matter of judgment, and sometimes the machine designers are better judges than the physicists who are anxious to start their research as soon as possible. But whatever compromise is reached about flexibility, one should certainly avoid taking risks with the reliability of the machine because then all its users suffer for as long as it is in service and the worst thing of all is to launch accelerator project, irrespective of whether or not one knows how to overcome the technical problems. That is the surest way of ending up with an expensive machine of doubtful reliability, later than was promised, and a physicist community which is thoroughly dissatisfied. CERN, I am glad to say, has avoided this trap and has consistently built machines which operate reliably, are capable of extensive development, and have been constructed within the times promised and within the estimated costs.*

## 3 His first success

Figure 1 is a picture of John Adams at a high point in his career. It was taken on 25 November 1959, in the CERN Auditorium—fifty years ago (almost to the day of this lecture) as he announced to CERN Staff that the PS had accelerated beam to 24 GeV. The November 2009 issue of the CERN Courier [2] contains an extract from a lively contemporary account by Hildred Blewett of the previous night's excitement in the Control Room.

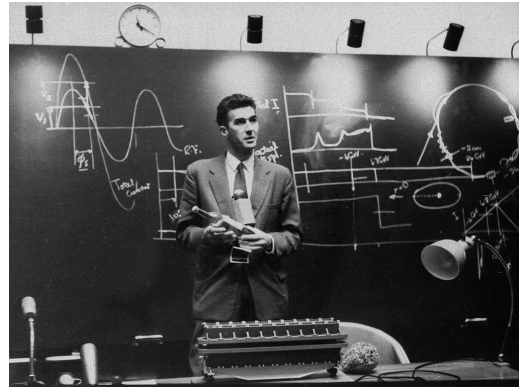

**Fig. 1:** John Adams announces that the PS had accelerated beam to 24 GeV

In his hand can be seen an (empty) vodka bottle, which he had received from Yu. P. Nikitin with the message that it was to be drunk when CERN passed Dubna's world record energy of 10 GeV. The bottle contains a Polaroid photograph of the 24 GeV pulse ready to be sent to the Soviet Union.

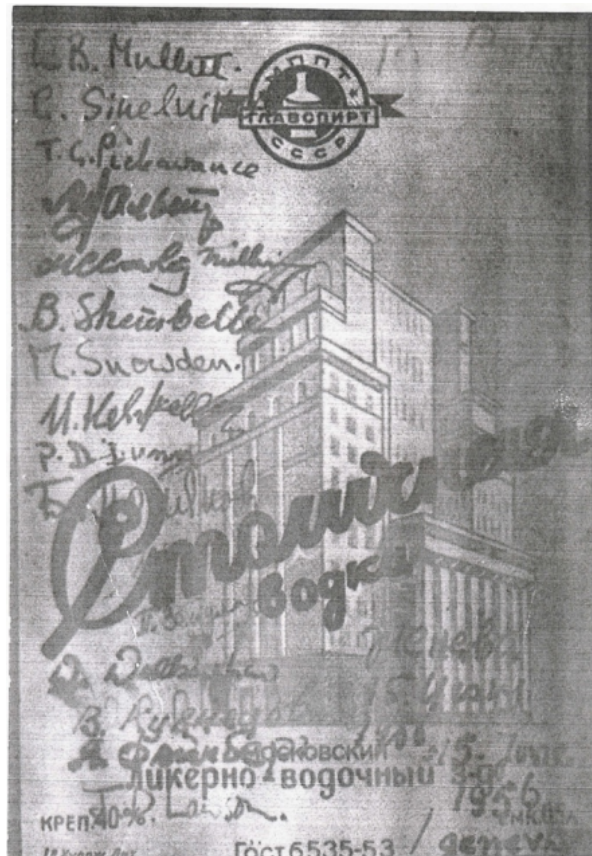

**Fig. 2:** The label of the vodka bottle (from the John Lawson Archives [3])

The label which we see in Fig. 2 is itself a piece of history—a testament to an international meeting at Dubna some months earlier and one of the early cracks in the ice of the Cold War. The names include Mullet, Pickavance, Crowley-Milling, Snowden, Lawson, and many others in Cyrillic script.

And this brings us to the first question: How did this young man of 33, without university education, come to lead such a project? Certainly he was not coached in physics, mathematics or management



at a prestigious university. He had left school in 1936 without wishing to go on to university. Rather, he sought practical employment as a student apprentice at the Siemens Laboratories at Woolwich. He took a Higher National Certificate (HNC) night school diploma in electronics to become a member of the Institution of Electrical Engineers, but at this point his formal education came to an end. When asked this question many years later, John Adams said, “*If university means that you learn from capable men—I had ample opportunity.*”

#### **4 Telecommunications Research Establishment Malvern—his university**

He first began to meet these capable men when he joined up for the war effort in 1940 and was posted to Telecommunications Research Establishment (TRE) Swanage and later to Malvern where Radio Direction Finding (RDF) or radar was under development. The staff and advisors of TRE included John Cockcroft, Robert Watson-Watt, Henry Tizard, Alan Blumlein, Bernard Lovell, P. I. Dee, W. E. Burcham, and E. D. Fry. Many of the accelerator builders of the post-war years were also there including Hine, Crowley-Milling, Shersby-Harvie, Snowdon, Mullet, Walkinshaw, and J. D. Lawson.

John Adams was in a group responsible for transmitter–receiver cells and diodes for 3 cm radar. His boss and mentor then was Herbert Skinner who had worked at the Cavendish Laboratory under Rutherford. His contemporaries said Adams had an instinctive feeling for what was needed—a comment that appears again and again during his later career. Adams’s roommate also said he was so good at doing sketches he could design a complete three-dimensional circuit layout on paper. It was during this time that he met Mervyn Hine—later to be his closest collaborator in the design of the PS, and Michael Crowley-Milling who was then working for Metropolitan Vickers building linacs for medical purposes. Michael was to become part of the Adams team that built the SPS and has written a book about John Adams which I commend to you as a more complete account than space allows me here [4].

#### **5 Harwell**

After the war, the Atomic Energy Research Establishment (AERE) Harwell Laboratory was set up at the initiative of Sir John Cockcroft, Mark Oliphant, and James Chadwick so that the contributions made by Britons to the nuclear effort in the US might continue in Europe. As part of this it was decided to build a 100-inch cyclotron (Fig. 3). Herbert Skinner, John Adams’s boss from TRE, was in charge of General Physics at Harwell and invited him to join the project. He was to work under Gerry Pickavance who had been part of a team that had already built a cyclotron at Liverpool University. At the time, Gerry had a reputation for assuming an importance above his station. It is said his Liverpoolian colleagues once nailed him to the floor by the sleeves of his lab-coat to teach him a lesson in modesty. As a Liverpool man myself, I can attest to this being quite within the bounds of possibility, though by the time I met Gerry Pickavance as Leader of the Rutherford Laboratory, he had obviously learned his lesson in restraint, and had become an excellent senior manager who was later to become a staunch supporter of John through the period leading up to the SPS.

It was at Harwell that John cut his teeth on project management. The Harwell cyclotron [5] was challenging—a synchrocyclotron with 110-inch poles, closely modelled on Stan Livingston’s design for the Massachusetts Institute of Technology. When Gerry spent months at a time visiting the US, John was left in charge of everything except the RF systems. He found he was taking more and more of the crucial design decisions himself as he thoroughly worked his way through a multitude of sketches and calculations as diverse as heat transfer and particle orbits. This was a considerable responsibility for a young man and here perhaps is another clue to his success as he *seized this unusual opportunity to develop his skills and experience.*

Even great men need a role model. For John Adams it was Harwell’s Director, Sir John Cockcroft, who had been awarded a Nobel Prize for his atom-splitting at the Cavendish Laboratory in the 1930s (Fig. 4). Sir John Cockcroft was much revered by John who in later life displayed a portrait of him behind

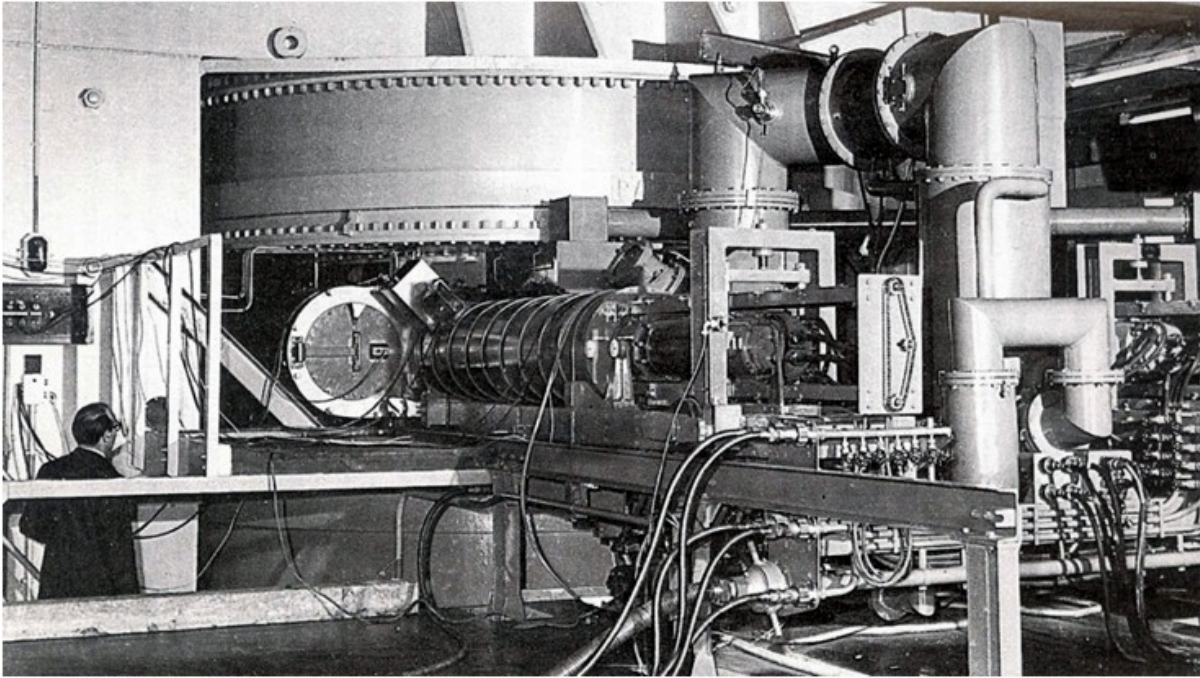

**Fig. 3:** The Harwell cyclotron

his desk. Cockcroft is said to have been a modest man who managed his team with quiet authority. His management style was to let people get on with what they were good at, but to show an almost daily interest in their progress. He would often appear at the beginning of a day's work behind the shoulder of a humble lathe operator to ask him "How is it going?" He gave his staff considerable freedom to follow their own line, but would be quick to support them by shouldering the responsibility, should they need to be rescued. How different from the aggressively critical attitude taught to today's managers who, all too often, are ready to dismiss 'the weakest link' rather than correct and reform. John's style was very much that of Cockcroft—a style which I commend to those who might wish to emulate him.



**Fig. 4:** Sir John Cockcroft

Harwell was part of John's learning curve and it was there that he first tasted failure when he tried to persuade Skinner to give him an extra £50,000 to enlarge the yoke of the magnet and reach a higher energy. (See Fig. 5 from his notebook.) He lost the battle only to see the finished cyclotron end up with not quite enough energy to produce the new 'mesons' which it might have discovered. This may have been in his mind as he later pressed for 400 GeV rather than 300 GeV for the SPS. Perhaps here he

learned another lesson—*not to give up on something your gut feeling tells you is correct.*

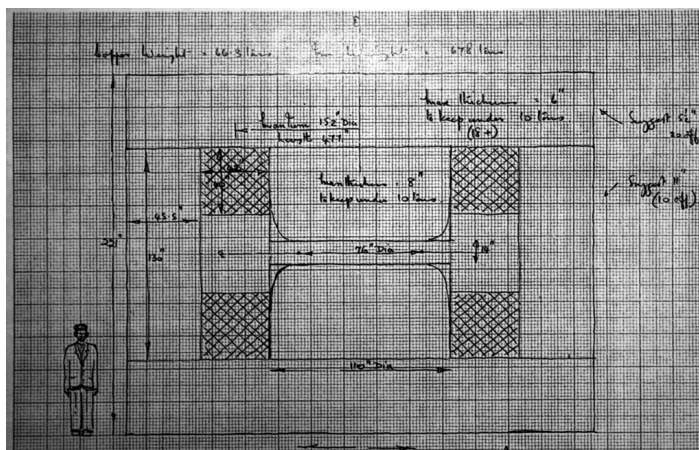

**Fig. 5:** A page from John Adams's meticulously kept Harwell notebook

Once the Harwell cyclotron was finished, he had another setback as he was reassigned to work on a fast breeder reactor. Knowing very little nuclear physics, he had to work night and day to catch up but found it frustratingly difficult. He became seriously depressed and was sent away for six months by his wife Renie to stay with an uncle who was a pig farmer. He returned in better spirits and with the courage to discuss his future with Cockcroft.

Cockcroft, who firmly believed in matching the man to the job, was sympathetic and as a temporary measure set him to work on a klystron together with Mervyn Hine. Soon after, Cockcroft saw a real chance to rescue John by setting him off on an international venture that brought him to CERN. Here he learned two more lessons—*don't force yourself to do things which do not match your skills* and *at crucial times seek help from your mentor.*

## 6 CERN

In May 1952 The CERN Council met for the first time in Paris. CERN's initial idea for a Proton Synchrotron (PS) was a 10 GeV weak focusing machine—a scaled-up version of the 3 GeV Cosmotron at Brookhaven in the US, which had recently become the first proton synchrotron to operate. A Norwegian, Odd Dahl, was the CERN PS Project leader together with Frank Goward who was later to become his deputy in Geneva. Very soon after this, in August 1952, Dahl, Goward, and Rold Widerøe visited the Cosmotron and learned of the new idea of strong focusing from Courant, Livingston, and Snyder. They returned to immediately change the CERN plan for a 25 GeV alternating-gradient machine.

At that time, the UK was suspicious of its continental neighbours. After all, it had benefited from a vigorous partnership with the US on nuclear matters during World War II and saw little advantage in joining CERN. It fell upon Edoardo Amaldi and Cockcroft to persuade a reluctant Ben Lockspeiser, then the UK minister in charge of the Department of Scientific and Industrial Research, to join. They also had to persuade Lord Cherwell, Churchill's scientific advisor, to withdraw his objections to CERN. In this they eventually succeeded. Amaldi described in his first John Adams Memorial Lecture how he then wished to meet some young British physicists and engineers, whereupon Cockcroft brought John Adams to meet him at lunch. Afterwards Amaldi had an extended interview with the young man as they travelled by car to Harwell and chose to recommend John (and Frank Goward) for places in the new team to build the PS. This set the seal on the career that was to lead John to his first triumph. Amaldi, in Ref. [1], recalls that John was surprisingly ready to move to Europe. He already realised the role of international science in keeping nations from warfare and wanted to be part of it. This seemed one of John Adams's guiding principles destined to steer his life towards CERN and later to world projects: *'International*

*common ventures prevent wars.* Frankly, as a child of wartime United Kingdom, I appreciate how such thoughts were far in advance of their time.

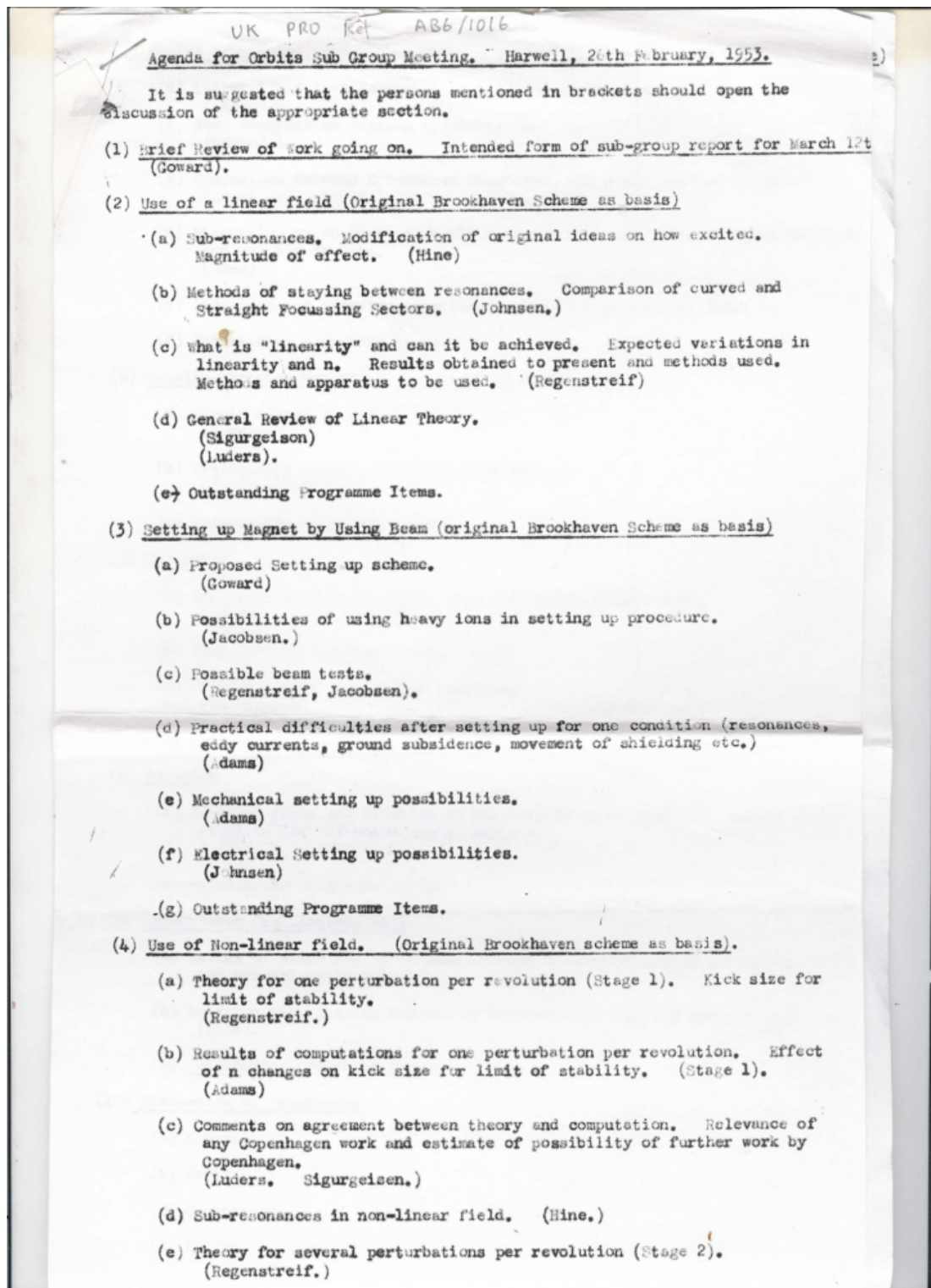

Fig. 6: Agenda of a meeting to decide PS parameters

The UK was therefore still not immediately a signatory to CERN and, not for the last time, John found himself working on a major European project without the support of his own government. But

Frank Goward and John Adams were seen as experts in circular machines and they met frequently in Harwell and other laboratories to discuss the new idea with the nascent PS team.

Among such discussions there was a crucial meeting at Harwell at the end of 1952—just after Amaldi’s visit, and before Adams officially worked for CERN. Those at the meeting included J. D. Lawson, Kjell Johnsen, Mervyn Hine and John Adams. It was not minuted, but in Fig. 6 (from Ref. [3]) we see the agenda for a subsequent meeting which gives a clue as to the contributions of the various participants.

It was John’s job to help resolve the many doubts there still were about this decision to change to alternating-gradient focusing. John Lawson had warned of the dangers of non-linear resonances and Kjell Johnsen had to be persuaded that transition would not be a problem. John and Mervyn Hine studied the non-linear resonances driven by magnet imperfections using ACE, one of the first computers available in the UK. It seemed that because of the high field gradient (n-value) of the first design, magnet construction tolerances would need to be unrealistically tight to avoid these resonances. Hine writes: “I remember at the end of the Harwell meeting John summarized and took over. He stepped into the authority position and wrote a summary on the blackboard in his wonderfully clear left-hand writing.” In retrospect this seems to be a crucial turning point at which *he seized the opportunity to assume authority over the new project’s design.*

At subsequent meetings John was able to report that a set of compromise parameters had been found. The n-value was to be reduced by a factor 4 and the magnet aperture would have to be three times larger—but still tiny compared with the Cosmotron. This was typical of the kind of approach that John brought to the design of accelerators. Each effect had to be analysed and calculated and its effect on the chances of a successful outcome had to be balanced against the need to be economical in construction. His notebooks contained logical lists of arguments for and against each compromise. He was to extend this careful elimination of all risk to many other parts of the project and he recruited incomparable teams of engineers to ensure the highest quality of design and construction. Sometimes the workshops resembled a Swiss watch factory, but it paid off and set the CERN standard for completing on time and within budget. The secret was in the many long hours of discussion with others and the analytical tool provided by his notebook.

## 6.1 The PS Parameter Committee



**Fig. 7:** PS Group Leaders— From left to right we see Ed. Regenstreif, Pierre Germain, Kjell Johnsen, Arnold Schoch, Mervyn Hine, John Adams, Franco Bonaudi, Fritz Grutter, Kees Zilverschoon, and Colin Ramm

Not long after, in October 1953, the PS team gathered in premises lent to them by the University of Geneva whilst awaiting the construction of the first buildings on the new CERN site in Meyrin.

Goward was the Project leader and he assembled a formidable team of experts to design and construct the machine. In the photograph (Fig. 7) we see almost all the PS Group Leaders, each responsible for an aspect of the machine.

John Adams and Mervyn Hine were known at this time as the ‘terrible twins’ using their experience with earlier projects to enliven the proceedings of the Parameter Committee which met once a week to put flesh on the bones of the design. (Later I will say more about the Parameter Committee and its role in Adams’s method of project management.)

To Giorgio Brianti, arriving in November 1953, it was clearly John who, chairing the Parameter Committee, masterminded the design and construction. Brianti recalls that then John was already ‘the Boss’. Goward had fallen ill and died in early 1954 leaving John to take over full responsibility for the project, eventually steering to the moment of his triumph in 1959.

## 7 Plasma research—the move to Culham

Near the end of his first period at CERN he began to take an interest in plasma research, attending a number of meetings with a view to setting up another international organization. He was interested in plasma accelerators and some experimental work started at CERN.

In 1958 a lot of plasma work in the UK was declassified and shared with the Russians during a momentary thaw in the Cold War. It was in the days of ZETA, the Harwell machine which prematurely announced the dawn of energy from thermonuclear fusion. These hopes proved false, but in spite of this, the UK was keen to set up a new laboratory at Culham to develop the field. Even before the PS was finished, they tried to persuade John to return as Director of this new laboratory. He was anxious that his children attend schools in the UK academic system to prepare them for university and he agreed to head the new laboratory once the PS was finished. However, following the death of Jan Bakker, then CERN’s Director-General, in a plane accident in April 1960, John Adams was appointed Director-General of CERN. His return to the UK had to be delayed until he had not only finished the work of getting the PS running properly but had seen the physics programme take off.



**Fig. 8:** ZETA

In Fig. 8 we see ZETA, and in Fig. 9 the Culham laboratory near Abingdon. He was to spend the next five years in the UK, eventually being asked to advise Frank Cousins, a minister in the government of Harold Wilson. I remember him later being very critical of the quality of the administration over which Frank Cousins and Anthony Wedgwood-Ben presided. John’s advice was often not taken and influenced government thinking only many years later. Frustrating as this experience was, it left John with a clear idea of how politicians worked and how they might or might not be influenced—an experience that was to be invaluable in persuading Member States to support moving the SPS to CERN.



**Fig. 9:** The Culham Laboratory

## 8 The 300 GeV machine and the ISR

In 1960 when he was still Director-General and just before he left for Culham, John recommended to Council, “that CERN should plan to build a machine to replace the Proton Synchrotron. It should be ready in 1970 therefore plans should be prepared for consideration in 1962 or 1963.” A study group was set up under Kjell Johnsen to look into the feasibility of a collider (Intersecting Storage Rings, the ISR) and a 150–300 GeV proton synchrotron. Council approved the ISR, appointing Johnsen to head its construction (see Fig. 10). At the same time a detailed design study of a new proton synchrotron was published in a substantial report ‘A Design Study for a 300 GeV Proton Synchrotron’ [6], commonly referred to as the ‘Grey Book’.

This machine proved to be a scaled-up version of the PS and ISR, incorporating the lessons learned from their construction and applied with all the conservatism that experienced engineers tend to bring to new projects. It would have taken eight years to construct and cost about 1800 MCHF.



**Fig. 10:** The ISR

### 8.1 Redesigning the 300 GeV machine

It had not been the aim of Kjell Johnsen’s team, who had written the Grey Book, to be economical in either time or money. In the USA a similar proposal was made for the 200 BeV accelerator, authored by many who had contributed to CERN’s Grey Book and incorporating many of the same conventional features. After its publication, the construction of the American machine was approved at the US Fermi National Laboratory (Fermilab) near Chicago and work started under the leadership of R. R. Wilson. He tore up the 200 BeV design and proposed a much leaner design which could be constructed in only four

years and which would operate at 400 GeV—twice the energy originally proposed. The most striking innovation was to change the lattice from combined-function magnets to one in which the functions of bending and focusing were performed by separate and quite different magnets.

The change from combined-function to separated-function lattice was later to be so fundamental to securing approval for the SPS that it is worth a short explanation. We recall that focusing in synchrotrons is achieved by a field gradient across the mid plane of the magnets. This, together with the centrifugal force on the particles, forces errant particles which swing away either upwards, downwards, or on either side of the ideal central orbit around the machine to be pushed back towards the central orbit. In early synchrotrons and cyclotrons this gradient was uniform around the machine. In the AGS, PS, and ISR the sign of the gradient alternated from magnet to magnet to produce a much stronger focusing effect called alternating-gradient focusing. The magnets had tapered gaps between the poles so that they both focused and bent the particles at the same time. The direction of the taper alternated from magnet to magnet. Although the gradient alternated in these machines, one kind of magnet combined the function of bending and focusing which had a certain simplicity. These were the magnets John and Kjell knew and loved from the PS and ISR.

However, in such magnets the central field, which determines the central orbit and the radius of the machine, cannot be as high as it is at the edge of the poles where saturation limits the field to 1.8 T. Allowing for the gradient, the field on the centre line of a combined-function magnet can only be about 1.3 T. In the separated-function idea there are two kinds of magnet: ‘pure dipole’ bending magnets with uniform field of about 1.8 T and special ‘pure gradient’ quadrupole magnets to provide the focusing. Bob Wilson had shown that, by using such a separated-function design, there could be a considerable saving in total bending magnet length—more than enough room to place special dedicated quadrupole magnets to provide the focusing.<sup>1</sup>

This change from combined to separated function happened in 1967 just when I had come to CERN on a fellowship and was encouraged by Roy Billinge (then about to leave to build the Booster at Fermilab) to join the Accelerator Research Department (AR) and work on improving the Grey Book. Roy and I (we were both just 30) were both ‘rebels with a cause’ convinced that, by adopting some of the radical simplifications that Bob Wilson was adopting for the Fermilab machine, CERN’s 300 GeV machine would become faster to build and cheaper. Roy went off to Fermilab while I taught myself the rudimentary skills of lattice design and set about designing a separated-function version of the Grey Book.

When I applied this to the 300 GeV machine, the energy jumped from 300 GeV to 400 GeV but when I showed this proudly to Kjell Johnsen and Kees Zilverschoon (caretakers of the 300 GeV project, but still busy finishing the ISR), I was told not to rock the boat. To be fair, the main concern at that time was to decide it was to be built. Council delegates spent much of the time viewing and reviewing the 22 and the finally 5 possible sites scattered across Europe in countries who all hoped to benefit from the local trade and prestige. It took the arrival of John Adams to give the revised design the attention it deserved.

In 1969 John Adams returned to CERN, appointed by the CERN Council to lead the 300 GeV/SPS Project. Finding that I was the only full-time person working on the lattice for the machine, he invited me to several one-on-one discussions about the design of the new machine and listened with enthusiasm to my separated-function version of the Grey Book. As a very junior visiting fellow to CERN at the time, I was both surprised and flattered by the attention of one of the ‘great men of science’. I expected it would be too revolutionary and might seem to him to prejudice the operational reliability of the machine, but it clearly fitted in with what turned out later to be his grand scheme for CERN. We worked hard on redesigning the machine, and our proposal is to be found in Ref. [8].

---

<sup>1</sup>The first proposal of separate-function magnets (i.e., the separation of dipoles and quadrupoles) for an accelerator lattice was made by T. Kitagaki in 1953 [7]. Among other implications, this separation allowed for smaller magnets and for the introduction of long straight sections without dipole fields.



## 8.2 Difficulties with the 300 GeV Project

Just before John arrived in CERN for the second time, the UK had dealt a blow below the belt to the '300'. The Labour government, who were strapped for cash, were not very interested in pure science and saw no financial advantage in the project even if their site were to be chosen. In June 1968, Sir Brian Flowers announced to the CERN Council that they should not count the UK among the participating countries. This was just after John had given up his influential responsibilities in London to move to CERN and become Project Director Designate. He found himself once again playing a crucial role in starting a project without the support of his own country.

Apart from the withdrawal of the UK from the new project and the difficulties in settling on a site for the '300 Machine', the new Project Director Designate had to pay more than lip service to Fermilab ideas. Bob Wilson was by then boasting a five-year construction time for his machine, an almost unbelievable cost profile, and 400 GeV to boot. Adams was under considerable pressure from certain German physicists and Citron (of the PS days) to move away from the "lavish practices" of the PS and the ISR and take heed of the wind of change blowing strong from Fermilab in Illinois.

He had to cut the cost of the 300 GeV proposal without sacrificing reliability, resolve the question of where it would be built, and defuse the feeling that Member State opinions were not being taken into account. I have no doubt that these aims were listed on the first page of his notebook soon after he returned and it is clear to me in retrospect that he lost no time in devising a strategy to find a way through the minefield. It can hardly have taken him too long, because there seemed to be no preliminary exploration of blind alleys on the way—and all of this from a man who *seemed not to have made up his mind about anything until he had heard all sides of the argument*—masterly leadership by any standards. After the event John Adams explained the difficulties he faced thus:

“Looking back, I think one can discern a number of reasons why our Member States hesitated to reach a decision on the 300 GeV Programme in the form it was presented at that time.

In the first place the economic situation in 1969 for science in general and nuclear physics in particular was very different from the ebullient years around 1964 and 1965 when the 300 GeV Programme was first put forward. It was evident that several Member States of CERN and possibly all of them found the cost of the Programme too high compared with their other investments in science and with the growth rates in their total science investments, which had dropped from figures around 15% per annum in 1965 to a few per cent per annum in 1969.

In the second place, the idea of constructing a second European laboratory for nuclear physics remote from the existing one, which had seemed attractive in 1965, looked inappropriate in 1969, particularly since it implied running down the existing CERN laboratory when the new one got under way.

In the third place, so many delays had occurred in the 300 GeV Programme and the American machine was coming along so fast that an eight-year Programme to reach experimental exploitation seemed too long.

Fourthly, it turned out that choosing one site amongst five technically possible sites presented non-trivial political problems for the Member States of CERN.”

This quotation is typical of the point-by-point analysis that he used to summarize his view on any argument. When he sat down in the afternoon to update his notebook with his resolution of the arguments presented to him by others, he would light his pipe and often compose just such a summary. He found this kind of logical analysis led him to the most reasonable and sensible decisions and, when presented to others, was persuasive and almost irresistible in its clarity of thought and logic.

This is frankly not the kind of rhetoric that a politician might use to sway a crowd but it is calm, reflective, designed to raise the minimum of eyebrows, and, above all, be persuasive in its relentless

logic. Brian Southworth, then Editor of the CERN Courier once said: “John has the astonishing gift of delivering absolute truth in the manner of Farmer Giles leaning over his gate to comment on the weather.”

The ideas seem just to have occurred to him after the project was approved, as a clever way of summarizing, but he surely arrived at these conclusions almost immediately he arrived at CERN as Project Director Designate since it so well summarizes what everyone was experiencing at that time—problems which only he knew how to resolve. I believe he decided then to adopt it as a to-do list and, playing his cards close to his chest, tackled each item in turn.

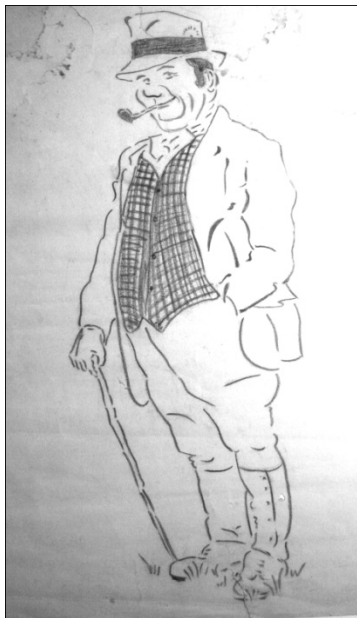

**Fig. 11:** “Farmer Giles” (as sketched by John Adams)

### 8.3 Designing the new machine

His first step towards securing the CERN Council’s approval for the SPS was to set up a Machine Committee to involve as many of the senior accelerator experts from Member States as he could. The choice of this committee was masterly—that of a benign Machiavelli. He needed the help of a number of his old PS group leaders to ensure that high standards of engineering were not sacrificed for the most important components, and to ensure the maximum probability of success. Magnet, radio frequency, survey, and extraction were looked after in this way. There were other major systems, among them the power supply and the control system where he found those in Member States who felt they could make an innovative contribution. Crowley-Milling’s control system based on mini computers from Norway was doubly salutary, as were John Fox’s power supplies based not on rotating machinery but saturable reactors. Others were recruited to the committee to reassure the sceptics in Germany and the UK that cost and manpower estimation was done in the way they would like to see it. They were encouraged to hang the redesign of the machine on this new separated-function lattice that I had designed.

John had headed the Parameter Committee in the days of the PS and he clearly expected the Machine Committee to operate in the same fashion to ensure the consistency of the design and the success of the project. Each of the meetings followed an agenda which was principally a series of reports by those responsible for the major systems of the machine. Each system was worked out in greater engineering detail following suggestions at the previous meeting. At the heart of the business was keeping a list of all the relevant design data from top energy, through number of bending and focusing magnets, their length and peak field, the injection and extraction systems, together with the frequency and voltage applied to the accelerating cavities, and even the diameter of the tunnel and the load on the cooling system.

Each time anything was changed, its impact on cost, performance, reliability, and of course implications for other systems would be discussed with all the hardware specialists present. Any changes had to be incorporated in a master list of parameters and in the lattice design. For the design and later construction of the SPS, I was lucky enough to be in charge of both parameters and lattice. Of course it was John, always at the head of the table, who presided. I sat at the other end keeping the minutes. He encouraged me to ask questions which would provoke discussion and reveal weaknesses in the design which needed to be debated and resolved. This method of managing a project had the great advantage that there was only one meeting at which technical matters of accelerator design and engineering would be decided in the presence of all component group leaders who might be affected.

I remember the lively, heated discussions between new members and some of the members from his past PS team who had moved on meanwhile to build the ISR. They were at pains to squash the ideas of Bob Wilson in the United States, often expressed by this younger “upstart Wilson” (perhaps they at first believed I was a relative) in their midst. Meetings were not without their explosive exchanges—not surprising considering my own brash inexperience. They also hoped to be asked to build these components and did not want to make it hard for themselves.

But having a variety of opinions put forward around the table suited John’s style of facilitating a meeting. He was able to judiciously move the project from the Grey Book towards a leaner design without apparently taking sides. John’s moderate and reasonable interventions were usually in the form of a simple question. “Wouldn’t that mean that...”, or as he turned to someone not already part of the combat, “How would that affect the magnet/power supply/schedule?—How would these new magnets look?—What tolerances would be necessary in their construction?—Would they reduce cost?—How would they compare with the PS and ISR? and How might one inject and extract the beam?” In this way he would orchestrate the discussion by asking for opinions until he heard one which matched his new way of thinking. Then he would summarize the ‘consensus’ he had sculpted for us and define what was to be studied next. Of course there were, meanwhile, many pipes of tobacco to be prepared after meticulous cleaning of the instrument to provide a pretext for reflexion.

When all of this had been debated, I would be expected to ask myself in the minutes of each meeting to accommodate new aspects of the design in an ever increasing series of lattices, each with new sets of parameters.

Later, when we came to construct the SPS, the Machine Committee became the Design Committee and the debates about magnets, cavities, injection, extraction, power supplies, and civil engineering were again heated. The more controversial decisions were often concerned with the lattice (myself) and the magnets (represented by Roy Billinge, recently returned from the US). Both of us had a preference for the new ways of building synchrotrons pioneered at Fermilab which were often at odds with the ideas of the more experienced members of the team. At the time the discussions in the SPS Design Committee were taking place, the news from Fermilab was not good and it became clear that their magnets had not been made to the standards of electrical integrity established at CERN. But John was not to be put off from taking what was best from Fermilab and imposing CERN standards on its construction.

In managing the construction, John Adams followed closely the precepts of his mentor Sir John Cockcroft. He gave his group leaders, the members of his Monday Morning Design Committee, considerable latitude to manage their own groups. His interest was always on achieving performance goals on time and without over expenditure. Subsequently I have heard it said that his budget was generous compared with later machines. All I can say is that he made strenuous efforts to build the SPS for much less than the unit costs achieved in the PS and ISR days. True there was, wisely, a contingency in the funding, but this was not needed for the SPS and at the end of the construction was reallocated to provide a new North Experimental Hall.

*To have such a weekly meeting with the heads of your hardware groups and have them inform everyone on progress in all aspects of the machine seems so fundamental to John Adams’s style that would-be project leaders should depart from this practice at their peril.*

As I prepared this talk, I struggled to describe the particular method that John Adams used to run a meeting. He hardly said anything, but would steer the opinion of the members in the direction he wanted simply by asking questions. An Oxford philosopher friend tells me this is exactly the method used by Socrates and Plato in the School of Athens (See Fig. 12). *Maieutics* (its name in Greek means helping give birth—in this case to ideas) is a disciplined questioning that can be used to pursue thought in many directions and for many purposes, including: to explore complex ideas, to get to the truth of things, to open up issues and problems, to uncover assumptions, to analyse concepts, to distinguish what we know from what we don't know, and to follow out logical implications of thought. I suppose our budding project manager should read a bit of Plato now and again—though I have no evidence that John Adams did—he was probably hard-wired to act in this way.



**Fig. 12:** Raphael's fresco 'The School of Athens'

#### 8.4 Design improvements

But our narrative has run on and we must now return to the days when his plan to secure the SPS for CERN was taking shape. He expected the Machine Committee to think of improvements and to incorporate the new ideas of Fermilab.

The first system to be scrutinized was the lattice—the pattern of magnets around the ring. Whether this is combined- or separated-function, it always has to be consistent with the parameters of the hardware. If it is decided to add more RF cavities to accelerate faster or to increase beam capture efficiency, the lattice has to be adjusted to make room for it. The lattice determines the dynamics of particles within the beam pipe, if it has many cells the focusing will be stronger, the beam envelope smaller, and both magnet dimensions and even that of the tunnel can be made smaller. Of course, even if the logic of the mathematics tells you that the tunnel need only be 150 cm in diameter, you can be sure that someone in the committee will remind you that no one would be able to walk there, let alone drive a lorry full of rock through it. In Fig. 13 we see one cell of the lattice (out of 100 or so around the circumference).

Figure 13 also shows another new idea: missing magnets. If only half of the bending magnets are built and installed in the first stage but more money becomes available, you add the second half to double the energy (from 200 GeV to 400 GeV). I'm not sure where this idea came from—it was perhaps prompted by Bob Wilson's 'energy saver' which was a 'missing power' machine—but it later proved very useful in countering the Member States when they complained they were in financial straits. In fact it was only when the final prices came in for the first set of magnets that we knew we could move directly to exercise an option to order the rest.

In the days before computer controls, synchrotrons were designed with magnet gaps between the poles large enough to accommodate not only the beam but a generous safety margin to accommodate all

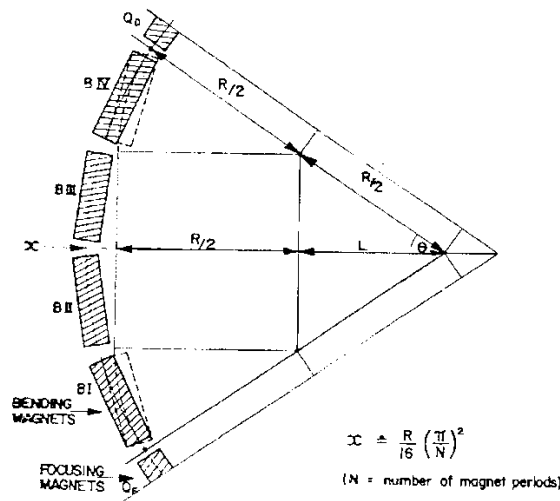

**Fig. 13:** One cell of a separated-function lattice (showing the missing magnet option)

the orbit distortions due to the tiny errors in magnet construction and alignment with 98% probability. We invented a strategy based on how orbit correction had been applied to the PS to liberate aperture by correcting orbits. By the time the SPS was discussed, the PS had successfully corrected a large fraction of this orbit distortion, liberating more aperture for the beam. Why not therefore rely on using the same kind of correction to reduce the SPS aperture (see Fig. 14)? I'm not sure if it was my idea but it was one that I championed. Perhaps I did not realise it at the time but this was in danger of pulling the design in the direction of making it less likely to work first time—one of John's major concerns. However, it brought about considerable cost savings.

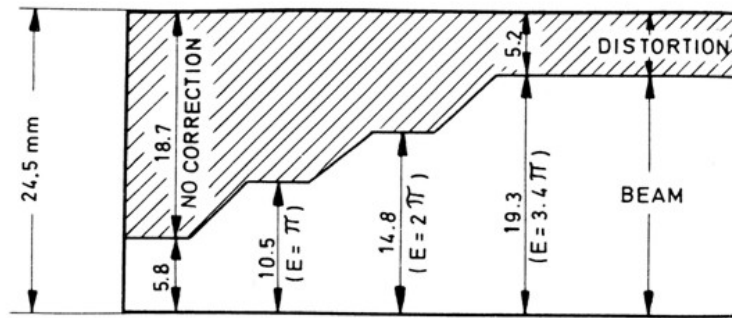

**Fig. 14:** Correcting orbit distortion liberates aperture

Magnet design is a subject dear to the heart of all accelerator builders and each (including John) had their idea of how best to do this. Earlier I explained how Bob Wilson had replaced 1.3 T combined-function magnets with 1.8 T pure dipoles. But combined-function were the magnets John and Kjell knew and loved from the PS and ISR and had spent many years perfecting. Moreover, some were still sceptical of Bob Wilson (who the unkind said ran a ranch of cowboys in the States).

We spent many meetings (then and later when the machine was approved) discussing the virtues and vices of the new magnet designs. Many in the Machine Committee remembered their experiences with similar and dissimilar magnets that they themselves had built or seen built. It was perhaps John's biggest challenge to resolve this issue and in the end it was settled by designing the best lattice for 300 GeV using combined- and then separated-function principles and looking at the cost implications us-

ing a computer program supplied by the laboratory that was one of our most vehement critics—Karlsruhe. John rightly insisted that everything had to be included in the program. If the field in a magnet was lowered, the ring became longer and more RF would have to be added to accelerate in the time defined by the parameter list. The tunnel would be longer but stored energy which had to be shipped in and out from the electricity grid would be reduced—and there were many more such considerations. The energy dissipated would also change, causing more or less cooling capacity to be installed. When all this was costed and optimized we clearly saw that a separated-function ring would cost no more, but would be more compact. Little did we know at the time that this matched John’s master plan to fit the machine back on the molasse plateau at CERN, and had the added advantage, vis-à-vis his critics, that Bob Wilson’s innovations had not been ignored but exploited.

When all this was over and the Design Report for a 400 GeV machine written [9], it turned out that the Machine Committee had done its job well. The cost savings were important because of the criticisms of many of the Member States concerning the generous and expensive safety margins that the Praetorian Guard of old PS designers had sustained in the ‘300 GeV Proposal’. Previous visitors from German and UK laboratories being shown around the ISR had marvelled openly at the vast space around the machine—the air conditioning—gold-plated connections (so it was said) and the absence of any attempt to learn from earlier experience. The new design at least seemed to have answered their technical objections.

## 8.5 Bringing the 300 back to CERN—‘Project B’

Member States had still to choose somewhere to put it and Member States were determined to build the next machine anywhere else, but not at CERN! This was in part fed by the feeling that many physicists had not succeeded in getting their experiments approved at CERN while other ‘residents’ had been preferred.

You perhaps saw in John Adams’s *a posteriori* analysis of the situation, how, in spite of these objections, it was his aim to bring the machine back to CERN. Studies of the separated-function lattice showed that this might now be possible (at least for 300 GeV). The deciding argument was to be that if the machine were built at CERN it would not be necessary to set up a whole new laboratory and build a new linac and an injector synchrotron. The 25 GeV PS was ready and waiting. This idea came to be known as ‘Project B’.

For several months in early 1970, Project B had to be kept secret while he politically manoeuvred the Member States to accept the idea. They must be attracted by the cost saving. Every week he set off each day to a new capital, appropriately dressed and coiffed to impress the local audience—with the aim of gradually coaxing them into this new way of thinking.

At first only John and Pepi Dokheer (his secretary) knew about Project B. However, to check his ideas he had to enlist my help to calculate the lattice. Unfortunately for both me and Project B, I had just broken my leg skiing and lay for six weeks with a weight strapped to my foot in the Cantonal Hospital in Geneva. Computing was out of the question. I was surprised one afternoon to have a distinguished visitor at my bedside when John arrived complete with secretary and chauffeur. He politely enquired about when I might return to my computer terminal and said that he would have something very important for me to do when I did.

Sure enough, once I was able to do the calculations, Project B seemed eminently possible on the CERN site but he still wondered if the molasse (sandstone) was extensive enough to contain the whole tunnelling operation and then one day he said, “I suppose I have to let Jean Gervaise into the secret so that we may look at the borings in his filing cabinet.” (Jean Gervaise was in charge of surveying the site.)

It was, of course, exciting to work on such a secret project, but fending off helpful enquires was not easy. Giuseppe Coconni asked me one day (and I think it was his own idea), “Has anyone thought of putting the 300 at CERN?” I had to pretend that no-one had considered it, but one might have a look.

Finally, it was time to spill the beans to the Scientific Policy Committee and then to Council. John cleverly asked Bernard Gregory (then Director-General) to make the first presentation while he, John, was in the US, safe from the storm he expected to break, and ready to return and dampen the flames. As expected, there was quite a lot of resistance from the physics community who had been hoping for 400 GeV and, with good luck, closer to their home. There were also many who probably felt somewhat cheated to hear what had been going on without their knowledge, and it is debatable whether the secrecy was not counterproductive.

All this came to a head a few weeks later when the European Committee for Future Accelerators were asked to approve the new 'Project B'. They met on a Saturday, spending the morning complaining that the energy was too low, and everything was going rather badly by the time they adjourned for lunch. After lunch John took me on one side. He had skipped the lunch, returning to his office to ponder over the cardboard model on his filing cabinet, which showed the contours of the rock beneath CERN. He said, "I think we can just find room for an 1100 m radius ring—will this be big enough for 400 GeV?" I confirmed that it would, and he offered it to the afternoon session (with the proviso, to satisfy his principle of caution, that there were still some crucial borings to be done which might yet bring a nasty surprise). It was enough to turn the tide in his favour and save the day for Project B.

There were still many Member States to be convinced to join. This took until the Council meeting of December 1970 and even that had to be adjourned and reconvened on 19th February 1971 before the last couple of Member States could be persuaded. That afternoon, after a particularly good Council lunch, John lost no time in returning to his office to start the business of recruiting the new staff. There were 600 farmers who owned the land on which the new ring was to be built. His first appointment that afternoon was with André Klein, a high official from the Prefecture of the region whom he persuaded to join the team to deal with any dissent from the landowners.

## 8.6 Highlights of SPS construction

The offices of the new Laboratory II were in a barrack as far from the centre of CERN as possible, and later were moved over into France near Prévessin. It was clear he wanted to put his imprint on a new style. Again he had only one weekly technical meeting, like the Parameter Meetings he had chaired for the PS. He chaired this Design Committee every Monday morning until the machine was finished. The team he assembled over the few weeks following SPS approval was a healthy mixture of those who had helped him with the PS and who had gone on to build the ISR, and new blood from other Member State laboratories.

Figure 15 is a photograph taken on the occasion of the first meeting of the 300 GeV Design Committee from my viewpoint opposite John. On his left is his second-in-command Hans-Otto Wuester, a charismatic but explosive German from DESY Hamburg who had, as he reminded anyone who was slow to respond to his encouragement, "one shoe that is sharpened to be used where it hurts." He was the foil to John's gentlemanly manner and was often sent over by John to Laboratory I to "sort them out". Usually the threat was enough!

We also see, going round clockwise from the left, Hans Horisberger (engineering), Clemens Zettler (radio frequency), Roy Billinge (magnets), Norman Blackburne (personnel), Bas De Raad (extraction), Klaus Goebel (health and safety), and Simon van der Meer (power supplies). Others who came later included Boris Milman (finance and planning), Giorgio Brianti (experimental areas), Michael Crowley-Milling (control system), and Robert Lévy-Mandel (civil engineering). Wuester, Billinge, Milman, Lévy-Mandel and Crowley-Milling came from outside. Others: Zettler, Blackburne, and Goebel, were second-in-command to CERN group leaders who presumably chose to stay where they were.

John was particularly interested in keeping an eye on civil engineering. On Saturdays he would tour the site with Robert Lévy-Mandel, noting where work might be falling behind schedule. By the time Monday came around again Robert would usually be able to report that he had talked with the contractors



**Fig. 15:** The 300 GeV Design Committee



**Fig. 16:** The SPS ring tunnel is completed

and found a solution. Placing large contracts for the magnets was another major concern. If the second half of the magnets for SPS were to be ordered, the contract for the first half would have to come in at a low price and options to build the second half would have to be written into the agreement.



## 8.7 Magnet problems

There were from time to time, as in any project, unforeseen technical setbacks. One such was the discovery that 100 of the 700 bending magnets already installed in the tunnel had developed short circuits to ground. This was deeply shocking to all concerned and it looked as if the SPS was no better than the Fermilab main ring where magnets failed at the rate of one a day in the early tests. Had we been wise to emulate the methods of Fermilab? we wondered.

The whole team of group leaders was summoned to meet every day for a week to investigate the cause and plan a remedy. It was in the spirit of putting their heads together. There might well have been shouting or admonishment, but with John Adams in the chair there was instead, as there should be, just logic and science.

Rather soon Billinge and Bob Sheldon, who was a chemist, and whose first instinct was to lick a finger and to taste the tag ends of the coil conductors, established that they had been prepared for brazing by cleaning with phosphoric acid by an overzealous welder. The acid, it was discovered, could fill up the hollow glass fibres which loaded the insulation and provide a conducting path for short circuits. Fortunately there was time, without delaying the start-up, to take out the infected magnets, rebuild the coils, and wrap them in Kapton to prevent any other shorts.

Delays to several large projects (not least, the magnet insulation of the Fermilab Main Ring, the niobium welds on the vacuum chamber of the Large Electron–Positron machine (LEP), the busbar connections of the Tevatron, and recently the interconnects in the Large Hadron Collider (LHC)) have regularly been caused by the unpredictable consequences of engineering solutions. It was fortunate that no delay resulted for the SPS—perhaps thanks to John Adams’s rigorous analysis of possible difficulties and their solutions—but more realistically because of the thorough pre-start-up tests he insisted upon after installation in the tunnel.

## 8.8 Commissioning

The SPS was finished five years after the team first assembled in Prévessin. Such was the thoroughness of the preparation that John had expected from his team that each stage in the commissioning programme worked like clockwork. Once again John left those in charge to do their stuff, but I do remember one moment before the beam was injected when he asked everyone “Are you sure you have not forgotten something?”.



**Fig. 17:** SPS control room—first beams accelerated

The contrast with the commissioning of Fermilab, which I had lived through a couple of years earlier, was clear. Everyone in the SPS control room had done their professional job and knew enough about accelerator physics to diagnose any little misbehaviour of the beam. To be fair, it also helped to be able to learn from Fermilab experience. There was one little hiccup when we tried to accelerate for the

first time and the beam just disappeared. Within the same day we tracked down a fault in the numerical program of the power supplies for the focusing system and went on to accelerate.



**Fig. 18:** The CERN Council is asked to approve 400 GeV

The 200 GeV acceleration came easily and the first pulse was synchronized to be announced to the Council at the end of their morning session. At some time in the past, the Council had insisted they be asked permission before moving from 200 GeV to 400 GeV. It had been something to do with ordering the missing magnets. After reporting acceleration to 200 GeV, John wryly asked their authorization to accelerate to 400 GeV and by the tea break in the afternoon he announced the first 400 GeV pulse—on time and of course—on budget.

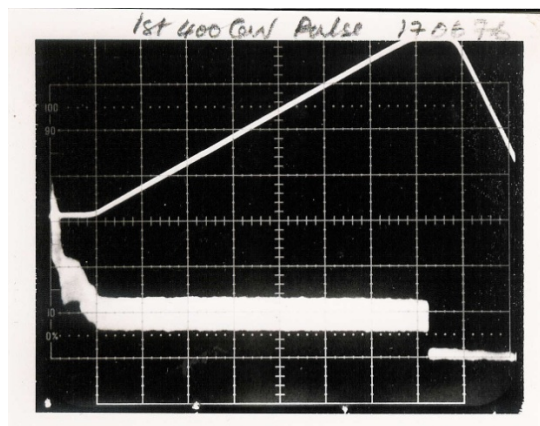

**Fig. 19:** The first 400 GeV pulse

## 8.9 He becomes Director-General a second time

During the construction period he had been Director-General of Laboratory II, which included the SPS and the Prévessin site in France, while Willi Jenschke had looked after the main Laboratory I site at Meyrin including the ISR, PS, and their experiments. The time came, just before the SPS was finished, to merge the two laboratories together under a single Director-General. I remember meeting him then in the corridor (during the Council meeting where this was to be decided). He confided in me disconsolately that, “they were taking a long time over it—for some reason I do not understand, they think they need to

have two DG's." It turned out that, while they recognized he was the man to look after the accelerators, they wanted an eminent physicist rather than an engineer to manage the research programme. And so it was that they decided that John would be one Director-General who would concentrate on the accelerators, while Léon van Hove, a second Director-General, looked after the physics programme. It is greatly to John's credit that he was able to accept this arrangement and together they made it work. During his final term as Director-General he visited China. It was 1977 and before the iron grip of the Gang of Four began to slacken. China was keen to build a large proton ring near the Great Wall as a statement of China's progress towards western prosperity. John met Deng Xiaoping. "Very smart," said John, "perhaps I made a mistake to tell him the big proton machine would be no use to them and what they really needed was a synchrotron light source." And of course that is what they did.

### 8.10 R. R. Wilson

Throughout the construction of the SPS, Robert Rathbun Wilson was John's US counterpart whom he rarely mentioned. Bob Wilson had set about constructing the Fermilab main ring with very similar design aims to the SPS. He was fortunate to be able to start about five years before SPS approval and had finished it (though there were still some things to tidy up) about five years before the SPS. His style could not have been more different from that of John Adams. I had the privilege of working closely with both these men for, in the middle of SPS construction, I was dispatched by John Adams to help sort out some of the difficulties that Bob Wilson was having in commissioning his 400 GeV Main Ring. The fact that it needed someone from another laboratory to help in this way is perhaps a comment on the risks that Bob Wilson was prepared to take to save time and money in construction. This was something that John Adams, in his desire to be careful and not prejudice the reliable operation for the machine, was at pains to avoid.

However, it must be said that Bob Wilson inspired younger members of his team (and ours) with his bold initiatives. Many of the ideas which simplified the design of the SPS and assured its success had been copied from innovations he pioneered at Fermilab. We have seen that John Adams had embraced these ideas with enthusiasm, provided they did not put the outcome at risk.

Once, while visiting Fermilab, I can remember being asked by a resident historian to compare these two great men. My answer was:

John Adams had artistic talent but had never had the time to follow his talent to its conclusion—Bob Wilson on the other hand had managed to achieve an international reputation as a sculptor and architect.

John Adams persuaded through reason and was always a gentleman —Bob Wilson challenged his team with his own inspiration and rode roughshod over their objections.

John Adams was careful—Bob Wilson deliberately took risks (but was prepared to fix them afterwards).

John Adams was ideal for Europe whose politicians are used to allowing themselves to be persuaded by the reason and common sense of their own scientific advisors. Bob Wilson's passionate rhetoric often rivalled the Fathers of his Nation and was finely tuned to the ear of a Washington politician or media magnate.

Both would have been a disaster had they exchanged the old world for the new, or vice versa. Perhaps John Adams would have found it even easier to establish his technical dominance in the USA and without formal qualifications, but the US has little time for the staff management methods of Cockcroft or the cerebral exercises of Socrates. Bob Wilson would probably have been judged rash by European politicians and scientists, but his artistic gifts would have found more nourishment in the richer soil of Paris, Florence, or Rome than in Illinois.

*Both felt their career should have gone on longer, and I agree!*

## 9 Since he left us . . .

In preparing this talk I was asked to answer the question “How would CERN be different if John Adams was still alive today?” I will attempt to answer this, but emphasize that this is merely a personal view. I have not been as closely involved in CERN’s recent projects as I was when John Adams was alive and I expect that those who were may disagree with my conclusions. I still think that the points I raise are worthy of debate and should be taken on board by leaders of future projects.

The first accelerator project to follow in the wake of his years as Director-General was the Antiproton Accumulator (AA) using the SPS for colliding antiprotons with protons. This involved also the construction of two large detectors, UA1 and UA2. John Adams was still with us when these projects and LEP were started, and accelerator engineers and physicists who had been schooled in his way of doing things were largely responsible for their execution. These projects still bore his footprint.

The development of a more intense antiproton source to follow AA was perhaps something he might have restrained, given that the Tevatron with twice the centre-of-mass energy of the SP-PbarS was about to put antiproton physics with the SPS out of business. However, the cost of the new Antiproton Accumulator turned out later to be a small price to pay for the improved supply of antiprotons for the low-energy LEAR programme. About this time there was an upgrade to UA1 which did not materialize. John Adams might have seen this coming but would probably not have been able to restrain it even if he had wanted, since it was outside the field of accelerators.

I am tempted to think that the teething troubles due to the use of magnetic material (niobium) in the finishing of the LEP vacuum chamber might have been prevented by a Design Committee with John to guide them—or maybe it was just bad luck. Anyway, the delay it caused was minimal and LEP proved a great success in spite of it.

LEP had expensive delays due to fountains of water springing from the walls and floor during the tunnelling. With hindsight it should never have encroached upon the Jura limestone. John would certainly have been aware of the dangers of leaving the molasse and tunnelling into water-bearing rock but it would have required all his skills to persuade the physics community to sanction a smaller and less energetic LEP.

The next phase that John Adams might have had an influence upon was the race for approval between the Large Hadron Collider (LHC) and the Superconducting Supercollider (SSC). Once the US and Texas had decided they could not foot the bill for the SSC, he would have been in his element trying to arrive at a machine which the world might afford. Had this come to pass and had he gone on to have a leading role in a Super Collider’s construction, he would have kept a tight control on the tenders for major hardware components—a scrutiny which was very much needed at the SSC. Both the SSC and LHC used superconducting magnets, and it would have been interesting to see if John Adams could have found a way to curb the fears of industrial firms whose tenders for superconducting magnets mainly reflected their caution in bidding for an unfamiliar technology.

Approval for the LHC took a long time, but then so did approval for the SPS. After the demise of the SSC, Chris Llewellyn-Smith and Giorgio Brianti finally took the Council by the horns, and got them to agree to the LHC. Their approach used many of the techniques that Adams had deployed in 1971 to secure the SPS for CERN.

As for the future linear collider, I like to think that John would have seen the virtue of a common cause which spanned the various laboratories involved earlier, and used collaboration to push CLIC more rapidly towards becoming a project rather than a research and development exercise.

Of course, the big question at the moment of writing is—Would John and his Design Committee have seen the troubles with the LHC interconnects which caused so much sorrow in the last twelve months? This is in many ways reminiscent of the SPS history of magnet insulation problems. The only difference perhaps is that the SPS problem became apparent during routine electrical tests rather than in the glare of the spotlight of the world press. Nevertheless, there is a strong probability that John (always

on the lookout for engineering weaknesses) would not have let it creep under the radar of his Design Committee.

## 10 Conclusion

It was in 1981 that Sir John Adams received his knighthood from the Queen, but he modestly never asked to be called Sir John by his colleagues. Once his term of office was over, he moved back to his old office on the Prévessin site and began to make himself available as an advisor to a number of European and other international bodies. He would really like to have built LEP but as he said, “Schopper was keen to do it.” His brilliant career was at an end, and in the last few years he missed the bustle of building accelerators and the long queue of those waiting to see him, but I suppose that comes to all as they approach retirement, and what a career he had had! And what a legacy he left behind at CERN! There is so much in his career that those at CERN would do well to remember every time they start a new accelerator project. Not all of us can have his gifts but we may aspire to them.

## References

- [1] E. Amaldi, John Adams and His Times, John Adams Memorial Lecture, 1985, CERN 86-04 (CERN, Geneva, 1986).
- [2] CERN Courier, November 2009, extracted from CERN Courier, November 1969, pp. 331–336, H. Blewett.
- [3] John Lawson Archives at the John Adams Institute, Oxford.
- [4] M. C. Crowley-Milling, John Bertram Adams: Engineer Extraordinary (Gordon and Breach, Yverdon, 1993).
- [5] J. B. Adams and A. O. Edmunds, The performance of the Harwell 110 inch synchrocyclotron, AERE Report G/R 568 (1950).
- [6] CERN Study Group on New Accelerators, Report on the Design Study of a 300 GeV Proton Synchrotron, CERN-AR/Int. SG/64-15, CERN/563 (CERN, Geneva, 1964), 2 vols., also in French.
- [7] T. Kitagaki, A focusing method for large accelerators, Phys. Rev. 89 (1953) 1161–2.
- [8] J. B. Adams and E. J. N. Wilson, Design studies for a large proton synchrotron and its laboratory, Nucl. Instrum. Methods, 87 (1970) 157–179.
- [9] The 300 GeV Programme, Ed. E. J. N. Wilson, CERN/1050 (CERN, Geneva, 1972), also in French.