

# Quantum Coherent Nonlinear Feedback with Applications to Quantum Optics on Chip

Jing Zhang, Re-Bing Wu *Member, IEEE*, Yu-xi Liu, Chun-Wen Li, Tzyh-Jong Tarn *Life Fellow, IEEE*

**Abstract**—In the control of classical mechanical systems, feedback has been applied to the generation of desired nonlinear dynamics, e.g., in chaos control. However, how much this can be done is still an open problem in quantum mechanical systems. This paper presents a scheme of enhancing nonlinear quantum effects via the recently developed coherent feedback techniques, which can be shown to outperform the measurement-based quantum feedback scheme that can only generate pseudo-nonlinear quantum effects. Apart from the advantages of our method, an unsolved problem is that the decoherence rate is also increased by the quantum amplifier, which may be solved by introducing, e.g., an integral device or a nonlinear quantum amplifier. Such a proposal is demonstrated via two application examples in quantum optics on chip. In the first example, we show that nonlinear Kerr effect can be generated and amplified to be comparable with the linear effect in a transmission line resonator (TLR). In the second example, we show that by tuning the gains of the quantum amplifiers in a TLR coherent feedback network, the resulting nonlinear effects can generate and manipulate non-Gaussian “light” (microwave field) which exhibits fully quantum sub-Poisson photoncount statistics and photon antibunching phenomenon. The scheme opens up broad applications in engineering nonlinear quantum optics on chip. Particularly, in this study, the concept of feedback nonlinearization which is very useful for quantum feedback control systems is introduced. This is in contrast to the feedback linearization concept used in classical nonlinear feedback control systems.

**Index Terms**—Feedback nonlinearization, quantum coherent feedback control, nonlinear quantum optics, on-chip quantum optics, quantum control.

## I. INTRODUCTION

Over the last decades, the control of quantum phenomena has been steadily advanced in many fields such as quantum communication and computation, laser-induced chemical reaction, and nano electronics [1]–[39]. However, the implementation of realtime feedback, which is the core of control theory and engineering, is still in its infancy. The

major technical obstacles are (1) the time scale of general quantum dynamics is too fast to be manipulated in realtime by currently available electronic devices; (2) the required quantum measurements are generally extremely hard to do; and (3), more essentially, the back action brought by the quantum measurement deeply annoys the control designers because it keeps dumping entropy into the system before the feedback attempts to reduce it. So far, it is still not clear to what extent quantum feedback control may outperform the open-loop control, and this impedes the discoveries of new applications of quantum feedback control.

Up to now, there have been two commonly studied classes of quantum feedback strategies in the literature. The first one is called the measurement-based feedback control [40]–[46]. A typical implementation of such a scheme is to shoot an electromagnetic probe field through the quantum system to be controlled, carrying a part of information of the system that can be detected by some measurement apparatus and converted into classical signals, which are then fed back to adjust the input of the system. This is the analog of classical feedback loop. However, the accompanied problem is that the quantum measurement disturbs the system (i.e., the measurement back-action), and thus adds unremovable noises. Such a feedback was shown in our study [47] to be only capable of generating “classical” nonlinearity, which is not fully quantum.

By contrast, the other strategy is called coherent feedback control [48]–[52], in which the probe field is, instead of being read out, coherently guided back into the system after being unitarily transformed via quantum controllers (e.g., quantum beam splitters, quantum switchers, and quantum amplifiers). Such a strategy preserves the quantum coherence of the system, and is completely new to the theory of control system.

This paper will propose a promising application of quantum feedback control that is capable of inducing fully quantum nonlinear effects into the controlled systems. Similar idea has been applied in the pioneer work [53] for a novel approach to engineer the nonlinear dynamics of the nanomechanical system by nonlinear feedback control. This is important because nonlinear quantum processes [54] are essential in engineering many interesting quantum phenomena, such as the photon blockade induced by nonlinear Kerr effect and the generation of non-Gaussian light, with broad applications in quantum information processing, quantum nondemolition measurement, and the preparation of particular nonclassical states, e.g., the Schrödinger cat state. However, the nonlinear effects induced by the natural field-matter interactions are normally very weak. Therefore, artificial enhancement of quantum nonlinearity is crucial. Note that a similar idea has been employed in classical

Manuscript received ; first revised ; second revised ; third revised . This research was supported in part by the National Natural Science Foundation of China under Grant Nos. 61174084, 61134008, 10975080, 61025022, 60904034, 60836001. T. J. Tarn would also like to acknowledge partial support from the U.S. Army Research Office under Grant W911NF-04-1-0386.

J. Zhang, R.-B. Wu, and C.-W. Li are with the Department of Automation, Tsinghua University, Beijing 100084, P. R. China.(e-mail: jing-zhang@mail.tsinghua.edu.cn; rbwu@tsinghua.edu.cn; lcw@mail.tsinghua.edu.cn)

Y.-X. Liu is with the Institute of Microelectronics, Tsinghua University, Beijing 100084, P. R. China.(e-mail: yuxiliu@mail.tsinghua.edu.cn)

T.-J. Tarn is with the Department of Electrical and Systems Engineering, Washington University, St. Louis, MO 63130, USA.(e-mail: tarn@wuauto.wustl.edu)

All the authors are also with the Center for Quantum Information Science and Technology, Tsinghua National Laboratory for Information Science and Technology, Beijing 100084, P. R. China.

control of chaos, but the case for quantum control has been rarely studied [53], and, as will be seen below, is much more complicated due to the so-called quantum coherence.

As a potential application, our coherent feedback nonlinearization scheme can be applied to the emerging field of quantum optics on chip, i.e., producing optical-like quantum phenomena on compact solid-state chips such as waveguide circuits or superconducting circuits [55]–[58]. The on-chip optical devices are powerful in demonstrating particular optical phenomena that are hard to be observed in conventional optical setups. So far, the existing on-chip optical experiments are mainly done in the linear regime, due to the fact that the natural nonlinear effects induced by the couplings between the optical fields (the microwave fields) and the solid-state devices are too weak to be observed. In this paper, we will show that such nonlinear effects of on-chip lights can be “artificially” generated and amplified via the coherent feedback strategy.

This paper is organized as follows. In Sec. II, preliminaries are given for a brief introduction of the theory of the coherent feedback control network. In Sec. III, we introduce the basic setup and the mathematical model of the coherent amplification-feedback loop, from which the Hamiltonian of the controlled system can be effectively reconstructed. In Sec. IV, we apply these general results to the generation of the Kerr effect and the cross Kerr effect in the superconducting circuits. Furthermore, in Sec. V, we study how to construct general fourth-order controllable nonlinear quantum Hamiltonians and their applications to nonclassical on-chip “lights” (microwave fields). Conclusions and perspectives are given in Sec. VI.

## II. PRELIMINARIES

In quantum mechanics, the state of an isolated system can be described by a vector  $|\psi\rangle$  in an abstract Hilbert space  $\mathcal{H}$ , on which the system observables can be described by operators. The evolution of the system state is governed by the Schrödinger equation:

$$|\dot{\psi}(t)\rangle = -iH|\psi(t)\rangle,$$

where the Hamiltonian  $H$  is an Hermitian operator denoting the “energy” observable of the quantum system. Here, the Planck constant  $\hbar$  has been assigned to be 1. If the system is bathed with the external environment, then, instead of the state vector  $|\psi\rangle$ , the system state should be represented by the so-called density operator  $\rho$ , which is Hermitian and positive semi-definite on  $\mathcal{H}$ . The evolution of  $\rho$  can be described by the following master equation [59]:

$$\dot{\rho}(t) = -i[H, \rho(t)] + \mathcal{L}_D[\rho(\tau) | \tau \in [0, t]],$$

where the commutator  $[\cdot, \cdot]$  is defined as  $[A, B] = AB - BA$ . The superoperator  $\mathcal{L}_D[\rho(\tau) | \tau \in [0, t]]$  represents the dissipation in the system due to the interaction with its environment, which depends on the system states in the whole time interval  $[0, t]$ . Under the so-called Markovian approximation to omit the back action effects from the environment, we can obtain a time-local dissipation superoperator  $\mathcal{L}_D[\rho(t)]$ .

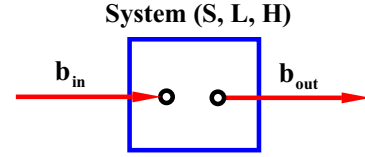

Fig. 1. (Color online). The schematic diagram of the input-output system.

Generally, in quantum optics, the quantum electromagnetic field (e.g., the probe light to be used below) is treated as the collection of the quantized modes whose Hamiltonian reads

$$H_E = \int_{-\infty}^{\infty} d\omega \omega b_{\omega}^{\dagger} b_{\omega},$$

where  $b_{\omega}$  is the annihilation operator of each quantized field mode with frequency  $\omega$ . Each  $b_{\omega}$  acts on the corresponding Hilbert state space spanned by the Fock states  $|n_{\omega}\rangle$ ,  $n_{\omega} = 0, 1, 2, \dots$ , where  $|n_{\omega}\rangle$  represents the state of the quantized field mode that contains  $n_{\omega}$  photons with frequency  $\omega$ , in the way that  $b_{\omega}|n_{\omega}\rangle$  is proportional to  $|n_{\omega} - 1\rangle$ . In addition,  $b_{\omega}$  also satisfies the continuous-variable canonical commutation relationship  $[b_{\omega}, b_{\omega'}^{\dagger}] = \delta(\omega - \omega')$ . Traditionally, we use the time-dependent operator

$$b(t) = \frac{1}{\sqrt{2\pi}} \int d\omega e^{-i\omega t} b_{\omega}$$

to represent the field consisting of a continuum of field modes, which satisfies  $[b(t), b^{\dagger}(t')] = \delta(t - t')$ .

Next, we give a brief review of the theory of the quantum feedback network developed recently [51], [52], [60]–[70]. Consider the general input-output system given in Fig. 1. The input of the quantum plant (with internal Hamiltonian  $H$ )  $\mathbf{b}_{\text{in}}(t) = [b_1(t), \dots, b_n(t)]^T$  contains  $n$  mutually different fields  $b_i(t)$ ,  $i = 1, \dots, n$ , all initially in vacuum states. The input field  $\mathbf{b}_{\text{in}}(t)$  transmits through a quantum beam splitter described by an  $n \times n$  unitary scattering matrix  $\mathbf{S}$ , and then interacts with the plant through the dissipation channels represented by the dissipation operators  $\mathbf{L} = [L_1, \dots, L_n]^T$ . In the following discussions, we will concentrate on the single input case, i.e.,  $n = 1$ , to simplify our discussions.

Let  $V(t)$  be the unitary evolution operator of the composite system of the plant plus the input field (as a quantum system). Correspondingly, the control system can be described by the following quantum stochastic differential equation [68], [71]:

$$\begin{aligned} \frac{dV(t)}{dt} &= b_{\text{in}}^{\dagger}(t)(S - I)V(t)b_{\text{in}}(t) + b_{\text{in}}^{\dagger}(t)LV(t) \\ &\quad - L^{\dagger}SV(t)b_{\text{in}}(t) - \left[ \frac{1}{2}L^{\dagger}L - iH \right] V(t), \end{aligned} \quad (1)$$

with initial value  $V_0 = I$ , where  $I$  is the identity operator. The output field is [72]:

$$b_{\text{out}}(t) = V(t)^{\dagger}SV(t)b_{\text{in}}(t) + V(t)^{\dagger}LV(t). \quad (2)$$

Equation (1) is the Wick-ordered differential equation of  $V_t$  (creators appear on the left, annihilators on the right), which is equivalent to its quantum stochastic differential form (see, e.g., Eq. (30) in Ref. [52]). Here,  $L$  and  $H$  ( $H$  is self-adjoint)

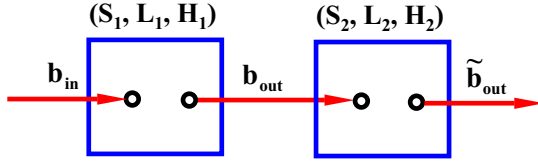

Fig. 2. (Color online). The schematic diagram of the series product system.

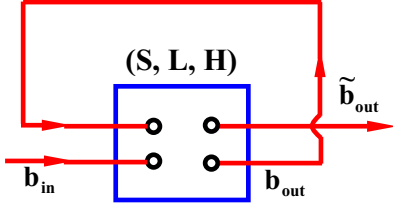

Fig. 3. (Color online). The schematic diagram of the coherent feedback system.

are system operators commuting with fields  $b_{\text{in}}(s)$  and  $b_{\text{in}}^\dagger(s)$  for earlier times  $s < t$ , which means that they are adaptive.  $S$  is unitary satisfying  $S^\dagger S = S S^\dagger = I$ , which, for the one-dimensional case we consider ( $n = 1$ ), is just a phase factor  $S = \exp(i\theta)$ . In a compact notation, the above input-output system can be represented by  $(S, L, H)$ .

After averaging over the vacuum input field  $b_{\text{in}}(t)$  which can be treated as a quantum random process, the system given by Eq. (1) can be transformed to the master equation for the density operator of the plant [52]:

$$\dot{\rho}(t) = -i[H, \rho(t)] + \mathcal{D}[L]\rho(t), \quad (3)$$

where the superoperator  $\mathcal{D}[L]\rho$  is defined as:

$$\mathcal{D}[L]\rho = L\rho L^\dagger - \frac{1}{2}L^\dagger L\rho - \frac{1}{2}\rho L^\dagger L.$$

Let us consider the two cascade systems shown in Fig. 2. By introducing the Markovian approximation to omit the time delay for the output of the first system  $(S_1, L_1, H_1)$  to reach the second system  $(S_2, L_2, H_2)$ , the total system in the series product can be described as follows [52]:

$$\left( S_2 S_1, L_2 + S_2 L_1, H_1 + H_2 + \frac{i}{2} \left( L_1^\dagger S_2^\dagger L_2 - L_2^\dagger S_2 L_1 \right) \right). \quad (4)$$

As a special case, if we feed the output of the system  $(S, L, H)$  back and take it as the input of the same system to construct a direct coherent feedback network as shown in Fig. 3. From Eq. (4), such a feedback network can be described by:

$$\left( S^2, L + SL, H + \frac{i}{2} L^\dagger (S^\dagger - S) L \right). \quad (5)$$

### III. QUANTUM AMPLIFICATION-FEEDBACK LOOP

In order to fulfil strong and controllable feedback-induced nonlinear effects, we consider the modified quantum coherent amplification-feedback loop shown in Fig. 4. There are two differences between the traditional coherent feedback network

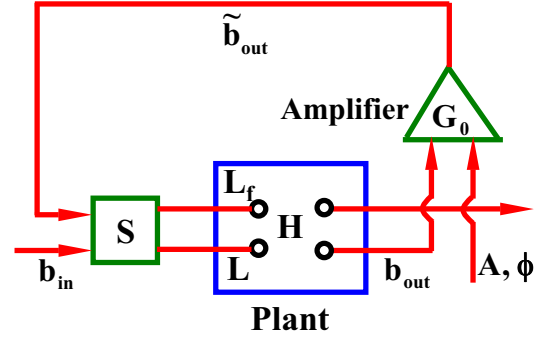

Fig. 4. (Color online). The schematic diagram of the coherent feedback and amplification network.

given in Fig. 3 and the quantum coherent amplification-feedback loop given in Fig. 4. Firstly, the dissipation operator  $L$  which represents the interaction between the system and the input field  $b_{\text{in}}$  may be different from  $L_f$  which represents the interaction between the system and the feedback field  $\tilde{b}_{\text{out}}$ . Secondly, we add a quantum amplifier [73] in the feedback loop, and feed the output field  $b_{\text{out}}(t)$  from the system into it.

The simplest setup to fulfil such a quantum amplifier is a driven squeezed cavity field [74] with the damping rate  $\kappa$  and the tunable squeezing coefficient  $\xi$ , which can be realized by the strategy given in Refs. [75], [76] (see Fig. 5). As presented in Refs. [75], [76], the cavity field is coupled with a three-level atom which is further driven by a classical field. By adiabatically eliminating the degrees of freedom of the auxiliary three-level atom, we can obtain a controllable squeezed field in the cavity in which the squeezed coefficient is tunable by changing the coupling strength between the classical driving field and the three-level atom. This strategy can be extended to the solid-state superconducting circuit by replacing the cavity by a transmission line resonator (TLR) and the three-level atom by an auxiliary flux qubit (see Sec. V in Ref. [77]), which is used to construct an on-chip amplifier in the following discussions.

The Hamiltonian of the controllable squeezed cavity field can be represented, in the rotating frame, as:

$$H_c = \frac{i\xi}{4} (c^{\dagger 2} - c^2) + \sqrt{\kappa} A (e^{i\phi} c + c^\dagger e^{-i\phi}), \quad (6)$$

where  $c$  is the annihilation operator of the cavity field;  $A, \phi \in \mathcal{R}$  represent the normalized amplitude and the initial phase of the classical control field driving the cavity mode. In the  $(S, L, H)$  notation, the squeezed cavity system can be represented by:

$$\left( I, \sqrt{\kappa} c, \frac{i\xi}{4} (c^{\dagger 2} - c^2) + \sqrt{\kappa} A (e^{i\phi} c + c^\dagger e^{-i\phi}) \right). \quad (7)$$

The original system  $(S, L, H)$  and the squeezed field can be looked as a series product system, which can be represented from Eq. (4) as:

$$\left( S, \sqrt{\kappa} c + L, H + H_c + \frac{i}{2} \sqrt{\kappa} (L^\dagger c - c^\dagger L) \right). \quad (8)$$

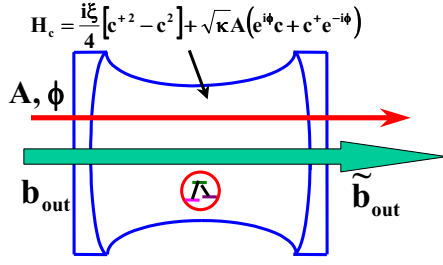

Fig. 5. (Color online). The single-mode squeezed field which works as the quantum amplifier.

The total coherent amplification-feedback loop given in Fig. 4 can be looked as a series product system of the subsystem  $(S, L, H)$ , the quantum amplifier, and the subsystem  $(S, L_f, H)$ , and thus can be described by:

$$\begin{aligned} & (S^2, L_f + S(\sqrt{\kappa}c + L), H + H_c + \frac{i}{2}\sqrt{\kappa}(L^\dagger c - c^\dagger L) \\ & + \frac{i}{2}[(L^\dagger + \sqrt{\kappa}c^\dagger)S^\dagger L_f - L_f^\dagger S(L + \sqrt{\kappa}c)]). \end{aligned} \quad (9)$$

Following the ideas of Refs. [78], [79], we can adiabatically eliminate the degrees of freedom of the cavity mode by the singular perturbation approach to obtain the following master equation (see the derivations in Appendix):

$$\begin{aligned} d\rho = & -i \left[ H + \cosh(r_0) \left( \frac{i}{2}L_f^\dagger S L - \frac{i}{2}L^\dagger S^\dagger L_f \right) \right. \\ & + \sinh(r_0) \left( -\frac{i}{4}(L^\dagger - L_f^\dagger S)(L^\dagger + L_f^\dagger S) + \text{h.c.} \right) \\ & + \left\{ -\frac{i}{2}Ae^{i\phi}[(\cosh(r_0) + 1)(L + S^\dagger L_f) \right. \\ & \left. + \sinh(r_0)(L^\dagger + L_f^\dagger S)] + \text{h.c.} \right\}, \rho \Big] \\ & + \mathcal{D}_s[L - S^\dagger L_f] \rho + \mathcal{D}[L - S^\dagger L_f] \rho, \end{aligned} \quad (10)$$

where

$$\begin{aligned} \mathcal{D}_s[\tilde{L}] \rho = & (N + 1) \mathcal{D}[\tilde{L}] \rho + N \mathcal{D}[\tilde{L}^\dagger] \rho \\ & + M^* (\tilde{L} \rho \tilde{L} - \tilde{L}^2 \rho / 2 - \rho \tilde{L}^2 / 2) \\ & + M (\tilde{L}^\dagger \rho \tilde{L}^\dagger - \tilde{L}^{\dagger 2} \rho / 2 - \rho \tilde{L}^{\dagger 2} / 2), \end{aligned}$$

and

$$r_0 = \ln \left( \frac{\kappa + \xi}{\kappa - \xi} \right), \quad N = \frac{\cosh(2r_0) - 1}{2}, \quad M = -\frac{\sinh(2r_0)}{2}.$$

The two dissipation channels  $\mathcal{D}[L - S^\dagger L_f] \rho$  and  $\mathcal{D}_s[L - S^\dagger L_f] \rho$  are induced by the vacuum field  $b_{\text{in}}$  and the squeezed vacuum field

$$b_{\text{in}}^s = \cosh(r_0) S b_{\text{in}} - \sinh(r_0) b_{\text{in}}^\dagger S^\dagger,$$

where  $b_{\text{in}}^s$  is generated by the quantum amplifier from  $b_{\text{in}}$ , which satisfies that

$$\begin{aligned} b_{\text{in}}^s(t) b_{\text{in}}^{s\dagger}(t') &= (N + 1) \delta(t - t'), \\ b_{\text{in}}^{s\dagger}(t) b_{\text{in}}^s(t') &= N \delta(t - t'), \\ b_{\text{in}}^s(t) b_{\text{in}}^s(t') &= M^* \delta(t - t'), \\ b_{\text{in}}^{s\dagger}(t) b_{\text{in}}^{s\dagger}(t') &= M \delta(t - t'), \end{aligned}$$

Under the adiabatic approximation, the input-out relation of the squeezed component can be written as:

$$\tilde{b}_{\text{out}} = \sqrt{G_0} b_{\text{out}} + \sqrt{G_0 - 1} b_{\text{out}}^\dagger.$$

It can be seen that the squeezed component in this case can be looked as a phase-insensitive quantum amplifier [73], [74] with power gain:

$$G_0 = \cosh^2(r_0) = \frac{(\kappa^2 + \xi^2)^2}{(\kappa - \xi)^2 (\kappa + \xi)^2}. \quad (11)$$

The system we discuss cannot be expressed by the  $(S, L, H)$  notation given in Ref. [52] due to the existence of the squeezed bath term  $\mathcal{D}_s[L - S^\dagger L_f] \rho$ . However, it can be checked that Eq. (10) coincides with those equations in Ref. [69] for linear quantum systems, in which linear quantum dynamical network elements including static Bogoliubov components (such as squeezers [80], [81] discussed here) are formulated by the transfer function and input-output equation.

If the power gain of the quantum amplifier  $G_0$  is far greater than 1, the master equation (10) can be simplified as:

$$\dot{\rho} = -i[H_{\text{eff}}, \rho] + G_0 \mathcal{D} \left[ \frac{1}{2} (L - L^\dagger + L_f^\dagger S - S^\dagger L_f) \right] \rho, \quad (12)$$

where

$$\begin{aligned} H_{\text{eff}} = & H + \sqrt{G_0} \left( \frac{i}{2}L_f^\dagger S L - \frac{i}{2}L^\dagger S^\dagger L_f \right) \\ & + \sqrt{G_0} \left[ -\frac{i}{4}(L^\dagger - L_f^\dagger S)(L^\dagger + L_f^\dagger S) + \text{h.c.} \right] \\ & + \sqrt{G_0} A \cos \phi (L + L^\dagger + S^\dagger L_f + L_f^\dagger S) \end{aligned} \quad (13)$$

represents the effective Hamiltonian under coherent feedback. One can immediately see that the system Hamiltonian has been reconstructed by the feedback loop involving the following tuple of parameters:

$$\mathbf{C} = \{S, L, L_f, G_0, A, \phi\},$$

which can be properly designed to realize desired quantum dynamics in the closed-loop system. Note that these parameters can also be chosen to be time-variant to get more flexibility, but such a case will not be discussed in this paper.

A system is said to be linear if its Hamiltonian  $H$  as a polynomial of the annihilation and creation operators  $a$  and  $a^\dagger$  is up to the second-order and the dissipation operator  $L$  is a linear combination of  $a$  and  $a^\dagger$ , otherwise it is said to be nonlinear. Obviously, in Eq. (9), nonlinear dynamics can be generated by

$$\begin{aligned} H_{nl} = & \sqrt{G_0} \left[ -\frac{i}{4}(L^\dagger - L_f^\dagger S)(L^\dagger + L_f^\dagger S) + \text{h.c.} \right] \\ & + \sqrt{G_0} \left( \frac{i}{2}L_f^\dagger S L - \frac{i}{2}L^\dagger S^\dagger L_f \right), \end{aligned} \quad (14)$$

if  $L$  or  $L_f$  is a second-order or higher-order polynomial of the annihilation and creation operators. What we have discussed above is the concept of *feedback nonlinearization*. More importantly, strong nonlinear effects can be produced

provided that the power gain  $G_0$  of the quantum amplifier in the coherent feedback loop is sufficiently high.

In practical experiments, the power gain of the quantum amplifier cannot be too large. For example, in optical systems, the quantum amplifiers are typically implemented using a nonlinear optical material. Thus, the production of a high gain amplifier may require an optical material with strong nonlinearity which is hard to be realized. One possible solution of this problem is to cascade a series of low gain quantum amplifiers to obtain a high gain just like what we have done for classical systems. There is also a great progress for nonlinear amplification in solid-state quantum systems such as superconducting circuits. For example, as shown in Ref. [82], the authors found that quantum signals can be greatly amplified near the bifurcation point of a nonlinear quantum device, which has been improved by the succeeding experiments. Thus, it is possible to realize a quantum amplifier with high gain in solid state systems other than optical systems.

The idea of the above feedback nonlinearization strategy can be demonstrated in the following simple model. Let the plant be a single-mode field with normalized position and momentum operators as  $x = (a + a^\dagger)/\sqrt{2}$  and  $p = (-ia + ia^\dagger)/\sqrt{2}$ . The internal Hamiltonian of the field is  $H = \omega a^\dagger a$ . We choose  $L = \sqrt{\gamma}x^2$ ,  $L_f = \sqrt{\gamma}x$  and  $S = e^{i\pi/2}$  respectively. If we coherently feed back the quantum signal (i.e., being an operator):

$$b_{\text{out}}(t) = \sqrt{\gamma}x^2 + b_{\text{in}}(t),$$

where  $b_{\text{in}}$  is the input vacuum noise, then  $H_{\text{nl}}$  given in Eq. (14) contains third-order nonlinear terms of  $x$  and  $p$ .

In comparison, the feedback signal in the measurement-based quantum feedback scheme [47] is a classical signal (i.e., being a scalar):

$$\bar{b}_{\text{out}}(t) = \sqrt{\gamma}\langle x^2 \rangle + \xi(t),$$

where  $\langle A \rangle = \text{tr} A\rho$  is the average over the system state  $\rho$ , and  $\xi(t)$  is a classical white noise satisfying:

$$E(\xi(t)) = 0, \quad E(\xi(t)\xi(t')) = \delta(t - t').$$

It has been shown in Ref. [47] that such a feedback loop can only introduce ‘‘classical’’ nonlinearity for the controlled quantum system. In fact, statistically, only the trajectories of the expectation values of the operators  $x$  and  $p$  behave nonlinearly. Those of the higher-order quadratures remain linearly, which can only be altered by fully quantum nonlinear Hamiltonian terms such as  $H_{\text{nl}}$  introduced by the coherent feedback. Such fully quantum nonlinear dynamics is essential to important physical applications such as light squeezing and the generation of the Kerr effect.

#### IV. GENERATION OF STRONG KERR EFFECTS

In this section, we will introduce the coherent feedback to generate strong and controllable nonlinear effects in the following two systems:

- (1) Kerr effect in a single-mode field with the annihilation operator  $a$ , where the nonlinear Hamiltonian to be constructed is  $H_{\text{Kerr}} = \chi (a^\dagger a)^2$ ,  $\chi \in \mathcal{R}$ ;

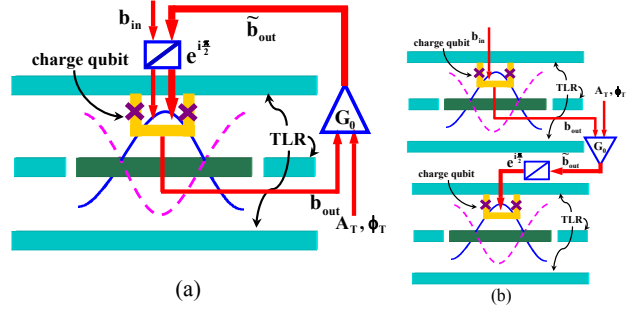

Fig. 6. (Color online). Schematic diagrams of the superconducting circuits to generate strong and controllable Kerr and cross-Kerr effects by coherent feedback and feedforward with (a) for Kerr nonlinearity and (b) for cross-Kerr nonlinearity.

- (2) Cross Kerr effect in a two-mode field with the annihilation operators  $a$  and  $b$ , where the nonlinear Hamiltonian is  $H_{\text{cross-Kerr}} = \chi_{ab} (a^\dagger a) (b^\dagger b)$ ,  $\chi_{ab} \in \mathcal{R}$ .

The generation of strong Kerr and cross-Kerr effects is crucial to nonlinear quantum optical phenomena, and has important applications to the generation of particular quantum states, e.g., the Schrödinger cat state [83] and universal quantum computation [84], i.e., the construction of two-qubit CNOT gate. Let us see how the Kerr effect can be generated in on-chip quantum optics [55]–[58] realized by the superconducting circuit [85]–[87] shown in Fig. 6(a). The vacuum input field  $b_{\text{in}}$  transmits through a  $\pi/2$  phase shifter which can be implemented by the on-chip quantum beam splitter [88] proposed recently. Then, the output field of the phase shifter is coupled to the fundamental mode of the electric field in a TLR via a charge qubit.

The Hamiltonian of the coupled qubit-TLR system can be expressed as [85]–[87]:

$$H_{qT} = 4E_C (n - n_g)^2 - 2E_J \cos\left(\pi \frac{\Phi_x}{\Phi_0}\right) \cos\phi + \omega_a a^\dagger a, \quad (15)$$

where  $\omega_a$  and  $a$  are the angular frequency and the annihilation operator of the electric field in the TLR;  $\phi$  is a phase operator denoting the phase drop across the superconducting loop of the charge qubit;  $n = -i\partial/\partial\phi$  is the conjugate operator of  $\phi$ , which represents the number of Cooper pairs on the island electrode of the charge qubit; the reduced charge number  $n_g$  on the gate of the charge qubit, in units of the Cooper pairs, can be given by  $n_g = -C_g V_g / 2e$ ;  $C_g$  and  $V_g$  are the gate capacitance and gate voltage;  $E_C = e^2/2(C_g + 2C_J^0)$  is the single-electron charging energy of the charge qubit;  $E_J^0$  and  $C_J^0$  represent the Josephson energy and the capacitance of a single Josephson junction; and  $\Phi_0$  is the quantum flux.  $\Phi_x$  in Eq. (15) denotes the external flux piercing the SQUID loop of the charge qubit which can be expressed as:

$$\Phi_x = \Phi_e + \eta_T (a + a^\dagger) + \eta_{\text{in}} (b_{\text{in}} + b_{\text{in}}^\dagger), \quad (16)$$

where  $\Phi_e$  is the flux generated by the classical magnetic field through the SQUID loop, and  $\eta_T$ ,  $\eta_{\text{in}}$  have units of magnetic flux and their absolute values represent the strengths of the quantum flux in the SQUID loop induced by the electric

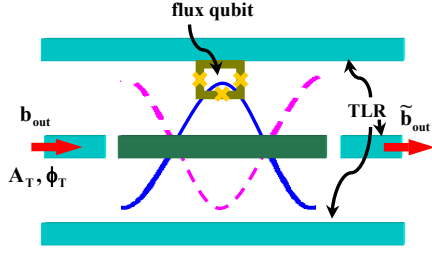

Fig. 7. (Color online). Schematic diagram of the quantum amplifier in superconducting circuit.

field in the TLR and the input field  $b_{\text{in}}$ . Let  $n_g = 1/2$ ,  $\Phi_e = -\Phi_0/2$ , and adiabatically eliminate the degrees of freedom of the charge qubit, we can obtain the following effective Hamiltonian to represent the coupling between the TLR and the input field (see the derivations in Appendix):

$$H_T = \omega_a a^\dagger a - \frac{\pi^3 \eta_T^2 \eta_{\text{in}}^2}{\Phi_0^3} a^\dagger a (b_{\text{in}} + b_{\text{in}}^\dagger). \quad (17)$$

Here, we have omitted the linear term of  $a$  and  $a^\dagger$ , which can be compensated by a classical driving field imposed on the TLR.

With the  $(S, L, H)$  notations, such a system can be expressed as:

$$H = \omega_a a^\dagger a, \quad L = \sqrt{\gamma_a} a^\dagger a, \quad S = e^{i\pi/2},$$

where

$$\gamma_a = \frac{\pi^6 \eta_T^4 \eta_{\text{in}}^2}{\Phi_0^6}$$

is the damping rate of the TLR induced by the input field. The output field of the system is fed into a quantum amplifier, and then fed back into the plant via the damping channel represented by  $L_f = \sqrt{\gamma_a} a^\dagger a$ .

As analyzed in Sec. III, the quantum amplifier used here can be implemented by a squeezed cavity field with a tunable squeezed coefficient  $\xi$ , which can be realized by the superconducting circuit given in Fig. 7. In this circuit, a transmission line resonator is driven by the quantum input field  $b_{\text{out}}$  and a classical driving field

$$I(t) = A_T \cos(\omega_T t + \phi_T),$$

where the angular frequency of the driving field is equal to the angular frequency  $\omega_T$  of the fundamental mode of the electric field in the quantum amplifier, i.e., the TLR. The output field of the quantum amplifier is  $\tilde{b}_{\text{out}}$ . The TLR is coupled with a flux qubit which works as a  $\Delta$ -shaped three-level artificial atom [89]. As discussed in Sec. V of Ref. [77], by adiabatically eliminating the degrees of freedom of the flux qubit, the effective Hamiltonian of the quantum amplifier can be written under the rotating wave approximation as:

$$H_{\text{eff}} = \omega_T c^\dagger c + \frac{\xi}{4} \left[ e^{i(\Omega t + \psi)} c^2 + c^{\dagger 2} e^{-i(\Omega t + \psi)} \right] + A_T \left[ e^{i(\omega_T t + \phi_T)} c + c^\dagger e^{-i(\omega_T t + \phi_T)} \right],$$

where  $c$  is the annihilation operator of the quantum amplifier, and  $\xi$ ,  $\Omega$ , and  $\psi$  are tunable parameters. Let  $\Omega = 2\omega_T$ ,  $\psi = -\pi/2$ , the effective Hamiltonian  $H_{\text{eff}}$  can be written in the interaction picture as  $H_c$  given in Eq. (6). With the experimentally realizable parameters, the squeezed coefficient  $\xi$  can be as large as the damping rate of the quantum amplifier  $\kappa$  (see, e.g., Ref. [77]). Thus, the quantum amplifier with large power gain  $G_0$  given in Eq. (11) can be obtained if we tune the squeezed coefficient  $\xi$  such that  $\xi \approx \kappa$ .

With this setup and under the condition that  $G_0 \gg 1$ , a nonlinear Hamiltonian of the closed-loop dynamics of the superconducting circuit shown in Fig. 6(a) can be reconstructed:

$$\tilde{H} = (\omega_a - \delta) a^\dagger a + \chi (a^\dagger a)^2, \quad (18)$$

where  $\delta = 2A_T \sqrt{G_0 \gamma_a}$  and  $\chi = 2\sqrt{G_0 \gamma_a}$  are the angular frequency shift and the strength of the nonlinear Kerr effect induced by the coherent feedback control respectively. As shown in Eq. (18), the Kerr effect is enhanced by increasing the power gain  $G_0$ , which can be done with the on-chip amplification device [73]. As a numerical example, if the parameters  $\omega_a/2\pi = 500$  MHz,  $\gamma_a/2\pi = 1$  MHz,  $A_T^2/2\pi = 576$  MHz, and the power gain of the quantum amplifier  $G_0 = 100$ , then it can be calculated that

$$(\omega_a - \delta)/2\pi = \chi/2\pi = 20 \text{ MHz}.$$

The strength of the generated Kerr term, which is comparable with that of the lower-order term, is about  $10^4 - 10^5$  stronger than the Kerr effect induced by the natural coupling between the electric field in TLR and the nonlinear element in superconducting circuit (only around tens of kHz). Thus, with experimentally realizable parameters, the coherent feedback strategy may dramatically enlarge the nonlinear Kerr effect.

Furthermore, using the same idea, if the plant includes another superconducting circuit whose TLR annihilation operator is  $b$  (see Fig. 6(b)), we can feed the amplified output field into this circuit via  $L_f = \sqrt{\gamma_b} b^\dagger b$ , and a cross-Kerr Hamiltonian is obtained as below:

$$H_{\text{cross-Kerr}} = \chi_{ab} a^\dagger a b^\dagger b,$$

whose strength  $\chi_{ab} = 2\sqrt{G_0 \gamma_a \gamma_b}$  can also be enhanced by increasing the amplification gain  $G_0$ .

## V. CONTROLLABLE FOURTH-ORDER NONLINEAR DYNAMICS

This section will focus on the design of a controllable fourth-order TLR Hamiltonian:

$$H_{\text{eff}} = \omega_a a^\dagger a + \sum_{k=1}^4 \chi_k x_a^k, \quad (19)$$

where  $x_a = (a^\dagger + a)/\sqrt{2}$  is the normalized position operator of the TLR; and  $\chi_k$ ,  $k = 1, 2, 3, 4$  are the coefficients of the  $k$ -th order quadratures, which are all tunable parameters.  $H_{\text{eff}}$  given in Eq. (19) can be used to produce more interesting nonlinear quantum effects. The terms in Eq. (19) have different applications, e.g., the  $\chi_2$ -term can be used to realize controllable squeezing in TLR [62]; the  $\chi_3$ -term can be used to construct the cubic phase gate which is fundamental to realize

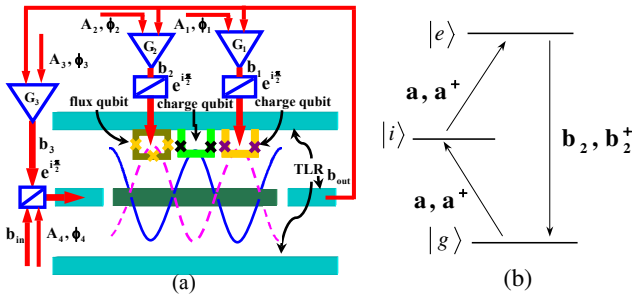

Fig. 8. (Color online). (a) Schematic diagram used to generate the fourth-order controllable Hamiltonian given in Eq. (19). (b) The  $\Delta$ -shape transition of the auxiliary flux qubit.

universal continuous variable quantum computation [90]; and the  $\chi_4$  term is useful for generating the Kerr effect. More importantly, as shown below, the nonlinear Hamiltonian given in Eq. (19) can be used to generate non-Gaussian “light” (microwave field) to show fully quantum sub-Poisson photoncount statistics and photon antibunching phenomenon [54]. The non-Gaussian “light” generated is possible to be used to transmit quantum information, which may have higher capacity of the information transmission than the Gaussian light in continuous variable quantum communication [91].

Such a nonlinear Hamiltonian can be constructed via the superconducting circuit in Fig. 8(a), where a TLR is coupled with a flux qubit (left) and two charge qubits (central, and right). The central charge qubit works as an auxiliary device for the quantum detection. By tuning the parameters of this auxiliary charge qubit, we can execute a detection of the square of the normalized position operator  $x_a$  by the probe field through the TLR. With this detection, we can obtain a quadratic damping operator  $L = \sqrt{\gamma}x_a^2$ , where  $\gamma$  is the related damping rate. This is similar to the quantum measurement strategy given in Ref. [92] to detect the square of the normalized position operator of a nanomechanical resonator. The charge qubit on the right plays the same role as in Sec. IV to induce a nonlinear Kerr term. The flux qubit in the circuit can be treated as a three-level artificial atom with  $\Delta$ -shape transition [89], [93], whose interaction with the electric field in the TLR induces another nonlinear Hamiltonian. As shown in Fig. 8(b), a two-photon exchange process occurs between the cavity mode  $a$  in the TLR and the travelling-wave mode  $b_2$  via the flux qubit, i.e., the  $\Delta$ -shaped three-level artificial atom. Two photons in the cavity mode  $a$  with the same angular frequency  $\omega_a$  annihilate, and one photon in the travelling-wave mode  $b_2$  is created in this process, and vice versa. Finally, the output field is coherently fed back after amplification to drive the electric field in the TLR, which leads to a third nonlinear Hamiltonian.

Mathematically, the above setup results in three feedback loops with

$$\begin{aligned} S_1 &= S_2 = S_3 = e^{i\pi/2}, \\ L_1 &= L_2 = L_3 = \sqrt{\gamma}x_a^2, \\ L_{1f} &= \sqrt{\gamma_1}a^\dagger a, \quad L_{2f} = \sqrt{\gamma_2}a^{\dagger 2}, \quad L_{3f} = \sqrt{\gamma_3}x_a. \end{aligned}$$

The corresponding parameters  $A_j, \phi_j, j = 1, 2, 3, 4$  of the

inputs of the quantum amplifiers and the phase shifters are tunable parameters need to be designed. Here, we let  $\phi_1 = \phi_2 = 0, \phi_3 = -\pi, \phi_4 = -\pi/2$ . From Eq. (13), we can obtain the desired effective Hamiltonian (19) with

$$\begin{aligned} \chi_1 &= A_4\sqrt{2\gamma}, \quad \chi_2 = 4A_1\sqrt{G_1\gamma_1} - 2A_3\sqrt{G_3\gamma_3}, \\ \chi_3 &= 2\sqrt{G_3\gamma_3}, \quad \chi_4 = 2\sqrt{G_1\gamma_1}, \end{aligned}$$

where we have set parameters  $G_2 = G_1\gamma_1/\gamma_2$  and  $A_2 = A_1\sqrt{\gamma_2/\gamma_1}$  in order to obtain the Hamiltonian form shown in Eq. (19). Therefore, by tuning the control parameters  $G_1, G_3, A_1, A_3$ , and  $A_4$ , we can independently change the coefficients  $\chi_k, k = 1, 2, 3, 4$ .

These nonlinear terms can be designed to generate nonclassical microwave field (i.e., the so-called nonclassical “light”) in TLR. To illustrate the effectiveness of the coherent feedback scheme, we set the parameters:

$$\begin{aligned} \omega_a/2\pi &= 100 \text{ MHz}, \quad \gamma_1/2\pi = \gamma_3/2\pi = 1 \text{ MHz}, \\ \gamma/2\pi &= 1 \text{ MHz}, \quad G_1 = G_3 = 10^3, \\ A_1^2/2\pi &= 40 \text{ MHz}, \quad A_3^2/2\pi = 152.1 \text{ MHz}, \\ A_4^2/2\pi &= 200 \text{ MHz}. \end{aligned}$$

As shown in Fig. 9(a), we can observe the sub-Poisson photoncount statistics indicating by the fano factor

$$F = (\langle N_a^2 \rangle - \langle N_a \rangle^2) / \langle N_a \rangle < 1,$$

and the photon antibunching phenomenon indicated by

$$g^{(2)}(\tau) > g^{(2)}(0),$$

where  $N_a = a^\dagger a$  is the photon number operator of the TLR;  $\langle \cdot \rangle$  is the average over the system state; and the normalized second-order correlation function  $g^{(2)}(\tau)$  is defined by:

$$g^{(2)}(\tau) = \frac{\langle a^\dagger(t) a^\dagger(t+\tau) a(t+\tau) a(t) \rangle}{\langle a^\dagger(t) a(t) \rangle^2}.$$

Here  $a(t)$  is the operator in the Heisenberg picture defined by  $\text{tr}(a(t)\rho_0) = \text{tr}(a\rho(t))$ , where  $\rho_0$  and  $\rho(t)$  are the initial state of the system and the state of the system at time  $t$ . Sub-Poisson photoncount statistics and photon antibunching phenomenon are typical quantum phenomena which violate the Cauchy-Schwartz inequality for the classical lights. Additionally, different from the Gaussian lights, e.g., the laser, which are quite similar to classical lights, the on-chip light generated is indeed a non-Gaussian light, which is highly nonclassical. In Fig. 9(b), we use the measure

$$\delta[\rho] = \frac{\text{tr}[(\rho - \sigma)^2/2]}{\text{tr}[\rho^2]} \in [0, 1]$$

to evaluate the non-Gaussian degree of the light generated [94], where  $\sigma$  is a Gaussian state with the same first and second-order quadratures of the non-Gaussian state  $\rho$ . Simulation results in Fig. 9(b) show that high-quality non-Gaussian state with  $\delta[\rho] > 0.25$  can be obtained. As pointed out by Ref. [95], the maximal value of  $\delta[\rho]$  is not larger than 1/2 for single-mode quantum states. Thus, the non-Gaussian degree of the generated light can be larger than half of the maximal value that can be reached by any non-Gaussian states.

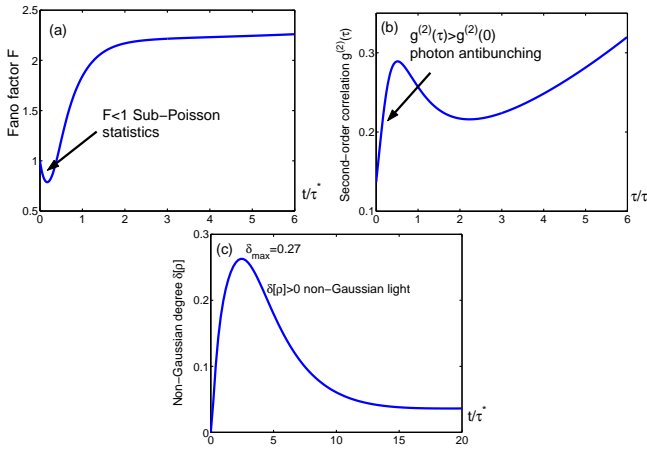

Fig. 9. (Color online) (a) Fano factor  $F(t)$  and (b) the normalized second-order correlation function  $g^{(2)}(\tau)$ : the sub-Poisson photoncount statistics indicating by  $F < 1$  and the photon antibunching indicating by  $g^{(2)}(\tau) > g^{(2)}(0)$  seen in small time scale exhibit the nonclassical properties of the light generated. (c) non-Gaussian measure  $\delta[\rho]$ : a highest value 0.27 can be attained, and it is shown that the stationary state of the electric field is also non-Gaussian and thus nonclassical state.  $\tau^* = 0.2$  ns is a normalized time-scale.

Finally, it should be pointed out that the decoherence (i.e., the destruction of quantum coherence) rate will also be increased by the quantum amplifier that is designed to enhance the nonlinear effect. Thus, there is a tradeoff between pursuing strong nonlinear effect and weak decoherence, which may somewhat limit the ability of effectively manipulating nonlinear quantum optical phenomena, e.g., the generation of Schrödinger cat state. This problem will hopefully be solved by introducing a nonlinear amplifier whose signal/noise ratio is high.

## VI. CONCLUSION

In summary, we present a method of engineering strong and controllable nonlinear effects in quantum systems by coherent feedback control and amplification. A byproduct of this investigation is the introduction of the concept of feedback nonlinearization which is very useful for quantum feedback control systems. To the authors' knowledge this concept has never been discussed in the literature. The applications in TLR superconducting circuits demonstrate its power of generating strong and controllable nonlinear Kerr and cross-Kerr effects and more complex nonlinear phenomena. They open up new perspectives to the design of nonlinear circuits for quantum optics on chip, where the systematic design methodology of the feedback loop parameters, including  $S$ ,  $G_0$ , etc., for more complex nonlinearities and large-scale circuits are interesting topics to be studied in the future. There is still a problem left. In our method, the decoherence will be enhanced if we want to generate stronger quantum nonlinearity, which may limit our ability to manipulate nonlinear quantum effects, e.g., the generation of Schrödinger cat state. This problem is also left for the future study.

## APPENDIX

*Derivation of Eq. (10):* To adiabatically eliminate the degrees of freedom of the squeezed cavity field, we introduce the singular perturbation approach [78] to let  $\kappa = \kappa_0/\epsilon$ ,  $\xi = \xi_0/\epsilon$ , and let  $\epsilon \rightarrow 0$  in the final step. In this case, the total system composed of the system  $(S, L, H)$ , the squeezed cavity field, and the system  $(S, L_f, H)$  can be described by:

$$\begin{aligned} & \left( S^2, L_f + S \left( \sqrt{\frac{\kappa_0}{\epsilon}} c + L \right), H + \frac{i\xi_0}{4\epsilon} (c^{\dagger 2} - c^2) \right. \\ & \left. + \sqrt{\frac{\kappa_0}{\epsilon}} A (e^{i\phi} c + c^\dagger e^{-i\phi}) + \frac{i}{2} \sqrt{\frac{\kappa_0}{\epsilon}} (L^\dagger c - c^\dagger L) \right. \\ & \left. + \frac{i}{2} (L^\dagger S^\dagger L_f - L_f^\dagger S L) + \frac{i}{2} \sqrt{\frac{\kappa_0}{\epsilon}} (c^\dagger S^\dagger L_f - L_f^\dagger S C) \right). \end{aligned} \quad (20)$$

From Eq. (30) in Ref. [52] and Eq. (20), the dynamical equation of the evolution operator  $U_t(\epsilon)$  of the total system can be expressed as:

$$\begin{aligned} dU_t(\epsilon) = & \left\{ (S^2 - I) d\Lambda_t + dB_t^\dagger \left( L_f + SL + \sqrt{\frac{\kappa_0}{\epsilon}} S c \right) \right. \\ & - \left( L_f^\dagger + L^\dagger S^\dagger + \sqrt{\frac{\kappa_0}{\epsilon}} c^\dagger S^\dagger \right) S^2 dB_t \\ & - \frac{1}{2} \left( L_f^\dagger + L^\dagger S^\dagger + \sqrt{\frac{\kappa_0}{\epsilon}} c^\dagger S^\dagger \right) \\ & \left( L_f + SL + \sqrt{\frac{\kappa_0}{\epsilon}} S c \right) dt \\ & - i \left[ H + \frac{i}{2} (L^\dagger S^\dagger - L_f^\dagger S L) + \frac{i\xi_0}{4\epsilon} (c^{\dagger 2} - c^2) \right. \\ & \left. + \sqrt{\frac{\kappa_0}{\epsilon}} \left( \left( \frac{i}{2} (L^\dagger - L_f^\dagger S) + A e^{i\phi} \right) c \right. \right. \\ & \left. \left. + c^\dagger \left( -\frac{i}{2} (L - S^\dagger L_f) + A e^{-i\phi} \right) \right) \right] dt \left. \right\} U_t(\epsilon), \end{aligned}$$

where

$$\Lambda_t = \int_0^t b_{\text{in}}^\dagger(\tau) b_{\text{in}}(\tau) d\tau, \quad B_t = \int_0^t b_{\text{in}}(\tau) d\tau.$$

In order to eliminate the degrees of freedom of the cavity mode in the singular limit  $\epsilon \rightarrow 0^+$ , we change to the interaction picture by introducing the time evolution operator  $V_t$ , which satisfies that:

$$\begin{aligned} dV_t(\epsilon) = & \left[ (S^2 - I) d\Lambda_t + dB_t^\dagger \left( L_f + SL + \sqrt{\frac{\kappa_0}{\epsilon}} S c \right) \right. \\ & - \left( L_f^\dagger + L^\dagger S^\dagger + \sqrt{\frac{\kappa_0}{\epsilon}} c^\dagger S^\dagger \right) S^2 dB_t \\ & - \frac{1}{2} \left( L_f^\dagger + L^\dagger S^\dagger + \sqrt{\frac{\kappa_0}{\epsilon}} c^\dagger S^\dagger \right) \\ & \left( L_f + SL + \sqrt{\frac{\kappa_0}{\epsilon}} S c \right) dt \\ & \left. + \frac{\xi_0}{4\epsilon} (c^{\dagger 2} - c^2) dt \right] V_t(\epsilon). \end{aligned} \quad (21)$$

Then, we want to consider the evolution of the unitary operator  $\tilde{U}_t(\epsilon) = V_t^\dagger(\epsilon) U_t(\epsilon)$ , which satisfies that

$$\frac{d\tilde{U}_t(\epsilon)}{dt} = -i\tilde{H}(\epsilon)\tilde{U}_t(\epsilon). \quad (22)$$



The Hamiltonian  $\tilde{H}(\epsilon)$  is defined by  $\tilde{H}(\epsilon) =$  where  $V_t^\dagger(\epsilon) H(\epsilon) V_t(\epsilon)$ , where

$$H(\epsilon) = \sqrt{\frac{\kappa_0}{\epsilon}} \left\{ \left[ \frac{i}{2} (L^\dagger - L_f^\dagger S) + A e^{i\phi} \right] c + \text{h.c.} \right\} + H + \frac{i}{2} (L^\dagger S^\dagger L_f - L_f^\dagger S L).$$

Then, we introduce the normalized cavity mode in the interaction picture:

$$\tilde{b}_t(\epsilon) = -\sqrt{\frac{\kappa_0}{4\epsilon}} V_t^\dagger(\epsilon) c V_t(\epsilon).$$

From Eq. (21), it can be verified that

$$d\tilde{b}_t(\epsilon) = -\frac{\kappa_0}{2\epsilon} \tilde{b}_t(\epsilon) dt + \frac{\xi_0}{2\epsilon} \tilde{b}_t^\dagger(\epsilon) dt + \frac{\kappa_0}{2\epsilon} \left[ \frac{1}{2} (L + S^\dagger L_f) dt + S dA_t \right]. \quad (23)$$

It can be solved from Eq. (23) that

$$\begin{aligned} \tilde{b}_t(\epsilon) &= \sqrt{\frac{\epsilon}{\kappa_0}} \left[ G_{1\epsilon}(t) (c + c^\dagger) + G_{2\epsilon}(t) (c - c^\dagger) \right] \\ &+ \frac{\kappa_0}{\kappa_0 - \xi_0} \int_0^t G_{1\epsilon}(t - \tau) \left[ \frac{1}{2} (L + S^\dagger L_f) d\tau + S dA_\tau + \text{h.c.} \right] \\ &+ \frac{\kappa_0}{\kappa_0 + \xi_0} \int_0^t G_{2\epsilon}(t - \tau) \left[ \frac{1}{2} (L + S^\dagger L_f) d\tau + S dA_\tau - \text{h.c.} \right], \end{aligned} \quad (24)$$

where

$$G_{1\epsilon}(t) = \frac{\kappa_0 - \xi_0}{4\epsilon} \exp\left(-\frac{(\kappa_0 - \xi_0)|\tau|}{2\epsilon}\right),$$

$$G_{2\epsilon}(t) = \frac{\kappa_0 + \xi_0}{4\epsilon} \exp\left(-\frac{(\kappa_0 + \xi_0)|\tau|}{2\epsilon}\right).$$

From Eq. (22), we have

$$\begin{aligned} \frac{d}{dt} \tilde{U}_t(\epsilon) &= -i \left\{ \left[ -i (L^\dagger - L_f^\dagger S) - 2A e^{i\phi} \right] \tilde{b}_t(\epsilon) \right. \\ &+ \tilde{b}_t^\dagger(\epsilon) \left[ i (L - S^\dagger L_f) - 2A e^{-i\phi} \right] \\ &\left. + H + \frac{i}{2} (L^\dagger S^\dagger L_f - L_f^\dagger S L) \right\} \tilde{U}_t(\epsilon) dt. \end{aligned} \quad (25)$$

Substituting Eq. (24) into Eq. (25) and letting  $\epsilon \rightarrow 0$  (it is a weak convergence in the meaning of Ref. [78]), we have

$$\begin{aligned} d\tilde{U}_t &= -i \left\{ \left[ -\frac{i}{4} (L^\dagger - L_f^\dagger S) (\cosh(r_0) (L + S^\dagger L_f) \right. \right. \\ &+ \sinh(L^\dagger + L_f^\dagger S)) + \text{h.c.} \left. \right] dt \\ &+ \left[ -\frac{1}{2} A e^{i\phi} ((\cosh(r_0) + 1) (L + S^\dagger L_f) \right. \\ &+ \sinh(r_0) (L^\dagger + L_f^\dagger S)) + \text{h.c.} \left. \right] dt + H dt \\ &- \frac{i}{2} (L^\dagger - L_f^\dagger S) dB_t^s + \frac{i}{2} (L - S^\dagger L_f) dB_t^{s\dagger} \\ &- \frac{i}{2} (L^\dagger - L_f^\dagger S) S dB_t \\ &\left. + \frac{i}{2} (L - S^\dagger L_f) dB_t^\dagger S^\dagger \right\} \tilde{U}_t, \end{aligned} \quad (26)$$

$$dB_t^s = \cosh(r_0) S dB_t + \sinh(r_0) dB_t^\dagger S^\dagger.$$

Here, we have used the limit

$$G_\epsilon(\tau) = \frac{\kappa}{4\epsilon} \exp\left(-\frac{\kappa|\tau|}{2\epsilon}\right) \rightarrow \delta(\tau), \quad \epsilon \rightarrow 0.$$

Since  $\rho = \text{tr}_E \left[ \left( \tilde{U}_t \rho_0 \tilde{U}_t^\dagger \right) / \text{tr} \left( \tilde{U}_t \rho_0 \tilde{U}_t^\dagger \right) \right]$  where  $\text{tr}_E(\cdot)$  is the partial trace over the Hilbert space of the noise  $dB_t$ , we can obtain the master equation (10) of  $\rho$  from Eq. (26) with simple calculations. Note that the map

$$T(t) : \rho_0 \mapsto \text{tr}_E \left[ \left( \tilde{U}_t \rho_0 \tilde{U}_t^\dagger \right) / \text{tr} \left( \tilde{U}_t \rho_0 \tilde{U}_t^\dagger \right) \right]$$

has good properties, because the final master equation (10) is of the traditional form of squeezing environment which has been widely studied in quantum optics [96], [97].

*Derivation of Eq. (17):* Near the optimal point  $n_g = 1/2$ , the two energy levels of the charge qubit corresponding to  $n = 0, 1$  are close to each other and far separated from higher-energy levels. Thus, in this case, the charge qubit can be looked as a two-level system [85]–[87]. The Hamiltonian  $H_{qT}$  in Eq. (15) can be written as:

$$H_{qT} = -2E_C (1 - 2n_g) \tilde{\sigma}_z - E_J^0 \cos\left(\pi \frac{\Phi_x}{\Phi_0}\right) \tilde{\sigma}_x + \omega_a a^\dagger a,$$

where the Pauli operators  $\tilde{\sigma}_z$  and  $\tilde{\sigma}_x$  are defined by:

$$\begin{aligned} \tilde{\sigma}_z &= |0\rangle\langle 0| - |1\rangle\langle 1|, \\ \tilde{\sigma}_x &= |0\rangle\langle 1| + |1\rangle\langle 0|, \end{aligned}$$

and  $|0\rangle$  and  $|1\rangle$  are the charge states with the Cooper pairs numbers  $n = 0, 1$ .

When  $n_g = 1/2$ , the charge qubit is in the charge degenerate point. In this case,  $H_{qT}$  can be rewritten using the eigenstates of the charge qubit as:

$$\begin{aligned} H_{qT} &= \omega_a a^\dagger a - E_J^0 \cos\frac{\pi}{\Phi_0} [\Phi_e + \eta_T (a + a^\dagger) \\ &+ \eta_{\text{in}} (b_{\text{in}} + b_{\text{in}}^\dagger)] \sigma_z, \end{aligned}$$

where

$$\sigma_z = |+\rangle\langle +| - |-\rangle\langle -|,$$

and

$$\begin{aligned} |+\rangle &= \frac{1}{\sqrt{2}} |0\rangle + \frac{1}{\sqrt{2}} |1\rangle, \\ |-\rangle &= -\frac{1}{\sqrt{2}} |0\rangle + \frac{1}{\sqrt{2}} |1\rangle. \end{aligned}$$

Since  $\Phi_e = -\Phi_0/2$ , we have

$$\begin{aligned} H_{qT} &= -E_J^0 \left[ \sin\frac{\pi}{\Phi_0} \eta_T (a + a^\dagger) \cos\frac{\pi}{\Phi_0} \eta_{\text{in}} (b_{\text{in}} + b_{\text{in}}^\dagger) \right. \\ &+ \cos\frac{\pi}{\Phi_0} \eta_T (a + a^\dagger) \sin\frac{\pi}{\Phi_0} \eta_{\text{in}} (b_{\text{in}} + b_{\text{in}}^\dagger) \left. \right] \sigma_z \\ &+ \omega_a a^\dagger a. \end{aligned}$$

Expanding  $H_{qT}$  to the first order of  $b_{\text{in}} + b_{\text{in}}^\dagger$  and the second order of  $(a + a^\dagger)$ , we can rewrite  $H_{qT}$  as:

$$H_{qT} = \omega_a a^\dagger a - E_J^0 \left[ \frac{\pi \eta_T}{\Phi_0} (a + a^\dagger) - \frac{\pi^3 \eta_T^2 \eta_{\text{in}}}{2\Phi_0^3} (a + a^\dagger)^2 (b_{\text{in}} + b_{\text{in}}^\dagger) \right] \sigma_z.$$

Here, we have omitted the term

$$-\frac{\pi E_J^0 \eta_{\text{in}}}{\Phi_0} (b_{\text{in}} + b_{\text{in}}^\dagger) \sigma_z,$$

which just leads to additional dephasing effects of the charge qubit. Assume that the charge qubit always stays in the ground state and omit the fast oscillating terms  $a^{\dagger 2}$ ,  $a^2$  in the rotating wave approximation, we can obtain the effective Hamiltonian of the TLR:

$$\tilde{H}_T = \omega_a a^\dagger a - \frac{\pi^3 E_J^0 \eta_T^2 \eta_{\text{in}}}{\Phi_0^3} a^\dagger a (b_{\text{in}} + b_{\text{in}}^\dagger) + \frac{\pi E_J^0 \eta_T}{\Phi_0} (a + a^\dagger).$$

The linear term

$$\frac{\pi E_J^0 \eta_T (a + a^\dagger)}{\Phi_0}$$

can be compensated by a classical driving field on the TLR, and thus the effective Hamiltonian  $H_T$  given in Eq. (17) can be obtained.

#### ACKNOWLEDGMENT

J. Zhang would like to thank Dr. H. I. Nurdin for helpful discussions and constructive suggestions for the revision of the manuscript. The author would also like to thank Prof. K. Jacobs and Dr. F. Sciarrino for providing the reference materials and helpful comments.

#### REFERENCES

- [1] D. D' Alessandro, *Introduction to Quantum Control and Dynamics*. Boca Raton, LA: Chapman & Hall, 2007.
- [2] H. M. Wiseman and G. J. Milburn, *Quantum Measurement and Control*. Cambridge, U.K.: Cambridge University Press, 2009.
- [3] H. Mabuchi and N. Khaneja, "Principles and applications of control in quantum systems," *Int. J. Robust Nonlinear Control*, vol. 15, pp. 647-667, 2005.
- [4] P. Rouchon, "Quantum Systems and Control," *Arima*, Vol. 9, pp. 325-357, 2008.
- [5] C. Brif, R. Chakrabarti, and H. Rabitz, "Control of quantum phenomena: past, present and future," *New J. Phys.*, vol. 12, pp. 075008, 2010.
- [6] D. Y. Dong and I. R. Petersen, "Quantum control theory and applications: a survey," *IET Control Theory and Applications*, vol. 4, pp. 2651-2671, 2010.
- [7] G. M. Huang, T. J. Tarn, and J. W. Clark, "On the controllability of quantum-mechanical systems," *J. Math. Phys.*, vol. 24, pp. 2608-2618, 1983.
- [8] N. Khaneja, R. Brockett, and S. J. Glaser, "Time optimal control in spin systems," *Phys. Rev. A*, vol. 63, pp. 032308, 2001.
- [9] J. S. Li and N. Khaneja, "Ensemble control of Bloch equations," *IEEE Trans. Automat. Contr.*, vol. 54, no. 3, pp. 528-536, 2009.
- [10] J. S. Li, "Ensemble control of finite-dimensional time-varying linear systems," *IEEE Trans. Automat. Contr.*, vol. 56, pp. 345-357, 2011.
- [11] H. D. Yuan, "Characterization of majorization monotone quantum dynamics," *IEEE Trans. Automat. Contr.*, vol. 55, no. 4, pp. 955-959, 2010.
- [12] A. M. Bloch, R. W. Brockett, and C. Rangan, "Finite controllability of infinite-dimensional quantum systems," *IEEE Trans. Automat. Contr.*, vol. 55, pp. 1797-1805, 2010.
- [13] F. Albertini and D. D'Alessandro, "Notions of controllability for bilinear multilevel quantum systems," *IEEE Trans. Automat. Contr.*, vol. 48, pp. 1399-1403, 2003.
- [14] R. Romano and D. D'Alessandro, "Environment-mediated control of a quantum system," *Phys. Rev. Lett.*, vol. 97, pp. 080402, 2006.
- [15] S. C. Hou, X. L. Huang, and X. X. Yi, "Suppressing decoherence and improving entanglement by quantum-jump-based feedback control in two-level systems," *Phys. Rev. A*, vol. 82, no. 1, pp. 012336, 2010.
- [16] H. C. Fu, H. Dong, X. F. Liu, and C. P. Sun, "Indirect control with a quantum accessor: Coherent control of multilevel system via a qubit chain," *Phys. Rev. A*, vol. 75, pp. 052317, 2007.
- [17] S. G. Schirmer, H. Fu, and A. I. Solomon, "Complete controllability of quantum systems," *Phys. Rev. A*, vol. 63, pp. 063410, 2000.
- [18] M. Mirrahimi and R. V. Handel, "Stabilizing feedback controls for quantum systems," *SIAM J. Control Optim.*, vol. 46, pp. 445-467, 2007.
- [19] M. Mirrahimi and P. Rouchon, "Real-time synchronization feedbacks for single-atom frequency standards," *SIAM J. Control Optim.*, Vol. 48, No. 4, pp. 2820C2839, 2009.
- [20] N. Yamamoto and L. Bouten, "Quantum risk-sensitive estimation and robustness," *IEEE Trans. Automat. Contr.*, vol. 54, pp. 92-107, 2009.
- [21] N. Yamamoto, K. Tsumura, and S. Hara, "Feedback control of quantum entanglement in a two-spin system," *Automatica*, vol. 43, pp. 981-992, 2007.
- [22] D. Y. Dong, C. B. Zhang, H. Rabitz, A. Pechen, and T. J. Tarn, "Incoherent control of locally controllable quantum systems," *J. Chem. Phys.*, vol. 129, pp. 154103, 2008.
- [23] C. Altafini, "Controllability properties for finite dimensional quantum Markovian master equations," *J. Math. Phys.*, vol. 44, pp. 2357-2372, 2003.
- [24] C. Altafini, "Coherent control of open quantum dynamical systems," *Phys. Rev. A*, vol. 70, pp. 062321, 2004.
- [25] C. Altafini, "Feedback stabilization of isospectral control systems on complex flag manifolds: application to quantum ensembles," *IEEE Trans. Automat. Contr.*, vol. 52, pp. 2019-2028, 2007.
- [26] D. D'Alessandro and M. Dahleh, "Optimal control of two-level quantum systems," *IEEE Trans. Automat. Contr.*, vol. 46, pp. 866-876, 2001.
- [27] K. Kashima and N. Yamamoto, "Control of quantum systems despite feedback delay," *IEEE Trans. Automat. Contr.*, vol. 54, pp. 876-881, 2009.
- [28] B. Bonnard, M. Chyba, and D. Sugny, "Time-minimal control of dissipative two-Level quantum systems: the generic case," *IEEE Trans. Automat. Contr.*, vol. 54, pp. 2598-2610, 2009.
- [29] X. T. Wang and S. G. Schirmer, "Analysis of Lyapunov method for control of quantum states," *IEEE Trans. Automat. Contr.*, vol. 55, pp. 2259-2270, 2010.
- [30] F. Ticozzi and L. Viola, "Quantum Markovian subsystems: invariance, attractivity, and control," *IEEE Trans. Automat. Contr.*, vol. 53, pp. 2048-2063, 2008.
- [31] M. Zhang, H. Y. Dai, Z. R. Xi, H. W. Xie, and D. W. Hu, "Combating dephasing decoherence by periodically performing tracking control and projective measurement," *Phys. Rev. A*, vol. 76, pp. 042335, 2007.
- [32] W. Cui, Z. R. Xi, and Y. Pan, "Optimal decoherence control in non-Markovian open dissipative quantum systems," *Phys. Rev. A*, vol. 77, pp. 032117, 2008.
- [33] J. Zhang, R. B. Wu, C. W. Li, and T. J. Tarn, "Protecting coherence and entanglement by quantum feedback controls," *IEEE Trans. Automat. Contr.*, vol. 55, no. 3, pp. 619-633, 2010.
- [34] B. Qi and L. Guo, "Is Measurement-based feedback still better for quantum control systems?" *Sys. Contr. Lett.*, vol. 59, pp. 333-339, 2010.
- [35] R. L. Cook, P. J. Martin, and J. M. Geremia, "Optical coherent state discrimination using a closed-loop quantum measurement," *Nature*, vol. 446, pp. 774-777, 2007.
- [36] R. van Handel, J. K. Stockton, and H. Mabuchi, "Feedback control of quantum state reduction," *IEEE Trans. Automat. Contr.*, vol. 50, pp. 768-780, 2005.
- [37] K. Jacobs and A. P. Lund, "Feedback control of nonlinear quantum systems: a rule of thumb," *Phys. Rev. Lett.*, vol. 99, pp. 020501, 2007.
- [38] L. Bouten, R. van Handel, and M. R. James, "An introduction to quantum filtering," *SIAM J. Control Optim.*, vol. 46, pp. 2199-2241, 2007.
- [39] J. K. Stockton, R. van Handel, and H. Mabuchi, "Deterministic Dicke-state preparation with continuous measurement and control," *Phys. Rev. A*, vol. 70, pp. 022106, 2004.
- [40] H. M. Wiseman and G. J. Milburn, "Quantum theory of optical feedback via homodyne detection," *Phys. Rev. Lett.*, vol. 70, pp. 548-551, 1993.
- [41] H. M. Wiseman, "Quantum theory of continuous feedback," *Phys. Rev. A*, vol. 49, pp. 2133-2150, 1994.
- [42] H. Mabuchi and A. C. Doherty, "Cavity quantum electrodynamics: coherence in context," *Science*, vol. 298, pp. 1372-1377, 2002.

- [43] A. C. Doherty, S. Habib, K. Jacobs, H. Mabuchi, and S. M. Tan, "Quantum feedback control and classical control theory," *Phys. Rev. A*, vol. 62, pp. 012105, 2000.
- [44] S. Mancini, and J. Wang, "Towards feedback control of entanglement," *Eur. Phys. J. D*, vol. 32, pp. 257-260, 2005.
- [45] S. Mancini, "Markovian feedback to control continuous-variable entanglement," *Phys. Rev. A*, vol. 73, pp. 010304(R), 2006.
- [46] S. Mancini, and H. Wiseman, "Optimal control of entanglement via quantum feedback," *Phys. Rev. A*, vol. 75, pp. 012330, 2007.
- [47] J. Zhang, Y.-X. Liu, R.-B. Wu, C.-W. Li, and T.-J. Tarn, "Transition from weak to strong measurements by nonlinear quantum feedback control," *Phys. Rev. A*, vol. 82, pp. 022101, 2010.
- [48] S. Lloyd, "Coherent quantum feedback," *Phys. Rev. A*, vol. 62, pp. 022108, 2000.
- [49] R. J. Nelson, Y. Weinstein, D. Cory, and S. Lloyd, "Experimental demonstration of fully coherent quantum feedback," *Phys. Rev. Lett.*, vol. 85, pp. 3045-3048, 2000.
- [50] H. Mabuchi, "Coherent-feedback quantum control with a dynamic compensator," *Phys. Rev. A*, vol. 78, pp. 032323, 2008.
- [51] M. R. James, H. I. Nurdin, and I. R. Petersen, " $H^\infty$  control of linear quantum stochastic systems," *IEEE Trans. Automat. Contr.*, vol. 53, pp. 1787-1803, 2008.
- [52] J. Gough and M. R. James, "The series product and its application to quantum feedforward and feedback networks," *IEEE Trans. Automat. Contr.*, vol. 54, pp. 2530-2544, 2009.
- [53] K. Jacobs and A. J. Landahl, "Engineering giant nonlinearities in quantum nanosystems," *Phys. Rev. Lett.*, vol. 103, pp. 067201, 2009.
- [54] J. Bajer, M. Dusek, J. Fiurasek, Z. Hradil, A. Luks, V. Perinova, J. Rehacek, J. Perina, O. Haderka, M. Hendrych, J. Perina Jr., N. Imoto, M. Koashi, and A. Miranowicz, *Nonlinear Phenomena in Quantum Optics, Modern Nonlinear Optics, Part I, Volume 119, Second Edition, Edited by M. W. Evans*. New York, USA: Wiley, 2002.
- [55] L. Sansoni, F. Sciarrino, G. Vallone, P. Mataloni, A. Crespi, R. Ramponi, and R. Osellame, "Polarization entangled state measurement on a chip," *Phys. Rev. Lett.*, vol. 105, pp. 200503, 2010.
- [56] A. Politi, J.C.F. Matthews, and J. L. O'Brien, "Shors quantum factoring algorithm on a photonic chip," *Science*, vol. 325, pp. 1221, 2009.
- [57] J.C.F. Matthews, A. Politi, A. Stefanov, and J. L. O'Brien, "Manipulation of multiphoton entanglement in waveguide quantum circuits," *Nature Photonics*, vol. 3, pp. 346-350, 2009.
- [58] D. W. Berry and H. M. Wiseman, "Quantum optics on a chip," *Nature Photonics*, vol. 3, pp. 317-319, 2009.
- [59] R. R. Puri. *Mathematical methods of quantum optics*. Berlin, Germany: Springer-Verlag, 2001.
- [60] M. R. James and J. Gough, "Quantum dissipative systems and feedback control design by interconnection," *IEEE Trans. Automat. Contr.*, vol. 55, pp. 1806-1821, 2010.
- [61] G. F. Zhang and M. R. James, "Direct and indirect couplings in coherent feedback control of linear quantum systems," Accepted by IEEE Transaction on Automatic Control.
- [62] J. E. Gough and M. R. James, "Quantum feedback networks: Hamiltonian formulation," *Commun. Math. Phys.*, vol. 287, pp. 1109-1132, 2009.
- [63] H. I. Nurdin, M. R. James, and A. C. Doherty, "Network synthesis of linear dynamical quantum stochastic systems," *SIAM J. Control Optim.*, vol. 48, no. 4, pp. 2686-2718, 2009.
- [64] H. I. Nurdin, "On synthesis of linear quantum stochastic systems by pure cascading," *IEEE Trans. Automat. Contr.*, vol. 55, pp. 2439-2444, 2010.
- [65] A. I. Maalouf and I. R. Petersen, "Coherent  $H^\infty$  control for a class of annihilation operator linear quantum systems," *IEEE Trans. Automat. Contr.*, vol. 56, pp. 309-319, 2011.
- [66] M. Yanagisawa and H. Kimura, "Transfer function approach to quantum control-part I: Dynamics of quantum feedback systems," *IEEE Trans. Automat. Contr.*, vol. 48, pp. 2107-2120, 2003.
- [67] M. Yanagisawa, "Non-Gaussian state generation from linear elements via feedback," *Phys. Rev. Lett.*, vol. 103, pp. 203601, 2009.
- [68] J. E. Gough, "Construction of bilinear control Hamiltonians using the series product and quantum feedback," *Phys. Rev. A*, vol. 78, pp. 052311, 2008.
- [69] J. E. Gough, M. R. James, and H. I. Nurdin, "Squeezing components in linear quantum feedback networks," *Phys. Rev. A*, vol. 81, pp. 023804, 2010.
- [70] J. Kerckhoff, H. I. Nurdin, D. S. Pavlichin, and H. Mabuchi, "Designing quantum memories with embedded control: photonic circuits for autonomous quantum error correction," *Phys. Rev. Lett.*, vol. 105, pp. 040502, 2010.
- [71] R. I. Hudson and K. R. Parthasarathy, "Quantum Ito's formula and stochastic evolution," *Commun. Math. Phys.*, vol. 93, pp. 301-323, 1984.
- [72] C. W. Gardiner and M. J. Collett, "Input and output in damped quantum systems: Quantum stochastic differential equations and the master equation," *Phys. Rev. A*, vol. 31, pp. 3761-3774, 1985.
- [73] A. A. Clerk, M. H. Devoret, S. M. Girvin, F. Marquardt, and R. J. Schoelkopf, "Introduction to quantum noise, measurement, and amplification," *Rev. Mod. Phys.*, vol. 82, pp. 1155-1208, 2010.
- [74] C. W. Gardiner and P. Zoller, *Quantum noise, 3rd ed.* Berlin, Germany: Springer-Verlag, 2004.
- [75] C. J. Villas-Boas, N. G. de Almeida, R. M. Serra, and M. H. Y. Moussa, "Squeezing arbitrary cavity-field states through their interaction with a single driven atom," *Phys. Rev. A*, vol. 68, pp. 061801(R), 2003.
- [76] N. G. de Almeida, R. M. Serra, C. J. Villas-Boas, and M. H. Y. Moussa, "Engineering squeezed states in high-Q cavities," *Phys. Rev. A*, vol. 69, pp. 035802, 2004.
- [77] J. Zhang, Y.-X. Liu, C. W. Li, T. J. Tarn, and F. Nori, "Generating stationary entangled states in superconducting qubits," *Phys. Rev. A*, vol. 79, pp. 052308, 2009.
- [78] J. Gough and R. van Handel, "Singular perturbation of quantum stochastic differential equations with coupling through an oscillator mode," *J. Stat. Phys.*, vol. 127, pp. 575, 2007.
- [79] L. Bouten, R. van Handel, and A. Silberfarb, "Approximation and limit theorems for quantum stochastic models with unbounded coefficients," *Journal of Functional Analysis*, vol. 254, pp. 3123C3147, 2008.
- [80] M. H. Schleier-Smith, I. D. Leroux, and V. Vuletić, "Squeezing the collective spin of a dilute atomic ensemble by cavity feedback," *Phys. Rev. A*, vol. 81, pp. 021804(R), 2010.
- [81] I. D. Leroux, M. H. Schleier-Smith, and V. Vuletić, "Implementation of cavity squeezing of a collective atomic spin," *Phys. Rev. Lett.*, vol. 104, pp. 073602, 2010.
- [82] I. Siddiqi, R. Vijay, F. Pierre, C. M. Wilson, M. Metcalfe, C. Rigetti, L. Frunzio, and M. H. Devoret, "RF-driven Josephson bifurcation amplifier for quantum measurement," *Phys. Rev. Lett.*, vol. 93, pp. 207002, 2004.
- [83] V. V. Dodonov, "Nonclassical states in quantum optics: a 'squeezed' review of the first 75 years," *Journal of Optics B: Quantum and Semiclassical Optics*, vol. 4, pp. R1-R33, 2002.
- [84] I. L. Chuang and Y. Yamamoto, "Simple quantum computer," *Phys. Rev. A*, vol. 52, pp. 3489-3496, 1995.
- [85] J. Q. You and F. Nori, "Superconducting circuits and quantum information," *Physics Today*, vol. 58, no. 11, pp. 42-47, 2005.
- [86] Y. Makhlin, G. Schön, and A. Shnirman, "Quantum-state engineering with Josephson-junction devices," *Rev. Mod. Phys.*, vol. 73, no. 2, pp. 357-400, 2001.
- [87] J. Clarke and F. K. Wilhelm, "Superconducting quantum bits," *Nature*, vol. 453, pp. 1031-1042, 2008.
- [88] L. Chirolli, G. Burkard, S. Kumar, and D. P. DiVincenzo, "Superconducting resonators as beam splitters for linear-optics quantum computation," *Phys. Rev. Lett.*, vol. 104, pp. 230502, 2010.
- [89] Y.-X. Liu, J. Q. You, L. F. Wei, C. P. Sun, and F. Nori, "Optical selection rules and phase-dependent adiabatic state control in a superconducting quantum circuit," *Phys. Rev. Lett.*, vol. 95, pp. 087001, 2005.
- [90] S. Lloyd and S. L. Braunstein, "Quantum computation over continuous variables," *Phys. Rev. Lett.*, vol. 82, pp. 1784-1787, 1999.
- [91] S. L. Braunstein and P. van Loock, "Quantum information with continuous variables," *Rev. Mod. Phys.*, vol. 77, pp. 513-577, 2005.
- [92] K. Jacobs, L. Tian, and J. Finn, "Engineering superposition states and tailored probes for nanoresonators via open-loop control," *Phys. Rev. Lett.*, vol. 102, pp. 057208, 2009.
- [93] F. Deppe, M. Mariani, E. P. Menzel, A. Marx, S. Saito, K. Kakuyanagi, H. Tanaka, T. Meno, K. Semba, H. Takayanagi, E. Solano, and R. Gross, "Two-photon probe of the Jaynes-Cummings model and controlled symmetry breaking in circuit QED," *Nature Physics*, vol. 4, pp. 686-691, 2008.
- [94] M. G. Genoni, M.G.A. Paris, and K. Banaszek, "Measure of the non-Gaussian character of a quantum state," *Phys. Rev. A*, vol. 76, pp. 042327, 2007.
- [95] M. G. Genoni and M.G.A. Paris, "Quantifying non-Gaussianity for quantum information," *Phys. Rev. A*, vol. 82, pp. 052341, 2010.
- [96] R. Tanas and Z. Ficek, "Stationary two-atom entanglement induced by nonclassical two-photon correlations," *J. Opt. B: Quantum Semiclass. Opt.*, vol. 6, pp. S610-S617, 2004.
- [97] A. F. Alharbi and Z. Ficek, "Deterministic creation of stationary entangled states by dissipation," *Phys. Rev. A*, vol. 82, pp. 054103, 2010.



**Jing Zhang** received his B.S. degree from Department of Mathematical Science and Ph.D. degree from Department of Automation, Tsinghua University, Beijing, China, in 2001 and 2006, respectively.

From 2006 to 2008, he was a Postdoctoral Fellow at the Department of Computer Science and Technology, Tsinghua University, Beijing, China, and a Visiting Researcher from 2008 to 2009 at the Advanced Science Institute, the Institute of Physical and Chemical Research (RIKEN), Japan. In 2010, he worked as a Visiting Assistant Professor at Department of Physics and National Center for Theoretical Sciences, National Cheng Kung University, Taiwan. He is now an Associate Professor at the Department of Automation, Tsinghua University, Beijing, China. His research interests include quantum control and nano manipulation.

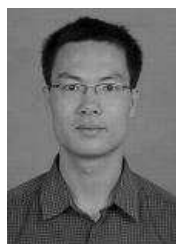

**Re-Bing Wu** received his B.S. degree in Electrical Engineering and Ph.D. degree in Control Science and Engineering from Tsinghua University, Beijing, China, in 1998 and 2004, respectively.

From 2005 to 2008, he was a Research Associate Fellow at the Department of Chemistry, Princeton University, USA. Since 2009, he has been an Associate Professor at the Department of Automation, Tsinghua University, Beijing, China. His research interests include quantum mechanical control theory and nonlinear control theory.



**Yu-xi Liu** received his B.S. degree, Master degree and Ph.D. degree from Department of Physics, Shanxi Normal University, Jilin University and Beijing University in 1989, 1995 and 1998, respectively.

From 1998 to 2000, he was a Post-doctor at the Institute of Theoretical Physics, the Chinese Academy of Sciences, China. From 2000 to 2002, he was a JSPS Postdoctoral fellow at the Graduate University for Advanced Studies (SOKENDAI), Japan. From 2002 to 2009, he was a research scientist in the

Institute of Physical and Chemical Research (RIKEN), Japan.

Since 2009, he has been a Professor with Institute of Microelectronics, Tsinghua University. His research interests include solid state quantum devices, quantum information processing, quantum optics and quantum control theory.



**Chun-Wen Li** received his B.S. degree and Ph.D. degree from Department of Automation, Tsinghua University in 1982 and 1989, respectively.

Since 1994, he has been a Professor with Department of Automation, Tsinghua University. His research interests include nonlinear control systems, inverse systems, CAD and simulation of nonlinear systems, and robust control.

Prof. Li received the National Youth Prize in 1991 and the Prize of Chinese Outstanding Ph.D. Degree Receiver in 1992.



**Tzyh-Jong Tarn** (M71-SM83-F85) received the D.Sc degree in control system engineering from Washington University at St. Louis, Missouri, USA.

He is currently a Senior Professor in the Department of Electrical and Systems Engineering at Washington University, St. Louis, USA. He also is the director of the Center for Quantum Information Science and Technology at Tsinghua University, Beijing, China.

An active member of the IEEE Robotics and Automation Society, Dr. Tarn served as the President of the IEEE Robotics and Automation Society, 1992-1993, the Director of the IEEE Division X (Systems and Control), 1995-1996, and a member of the IEEE Board of Directors, 1995-1996.

He is the first recipient of the Nakamura Prize (in recognition and appreciation of his contribution to the advancement of the technology on intelligent robots and systems over a decade) at the 10th Anniversary of IROS in Grenoble, France, 1997, the recipient of the prestigious Joseph F. Engelberger Award of the Robotic Industries Association in 1999 for contributing to the advancement of the science of robotics, the Auto Soft Lifetime Achievement Award in 2000 in recognition of his pioneering and outstanding contributions to the fields of Robotics and Automation, the Pioneer in Robotics and Automation Award in 2003 from the IEEE Robotics and Automation Society for his technical contribution in developing and implementing nonlinear feedback control concepts for robotics and automation, and the George Saridis Leadership Award from the IEEE Robotics and Automation Society in 2009. In 2010 he received the Einstein Chair Professorship Award from the Chinese Academy of Sciences and the John R. Ragazzini Award from the American Automatic Control Council. He was featured in the Special Report on Engineering of the 1998 Best Graduate School issue of US News and World Report and his research accomplishments were reported in the Washington Times, Washington D.C., the Financial Times, London, Le Monde, Paris, and the Chicago Sun-Times, Chicago, etc. Dr. Tarn is an IFAC Fellow.