

# Technical Design Report of the Inner Tracker for the KLOE-2 experiment

## The KLOE-2 Collaboration

G. De Robertis, O. Erriquez, F. Loddo, A. Ranieri,  
*Dipartimento di Fisica, Università di Bari and INFN sezione di Bari, Bari,  
Italy*

G. Morello, M. Schioppa  
*Dipartimento di Fisica, Università della Calabria and INFN gruppo  
collegato di Cosenza, Cosenza, Italy*

E. Czerwinski, P. Moskal, M. Silarski, J. Zdebik  
*Institute of Physics, Jagellonian University, Cracow, Poland*

D. Babusci, G. Bencivenni, C. Bloise, F. Bossi, P. Campana, G. Capon,  
P. Ciambrone, E. Danè, E. De Lucia, D. Domenici, M. Dreucci, G. Felici,  
S. Giovannella, F. Happacher, E. Iarocci, M. Jacewicz, J. Lee Franzini,  
M. Martini, S. Miscetti, L. Quintieri, V. Patera, P. Santangelo, I. Sarra,  
B. Sciascia, A. Sciubba, G. Venanzoni, R. Versaci  
*Laboratori Nazionali di Frascati dell' INFN, Frascati, Italy*

S. A. Bulychjev, V. V. Kulikov, M. A. Martemianov, M. A. Matsyuk  
*Institute for Theoretical and Experimental Physics (ITEP), Moscow, Russia*

C. Di Donato  
*Dipartimento di Scienze Fisiche, Università di Napoli "Federico II" and  
INFN sezione di Napoli, Napoli, Italy*

C. Bini, V. Bocci, A. De Santis, G. De Zorzi, A. Di Domenico, S. Fiore,  
P. Franzini, P. Gauzzi  
*Dipartimento di Fisica, "Sapienza" Università di Roma and INFN sezione  
di Roma, Roma, Italy*

F. Archilli, D. Badoni, F. Gonnella, R. Messi, D. Moricciani  
*Dipartimento di Fisica, Università di Roma "Tor Vergata" and INFN  
sezione di Roma 2, Roma, Italy*

P. Branchini, A. Budano, F. Ceradini, B. Di Micco, E. Graziani, F. Nguyen,  
A. Passeri, C. Taccini, L. Tortora  
*Dipartimento di Fisica, Università Roma Tre and INFN sezione di Roma  
Tre, Roma, Italy*

L. Kurdadze, D. Mchedlishvili, M. Tabidze  
*Nuclear Physics Department and High Energy Physics Institute of Tbilisi  
State University, Georgia*

B. Hoistad, T. Johansson, A. Kupsc, M. Wolke  
*Department of Nuclear and Particle Physics, Uppsala University, Uppsala,  
Sweden*

W. Wislicki  
*A. Soltan Institute for Nuclear Studies, Warsaw, Poland*

**and**

N. Lacalamita, R. Liuzzi, M. Mongelli, V. Valentino  
*INFN sezione di Bari, Bari, Italy*

A. Balla, S. Cerioni, M. Gatta, S. Lauciani, M. Pistilli  
*Laboratori Nazionali di Frascati dell' INFN, Frascati, Italy*

A. Pelosi  
*INFN sezione di Roma, Roma, Italy*

# Contents

<b>1</b>	<b>Introduction</b>	<b>5</b>
<b>2</b>	<b>Physics issues</b>	<b>7</b>
2.1	Neutral Kaon Interferometry . . . . .	7
2.2	Rare $K_S$ decays . . . . .	9
2.3	$\eta$ decays in four charged particles . . . . .	10
2.4	Multi-lepton events . . . . .	11
<b>3</b>	<b>Detector design requirements.</b>	<b>12</b>
3.1	Detector layout . . . . .	13
3.2	Operating principles of a triple-GEM detector. . . . .	15
3.3	Simulation results . . . . .	15
<b>4</b>	<b>Prototype studies</b>	<b>18</b>
4.1	Full-scale CGEM prototype . . . . .	18
4.1.1	Construction . . . . .	18
4.1.2	X-ray test . . . . .	22
4.1.3	CGEM test beam at CERN . . . . .	24
4.2	Planar GEM for readout studies . . . . .	29
4.2.1	Operation in magnetic field . . . . .	30
4.2.2	Planar GEM test beam at CERN . . . . .	32
4.3	Large area GEM . . . . .	37
4.3.1	Single-mask procedure . . . . .	38
4.3.2	Measurements . . . . .	39
4.3.3	Large planar prototype . . . . .	41
<b>5</b>	<b>Mechanics and construction</b>	<b>42</b>
5.1	Detector components . . . . .	43
5.2	Construction and tooling . . . . .	46
5.3	Material preparation & Quality Controls . . . . .	48
5.3.1	GEMs . . . . .	48
5.3.2	Readout anode circuit . . . . .	50
5.3.3	Annular frames . . . . .	51
5.3.4	Final tests on closed chamber . . . . .	51
5.4	Detector integration . . . . .	52
<b>6</b>	<b>Electronics</b>	<b>55</b>
6.1	On-Detector Electronics . . . . .	55
6.1.1	The GASTONE ASIC . . . . .	55
6.1.2	The Digital section . . . . .	60

6.2	The 16 channels chip prototype . . . . .	62
6.2.1	Lab test result . . . . .	63
6.3	Off-Detector electronics . . . . .	64
6.3.1	GEO boards . . . . .	65
6.3.2	CONCENTRATOR board . . . . .	67
6.4	HV and FEE integration . . . . .	69
6.4.1	FEE Integration . . . . .	69
6.4.2	HV Integration . . . . .	71
6.4.3	Assembling test . . . . .	72
<b>7</b>	<b>Time schedule and responsibilities sharing</b>	<b>73</b>

# 1 Introduction

The KLOE experiment collected an integrated luminosity  $\int \mathcal{L} dt \sim 2.5 \text{ fb}^{-1}$  at the Frascati  $\phi$ -factory DAΦNE, an  $e^+e^-$  collider operated at the energy of 1020 MeV, the mass of the  $\phi$  meson.

The experiment achieved several precision physics results [1] both in

- Kaon physics, thanks to the unique availability of pure  $K_S$ ,  $K_L$ ,  $K^\pm$  beams, with the measurement of all significant branching ratios and the unitarity and universality tests of the weak interactions in the Standard Model, and also with several stringent tests of  $CPT$  symmetry and quantum mechanics, and in
- Hadronic physics, with the study of the properties of scalar and pseudoscalar mesons with unprecedented accuracy and the measurement of the  $e^+e^- \rightarrow \pi^+\pi^-$  cross section representing the main hadronic contribution to the muon anomaly.

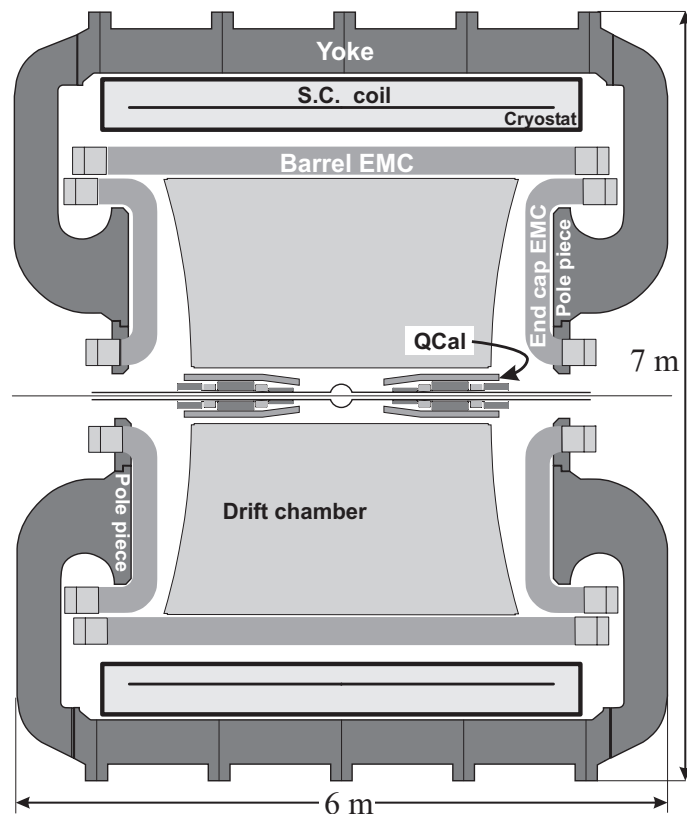

Figure 1: The KLOE detector

The detector (fig. 1) consists of a large volume drift chamber surrounded by an electromagnetic sampling calorimeter and it is entirely immersed in an axial magnetic field  $B = 0.52$  T. The drift chamber (DC) [2], 3.3 m long and 4 m in diameter, has a stereo geometry with 12,582 drift cells arranged in 58 layers and operates with a 90% helium-10% isobutane gas mixture. Tracking in the DC provides measurements of the momentum of charged particles with  $\sigma(p_{\perp})/p_{\perp} \leq 0.4\%$  for polar angles larger than  $45^{\circ}$ . The spatial resolution is  $\sim 150$   $\mu\text{m}$  in the bending plane,  $\sim 2$  mm on the  $z$  coordinate and  $\sim 3$  mm on decay vertices. The first track hit measured by the KLOE drift chamber is at a radius of 28 cm from the interaction point (IP). After track extrapolation, the vertex of a  $K_S \rightarrow \pi^+\pi^-$  decay close to the IP is reconstructed with a resolution of  $\sim 1 \tau_S \simeq 6$  mm. The electromagnetic calorimeter (EMC) [3] consists of a cylindrical barrel and two endcaps, covering a solid angle of 98% of  $4\pi$ . Particles crossing the lead-scintillator-fiber structure of the EMC, segmented into five planes in depth, are detected as local energy deposits. Deposits close in time and space are grouped into clusters. The energy and time resolution for electromagnetic showers are  $\sigma_E/E = 5.7\%/\sqrt{E(\text{GeV})}$  and  $\sigma_t = 57 \text{ ps}/\sqrt{E(\text{GeV})} \oplus 100 \text{ ps}$ , respectively. The trigger [4] requires two isolated energy deposits in the EMC with:  $E > 50$  MeV in the barrel and  $E > 150$  MeV in the endcaps. Cosmic-ray muons are identified as events with two energy deposits with  $E > 30$  MeV in the outermost EMC planes and are vetoed at the trigger level. A software filter, based on the topology and multiplicity of EMC clusters and DC hits, is applied to reject machine background.

After the completion of the KLOE data taking, a proposal [5, 6] has been presented for a physics program to be carried out with an upgraded KLOE detector, KLOE-2 [7, 8, 9], at an upgraded DAΦNE machine, which has been assumed to deliver an integrated luminosity  $\mathcal{O}(20) \text{ fb}^{-1}$ .

The KLOE physics program required a detector capable of reconstructing with good accuracy a large fraction of  $K_L$  decays, in a big fiducial volume, and  $K_S$  decays coming from the interaction region. At KLOE-2 an enhanced interest will be focused on physics coming from the interaction region:  $K_S$  decays,  $K_S K_L$  interference,  $\eta$ ,  $\eta'$  and  $K^{\pm}$  decays, multi-lepton events. Therefore an improvement of the detection performance and capabilities close to the interaction point (IP) would be extremely beneficial for the KLOE-2 physics program.

In this document an upgrade of the KLOE setup with a new detector, the Inner Tracker (IT), is discussed. The IT will be placed between the beam pipe and the DC inner wall in order to:

- reduce the track extrapolation length and improve the decay vertex

reconstruction capability;

- increase the geometrical acceptance for low momentum tracks, presently limited by the KLOE magnetic field and by the distance of the DC first layer, and optimize their detection;
- improve the track momentum resolution.

## 2 Physics issues

### 2.1 Neutral Kaon Interferometry

A  $\phi$ -factory is a unique place to investigate the evolution of the entangled kaons, and to search for decoherence and  $CPT$  violation effects, possibly induced by underlying quantum gravitational phenomena.

As discussed in Ref.[5, 10], from the analysis of  $CP$  violating decay mode  $\phi \rightarrow K_S K_L \rightarrow \pi^+ \pi^-, \pi^+ \pi^-$  several important tests of fundamental physics can be done. Quantum interference effects in this channel have been observed for the first time by the KLOE collaboration [11], measuring the distribution  $I(\pi^+ \pi^-, \pi^+ \pi^-; |\Delta t|)$ , with  $\Delta t$  the time difference of the two  $\pi^+ \pi^-$  decays. The analysis of the full KLOE data set [12] provided the most stringent limits on the  $\gamma$ ,  $\Re\omega$ , and  $\Im\omega$  parameters related to possible decoherence and  $CPT$  violation effects in the neutral kaon system [13]. Moreover, the most precise test of quantum coherence on an entangled two-particle system has been performed, putting very stringent limits on the decoherence parameters  $\zeta_{00}$  and  $\zeta_{SL}$  [14]. All these measurements are dominated by statistical uncertainties.

In general, all decoherence effects (including  $CPT$  violation effects related to decoherence phenomena) should manifest as a deviation from the quantum mechanical prediction  $I(\pi^+ \pi^-, \pi^+ \pi^-; |\Delta t| = 0) = 0$ . Hence the reconstruction of events in the region at  $\Delta t \approx 0$ , i.e. with two vertices close to each other and both near the IP, is crucial for a precise determination of the parameters related to  $CPT$  violation and decoherence. The vertex resolution, mainly due to track extrapolation, affects the  $I(\pi^+ \pi^-, \pi^+ \pi^-; |\Delta t|)$  distribution precisely in this region, as shown in fig. 2. The resolution has been taken into account by properly folding and fitting the original distribution with the smearing matrix and the efficiency curve obtained with the Monte Carlo simulation used for the KLOE data analysis [11]. The effect of an improved resolution  $\sigma_{|\Delta t|} \approx 0.3 \tau_S$  has simply been obtained by taking into account the corresponding  $|\Delta t|$  scale factor in the smearing matrix and in the efficiency curve. In this way all the peculiar asymmetries and behaviours

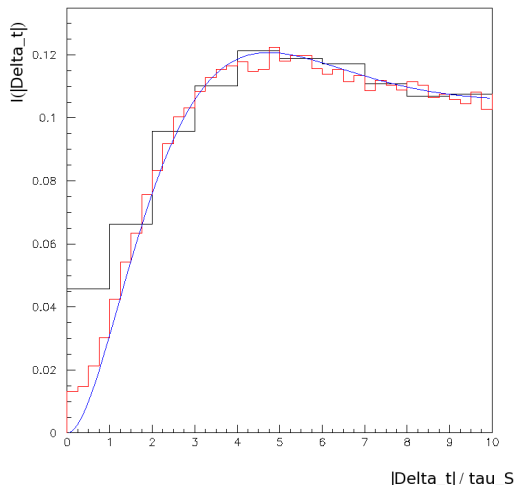

Figure 2: The  $I(\pi^+\pi^-, \pi^+\pi^-; |\Delta t|)$  distribution as a function of  $|\Delta t|$  (in  $\tau_S$  units) with the present KLOE resolution  $\sigma_{|\Delta t|} \approx \tau_S$  (histogram with wide bins), with an improved resolution  $\sigma_{|\Delta t|} \sim 0.3 \tau_S$  (histogram with narrow bins), and in the ideal case (solid line). Simulation results.

of the  $|\Delta t|$  resolution around  $\Delta t = 0$  are maintained, even though they are shrunk. The impact of the resolution on the decoherence parameter measurements has to be carefully evaluated. Indeed, the resolution has two main effects: (1) it contributes to the statistical sensitivity on the measurement of the decoherence (and  $CPT$  violation) parameters, which are obtained from a fit to the measured  $I(\pi^+\pi^-, \pi^+\pi^-; |\Delta t|)$  distribution; (2) it introduces a source of systematic uncertainty, due to its folding in the fit procedure. In fig. 3 the statistical uncertainty on several decoherence and  $CPT$ -violating parameters is shown as a function of the integrated luminosity for  $\sigma_{|\Delta t|} \approx \tau_S$  (present KLOE resolution) and  $\sigma_{|\Delta t|} \sim 0.3 \tau_S$ . As it can be seen in the last case an improvement of about a factor two in statistical sensitivity could be achieved. This improvement would be equivalent to an increase in luminosity of a factor of four, and it is necessary, with a target integrated luminosity of  $\mathbb{L} 20 \text{ fb}^{-1}$ , to reduce the statistical uncertainties below or approximately at the same level of the expected systematic ones. Therefore the insertion of an inner tracker between the spherical beam pipe and the drift chamber is mandatory for a significant improvement of the KLOE results, and in general



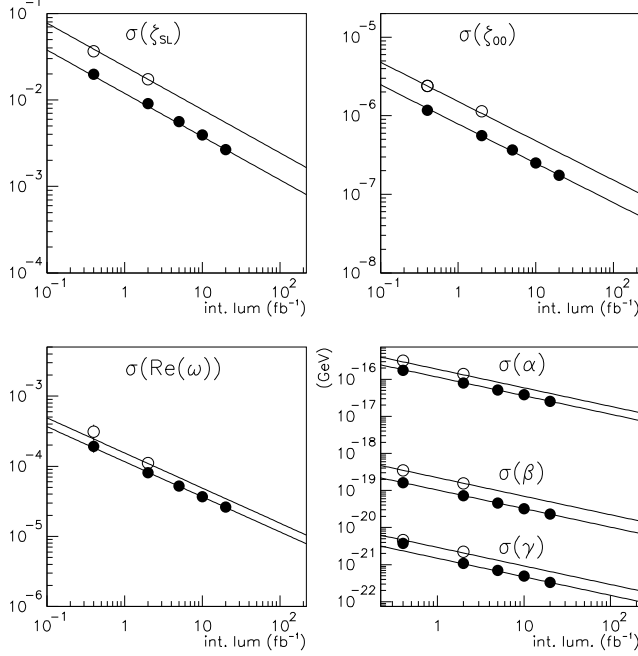

Figure 3: The statistical sensitivity to the parameters  $\zeta_{SL}$  (top-left),  $\zeta_{00}$  (top-right),  $\Re\omega$  (bottom-left) and  $\alpha$ ,  $\beta$ ,  $\gamma$  (bottom-right) with the present KLOE resolution  $\sigma_{|\Delta t|} \approx \tau_S$  (open circles), and with an improved resolution  $\sigma_{|\Delta t|} \sim 0.3 \tau_S$  (full circles); solid lines represent  $1/\sqrt{L}$  function.

for the neutral kaon interferometry program of KLOE-2.

In fact also the  $\Delta t$  distribution of other decay modes like  $\phi \rightarrow K_S K_L \rightarrow \pi^+ \ell^- \bar{\nu}$ ,  $\pi^- \ell^+ \nu$  and  $\phi \rightarrow K_S K_L \rightarrow \pi\pi$ ,  $\pi\ell\nu$  are interesting in the interference region (corresponding to kaon decays close to the IP), being sensitive to  $CP$ ,  $CPT$  and/or  $\Delta S = \Delta Q$  rule violation effects [10]. In analogy with the measurement of the decoherence parameters, the statistical sensitivity and the systematic uncertainties in the measurement of these parameters could be largely improved with the use of an inner tracker.

## 2.2 Rare $K_S$ decays

Significant results in kaon physics can be obtained at KLOE-2 improving the present knowledge on  $K_S$  rare decays. The measurement of  $K_S$  decays at the  $\phi$ -factory has the unique feature to rely on  $K_S$  pure beams, tagged by the reconstruction of  $K_L$  decays and  $K_L$  interactions in the calorimeter. Back-

ground sources are limited to the dominant  $K_S$  decay channels,  $K_S \rightarrow \pi\pi$ , well under control using the constraint of the closed kinematics of the decay. In general the insertion of an inner tracker would greatly improve the quality of tracking and vertexing for all charged  $K_S$  decay modes; it would also optimize low momentum tracks detection, which is of fundamental importance to improve the acceptance for some rare  $K_S$  decays.

The study of  $K_S \rightarrow \pi e \nu$  decays is very important to test  $CPT$  symmetry, the  $\Delta S = \Delta Q$  rule and to measure  $V_{us}$ . The most precise measurement of this branching ratio (BR) has been obtained by KLOE with a total uncertainty of  $\sim 1.3\%$  using an integrated luminosity of  $410 \text{ pb}^{-1}$  [15]. This accuracy is the combination of a  $1.1\%$  statistical and a  $0.7\%$  systematic fractional uncertainties, largely dominated by the precision of the knowledge of the distributions of tracking-related quantities. In fact the systematic uncertainty on the combined fit of these distributions, like the difference between missing energy and momentum, mainly comes from the background of  $K_S \rightarrow \pi^+\pi^-$  decays not correctly reconstructed, e.g. cases in which one pion decays to a muon before entering the DC tracking volume.

With a target integrated luminosity of  $10\text{-}20 \text{ fb}^{-1}$  and the detector upgraded with an inner tracker, KLOE-2 could measure the BR with a total uncertainty dominated by systematic effects. These systematic effects could be reduced at few per mil level with the IT, thanks to a better quality of the tracking, a more powerful rejection of the background from pion decays close to the IP, and a larger acceptance for low momentum tracks.

Similar considerations apply to other  $K_S$  rare decays that can be measured at KLOE-2 as (i)  $K_S \rightarrow \pi\mu\nu$ , with similar physics interest as the  $K_S \rightarrow \pi e \nu$  decay, but with a lower BR and larger background; (ii)  $K_S \rightarrow \pi^+\pi^-e^+e^-$ , important to perform tests of Chiral Perturbation Theory and possible new  $CP$  violation mechanisms; (iii)  $K_S \rightarrow \pi^0e^+e^-$  very important to assess indirect  $CP$  violation contribution in  $K_L$  decays and to extract the direct  $CP$  violating contribution.

### 2.3 $\eta$ decays in four charged particles

The radiative decays of the  $\eta$  meson where the virtual photon converts into a lepton pair allow to study the  $\eta$  internal structure, and to search for unconventional possible  $CP$  violation mechanisms. The BR of the  $\eta \rightarrow \pi^+\pi^-e^+e^-$  decay has been recently measured at KLOE [16] with a  $3.4\%$  statistical uncertainty and a  $2.6\%$  systematic one. The detection efficiency for these decays is strongly limited by the minimum detectable transverse momentum  $\sim 23 \text{ MeV}/c$  with the KLOE DC, being the transverse momentum distribution of the four tracks peaked at low values,  $\sim 10 \text{ MeV}/c$ . Moreover the largest con-

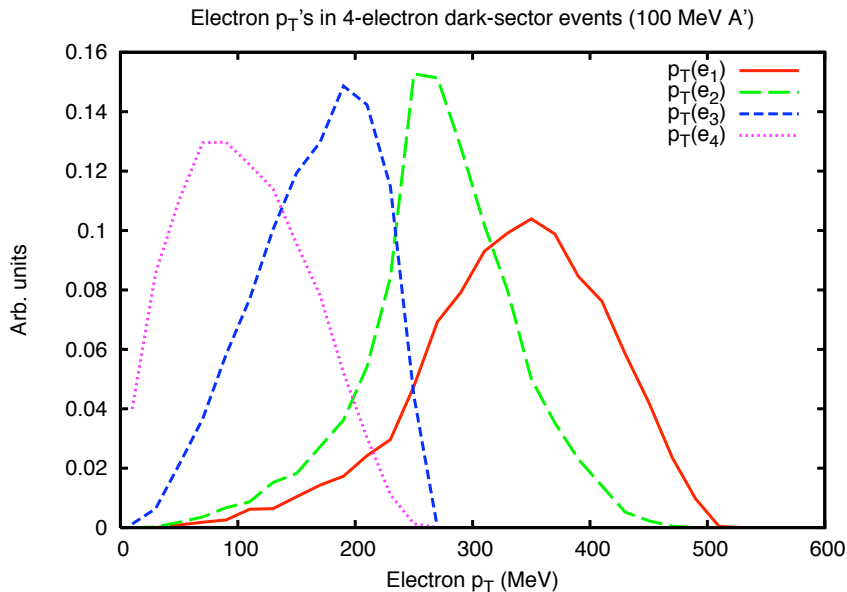

Figure 4: *Transverse momentum distribution of the four electrons produced in events involving a neutral vector boson with a mass of 100 MeV connected with a secluded gauge sector. Electrons are sorted by decreasing transverse momentum.*

tribution (70%) to systematic uncertainty is due to the cut to reject  $\eta \rightarrow \pi\pi\gamma$  events with  $\gamma$  conversion on the beam pipe. The insertion of an inner tracker between the beam pipe and the KLOE DC is expected to significantly improve both the acceptance of low momentum tracks and the vertex and momentum resolution to reject much more efficiently the background. Similar benefits are expected for the  $\eta \rightarrow e^+e^-e^+e^-$  and  $\eta \rightarrow e^+e^-\mu^+\mu^-$  decays with a BR in the range  $10^{-5}$  and  $10^{-7}$ , respectively, well accessible at KLOE-2.

## 2.4 Multi-lepton events

Several puzzling astrophysical observations (PAMELA, ATIC, INTEGRAL, DAMA) have been recently interpreted by postulating the existence of some secluded gauge sector weakly coupled with the SM particles. The typical energy scale for this new physics is 1 GeV or less, and can therefore induce observable signals at DAΦNE. One of the possible signatures for the secluded sector is the production of multi-lepton events, whose energy spectrum is highly dependent on the lepton flavor/multiplicity and on the actual values of the parameters of the theory (the mass of the vector boson, for instance). As an example, in fig. 4 the transverse momentum distribution of the four

electrons produced in events involving the neutral vector boson mediating the new interaction with a mass of 100 MeV, is shown. The low momenta of the leptons in this kind of events (about 30% of the events have at least an electron below 50 MeV/c; this fraction might become larger for a different choice of the vector boson's mass or if muons are present instead of electrons) translates into a low geometrical acceptance due to the KLOE magnetic field. The need to fully reconstruct the event in addition to the necessity to reject the background due to  $\gamma$  conversions on the beam pipe makes, in this respect, the insertion of an inner tracker extremely beneficial.

### 3 Detector design requirements.

The design of the IT is driven by physics requirements and space constraints due to limited detector clearance. The inner radius must preserve the  $K_S$ - $K_L$  quantum interference region (e.g. from  $K_S$  regeneration) shown in fig. 5 in units of  $K_S$  lifetime ( $\tau_S \simeq 0.6\text{cm}$  at a  $\phi$ -factory). It follows that the inner radius of the IT should be at least at a distance of  $\simeq 20\tau_S \simeq 12$  cm from the IP. The outer radius of the inner tracker is constrained from the presence of the drift chamber inner wall at 25 cm.

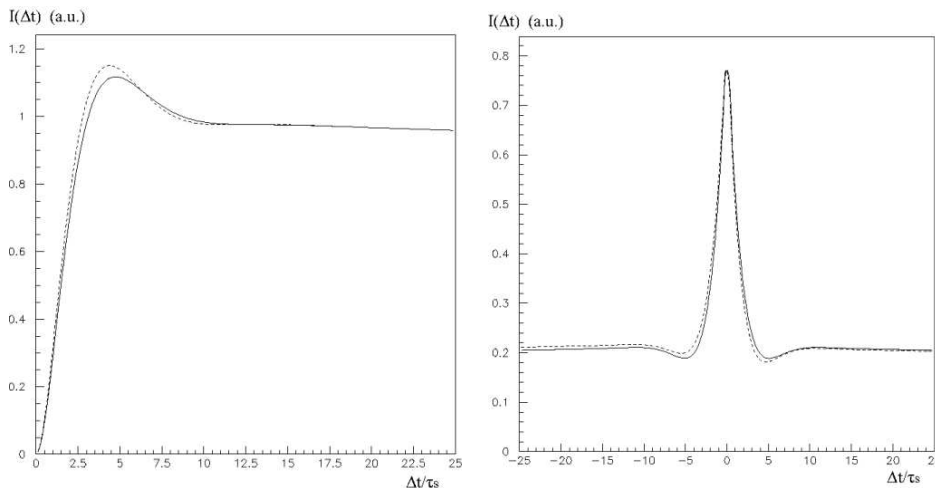

Figure 5: (Left) Distribution of the decay time difference  $|\Delta t|$  for  $K_S K_L \rightarrow \pi^+ \pi^-, \pi^+ \pi^-$  events (Right) Distribution of the decay time difference  $\Delta t$  for  $K_S K_L \rightarrow \pi^- l^+ \nu, \pi^+ l^- \bar{\nu}$  events

A crucial design parameter is the resolution on the  $K_S$  decay point, occurring within few cm from the IP. An accurate study of quantum interferometry requires an improvement on this resolution of a factor 3-4 with respect to the

present value ( $\simeq 0.6$  cm).

In order to reconstruct the decay vertex nearby the IP, the charged decay tracks must be extrapolated from the hit on the IT innermost layer to the decay point. This in turn implies that both the spatial resolution of the IT and the multiple scattering contribution must be carefully taken into account in the evaluation of the track momentum resolution. To this extent and in order to minimize photon conversion, the IT should give a maximum contribution to the overall material budget of  $\sim 2\% X_0$ .

The event rate from  $\phi$ -decays at  $O(10^{33})$   $\text{cm}^{-2}\text{s}^{-1}$  luminosity is of the order of 10 KHz. However a critical parameter for the inner tracker design is given by the occupancy due to the machine background events. The composition (electrons and/or photons), the rate, the spatial and momentum distribution of these events are difficult to estimate since they are highly dependent on the machine optics, operating conditions, and on the configuration of screens and absorbers. A first estimate of the background occupancy can be obtained from the counting rate of the silicon detector of the FINUDA experiment that collected data at the second DAΦNE interaction region: at a radius of 6 cm from IP this detector collected 7-8 hits/plane in  $2\mu\text{s}$  of integration time at  $10^{32}\text{cm}^{-2}\text{s}^{-1}$  luminosity. Scaling with the luminosity and detector's geometry, the occupancy for the IT is 10-20 hits /layer, in one  $\mu\text{s}$  of integration time. An alternative estimate can be obtained by properly scaling the single counting rate of the innermost layer of the KLOE DC positioned at 28 cm from the IP. The result is found to be consistent with the previous estimate. In order to minimize the possible effect of combinatorial for an independent pattern recognition based on IT hits, the detector should have the shortest possible integration time. As a reference figure for the integration time of the IT, we have considered 200 ns, equal to the maximum delay between the  $e^+e^-$  collision and the KLOE trigger signal formation.

Summarizing, the detector requirements for the IT are:

- $\sigma_{r\phi} \sim 200\mu\text{m}$  and  $\sigma_Z \sim 400\mu\text{m}$  spatial resolutions, to improve present resolution on the  $K_S$  decay point by a factor of  $\sim 3$ ;
- $2\% X_0$  overall material budget;
- 5 kHz/ $\text{cm}^2$  rate capability.

### 3.1 Detector layout

The Inner Tracker will be inserted in the available space inside the Drift Chamber. The proposed solution consist of five independent tracking layers (L1-L5), each providing a 3-D reconstruction of space points along the track

with a 2-D readout. The innermost layer is placed at 12.7 cm from the beam line, corresponding to  $20 \tau_S$  avoiding to spoil the  $K_S K_L$  interference. The outermost layer will be placed at 23.0 cm from the beam line, just inside the internal wall of the Drift Chamber. The active length for all layers is 700 mm (fig. 6).

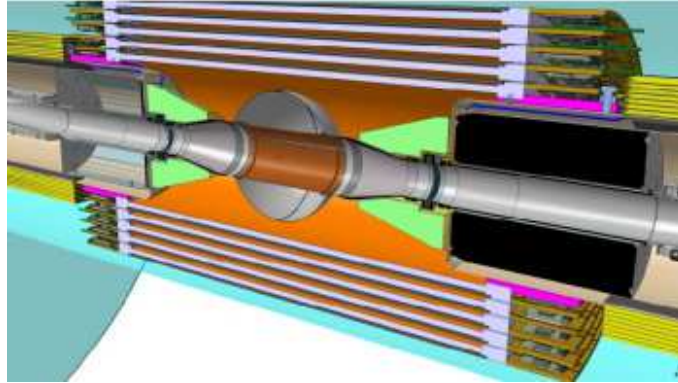

Figure 6: Cross-section of the inner tracker at the interaction point.

We have chosen to realize each layer as a cylindrical-GEM detector (CGEM). The CGEM is a triple-GEM detector composed by concentric cylindrical electrodes (fig. 7): from the cathode (the innermost electrode), through the three GEM foils, to the anode readout (the outermost electrode). The anode readout of each CGEM is segmented with  $650 \mu\text{m}$  pitch XV patterned strips with a stereo angle of about 40 degrees. The full system consists of about 30,000 FEE channels.

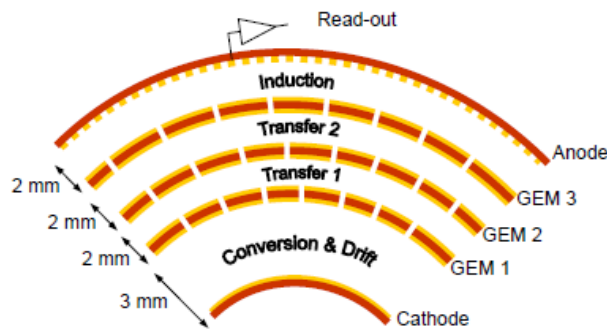

Figure 7: Cross-section of the triple GEM detector.

This innovative technology provides us with an ultra-light and fully sensitive detector, fulfilling the stringent requirement on the material budget

needed to minimize the multiple scattering effect for low-momentum tracks. The detector is composed by thin ( $50\ \mu\text{m}$ ) Copper clad polyimide foils, acting as cathode, readout anode and multiplication stages.

Moreover the high rate capability of the GEM (up to  $1\ \text{MHz}/\text{mm}^2$  measured [17]) makes this detectors suitable to be placed near the interaction point of a high-luminosity collider machine.

### 3.2 Operating principles of a triple-GEM detector.

A GEM (Gas Electron Multiplier) is made by a thin ( $50\ \mu\text{m}$ ) kapton foil, copper clad on each side, with a high surface density of holes [18]. In the standard technique each hole has a bi-conical structure with external (internal) diameter of  $70\ \mu\text{m}$  ( $50\ \mu\text{m}$ ); the hole pitch is  $140\ \mu\text{m}$ . The bi-conical shape of the hole is a consequence of the double mask process used in standard photolithographic technologies. The GEM foils are manufactured by the CERN EST-DEM [19] workshop. A typical voltage difference of 350 to 500 V is applied between the two copper sides, giving fields as high as  $100\ \text{kV}/\text{cm}$  into the holes, resulting in an electron multiplication up to a few thousand. Multiple structures realized by assembling two or more GEMs at close distance allow high gains to be reached while minimizing the discharge probability [20].

The triple GEM detector can effectively be used as tracking detector, with good time and position resolution performance. A cross-section of the detector is shown in fig. 7 indicating all of the GEM stages: conversion and drift, transfer and induction.

### 3.3 Simulation results

Code to simulate the IT detector has been inserted in the official KLOE Monte Carlo program, GEANFI [21]. We used a reference geometry where the IT is made of five cylindrical triple-GEM layers, 70 cm long and with the innermost plane of the triple-GEM positioned at the following radii from the IP (in cm): 12.7, 14.9, 17.1, 19.3 and 21.5.

The simulation accounts for the following materials for each GEM layer:  $300\ \mu\text{m}$  of kapton,  $2\ \mu\text{m}$  of copper, and 8 mm of gas mixture ( $\text{Ar-CO}_2$ ). The grand total of the material budget for the five layers of the IT is then 1.08 % of  $X_0$ . Each GEM is simulated as a 2 mm gas stage, in which ionization takes place, followed by the three multiplication stages simulated as a whole. The simulated hits from the particles crossing the IT are then digitized according to a two dimensional X-V strip readout for each GEM layer. The X strips

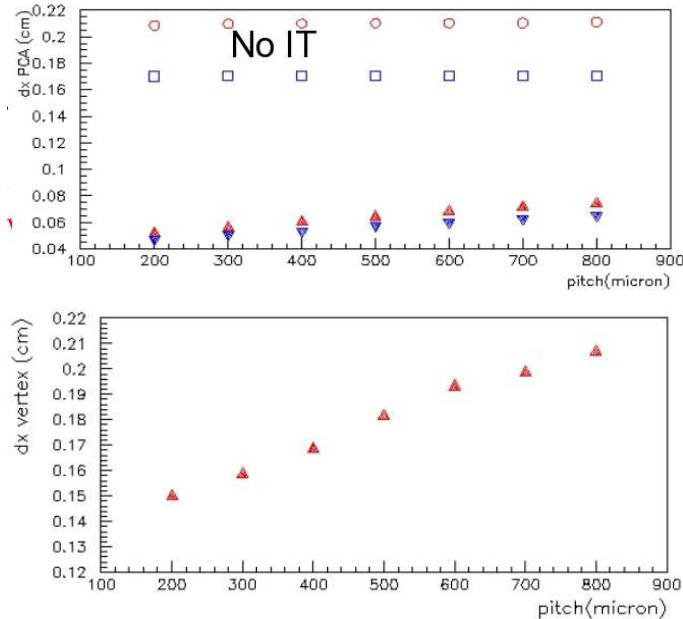

Figure 8: (Top) Resolution on the point of closest approach to the decay vertex in the transverse plane obtained for reconstructed tracks in  $K_S \rightarrow \pi^+\pi^-$  (BLUE triangle) and  $K_S \rightarrow \pi^+e^-\nu$  events (RED triangle). Empty point indicates the same quantities without the IT. (Bottom) Vertex resolution obtained in the transverse plane for  $K_S \rightarrow \pi^+\pi^-$  decays using several values of the readout pitch.

are parallel to the  $z$  beam axis <sup>1</sup>, while the V strips have a 40 degree angle with respect to the beam axis. Both X and V strips have a  $650 \mu\text{m}$  pitch. The Z coordinate is then obtained from the crossing of both X and V strip readout as  $Y = \tan(50^\circ) \times X + V/\cos(50^\circ)$ . The corresponding single hit resolution obtained with digital readout is  $\simeq 190 \mu\text{m}$  in the  $r - \phi$  plane and  $\simeq 400 \mu\text{m}$  in the  $z$  direction.

The digitization procedure takes properly into account the presence of ghost hits due to the X-V projection. To extract the helix parameters of the incoming particle, the digitized hits are grouped first into clusters, then the clusters information is processed by a dedicated tracking code.

We start with the tracks already reconstructed in the KLOE Drift Chamber and extrapolated to the IT. The helix parameters obtained from the DC are updated with the Kalman filter by using the information of the IT clus-

<sup>1</sup>In the following the coordinate system is defined with the  $z$ -axis along the bisector of the  $e^+e^-$  beams, positive along the positron motion, the  $y$ -axis vertical and the  $x$ -axis toward the center of the collider rings and origin at the collision point.



ters. Finally the tracks are extrapolated to the IP and given as input to a simple vertex finder based on minimum helixes distance.

The simulation shows that pions coming from  $K_S \rightarrow \pi^+\pi^-$  decays cross nearly orthogonal the GEM layers, due to the typical P-wave angular distribution of kaons produced from  $\phi$  decays. Fig 8 top shows the resolution on the point of closest approach to the decay vertex in the transverse plane obtained for reconstructed tracks in  $K_S \rightarrow \pi^+\pi^-$  and  $K_S \rightarrow \pi^+e^-\nu$  events. The comparison with the same quantity obtained without the IT shows an

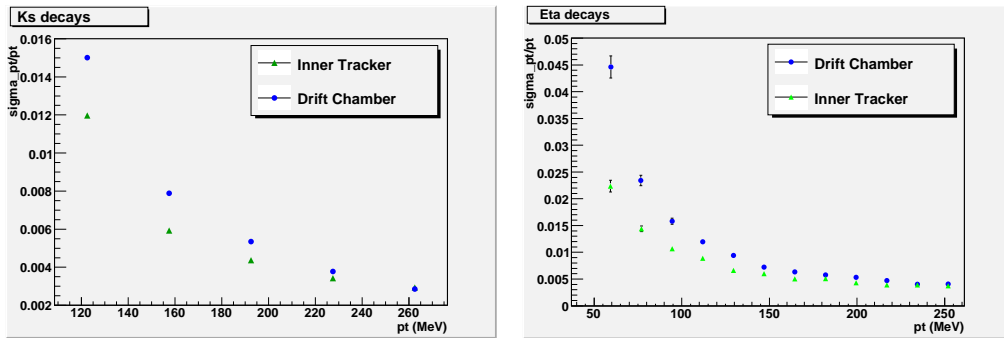

Figure 9: Resolution  $\sigma_{p_T}/p_T$  on the transverse momentum measurement as a function of  $p_T$  for  $K_S \rightarrow \pi^+\pi^-$  (Left) and  $\eta \rightarrow \pi^+\pi^-e^+e^-$  decays (Right) with DC only (circles) and adding the IT information (triangles).

improvement of a factor 3 with a  $600 \mu m$  pitch, perfectly compatible with the requirements of KLOE-2, discussed in the previous section. Fig 8 bottom shows the vertex resolution obtained in the transverse plane for  $K_S \rightarrow \pi^+\pi^-$  decays using several values of the readout pitch.

The insertion of the Inner Tracker improves also the resolution on the measurement of the transverse momentum,  $p_T$ . The effect has been studied with  $K_S \rightarrow \pi^+\pi^-$  and  $\eta \rightarrow \pi^+\pi^-e^+e^-$  decays, assuming a pitch of  $650 \mu m$ . Fig.9 shows the behaviour of  $\sigma_{p_T}/p_T$  as a function of  $p_T$ , obtained using the DC only and adding the IT information. As expected, usage of the IT improves the transverse momentum resolution for low momentum tracks, as much as 20% at  $p_T \simeq 120$  MeV for  $K_S \rightarrow \pi^+\pi^-$  decays and 50% at  $p_T \simeq 60$  MeV for  $\eta \rightarrow \pi^+\pi^-e^+e^-$  decays.

## 4 Prototype studies

The idea of a cylindrical GEM detector was tested for the first time with a small prototype (7 cm radius and 24 cm length) [22]. The very positive results obtained with this prototype paved the road for the construction of a full-scale prototype for the first layer of the IT. Since then, the R&D activity for the final detector has been focused on three main items: the realization and test of a full-scale Cylindrical GEM prototype, the detailed study of the XV readout, performed on dedicated small planar chambers for simplicity and economical reasons, and the realization of very large GEM foils based on the new single-mask technology. In the following three subsections, these three items will be discussed in detail.

### 4.1 Full-scale CGEM prototype

In 2007 we built a cylindrical GEM prototype with dimensions similar to those of the first layer of the final IT: it has the same diameter of 300 mm but a reduced active length, 352 mm instead of 700 mm, due to a limitation in the availability of large area GEM foils. For the same reason a single cylindrical electrode (352x960 mm) was obtained as a joint of three identical GEM foils (352x320 mm).

The detector has a geometrical configuration of the gaps of 3/2/2/2 mm, respectively for drift/transfer1/transfer2/induction (fig. 7), with the cathode being the innermost electrode.

#### 4.1.1 Construction

A special manufacturing technique has been developed to obtain cylindrical GEM electrodes, as shown in fig. 10. At first three GEM foils are glued together to obtain the single large foil needed to make a cylindrical electrode. We used an epoxy (Araldite), applied on one of the short sides of the GEM foil, on a 3 mm wide region (fig. 10 top-left). Then the foil is rolled on an aluminum mould coated with a very precisely machined 400  $\mu\text{m}$  thick Teflon film which provides a non-stick, low friction surface (fig. 10 top-right). Finally the mould is inserted in a vacuum bag where vacuum is made with a Venturi system, resulting in a uniform pressure of 0.8  $\text{Kg}/\text{cm}^2$  over the whole surface of the cylinder (fig. 10 bottom-left). At this stage, two fiberglass annular rings are glued on the edges of the electrode, acting as spacers for the gaps and providing all of the mechanical frames needed to support the detector. After the curing cycle of the glue, the cylindrical electrode is easily

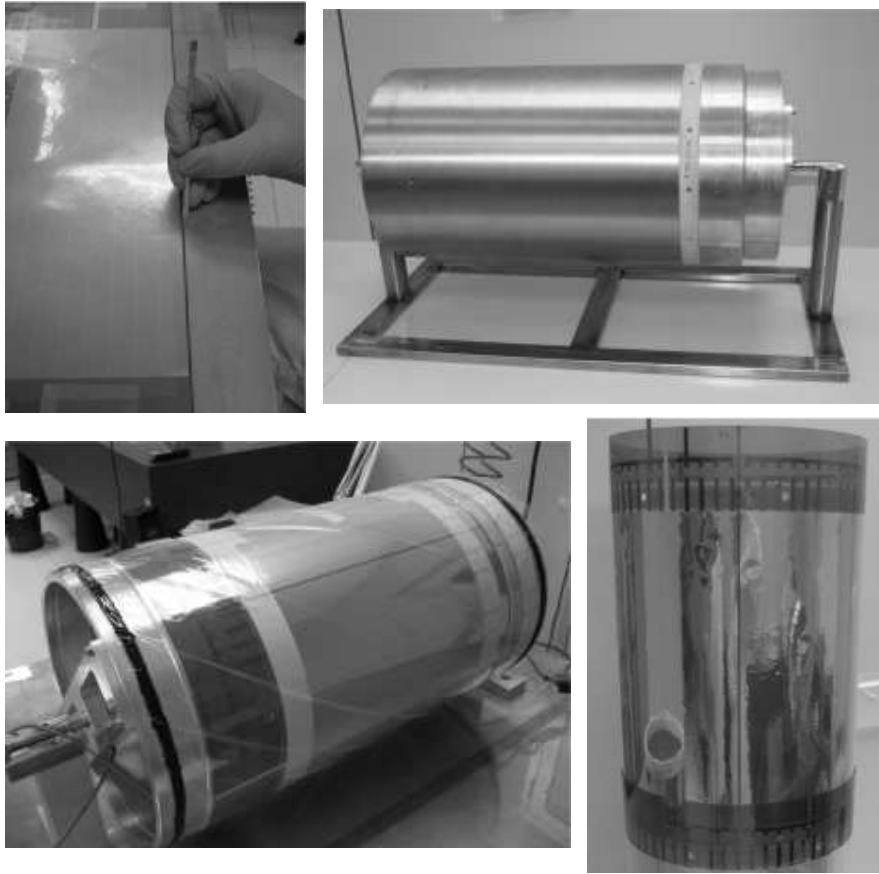

Figure 10: The various steps of the construction of a cylindrical GEM. See the text for the description.

extracted from the mould thanks to the Teflon surface (fig. 10 bottom-right). Cathode and anode are obtained with the same procedure as well.

**The cylindrical cathode** The cathode is realized as a unique polyimide foil,  $100\ \mu\text{m}$  thick, with a copper cladding of  $18\ \mu\text{m}$  on the internal surface. All the support mechanics of the chamber is composed by annular flanges made of Permaglass (G11) placed on the edges of the cylinder. These flanges house the gas inlets and outlets and their thickness defines the distance between the various electrodes.

**The GEM foils** Three  $352 \times 320\ \text{mm}^2$  foils are spliced together in order to realize one single prototype electrode. For a safe detector operation the foil has independent high voltage sectors, in order to limit the capacitance and hence the energy released through the GEM hole in case of discharges. Each

foil has 20 sectors, with an area of about  $56 \text{ cm}^2$ , corresponding to a width of 1.6 cm for the single sector.

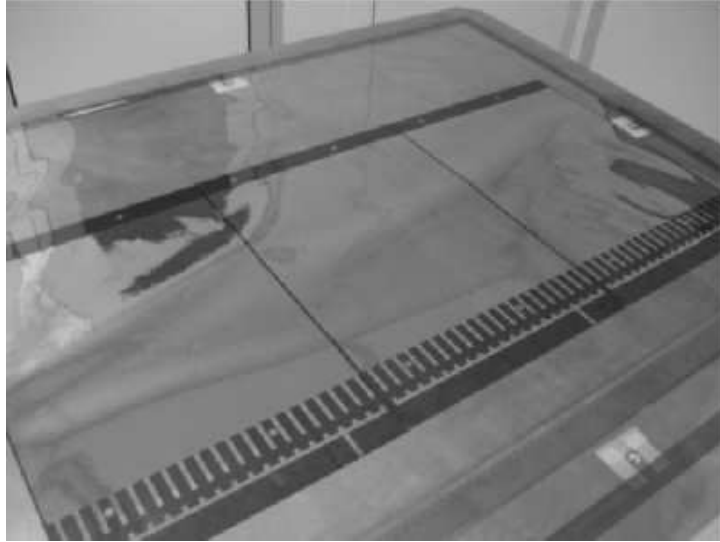

Figure 11: The GEM obtained as a join of three foils. The dimensions are  $960 \times 352 \text{ mm}^2$ .

**The anode readout** Also the anode is realized as a splicing of three foils (fig. 11), each with the readout copper strips and the ground. The copper strips surface and the ground surface are placed on the opposite faces of two different polyimide foils, staggered and glued together. This avoids discontinuities in the readout strips and preserves the pitch value across the overlap region. In order to bring out the signals, the strips end-up in polyimide flaps (see fig. 12), each grouping 32 strips, where the FEE is plugged with ZIF connectors. The pitch of the strips is  $650 \mu\text{m}$  in the readout zone and provides a  $\sigma \simeq 200 \mu\text{m}$  spatial resolution, when equipped with a digital readout, fulfilling the KLOE-2 requirements. In the flaps the pitch is reduced to  $500 \mu\text{m}$  in order to match the pitch of the connector.

**Assembly of the detector** The five electrodes are extracted from the moulds by using a PVC ring, bound with pins to one of the annular flanges of the cylinder, and then are inserted one into the other. To accomplish the insertion of the electrodes without damaging the GEMs, a dedicated tool has been realized: the Vertical Insertion System (fig. 13). The electrodes are fixed on two aluminum plates aligned on a vertical axis, and one is pulled down with a very precise linear bearing equipment.

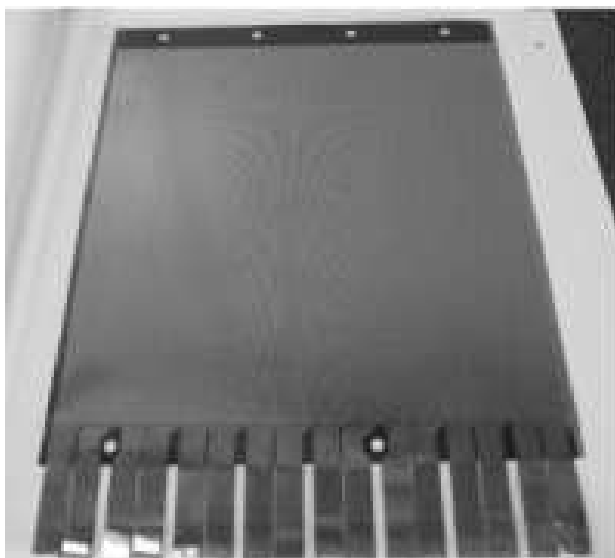

Figure 12: The anode with the strips for the readout and the flaps for the bonding of the FEE.



Figure 13: Two electrodes fixed on the vertical insertion system used to assembly the detector.

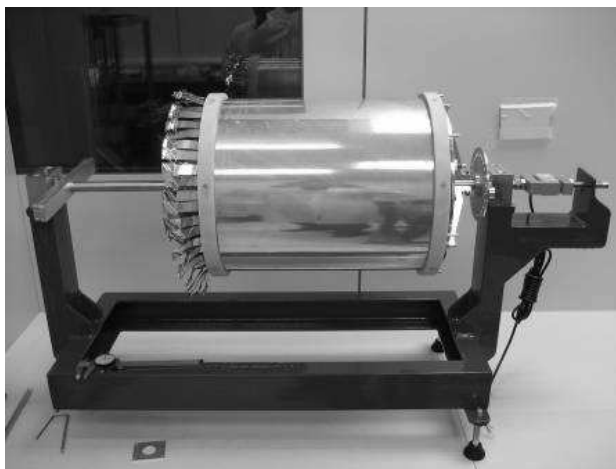

Figure 14: The chamber mounted on the support system and stretched. The tension is measured by the load cell on the right end.

After the assembly of all the electrodes, the detector has been sealed on both sides, mounted on a support system and longitudinally stretched with a tension of 200 g/cm ( $\sim 100$  kg of overall tension) measured by a load cell (see fig. 14).

#### 4.1.2 X-ray test

The very first test of the CGEM prototype was performed using a X-rays source. The prototype was flushed with a gas mixture of  $Ar/iC_4H_{10}/CF_4 = 65/7/28$  and tested in current mode with a 6 keV X-ray gun. A  $10 \times 10$  cm<sup>2</sup> planar GEM was placed in the same gas line and irradiated from a side opening of the gun. It was used as a reference to account for possible gain variations due to changes in atmospheric variables. We estimate that we operated the CGEM prototype at gains larger than  $10^4$ . In order to characterize the CGEM detector and to find the optimal operating parameters, the relative gain with respect to the reference was measured as a function of the different electric fields in the GEM. The first two plots of fig. 15 show the electron transparencies (defined as effective gain normalized on its maximum value) as a function of the drift and the transfer fields: this is a measurement of the focusing efficiency of the electrons into the three GEM foils. The third plot of fig. 15 shows the charge sharing between the bottom surface of the third GEM and the anode readout, as a function of the induction field: this is a measurement of the extraction efficiency from the last GEM foil. The sum of the two charges is also shown (red and blue triangle on the third plot); no dependence from the induction field is observed. All the measurements

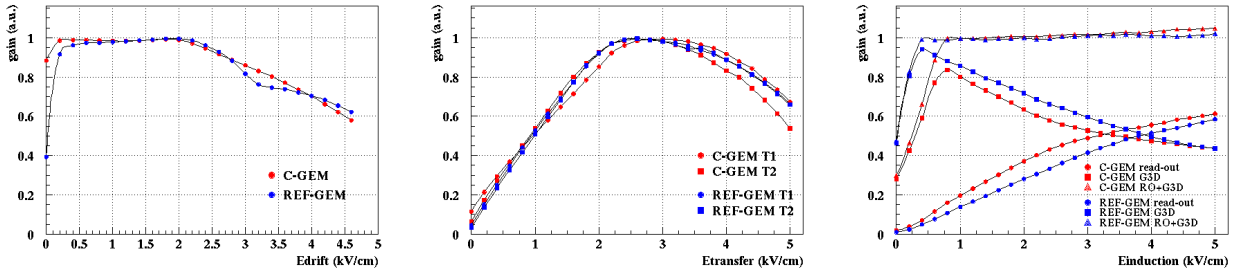

Figure 15: Relative gain as a function of drift field (left), transfers fields T1 and T2 (center) and induction field (right) of the CGEM with respect to the planar reference chamber. All the electric fields not involved in each measurement are kept at constant values.

have been performed with a CGEM polarization of 375/365/355 V and are in good agreement with previous results found in literature.

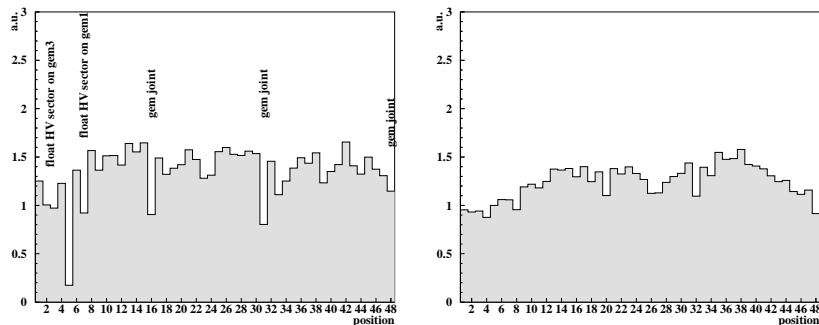

Figure 16: CGEM gain uniformity (left) and induction gap thickness uniformity (right). Excluding sectors with intrinsically weaker response (e.g. gem joints), both measured values have R.M.S. within 9%.

The uniformity of the CGEM has also been measured over the 940 mm of its circumference (fig. 16). The fluctuations (R.M.S.) of the measured currents were within 9%, showing a good uniformity on such a large surface. Since the ratio between the current on the bottom side of the third GEM and the read-out electrode depends only on the applied induction field, we were also able to measure the uniformity of the induction gap thickness. The result indicates that the detector construction was realized with good mechanical precision.

### 4.1.3 CGEM test beam at CERN

The CGEM prototype was also extensively tested with the 10 GeV pion beam at the T9 area of CERN PS [23]. Two different read-out devices were used: 128 channels were equipped with the GASTONE ASIC, while 96 channels with the CARIOCA-GEM electronics.

GASTONE is a custom chip, developed to fulfill the low-power consumption and high integration requirements of the KLOE-2 experiment. Its first release was tested during the test beam [24]. Results of this test are reported in sec. 6.1.1.

The CARIOCA-GEM chip, instead, has been developed for the LHCb Muon System GEM detectors. CARIOCA is a very fast chip (10 ns peaking time) with digital readout and has been used to measure the timing performance of the detector, coupled to a 100 ps resolution TDC.

The CGEM was flushed with a Ar/CO<sub>2</sub> (70/30) gas mixture and operated with the following voltages:  $V_{fields} = 1.5/2.5/2.5/4$  kV/cm and  $V_{GEM} = 390/380/370$  V ( $\sum V_G = 1140$ V, corresponding to a gas gain of  $2 \times 10^4$ ).

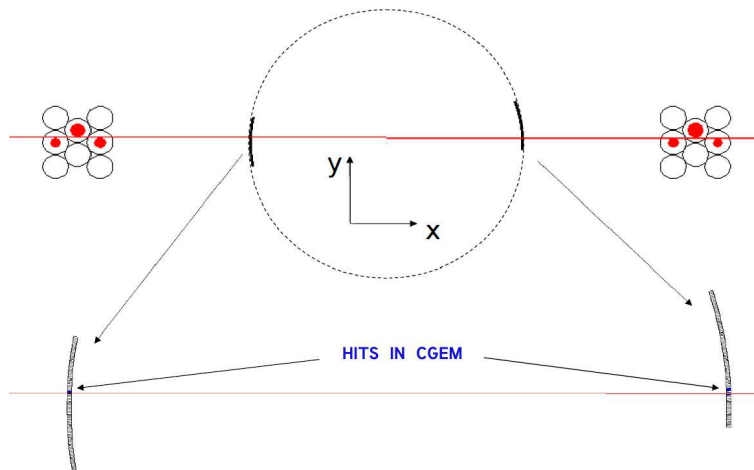

Figure 17: An event display example illustrating the tracker setup. Two sets with 3 planes of drift tubes (20 channels in total) are placed in front and behind the CGEM to measure the Y coordinate.

The track position was measured with an external tracker based on ATLAS drift tubes with 30 mm diameter and 0.4 mm wall thickness. These tubes were operated with a 100  $\mu$ m wire diameter, in streamer mode, using a gas mixture Ar/C<sub>4</sub>H<sub>10</sub> : 40/60 at STP.

The tracker consisted of two sets of longitudinal stations, each with 8 channels arranged on 3 planes, placed in front and behind the CGEM prototype and providing a measurement of the Y coordinate (see fig. 17). Only



tracks with on-time hits in each of the 6 tracker planes have been used for the analysis.

The contribution to the spatial resolution due to the external tracker was measured to be  $\sigma_{tracker} = 140\mu\text{m}$ . The setup also included a trigger built with a coincidence of three scintillators placed before and after the CGEM.

The reconstruction procedure had to take into account the fact that the measured particles do not generally cross the detector along the radius of the cylinder i.e. along the drift lines inside the gems. This is shown in fig. 18. The effect increases moving from the center of the cylinder outwards, and affects both the position resolution and the strip cluster size. For each reconstructed track an offset is calculated, based on the impact position of the track, thus allowing to correct the reconstructed position (see fig. 19 left).

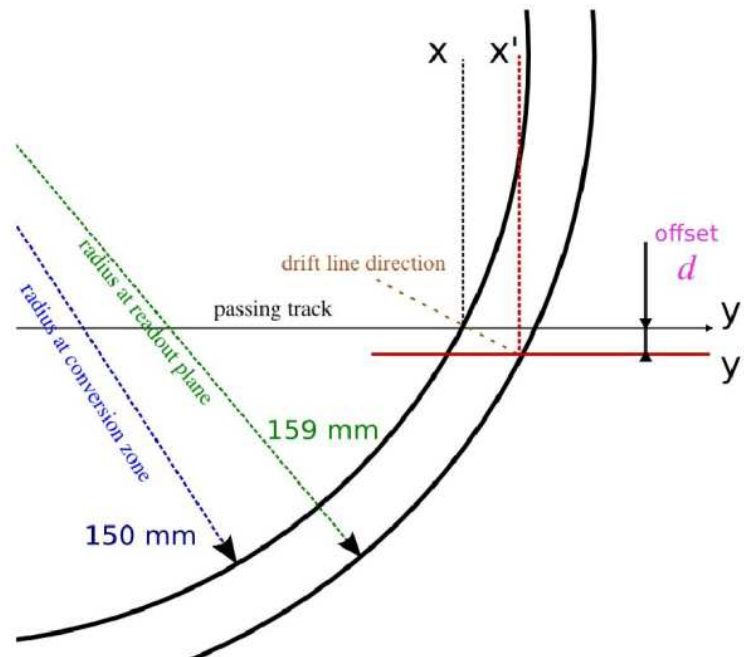

Figure 18: Radial tracks follow drift lines of electrons inside the GEM and pass the readout plane at the same position where the charge collection takes place. Non-radial tracks do not follow drift lines and the measured position on the readout plane is shifted with respect to the impinging position of the track (offset  $d$ ). Moreover cluster created in the conversion zone are not distributed along the drift lines and are collected on several different readout strips thus increasing the cluster size.

Ionization clusters created in the conversion zone by non-radial tracks are not distributed along the drift lines and are collected on several different

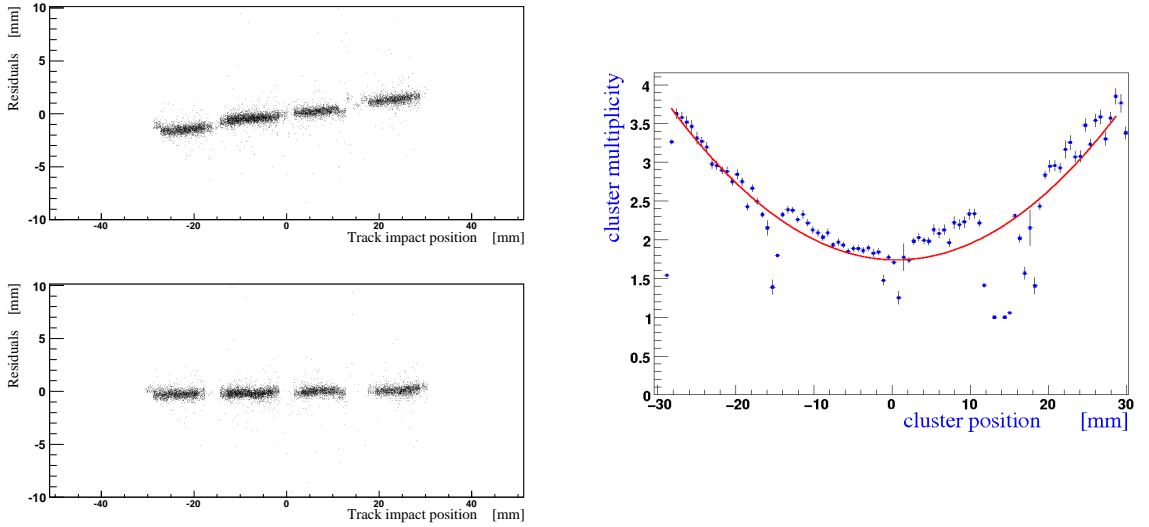

Figure 19: GEM residuals as a function of the track impact point before (top-left) and after (bottom-left) the correction factor for the non-radial tracks. Cluster multiplicity (right) as a function of the track position shows the effect of the offset.

readout strips. This effect leads to an increase of the cluster size as a function of the track impact point in the Y coordinate (see fig. 19 right). For radial tracks (i.e.  $Y=0$ ) an average cluster multiplicity of 1.8 has been measured.

Fig. 20 shows the efficiency of the chamber measured for different positions of the impact track, with the GASTONE chip threshold set at 3.5 fC. The efficiency averaged over the whole equipped region is 97.7%. The low statistics points are due to a lack of reconstructed tracks in proximity of the walls of the drift tubes (30 mm diameter). An efficiency of 99.6% is obtained when rejecting these points.

In order to produce large area GEM foils, one needs to glue together different smaller area GEMs (see sec. 4.1.1); this technique may lead to a possible loss of efficiency of the detector in the overlapping region, which needs to be well studied and understood. In the final detector design, this region accounts for less than 0.4% of the total CGEM foil. In order to investigate this effect, we studied the time distributions obtained using the CARIOCA-GEM chip, readout by a 100ps resolution TDC and with gas mixture Ar/CO<sub>2</sub> (70/30) with drift velocities  $V_d = 7$  cm/ $\mu$ s at 2 kV/cm (approximately 10 clusters in 3 mm). Time distributions in non overlapping (regular) regions and in the joint zone are shown, respectively in fig. 21 left and right. In the regular region a 13 ns RMS is obtained, in agreement

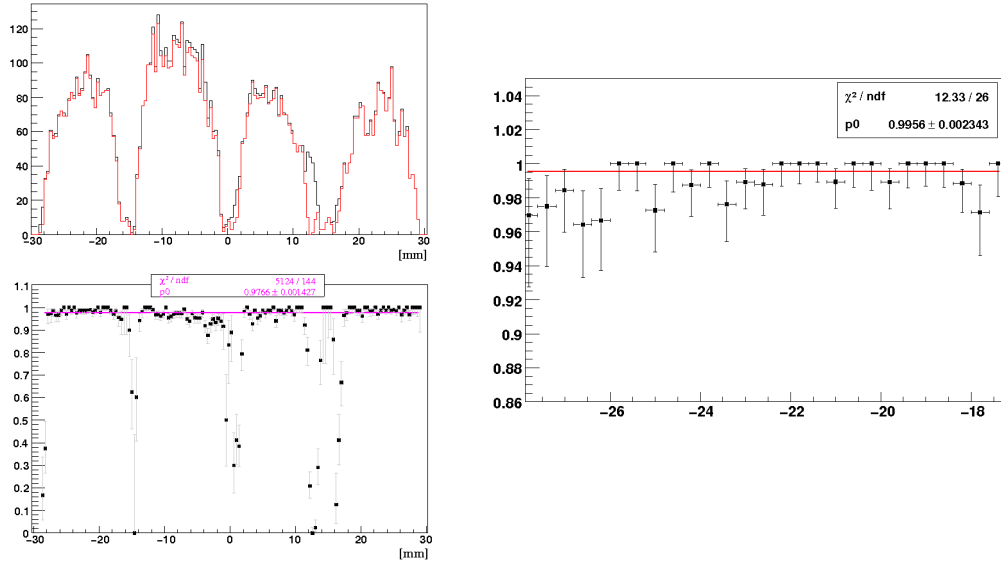

Figure 20: Left top: Distribution of reconstructed (black) and measured (red) impact track position; left bottom: efficiency as a function of the impact track position; right: detail of the efficiency in a high statistics region.

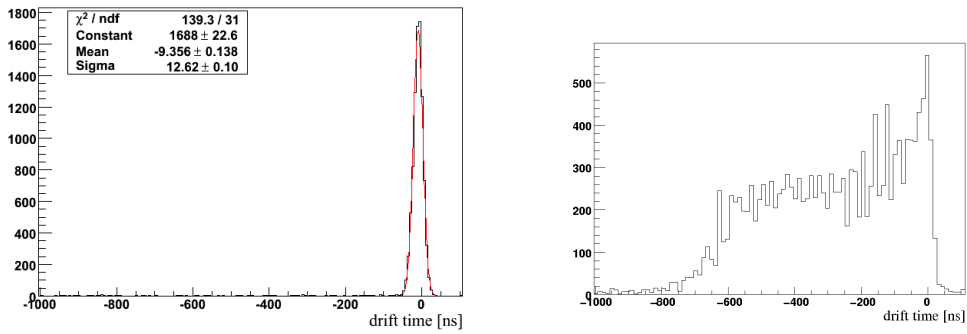

Figure 21: Time distributions in regular regions (left) and in the joint zone (right).

with the performance expected for the gas mixture in use. In the joint zone the spectrum is much broader, with a 200 ns RMS. In particular the signals are delayed up to 800 ns, suggesting that a longer drift path had

to be followed to reach the anode. Ionization electrons originating from a track passing through an overlap region, drift along the distorted field lines, are then efficiently driven and focused in the multiplication holes of the GEM and finally are picked up by the anode with longer collection time. Such hypothesis has been confirmed by simulations studies using ANSYS and GARFIELD, showing a distortion of the field lines in the glueing regions, due to a space charge effect on the dielectric (fig. 22 left).

Fig. 22 right shows the residuals of the clusters position with respect to the reconstructed position of the track. If the contribution of the tracker resolution ( $\sigma_{tracker} = 140\mu\text{m}$ ) is subtracted, the GEM spatial resolution is found to be  $\sigma_{GEM} = \sqrt{\sigma_{residuals}^2 - \sigma_{tracker}^2} \simeq 200\mu\text{m}$ . This is in good agreement with what expected from a digital readout of  $650\mu\text{m}$  pitch strips. In

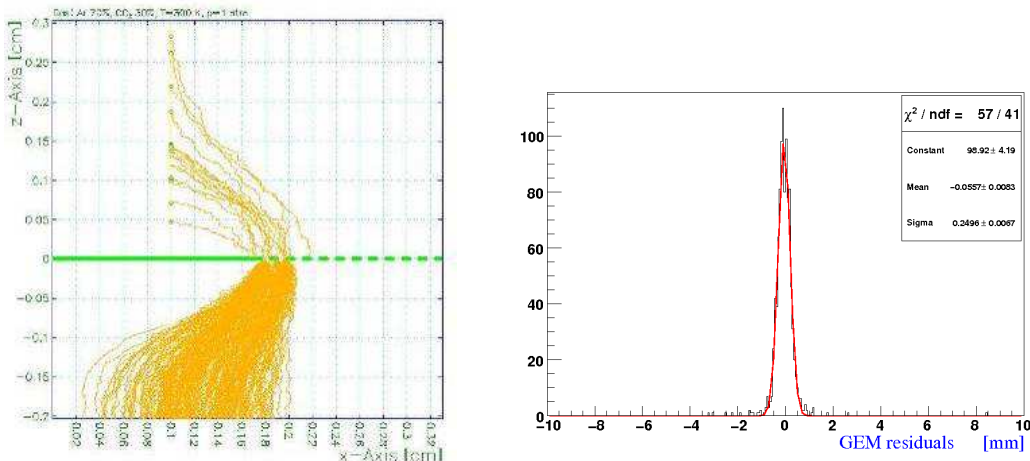

Figure 22: Left: Distortion of the field lines in the glueing region (GARFIELD simulation). Right: CGEM resolution.

conclusion, the full scale prototype was safely operated at CERN PS with 10 GeV pion beam. This test successfully validated the innovative idea of the fully sensitive cylindrical GEM detector, constructed with no support frames inside the active area.

The material budget used in the construction of the CGEM prototype and the the measured spatial resolution are fulfilling the inner tracker requirements.

## 4.2 Planar GEM for readout studies

A typical orthogonal X-Y readout can not be used for the IT, due to its cylindrical geometry. However, a 2-D readout can still be obtained making use of  $650\ \mu\text{m}$  pitch XV patterned strips at an angle of  $40^\circ$  (see sec.5.3.2). The X-Y and X-V readouts are shown in figs. 23 and 24. The investigation of possi-

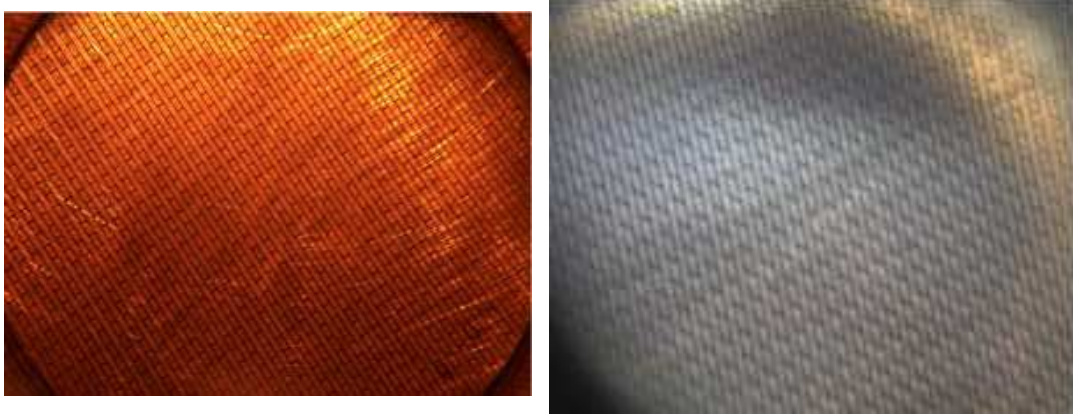

Figure 23: Pictures of the 2D-read-out: (Left) X-Y strips and (Right) X-V strips

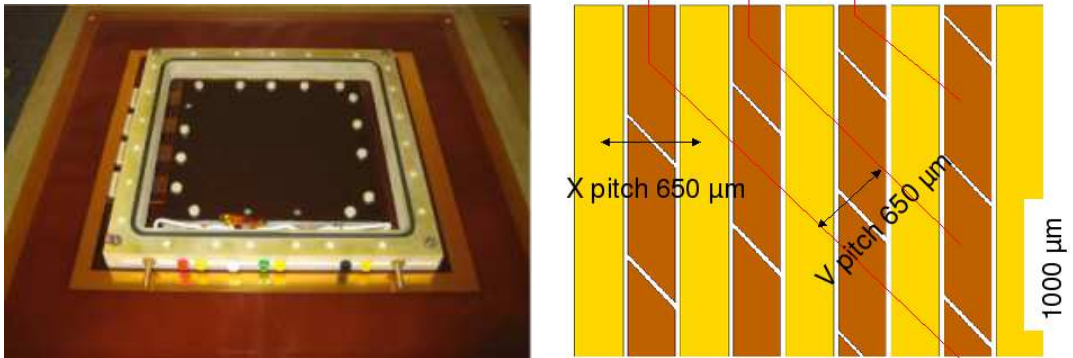

Figure 24: Picture of assembled triple GEM plane with X-V readout (left), schematic details of X-V readout design (right).

ble problems correlated with this specific arrangement (e.g. charge sharing, grounding, cross-talk) required a dedicated test. Moreover, the effects of the KLOE magnetic field on the cluster formation and electronics readout have to be studied. During the previous KLOE data taking, the magnetic field was set at  $0.52\ \text{T}$ . For the future, in order to improve the acceptance for low

momentum tracks, the option to run at a reduced magnetic field value, e.g. 0.3 T, is also under consideration.

#### 4.2.1 Operation in magnetic field

The presence of a magnetic field affects the drift motion of electrons produced by ionization in the gas, thus influencing the position reconstruction of primary particles. All the charged particles involved in the ionization process experience the Lorentz force and consequently their drift path increases. Since the Lorentz force depends on the velocity, the effect is larger for electrons rather than for ions. The Lorentz angle is given by  $\tan \alpha_L = |v(\vec{E})| \cdot |\vec{B}| / |\vec{E}|$ ; its knowledge for each GEM gap is used to evaluate the systematic shift of the collection area of the electrons from the track of the incoming particle. Because of the non-linear dependence of drift velocity from electric field in many gas mixtures, a comparison between simulation results and direct measurements is needed. The simulation has to take into account all the features of the gas mixture, such as the diffusion and Townsend coefficients.

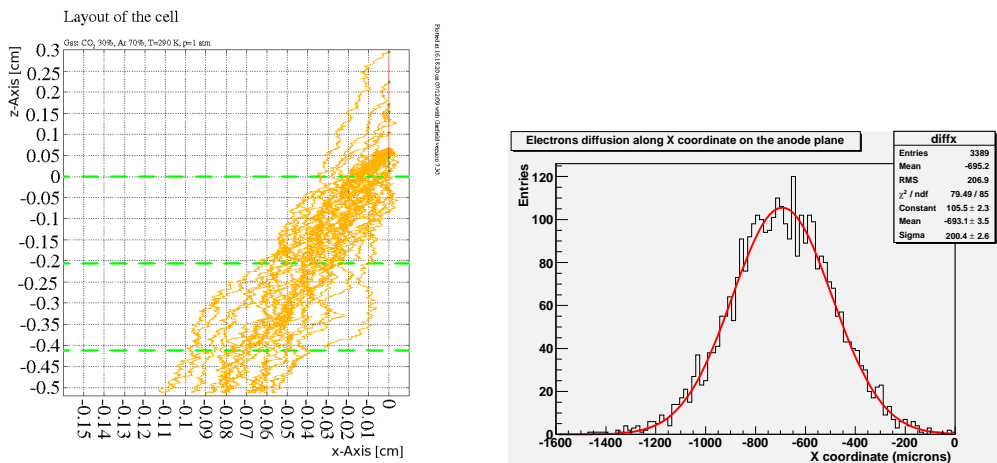

Figure 25: The magnetic field effect in ArCO<sub>2</sub> 70 : 30 on a single track simulated with GARFIELD(left). Position distribution of the collected charge on the X coordinate with the Lorentz shift simulated with GARFIELD (right).

We use a finite elements method in ANSYS program to simulate the chamber, set all the desired voltages and choose a gas mixture. The GARFIELD program simulates the electron drift through the chamber in presence of magnetic field, according to the transport properties of the gas mixture, as a function of the electric field computed by MAGBOLTZ. Fig. 25-left shows the deflection of electrons produced by a minimum ionizing particle in the dif-

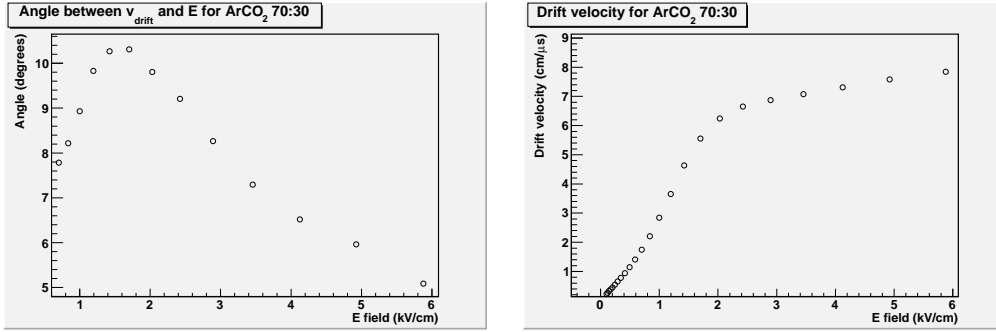

Figure 26: Lorentz angle  $\alpha_L$  (left) and drift velocity (right) for the ArCO<sub>2</sub> 70 : 30 mixture as a function of the electric field.

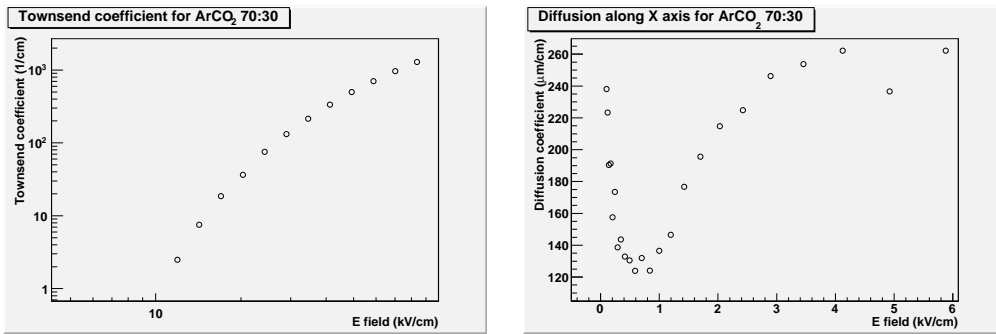

Figure 27: First Townsend coefficient (left) and the diffusion coefficient along the electric field for the ArCO<sub>2</sub> 70 : 30 mixture as a function of the electric field.

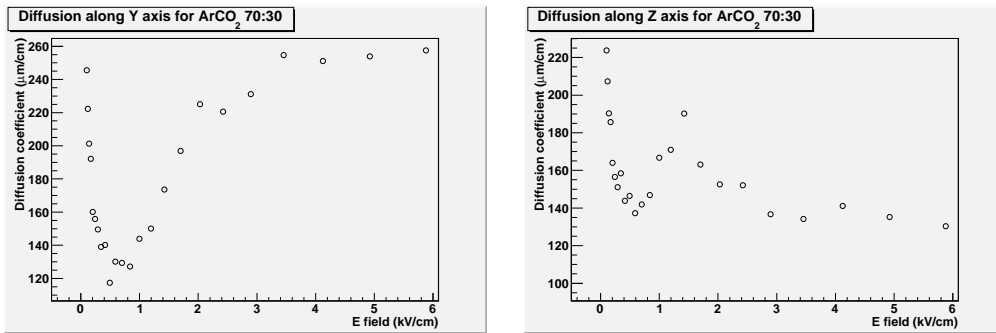

Figure 28: Diffusion coefficient orthogonal (left) and parallel (right) to the magnetic field for the ArCO<sub>2</sub> 70 : 30 mixture as a function of the electric field.

ferent GEM gaps (three dashed lines), obtained with a 0.5 T magnetic field orthogonal to the electric fields. The displacement of the collected charge

with respect to the entry position of the track can be evaluated using this simulation. For  $B=0.5$  T and for the standard working point of the chamber, we obtained an offset  $|\Delta x| = 0.693$  mm, as shown in fig. 25-right.

To study the properties of the gas mixture in the magnetic field we performed detailed calculation of its transport properties in the electric field range  $10^2 \div 10^5$  V/cm and the most relevant parameters are shown in figs. 26, 27, 28. In the following section the results of the simulation have been compared with our measurements obtained with planar GEMs in a magnetic field.

#### 4.2.2 Planar GEM test beam at CERN

A dedicated test was done at SPS-H4 North Area beam line at CERN [25]. The H4 area is equipped with the GOLIATH magnet providing a field adjustable from 0 to 1.5 T perpendicular to the horizontal beam-plane (X-Z). We used 150 GeV/c  $\pi^+$  beam.

The X-V readout (fig. 24 right) was tested with a tracking telescope realized with five  $10 \times 10$  cm<sup>2</sup> planar triple-GEMs detectors with 650  $\mu$ m pitch: four chambers were equipped with standard X-Y readout and the fifth with the X-V readout under investigation. In the following the X-V readout chamber will be referred to as the XV chamber while the X-Y readout chamber as the XY chambers. The five detectors were equally spaced between each other, with the XV chamber placed at the center (see fig. 29). The entire setup was 1 meter long.



Figure 29: Setup of the test beam at CERN with planar chambers with 2D-read-out.

The GEMs were partially equipped with 22 digital readout GASTONE boards, 32 channels each, four on each XY chamber and six on the XV chamber. This was enough to fully cover the area illuminated by the SPS beam.



The coincidence of 6 scintillators ( $3 \times 3 \text{ cm}^2$ ) read-out by silicon multipliers provided the trigger signal for the acquisition.

We have used the same working point as for the CGEM prototype (sec.4.1.3): Ar/CO<sub>2</sub> (70/30) gas mixture and operating voltages  $V_{fields} = 1.5/2.5/2.5/4 \text{ kV/cm}$  and  $V_{GEM} = 390/380/370 \text{ V}$  ( $\sum V_G = 1140\text{V}$ ). The GASTONE threshold was set at 3.5 fC.

In the presence of a magnetic field a displacement  $\mathbf{dx}$  on the readout plane must be observed, due to the effect of the Lorentz force. The displacement is related to the direction of the electric field and, if the detector is rotated, the displacement also changes direction. We arranged the test-beam setup to be able to measure this effect (fig. 30).

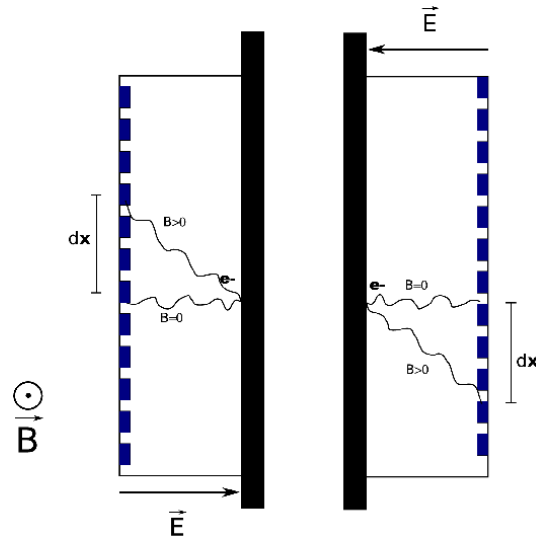

Figure 30: Test beam setup and definition of the measured quantity.

All XY chambers in the tracking telescope were placed with the same anode-cathode configuration while we reversed the XV chamber to cathode-anode arrangement. We aligned the setup with zero magnetic field ( $B=0\text{T}$ ) to a few micrometer precision. In the presence of a magnetic field we reconstructed the track using only the four XY chambers. Since all four of them are subject to the same Lorentz force in the same direction, the reconstructed track will be shifted by the same offset  $\mathbf{dx}$  with respect to the true track trajectory. The XV chamber with the reversed cathode-anode arrangement is affected by the Lorentz force; since the electric field has opposite direction, the displacement inside this chamber is of the same magnitude ( $\mathbf{dx}$ ) but with opposite direction. Hence the measurement of the total displacement between the track reconstructed by the XY telescope and the value measured in the XV chamber is  $D = 2 \cdot \mathbf{dx}$ . (See fig. 31).

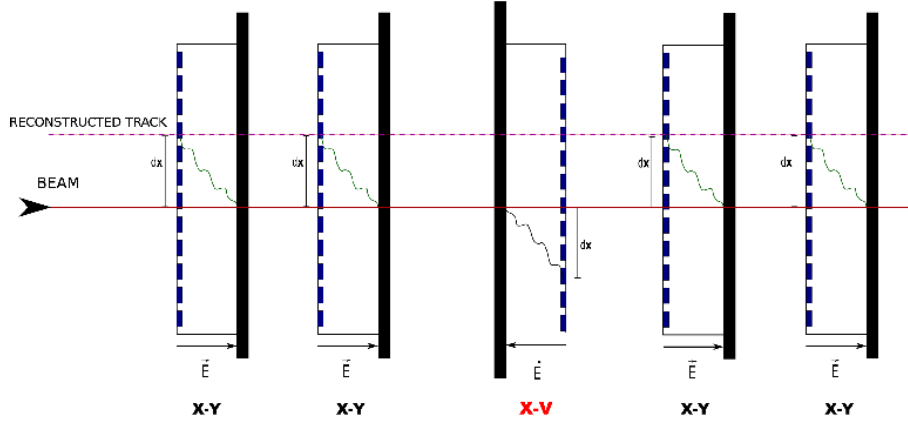

Figure 31: Test beam setup and definition of the measured quantity.

The displacement  $\mathbf{dx}$  was measured for 5 values of the magnetic field and found in good agreement with the value obtained from the GARFIELD simulation at  $B=0.5$  T (sec.4.2.1). See fig. 32. Such effect will be properly taken into account in the reconstruction procedure.

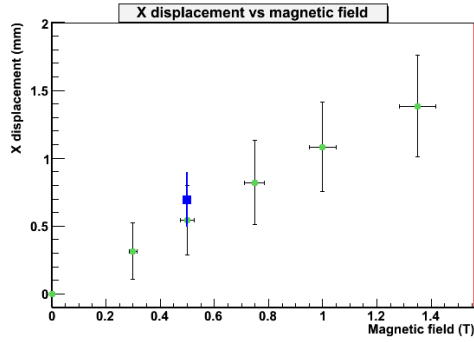

Figure 32: Displacement  $\mathbf{dx}$  as a function of the magnetic field. The blue point comes from simulation results with GARFIELD presented in section 4.2.1.

To study the XV chamber performance, we measured the position resolution defined as the sigma value from the gaussian fit to the residual plot of the XV chamber. The resolution obtained as a function of the magnetic field is shown in fig. 33 together with examples of residual plots at  $B=0$  T and  $B=1.35$  T. There is a clear effect on the resolution with increased magnetic fields, due to the Lorentz force, which on our test-beam setup affects the X coordinate only.

The resolution on the X coordinate ranges from  $200 \mu\text{m}$  at  $B=0$  T up to  $380 \mu\text{m}$  at  $B=1.35$  T. The Y coordinate is obtained from the crossing of both

X and V strip readout as  $Y = \tan(50^\circ) \times X + V/\cos(50^\circ)$  and shows a  $\sim 370 \mu\text{m}$  resolution, in agreement with what expected from the digital readout of the two views.

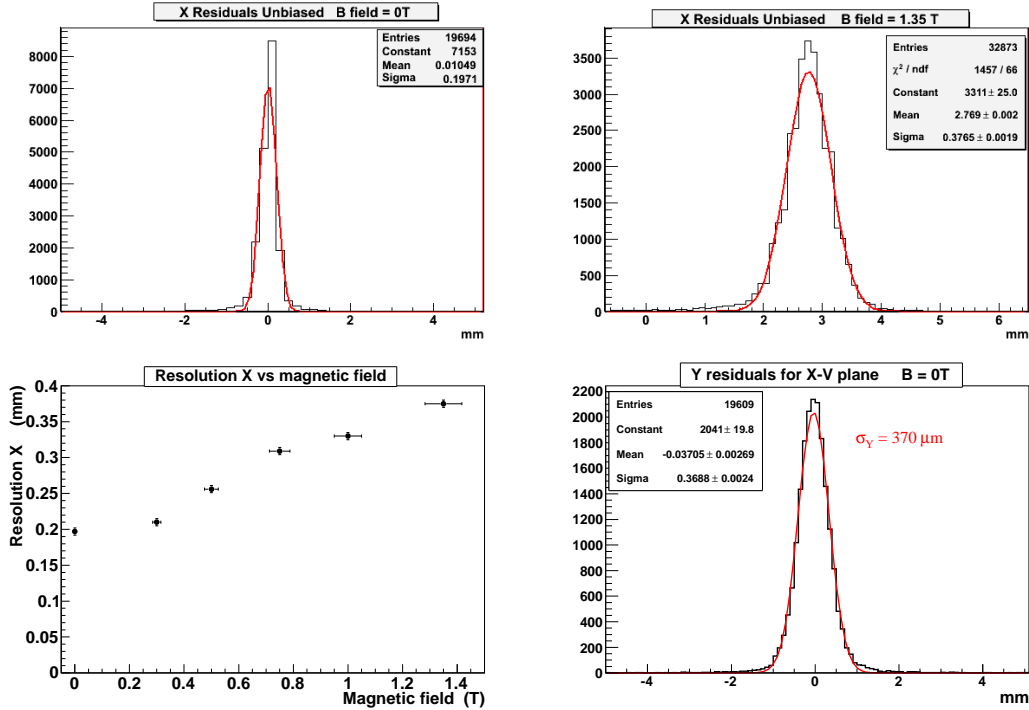

Figure 33: (Top:) Residuals in the X view on the plane with X-V readout, without magnetic field (left) and with 1.35T field (right). (Bottom:) Resolution on the X coordinate as a function of the magnetic field (left). Resolution on the Y coordinate with indicated the corresponding value on V coordinate (right).

We have also measured the position resolution as a function of the GEM voltage (gain). (See fig. 34) It is stable in a rather broad range of the voltage settings around to the nominal value; an appreciable decrease can actually be observed only for values much below the nominal, corresponding to gains  $G \sim 0.3 \times 10^4$ .

The performance of the front-end chip GASTONE have been studied measuring the cluster size and the reconstruction efficiency, defined as the presence of a cluster in the XV chamber when a candidate track was reconstructed using four XY chambers. GEM efficiency and cluster size were measured as a function of the magnetic field and of the GEM voltage (fig. 35). The efficiency for the nominal KLOE B field value and voltage settings was measured to exceed 99%, slightly decreasing at higher B fields.

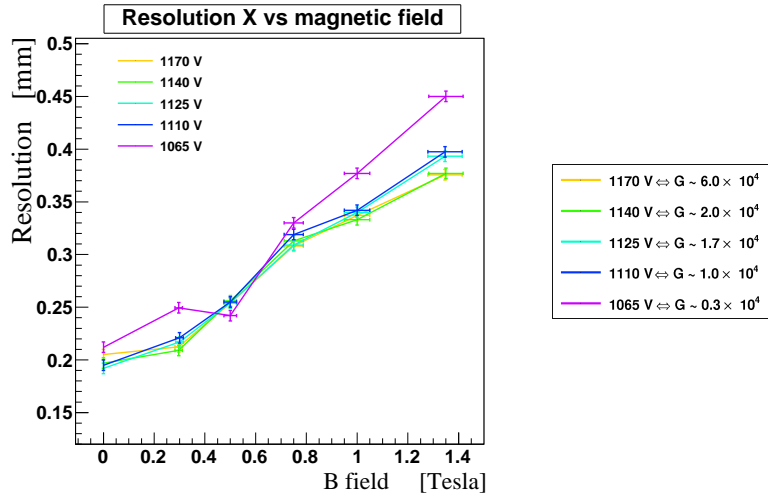

Figure 34: Measured resolution in function of the GEM voltage (gain) and magnetic field.

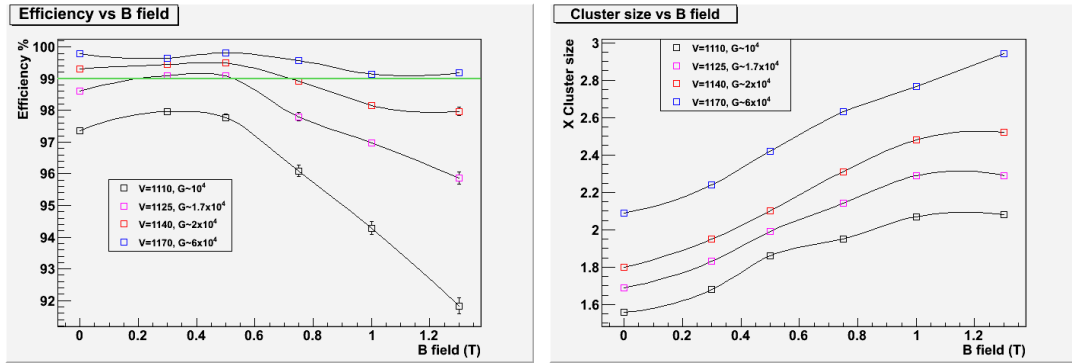

Figure 35: GEM efficiency **left**) and cluster size **right**) in function of the magnetic field given for four different gain values.

The size of the clusters formed in both X and V views were studied as a function of the value of the GASTONE threshold, of the GEM voltage and of the magnetic field (fig. 36).

In principle the charge sharing, grounding, cross-talk could be different for X and V views due to the different readout geometry. However, our measurements showed essentially identical response of both X and V readout views. The variation of the magnetic fields within the KLOE-2 planned values (0.3-0.5 T) has a negligible effect on the reconstruction efficiency in the voltage range around our working point ( $V_{ref} = 1140$  V).

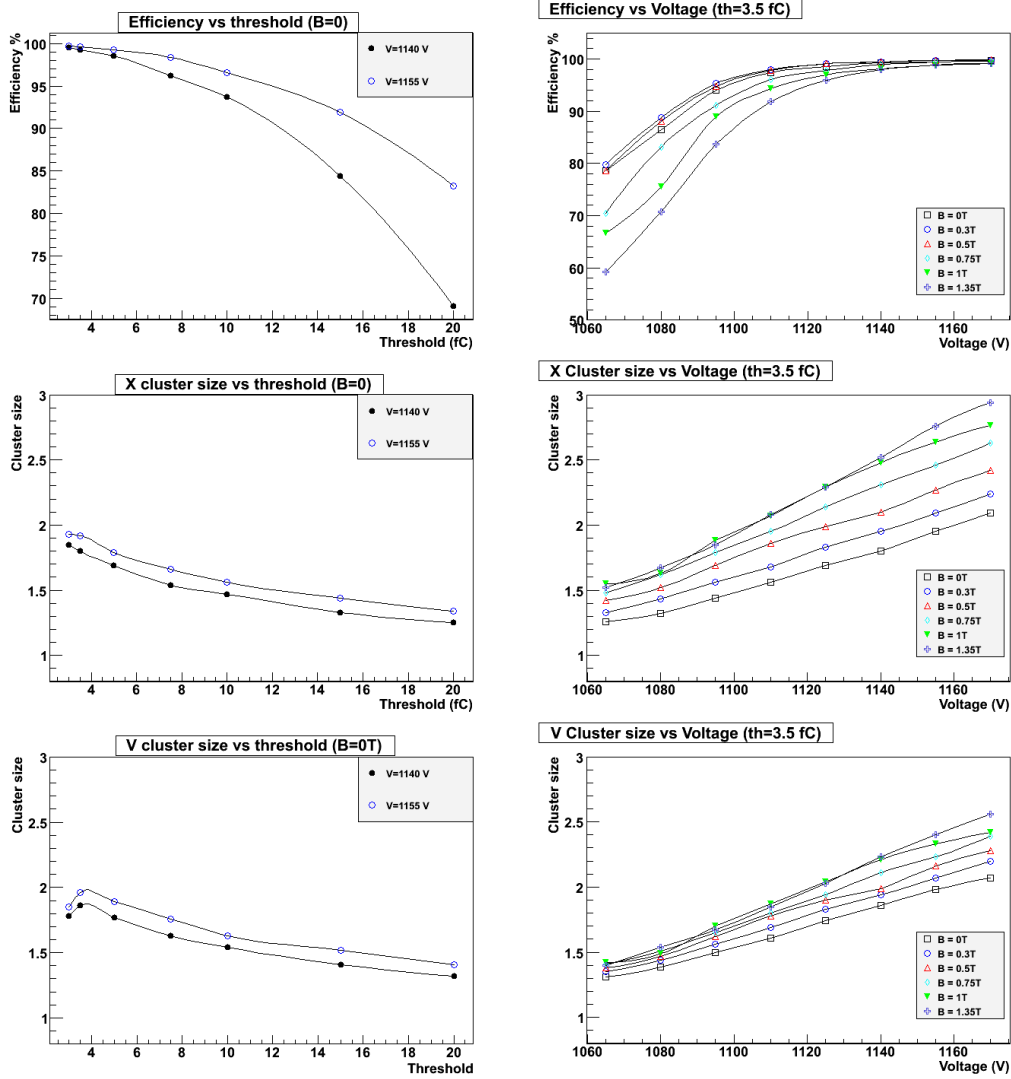

Figure 36: (**Left**) Threshold scan: efficiency (Top) X cluster size (Middle) V cluster size (Bottom); (**Right**) Voltage and magnetic field scan: efficiency (Top) X cluster size (Middle) V cluster size (Bottom).

### 4.3 Large area GEM

The GEM technology was born at CERN and CERN is still the main producer of GEM foils. Presently the size of the foils manufactured at the CERN EST-DEM workshop [19] is limited to  $450 \times 450$  mm<sup>2</sup>. Such a limitation arises from two different reasons:

1. the raw material presently used for GEM foils is the Novaclad G2300 from Sheldahl, a polyimide (kapton) foil with an adhesiveless copper

cladding on both sides. This material is normally provided in 457 mm wide rolls. Considering the space needed for the handling of a foil, 450 mm is a limit for one dimension. Rolls as large as 514 mm are available from the same company, but are non-standard and should be ordered in bulk. Anyhow this option could be considered when large production of detectors is foreseen.

2. the manufacturing of GEM foils is based on the photolithographic process commonly employed in the printed circuit industry: the hole pattern is transferred by UV-exposure from transparent masks to photoresistive layers deposited on both sides of the raw material. The foil is then etched in an acid bath, which removes copper from the holes left in the photoresist. Since the hole has a diameter of  $70\ \mu\text{m}$ , the two masks have to be aligned with a precision of few  $\mu\text{m}$ , not a trivial goal to meet as the area increases. With the present plastic masks, 450 mm is considered a limit to preserve the homogeneity and the quality of the hole geometry.

#### 4.3.1 Single-mask procedure

In order to overcome the size limitation due to the troublesome alignment of the two masks, and thus fulfilling the demand of large area foils from a consistent part of the GEM community, a single-mask procedure has been developed by the CERN EST-DEM workshop together with the Gas Detector Development (GDD) group of CERN [26]. It is schematically highlighted in fig. 37.

- a) the raw material is a polyimide foil (kapton)  $50\ \mu\text{m}$  thick, with a double-sided  $5\ \mu\text{m}$  copper cladding;
- b) a photoresist layer is laminated on both surfaces; a lithographic mask with the pattern of the holes is placed on the top face of the foil and exposed to UV light;
- c) the top metal is etched while the bottom metal is protected where the photoresist layer is still present;
- d) the polyimide is etched all through from top;
- e) using the polyimide as a mask, the hole is opened by etching the bottom metal; the top metal is actively preserved from etching as it is biased

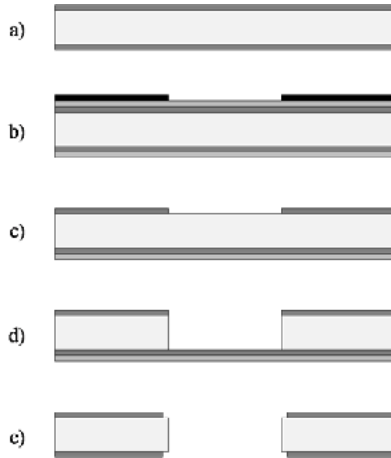

Figure 37: Schematic procedure for fabrication of a single-mask GEM. See the text for detailed description.

to a more negative voltage with respect to the chemical bath, working as the cathode of the electrochemical cell and thus being protected <sup>2</sup>.

At the end of this process the shape of the hole is still slightly conical with a top diameter of  $70 \mu\text{m}$  and a bottom diameter of  $60 \mu\text{m}$ . This has to be compared with the usual double-conical shaped hole obtained with the double-mask procedure, with diameters of  $70\text{-}50\text{-}70 \mu\text{m}$ , respectively for top, middle and bottom parts of the hole.

#### 4.3.2 Measurements

To characterize the new foils, two identical  $10 \times 10 \text{ cm}^2$  Single-GEM chambers have been assembled: one with single-mask foil and one with the standard foil, used as a reference. The two detectors have been put on the same gas line and flushed with  $\text{Ar} : \text{CO}_2 = 70 : 30$ . They have been simultaneously irradiated with a  $6 \text{ keV}$  X-rays gun and tested in current mode.

At first the single-mask foil has been mounted in a bottom-open configuration, i.e. with the larger section of the holes facing the anode. Then the foil has been turned, in a top-open configuration, i.e. with the larger section of the holes facing the cathode. In the following these two configurations will be referred to as 60-70 and 70-60, respectively.

Fig. 38-left shows the electron transparency as a function of the drift field. The single-mask foil exhibits a different behavior depending on the

<sup>2</sup>This technique, called “Cathodic protection”, is commonly used for example to protect oil pipes from corrosion

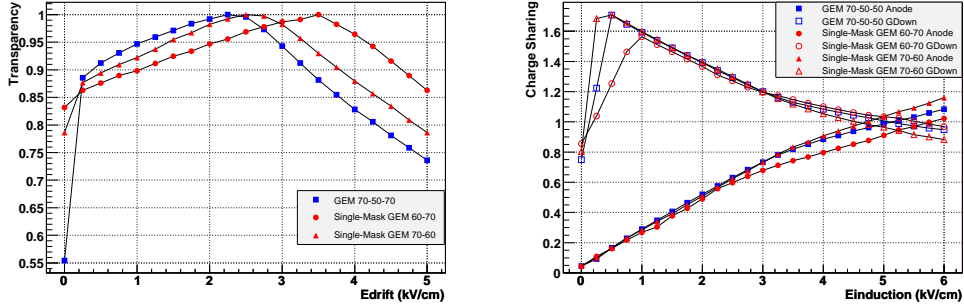

Figure 38: Left: Electron transparency as a function of the Drift field. Right: Charge sharing between bottom surface of the GEM and anode as a function of the Induction field. The equal sharing values are 4.6 kV/cm, 5.2 kV/cm and 5.7 kV/cm respectively for 70-60, 70-50-70 and 60-70 hole configurations.

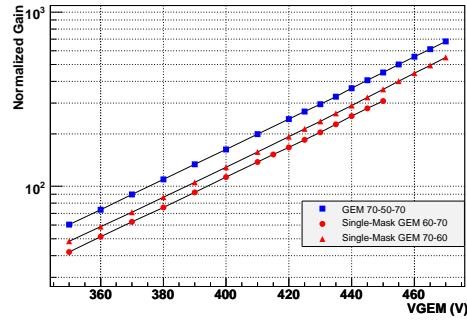

Figure 39: Gas gain in  $\text{Ar} : \text{CO}_2 = 70 : 30$ .

orientation: in the 60-70 configuration the full focusing efficiency is reached for a higher value of the field with respect to the other two configurations.

In fig. 38-right the charge sharing between the bottom surface of the GEM and the anode is plot as a function of the induction field. It is common practice to choose the equal sharing point as a reasonable operating value for the induction field. The equal sharing values are 4.6 kV/cm, 5.2 kV/cm and 5.7 kV/cm respectively for 70-60, 70-50-70 and 60-70 hole configurations. A clear dependency of this parameter from the GEM orientation can be seen.

In fig. 39 the gas gain of the GEM is shown as a function of the voltage drop between the two faces of the foil. The gain of the new GEM is 20÷30% smaller with respect to the standard one, meaning that additional 10÷20 V must be applied in order to operate the new chamber at the same gain of the 70-50-70 configuration.



### 4.3.3 Large planar prototype

The CGEM prototype was limited in size since the single-mask technology for the manufacturing of the large foils was not yet available at that time. Now that the procedure has been finally established, we are building a large area planar detector ( $300 \times 700 \text{ mm}^2$ ) to test the gain uniformity of a single-mask GEM over the same surface needed for the construction of the Inner Tracker (fig. 40). For this purpose, a dedicated special tensioning tool has been realized (fig. 41). ANSYS simulations indicate that even on such a large area, with a tension of  $1 \text{ kg/cm}$  the maximum sag due to combined gravitational and electrostatic effects is only  $20 \text{ }\mu\text{m}$ .

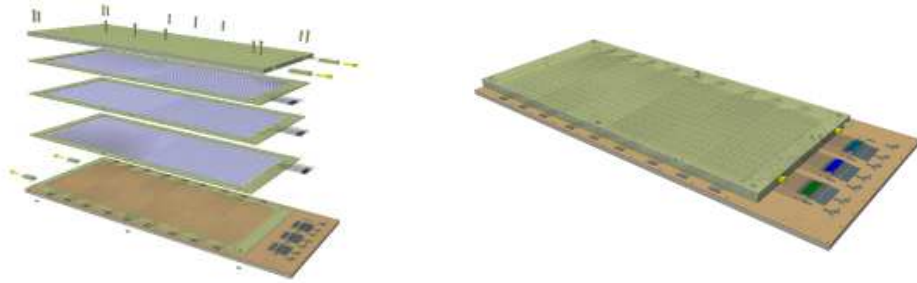

Figure 40: The project for the large area planar GEM prototype.



Figure 41: Tensioning tool for large area GEM foils.

## 5 Mechanics and construction

The Inner Tracker will be composed by five concentric layers of CGEM detectors (fig. 42), as described in section 3.1. The technology used to build the cylindrical electrodes does not require the presence of internal frames as a support and therefore allows us to realize an intrinsically dead-zone-free detector. Actually, since the shape of the detector is cylindrical, the typical sag of the electrodes is negligible:  $< 5 \mu\text{m}$  for an overall stretching mechanical tension of  $\sim 50 \text{ kg}$  applied at the ends of the detector.

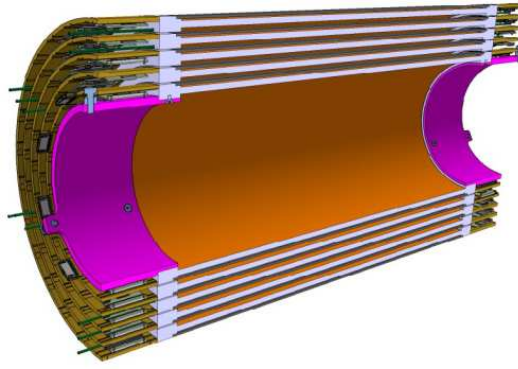

Figure 42: (Left) Inner Tracker Global view

The detector construction will be entirely carried out in a class 1000 clean room: it is a clean procedure and protective clothings will be always worn. The clean room will include:

- the storage areas for GEM and readout circuit foils and apart those dedicated to the storage of the fiber-glass components;
- the GEM testing areas, for optical inspection and HV test;
- the cleaning area for fiber-glass components;
- the planar and cylindrical gluing stations;
- the detector assembly area;
- the area for the final detector test: gas leak and HV test.

The closed detector will be then moved to the laboratory where it will be tested first with X-rays, in current mode, and then with cosmics, after the installation of the front-end electronics.

## 5.1 Detector components

The design of the detector components and construction toolings as well as the choice of the materials originates both from the experience of the construction of the GEM detectors [27] of the LHCb Muon apparatus, and, more specifically, for the construction of the full scale prototype of the CGEM [28, 29].

In particular, the materials used for the CGEM were largely tested and validated for high-rate environments [30] and for different gas mixtures (Ar,  $i\text{-C}_4\text{H}_{10}$ ,  $\text{CF}_4$ ,  $\text{CO}_2$ ) [31]. Such validations were performed with global large area irradiation tests, with 1.25 MeV  $\gamma$  from a 25 kCi  $^{60}\text{Co}$  source at the ENEA Casaccia, and with discharge tests performed at PSI with high intensity low momentum  $\pi$ -p particles fluxes on reduced beam spot area ( $\sim 15\text{ cm}^2$ ). The general design and the construction procedure for each CGEM of the IT is substantially the same used for the realization of the full scale prototype. In fig. 43 is reported the global cross-section of the IT. As shown in fig. 44 left the CGEM has the typical triple-structure of such a kind of micro-pattern gas detector. The gaps among the different electrodes of the detector (cathode-G1, G1-G2, G2-G3 and G3-anode) define the various regions of the detector itself: drift (3 mm wide), transfers (both 2 mm wide) and induction (1-2mm). The gas, supplied in open mode through the six gas inlets realized on the Permaglass annular frame of the cathode, flows through the holes of the three GEM and then exits from the detector by the six outlets of the anode frame fig. 44 right. Frames are realized in Permaglass, a not stratified homogeneous composite material realized by the Resarm ltd (Belgium), that allows very precise and almost fibers- and spikes-free machining: a crucial feature against spurious discharges. The frames, glued at the edge of the cylindrical electrodes outside their active area, define the various gaps of the detector. As successfully demonstrated by the full scale prototype, no support frames inside the active area of the detector are required for a safe operation of the CGEM.

The most relevant modification with respect to the prototype design is represented by the *embedded-anode*, consisting of a very light honeycombed carbon fiber cylinder (CFC) on which the anode readout circuit is glued. The CFC acts as a rigid support for the whole detector layer.

A complete mechanical model of one of the IT layers has been realized and includes: a prototype of the CFC with  $\sim 300$  mm radius and 360 mm length; the annular flange (Service Flange-SF) foreseen as a support for the FEE cards, HV connectors and gas piping. The CFC has been realized at the RIBA srl (fig. 45 top-left). The SF prototype (fig. 45 top-right) made by the Nuova Saltini srl company, is described in sec.6.4.1. The simulation studies

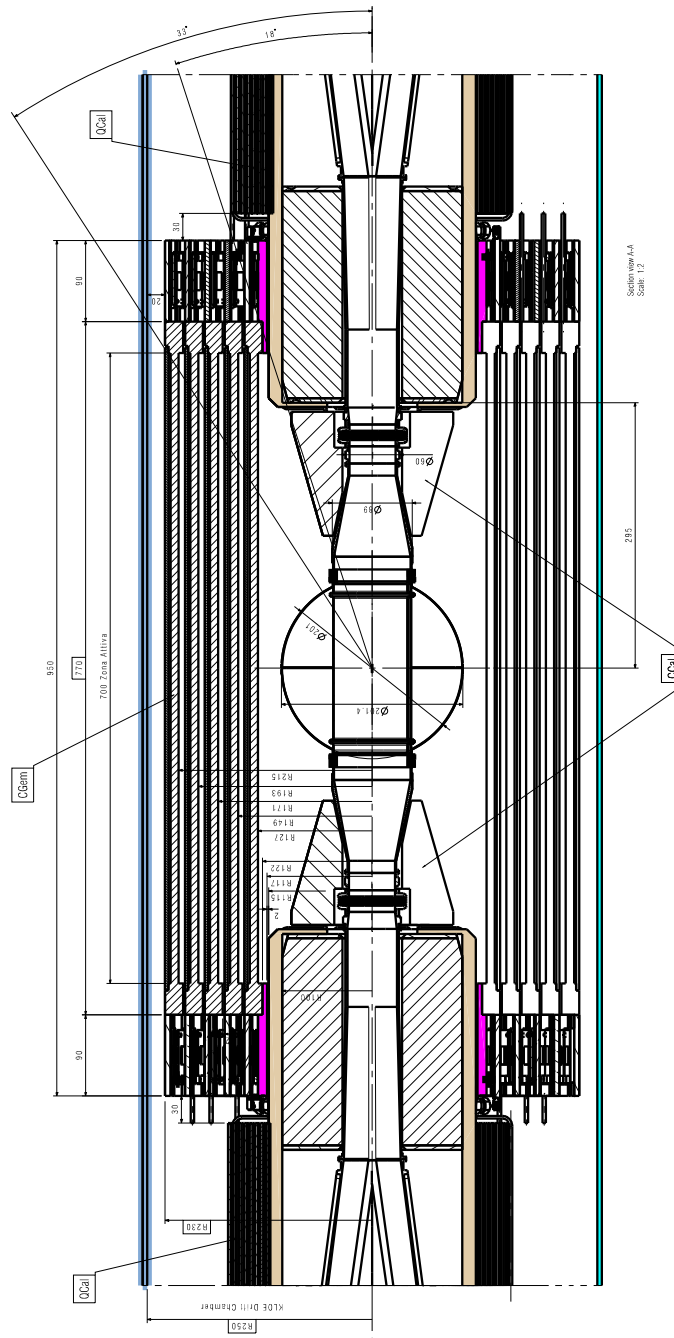

Figure 43: Inner Tracker Global cross section.

of the CFC deformation indicate that for an axial load of 600 kg applied to the CFC the maximum radial displacement is about  $70\mu\text{m}$  for the prototype

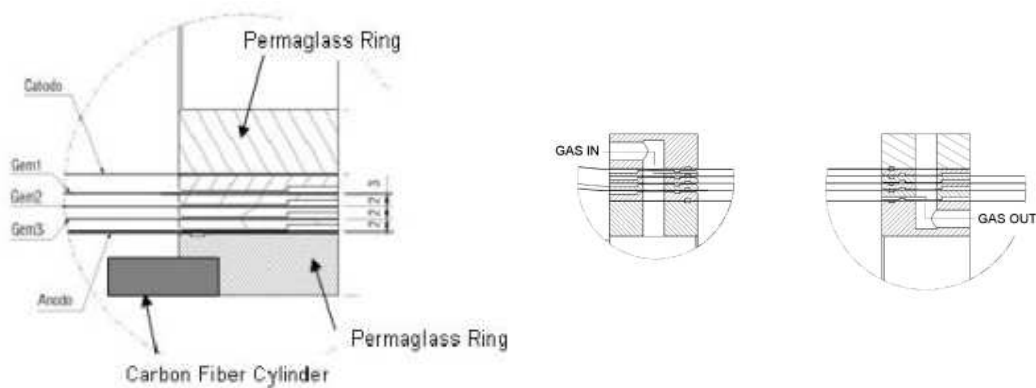

Figure 44: (Left) Detail of the CGEM structure. (Right) Detail of the gas inlets.

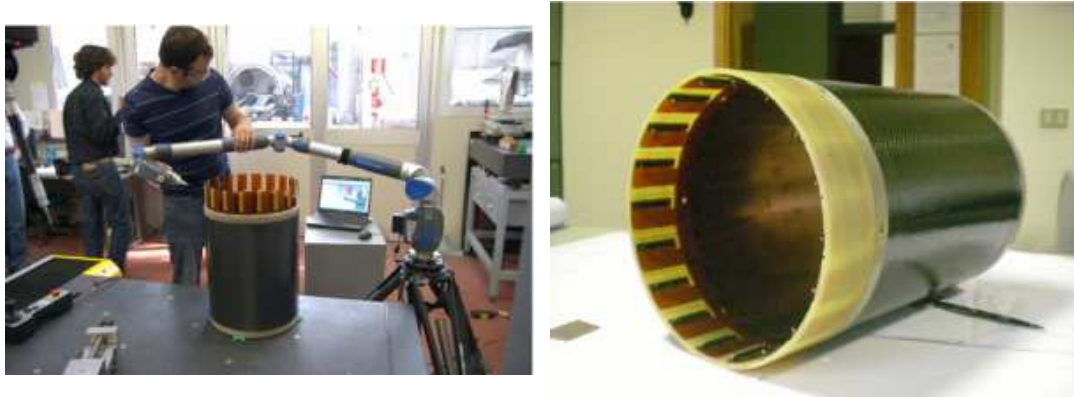

Figure 45: (Left) Carbon fiber cylinder prototype with the "embedded-anode". (Right) The annular frame for FEE support coupled with the carbon fiber cylinder.

dimension and  $150 \mu\text{m}$  for a CGEM with the dimension of the first layer (up to 700 mm length). The applied load is well above the 100 kg overall load required for good detector stiffness and negligible sag ( $<5\mu\text{m}$ ) [32].

The buckling of the CFC is expected for an axial load of about 9 tons. The load tests have shown that the break-down of the CFC prototype occurs at about 8 tons, well above the expected load on the final IT structure.

The 700 mm long GEMs will be realized with the new single mask procedure, extensively discussed in sec.4.3, that allows large area foils to be build. In order to overcome the limit on the width of the raw material used for the GEM foils (453 mm maximum size), all the large electrodes of each layers of the IT will be realized by splicing three smaller foils: the gluing technique is the same used for the construction of the prototype (planar gluing), exploit-

ing the vacuum bag technique for epoxy glue polymerization (sec.4.1.1). The epoxy used for the foils splicing is the two components Araldite AY103 + Hardener HD991, with a curing and polymerization time, at ambient temperature, of about 1 hour and 12 hours respectively. The epoxy, largely tested in harsh radiation environment, is the same used for the assembly of the LHCb GEM chambers. The GEM foils as well as the XV strip-pad patterned anode readout circuits and the cathode foils will be realized on the typical  $50\mu\text{m}$  polyimide foils as substrates, on the basis of our design, by the CERN EST-DEM Printed Circuit Board Workshop.

In table 1 we summarize the materials used for the construction of the detector.

Table 2 shows the material budget of a CGEM layer inside the active area.

Table 1: Materials used for the assembly of a CGEM

<b>Material</b>	<b>Details</b>	<b>Supplier/ Manufacturer</b>
Epoxy glue (2 comp.)	Araldite AY103 + HD991 Ciba 2012 (for fast applications)	Ciba Geigy Ciba Geigy
Annular frames	3/2/1mm thick Permaglass	Resarm ltd (Be)
CFC support	CF( $250\mu\text{m}$ )-Nomex(3mm)-CF( $250\mu\text{m}$ )	Riba srl (It)
SF support	8mm thick Permaglass annular-flange for FEE/HV/gas-piping location	Nuova Saltini (It)
GEM foils	$50\mu\text{m}$ thick kapton, 3- $5\mu\text{m}$ Cu; $70\mu\text{m}$ hole dia., $140\mu\text{m}$ hole pitch	EST-DEM CERN Workshop
Cathode	3- $5\mu\text{m}$ Cu on a $50\mu\text{m}$ thick kapton	EST-DEM CERN
Anode readout	3- $5\mu\text{m}$ Cu on a $100\mu\text{m}$ thick kapton with XV strips-pad patterned	EST-DEM CERN
Gas pipes	4 mm out.-dia. brass tube	LNF-workshop
Gas outlet	6 mm out.-dia. rilsan Pa11 tube (not hygroscopic)	Tesfluid srl (Italy)

## 5.2 Construction and tooling

The construction strategy and the toolings of the CGEM layers composing the IT are the same used for the prototype.

The main construction steps can be summarized as follows:

1. three GEM, as well as the anode and cathode, foils are preliminary glued together in order to obtain a single large foil needed to realize

Table 2: Material budget for a CGEM layer detector (active area)

Component	times x material ( $X_0$ ) x quantity	% of $X_0$
3 GEMs	Copper: $6 \times 2\mu\text{m Cu } (X_0=14.3\text{mm}) \times 0.8$	0.067
	Kapton: $3 \times 50\mu\text{m kapton } (X_0=286\text{mm}) \times 0.8$	0.042
		Total: 0.109
1 Cathode	Copper: $1 \times 2\mu\text{m Cu } \times 1$	0.013
	Kapton: $1 \times 50\mu\text{m kapton} \times 1$	0.017
		Total: 0.030
1 Readout anode	Copper: $1 \times 2\mu\text{m Cu } \times 0.95$	0.013
	Kapton: $2 \times 50\mu\text{m kapton} \times 1$	0.034
		Total: 0.047
1 Shielding	Aluminum: $1 \times 10\mu\text{m Al}(X_0=89\text{mm}) \times 1$	Total: 0.011
1 Honeycomb	NOMEX: $1 \times 3\text{mm Nomex}(X_0=13125\text{mm}) \times 1$	Total: 0.023
2 CF skins	CF: $2 \times 250\mu\text{ CF}(X_0=250\text{mm}) \times 1$	Total: 0.160
		Total: 0.380

a cylindrical electrode. For this operation we exploit a precise Alcoa plane and the vacuum bag technique.

2. the large foil is then rolled on a very precise aluminum cylindrical mould covered with a 0.4 mm machined Teflon film for easy and safe extraction of the cylindrical electrode. The mould is then enveloped with the usual vacuum bag, and vacuum is applied for the glue curing time (about 12 hours). In fig. 46 left the technical drawing of one of the 25 cylindrical moulds needed for the IT construction is shown.
3. the final assembling of a CGEM layer is performed by means of the Vertical Insertion System (VIS) fig. 46 right, a tool that allows a smooth and safe insertion of the cylindrical electrodes one after the other. The system is designed to permit a very precise alignment of the cylindrical electrodes along their vertical axis. The bottom electrode is fixed, while the top one is slowly moved downwards by a manually controlled step-motor, coupled with a reduction gear system. The operation is performed with the help of three small web-cameras, placed at 120 degrees one to each other around the top cylindrical electrode, thus allowing the monitoring of the radial distance between the electrodes (2-3mm typically). The up-down rotation of the assembly tool allows an easy sealing of the detector on both sides.

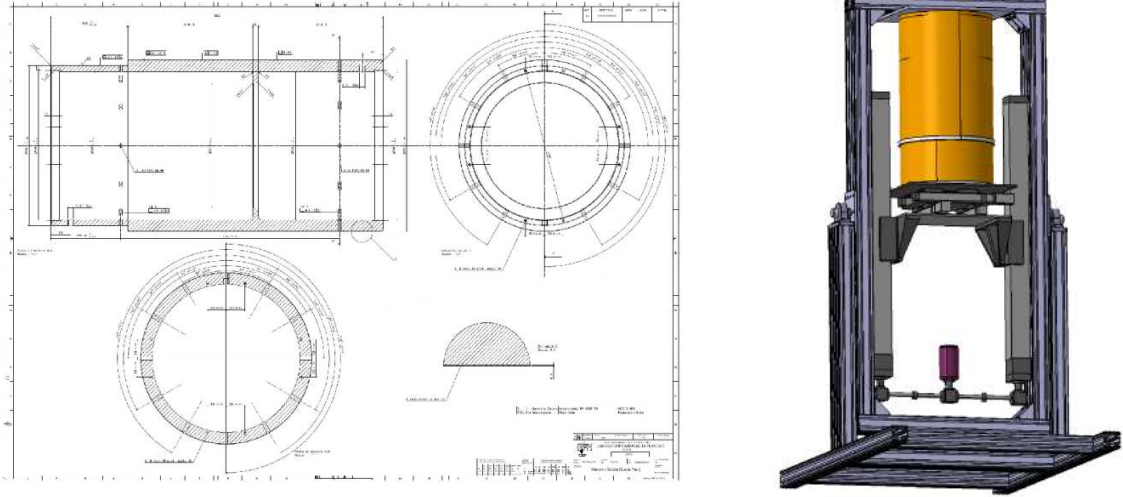

Figure 46: (Left) Technical drawing of the cylindrical mould. (Right) Isometric view of the Vertical Insertion System.

### 5.3 Material preparation & Quality Controls

Before the final assembly of the different parts of the detector, each component follows a well defined preparation procedure that generally includes a global optical inspection, a cleaning and an HV test. In particular for GEMs the HV test is repeated at each construction step, in order to avoid the assembly of damaged GEM and to minimize the losses of precious components.

#### 5.3.1 GEMs

GEMs are produced by the EST-DEM Workshop at CERN. A GEM foil realized for the construction of the full scale prototype is shown in fig. 47: clearly visible is the sectors structure realized on one side of the foil with the aim of reducing the energy stored and then released in case of discharge through the GEM hole. The sectors in this case were 1.6-1.8 cm wide and about 36 cm long, resulting in a sector area of about  $60\text{-}65\text{ cm}^2$ , to be compared with those of LHCb and Compass experiments respectively  $80$  and  $90\text{ cm}^2$  large. A first quality check is done at CERN by the producer: besides a global optical survey each sector is supplied with a voltage up to 500 V and checked for leak current that should be less than 5 nA. This test is performed in clean room at ambient temperature and relative humidity, that is without putting the GEM foil into a nitrogen flushed gas box.



GEMs are delivered inside a rigid clean plastic plates, each foil protected between clean soft papers. They are identified with a ID-number: "Z-type-XX", "Z" for the production batch, the "type" identify the GEM (G1,G2 or G3) and "XX" indicates the progressive number inside the batch. In our

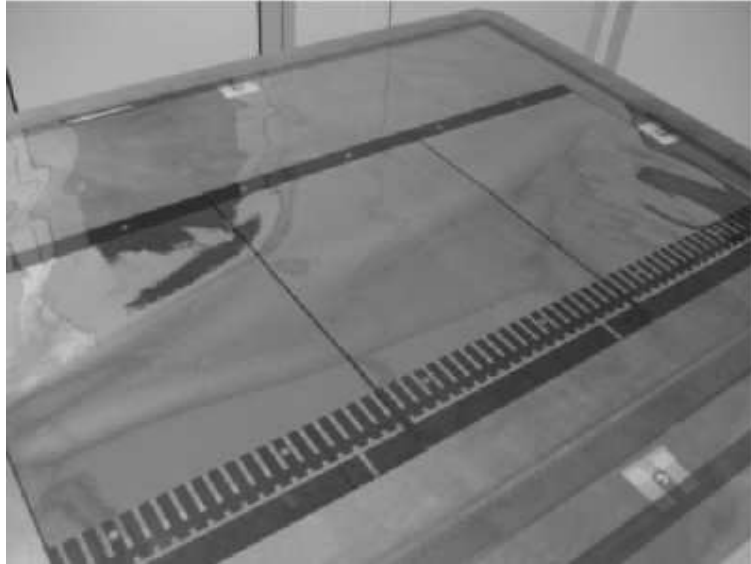

Figure 47: Detail of a large GEM foil.

laboratory they are stored in a dedicated cabinet inside the clean room and always handled by operators suitable worn with clean clothings, facial mask, gloves and hat.

GEMs do not require any special cleaning procedure, because in principle they are clean: the only allowed cleaning procedure is done with a light nitrogen flush that is generally used to gently remove possible dusts. Any other procedure can instead damage the GEM and then is strongly forbidden.

A first optical inspection is done by eye to look for areas with possible defects, typically spots with unavoidable inhomogeneity in the material as local absence of the metal and underlying kapton or lack of holes. A more careful optical inspection of these spots is then performed under microscope, equipped with a digital camera in order to evaluate the dimension and type of the defect. Such defects have generally no consequences in the operating behavior of the GEM. For GEMs of the LHCb detector not more than 1 defect with an area less than  $1mm^2$  per each GEM sector were accepted.

The HV test of a GEM is performed inside a gas tight box flushed with Nitrogen, in order to reduce the humidity down to 10% Residual Humidity (time needed about 5 hours). The HV is applied individually to each sector through a 500 M $\Omega$  limiting resistor, in order to avoid GEM damages in case

of discharges, while the non-sectored side is grounded. The maximum current in the power supply is set to 100 nA. The HV is slowly increased with eighteen steps up to a maximum of 600 V:

- from 0 to 400 V with 50 V steps of 20 seconds each;
- from 400 V to 500 V with 25 V steps of 60 seconds each;
- from 500 V to 600 V with 10 V steps of 2 minutes each.

The GEM sector pass the HV step if the current is less than 1 nA and no more than 3 discharges occurred during the test time. In case these acceptance requirements are not fulfilled the voltage ramp-up on the sector is suspended and the test is repeated later on. For each sector the test has a duration of about 30 minutes. This figure, coming from our previous experience in LHCb, gives an estimate of about 600 hours needed to test (only with HV) the about 1200 sectors foreseen for the IT, that become about 850 hours including the time needed for nitrogen flushing (this must be done only about 50 times, once per GEM foil), corresponding to about 5.5 man-months.

### 5.3.2 Readout anode circuit

The readout anode circuit is manufactured by EST-DEM CERN Workshop, on the basis of our design, starting from the  $5\mu\text{m}$  copper clad,  $50\mu\text{m}$  thick polyimide substrate, the same used for GEM foils. The  $650\mu\text{m}$  pitch,  $300\mu\text{m}$  wide X strips are parallel to CGEM axis, giving the  $r\phi$  coordinates; while the V strips, realized connecting by vias a suitable pattern of parallelogram shaped pads, and forming an angle of about 40 degrees with respect the X-strips, gives the z coordinate.

A first check to look for shorts between both coordinates is performed by the producer. Connections test between pads and vias is also required.

A useful test for anode readout validation consists of measuring the distance between first and last strip at different positions for both coordinates, requiring a maximum deviation from the nominal not exceeding  $100\mu\text{m}$ .

The readout anode circuits, as GEM foils, do not require any special cleaning procedure: the only allowed cleaning procedure is done with a light nitrogen flush to remove possible dusts. Any other procedure can instead damage the circuit and then is strongly forbidden. They are stored in a dedicated cabinet in the clean room and always handled by operators suitable worn with clean clothings, facial mask, gloves and hat.

### 5.3.3 Annular frames

The annular frames, defining the gaps between electrodes, are 3 or 2mm (1mm) thick and 35 mm wide. They are made of Permaglass and they are the only supports for the cylindrical electrodes. The cathode and anode frames contain the gas inlets and outlets respectively.

The frames delivered by the machine workshop before enter the clean room are preliminary washed with isopropilic-alcohol and brush. A carefully optical inspection to find and eliminate spikes and possible broken fibers, is performed before and after the final cleaning done in a ultra-sonic bath with demineralized water for 30 minutes. After the cleaning the permaglass components are dried in a oven at 40 °C for 1 hours.

An HV test to verify its insulating is done placing the frame in between two copper foils put at 4 kV within a clean box flushed with nitrogen. If sparks occur, the frame is flushed for a couple of hours and then tested again. If sparks still occur frames is inspected with a microscope. Generally if the frame is perfectly clean neither sparks nor dark current is observed.

### 5.3.4 Final tests on closed chamber

Once the chamber is closed we proceed with gas leakage test. The gas tightness is checked with a differential pressure device, a system that allows us to measure the gas leak as the fall of pressure as function of time. The chamber to be tested and a reference volume (same volume of the chamber with no leak, e.g.  $\ll$  1 mbar/day), flushed in parallel with an overpressure of few mbars (typically 5 mbars), are connected to the two sensors of the device. The reference volume allows us to take into account for atmospheric and temperature variations during the measurement that can lasts about 1 hour. The difference between the two pressure measurements gives the gas leak rate of the chamber. All LHCb chambers [33] exhibit a gas leak of the order of less than 2 mbar/day, corresponding to not more than 100 ppmV of residual humidity with a gas flux of 80 cc/min.

The same system is also used to search for large gas leaks. In this case the chamber connected to the sensor is inspected with a gas flow all around the gluing regions: the possible sources of leak are easily detected as a sudden increase of pressure, since the chamber is flushed through the hole itself. The holes are then sealed applying locally the same glue used for the assembly of the chamber. After glue polymerization the gas leak test is repeated and the chamber is validated.

The chamber is then taken out from the clean room and moved to the labo-

ratory where it is flushed with the Ar/CO<sub>2</sub> (70/30) gas mixture and tested in current mode with X-rays in order to check the gain uniformity. Gain variations of the order of 5-6% [33] are measured all over the active surface of the detector.

## 5.4 Detector integration

The study of the IT integration around the DAFNE interaction point (IP) must take into account the interferences between the IT and the internal tube of the Drift Chamber and with the CCal and QCal calorimeters that are placed around the beam pipe [9].

As shown in fig. 48, a radial distance of 20mm between the fifth layer of the IT and the internal surface of the DC is foreseen in order to facilitate the critical insertion inside the DC of the integrated system constituted by the beam pipe and detectors complex.

The interference with CCal mainly concerns the routing of the calorimeter cables that in the current design are foreseen to be embedded in the aluminum support tubes of the interaction region (IR) fig. 49 left.

The isometric view reported in fig. 49 right shows the other critical region between the IT ends and the two QCal's surrounding the quadrupoles, where gas piping, HV and signal cables of the IT (especially for the first layer) must be routed out.

A very preliminary study of the integration sequence of the IT with the beam pipe, CCal and QCal detectors is schematically shown in fig. 50.

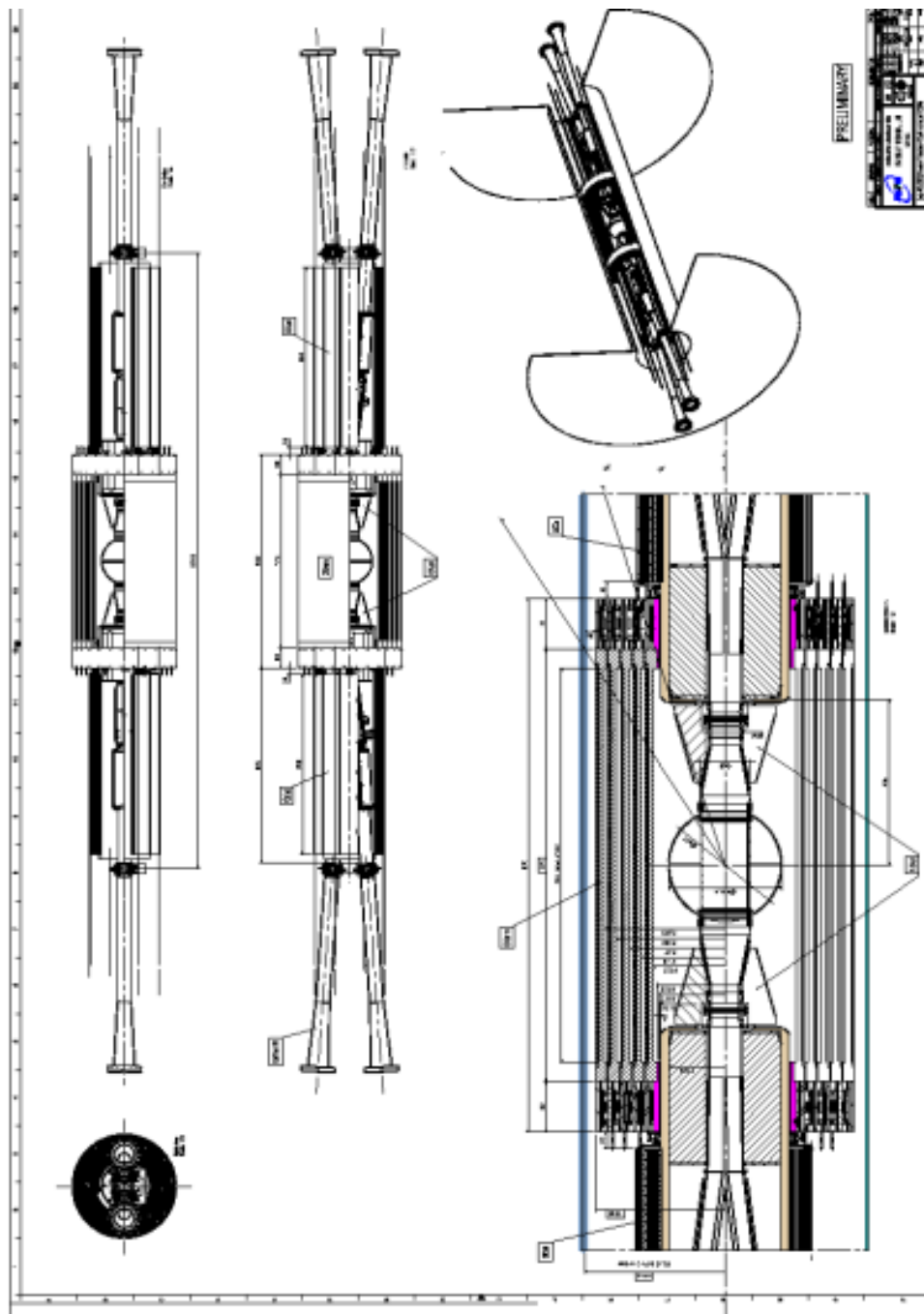

Figure 48: Technical drawings of the integration of the detectors at the interaction point.

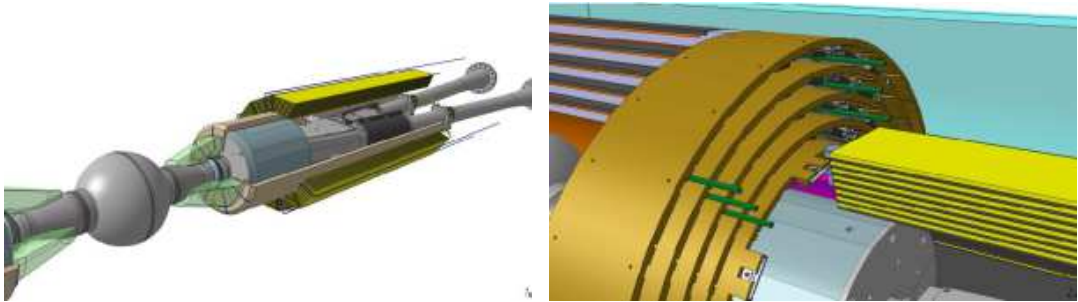

Figure 49: Isometric views of detectors integration (Left) IT and CCal integration (Right) IT and QCal integration.

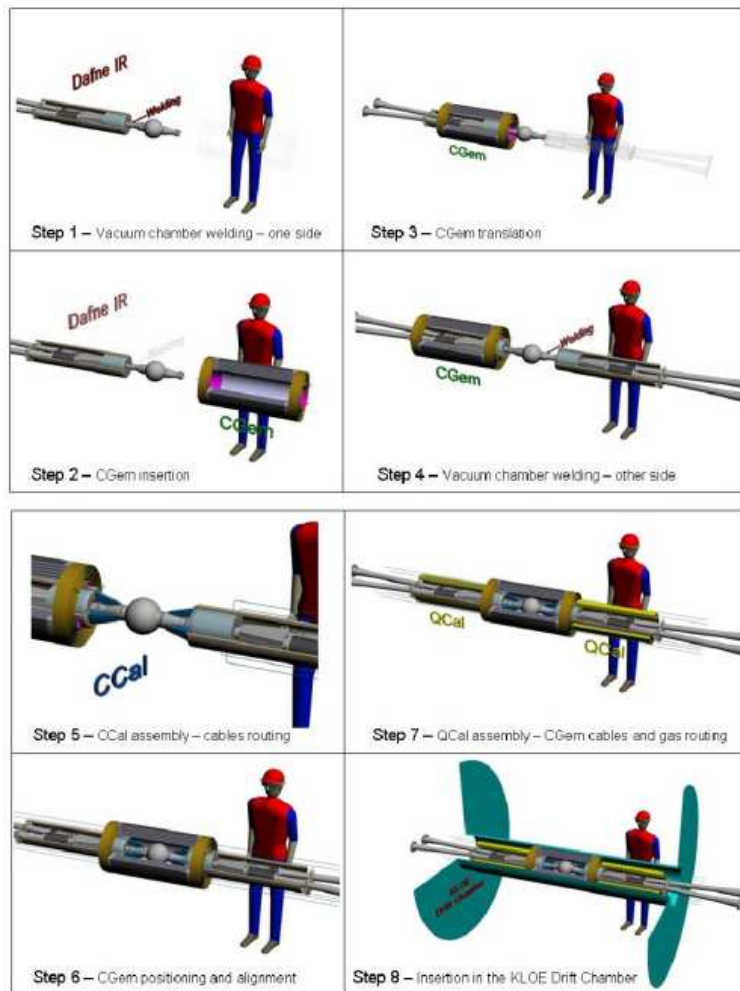

Figure 50: Preliminary studies of the detector integration sequence.

## 6 Electronics

### 6.1 On-Detector Electronics

The IT will be readout by means of about 30000 XV strips.

Due to the different length of the V strips the parasitic capacitance will range between about 1 and 50 pF according to the position, making impossible the S/N optimization by capacitive matching. Moreover, because of the GEM moderate gas gain (e.g. with respect to Wire Chambers), the front-end electronics must be installed on the detector itself to maximize S/N ratio. Therefore both power consumption and I/O connections must be kept as low as possible.

A further constraint concerns the KLOE DAQ timing: since the Level 1 trigger is delayed of about 200 ns with respect to the Bunch Crossing (BX), the IT discriminated signals must be properly stretched to be acquired.

To fulfill the mentioned requirements a novel 16-channels front-end ASIC prototype, named GASTONE (*Gem Amplifier Shaper Tracking ON Events*), has been developed. The sixteen channels ASICs have been used to readout the Cylindrical-GEM prototype in a test beam at CERN (sec 4.1.3).

As the chip prototype fulfilled the IT readout requirements, a second release, including a robust protection circuit to prevent damages caused by discharge effects in the detector [20], has been implemented. This feature simplify significantly the layout of the front-end electronic boards, avoiding the use of the classical, space-consuming, external protection network made of resistors, diode and capacitors. The new chips have been used to instrument the Planar GEM detectors for the readout studies in a magnetic field performed in the testbeam at CERN (sec. 4.2.2).

Finally a 64 channels prototype (fig. 51) has been designed and will be used to instrument the 350x700 mm<sup>2</sup> large planar GEM detector (produced with the new single-mask technology) as final test of the GASTONE design before mass production (about 700 chips).

#### 6.1.1 The GASTONE ASIC

The final version of the GASTONE chip is a mixed analog-digital circuit, consisting of 64 analog channels followed by a digital section implementing

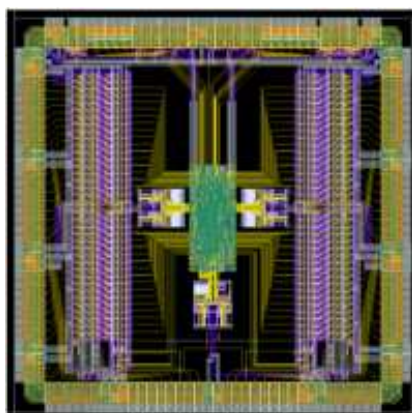

Figure 51: GASTONE 64 channels layout

the slow control and readout interface, as shown in fig. 52.

The main features of GASTONE are the low input equivalent noise (ENC)

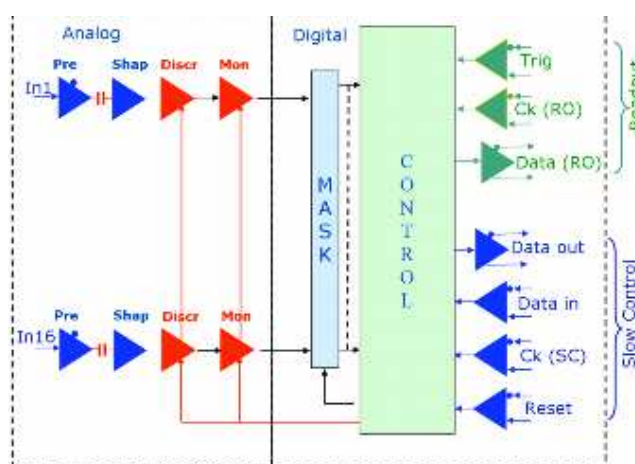

Figure 52: Gastone Block Diagram

in the detector capacitance range, the high modularity (to reduce the I/O lines) and the low power consumption. The modularity has been set to 64 channels, as a compromise between the reduced number of I/O lines and the overall system reliability (damaged devices can not be replaced as the detector will be not accessible without extracting the beam-pipe).

The amplified and shaped signals are digitized and serially readout using both edges of a 50 MHz clock, achieving a 100 Mbps transfer rate. To avoid interference between digital and analog sections, separate analog and digital



power supplies have been used and I/O signals have been implemented in the LVDS standard. The readout clock will be active only in the download period (i.e. after the arrival of the Level1 trigger).

Since the expected integrated radiation dose is quite low, the ASIC has been designed in the mature and relatively cheap AMS 0.35 CMOS technology.

**Analog section** Each channel is made of four blocks: a charge sensitive preamplifier, an amplifier-shaper, a threshold discriminator and a monostable. The charge sensitive preamplifier converts the input current signal into a voltage while the amplifier-shaper provides further amplification and noise reduction. The discriminator generates the digital hit information which is then stretched by the monostable so allowing the output signal to be sampled by the Level1 signal. The total power consumption of the analog channel is 1 mW.

**Preamplifier features** Due to the relatively low charge amplification of GEM devices [34], the expected input charge will range from few fC to some tenths of fC. The implemented amplifier should therefore combine a high charge sensitivity with low noise level.

The input charge amplifier (fig. 53) consists of a common-source cascaded amplifier with an active feedback network made of a 150 fF capacitor and a PMOS transistor ( $W/L = 1.5/10$ ). The equivalent resistance is about 5 M $\Omega$  for a bias current of 300 nA. The main preamplifier characteristics are: gain of  $\sim 5$  mV/fC @  $C_{IN} = 0$  pF, non-linearity less than 1% (0÷30 fC) and supply current of about 350  $\mu$ A. The input impedance is  $\sim 120 \Omega$  over a  $10^5$  Hz frequency range as shown in fig. 54. Table 3 summarizes the main features of the GASTONE preamplifier.

Table 3: Charge preamplifier main specifications

Feedback capacitance	150 fF
Feedback resistance	5 M $\Omega$ @ $I_{feedb} = 300$ nA
Transconductance ( $g_m$ )	6.4 mA/V
Gain	5mV/fC @ $C_{in} = 0$ pF
$Z_{IN}$	120 $\Omega$ up to $10^5$ Hz
Non-linearity	$\leq 1$ % (0÷30 fC)
ENC (erms)	800 $e_{rms} + 40 e_{rms}/pF$
Supply Current	$\approx 350\mu A$

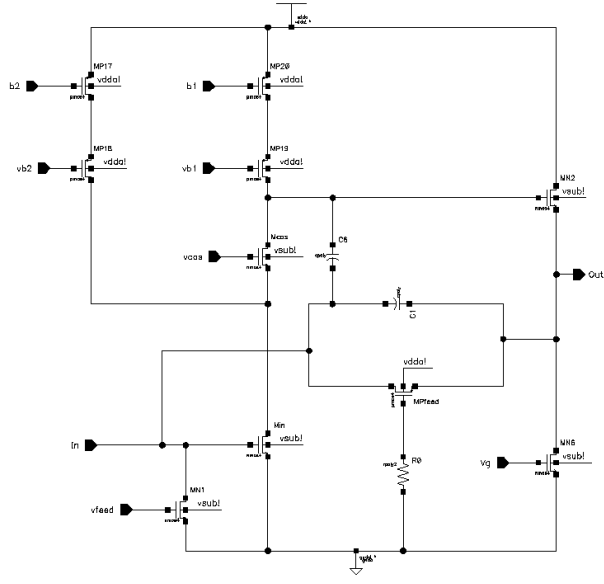

Figure 53: GASTONE preamplifier

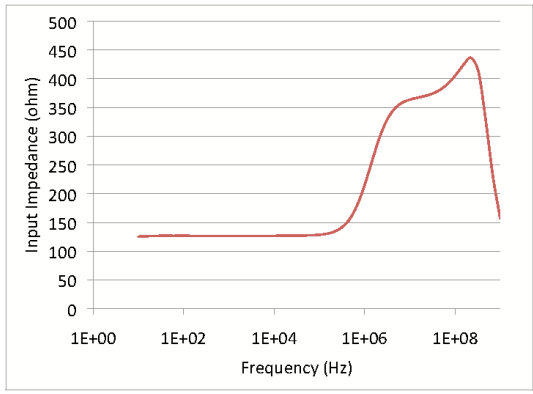

Figure 54: Preamplifier input impedance vs frequency ( $I_{feedback} = 300 \text{ nA}$ ,  $I_{DCPRE} = 350 \mu\text{A}$ )

**Shaper features** The shaper provides semi-gaussian shaping for noise filtering and is characterized by a voltage gain of 4. The non-linearity is less than 3% with a supply current of about  $200 \mu\text{A}$ . The measured peaking time is between 90 and 220 ns for a detector capacitance ranging between 1 and 50 pF. As shown in fig. 55(a), the overall preamplifier-shaper circuit has a

global charge sensitivity of about 23 mV/fC, while the behavior of the gain as a function of the input capacitance is shown fig. 55(b). The measured crosstalk is about 3%. Some snapshots of the shaper output for a fixed input

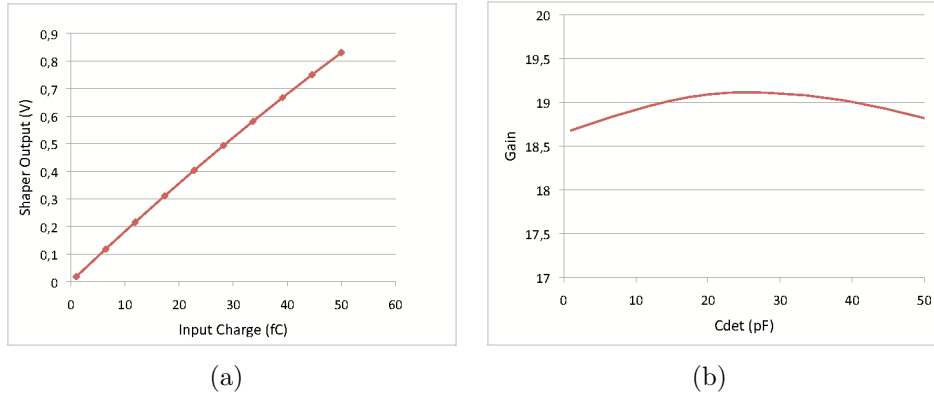

Figure 55: Shaper output vs input charge (a), Overall gain vs  $C_{in}$  (b)

charge of 10 fC and two preamplifier input capacitance (10 pF and 50 pF) are shown in fig. 56.

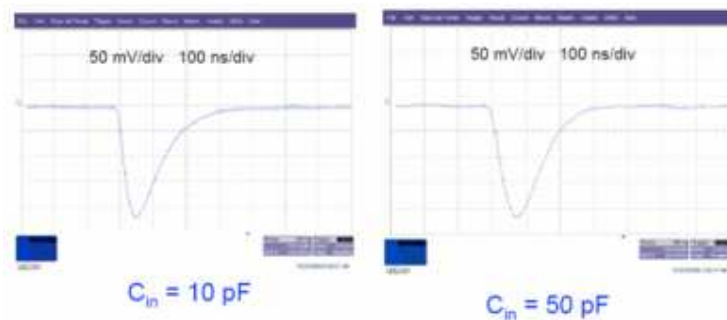

Figure 56: Snapshot of the shaper output

**Discriminator features** A leading-edge discriminator follows the shaper stage. The threshold ranges between 0 and  $\sim 200$  fC while the supply current is  $180 \mu\text{A}$ . It is AC-coupled to the shaper to be independent from DC level variations and is characterized by a threshold spread below 2% and an offset of  $\sim 2.2$  mV rms over the full threshold range.

**Monostable features** The discriminator is followed by a monostable circuit. It stretches the pulse duration to allow the proper signal sampling upon

the arrival of the Lev1 trigger.

The pulse width can be tuned between 200 ns and 1  $\mu$ s. The range could

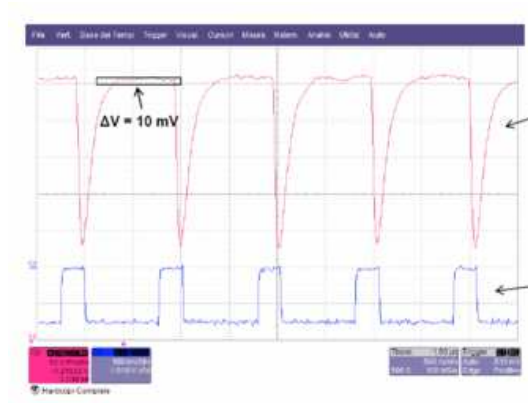

Figure 57: Discriminator input and monostable output with a 10 fC, 1 MHz input signal rate

be modified by choosing different external bias resistors.

The fig. 57, shows a snapshot of the monostable output. The maximum input rate is about 1 MHz, that is about 3 order of magnitude higher than the maximum expected rate. The fig. 57 also shows the effects on the discriminator input signal level for a 10 fC at 1 MHz input preamplifier signal. The shift, produced by the pile-up effect, is about 10 mV ( $\sim 0.5$  fC).

### 6.1.2 The Digital section

**Readout Interface** The digital section manages both the control logic for threshold sensing/setting and the discriminated signal serialization for data readout (fig. 58). The 50 MHz readout clock is active only after the arriving of Lev 1 trigger signal, then avoiding possible crosstalk with the analog section. In the 16 channels prototype the digital section has been already implemented to manage the 64 channels of the final chip.

Upon the arrival of the Lev 1 trigger signal, the discriminated signals are stored into a 96-bits register according to the event frame described in tab. 4. The arrival of 50 MHz readout clock starts the data transmission procedure that will last 960 ns (the readout circuit uses both edges of the clock signal).

The full digital section power consumption is about 40 mW and is dominated by the LVDS output drivers.

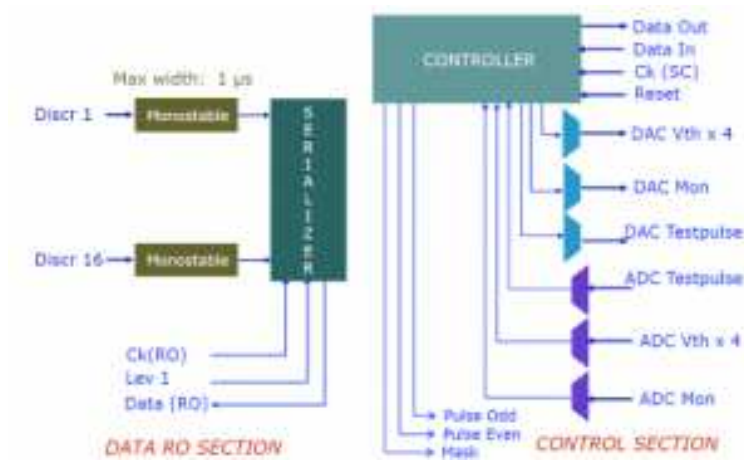

Figure 58: Digital section block diagram

Table 4: Gastone data transmission frame

Number of bits	Name	Description
8	Sync	10101010 synchronization receiver pattern
2	START	11 (consecutive data precursor bits)
5	TRIGGER_NUM	Trigger number
9	CHIP_ID	chip identification
64	CH_DATA	Transmitted data
8	ZERO	Ending transmission bits

**Slow Control-SPI interface** The Slow Control section of the chip is managed by a SPI interface with a clock running at 1 MHz. It consists of twenty-eight 8-bit registers (listed in tab 5) for configuring the chip functionality, setting the four DACs threshold and reading back the four ADCs (16 channels modularity). A fifth DAC/ADC is devoted to set/read the width of the monostable output pulse and, finally, a sixth DAC/ADC allows to set/read the amplitude of the internal test pulse. The threshold is set to ( $\sim 3 fC$ ) at power-on.

An internal pulsing procedure has been implemented to inject a selectable charge for calibration and test purpose. The chip also generate a global OR signal that can be used in self-triggering applications.

Table 5: List of SPI registers

# BITS	Content
8	Mask
4	Threshold(1 threshold for 16 channels)
1	Pulse amplitude (1 per 64 channels)
5	Read back from 5 ADCs
1	Test pulse configuration
8	Test pulse result
1	Control register

## 6.2 The 16 channels chip prototype

The 16 channels GASTONE prototype layout is shown in fig. 59. The chip occupies a silicon area of  $3.2 \times 2.2 \text{ mm}^2$  and has a power consumption of 0.6 mA/ch. A custom Front-End Board (FEB) has been developed (fig. 60) to host the chips. The board contains a passive network to protect the chip against possible spark events due to gas discharges and hosts two chips, for a total amount of 32 channels.

The main features of the FEB (whose dimension are  $30 \times 95 \text{ mm}^2$ ) are:

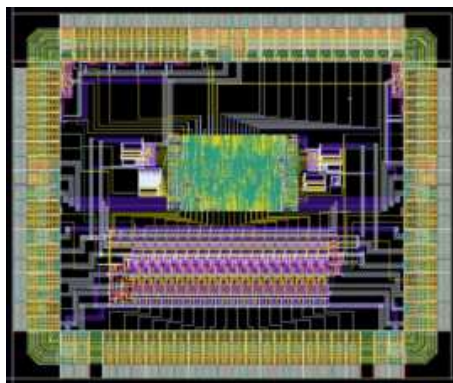

Figure 59: Layout of the 16 channels GASTONE chip

- 2 chips/board (32 channels)
- 2 independent LVDS serial data readout lines
- LVDS I/O for Slow Control/Reset/Trigger
- 16 chs OR output for self-triggering
- HW ID

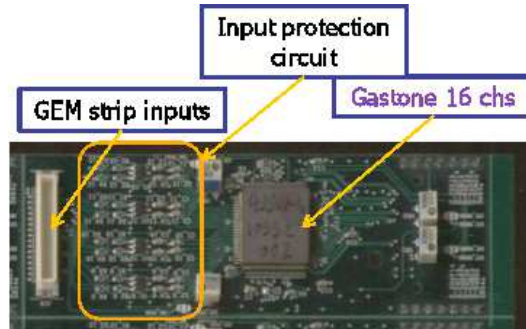

Figure 60: Front-End Board developed to host the first release of the chip. It includes the protection circuit connected to the input pads of the chip.

### 6.2.1 Lab test result

Twenty-two chips have been produced in the run. All chips have been characterized by means of a dedicated test bench based on a custom VME board implementing both the SPI control and the readout protocol. An Agilent Pulse Generator 81110A has been used to drive the charge injection used to test the devices.

**Charge sensitivity and gain measurements** The charge sensitivity over the 16 channels of one chip (chip 0 / Board 0) is shown in fig. 61. A good linearity and uniformity over the various channels can be easily inferred. Doing the same measurements over the 22 chips (352 channels), an average gain of 25mV/fC has been obtained (fig. 62).

**ENC measurements** The ENC directly measured on a triple-GEM  $10 \times 10$  cm<sup>2</sup> prototype (fig. 63) is about  $974 e_{rms} + 59 e_{rms}/\text{pF}$ . The measured value corresponds to  $\sim 0.63$  fC for the longest strip and sets a minimum level of  $\sim 1.5$  fC to the discriminator threshold. The difference between measured and simulated values is due to the PCB lines and protection diodes parasitic capacitance (between 5 and 10 pF).

**Time-Walk** The time response of the chip as a function of the input charge has been measured for different thresholds. As expected, the time response increases as the charge approaches the discriminator threshold, because of the used leading edge technique. In fig. 64 the results obtained for  $C_{det} = 10$  pF are shown.

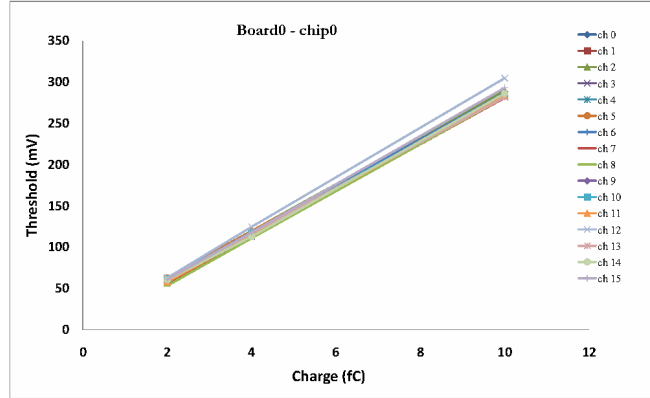

Figure 61: Charge sensitivity (threshold vs input charge)

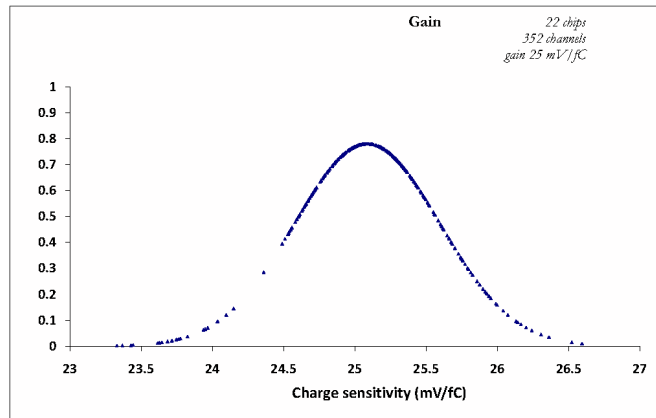

Figure 62: Gain distribution

### 6.3 Off-Detector electronics

The IT off-detector electronics is made of two sections. The first one (GASTONE Electronics Off-detector - GEO) will be located just outside KLOE with the aim of keeping the connections between the boards and the on-detector electronics as short as possible (about 3.5 m have been foreseen in the final design); the second one (CONCENTRATOR) will be located on



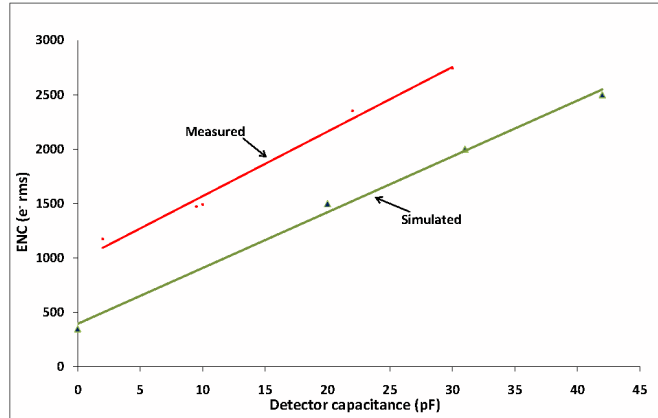

Figure 63: Simulated and measured ENC distributions

the platform near the DAQ electronics (about 15 m apart). The connections between the two sections will be implemented by means optical links, thus avoiding any trouble due to ground-loops and/or interference with other readout sections of the KLOE apparatus. A block diagram of the system is shown in fig. 65.

### 6.3.1 GEO boards

These boards, besides supplying low voltage to the on-detector electronics, provide full control over the GASTONE boards. More in detail, with these boards it is possible to set/read the GASTONE chips internal registers, to test different sections of the chain (then implementing an efficient debug procedure) and, finally, download the 64 bits data pattern if a Lev1 trigger signal is issued by the KLOE Trigger System. The board is foreseen working together with the CONCENTRATOR board; anyway some local control capability has been foreseen as well (Ethernet and USB) both to simplify the detector setup procedure and to use the board as stand-alone DAQ system.

Fig. 66 shows the block diagram of the GEO board. The two main circuit sections can be easily identified: the on-detector interface on the left side and the DAQ interface on the right side.

The first prototype of the board is shown in fig. 67. A Xilinx Virtex4 device has been used to manage both the Experiment Control System (ECS)

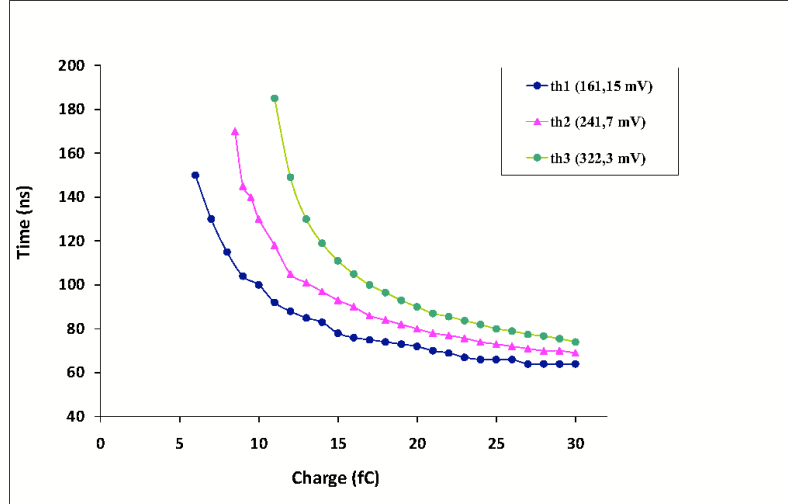

Figure 64: Time walk vs  $Q_{in}$  at  $C_{det} = 10$  pF

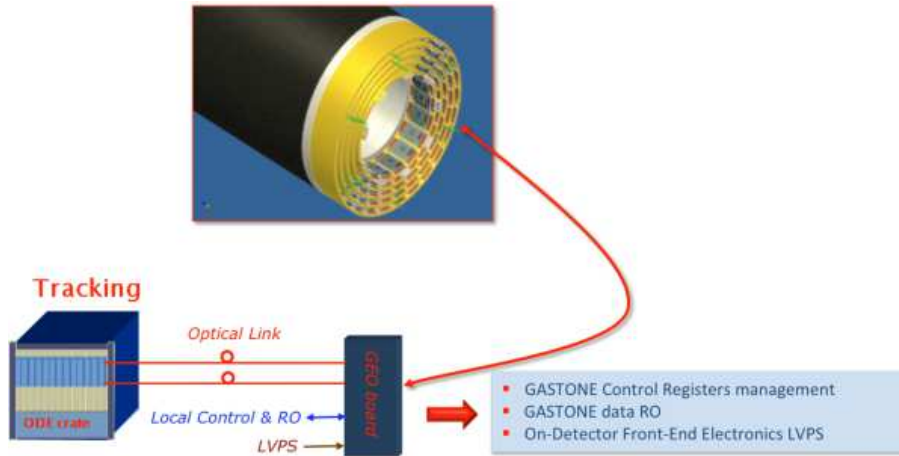

Figure 65: Inner Tracker readout block diagram

path (through the embedded Power PC processor) and the DAQ path. Data transmission to/from GASTONE boards has been implemented by means of LVDS connections (on the left-side of the board), while communications with the experiment DAQ and ECS systems have been implemented through two separate optical links (on the right side of the board). LVDS inputs have been foreseen to manage (if required) external signals.

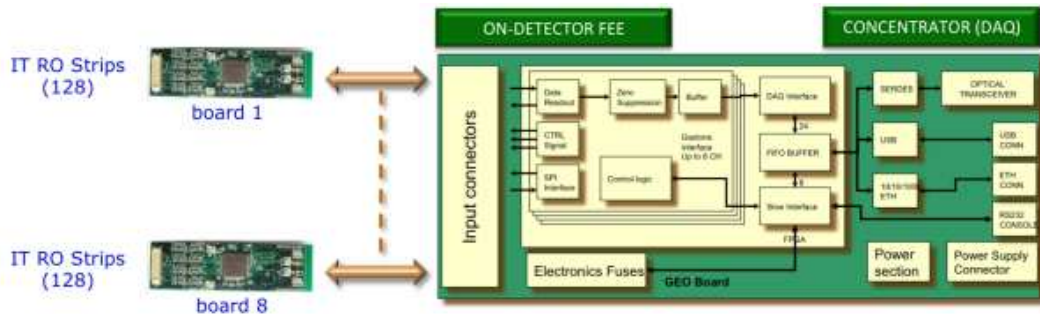

Figure 66: GEO readout board Readout block diagram

The readout procedure is started as soon as the Lev1 trigger signal is issued.



Figure 67: GEO readout board prototype

As a consequence of the Lev1 signal detection the GEO board internal state machine takes the following actions:

- propagates the Lev1 signal to the 468 sixty-four channels GASTONE chips to load the internal readout register with the 96 bits data frame;
- start the GASTONE boards readout procedure by delivering a 50 MHz readout clock (effective data throughput is 100 Mbit/s as both sides of the readout clock are used).

Zero suppression on incoming data has been foreseen, as well, to reduce data transfer size in case of low detector occupancy.

### 6.3.2 CONCENTRATOR board

As already said, the CONCENTRATOR boards (fig. 69) are located on the platform, about 15 m far from the detector. All communications (Slow Control, DAQ and Trigger) to/from the GEO boards are managed by these boards (through optical links).

The acquisition procedure is started by Lev1 trigger signal (fig. 68). When

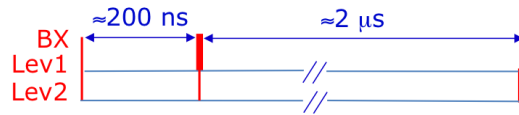

Figure 68: KLOE DAQ Timing

the GEO boards detect the trigger signal they propagate the signal to the on-detector electronics then loading the GASTONE output registers. After a while the GEO boards activate the download clock and the readout of the (about) 400 boards starts. After 900 ns the readout procedure is completed and, if enabled, the data zero suppression procedure starts. Finally,  $1.8 \mu s$  after the Lev1 signal the Lev2 trigger signal can be generated and data transmission from GEO boards to CONCENTRATOR starts.

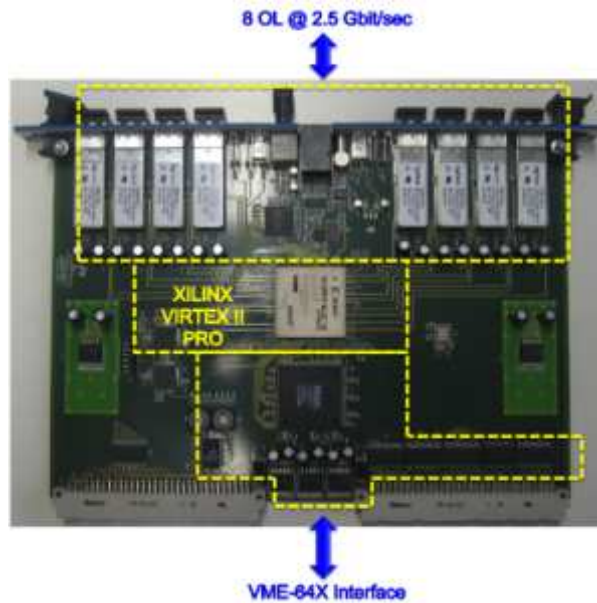

Figure 69: CONCENTRATOR board prototype

## 6.4 HV and FEE integration

### 6.4.1 FEE Integration

The number of connections between the detector readout plane and the front-end electronics is a function of the layers diameters. As an example, for the innermost layer there are about 3950 readout strips which are connected to the same number of electronics readout channels.

The connections density and the cylindrical structure of the readout dictates the usage of a 120 pins/0.5 mm pitch connector (fig. 70) positioned parallel with respect to the detector z axis. The connector has two retention plugs that allow a suitable fixation of the PCB to the mechanical support and the connection to the electrode ground plane.

To define the front-end board pcb dimension constraints a 3-D mechanical

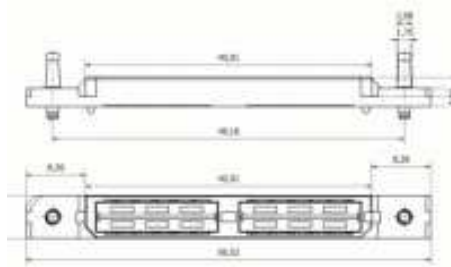

Figure 70: Front-end board connector

detector model has been implemented (fig. 71(a)). From the 3-D simulations a front-end board pcb maximum size of  $60 \times 40 \text{ mm}^2$  has been inferred (fig. 71(b)).

The readout signals are extracted from both sides of the cylindrical electrode in such a way to obtain a symmetrical readout. Finally the electronics channels have been arranged as described in tab.6 allowing the partition of the (cylindrical) readout electrode in three pieces covering 120 degrees each.

In the shaped far-end electrode protruded part ( see fig. 72), FR4 stiffness supports will be glued before soldering the front-end board input connectors. The stiffness support will be also used to fix the kapton foil to the cylindrical structure support .

For each side of the readout electrode a support flange (fig. 73(a)), im-

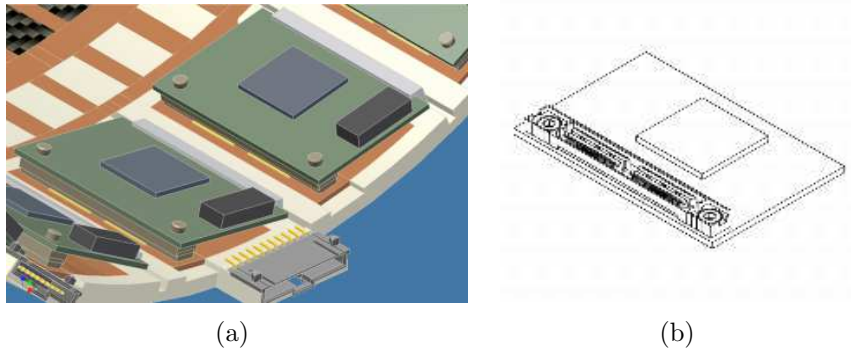

Figure 71: Detector 3-D model - front-end pcb insertion detail (a), PCB 3-D model (b)

Table 6: Front-End and HV connector per side

Layer Number	Radius(mm)	FEE Connector per side	HV Connector per side for one 120° sector
1	136	18	4
2	158	21	7
3	180	24	7
4	202	27	7
5	224	27	7

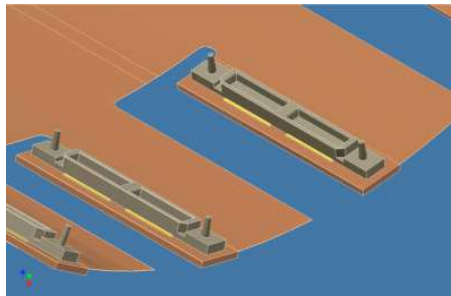

Figure 72: Stiffness support and connectors glued into the Kapton foil

plemented by an annular cylinder, has been foreseen. The flange will allow to allocate both the stiffness and the nozzles (located on the opposite side of the connector) used to hold the connector. Also the supports for the HV connectors (placed at regular angles, taking into account the segmentation of the three GEM detector planes) will be glued to the structure. Finally, the two flanges will be glued to the layer support structure and to the readout

electrode

Once each layer is built and tested, the detector will be assembled by at-

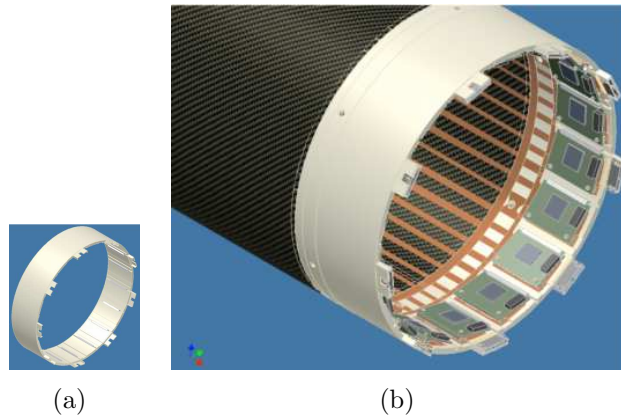

Figure 73: Front-end electronics support flanges (a), Detector structure (b)

taching layers together through suitable structure that will also allow the detector placing on the beam-pipe (fig. 73(b)).

In fig. 74 some details concerning the placement of HV connectors, front-end boards and gas connections for the 5 layers are shown.

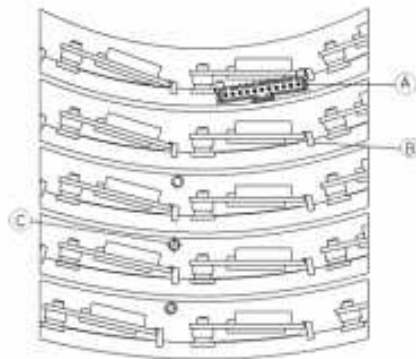

Figure 74: Support structure detail : A - HV connectors, B - front-end boards nozzles, C - gas connections

#### 6.4.2 HV Integration

Each GEM foil has 20 independent HV sections. The relative connections are routed on the same kapton foil into terminal wings coming out from the

detector volume. These wings will be positioned on the front-end support flange, underneath the FEE boards. The HV connectors are soldered and fixed on the same structure, as shown in fig. 75(a) and 75(b).

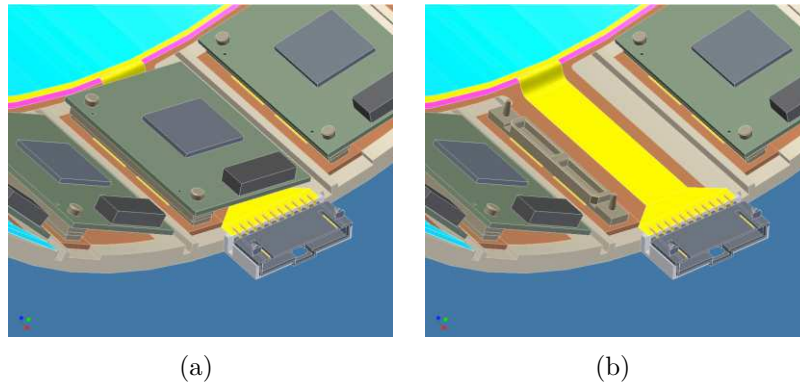

Figure 75: HV connection detail (a), HV and front-end board assembling detail (b)

### 6.4.3 Assembling test

In order to test the assembling procedure a detector layer mock-up will be manufactured, with the same dimensions and the same number of connections of the Layer 1, but with flanges on one side only (fig. 76).

Finally a thermal cycle test has been successfully carried out at 120 °C to validate the connector soldering and assembling procedure.



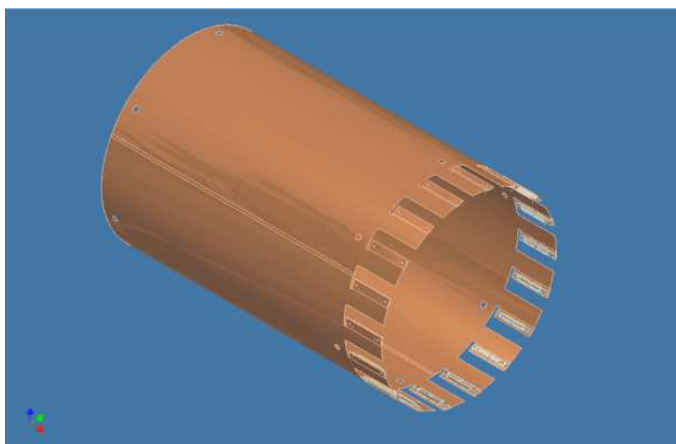

Figure 76: Test Layer Assembly

## 7 Time schedule and responsibilities sharing

The overall work program and schedule is summarized in fig. 77. It is divided into two main parts:

1. the finalization of the engineering design of the detector, including tenders, orders and materials delivery, that takes about 7.5 months;
2. the construction of the five layers, including QC/QA tests of the detectors, and the successive FEE installation, gas piping, HV connections, that will take less than 15 months.

In the schedule we also reported the sharing of responsibilities among the INFN groups historically involved in the R&D phase:

- a) the Bari group will have in charge the production and testing procedure to validate FE electronics together with the design and construction of the support frames.
- b) the Rome 1 group is responsible of the detector assembly system tool;
- c) the LNF group, beside the overall supervision of the project, is responsible for the construction and QC tools, the GEM foil design, construction and test of the detector.

Following our schedule, the final design of the IT started in September 2009 and the detector will be completed and ready for the installation by the end of July 2011.

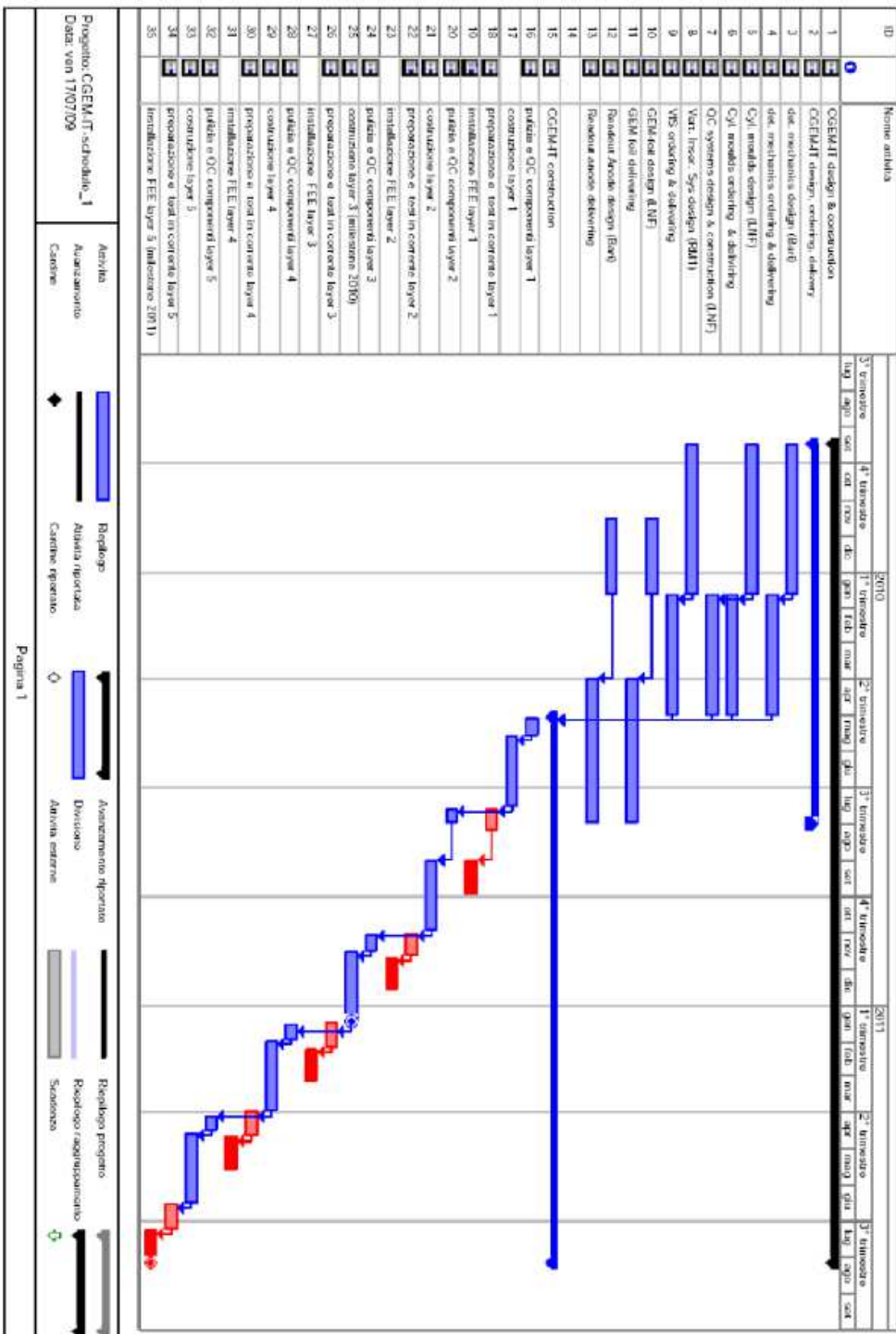

Figure 77: Time schedule

## References

- [1] F. Bossi, E. De Lucia, J. Lee-Franzini, S. Miscetti, M. Palutan and KLOE Collaboration, *Precision Kaon and Hadron Physics with KLOE*, Rivista del Nuovo Cimento Vol.31, N.10 (2008).
- [2] KLOE Collaboration, M. Adinolfi et al., *Nucl. Instrum. Methods A* **488** (2002) 51.
- [3] KLOE Collaboration, M. Adinolfi et al., *Nucl. Instrum. Methods A* **482** (2002) 364.
- [4] KLOE Collaboration, M. Adinolfi et al., *Nucl. Instrum. Methods A* **492** (2002) 134.
- [5] R. Beck et al, KLOE-2 collaboration, *Expression of interest for the continuation of the KLOE physics program at DAΦNE upgraded in luminosity and in energy*, March 31, 2006, available at <http://www.lnf.infn.it/lnfadmin/direzione/roadmap/LoIKLOE.pdf> .
- [6] R. Beck et al, KLOE-2 collaboration, *A proposal for the roll-in of the KLOE-2 detector*, LNF-07/19(IR), INFN-LNF, Frascati, 2007.
- [7] D. Babusci et al., *Nucl. Instrum. Methods A*, accepted for publication, doi:10.1016/j.nima.2009.09.110
- [8] F. Archilli et al., *Nucl. Instrum. Methods A*, accepted for publication, doi:10.1016/j.nima.2009.06.082
- [9] M. Cordelli et al., *Nucl. Instrum. Methods A*, accepted for publication, doi:10.1016/j.nima.2009.09.015
- [10] *Handbook on neutral kaon interferometry at a  $\phi$ -factory*, A. Di Domenico ed., Frascati Physics Series **43**, INFN-LNF, Frascati, 2007.
- [11] F. Ambrosino et al., KLOE collaboration, *Phys. Lett.* **B 642** (2006) 315.
- [12] A. Di Domenico and KLOE collaboration, *Journal of Physics: Conf. Series* 171 (2009) 012008.
- [13] J. Bernabeu, N. Mavromatos and J. Papavassiliou, *Phys. Rev. Lett.* **92** (2004) 131601. J. Bernabeu, N. Mavromatos, J. Papavassiliou and A. Waldron-Lauda, *Nucl. Phys. B* **744** (2006) 180.

- [14] R.A. Bertlmann, W. Grimus and B.C. Hiesmayr, Phys. Rev. D **60** (1999) 114032.
- [15] F. Ambrosino *et al.* (KLOE Collab.), Phys. Lett. B **636** (2006) 173.
- [16] F. Ambrosino *et al.* (KLOE Collab.), Phys. Lett. B **675** (2009) 283.
- [17] M. Alfonsi *et al.*, *Nucl. Instrum. Methods A* **50258** (2009) (in press)
- [18] F. Sauli, *Nucl. Instrum. Methods A* **386** (1997) 531.
- [19] CERN EST-DEM is the Design and Manufacture of Electronic Modules (DEM) Group of the Engineering Support & Technology Division (EST) <http://ts-dep-dem.web.cern.ch/ts-dep-dem/>
- [20] S Bachmann, *et al.*, *Nucl. Instrum. Methods A* **479** (2002) 294
- [21] A. Antonelli *et al.*, KLOE notes n. 3 (1991), 23 (1992), 52 (1993).
- [22] G. Bencivenni *et al.*, *Nucl. Instrum. Methods A* **581** (2007) 221.
- [23] G. Bencivenni *et al.*, *Performance of the cylindrical GEM prototype for the Inner Tracker of KLOE2*, NSS Conference Record 2008 IEEE.
- [24] A. Balla *et al.*, Nucl. Inst. & Meth. **A 604** (2009) 23.
- [25] G. Bencivenni *et al.*, *Status of the Cylindrical-GEM Project for the KLOE-2 Inner Tracker*, NSS Conference Record 2009 IEEE.
- [26] CERN Gas Detector Development (GDD) group <http://gdd.web.cern.ch/GDD/>
- [27] G. Bencivenni *et al.*, *Nucl. Instrum. Methods A* **494** (2002) 156.
- [28] G. Bencivenni *et al.*, *Nucl. Instrum. Methods A* **581** (2007) 221. G. Bencivenni *et al.*, *Nucl. Instrum. Methods A* **572** (2007) 168.
- [29] G. Bencivenni *et al.*, NSS Conference Record, 2007 IEEE. Volume 6 pp 4666-4670.
- [30] P. de Simone *et al.*, IEEE Trans. Nucl. Sci. 52 (2005) 2872.
- [31] M. Alfonsi *et al.*, *Nucl. Instrum. Methods A* **518** (2004) 106.
- [32] L. Quintieri *et al.*, *Finite Element Model of the Cylindrical GEM Detector as New Inner Tracker of Kloe2 and Mechanical Characterization of the Employed Materials*, LNF-09/12(IR), INFN-LNF, Frascati, 2009.

- [33] M. Alfonsi et al., NSS Conference Record, 2007 IEEE. Volume 6 pp 4671-4676.
- [34] M Benlloch, et.al. *Further developments of the gas electron multiplier*, CERN-EP-98-050 (1998).