

# Torsors, herds and flocks

Thomas Booker and Ross Street

June 11, 2018

*2000 Mathematics Subject Classification.* 18D35; 18D10; 20J06

*Key words and phrases.* torsor; herd; flock; monoidal category; descent morphism.

---

## Abstract

This paper presents non-commutative and structural notions of torsor. The two are related by the machinery of Tannaka-Krein duality.

## 1 Introduction

Let us describe briefly how the concepts and results dealt with in this paper are variants or generalizations of those existing in the literature.

While affine functions between vector spaces take lines to lines, they are not linear functions. In particular, translations do not preserve the origin. This phenomenon appears at the basic level with groups: left multiplication  $a- : G \rightarrow G$  by an element  $a$  of a group  $G$  is not a group morphism. However, left multiplication does preserve the ternary operation  $q : G^3 \rightarrow G$  defined by  $q(x, y, z) = xy^{-1}z$ . Clearly, the operation  $q$ , together with a choice of any element as unit, determine the group structure.

A herd is a set  $A$  with a ternary operation  $q$  satisfying three simple axioms motivated by the group example. References for this term go back a long way, originating with the German form “Schar”: see [13], [1], [8]. Because Hopf algebras generalize groups, it is natural to consider the corresponding generalization of herds. Such a generalization, involving algebras with a ternary “co-operation”, is indeed considered in [11]; for later developments see [2] and references there. Moreover, using the term “quantum heaps” of his 2002 thesis, Škoda [14] proved an equivalence between the category of copointed quantum heaps and the category of Hopf algebras.

In this paper, we use the term herd for a coalgebra with an appropriate ternary operation. As far as possible we work with comonoids in a braided monoidal category  $\mathcal{V}$  (admitting reflexive coequalizers preserved by  $X \otimes -$ ) rather than the special case of categories of modules over a commutative ring in which comonoids interpret as coalgebras over the ring. The algebra version is included by taking  $\mathcal{V}$  to be a dual category of modules (plus some flatness assumptions). When  $\mathcal{V}$  is the category of sets, we obtain the classical notion of herd.

The theory of torsors for a group in a topos  $\mathcal{E}$  appears in [6]. Torsors give an interpretation of the first cohomology group of the topos with coefficients in

the group. In Section 2 we review how, when working in a topos  $\mathcal{E}$ , torsors are herds with chosen elements existing locally. Locally here means after applying a functor  $- \times R : \mathcal{E} \rightarrow \mathcal{E}/R$  where  $R \rightarrow 1$  is an epimorphism in  $\mathcal{E}$ . Such a functor is conservative and, since it has both adjoints, is monadic.

In Section 3 we define herds in a braided monoidal category and make explicit the codescent condition causing them to be torsors for a Hopf monoid. This generalizes the topos case and slightly extends aspects of recent work of Grunspan [7] and Schauenburg [15], [16].

Finite dimensional representations of a Hopf algebra form an autonomous (= compact = rigid) monoidal category. In fact, as explained in [4], Hopf algebras and autonomous monoidal categories are structures of the same kind: autonomous pseudomonoids in different autonomous monoidal bicategories. In Section 4, we introduce a general structure in an autonomous monoidal bicategory we call a “flock”. It generalizes herd in the same way that autonomous pseudomonoid generalizes Hopf algebra. However, by looking at the autonomous monoidal bicategory  $\mathcal{V}\text{-Mod}$ , in Section 4 this gives us the notion of enriched flock, roughly described as an autonomous monoidal  $\mathcal{V}$ -category without a chosen unit for the tensor product. We believe our use of the term flock is new. However, our use is close to the concept of “heapy category” in [14].

The comodules admitting a dual over a herd in  $\mathcal{V}$  form a  $\mathcal{V}$ -flock. In Section 5 we adapt Tannaka duality (as presented, for example, in [9]) to relate  $\mathcal{V}$ -flocks and herds in  $\mathcal{V}$ .

In Section 3 we need to know that the existence of an antipode in a bimonoid is equivalent to the invertibility of the so-called fusion operator. For completeness, we include in an Appendix a direct proof shown to us by Micah McCurdy at the generality required. It is a standard result for Hopf algebras over a field.

## 2 Recollections on torsors for groups

Let  $G$  be a monoid in a cartesian closed, finitely complete and finitely cocomplete category  $\mathcal{E}$ . A  $G$ -torsor [6] is an object  $A$  with a  $G$ -action

$$\mu : G \times A \longrightarrow A$$

such that:

- (i) the unique  $! : A \longrightarrow 1$  is a regular epimorphism; and,
- (ii) the morphism  $(\mu, pr_2) : G \times A \longrightarrow A \times A$  is invertible.

The inverse to  $(\mu, pr_2)$  must have the form  $(\varpi, pr_2) : A \times A \longrightarrow G \times A$  where

$$\varpi : A \times A \longrightarrow G$$

has the property that the following two composites are equal to the first projections.

$$\begin{aligned} G \times A &\xrightarrow{1 \times \delta} G \times A \times A \xrightarrow{\mu \times 1} A \times A \xrightarrow{\varpi} G \\ A \times A &\xrightarrow{1 \times \delta} A \times A \times A \xrightarrow{\varpi \times 1} G \times A \xrightarrow{\mu} A \end{aligned}$$

If the epimorphism  $A \rightarrow 1$  is a retraction with right inverse  $a : 1 \rightarrow A$  then

$$G \xrightarrow{1 \times q} G \times A \xrightarrow{\mu} A$$

is an invertible morphism of  $G$ -actions where  $G$  acts on itself by its own multiplication. It follows that the existence of such a torsor forces  $G$  to be a group.

If  $A$  is a  $G$ -torsor in  $\mathcal{E}$ , we obtain a ternary operation on  $A$  as the composite

$$q : A \times A \times A \xrightarrow{\varpi \times 1} G \times A \xrightarrow{\mu} A.$$

The following properties hold:

$$\begin{array}{ccc} A \times A \times A \times A \times A & \xrightarrow{q \times 1 \times 1} & A \times A \times A \\ \downarrow 1 \times 1 \times q & = & \downarrow q \\ A \times A \times A & \xrightarrow{q} & A \end{array} \quad (2.1)$$

$$\begin{array}{ccc} & A \times A \times A & \\ \nearrow 1 \times \delta & = & \searrow q \\ A \times A & \xrightarrow{pr_1} & A \end{array} \quad (2.2)$$

$$\begin{array}{ccc} & A \times A \times A & \\ \nearrow \delta \times 1 & = & \searrow q \\ A \times A & \xrightarrow{pr_2} & A \end{array} \quad (2.3)$$

That is,  $A$  becomes a herd (“Schar” in German) in  $\mathcal{E}$ ; references for this term are [13], [1], [8].

Conversely, given a herd  $A$  in  $\mathcal{E}$  for which  $! : A \rightarrow 1$  is a regular epimorphism, a group  $G$  is obtained as the coequalizer  $\varpi : A \times A \rightarrow G$  of the two morphisms

$$A \times A \times A \xrightarrow{1 \times 1 \times \delta} A \times A \times A \times A \xrightarrow{q \times 1} A \times A \quad \text{and} \quad A \times A \times A \xrightarrow{1 \times 1 \times !} A \times A$$

with multiplication induced by

$$A \times A \times A \times A \xrightarrow{q \times 1} A \times A.$$

The unit for  $G$  is constructed using the composite  $A \xrightarrow{\delta} A \times A \xrightarrow{\varpi} G$  and the coequalizer

$$A \times A \begin{array}{c} \longrightarrow \\ \longrightarrow \end{array} A \longrightarrow 1.$$

Moreover, there is an action of  $G$  on  $A$  induced by  $q$  which causes  $A$  to be a  $G$ -torsor.

Our purpose is to generalize this to the case of comonoids in a monoidal category  $\mathcal{V}$  in place of the cartesian monoidal  $\mathcal{E}$  and to examine a higher dimensional version. We relate the two concepts using the Tannakian adjunction; see Chapter 16 of [17].

### 3 Non-commutative torsors

Let  $\mathcal{V}$  be a braided monoidal category with tensor product  $\otimes$  having unit  $I$ , and with reflexive coequalizers preserved by each  $X \otimes -$ .

For a comonoid  $A = (A, \delta : A \rightarrow A \otimes A, \varepsilon : A \rightarrow I)$  in  $\mathcal{V}$ , we write  $A^\circ$  for the opposite comonoid  $(A, A \xrightarrow{\delta} A \otimes A \xrightarrow{c_{A,A}} A \otimes A, \varepsilon : A \rightarrow I)$ . For comonoids  $A$  and  $B$ , there is a comonoid

$$A \otimes B = (A \otimes B, A \otimes B \xrightarrow{\delta \otimes \delta} A \otimes A \otimes B \otimes B \xrightarrow{1 \otimes c_{A,B} \otimes 1} A \otimes B \otimes A \otimes B, A \otimes B \xrightarrow{\varepsilon \otimes \varepsilon} I).$$

**Definition 1** A comonoid  $A$  in  $\mathcal{V}$  is called a *herd* when it is equipped with a comonoid morphism

$$q : A \otimes A^\circ \otimes A \rightarrow A \quad (3.1)$$

for which the following conditions hold:

$$\begin{array}{ccc} A \otimes A \otimes A \otimes A \otimes A & \xrightarrow{q \otimes 1 \otimes 1} & A \otimes A \otimes A \\ 1 \otimes 1 \otimes q \downarrow & = & \downarrow q \\ A \otimes A \otimes A & \xrightarrow{q} & A \end{array} \quad (3.2)$$

$$\begin{array}{ccc} & A \otimes A \otimes A & \\ 1 \otimes \delta \nearrow & = & \searrow q \\ A \otimes A & \xrightarrow{1 \otimes \varepsilon} & A \end{array} \quad (3.3)$$

$$\begin{array}{ccc} & A \otimes A \otimes A & \\ \delta \otimes 1 \nearrow & = & \searrow q \\ A \otimes A & \xrightarrow{\varepsilon \otimes 1} & A \end{array} \quad (3.4)$$

Such structures, stated dually, occur in [11] and [2], for example.

For any comonoid  $A$  in  $\mathcal{V}$  we have the category  $\text{Cm}_l A$  of left  $A$ -comodules  $\delta : M \rightarrow A \otimes M$ . There is a monad  $T_A$  on  $\text{Cm}_l A$  defined by

$$T_A(M \xrightarrow{\delta} A \otimes M) = \left( A \otimes M \xrightarrow{\delta \otimes 1} A \otimes A \otimes M \right), \quad (3.5)$$

with multiplication and unit for the monad having components

$$A \otimes A \otimes M \xrightarrow{1 \otimes \varepsilon \otimes 1} A \otimes M \quad \text{and} \quad M \xrightarrow{\delta} A \otimes M. \quad (3.6)$$

There is a comparison functor

$$K_A : \mathcal{V} \rightarrow (\text{Cm}_l A)^{T_A}$$

into the category of Eilenberg-Moore algebras taking  $X$  to the  $A$ -comodule  $\delta \otimes 1 : A \otimes X \rightarrow A \otimes A \otimes X$  with  $T_A$ -action  $1 \otimes \varepsilon \otimes 1 : A \otimes A \otimes X \rightarrow A \otimes X$ . We say that  $\varepsilon : A \rightarrow I$  is a *codescent morphism* when  $K_A$  is fully faithful. If  $K_A$  is an equivalence of categories (that is, the right adjoint to the underlying functor  $\text{Cm}_l A \rightarrow \mathcal{V}$  is monadic) then we say  $\varepsilon : A \rightarrow I$  is an *effective codescent morphism*.

**Definition 2** A *torsor* in  $\mathcal{V}$  is a herd  $A$  for which the counit  $\varepsilon : A \rightarrow I$  is a codescent morphism.

Let  $A$  be a herd. We asymmetrically introduce morphisms  $\sigma$  and  $\tau : A \otimes A \otimes A \rightarrow A \otimes A$  defined by

$$\sigma = \left( A \otimes A \otimes A \xrightarrow{1 \otimes 1 \otimes \delta} A \otimes A \otimes A \otimes A \xrightarrow{q \otimes 1} A \otimes A \right) \quad \text{and}$$

$$\tau = \left( A \otimes A \otimes A \xrightarrow{1 \otimes 1 \otimes \varepsilon} A \otimes A \right).$$

These form a reflexive pair using the common right inverse

$$A \otimes A \xrightarrow{1 \otimes \delta} A \otimes A \otimes A.$$

Let  $\varpi : A \otimes A \rightarrow H$  be the coequalizer of  $\sigma$  and  $\tau$ . It is easily seen that there is a unique comonoid structure on  $H$  such that  $\varpi : A \otimes A \rightarrow H$  becomes a comonoid morphism which means the following diagrams commutes (where  $c_{1342}$  is the positive braid whose underlying permutation is 1342).

$$\begin{array}{ccc} & & H \\ & \nearrow \varpi & \searrow \delta \\ A^{\otimes 2} & & H^{\otimes 2} \\ & \searrow \delta \otimes \delta & \nearrow \varpi \otimes \varpi \\ & & A^{\otimes 4} \\ & \xrightarrow{c_{1342}} & A^{\otimes 4} \end{array} \quad = \quad \begin{array}{ccc} & & A^{\otimes 2} \\ & \nearrow \varepsilon \otimes \varepsilon & \searrow \varepsilon \\ & & I \\ & \searrow \varepsilon & \nearrow \varepsilon \\ & & H \end{array} \quad (3.7)$$

Since  $H$  is a reflexive coequalizer, we have the coequalizer

$$A^{\otimes 6} \begin{array}{c} \xrightarrow{\sigma \otimes \sigma} \\ \xrightarrow{\tau \otimes \tau} \end{array} A^{\otimes 4} \xrightarrow{\varpi \otimes \varpi} H^{\otimes 2}. \quad (3.8)$$

It is readily checked that

$$A^{\otimes 6} \begin{array}{c} \xrightarrow{\sigma \otimes \sigma} \\ \xrightarrow{\tau \otimes \tau} \end{array} A^{\otimes 4} \xrightarrow{q \otimes 1} A^{\otimes 2} \xrightarrow{\varpi} H \quad (3.9)$$

commutes. So there exists a unique  $\mu : H^{\otimes 2} \rightarrow H$  such that

$$A^{\otimes 4} \xrightarrow{\varpi \otimes \varpi} H^{\otimes 2} \xrightarrow{\mu} H = A^{\otimes 4} \xrightarrow{q \otimes 1} A^{\otimes 2} \xrightarrow{\varpi} H. \quad (3.10)$$

**Proposition 1** This  $\mu : H^{\otimes 2} \rightarrow H$  is associative and a comonoid morphism.

**Proof** Associativity follows easily from equation (3.2) and (3.10). To show that  $\mu$  is a comonoid morphism we need to prove the equations

$$H^{\otimes 2} \xrightarrow{\delta \otimes \delta} H^{\otimes 4} \xrightarrow{1 \otimes c \otimes 1} H^{\otimes 4} \xrightarrow{\mu \otimes \mu} H^{\otimes 2} = H^{\otimes 2} \xrightarrow{\mu} H \xrightarrow{\delta} H^{\otimes 2} \quad (3.11)$$

$$H^{\otimes 2} \xrightarrow{\varepsilon \otimes \varepsilon} I = H^{\otimes 2} \xrightarrow{\mu} H \xrightarrow{\varepsilon} I. \quad (3.12)$$

The following diagram proves (3.11) while equation (3.12) follows easily from the second diagram of (3.7) and the fact that  $\varpi$  and  $q$  preserve counits.

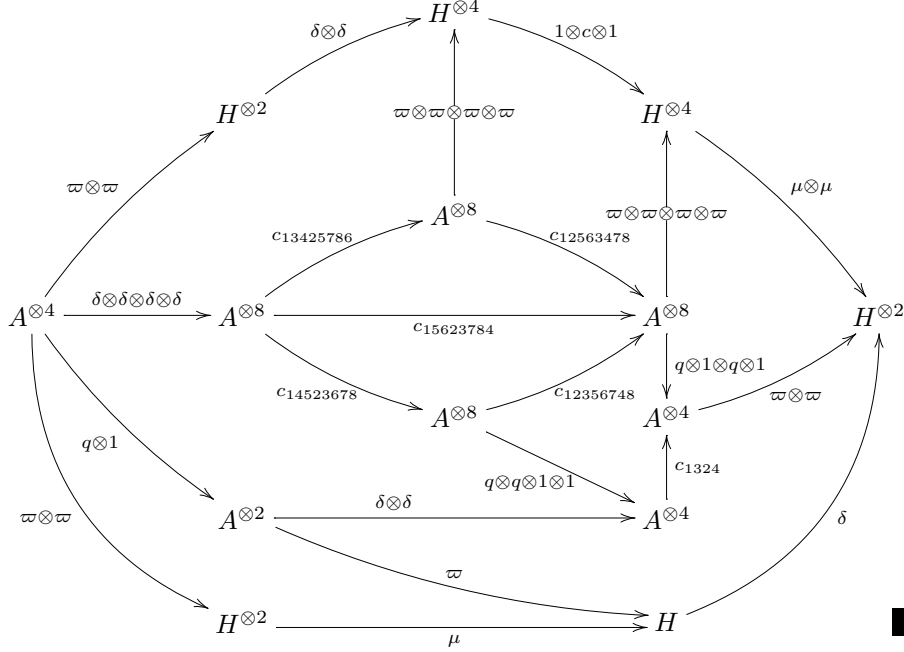

**Proposition 2** *If  $A$  is a torsor then  $H$  is a Hopf monoid and  $A$  is a left  $H$ -torsor.*

**Proof** In order to construct a unit for the multiplication on  $H$ , we use the codescent condition on  $\varepsilon : A \rightarrow I$ . We define  $\eta : I \rightarrow H$  by providing an Eilenberg-Moore  $T_A$ -algebra morphism from

$$K_A I = \left( A, A \otimes A \xrightarrow{1 \otimes \varepsilon} A \right)$$

to

$$K_A H = \left( A \otimes H, A \otimes A \otimes H \xrightarrow{1 \otimes \varepsilon \otimes 1} A \otimes H \right)$$

and using the assumption that  $K_A$  is fully faithful. The morphism is

$$A \xrightarrow{\delta} A \otimes A \xrightarrow{c_{A,A}} A \otimes A \xrightarrow{1 \otimes \delta} A \otimes A \otimes A \xrightarrow{1 \otimes \varpi} A \otimes H. \quad (3.13)$$

It is an  $(A \otimes -)$ -algebra morphism since

$$\begin{aligned} & (1 \otimes \varepsilon \otimes 1) (1 \otimes 1 \otimes \varpi) (1 \otimes 1 \otimes \delta) (1 \otimes c) (1 \otimes \delta) \\ &= (1 \otimes \varpi) (1 \otimes \delta) (1 \otimes \varepsilon \otimes 1) (1 \otimes c) (1 \otimes \delta) \\ &= (1 \otimes \varpi) (1 \otimes \delta) \\ &= (1 \otimes \varpi) (1 \otimes 1 \otimes 1 \otimes \varepsilon) c_{2341} (\delta \otimes \delta) \\ &= (1 \otimes \varpi) (1 \otimes q \otimes 1) (1 \otimes \delta \otimes \delta) c_{231} (1 \otimes \delta) \\ &= (1 \otimes \varpi) (1 \otimes \delta) c_{21} \delta (1 \otimes \varepsilon). \end{aligned}$$

So indeed we can define  $\eta$  by

$$1_A \otimes \eta = (1 \otimes \varpi)(1 \otimes \delta) c_{A,A} \delta . \quad (3.14)$$

Here is the proof that  $\eta$  is a right unit:

$$\begin{aligned} & (1 \otimes \mu)(1 \otimes 1 \otimes \eta)(1 \otimes \varpi) \\ = & (1 \otimes \mu)(c^{-1} \otimes 1)(1 \otimes 1 \otimes \eta) c(1 \otimes \varpi) \\ = & (1 \otimes \mu)(c^{-1} \otimes 1)(1 \otimes 1 \otimes \varpi)(1 \otimes 1 \otimes \delta)(1 \otimes c\delta) c(1 \otimes \varpi) \\ = & (1 \otimes \mu)(1 \otimes \varpi \otimes \varpi\delta)(c_{231})^{-1}(1 \otimes 1 \otimes c\delta) c_{231} \\ = & (1 \otimes \varpi)(1 \otimes q \otimes 1)(1 \otimes 1 \otimes \delta)(c_{231})^{-1}(1 \otimes 1 \otimes c\delta) c_{231} \\ = & (1 \otimes \varpi)(1 \otimes 1 \otimes 1 \otimes \varepsilon)(c_{231})^{-1}(1 \otimes 1 \otimes c\delta) c_{231} \\ = & 1 \otimes \varpi. \end{aligned}$$

Here is the proof that  $\eta$  is a left unit:

$$\begin{aligned} & (1 \otimes \mu)(1 \otimes \eta \otimes 1)(1 \otimes \varpi) \\ = & (1 \otimes \mu)(1 \otimes \varpi \otimes 1)(1 \otimes \delta \otimes 1)(c\delta \otimes 1)(1 \otimes \varpi) \\ = & (1 \otimes \mu)(1 \otimes \varpi \otimes \varpi)(1 \otimes \delta \otimes 1 \otimes 1)(c\delta \otimes 1 \otimes 1) \\ = & (1 \otimes \varpi)(1 \otimes q \otimes 1)(1 \otimes \delta \otimes 1 \otimes 1)(c\delta \otimes 1 \otimes 1) \\ = & (1 \otimes \varpi)(1 \otimes \varepsilon \otimes 1 \otimes 1)(c\delta \otimes 1 \otimes 1) \\ = & 1 \otimes \varpi. \end{aligned}$$

To complete the proof that  $H$  is a bimonoid, one easily checks the remaining properties:

$$I \xrightarrow{\eta} H \xrightarrow{\delta} H \otimes H = I \xrightarrow{\eta \otimes \eta} H \otimes H \quad (3.15)$$

$$I \xrightarrow{\eta} H \xrightarrow{\varepsilon} I = I \xrightarrow{1} I. \quad (3.16)$$

Using the coequalizer

$$A^{\otimes 4} \begin{array}{c} \xrightarrow{\sigma \otimes 1} \\ \xrightarrow{\tau \otimes 1} \end{array} A^{\otimes 3} \xrightarrow{\varpi \otimes 1} H \otimes A , \quad (3.17)$$

we can define a morphism

$$\mu : H \otimes A \longrightarrow A \quad (3.18)$$

by the condition

$$A \otimes A \otimes A \xrightarrow{\varpi \otimes 1} H \otimes A \xrightarrow{\mu} A = A \otimes A \otimes A \xrightarrow{q} A . \quad (3.19)$$

It is easy to see that this is a comonoid morphism and satisfies the two axioms for a left action of the bimonoid  $H$  on  $A$ . Moreover, the *fusion morphism*

$$v = \left( H \otimes A \xrightarrow{1 \otimes \delta} H \otimes A \otimes A \xrightarrow{\mu \otimes 1} A \otimes A \right) \quad (3.20)$$

has inverse

$$A \otimes A \xrightarrow{1 \otimes \delta} A \otimes A \otimes A \xrightarrow{\varpi \otimes 1} H \otimes A. \quad (3.21)$$

In fact,  $H$  is a Hopf monoid. To see this, consider the fusion morphism

$$v = \left( H \otimes H \xrightarrow{1 \otimes \delta} H \otimes H \otimes H \xrightarrow{\mu \otimes 1} H \otimes H \right). \quad (3.22)$$

It suffices to prove this is invertible (see the Section 8 Appendix for a proof that this implies the existence of an antipode). Again we appeal to the codescent property of  $\varepsilon : A \rightarrow I$ ; we only require that  $\mathcal{V} \rightarrow \text{Cm}_I A$  is conservative (reflects invertibility). For, we have the fusion equation

$$\begin{array}{ccc} & H \otimes H \otimes A \xrightarrow{1 \otimes v} H \otimes A \otimes A & \\ \begin{array}{c} \nearrow v \otimes 1 \\ \searrow 1 \otimes v \end{array} & & \begin{array}{c} \searrow v \otimes 1 \\ \nearrow 1 \otimes v \end{array} \\ H \otimes H \otimes A & = & A \otimes A \otimes A \\ & & \begin{array}{c} \xrightarrow{c \otimes 1} A \otimes H \otimes A \end{array} \end{array} \quad (3.23)$$

which holds in  $\text{Cm}_I A$ . All morphisms here are known to be invertible with the exception of  $H \otimes H \otimes A \xrightarrow{v \otimes 1} H \otimes H \otimes A$ . So that possible exception is also invertible.  $\blacksquare$

Alternatively, for the herd  $A$ , we can introduce morphisms  $\sigma' : A \otimes A \otimes A \rightarrow A \otimes A$  and  $\tau' : A \otimes A \otimes A \rightarrow A \otimes A$  defined by

$$\sigma' = \left( A \otimes A \otimes A \xrightarrow{\delta \otimes 1 \otimes 1} A \otimes A \otimes A \otimes A \xrightarrow{1 \otimes q} A \otimes A \right) \quad \text{and}$$

$$\tau' = \left( A \otimes A \otimes A \xrightarrow{\varepsilon \otimes 1 \otimes 1} A \otimes A \right).$$

These form a reflexive pair using the common right inverse

$$A \otimes A \xrightarrow{\delta \otimes 1} A \otimes A \otimes A.$$

Let  $\varpi' : A \otimes A \rightarrow H'$  be the coequalizer of  $\sigma'$  and  $\tau'$ . Then there is a unique comonoid structure on  $H'$  such that  $\varpi' : A^\circ \otimes A \rightarrow H'$  becomes a comonoid morphism. Symmetrically to  $H$ , we see that  $A$  becomes a right  $H'$ -torsor for the Hopf monoid  $H'$ . Indeed,  $A$  is a torsor from  $H$  to  $H'$  in the sense that the actions make  $A$  a left  $H$ -, right  $H'$ -bimodule.



## 4 Flocks

Flocks are a higher-dimensional version of herds. Our use of the term may be in conflict with other uses in the literature (such as [3]).

**Definition 3** Let  $\mathcal{M}$  denote a right autonomous monoidal bicategory [5]. So each object  $X$  has a bidual  $X^\circ$  with unit  $n : I \rightarrow X^\circ \otimes X$  and counit  $e : X \otimes X^\circ \rightarrow I$ .

A *left flock* in  $\mathcal{M}$  is an object  $A$  equipped with a morphism

$$q : A \otimes A^\circ \otimes A \rightarrow A \quad (4.1)$$

and 2-cells

$$\begin{array}{ccc} A \otimes A^\circ \otimes A \otimes A^\circ \otimes A & \xrightarrow{q \otimes 1 \otimes 1} & A \otimes A^\circ \otimes A \\ 1 \otimes 1 \otimes q \downarrow & \phi \Downarrow \cong & \downarrow q \\ A \otimes A^\circ \otimes A & \xrightarrow{q} & A \end{array} \quad (4.2)$$

$$\begin{array}{ccc} & A \otimes A^\circ \otimes A & \\ 1 \otimes n \nearrow & \Downarrow \alpha & \searrow q \\ A & \xrightarrow{1} & A \end{array} \quad (4.3)$$

$$\begin{array}{ccc} & e \otimes 1 & \\ A \otimes A^\circ \otimes A & \xrightarrow{\quad} & A \\ & \Downarrow \beta & \\ & q & \end{array} \quad (4.4)$$

satisfying the following three conditions (where  $1_n = \overbrace{1 \otimes \dots \otimes 1}^n$ ):

$$\begin{array}{ccc} & q(1_2 \otimes q)(q \otimes 1_4) \cong q(q \otimes 1_2)(1_4 \otimes q) & \\ \phi(q \otimes 1_4) \nearrow & & \searrow \phi(1_4 \otimes q) \\ q(q \otimes 1_2)(q \otimes 1_4) & = & q(1_2 \otimes q)(1_4 \otimes q) \\ q(\phi \otimes 1_2) \Downarrow & & \Uparrow q(1_2 \otimes \phi) \\ q(q \otimes 1_2)(1_2 \otimes q \otimes 1_2) & \xrightarrow{\phi(1_2 \otimes q \otimes 1_2)} & q(1_2 \otimes q)(1_2 \otimes q \otimes 1_2) \end{array} \quad (4.5)$$

$$\begin{array}{ccc} 1 & \cong & (e \otimes 1)(1 \otimes n) \xrightarrow{\beta(1 \otimes n)} q(1 \otimes n) \\ & \searrow & \downarrow \alpha \\ & & 1 \end{array} \quad (4.6)$$

$$\begin{array}{ccc} q(1_2 \otimes q)(1_1 \otimes n \otimes 1_2) & \xrightarrow{\phi^{-1}(1_1 \otimes n \otimes 1_2)} & q(q \otimes 1_2)(1_1 \otimes n \otimes 1_2) \\ q(1_2 \otimes \beta)(1_1 \otimes n \otimes 1_2) \uparrow & = & \downarrow q(\alpha \otimes 1_2) \\ q(1_2 \otimes e \otimes 1_1)(1_1 \otimes n \otimes 1_2) \cong q1_3 \cong q & \xrightarrow{1} & q \cong q1_3 \end{array} \quad (4.7)$$

**Example 1** Suppose  $A$  is a left autonomous pseudomonoid in  $\mathcal{M}$  in the sense of [4] and [12]. A pseudomonoid consists of an object  $A$ , morphisms  $p : A \otimes A \rightarrow A$  and  $j : I \rightarrow A$ , 2-cells  $\phi : p(p \otimes 1) \Rightarrow p(1 \otimes p)$ ,  $\lambda : p(j \otimes 1) \Rightarrow 1$  and  $\rho : p(1 \otimes j) \Rightarrow 1$ , satisfying coherence axioms. It is left autonomous when it is equipped with a left dualization morphism  $d : A^\circ \rightarrow A$  having 2-cells  $\alpha : p(d \otimes 1)n \Rightarrow j$  and  $\beta : je \Rightarrow p(1 \otimes d)$ , satisfying two axioms. Put

$$q = \left( A \otimes A^\circ \otimes A \xrightarrow{1 \otimes d \otimes 1} A \otimes A \otimes A \xrightarrow{p \otimes 1} A \otimes A \xrightarrow{p} A \right)$$

$$\begin{aligned} \phi : q(q \otimes 1_2) &= p(p \otimes 1)(1 \otimes d \otimes 1)(p \otimes 1_2)(p \otimes 1_3)(1 \otimes d \otimes 1_3) \\ &\cong p(p \otimes 1)(p \otimes 1_2)(p \otimes 1_3)(1 \otimes d \otimes 1 \otimes d \otimes 1) \\ &\cong p_5(1 \otimes d \otimes 1 \otimes d \otimes 1) \\ &\cong p(p \otimes 1)(1_2 \otimes p)(1_2 \otimes p \otimes 1)(1 \otimes d \otimes 1 \otimes d \otimes 1) \\ &\cong q(1_2 \otimes q) \end{aligned}$$

$$\alpha : q(1 \otimes n) \cong p(1 \otimes (p(d \otimes 1)n)) \xrightarrow{p(1 \otimes \alpha)} p(1 \otimes j) \cong 1$$

$$\beta : e \otimes 1 \cong p(j \otimes 1)(e \otimes 1) \cong p((je) \otimes 1) \xrightarrow{p(\beta \otimes 1)} p((p(1 \otimes d)) \otimes 1) \cong q.$$

The axioms for the flock  $(A, q, \phi, \alpha, \beta)$  follow from those on  $(A, p, \phi, \lambda, \rho, d, \alpha, \beta)$  in [4].

**Remark** As noted in [5], Baez-Dolan coined the term ‘‘microcosm principal’’ for the phenomenon whereby a concept finds its appropriate level of generality in a higher dimensional version of the concept. In particular, monoids in the category of sets generalize to monoids in monoidal categories. Similarly, monoidal categories generalize to pseudomonoids in monoidal bicategories. For autonomous pseudomonoids the context is an autonomous monoidal bicategory. Example 1 shows that autonomous monoidal categories become flocks. Although we shall not explicitly define a biflock, an autonomous monoidal bicategory would be an example. The general context for flock would be biflock.

Given a left flock  $A$ , consider the mate

$$\hat{q} : A^\circ \otimes A \longrightarrow A^\circ \otimes A \tag{4.8}$$

of  $q$  under the biduality  $A \dashv_b A^\circ$ ; that is,  $\hat{q}$  is the composite

$$A^\circ \otimes A \xrightarrow{n \otimes 1_2} A^\circ \otimes A \otimes A^\circ \otimes A \xrightarrow{1 \otimes q} A^\circ \otimes A. \tag{4.9}$$

Define  $\mu : \hat{q}\hat{q} \Longrightarrow \hat{q}$  to be the composite

$$\begin{aligned} (1 \otimes q)(n \otimes 1_2)(1 \otimes q)(n \otimes 1_2) &\cong \\ (1 \otimes q)(1 \otimes q \otimes 1)(1 \otimes n \otimes 1)(n \otimes 1_2) &\xrightarrow{(1 \otimes q)(1 \otimes \alpha \otimes 1)(n \otimes 1_2)} (1 \otimes q)(n \otimes 1_2) \end{aligned} \tag{4.10}$$

and  $\eta : 1_2 \implies \hat{q}$  to be the composite

$$1_2 \cong (1 \otimes e \otimes 1) (n \otimes 1_2) \xrightarrow{(1 \otimes \beta)(n \otimes 1_2)} (1 \otimes q) (n \otimes 1_2) . \quad (4.11)$$

**Proposition 3**  $(\hat{q}, \mu, \eta)$  is a monad on  $A^\circ \otimes A$ .

**Proof** Conditions (4.5), (4.6) and (4.7) translate to the monad axioms.  $\blacksquare$

Assume a Kleisli object  $K$  exists for the monad  $\hat{q}$ . So we have a morphism

$$h : A^\circ \otimes A \longrightarrow K \quad (4.12)$$

and a 2-cell

$$\chi : h\hat{q} \implies h \quad (4.13)$$

forming the universal Eilenberg-Moore algebra for the monad defined by pre-composition with  $\hat{q}$ . It follows that  $h$  is a map in the bicategory  $\mathcal{M}$ ; that is,  $h$  has a right adjoint  $h^* : K \longrightarrow A^\circ \otimes A$ .

**Proposition 4** *The morphism*

$$1 \otimes q : A^\circ \otimes A \otimes A^\circ \otimes A \longrightarrow A^\circ \otimes A$$

*induces a pseudo-associative multiplication*

$$p : K \otimes K \longrightarrow K.$$

**Proof** We obtain a monad opmorphism  $(1 \otimes q, \psi) : (A^\circ \otimes A \otimes A^\circ \otimes A, \hat{q} \otimes \hat{q}) \longrightarrow (A^\circ \otimes A, \hat{q})$  where  $\psi$  is the composite 2-cell

$$\begin{aligned} (1 \otimes q) (\hat{q} \otimes \hat{q}) &= (1 \otimes q) (1_3 \otimes q) (1 \otimes q \otimes 1_4) (1_4 \otimes n \otimes 1_2) (n \otimes 1_4) \cong \\ &(1 \otimes q) (1_3 \otimes q) (1_3 \otimes q \otimes 1_2) (1_4 \otimes n \otimes 1_2) (n \otimes 1_4) \implies (1 \otimes q) (1_3 \otimes q) (n \otimes 1_4) \cong \\ &(1 \otimes q) (n \otimes 1_2) (1 \otimes q) \cong \hat{q}(1 \otimes q). \end{aligned} \quad (4.14)$$

Since the Kleisli object for the monad  $\hat{q} \otimes \hat{q}$  is  $K \otimes K$ , the morphism  $p : K \otimes K \longrightarrow K$  is induced by  $(1 \otimes q, \psi)$ . The invertible 2-cell  $\phi$  of (4.2) induces an invertible  $\phi : p(p \otimes 1) \implies p(1 \otimes p)$  satisfying the appropriate ‘‘pentagon’’ condition following from condition (4.5).  $\blacksquare$

**Proposition 5** *The morphism  $q : A \otimes A^\circ \otimes A \longrightarrow A$  induces a pseudo-action*

$$\bar{q} : A \otimes K \longrightarrow A.$$

*If  $q$  is a map then so is  $\bar{q}$ .*

**Proof** The Kleisli object for the monad  $1 \otimes \hat{q}$  on  $A \otimes A^\circ \otimes A$  is  $A \otimes K$ . So there exists a unique  $\bar{q} : A \otimes K \longrightarrow A$  such that

$$\begin{aligned} &\left( q(1 \otimes \hat{q}) \cong \bar{q}(1 \otimes h) (1 \otimes \hat{q}) \xrightarrow{\bar{q}(1 \otimes \chi)} \bar{q}(1 \otimes h) \cong q \right) = \\ &\left( q(1 \otimes \hat{q}) = q(1_2 \otimes q) (1 \otimes n \otimes 1_2) \cong q(q \otimes 1_2) (1 \otimes n \otimes 1_2) \xrightarrow{q(\alpha \otimes 1_2)} q \right). \end{aligned} \quad \blacksquare$$

**Proposition 6** *The morphism  $h : A^\circ \otimes A \longrightarrow K$  is a parametric left adjoint for  $\bar{q} : A \otimes K \longrightarrow A$ . That is, the mate*

$$K \xrightarrow{n \otimes 1} A^\circ \otimes A \otimes K \xrightarrow{1 \otimes \bar{q}} A^\circ \otimes A \quad (4.15)$$

*of  $\bar{q}$  is right adjoint to  $h : A^\circ \otimes A \longrightarrow K$ .*

## 5 Enriched flocks

Suppose  $\mathcal{V}$  is a base monoidal category of the kind considered in [10] and we will use the enriched category theory developed there. In particular recall that the end  $\int_A T(A, A)$  of a  $\mathcal{V}$ -functor  $T : \mathcal{A}^{\text{op}} \otimes \mathcal{A} \rightarrow \mathcal{V}$  is constructed as the equalizer

$$\int_A T(A, A) \longrightarrow \prod_A T(A, A) \rightrightarrows \prod_{A,B} \mathcal{V}(\mathcal{A}(A, B), T(A, B))$$

For a  $\mathcal{V}$ -functor  $T : \mathcal{A}^{\text{op}} \otimes \mathcal{A} \rightarrow \mathcal{X}$ , the end  $\int_A T(A, A)$  and coend  $\int^A T(A, A)$  are defined by  $\mathcal{V}$ -natural isomorphisms

$$\begin{aligned} \mathcal{X}(X, \int_A T(A, A)) &\cong \int_A \mathcal{X}(X, T(A, A)) \text{ and} \\ \mathcal{X}(\int^A T(A, A), X) &\cong \int_A \mathcal{X}(T(A, A), X). \end{aligned}$$

**Definition 4** A *left  $\mathcal{V}$ -flock* is a flock  $\mathcal{A}$  in  $\mathcal{V}\text{-Mod}$  for which the structure module

$$Q : \mathcal{A} \otimes \mathcal{A}^{\text{op}} \otimes \mathcal{A} \longrightarrow \mathcal{A} \quad (5.1)$$

of (4.1) is a  $\mathcal{V}$ -functor. More explicitly, we have a  $\mathcal{V}$ -category  $\mathcal{A}$  and a  $\mathcal{V}$ -functor  $Q : \mathcal{A} \otimes \mathcal{A}^{\text{op}} \otimes \mathcal{A} \longrightarrow \mathcal{A}$  equipped with  $\mathcal{V}$ -natural transformations

$$\phi : Q(Q(A, B, C), D, E) \xrightarrow{\cong} Q(A, B, Q(C, D, E)) \quad (5.2)$$

$$\alpha_A^B : Q(A, B, B) \longrightarrow A \quad (5.3)$$

$$\beta_B^A : B \longrightarrow Q(A, A, B), \quad (5.4)$$

with  $\phi$  invertible, such that the following three conditions hold:

$$\begin{array}{ccc} Q(Q(A, B, C), D, Q(E, F, G)) & \xrightarrow{\phi} & Q(A, B, Q(C, D, Q(E, F, G))) \\ \uparrow \phi & & \uparrow Q(1,1,\phi) \\ Q(Q(Q(A, B, C), D, E), F, G) & = & \\ \downarrow Q(\phi,1,1) & & \\ Q(Q(A, B, Q(C, D, E)), F, G) & \xrightarrow{\phi} & Q(A, B, Q(Q(C, D, E), F, G)) \end{array} \quad (5.5)$$

$$\begin{array}{ccc} Q(A, B, Q(B, B, C)) & \xrightarrow{\phi^{-1}} & Q(Q(A, B, B), B, C) \\ \uparrow Q(1,1,\beta) & = & \downarrow Q(\alpha,1,1) \\ Q(A, B, C) & \xrightarrow{1} & Q(A, B, C) \end{array} \quad (5.6)$$

$$\begin{array}{ccc} & Q(A, A, A) & \\ \beta \nearrow & = & \searrow \alpha \\ A & \xrightarrow{1} & A \end{array} \quad (5.7)$$

The following observation characterizes the special case of Example 3 (below) where  $\mathcal{H} = \mathcal{A}$ .

**Proposition 7** *Suppose  $\mathcal{A}$  is a  $\mathcal{V}$ -flock which has an object  $J$  for which  $\alpha_A^K : Q(A, J, J) \rightarrow A$  and  $\beta_B^K : B \rightarrow Q(J, J, B)$  are invertible for all  $A$  and  $B$ . Then  $\mathcal{A}$  becomes a left autonomous monoidal  $\mathcal{V}$ -category by defining*

$$A \otimes B = Q(A, J, B) \quad \text{and} \quad A^* = Q(J, A, J). \quad (5.8)$$

*The associativity and unit constraints are defined by instances of  $\phi$ ,  $\alpha$  and  $\beta$ , while the counit and unit for  $A^* \dashv A$  are  $\alpha_K^A$  and  $\beta_K^A$ .*

Now, given any  $\mathcal{V}$ -flock, we have the Kleisli  $\mathcal{V}$ -category  $\mathcal{K}$  and a  $\mathcal{V}$ -functor

$$H : \mathcal{A}^{\text{op}} \otimes \mathcal{A} \rightarrow \mathcal{K} \quad (5.9)$$

constructed as in (4.12). The objects of  $\mathcal{K}$  are pairs  $(A, B)$  as for  $\mathcal{A}^{\text{op}} \otimes \mathcal{A}$  and the hom-objects are defined by

$$\mathcal{K}((A, B), (C, D)) = \mathcal{A}(B, Q(A, C, D)). \quad (5.10)$$

Composition

$$\int^{C, D} \mathcal{K}((C, D), (E, F)) \otimes \mathcal{K}((A, B), (C, D)) \rightarrow \mathcal{K}((A, B), (E, F)) \quad (5.11)$$

for  $\mathcal{K}$  is defined to be the morphism

$$\int^{C, D} \mathcal{A}(D, Q(C, E, F)) \otimes \mathcal{A}(B, Q(A, C, D)) \rightarrow \mathcal{A}(B, Q(A, E, F))$$

equal to the composite of the canonical Yoneda isomorphism with the composite

$$\begin{aligned} & \int^C \mathcal{A}(B, Q(A, C, Q(C, E, F))) \xrightarrow{\int^C \mathcal{A}(1, \phi^{-1})} \\ & \int^C \mathcal{A}(B, Q(Q(A, C, C), E, F)) \xrightarrow{\int^C \mathcal{A}(1, Q(\alpha, 1, 1))} \mathcal{A}(B, Q(A, E, F)). \end{aligned}$$

The  $\mathcal{V}$ -functor  $H$  of (5.9) is the identity on objects and its effect on hom-objects

$$\mathcal{A}(C, A) \otimes \mathcal{A}(B, D) \xrightarrow{H} \mathcal{A}(B, Q(A, C, D))$$

is the  $\mathcal{V}$ -natural family corresponding under the Yoneda Lemma to the composite

$$I \xrightarrow{j_B} \mathcal{A}(B, B) \xrightarrow{\mathcal{A}(1, \beta)} \mathcal{A}(B, Q(A, A, B)).$$

**Example 2** Let  $\mathcal{X}$  and  $\mathcal{Y}$  be  $\mathcal{V}$ -categories for a suitable  $\mathcal{V}$ . There is a  $\mathcal{V}$ -category  $\text{Adj}(\mathcal{X}, \mathcal{Y})$  of adjunctions between  $\mathcal{X}$  and  $\mathcal{Y}$ : the objects  $\mathbf{F} = (F, F^*, \varepsilon, \eta)$  consist of  $\mathcal{V}$ -functors  $F : \mathcal{X} \rightarrow \mathcal{Y}$ ,  $F^* : \mathcal{Y} \rightarrow \mathcal{X}$ , and  $\mathcal{V}$ -natural transformations  $\varepsilon : FF^* \Rightarrow 1_{\mathcal{Y}}$  and  $\eta : 1_{\mathcal{X}} \Rightarrow F^*F$  which are the counit and unit for an adjunction  $F \dashv F^*$ ; the hom objects are defined by

$$\text{Adj}(\mathcal{X}, \mathcal{Y})(\mathbf{F}, \mathbf{G}) = [\mathcal{X}, \mathcal{Y}](F, G) = \int_X \mathcal{X}(FX, GX) (\cong [\mathcal{Y}, \mathcal{X}](G^*, F^*))$$

where  $[\mathcal{X}, \mathcal{Y}]$  is the  $\mathcal{V}$ -functor  $\mathcal{V}$ -category [10]. We obtain a  $\mathcal{V}$ -flock  $\mathcal{A} = \text{Adj}(\mathcal{X}, \mathcal{Y})$  by defining

$$Q(F, G, H) = (HG^*F, F^*GH^*, \varepsilon, \eta)$$

where  $\varepsilon$  and  $\eta$  come by composition from those for  $F \dashv F^*$ ,  $G \dashv G^*$  and  $H \dashv H^*$ . In this case  $\phi$  is an equality while  $\alpha$  and  $\beta$  are induced by the appropriate counit  $\varepsilon$  and unit  $\eta$ . Notice that

$$\mathcal{K}((\mathbf{F}, \mathbf{G}), (\mathbf{H}, \mathbf{K})) = [\mathcal{Y}, \mathcal{Y}](GF^*, KH^*).$$

**Example 3** Let  $\mathcal{H}$  be a left autonomous monoidal  $\mathcal{V}$ -category for suitable  $\mathcal{V}$ . For each  $X \in \mathcal{H}$ , we have  $X^* \in \mathcal{H}$  and  $\varepsilon : X^* \otimes X \rightarrow I$  and  $\eta : I \rightarrow X \otimes X^*$  inducing isomorphisms

$$\mathcal{H}(X^* \otimes Y, Z) \cong \mathcal{H}(Y, X \otimes Z) \quad \text{and} \quad (5.12)$$

$$\mathcal{H}(Y \otimes X, Z) \cong \mathcal{H}(Y, Z \otimes X^*). \quad (5.13)$$

So  ${}^X Z = Z \otimes X^*$  acts as a left internal hom for  $\mathcal{H}$  and

$$\langle X, Y \rangle = X^* \otimes Y \quad (5.14)$$

acts as a left internal cohom. Notice that

$${}^X(Z \otimes Y) \cong Z \otimes Y \otimes X^* \cong Z \otimes {}^X Y \quad \text{and} \quad (5.15)$$

$$\langle X, Y \otimes Z \rangle \cong X^* \otimes Y \otimes Z \cong \langle X, Y \rangle \otimes Z. \quad (5.16)$$

Suppose  $\mathcal{A}$  is a right  $\mathcal{H}$ -actegory; that is,  $\mathcal{A}$  is a  $\mathcal{V}$ -category equipped with a  $\mathcal{V}$ -functor

$$* : \mathcal{A} \otimes \mathcal{H} \rightarrow \mathcal{A} \quad (5.17)$$

and  $\mathcal{V}$ -natural isomorphisms

$$(A * X) * Y \cong A * (X \otimes Y) \quad \text{and} \quad (5.18)$$

$$A * I \cong A \quad (5.19)$$

satisfying the obvious coherence conditions. Suppose further that each  $\mathcal{V}$ -functor

$$A * - : \mathcal{H} \rightarrow \mathcal{A} \quad (5.20)$$

has a left adjoint

$$\langle A, - \rangle : \mathcal{A} \rightarrow \mathcal{H}. \quad (5.21)$$

It follows that we have a  $\mathcal{V}$ -functor

$$\langle -, - \rangle : \mathcal{A}^{\text{op}} \otimes \mathcal{A} \rightarrow \mathcal{H} \quad (5.22)$$

and a  $\mathcal{V}$ -natural isomorphism

$$\mathcal{H}(\langle A, B \rangle, Z) \cong \mathcal{A}(B, A * Z). \quad (5.23)$$

To encapsulate:  $\mathcal{A}^{\text{op}}$  is a tensored  $\mathcal{H}^{\text{op}}$ -category. Observe that we have a canonical isomorphism

$$\langle A, B * Z \rangle \cong \langle A, B \rangle \otimes Z. \quad (5.24)$$

For, we have the natural isomorphisms

$$\begin{aligned}\mathcal{H}(\langle A, B * Z \rangle, X) &\cong \mathcal{A}(B * Z, A * X) \cong \mathcal{A}(B, (A * X) * Z^*) \cong \\ &\mathcal{A}(B, A * (X \otimes Z^*)) \cong \mathcal{H}(\langle A, B \rangle, X \otimes Z^*) \cong \mathcal{H}(\langle A, B \rangle \otimes Z, X).\end{aligned}$$

There are also canonical morphisms

$$e : \langle A, B \rangle \longrightarrow I \quad \text{and} \quad (5.25)$$

$$d : B \longrightarrow A * \langle A, B \rangle \quad (5.26)$$

corresponding respectively under isomorphism (5.23) to  $A \cong A * I$  and  $1 : \langle A, B \rangle \longrightarrow \langle A, B \rangle$ . Finally, we come to our example of a left  $\mathcal{V}$ -flock. The  $\mathcal{V}$ -category is  $\mathcal{A}$  and the  $\mathcal{V}$ -functor  $Q : \mathcal{A} \otimes \mathcal{A}^{\text{op}} \otimes \mathcal{A} \longrightarrow \mathcal{A}$  of (5.1) is

$$Q(A, B, C) = A * \langle B, C \rangle. \quad (5.27)$$

The isomorphism  $\phi$  of (5.2) is derived from (5.24) as

$$Q(Q(A, B, C), D, E) = A * \langle B, C \rangle * \langle D, E \rangle \cong A * \langle B, C * \langle D, E \rangle \rangle \cong Q(A, B, Q(C, D, E)). \quad (5.28)$$

The natural transformations  $\alpha$  and  $\beta$  of (5.3) and (5.4) are

$$Q(A, B, B) = A * \langle B, B \rangle \xrightarrow{1 * e} A * I \cong A \quad \text{and} \quad (5.29)$$

$$B \xrightarrow{d} A * \langle A, B \rangle = Q(A, A, B). \quad (5.30)$$

In this case the Kleisli  $\mathcal{V}$ -category  $\mathcal{K}$  of (5.9) is given by the  $\mathcal{V}$ -functor  $\langle -, - \rangle$  of (5.22). Notice that  $\mathcal{K}$  is closed under binary tensoring in  $\mathcal{H}$  since, by (5.24), we have

$$\langle A, B \rangle \otimes \langle C, D \rangle \cong \langle A, B * \langle C, D \rangle \rangle.$$

However,  $\mathcal{K}$  may not contain the  $I$  of  $\mathcal{H}$ .

**Definition 5** Suppose  $F : \mathcal{A} \longrightarrow \mathcal{X}$  is a  $\mathcal{V}$ -functor between  $\mathcal{V}$ -flocks  $\mathcal{A}$  and  $\mathcal{X}$ . We call  $F$  *flockular* when it is equipped with a  $\mathcal{V}$ -natural family consisting of maps

$$\rho_{A,B,C} : Q(FA, FB, FC) \rightarrow FQ(A, B, C)$$

such that

$$\begin{array}{ccc} Q(FQ(A, B, C), FD, FE) & \xrightarrow{\rho} & FQ(Q(A, B, C), D, E) \\ \uparrow Q(\rho, 1, 1) & & \downarrow F\phi \\ Q(Q(FA, FB, FC), FD, FE) & = & FQ(A, B, Q(C, D, E)) \\ \downarrow \phi & & \uparrow \rho \\ Q(FA, FB, Q(FC, FD, FE)) & \xrightarrow{Q(1, 1, \rho)} & Q(FA, FB, FQ(C, D, E)) \end{array}$$

$$\begin{array}{ccc}
& & FQ(A, B, B) \\
& \nearrow \rho & \\
Q(FA, FB, FB) & \xrightarrow{\alpha} & FA \\
& & \searrow F\alpha \\
& & =
\end{array} \tag{5.31}$$

$$\begin{array}{ccc}
& & Q(FA, FA, FB) \\
& \nearrow \beta & \\
FB & \xrightarrow{F\beta} & FQ(A, A, B) \\
& & \searrow \rho \\
& & =
\end{array} \tag{5.32}$$

(where we have suppressed the subscripts of  $\rho$ ) commute. We call  $F$  *strong flockular* when each  $\rho_{A,B,C}$  is invertible.

## 6 Herd comodules

Let  $A$  be a herd in  $\mathcal{V}$  in the sense of Section 3. In the first instance,  $A$  is a comonoid. Write  $\text{Cm}_{r_f}A$  for the  $\mathcal{V}$ -category of right  $A$ -comodules whose underlying objects in  $\mathcal{V}$  have duals. Write  $\mathcal{V}_f$  for the full subcategory of  $\mathcal{V}$  consisting of the objects with duals. We shall show that  $\text{Cm}_{r_f}A$  is a  $\mathcal{V}$ -flock in the sense of Section 5 and that the forgetful  $\mathcal{V}$ -functor  $U : \text{Cm}_{r_f}A \rightarrow \mathcal{V}_f$  is strong flockular.

The flock structure on  $\mathcal{V}_f$  is  $Q(L, M, N) = L \otimes M^* \otimes N$  which is a special case of Example 3 with  $\mathcal{A} = \mathcal{H} = \mathcal{V}_f$ . We wish to lift this flock structure on  $\mathcal{V}_f$  to  $\text{Cm}_{r_f}A$ . So, assuming  $L, M$  and  $N$  are right  $A$ -comodules with duals in  $\mathcal{V}$ , we need to provide a right  $A$ -comodule structure on  $L \otimes M^* \otimes N$ . This is defined as the composite

$$\begin{aligned}
L \otimes M^* \otimes N &\xrightarrow{1 \otimes 1 \otimes \eta \otimes 1} L \otimes M^* \otimes M \otimes M^* \otimes N \xrightarrow{\delta \otimes 1 \otimes \delta \otimes 1 \otimes \delta} L \otimes A \otimes M^* \otimes M \otimes A \otimes \\
&M^* \otimes N \otimes A \xrightarrow{1 \otimes 1 \otimes \varepsilon \otimes 1 \otimes 1 \otimes 1} L \otimes A \otimes A \otimes M^* \otimes N \otimes A \xrightarrow{c_{145236}} \\
&L \otimes M^* \otimes N \otimes A \otimes A \otimes A \xrightarrow{1 \otimes 1 \otimes 1 \otimes q} L \otimes M^* \otimes N \otimes A. \tag{6.1}
\end{aligned}$$

In terms of strings we can write this as

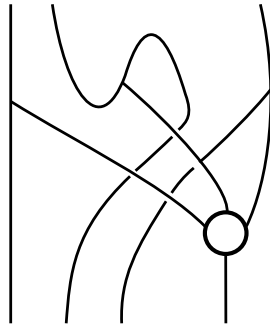

$$\tag{6.2}$$



**Theorem 8** For all right  $A$ -comodules  $L, M$  and  $N$  with duals in  $\mathcal{V}$ , the composite (6.1) renders  $Q(L, M, N) = L \otimes M^* \otimes N$  a right  $A$ -comodule such that the canonical morphisms

$$\begin{aligned} \phi &: Q(Q(L, M, N), R, S) \rightarrow Q(L, M, Q(N, R, S)), \\ \alpha &: Q(L, M, M) \rightarrow L \quad \text{and} \quad \beta : M \rightarrow Q(L, L, M) \end{aligned}$$

in  $\mathcal{V}$  are right  $A$ -comodule morphisms. Further,  $\text{Cm}_{r,f}A$  is a flock such that the forgetful functor  $U : \text{Cm}_{r,f}A \rightarrow \mathcal{V}_f$  is strong flockular.

*Proof.* The main coaction axiom for the composite (6.1) follows by using a duality (“snake”) identity for  $M^* \dashv M$ , the coaction axioms for  $L, M$  and  $N$ , and that  $q$  is a comonoid morphism.

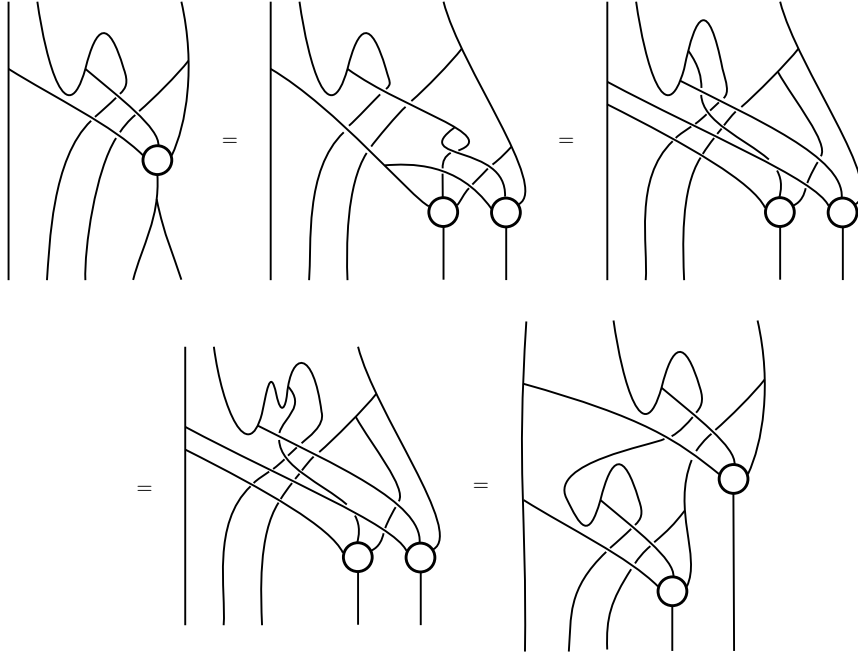

The fact that  $\phi, \alpha$  and  $\beta$  are right comodule morphisms follow from duality identities, comonoid axioms, and equations (3.2), (3.3) and (3.4).

The calculation for  $\phi$  is straight forward

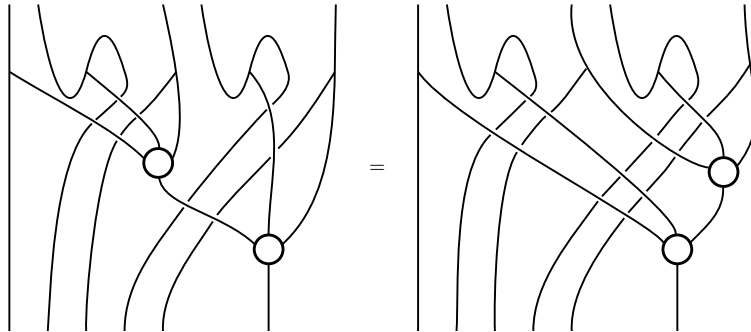

The one for  $\alpha$  is

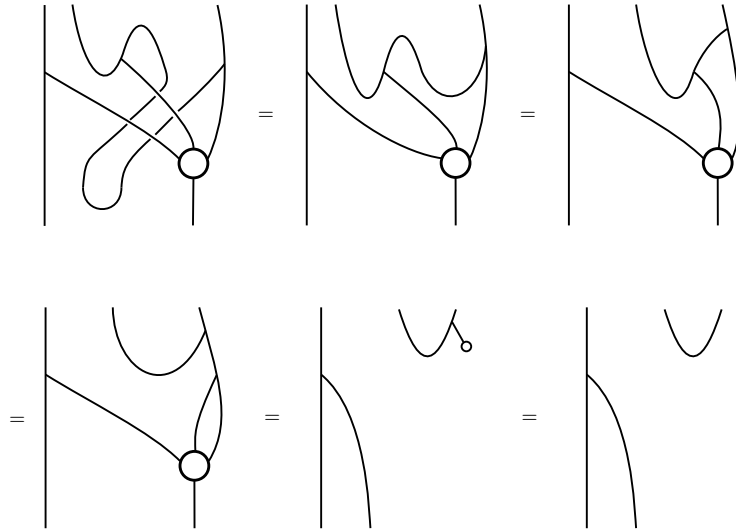

and the one for  $\beta$  is

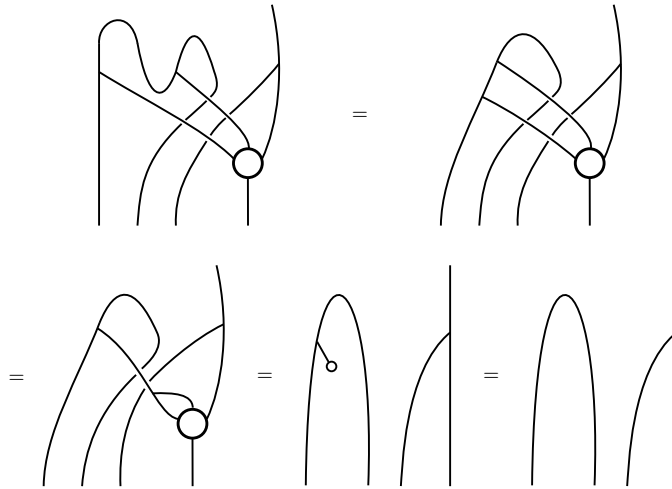

Since the forgetful functor  $\text{Cm}_{r_f}A \rightarrow \mathcal{V}_f$  is faithful, the flock axioms hold in  $\text{Cm}_{r_f}A$  because they do in  $\mathcal{V}_f$ , it follows that  $\text{Cm}_{r_f}A$  is a flock. Clearly also the  $\mathcal{V}$ -functor  $U : \text{Cm}_{r_f}A \rightarrow \mathcal{V}_f$  is strong flockular. ■

## 7 Tannaka duality for flocks and herds

Given a strong flockular  $\mathcal{V}$ -functor  $F : \mathcal{A} \rightarrow \mathcal{V}_f$ , we show that, when the coend

$$E = \text{End}^\vee F = \int^A (FA)^* \otimes FA, \quad (7.1)$$

exists in  $\mathcal{V}$ , it is a herd in  $\mathcal{V}$ . To simplify notation, let us put  $eX = X^* \otimes X$  for  $X \in \mathcal{V}$  so that, for  $A \in \mathcal{A}$ , we have a coprojection

$$\text{copr}_A : eFA \rightarrow E.$$

It is well known that  $E$  is a comonoid (see [17] for example). The comultiplication  $\delta : E \rightarrow E \otimes E$  is defined by commutativity of

$$\begin{array}{ccc} eFA & \xrightarrow{1 \otimes \eta \otimes 1} & eFA \otimes eFA \\ \text{copr}_A \downarrow & & \downarrow \text{copr}_A \otimes \text{copr}_A \\ E & \xrightarrow{\delta} & E \otimes E \end{array} \quad (7.2)$$

The counit  $\varepsilon : E \rightarrow I$  restricts along the coprojection  $\text{copr}_A : eFA \rightarrow E$  to yield the counit for the duality  $FA^* \dashv FA$ .

We have the following isomorphisms

$$\begin{aligned} E^{\otimes 3} &= \int^A eFA \otimes \int^B eFB \otimes \int^C eFC \\ &\cong \int^{A,B,C} eFA \otimes eFB \otimes eFC \\ &\cong \int^{A,B,C} ((FA) \otimes (FB)^* \otimes FC)^* \otimes FA \otimes (FB)^* \otimes FC \\ &\cong \int^{A,B,C} Q(FA, FB, FC)^* \otimes Q(FA, FB, FC) \\ &\cong \int^{A,B,C} (FQ(A, B, C))^* \otimes FQ(A, B, C) \\ &= \int^{A,B,C} eFQ(A, B, C) \end{aligned}$$

compatible with the coprojections. The morphism  $q : E \otimes E \otimes E \rightarrow E$  is defined by commutativity of

$$\begin{array}{ccc} eFQ(A, B, C) & \xrightarrow{\text{copr}_{A,B,C}} & E^{\otimes 3} \\ & \searrow \text{copr}_{Q(A,B,C)} & \downarrow q \\ & & E \end{array} \quad (7.3)$$

**Theorem 9** *For any strong flockular  $\mathcal{V}$ -functor  $F : \mathcal{A} \rightarrow \mathcal{V}_f$ , the coend (7.1), and diagrams (7.2) and (7.3), define a herd  $E$  in  $\mathcal{V}$ .*

**Proof** Once again we proceed by strings. As usual, morphisms in string diagrams are depicted as nodes shown as circles with the morphism's name written inside. However, coprojections  $\text{copr}_A : eA \rightarrow E$  are labeled as  $A$ . We define the comonoid multiplication by

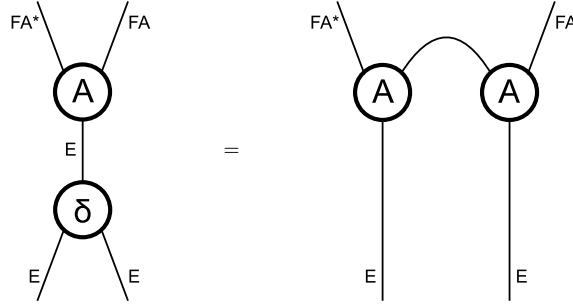

and the counit by

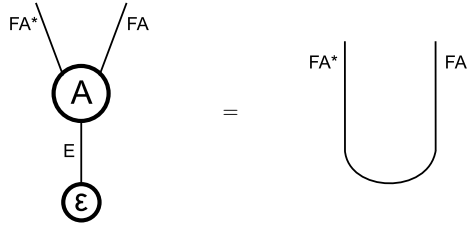

The  $q$  for the herd structure is

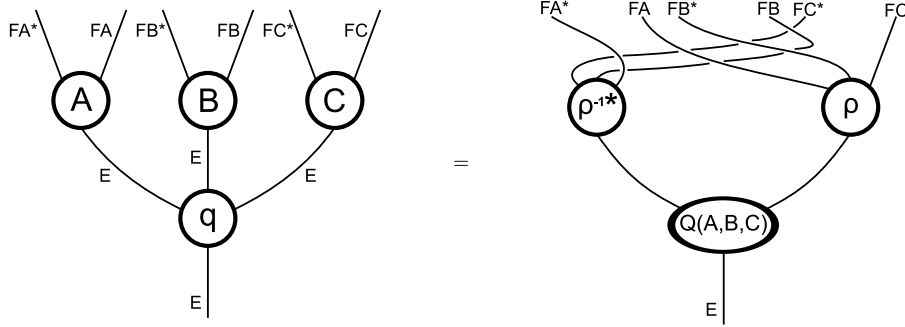

There are also the  $\alpha$  and  $\beta$  where, for example

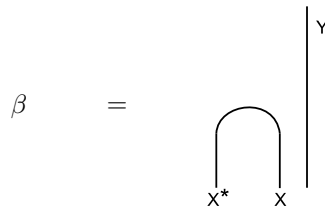

$$\beta^* = \left| \begin{array}{c} \text{Y}^* \text{ X}^* \text{ X} \\ \text{---} \\ \text{---} \end{array} \right.$$

for which we have the following identifications:

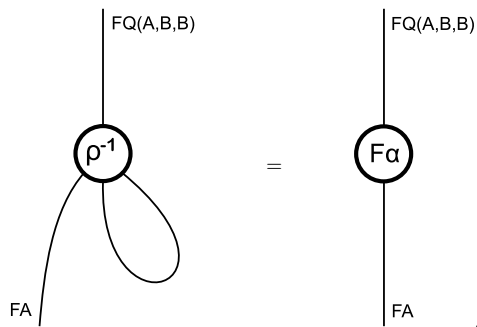
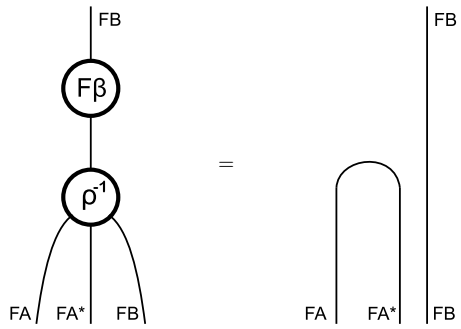
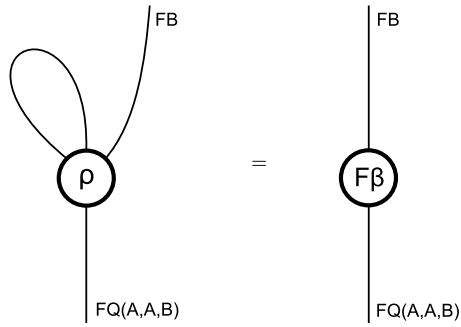

From now on we will drop the labels on the strings and take them to be understood.

By Definition 1 we require  $q$  to be a comonoid morphism. We proceed as follows:

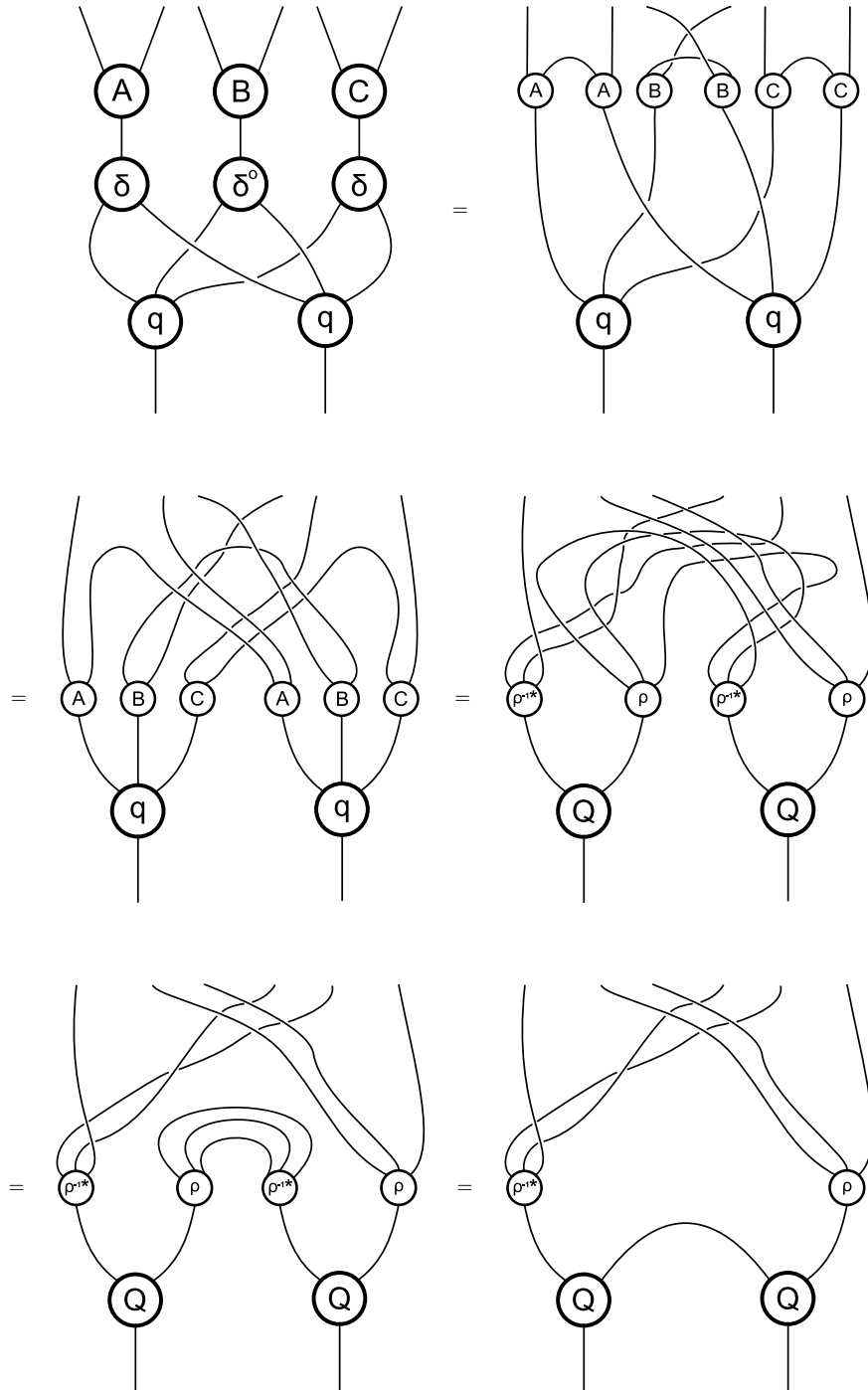

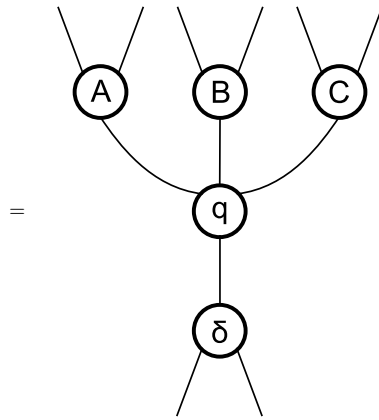

The map  $q$  defined above is also associative since:

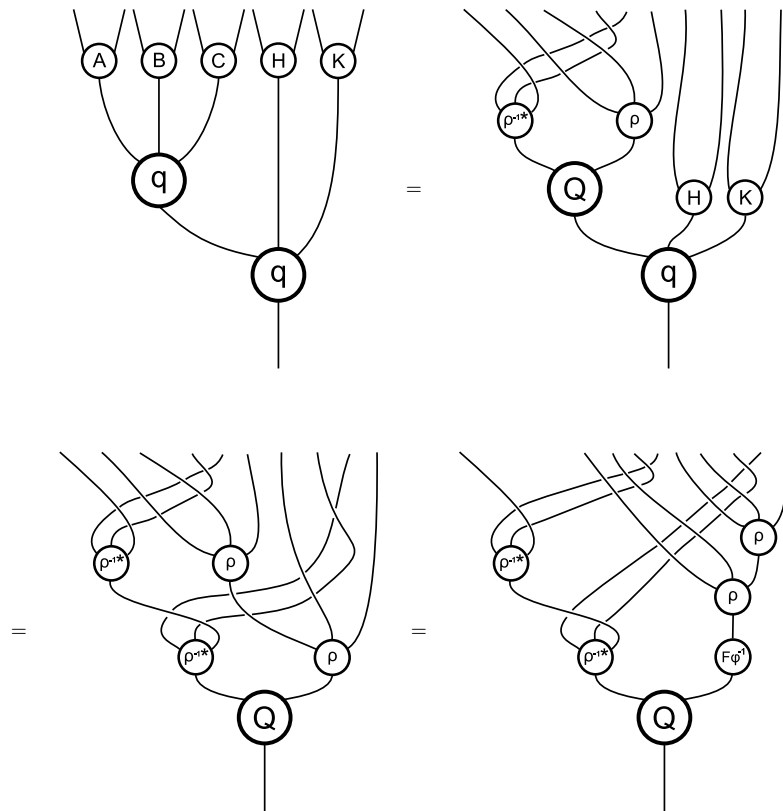

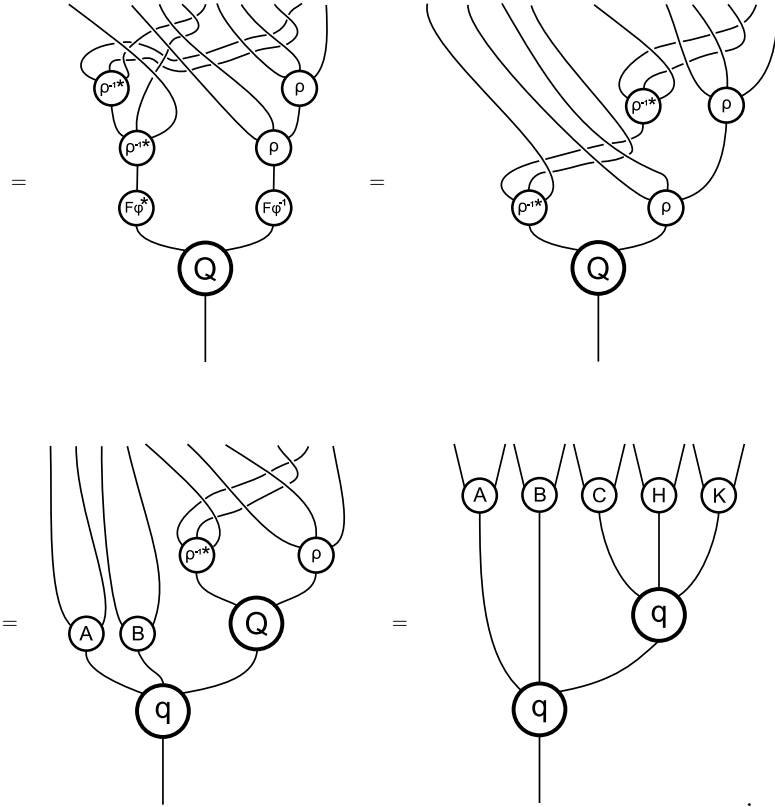

The calculation for comultiplying on the left is:

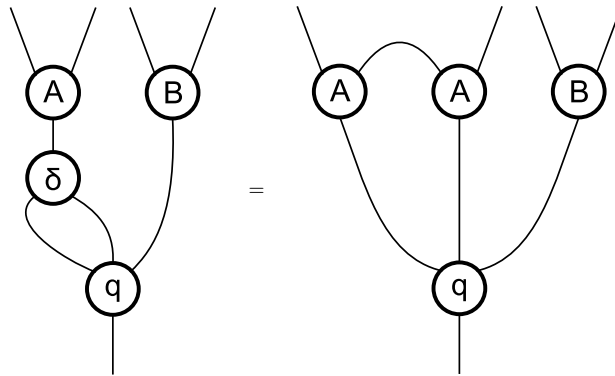



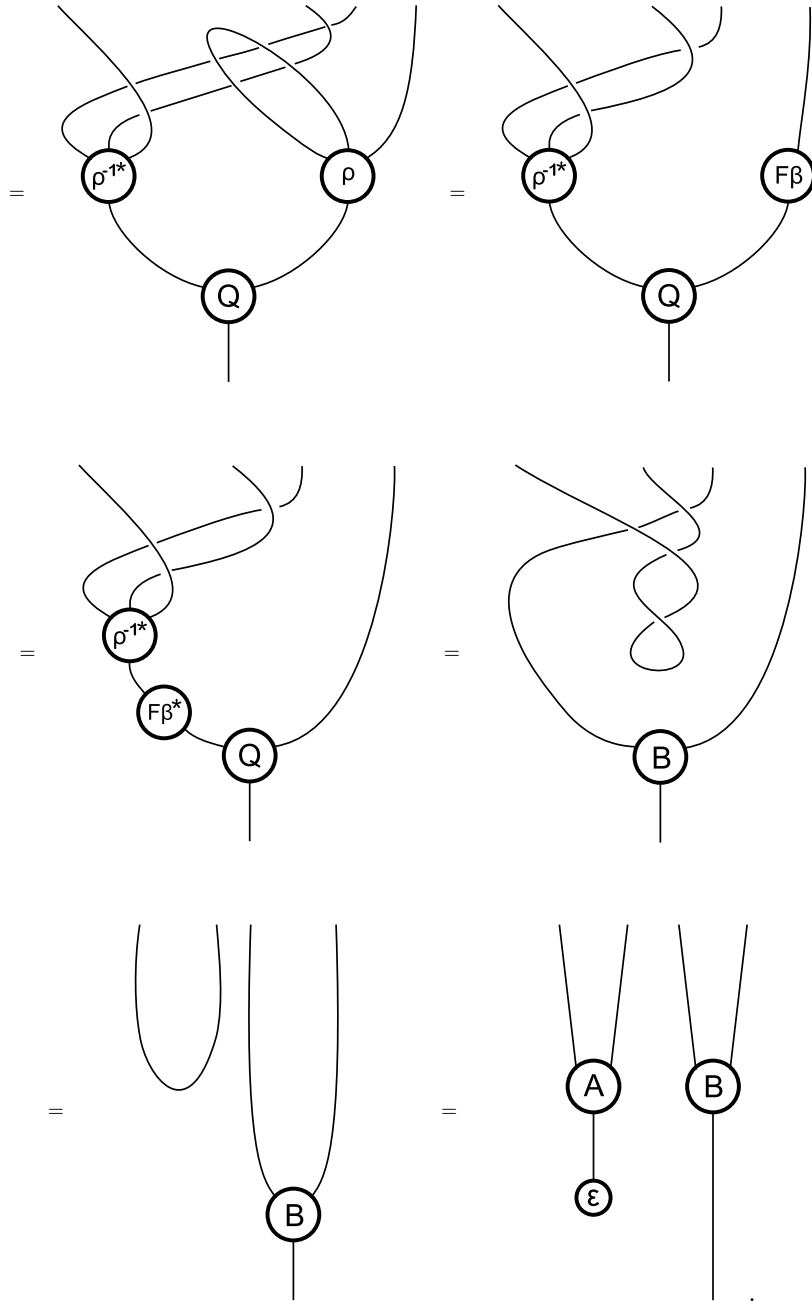

The one for comultiplying on the right is:

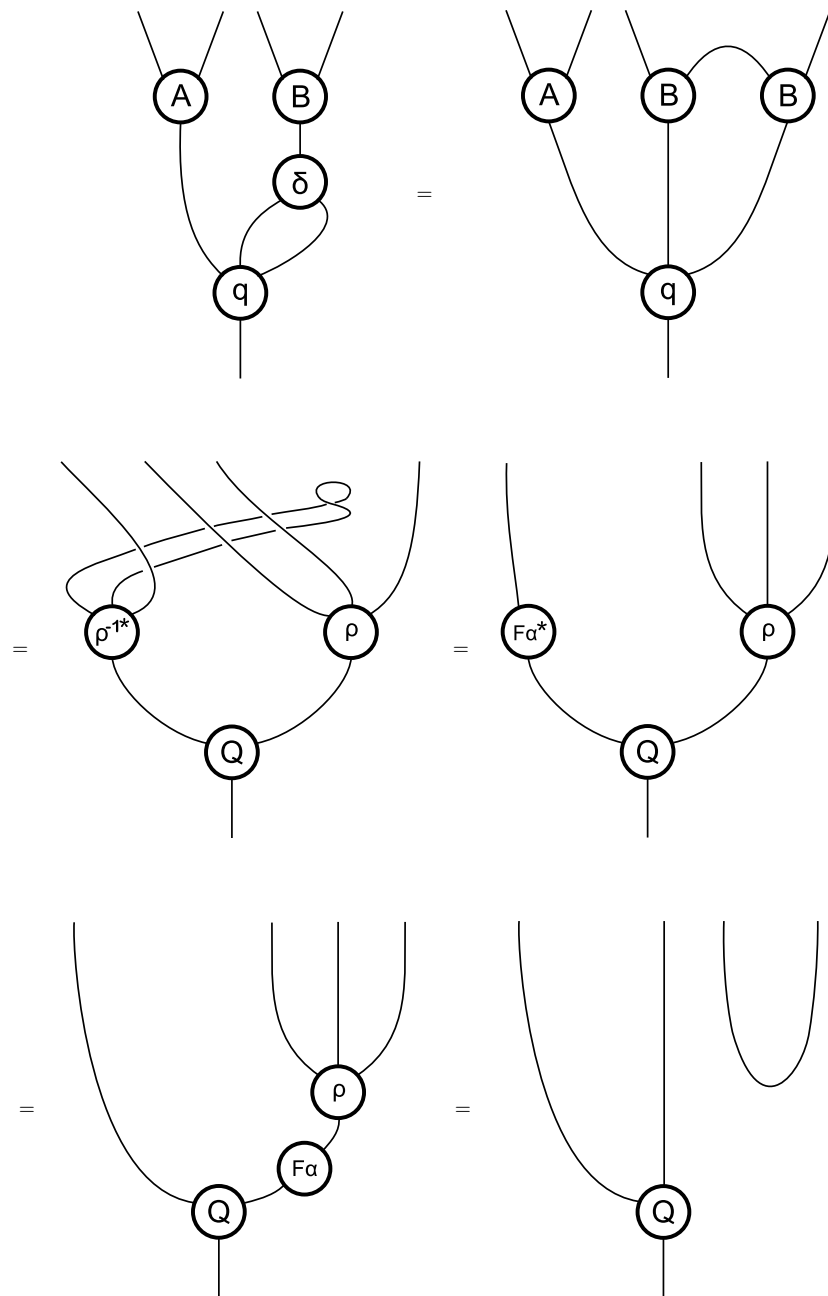

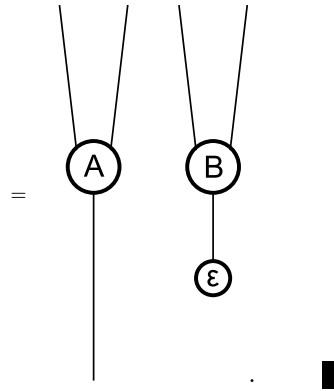

## 8 Appendix: Invertible Fusion Implies Antipode.

For completeness we provide a proof shown to us by Micah Blake McCurdy. This proof applies in any braided monoidal category. The result for Hopf algebras is classical.

**Proposition 10** *A bimonoid  $H$  is a Hopf monoid if and only if the fusion morphism (3.22) is invertible.*

**Proof** If  $H$  has an antipode  $\nu : H \rightarrow H$  denoted by a black node with one input and one output, define  $\bar{\nu}$  by

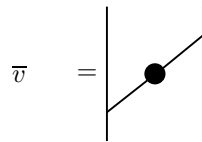

so that

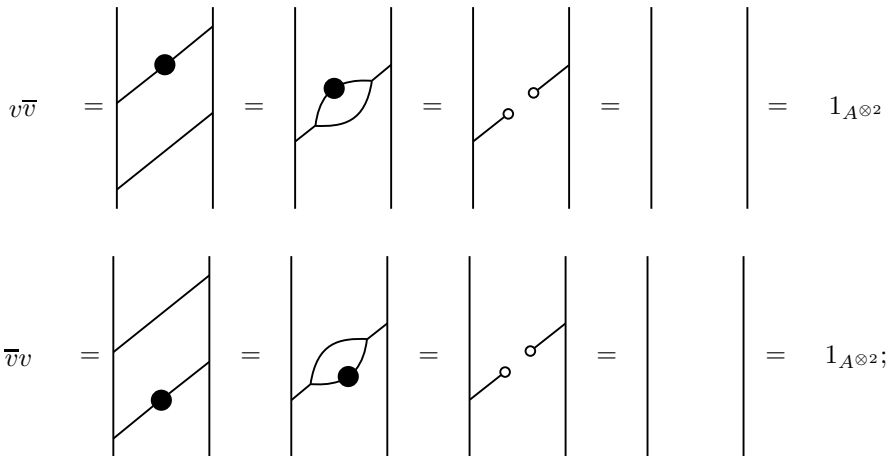

$\nu$  is invertible.

Conversely, (M.B. McCurdy) suppose  $v$  has an inverse  $\bar{v}$  denoted by a black node with two inputs and two outputs. Define  $\nu$  by

$$\nu = \begin{array}{c} \circ \\ \diagup \quad \diagdown \\ \bullet \\ \diagdown \quad \diagup \\ \circ \end{array}$$

We shall use

$$\begin{array}{ll} (i) \quad \begin{array}{ccc} A^{\otimes 3} & \xrightarrow{1 \otimes \bar{v}} & A^{\otimes 3} \\ \mu \otimes 1 \downarrow & & \downarrow \mu \otimes 1 \\ A^{\otimes 2} & \xrightarrow{\bar{v}} & A^{\otimes 2} \end{array} & (ii) \quad \begin{array}{ccc} A & \xrightarrow{\delta} & A^{\otimes 2} \\ \eta \otimes 1 \searrow & & \downarrow \bar{v} \\ & & A^{\otimes 2} \end{array} \\ (iii) \quad \begin{array}{ccc} A^{\otimes 2} & \xrightarrow{1 \otimes \delta} & A^{\otimes 3} \\ \bar{v} \downarrow & & \downarrow \bar{v} \otimes 1 \\ A^{\otimes 2} & \xrightarrow{1 \otimes \delta} & A^{\otimes 3} \end{array} & (iv) \quad \begin{array}{ccc} A^{\otimes 2} & \xrightarrow{\bar{v}} & A^{\otimes 2} \\ 1 \otimes \epsilon \searrow & & \downarrow \mu \\ & & A \end{array} \end{array}$$

which follow from the more obvious

$$\begin{array}{ll} (i)' & (\mu \otimes 1)(1 \otimes v) = v(\mu \otimes 1) \\ (ii)' & \delta = v(\eta \otimes 1) \\ (iii)' & (1 \otimes \delta)v = (v \otimes 1)(1 \otimes \delta) \\ (iv)' & \mu = (1 \otimes \epsilon)v \end{array}$$

which as strings are

$$\begin{array}{ll} (i)' & \begin{array}{ccc} \begin{array}{c} | \\ | \\ \diagdown \quad \diagup \\ | \end{array} & = & \begin{array}{c} \diagup \quad \diagdown \\ | \end{array} \end{array} & (ii)' & \begin{array}{ccc} \begin{array}{c} | \\ \diagdown \quad \diagup \\ | \end{array} & = & \begin{array}{c} \circ \\ | \end{array} \end{array} \\ (iii)' & \begin{array}{ccc} \begin{array}{c} | \\ \diagup \quad \diagdown \\ | \end{array} & = & \begin{array}{c} | \\ \diagdown \quad \diagup \\ | \end{array} \end{array} & (iv)' & \begin{array}{ccc} \begin{array}{c} \diagup \quad \diagdown \\ | \end{array} & = & \begin{array}{c} | \\ \diagdown \quad \diagup \\ \circ \end{array} \end{array} \end{array}$$

Now

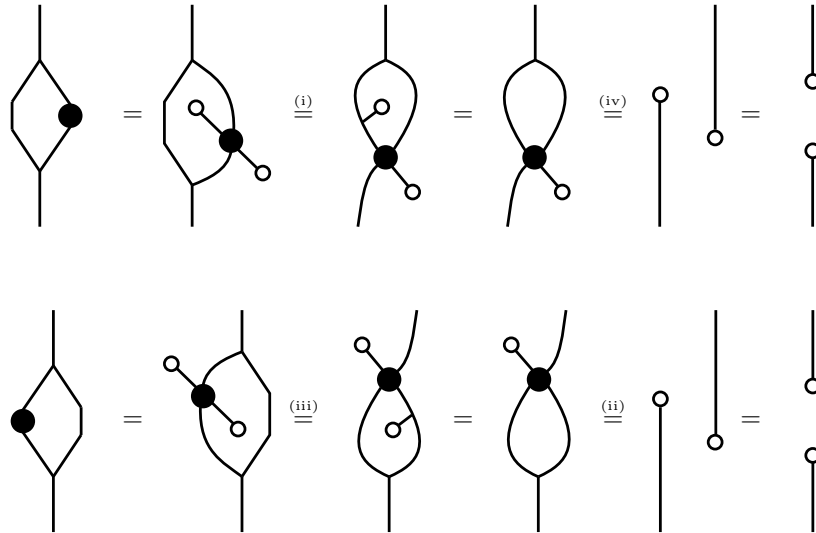

so that  $\nu$  is an antipode.  $\blacksquare$

## References

- [1] R. Baer, *Zur Einführung des Scharbegriffs*, Journal für die reine und angewandte Mathematik **160** (1929) 199–207.
- [2] T. Brzezinski and J. Vercruyssen, *Bimodule herds*, Journal of Algebra **321** (2009) 2670–2704.
- [3] W. Cherowitzo, T. Penttilä, I. Pinneri and G.F. Royle, *Flocks and ovals*, Geometriae Dedicata **60** (1996) 17–37.
- [4] B. Day, P. McCrudden and R. Street, *Dualizations and antipodes*, Applied Categorical Structures **11** (2003) 229–260.
- [5] B. Day and R. Street, *Monoidal bicategories and Hopf algebroids*, Advances in Mathematics **129** (1997) 99–157.
- [6] J. Giraud, *Cohomologie non abélienne*, Die Grundlehren der mathematischen Wissenschaften **179** (Springer-Verlag, Berlin-New York, 1971).
- [7] Cyril Grunspan, *Quantum torsors*, J. Pure Applied Algebra **184** (2003) 229–255.
- [8] P. T. Johnstone, *The ‘closed subgroup theorem’ for localic herds and pre-groupoids*, Journal of Pure and Applied Algebra **70** (1991) 97–106.

- [9] A. Joyal and R. Street, *An introduction to Tannaka duality and quantum groups*, ; Part II of Category Theory, Proceedings, Como 1990 (Editors A. Carboni, M.C. Pedicchio and G. Rosolini) Lecture Notes in Math. **1488** (Springer-Verlag Berlin, Heidelberg 1991) 411–492.
- [10] G. M. Kelly, *Basic concepts of enriched category theory*, London Mathematical Society Lecture Note Series **64** (Cambridge University Press, Cambridge, 1982). <http://www.tac.mta.ca/tac/reprints/articles/10/tr10.pdf>
- [11] M. Kontsevich, *Operads and motives in deformation quantization*, Letters in Mathematical Physics **48** (1999) 35–72. [arxiv.org/abs/math/9904055](http://arxiv.org/abs/math/9904055)
- [12] I. Lopez-Franco, R. Street and R. J. Wood, *Duals invert*, Applied Categorical Structures (accepted 8 September 2009; published online: 26 September 2009) (i)-(x)+40. <http://www.springerlink.com/content/u517174h46wm2313/>
- [13] H. Prüfer, *Theorie der Abelschen Gruppen. I. Grundeigenschaften*, Mathematische Zeitschrift **20** (1924) 165–187.
- [14] Zoran Škoda, *Quantum heaps, cops and heapy categories*, Mathematical Communications **12** (2007) 1–9.
- [15] Peter Schauenburg, *Braided bi-Galois theory*, Annali dell’Università di Ferrara - Sez. VII - Sc. Mat. **51** (2005) 119–149.
- [16] Peter Schauenburg, *Hopf-Galois and bi-Galois extensions*, in: “Galois theory, Hopf algebras, and semiabelian categories”, Fields Institute Communications **43** (Amer. Math. Soc. 2004) 469–515.
- [17] R. Street, *Quantum Groups: a path to current algebra*, Australian Mathematical Society Lecture Series **19** (Cambridge University Press, Cambridge, 2007). <http://www.cambridge.org/catalogue/catalogue.asp?isbn=0521695244>