

# Challenges in Accelerator Beam Instrumentation

M. Wendt  
 Fermi National Accelerator Laboratory, Batavia, IL 60510, USA

The challenges in beam instrumentation and diagnostics for present and future particle accelerator projects are presented. A few examples for advanced hadron and lepton beam diagnostics are given.

## 1. Motivation or “Why Beam Instrumentation?”

Any modern particle accelerator requires three core elements for beam acceleration: guide fields, accelerating fields and vacuum. The emphasis of every new accelerator project lies on these mission critical areas and the related technical components:

- Guide fields
  - Magnets – dipoles, quadrupoles, sextupoles, other multipoles,...
  - Correction / steering magnets
  - Power supplies
  - Cooling water, technical interlocks, ...sometimes cryogenics
- Accelerating fields(\$\$\$)
  - Cavities, waveguides, couplers
  - Klystrons, modulators, PFNs, HV-supplies
  - Interlocks, control systems, and again sometimes cryogenics!
- Vacuum
  - Pipes, pumps, flanges, etc., ...and a very clean environment!

While most of the beam characteristics are defined by these three elements, it would be difficult, perhaps impossible to verify the beam properties and further improve its quality without a sufficient set of beam diagnostics and instruments. These specialized beam instruments are the “ears” and “eyes” of the accelerator, and they provide only to way “watch” the beam, and allow to characterize its properties and quality.

During the design and construction phase of a typical particle accelerator project the focus is on the technical elements providing guide and accelerating fields, particular if superconducting technologies are involved. Once the machine hardware is in completed and the accelerator has to be commissioned with beam, the focus shifts to beam properties and quality, and the related beam instrumentation. During this beam commissioning phase, but also after major upgrades or modifications, a substantial set of well understood beam diagnostics is very important. The

instruments will help to spot errors (e.g. cabling, polarity, timing signals) and component failures (RF, magnets, power supplies, etc.). But the beam instruments itself may not be fully operational from day one, and often need test beam for internal tests and verification, thus the beam commissioning of the machine and the related beam diagnostics have to move forward hand in hand.

Once the beam instruments are fully operational and well understood in their performance and limitations, they can be used in a systematical way. The beam parameter(s) of interest are extracted from the measured signals – typically with help of digital signal processing technologies – acquired, collected, stored and sorted through the control system. Now the accelerator beam diagnostics is used to analyze and characterize the beam, and help to improve the properties and quality to the needs of the users.

The beam instrumentation can be seen as a detection element of a complex feedback system, with, and for some damping or orbit FB systems even without human integration. The measured beam parameters are compared with the simulations and give a better understanding of the accelerator hardware and beam dynamics, thus the core input to modify, improve and upgrade accelerator components and systems. Therefore, improvements of the beam quality or sophisticated /exotic beam properties require improvements and advances in the technology of the beam diagnostics.

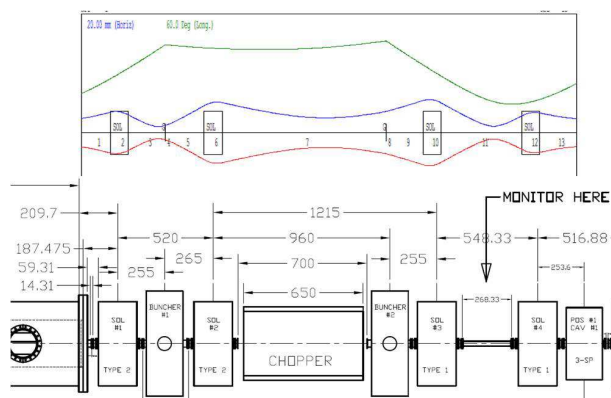

Figure 1: “Don’t forget beam diagnostics!”.

Fig. 1 shows the discrepancy between simulation exercise and “real world” needs for the medium energy beam transport (MEBT) of a  $H^-$ -beamline. Due to the space charge driven constraints the design gives only very little real estate for beam diagnostics. However, neither the given space will be sufficient to accommodate all the necessary instrumentation for beam intensity, orbit, phase, tr. and long. emittances, as well as beam halo and tails measurements, nor a single measurement location gives valuable information about the beam parameters along the beamline, like a simulation program does.

*Space for beam diagnostics* was and always will be an issues, therefore the design of beam pickups with minimum space requirements is crucial. Fig. 2 shows a stripline BPM pickup, embedded inside a quadrupole magnet, so it does not eat any additional space.

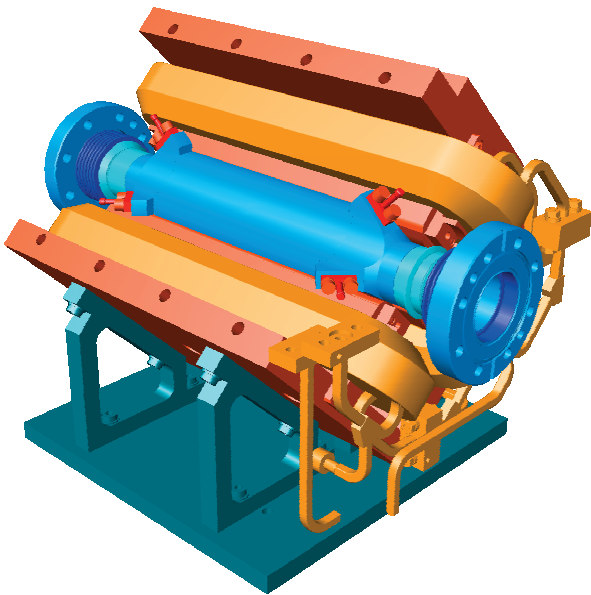

Figure 2: BPM pickup inside a quadrupole saves space!

## 2. Beam Instrumentation

Beam diagnostic and instrumentation systems are used for:

### 2.1. Beam Characterization

Most beam measurements and applications fall in this category:

#### 2.1.1. Beam intensity, bunch charge, beam current

This is the most fundamental property to be measured in a particle accelerator, i.e. how much beam

do we have in the machine? A *direct-current current-transformer* (DCCT) is able to measure the DC contents of the beam, while *toroidal transformers* can give information on the number of particles in a bunch. A *wall current transformer* provides a very high bandwidth (up to 10 GHz), and can be also used for long. bunch profile characterization (hadrons), as timing electrode, or for beam phase measurements.

#### 2.1.2. Beam position, orbit, phase, energy, betatron / synchrotron tune, chromaticity, etc.

The *beam position monitors* (BPM) are the most powerful – and most expensive – beam instrumentation system in a particle accelerator. Many BPM detectors are located along the beam-line, typically four or more per betatron oscillation period. The BPMs offer much more than just the measurement of the beam orbit, they are essential in almost every beam measurement, e.g. beam phase and energy, injection optimization, tune measurement, dynamic aperture and lattice function measurements, etc. During machine commissioning, but also later they are the most effective diagnostics for troubleshooting and error analysis. A *Schottky detector* is related to a BPM, but optimized to sense the finite number of particles in a beam in the frequency domain. The Schottky monitor can be used to measure beam tunes and emittances in a non-invasive way.

#### 2.1.3. Particle distribution, sliced beam / bunch parameters

There is a verity of methods, intercepting and non-intercepting, to measure the transverse or longitudinal beam profile, which leads to the beam emittance, e.g. wire-scanners or flying wires, secondary emission monitors (SEM) based on multi-wires or foils, screen monitors based on fluorescence or transition radiation, and different styles of non-invasive beam profile diagnostics (IPM, ODR, EOS, DMC, Schottky, laser wire, e-beam scanner, etc.).

#### 2.1.4. Beam losses, halo and tails

*Beam loss monitors* (BLM) are detection elements outside the vacuum chamber, which are sensitive to particle showers (scintillation, ionization). Similar to BPMs they are distributed along the beam-line, located at “strategic” locations, e.g. at the quadrupoles. Typically the BLMs are part of a complex machine protection system, which protects vacuum and other components from uncontrolled beam losses. In superconducting accelerators the latency of the BPM detection system is critical, to respond in time and prevent a quench or other major impacts. However, often BLMs are also used to fine tune the beam orbit or in other empirical machine optimization procedures. Some loss monitor systems (fiber optics based) allow a qualitative radiation dosimetry, other technologies

provide the total integrated loss along a beam-line (long ion chambers).

For high intensity beams, the monitoring of the transverse beam halo, and longitudinal beam tails is of great interest, as off-core particles tend to get lost along the beam-line. The vibrating-wire monitor (a temperature measurement) or other physical or laser wire methods provide these features.

## 2.2. Feedback Systems

Some beam monitors, typically BPM detectors, are used in automatic feedback systems (no human interface), e.g. orbit feedback, beam tune stabilization, damping of instabilities, etc. The feedback acts on magnets (quadrupoles), ejection and correction elements (kickers, beam damping electrodes), or on parts of the RF system (voltage), etc. The loop of slow (sec-range) feedback systems is usually closed through the data-acquisition and control system, particular if a deterministic response time is not critical. For fast feedback systems ( $\mu\text{sec} \dots \text{msec}$  range) the latency of each element is critical to prevent an instable operation. While the FB system is able to improve the stability in the pass-band frequency range, it may add unwanted noise outside the designed specifications.

## 2.3. Beam Monitors

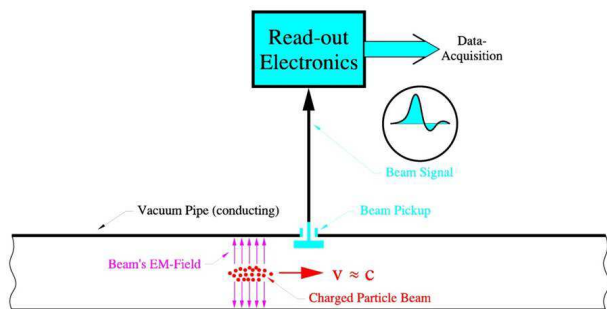

Figure 3: Principle of a beam monitor.

Figure 3 shows the simplistic principle of a typical beam monitor, consisting out of two major elements:

**Beam detector** Typically the beam detector is part of the vacuum system, and interacts with the beam in a non / minimum invasive or invasive way. As shown in the example (Fig. 3), the electromagnetic field of particle beam is sensed (here non-invasive) by the detector and converted into an electric signal. Other minimum-invasive detection methods are based on the scattering with the residual gas or photons, synchrotron radiation detection, laser stripping of electrons ( $\text{H}^-$ -beams), or other ways of electromagnetic interaction.

Invasive beam detectors use screen-, foil-, or wire-targets, and apply scintillation, secondary emission, or transition radiation principles. Cameras or charge detectors are used to convert to electrical signals.

**Read-out system** The beam property of interest is embedded in the electrical signal provided by the detector. The read-out system extracts this information, e.g. bunch intensity, beam displacement, etc., and converts it a digital format which is accepted by the data-acquisition part of the accelerator control system. A read-out system can be as simple as a diode detector, or a very complex VME-crate with many modules. The trend is to convert the analog output signal of the detector as early as possible into a digital format, and make use of mathematical methods to extract the wanted beam information. Typically this digital signal processing is performed in a field programmable gate array (FPGA), which operates in close connection to an analog-to-digital converter (ADC).

Beside these core signal processing elements, there are additional components, which are part of the read-out, acquisition & control system of a beam monitor, e.g. trigger, timing and control signals, power supplies, local control systems for switches, attenuators, motors and other motion control elements, cabling, internal interlocks and safety systems, etc.

## 3. Requirements & Challenges of Beam Diagnostics

The requirements in beam quality and properties to be measured, verified and controlled is challenging for any future HEP accelerator, like a super-B factory, a high intensity hadron accelerator, a lepton linear collider or a muon collider. Figure 4 shows the Compact Linear Collider (CLIC), proposed by CERN as the next HEP energy frontier lepton machine. The 3 TeV accelerator complex consists out of 96 km beam-lines, and needs almost 200.000(!) beam monitor and diagnostic devices to observe and control the beams. Just the pure number of beam instrumentation elements is impressive (taking about 10 % of the total costs), the requirements of most systems is very challenging, and at or beyond the current state-of-the-art.

The core requirements, e.g. resolution, reproducibility (and stability), linearity, dynamic range, etc., for most of the beam diagnostic systems are established by beam dynamics simulations. Other requirements and conditions are given by the available physical space, environment (radiation, temperature, remote location), or laboratory standards (data-acquisition formats, timing and trigger standards, rack and crate

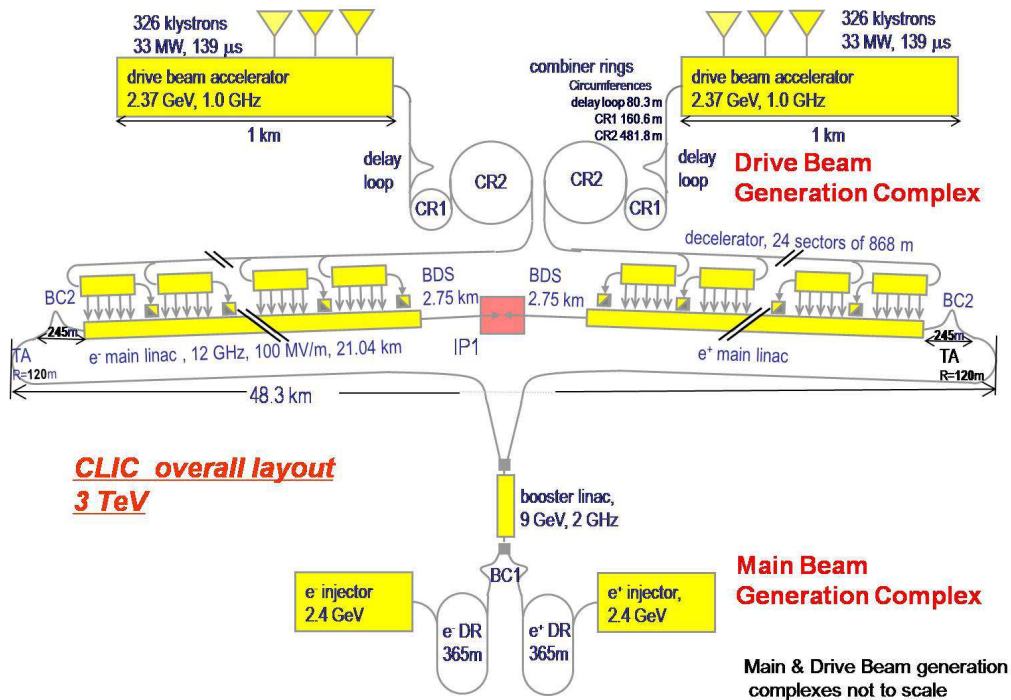

Figure 4: The Compact Linear Collider (CLIC) HEP accelerator proposal.

standards). For complex and operational important instrumentation systems the reliability plays a role.

Some key requirements for the beam diagnostics are rather different between lepton and hadron accelerators:

### 3.1. Lepton Accelerators – LCLS, XFEL, ILC, CLIC

- Observation and control of the longitudinal beam dynamics is the most challenging aspect for the beam instrumentation of these machines. The bunch length is in the 50... 500 fsec range, and requires very a high bandwidth (THz range) of the instruments to measure the longitudinal bunch profile.
- The BPM requirements are very challenging, i.e. a RMS resolution in the 50... 500 nm is needed, while the measurement (integration) time is in the 50... 500 nsec range.
- The large number of beam instruments (CLIC: 200.000 beam monitors, thereof 50.000 BPMs with sub-micrometer resolution) requires massive simplification (costs) and optimization for series production, testing, installation and system commissioning.

### 3.2. Hadron Accelerators – SNS, LHC, J-PARC, Project X, $\mu$ -Collider

- For hadron machines the high beam power, and the related damage potential is in the foreground. Therefore the focus is on non-invasive beam monitors (laser wire, e-beam scanner, IPM). Many beam instruments are part of the machine protection system, which require a high reliability and/or a sufficient redundancy of these devices.
- The mitigation of beam losses is crucial. The characterization/minimization of beam halo and tails in the low and medium energy beam transport (LEBT/MEBT) of these accelerators will prevent beam losses and activation in the high energy section of the machines.
- Special hadron beam diagnostics have to be established for the low-energy, non-relativistic parts of the accelerator. CW operation of hadron linacs will challenge the data-acquisition throughput and time stamping requirements.

## 4. Examples of Advanced Beam Instrumentation

### 4.1. High Resolution BPMs

To achieve a sufficient luminosity in the next generation linear collider (e.g. ILC, CLIC), the vertical RMS beam size at the IP has to be squeezed to just a few nm. This requires a very accurate observation and control of the beam orbit throughout the entire accelerator complex. High resolution ( $< 1 \mu\text{m}$ ) beam position monitors with single-pass, single-bunch measurement capability are a key requirement. Instead of sensing the mirror current distribution on the vacuum chamber, induced by the charged particle beam (indicated in Fig. 3), a beam excited dipole eigenmode ( $\text{TM}_{110}$ ) of a passive resonant cavity gives an intrinsic higher sensitivity to the beam displacement (Fig. 5).

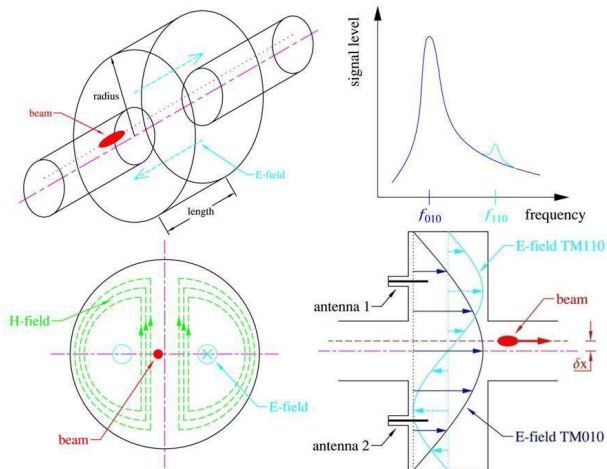

Figure 5: High resolution resonant cavity BPM principle.

The resolution “world-record” is currently held by an Asian team of beam instrumentation experts. Based on a common-mode free C-Band ( $\approx 6 \text{ GHz}$ ) rectangular cavity design a resolution of 8.7 nm could be verified by beam measurements!

### 4.2. Digital Signal Processing

Beam orbit and damping systems gained the high-profit from recent advances in the area of digital signal processing. The generation and preservation of a low vertical emittance lepton beam is a key element of any version of the next linear HEP collider, and is mainly defined in the damping ring. High resolution beam position monitors, based on simple “button” style electrodes, allow to steer the beam along a “golden” orbit, with minimum non-linear field effects. The required signal processing technology has two elements

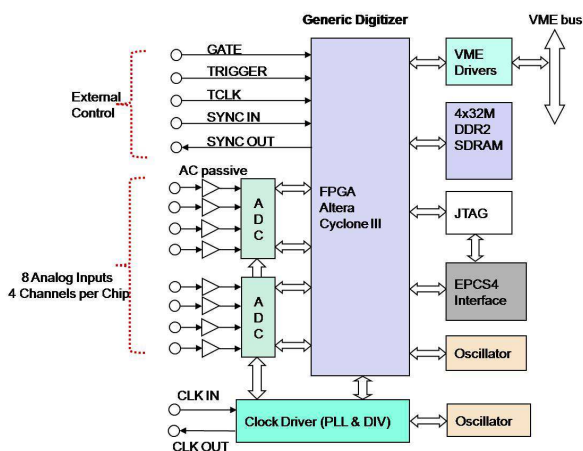

Figure 6: Block diagram of a digitizer.

**Hardware** A versatile digitizer, based on fast analog-to-digital converters (ADC, typically 100-500 MSPS, 12-16 bit), a large field programmable gate array (FPGA) which holds all digital signal processing elements, and a low-jitter (10-500 fsec) timing and clock signal distribution system. Figure 6 shows the block diagram of a VME digitizer.

**Firmware** The FPGA firmware is used to downconvert, filter and decimate the data to extract the required beam position or orbit information. Typical digital building blocks are numerically controlled oscillators (NCO), downconverters (mixer), filters (FIR, IIR, CIC, etc.), delays, memory, mathematical functions, etc., even a complete microcomputer can be utilized. Figure 7 shows the narrowband signal processing section for a damping ring BPM system, which has a resolution potential of 100-200 nm.

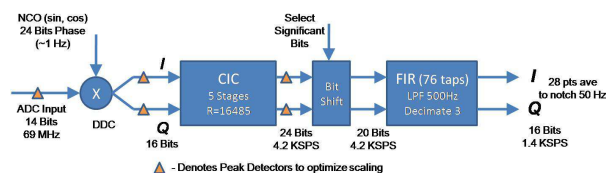

Figure 7: Narrowband BPM signal processing.

### 4.3. Optical Beam Diagnostics

Most optical beam diagnostics are based on laser systems, and profit from the availability of short (fsec range) laser pulses, in which the laser is mode-locked to the accelerator RF.

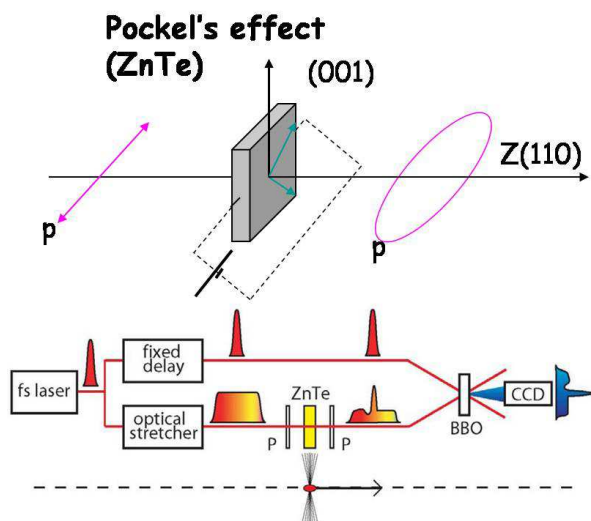

Figure 8: *Upper*: Pockel's cell effect.  
*Lower*: Spectral-decoding electro-optical sampling.

#### 4.3.1. Electro-Optical Sampling (EOS)

The longitudinal bunch profile of relativistic bunches can be measured in a non-invasive manner with the *electro-optical sampling* (EOS) technique. Key element is a ZnTe crystal (*Pockels* cell), which alters the polarization of the transmitted laser light, while exposed to an electric field (upper part of Fig. 8). In an EOS setup the *Pockels* cell is located inside the vacuum chamber, and sees the EM-field of the bunched beam, which alters the polarization of chirped laser pulse – imprinting its longitudinal profile. The lower part of Figure 8 shows the details of this so-called “spectral decoding” EOS technique, which allows the single path profile measurement of ultra-short bunches (resolution in the 50-500 fsec range).

#### 4.3.2. Laser wire

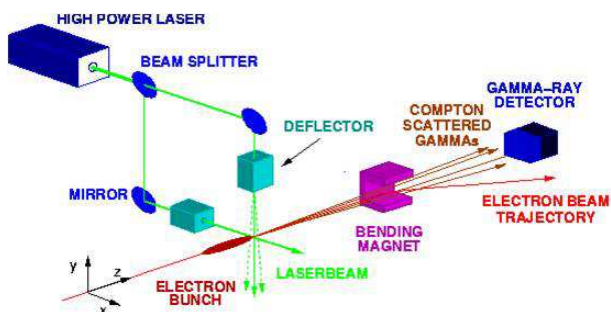
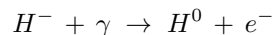

Figure 9: Laser wire for lepton beams (compton scattering).

The laser wire allows a non-invasive measurement of the transverse beam profile. A thin physical wire scanning an electron or  $H^-$  beam is replaced by a focused laser beam (Fig. 9), thus no wire heating or damage in case of high beam intensities, and no fragile wire setup. In case of an  $H^-$  beam, the weakly bounded electrons (0.75 eV) are stripped:



and with help of a dipole magnet separated from the  $H^-$  beam for detection (*Faraday-cup*, scintillator-PMT, etc.).

To enhance the resolution of the laser wire, i.e. to analyze sub-micrometer beam-sizes, the laser beam can be operated at a higher moment in an optical cavity. Experiments demonstrated a resolution of  $4.3 \mu\text{m}$ , operating a laser beam of  $9.6 \mu\text{m}$  RMS size in the  $TEM_{01}$  (dipole) mode.

## 4.4. Other Advanced Beam Diagnostics

Beside the few examples given, the a large variety of advanced beam diagnostics is available to better understand the beam parameters, identify deficiencies, locate errors and improve the beam quality.

**Transition or diffraction radiation** is used in the infrared, or optical domain to characterize lepton beam / bunch parameters, e.g. transverse profile, bunch length / profile, beam divergence / emittance, etc. The detection techniques, operating in the THz range (*Golay*-cells, “pyro”-detectors), include interferometric methods (*Michelson*, *Martin-Puplett*).

**Electron Beam Scanner** is a non-invasive approach to measure the beam profile of a high intensity proton beam, i.e. scanning an e-beam through the p-beam and detect the deflection effect. A different non-invasive method is based on the ionization of the residual gas, the **ionization profile monitor** (IPM).

**HOM, e-Cloud** We can utilize some beam detectors in “other” ways, e.g. we can use a set of two BPMs to measure the *electron cloud* effect or instability under high beam intensities, we can use the *HOM-coupler signals* of a RF accelerating structure to measure the beam displacement (or cavity alignment) to a few  $\mu\text{m}$ , or the beam phase to  $0.1^\circ$ , and there are more examples of “parasitic” beam diagnostics.