

SUPERMATRIX MODELS, LOOP EQUATIONS, AND DUALITY

PATRICK DESROSIERS AND BERTRAND EYNARD

ABSTRACT. We study integrals over Hermitian supermatrices of arbitrary size $p + q$, that are parametrized by an external field X and a source Y , of respective size $m + n$ and $p + q$. We show that these integrals exhibit a simple topological expansion in powers of a formal parameter \hbar , which can be identified with $1/(p - q)$. The loop equation and the associated spectral curve are also obtained. The solutions to the loop equation are given in terms of the symplectic invariants introduced in [10]. The symmetry property of the latter objects allows us to prove a duality that relates supermatrix models in which the role of X and Y are interchanged.

CONTENTS

1. Introduction	2
2. Topological expansion	3
3. Loop equations	15
3.1. Schwinger-Dyson equations	15
3.2. Loop equations for the supermatrix model in an external field	17
3.3. Spectral curve	18
4. Gaussian model with sources and external fields	20
4.1. Spectral curve	20
4.2. Geometry of the spectral curve	20
4.3. Poles	21
5. Duality	22
6. Conclusion	23
Acknowledgments	24
Appendix A. Grassmann variables	24
Appendix B. Supermatrices	25
References	26

2000 *Mathematics Subject Classification.* 15A52, 14H70, 05C30.

Key words and phrases. Matrix models, Supermatrices, Algebraic curves, Duality.
IPhT-t09/163.

1. INTRODUCTION

In this article, we study supermatrix integrals that include an external field. We first prove that they can be expanded topologically. We then write their loop equations, and show that they are the same as for usual matrix integrals, and therefore, they have the same solution. In other words, super-matrix integrals' topological expansion is given by the symplectic invariants of [10]. As a consequence, we prove a duality which generalizes that of [4, 7]. Namely, we define (notations are explained below)

$$Z_{(m|n),(p|q)}(X, Y) = \frac{e^{-\frac{1}{2\hbar} \text{str} Y^2}}{z_{p,q}(\hbar)} \int_{H(p|q)} dM e^{-\frac{1}{2\hbar} \text{str}(IM)^2} e^{\frac{1}{\hbar} \text{str} IMY} \frac{\prod_{i=1}^m \text{sdet}(x_i - IM)}{\prod_{i=m+1}^{m+n} \text{sdet}(x_i - M)} \quad (1.1)$$

and we show that, if X and Y diagonal with complex entries,

$$Z_{(m|n),(p|q)}(X, Y) = Z_{(p|q),(m|n)}(Y, X) \quad (1.2)$$

for all $m, n, p, q \geq 0$. Note that the matrix integrals $Z_{(m|n),(p|q)}(X, Y)$ and $Z_{(p|q),(m|n)}(Y, X)$ share the same formal parameter \hbar . The duality exchanges the size of the matrix with the number of sources, and it exchanges the external field Y of size $p + q$, with the sources X of size $m + n$.

Let us be more explicit. The ensemble $H(p|q)$ of hermitian supermatrices of size $p + q$, is the set of matrices of the form:

$$M = \begin{pmatrix} A & B \\ C & D \end{pmatrix} \quad (1.3)$$

where A and D are hermitian matrices of respective size $p \times p$ and $q \times q$, and B and $C = B^\dagger$ are fermionic matrices (entries are Grassmann anti-commuting variables) of respective size $p \times q$ and $q \times p$. A Hermitian supermatrix can be diagonalized by an element of $U(p|q)$, the supergroup of unitary transformations. For a short review of the theory of Grassmann algebras and supermatrices, see Appendices A and B, which are based on references [3, 13, 8].

Consider P , a complex-valued function depending upon an Hermitian supermatrix M . Its expectation value with Gaussian measure in $H(p|q)$ is defined by

$$\langle P(M) \rangle_{M \in GU(p|q)} = \int_{H(p|q)} dM e^{-\frac{1}{2\hbar} \text{str}(IM)^2} P(IM) / \int dM e^{-\frac{1}{2\hbar} \text{str}(IM)^2} \quad (1.4)$$

where str is the supertrace and I is a supermatrix which ensures the convergence of the integral. We choose

$$I = \text{diag}(\overbrace{1, \dots, 1}^p, \overbrace{i, \dots, i}^q) \quad (1.5)$$

so that I is an element of $U(p|q)$, the supergroup of unitary transformations.

Our aim is to study the partition function of Gaussian supermatrix models containing sources x_j as well as an external field Y :

$$Z_{(m|n),(p|q)}(X, Y) = e^{-\frac{1}{2\hbar} \text{str} Y^2} \left\langle e^{\frac{1}{\hbar} \text{str} MY} \prod_{i=1}^{m+n} \text{sdet}(x_i - M)^{\sigma(i)} \right\rangle_{M \in GU(p|q)}. \quad (1.6)$$

In the last equation, X stands for a Hermitian supermatrix of size $m + n$ with eigenvalues x_j (possibly not all distinct), so that $x_i - M$ is understood as the matrix whose element in the j th row and k th column is equal to $x_i \delta_{jk} - M_{jk}$, while

$$\sigma(i) = \sigma_{m,n}(i) = \begin{cases} +1 & \text{if } i \in \{1, \dots, m\}, \\ -1 & \text{if } i \in \{m + 1, \dots, m + n\}. \end{cases} \quad (1.7)$$

It is worth mentioning that models involving hermitian supermatrix have been studied in the past. For instance, Itzykson-Zuber and character formulas for $U(n|m)$ have been obtained in [1]. This had been preceded, in the beginning of the 1990s, by a few attempts to generalize the well known connection between conventional matrix models and quantum gravity in 2D [2, 6, 18]. It was soon realized however that supermatrix models could not provide a discrete version of supergravity.¹ Especially, convincing arguments were given for the equivalence between supermatrix and matrix models when no external fields are involved [2].

Here we indeed prove, in the first section, that we can formally map the partition function of a matrix model to that of supermatrix model. It should be understood that this bijection remains true as long as the models are interpreted as linear combination of expectation values with respect to the Gaussian measure, like in Eq. (2.35), and as long as all the matrices' size and entries are considered as parameters. When considering the models from a more general perspective, based on algebraic geometry, the relation between matrix and supermatrix problems becomes more subtle. In particular, we show that supermatrix models possess new critical behaviors and enjoy more symmetry. Especially, we will prove the following duality property given in Eq. (1.2).

2. TOPOLOGICAL EXPANSION

Here we show that the expectation value of powers of superstraces have a simple interpretation in terms of ribbon graphs (also called fatgraphs). This naturally leads to the conclusion that the partition function for a matrix model of hermitian $(p+q) \times (p+q)$ supermatrices that contains an external field is similar to the partition function for the usual hermitian matrix model with an external field. As shown below, the formal power series expansion in \hbar^2 of the supermatrix integrals is of topological nature. This property will allow us, in section 3.3, to exploit the uniqueness of the solution to the loop equations.

Proposition 1. *Let y and Y be a $N \times N$ Hermitian matrix and a $(p+q) \times (p+q)$ Hermitian supermatrix, respectively. Define the map ϕ as²*

$$\phi(\text{tr } y^n) = \text{str } Y^n \quad \forall n \geq 0. \quad (2.1)$$

¹Note that other routes have been followed for describing supergravity as a matrix models, such as the formal supereigenvalue models (see [17] for a review) and matrix model in superspace such as the Marinari-Parisi model (see [14] and references therein).

²The function ϕ can be used only when the matrix y and the supermatrix Y as well as their respective sizes, are considered as parameters. We cannot for instance set $N = 2$ and $y = \text{diag}(1, 1)$ and then apply ϕ . In fact, ϕ is a homomorphism that maps of the algebra of the symmetric polynomials in the eigenvalues of y to the subalgebra of the polynomials which symmetric in two set of eigenvalues of Y , y_1, \dots, y_p and y_{p+1}, \dots, y_{p+q} , that becomes independent of y_p if $y_p = y_{p+q}$. In general ϕ is not invertible.

Note in particular that the case $n = 0$ corresponds to $\phi(N) = p - q$. Then

$$\left\langle \prod_i \text{str } M^{n_i} e^{\text{str } MY} \right\rangle_{M \in GU(p|q)} = \phi \left(\left\langle \prod_i \text{tr } m^{n_i} e^{\text{tr } my} \right\rangle_{m \in GU(N)} \right). \quad (2.2)$$

Corollary 2. *Let g be a natural number and $p_n = \hbar \text{str } Y^n$, where Y is a Hermitian supermatrix of size $p + q$. Let moreover $F = F_{(m|n),(p|q)}(X, Y)$ be the free energy of the supermatrix model whose partition function is $Z = Z_{(m|n),(p|q)}(X, Y)$; that is, $F = -\ln Z$. Then, the following formal power series holds*

$$F = \sum_{g \geq 0} \hbar^{2g-2} F^{(g)}(p_1, p_2, \dots). \quad (2.3)$$

The latter results are in fact obvious reformulations of Theorem 8, which will be proved in the following paragraphs.

Proposition 3. *One has*

$$e^{-\frac{\hbar}{2} \text{str } Y^2} \left\langle M_{i_1 j_1} \cdots M_{i_n j_n} e^{\text{str } MY} \right\rangle_{M \in GU(p|q)} = \left(\sigma(j_1) \frac{\partial}{\partial Y_{j_1 i_1}} + \hbar Y_{i_1 j_1} \right) \circ \cdots \circ \left(\sigma(j_n) \frac{\partial}{\partial Y_{j_n i_n}} + \hbar Y_{i_n j_n} \right) \circ 1. \quad (2.4)$$

Proof. By definition we have simply

$$\left\langle M_{i_1 j_1} \cdots M_{i_n j_n} e^{\text{str } MY} \right\rangle = \frac{\int dM e^{-\frac{1}{2\hbar} \text{str}(IM)^2} e^{\text{str } IMY} (IM)_{i_1 j_1} \cdots (IM)_{i_n j_n}}{\int dM e^{-\frac{1}{2\hbar} \text{str}(IM)^2}} \quad (2.5)$$

But a few manipulations give

$$e^{\text{str } IMY} (IM)_{ij} = \sigma(j) \frac{\partial}{\partial Y_{ji}} e^{\text{str } IMY} \quad (2.6)$$

so that

$$\begin{aligned} \left\langle M_{i_1 j_1} \cdots M_{i_n j_n} e^{\text{str } MY} \right\rangle &= \\ \sigma(j_1) \frac{\partial}{\partial Y_{j_1 i_1}} \cdots \sigma(j_n) \frac{\partial}{\partial Y_{j_n i_n}} \frac{\int dM e^{-\frac{1}{2\hbar} \text{str}(IM)^2} e^{\text{str } IMY}}{\int dM e^{-\frac{1}{2\hbar} \text{str}(IM)^2}} &= \\ \sigma(j_1) \frac{\partial}{\partial Y_{j_1 i_1}} \cdots \sigma(j_n) \frac{\partial}{\partial Y_{j_n i_n}} \left\langle e^{\text{str } MY} \right\rangle & \quad (2.7) \end{aligned}$$

Note that the order of the derivatives is important. We now make use of the Gaussian integral formula (B.15) and obtain:

$$\left\langle M_{i_1 j_1} \cdots M_{i_n j_n} e^{\text{str } MY} \right\rangle = \sigma(j_1) \frac{\partial}{\partial Y_{j_1 i_1}} \cdots \sigma(j_n) \frac{\partial}{\partial Y_{j_n i_n}} e^{\frac{\hbar}{2} \text{str } Y^2} \quad (2.8)$$

Finally, we note that

$$e^{-\frac{\hbar}{2} \text{str } Y^2} \frac{\partial}{\partial Y_{ij}} e^{\frac{\hbar}{2} \text{str } Y^2} = \frac{\partial}{\partial Y_{ij}} + \hbar \sigma(i) Y_{ji} \quad (2.9)$$

and the proposition follows. \square

We now wish to evaluate the expectation value of products of matrix elements by means of a simple generalization of ribbon graphs. We define a ribbon graph of order n as a sequence of n vertices graphically represented as half-edges $\uparrow\downarrow$ and ordered from left to right on an horizontal axis. Each half-edge $\uparrow\downarrow$ is labeled by a pair $i\downarrow j$ of positive integers. Moreover, a vertex $\uparrow\downarrow$ can be connected to at most one other vertex as long as the orientation of the arrows is respected; the connection of two half-edges produces an edge. Fig.1 gives an example of a ribbon graph of order 6 and labeled by i_1j_1, \dots, i_6j_6 .

FIGURE 1. A ribbon graph with 2 edges and 2 half-edges

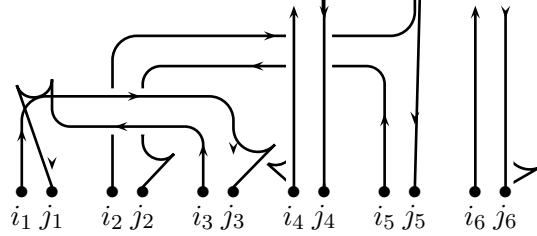

Any collection of independent graphs, $\{G_1, G_2, \dots\}$, will be written as a sum $G_1 + G_2 + \dots$. The concatenation (or union) of two independent graphs, G_1 and G_2 , gives another graph $G = G_1G_2$. For instance, if

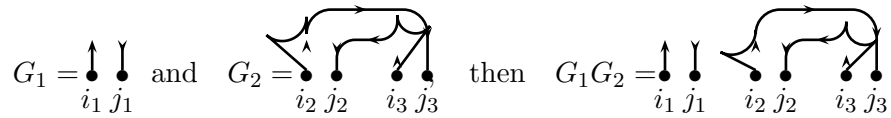

In order to take into account the presence of Grassmann odd variables, we need to equip the vertices with the following \mathbb{Z}_2 -grading: The half-edge labeled by $i\downarrow j$ has degree $\epsilon_i + \epsilon_j$, where ϵ_i is defined by $\sigma(i) = (-1)^{\epsilon_i}$, that is

$$\epsilon_i = \epsilon(i) = \begin{cases} 0 & \text{if } i \in \{1, \dots, p\}, \\ 1 & \text{if } i \in \{p + 1, \dots, p + q\}. \end{cases} \quad (2.10)$$

The total degree of a graph or a subgraph G is equal to the sum of the degrees of all the half-edges contained in G ; that is, if G can be separated into two independent subgraphs as $G = G_1G_2$, then $\text{deg } G = \text{deg } G_1 + \text{deg } G_2$ and the connection between half-edges doesn't affect their degree.

FIGURE 2. Weight function W on the basic constituents (or propagators) of ribbon graphs.

$$W \begin{array}{c} \uparrow \quad \downarrow \\ | \quad | \\ \bullet \quad \bullet \\ i_1 \quad j_1 \end{array} = \hbar Y_{i_1 j_1} \quad W \begin{array}{c} \uparrow \quad \downarrow \\ \uparrow \quad \downarrow \\ | \quad | \\ \bullet \quad \bullet \\ i_1 \quad j_1 \end{array} = \sigma(j_1) \frac{\partial}{\partial Y_{j_1 i_1}} (\hbar Y_{i_2 j_2}) = \hbar \sigma(j_1) \delta_{i_1 j_2} \delta_{j_1 i_2}$$

We now introduce a weight function W on graded ribbon graphs whose values belong to a Grassmann algebra over \mathbb{C} . We first set $W(\emptyset) = 0$, where \emptyset stands for the empty graph. Then

FIGURE 4. Weight W associated to a crossing of ribbons. The signum depends on the degree of each ribbon, that is, $\epsilon = (\epsilon_{i_1} + \epsilon_{j_1})(\epsilon_{i_2} + \epsilon_{j_2})$.

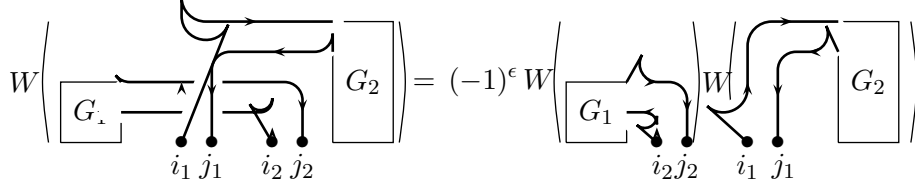

plus all distinct graphs obtained from the latter by connecting at least 2 half-edges and at most n or $n - 1$ of them, depending on whether n is even or odd, respectively. Then

$$e^{-\frac{\hbar}{2} \text{str } Y^2} \left\langle M_{i_1 j_1} \cdots M_{i_n j_n} e^{\text{str } MY} \right\rangle_{M \in GU(p|q)} = W(\Sigma G)$$

Proof. Let G be an arbitrary ribbon graph and let $1 = \text{id}$ be the left identity operator on graphs, which means $1 \circ G = G$. We introduce A_{ij} , a noncommutative operator acting on G by creating a half-edge, labeled by ij , to the left of G . Obviously, the graph O_n given in Eq.(2.13) can be written as $A_{i_1 j_1} \cdots A_{i_n j_n} \emptyset$. Let also $B_{ij,kl}$ be a noncommutative operator acting on G by connecting the half-edge labeled by ij to that labeled by kl , the first half-edge being located to the left of the second. We consider B_{ij} as a nilpotent operator, which means $B_{ij}^2 G = \emptyset$, and set $B_{ij,kl} G = \emptyset$ if G doesn't contain a half-edge labeled by ij (or kl) or if all half-edges ij (or kl) in G are already connected. Thus, every ribbon graph of degree n can be uniquely written as a polynomial in operators $B_{i,j}$ acting from the left on $O_n = A_{i_1 j_1} \cdots A_{i_n j_n} \emptyset$. In particular, the sum ΣG of all graphs obtained from O_n by connecting the half-edges in all possible ways, is given by

$$\begin{aligned} \Sigma G &= (1 + B_{i_1 j_1, i_2 j_2})(1 + B_{i_1 j_1, i_3 j_3}) \cdots (1 + B_{i_1 j_1, i_n j_n}) \\ &\quad \circ (1 + B_{i_2 j_2, i_3 j_3}) \cdots (1 + B_{i_2 j_2, i_n j_n}) \cdots (1 + B_{i_{n-1} j_{n-1}, i_n j_n}) O_n. \end{aligned} \quad (2.14)$$

From the properties of the connection operators B , we can simplify the latter expression as follows:

$$\begin{aligned} \Sigma G &= (1 + B_{i_1 j_1, i_2 j_2} + B_{i_1 j_1, i_3 j_3} \cdots B_{i_1 j_1, i_n j_n}) \\ &\quad \circ (1 + B_{i_2 j_2, i_3 j_3} + \cdots + B_{i_2 j_2, i_n j_n}) \cdots (1 + B_{i_{n-1} j_{n-1}, i_n j_n}) O_n. \end{aligned} \quad (2.15)$$

Now we consider the action weight function on the graph ΣG . We first note that

$$W\left(\sum_{\ell > k} B_{i_k j_k, i_\ell j_\ell} O_n\right) = W(A_{i_1 j_1} \cdots A_{i_{k-1} j_{k-1}}) \cdot W\left(\sum_{\ell > k} B_{i_k j_k, i_\ell j_\ell} A_{i_1 j_1} \cdots A_{i_n j_n} \emptyset\right).$$

The latter formula and Eq.(2.15) then imply

$$\begin{aligned} W(\Sigma G) &= W\left((1 + B_{i_1 j_1, i_2 j_2} + B_{i_1 j_1, i_3 j_3} \cdots B_{i_1 j_1, i_n j_n}) A_{i_1 j_1} \right. \\ &\quad \left. \circ (1 + B_{i_2 j_2, i_3 j_3} + \cdots + B_{i_2 j_2, i_n j_n}) A_{i_2 j_2} \cdots (1 + B_{i_{n-1} j_{n-1}, i_n j_n}) A_{i_n j_n} \emptyset\right), \end{aligned} \quad (2.16)$$

Using the fact that $\sum_{\ell > k} B_{i_k j_k, i_\ell j_\ell} A_{i_k j_k} G = \sum_{\ell \neq k} B_{i_k j_k, i_\ell j_\ell} A_{i_k j_k} G$ when G doesn't contain half-edges labeled by $i_\ell j_\ell$ such that $\ell < k$, we get

$$W(\Sigma G) = W(D_{i_1 j_1} \cdots D_{i_n j_n} \emptyset), \quad D_{i_k j_k} = A_{i_k j_k} + \sum_{\ell \neq k} B_{i_k j_k, i_\ell j_\ell} A_{i_k j_k}, \quad (2.17)$$

which corresponds the successive concatenation of a half-edge followed by its connection (or not) to all possible half-edges contained in the graph on its right. By making use of the commutation rules of Fig.3 and 4, one easily verifies that

$$W(\Sigma G) = W(\cdots D_{i_k j_k} D_{i_\ell j_\ell} \cdots \emptyset) = (-1)^{(\epsilon_{i_k} + \epsilon_{j_k})(\epsilon_{i_\ell} + \epsilon_{j_\ell})} W(\cdots D_{i_\ell j_\ell} D_{i_k j_k} \cdots \emptyset)$$

and

$$W(D_{i_k j_k} D_{i_{k+1} j_{k+1}} \cdots D_{i_n j_n} \emptyset) = \left(\hbar Y_{i_k j_k} + \sigma(j_k) \frac{\partial}{\partial Y_{j_k i_k}} \right) \circ W(D_{i_{k+1} j_{k+1}} \cdots D_{i_n j_n} \emptyset).$$

Thus by induction,

$$W(\Sigma G) = \left(\hbar Y_{i_1 j_1} + \sigma(j_1) \frac{\partial}{\partial Y_{j_1 i_1}} \right) \circ \cdots \circ \left(\hbar Y_{i_n j_n} + \sigma(j_n) \frac{\partial}{\partial Y_{j_n i_n}} \right) \circ 1,$$

and the proposition follows from the comparison of the latter equation and Lemma 3. \square

An immediate consequence of the latter result is a graded version of the Wick formula, which, in the context of matrix models, allows to express the correlation of $2k$ matrix elements in terms of a sum of monomials involving k correlations of 2 elements.

In order to present the formula in a compact form, we need to introduce some more notations. Let $a = (a_1, \dots, a_k)$ and $b = (b_1, \dots, b_k)$ be two disjoint increasing sequences of integers in $\{1, \dots, 2k\}$. By $\mathcal{P}_{a,b} = \{(i_{a_1} j_{a_1}, i_{b_1} j_{b_1}), \dots, (i_{a_k} j_{a_k}, i_{b_k} j_{b_k})\}$ we denote a set of pairings of the indices $i_1 j_1, \dots, i_{2k} j_{2k}$. Let $\pi_{a,b} \in S_{2k}$ be the permutation such that

$$(a_1, b_1, \dots, a_k, b_k) = \pi_{a,b}(1, 2, \dots, 2k - 1, 2k).$$

Define the signum of $\pi_{a,b}$ by

$$M_{i_1 j_1} \cdots M_{i_{2k} j_{2k}} = \text{sgn}(\pi_{a,b}) M_{i_{a_1} j_{a_1}} M_{i_{b_1} j_{b_1}} \cdots M_{i_{a_k} j_{a_k}} M_{i_{b_k} j_{b_k}}.$$

Corollary 5. *Let $\langle M_{i_1 j_1} \cdots M_{i_n j_n} \rangle$ denote the expectation value given by the left-hand-side Eq.(2.4) with $Y = 0$. Then,*

$$\langle M_{i_k j_k} M_{i_\ell j_\ell} \rangle = \hbar \sigma(j_k) \delta_{i_k, j_\ell} \delta_{j_j, i_\ell}.$$

Moreover, if k is a nonnegative integer,

$$\begin{aligned} \langle M_{i_1 j_1} \cdots M_{i_{2k+1} j_{2k+1}} \rangle &= 0 \\ \langle M_{i_1 j_1} \cdots M_{i_n j_n} \rangle &= \sum \text{sgn}(\pi_{a,b}) \langle M_{i_{a_1} j_{a_1}} M_{i_{b_1} j_{b_1}} \rangle \cdots \langle M_{i_{a_k} j_{a_k}} M_{i_{b_k} j_{b_k}} \rangle, \end{aligned} \quad (2.18)$$

where the sum runs over all distinct sets of pairings $\mathcal{P}_{a,b}$ of $i_1 j_1, \dots, i_{2k} j_{2k}$.

We are ready to turn our attention to the expectation value of products of supertraces. From Proposition 4 and the definition of the supertrace, we know that

$$e^{-\frac{\hbar}{2} \text{str } Y^2} \left\langle \text{str } M^n e^{\text{str } MY} \right\rangle_{M \in GU(p|q)} = \sum_{1 \leq i_1, \dots, i_n \leq p+q} \sigma(i_1) W(\Sigma T), \quad (2.19)$$

where ΣT denotes the sum of all distinct graphs that we can get by connecting by pairs the half-edges of the following graph:

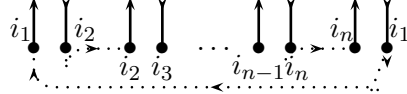
(2.20)

Note that dotted arrows $i_k \rightarrow i_k$ have been used in order to ease the identification of components that share a same index. We set $W(i_k \rightarrow i_k) = 1$. A ribbon graph or a subgraph T is said to be of trace-type if it is labeled like the graph in Eq.(2.20), which means that its indices follow the pattern

$$i_k i_{k+1}, \quad i_{k+1} i_{k+2}, \quad i_{k+2} i_{k+3}, \quad \dots, \quad i_{k+\ell} i_k.$$

The degree of a graph of trace-type depends only on the degree of the first and last labels, for the intermediate indices are always repeated. In other words, if T is of trace-type,

$$\deg \left(\begin{array}{|c|} \hline T \\ \hline \bullet \quad \bullet \\ i_k \quad i_\ell \\ \hline \end{array} \right) = \epsilon_{i_k} + \epsilon_{i_\ell} \quad (2.21)$$

Notice that we adopt the following convention: if T_j is an empty subgraph of a trace-type graph, then

$$\begin{array}{|c|} \hline T_j \\ \hline \bullet \quad \bullet \\ i_k \quad i_k \\ \hline \end{array} = i_k \rightarrow i_k \quad (2.22)$$

so that the weight of T_j is equal to one.

In order to calculate the contribution of graphs of trace type, we need to establish a few rules that allow to decompose a graph in its independent parts. From the definition of the weight W and Eq.(2.21), we see that if T_1 and T_2 stand for 2 subgraphs of trace type (independent or not), then

$$W \left(\begin{array}{|c|} \hline T_1 \quad T_2 \\ \hline \bullet \quad \bullet \quad \bullet \quad \bullet \\ i_k \quad i_\ell \quad i_\ell \quad i_m \\ \hline \end{array} \right) = (-1)^{(\epsilon_k + \epsilon_\ell)(\epsilon_\ell + \epsilon_m)} W \left(\begin{array}{|c|} \hline T_2 \quad T_1 \\ \hline \bullet \quad \bullet \quad \bullet \quad \bullet \\ i_\ell \quad i_m \quad i_k \quad i_\ell \\ \hline \end{array} \right) \quad (2.23)$$

Moreover,

$$W \left(\begin{array}{|c|} \hline \text{Diagram with } T_2 \text{ and linking edges} \\ \hline \bullet \quad \bullet \quad \bullet \quad \bullet \\ i_k \quad i_{k+1} \quad i_\ell \quad i_{\ell+1} \\ \hline \end{array} \right) \neq 0 \implies i_\ell = i_{k+1}, \quad i_{\ell+1} = i_k; \quad (2.24)$$

This in turn implies that the previous subgraph has a nonzero contribution only if both T_2 and the edge linking $i_k i_{k+1}$ and $i_\ell i_{\ell+1}$ has a degree equal to zero. In other words, these subgraphs contribute only if they are bosonic, so that we can commute all components of that type when evaluating the weight. By making use of equations (2.21),(5), (2.24) and the fact that $(-1)^{(\epsilon_k + \epsilon_\ell)(\epsilon_k + \epsilon_\ell)} = (-1)^{(\epsilon_k + \epsilon_\ell)}$, one can establish the following.

Lemma 6. *Let T_1, \dots, T_5 be trace-type ribbon graphs that may be dependent or not. Then the equations given in Figures 5, 6, and 7 hold.*

Let us consider a few examples in relation to the expectation value of $\text{str } M^n$. First of all, one easily verifies that the contribution of the trace-type graph of Eq.(2.20) is equal

FIGURE 5. Commutation of trace type ribbon graphs

$$\sigma(i_1) W \left(\begin{array}{c} \boxed{T_1} \quad \boxed{T_2} \\ \bullet_{i_1} \quad \bullet_{i_\ell} \quad \bullet_{i_\ell} \quad \bullet_{i_1} \end{array} \right) = \sigma(i_\ell) W \left(\begin{array}{c} \boxed{T_2} \quad \boxed{T_1} \\ \bullet_{i_\ell} \quad \bullet_{i_1} \quad \bullet_{i_1} \quad \bullet_{i_\ell} \end{array} \right)$$

FIGURE 6. Effect of an edge on trace-type ribbon graphs

$$\sum_{i_\ell, i_{\ell+1}} W \left(\begin{array}{c} \boxed{T_1} \quad \boxed{T_2} \quad \boxed{T_3} \\ \bullet_{i_1} \quad \bullet_{i_k} \quad \bullet_{i_{k+1}} \quad \bullet_{i_\ell} \quad \bullet_{i_{\ell+1}} \quad \bullet_{i_1} \end{array} \right) = \hbar \sigma(i_{k+1}) W \left(\begin{array}{c} \boxed{T_1} \quad \boxed{T_3} \quad \boxed{T_2} \\ \bullet_{i_1} \quad \bullet_{i_k} \quad \bullet_{i_1} \quad \bullet_{i_{k+1}} \quad \bullet_{i_{k+1}} \end{array} \right)$$

FIGURE 7. Effect of crossing edges on trace-type ribbon graphs

$$\sum_{\substack{i_p, i_{p+1} \\ i_q, i_{q+1}}} W \left(\begin{array}{c} \boxed{T_1} \quad \boxed{T_2} \quad \boxed{T_3} \quad \boxed{T_4} \quad \boxed{T_5} \\ \bullet_{i_1} \quad \bullet_{i_k} \quad \bullet_{i_{k+1}} \quad \bullet_{i_\ell} \quad \bullet_{i_{\ell+1}} \quad \bullet_{i_p} \quad \bullet_{i_{p+1}} \quad \bullet_{i_q} \quad \bullet_{i_{q+1}} \quad \bullet_{i_1} \end{array} \right) = \hbar^2 W \left(\begin{array}{c} \boxed{T_1} \quad \boxed{T_4} \quad \boxed{T_3} \quad \boxed{T_2} \quad \boxed{T_5} \\ \bullet_{i_1} \quad \bullet_{i_k} \quad \bullet_{i_{\ell+1}} \quad \bullet_{i_{k+1}} \quad \bullet_{i_\ell} \quad \bullet_{i_1} \end{array} \right)$$

to $\hbar Y_{i_1 i_2} \hbar Y_{i_2 i_3} \cdots \hbar Y_{i_n i_1}$, so summing over all the indices as in Eq.(2.19) leads to $\text{str}(\hbar Y)^n$. Consider next the contribution of a graph with one edge:

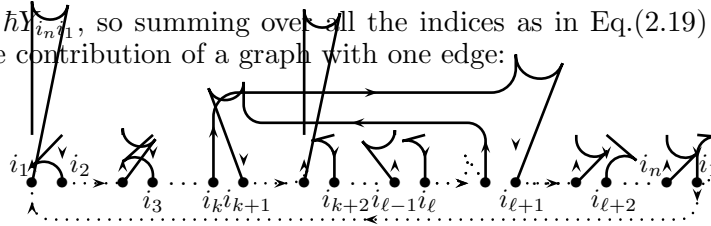

From Fig.6, we conclude if T_2 is equal to a sequence of non-connected half-edges of trace-type, then

$$\sum_{i_{k+1}, \dots, i_{\ell+1}} W \left(\begin{array}{c} \boxed{T_1} \quad \boxed{T_2} \quad \boxed{T_3} \\ \bullet_{i_1} \quad \bullet_{i_k} \quad \bullet_{i_{k+1}} \quad \bullet_{i_\ell} \quad \bullet_{i_{\ell+1}} \quad \bullet_{i_1} \end{array} \right) = \hbar \text{str}(\hbar Y)^{\ell-k-1} W \left(\begin{array}{c} \boxed{T_1} \quad \boxed{T_3} \\ \bullet_{i_1} \quad \bullet_{i_k} \quad \bullet_{i_1} \end{array} \right).$$

Note that in the case where $\ell = k + 1$, which corresponds to graph with a closed loop labeled by i_{k+1} , the previous formula remains valid if we interpret $\text{str}(\hbar Y)^{\ell-k-1}$ as $\text{str} \mathbf{1} = p - q$. We then conclude that the total contribution to the expectation value of $\text{str} M^n$ of all labeled

graphs $T_{k\ell}$ as in Eq.(2), with one edge linking the half-edges $i_k i_{k+1}$ and $i_\ell i_{\ell+1}$, is

$$\sum_{i_1, \dots, i_n} \sigma(i_1) W(T_{k\ell}) = \hbar \operatorname{str}(\hbar Y)^{n+k-\ell-1} \operatorname{str}(\hbar Y)^{\ell-k-1}.$$

The ribbon graph $T_{15,27,36}$ given in Fig.8 is more complicated since the calculation of its contribution to the expectation of $\operatorname{str} M^8$ requires the use of the three rules given in Figures 5, 6, and 7. One gets

$$\sum_{1 \leq i_1, \dots, i_8 \leq p+q} \sigma(i_1) W(T_{15,27,36}) = \hbar^3 (p-q) \operatorname{str}(\hbar Y)^2.$$

The different factors in the last equation can be understood as follows: the 3 edges create a \hbar^3 ; $p-q$ comes from the loop starting at i_3 ; $\operatorname{str}(\hbar Y)^2$ is obtained when considering the two non-connected half-edges.

FIGURE 8. Possible ribbon graph associated to $\langle \operatorname{str} M^8 \rangle$

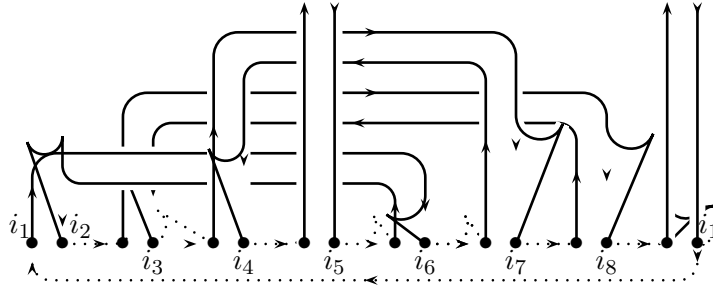

The previous discussion suggests that the weight associated to the sum over the indices of a trace-type ribbon graph depends only \hbar and supertraces of the form $\operatorname{str}(\hbar Y)^m$, which includes the contribution $\operatorname{str}(\hbar Y)^0 = \operatorname{str} \mathbf{1} = p-q$. It is indeed the case since Lema 6 implies that when reordering the subgraphs correctly, the only signs that appear in the total weight are factors of the form $\sigma(i_k)$, each of them associated to an independent trace-type subgraph. This means that each independent subgraph produces a factor $p-q$ if it is empty while it produces a factor $\operatorname{str}(\hbar Y)^n$ if it is made of n non-connected half-edges. Moreover, each edge produce a factor \hbar .

We can go further by defining a face of a trace-type ribbon graph as the region contained inside a loop, which is a closed path that follows the arrows (including the dotted arrow). Note that a face can contain an independent subgraph that contains non-connected half-edges. For instance, the graph given in Fig.8 has two faces: the first is delimited by the path $i_1 \rightarrow i_6 \rightarrow i_4 \rightarrow i_5 \rightarrow i_2 \rightarrow i_8 \rightarrow i_1$; the second is found by following the path $i_3 \rightarrow i_7 \rightarrow i_3$. By making use of Lemma 6, we conclude that each face, when summing over all the indices, carries a weight of $\operatorname{str}(\hbar Y)^m$, where $m \geq 0$ corresponds to the number of non-connected half-edges. The weight of the whole graph is given by the product of the weights associated to the edges and the faces. Thus, if the labeled trace-type ribbon-graph T that contains $n-m$ edges and F faces f_i , each of them including $m_i \geq 0$ non-connected half-edges,

$$\sum_{i_1, \dots, i_n} \sigma(i_1) W(T) = \hbar^n \prod_{i=1}^F \operatorname{str}(\hbar Y)^{m_i} \tag{2.25}$$

Now define $m = \sum_i m_n$ as the total number of non-connected half-edges in T .

Obviously, to any trace-type ribbon graph T with $n - m$ edges, m half-edges, F faces and labeled by the integers i_1, \dots, i_n , we can associate a connected ribbon graph Γ , called a fatgraph star, with F faces, $V = 1 + m$ vertices, and $E = n$ edges labeled from 1 to n . Note that in the star Γ , all the points carrying the indices of T are considered as forming a unique vertex while the m non-connected half-edges of T are interpreted as being connected to m distinct vertices, so that the total number of vertices in Γ is $1 + m$. For example, the fatgraph star associated to the trace-type ribbon graph of Fig.8 is given in Fig. 9. It is a classical result that any connected graph with F faces, E edges, and V vertices, can be embedded on a surface of genus (at least) g in a way that guaranties that the edges don't cross (except at the vertices) if g is given by the following expression of the Euler characteristic [15]:

$$\chi = V + F - E = 2 - 2g \quad (2.26)$$

Thus, if T is a trace-type ribbon graph with m non-connected half-edges, $n - m$ edges, and F faces,

$$\hbar^{-1} \sum_{i_1, \dots, i_n} \sigma(i_1) W(T) = \hbar^{n-m-1-F} \prod_{i=1}^F \hbar \operatorname{str}(\hbar Y)^{m_i} \quad (2.27)$$

which yields, when $E = n$ and $V = 1 + m$,

$$\hbar^{-1} \sum_{i_1, \dots, i_n} \sigma(i_1) W(T) = \hbar^{E-V-F} \prod_{i=1}^F \hbar \operatorname{str}(\hbar Y)^{m_i} = \hbar^{-2+2g} \prod_{i=1}^F \hbar \operatorname{str}(\hbar Y)^{m_i} \quad (2.28)$$

Going back to Eq.(2.19), we conclude that if

$$\bar{Y} = \hbar Y, \quad p_{m_i} = \hbar \operatorname{str} \bar{Y}^{m_i}, \quad (2.29)$$

then

$$e^{-\frac{1}{2\hbar^2} p_2} \left\langle \frac{1}{\hbar} \operatorname{str} M^n e^{\frac{1}{\hbar} \operatorname{str} M \bar{Y}} \right\rangle_{M \in GU(p|q)} = \sum_{\Gamma} \hbar^{-2+2g} \prod_i p_{m_i}. \quad (2.30)$$

where the sum runs over all connected fatgraph stars Γ with one n -valent vertex, m univalent vertices and F faces, each face containing m_i edges connected to m_i distinct vertices.

Any correlation of product of supertraces $\operatorname{str} M^n$ can be evaluated with the help of a simple generalization the combinatorial method exposed above. Indeed, Proposition 4 implies that

$$\begin{aligned} e^{-\frac{1}{2\hbar} \operatorname{str} \bar{Y}^2} \left\langle \prod_{k=1}^d \frac{1}{\hbar} \operatorname{str} M^{n_k} e^{\frac{1}{\hbar} \operatorname{str} M \bar{Y}} \right\rangle_{M \in GU(p|q)} \\ = \sum_{1 \leq k \leq d} \sum_{1 \leq i_1^k, \dots, i_{n_k}^k \leq p+q} \sigma(i_1) \cdots \sigma(i_d) W(\Sigma T^{n_1} \cdots T^{n_d}) \end{aligned} \quad (2.31)$$

where $\Sigma T^{n_1} \cdots T^{n_d}$ stands for the sum of all possible ribbon graphs that can be obtained by connecting (partially or totally) the half-edges contained in the following concatenation of d trace-type ribbon graphs (cf. Eq.2.20):

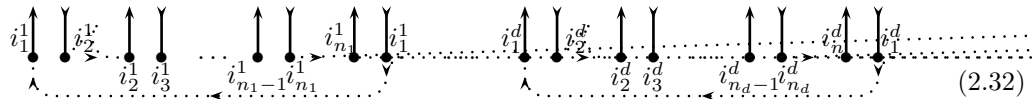
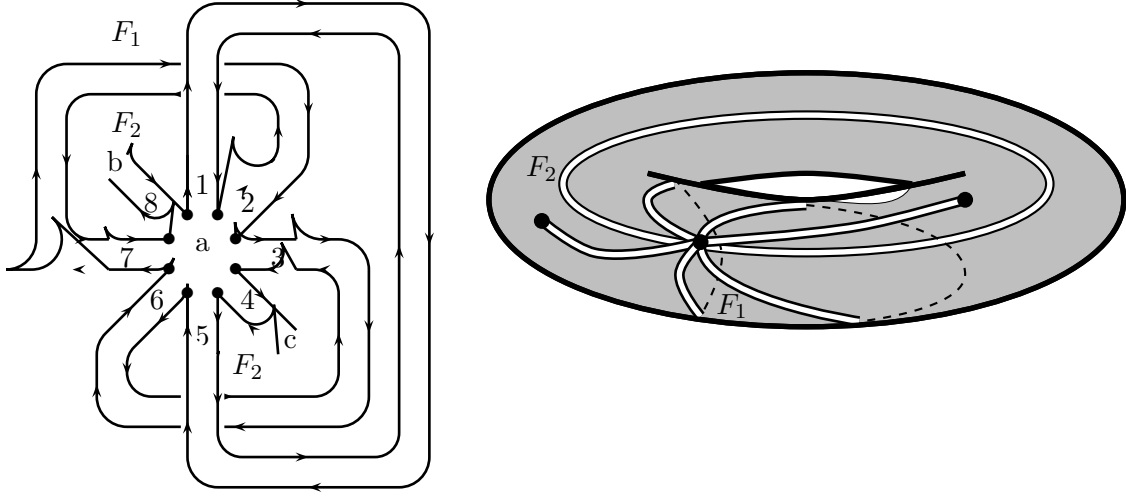

FIGURE 9. The star fatgraph associated to the ribbon graph of Fig. 8. The half-edges are labeled from 1 to 8. The graph contains $V = 3$ vertices (denoted a, b, c), $F = 2$ faces (denoted F_1, F_2), and $E = 5$ edges. As shown on the right-hand side, it can be embedded on compact surface of genus $g = (E - F - V + 2)/2 = 1$.



In the last equation, the i th independent subgraph has valency n_i . The connection process may produce a minimum of 0 and a maximum of d non-connected trace-type ribbon graphs. The use of Lemma 6 allows to eliminate the sum over the indices i_ℓ^k and leads to the following proposition which establish that any correlation function as an expansion in terms of $(p - q)^{-2}$ and supertraces of the external field Y .

Theorem 7. Let $p_n = \hbar \text{str } Y^n$, where Y denotes a Hermitian supermatrix of size $p + q$. Suppose that Γ is a star fatgraph with d labeled vertices, each of them having a valency n_i , and define $E = \sum_{i=1}^d n_i$. Suppose moreover that Γ contains δ non-connected subgraphs Γ_i . Define the number of faces in Γ as $F = \sum_{i=1}^{\delta} f_i$, where f_i is equal to the the number of faces in Γ_i . Finally, let m_i stand for the number of non-connected half-edges in the i th face of Γ and $V = d + \sum_{i=1}^F m_i$. Then

$$\left\langle \prod_{k=1}^d \frac{1}{\hbar} \text{str } M^{n_k} e^{\frac{1}{\hbar} \text{str } MY} \right\rangle_{M \in GU(p|q)} = e^{\frac{1}{2\hbar^2} p^2} \sum_{\Gamma} \hbar^{E-V-F} \prod_{i=1}^F p_{m_i} \quad (2.33)$$

where the sum extends over all possible (connected or not) star fatgraphs Γ . Moreover, $V + F - E = 2 - 2g(\Gamma)$, where $g(\Gamma) = \sum_{i=1}^{\delta} g_i$ and where g_i denotes the minimal genus of the compact surface on which the graph Γ_i can be embedded.

We remark that if $\hbar = (p - q)^{-1}$, then the polynomial $p_0 = 1$. In that case, the previous theorem directly implies that when the external field is zero, the correlation functions of a Gaussian supermatrix model are equivalent to that of a Gaussian model involving a $N \times N$ matrix if one identifies \hbar with N .

Corollary 8. *Let $\hbar = (p - q)^{-1}$ and let $n = \sum_k n_k$ be an even integer. Then, with the notation explained above,*

$$\left\langle \prod_{k=1}^d \frac{1}{\hbar} \text{str} M^{n_k} e^{\frac{1}{\hbar} \text{str} MY} \right\rangle_{M \in GU(p|q)} = \sum_{\Gamma} \hbar^{2g(\Gamma)-2} \quad (2.34)$$

where the sum extends over all possible (connected or not) star fatgraphs Γ in which the n half-edges are all connected by pairs.

Let us make a last remark regarding the partition of the one-supermatrix model

$$\mathcal{Z}_{(p|q)}(t_1, t_2, \dots) = \left\langle e^{-\sum_{k \geq 1} \frac{t_k}{k} \text{str} M^k} \right\rangle_{M \in GU(p|q)} \quad (2.35)$$

This is the usual form of the generating function considered for the enumeration of maps. As explained in [7], partition functions of one-matrix models, when considering the t_k as formal parameters (thus, not as complex numbers), are equivalent to the expectation value of products of characteristic polynomials in Gaussian ensembles. This is easily generalized to the supermatrix case.

Proposition 9. *Let $S = \text{diag}(s_i)$ be an arbitrary diagonal supermatrix of size (possibly infinite) $p' + q'$. Moreover, set*

$$t_k = \gamma \text{str} S^{-k} = \gamma \sum_{i=1}^{p'} s_i^{-k} - \gamma \sum_{i=p'+1}^{q'} s_i^{-k} \quad (2.36)$$

where γ is a complex parameter. Then, as long as the t_k s are kept arbitrary, one formally has

$$\mathcal{Z}_{(p|q)}(t_1, t_2, \dots) = (\text{sdet} S)^{\gamma(q-p)} \left\langle \frac{\prod_{j=1}^{p'} \text{sdet}(s_j - M)^\gamma}{\prod_{k=p'+1}^{p'+q'} \text{sdet}(s_k - M)^\gamma} \right\rangle_{M \in GU(p|q)} \quad (2.37)$$

Proof. First, suppose that the eigenvalues of M are $(\lambda_1, \dots, \lambda_p, \lambda_{p+1}, \dots, \lambda_{p+q})$, so the eigenvalues of IM are $(\lambda_1, \dots, \lambda_p, i\lambda_{p+1}, \dots, i\lambda_{p+q})$. Second, formally expand $\sum_{k \geq 1} t_k \text{str} M^k / k$ in terms of the eigenvalues and get

$$\frac{\prod_{j=1}^{p'} s_j^{\gamma(p-q)}}{\prod_{j=p'+1}^{p'+q'} s_j^{\gamma(p-q)}} \exp \left(- \sum_{k \geq 1} \frac{t_k}{k} \text{str} M^k \right) = \frac{\prod_{i=1}^p \prod_{j=1}^{p'} (s_j - \lambda_i)^\gamma \prod_{i=p+1}^{p+q} \prod_{j=p'+1}^{p'+q'} (s_j - i\lambda_i)^\gamma}{\prod_{i=1}^p \prod_{j=p'+1}^{p'+q'} (s_j - \lambda_i)^\gamma \prod_{i=p+1}^{p+q} \prod_{j=1}^{p'} (s_j - i\lambda_i)^\gamma}. \quad (2.38)$$

We can rewrite the last equation as

$$\exp \left(- \sum_{k \geq 1} \frac{t_k}{k} \text{str} M^k \right) = (\text{sdet} S)^{\gamma(q-p)} \frac{\prod_{j=1}^{p'} \text{sdet}(s_j - IM)^\gamma}{\prod_{j=p'+1}^{p'+q'} \text{sdet}(s_j - IM)^\gamma} \quad (2.39)$$

and the proposition follows. \square

3. LOOP EQUATIONS

In this section, we show that supermatrix models obey the same loop equations (Schwinger-Dyson equations) as usual matrix models. Since the solution of loop equations of usual matrix models is known order by order in \hbar , in terms of invariants of a spectral curve [10], then this also gives the solution for supermatrix models. The only novelty, is that supermatrix models can have more general spectral curves than usual matrix models.

3.1. Schwinger-Dyson equations. Schwinger-Dyson equations are called loop equations in the context of matrix models. They merely proceed from the invariance of an integral under changes of variables.

Let us consider the change of variables $f : M \mapsto M'$. The measure transforms according to the following rule [3]:

$$dM' = J(M', M)dM = \text{sdet} \left(\frac{\partial M'}{\partial M} \right) dM \quad (3.1)$$

J is the Berezinian, which is a generalisation of the Jacobian. Note that in the last equation, $\partial M'/\partial M$ is a supermatrix of size $(p+q)^2$ when the size of M is $p+q$. For instance, if

$$M = \begin{pmatrix} a & b \\ b^* & d \end{pmatrix} \quad \text{and} \quad M' = \begin{pmatrix} \alpha & \beta \\ \beta^* & \delta \end{pmatrix} \quad (3.2)$$

then

$$\frac{\partial M'}{\partial M} = \begin{pmatrix} \frac{\partial \alpha}{\partial a} & \frac{\partial \delta}{\partial a} & \frac{\partial \beta}{\partial a} & \frac{\partial \beta^*}{\partial a} \\ \frac{\partial \alpha}{\partial \alpha} & \frac{\partial \delta}{\partial \alpha} & \frac{\partial \beta}{\partial \alpha} & \frac{\partial \beta^*}{\partial \alpha} \\ \frac{\partial \alpha}{\partial d} & \frac{\partial \delta}{\partial d} & \frac{\partial \beta}{\partial d} & \frac{\partial \beta^*}{\partial d} \\ \frac{\partial \alpha}{\partial b} & \frac{\partial \delta}{\partial b} & \frac{\partial \beta}{\partial b} & \frac{\partial \beta^*}{\partial b} \\ \frac{\partial \alpha}{\partial b^*} & \frac{\partial \delta}{\partial b^*} & \frac{\partial \beta}{\partial b^*} & \frac{\partial \beta^*}{\partial b^*} \end{pmatrix} \quad (3.3)$$

Now suppose that the transformation f is infinitesimal, that is

$$f(M) = M' = M + \epsilon g(M) + O(\epsilon^2), \quad (3.4)$$

for $\epsilon \ll 1$. By virtue of $\text{sdet } M = \exp(\text{str } \ln M)$, we get

$$J(M', M) = 1 + \epsilon K(M) + O(\epsilon^2) \quad (3.5)$$

where

$$K(M) = \text{str} \left(\frac{\partial g(M)}{\partial M} \right). \quad (3.6)$$

Lemma 10. *Let A , B , and C be supermatrices of the same type than M . Suppose that*

$$g(M) = A \frac{1}{x - BM} C. \quad (3.7)$$

Then we have the “splitting rule”

$$K(M) = \text{str} \left(A \frac{1}{x - BM} B \right) \text{str} \left(\frac{1}{x - BM} C \right). \quad (3.8)$$

Proof. Firstly, we consider $g_1(M) = AMB$. According to Eq. (3.5),

$$K_1(M) = \text{str} \left(\frac{\partial}{\partial M} AMB \right) = \sum_{i,j} \sigma(i)\sigma(j) \frac{\partial}{\partial M_{ij}} (AMB)_{ij} \quad (3.9)$$

that is

$$K_1(M) = \sum_{i,j} \sigma(i)\sigma(j)A_{ii}B_{jj} = \text{str } A \text{ str } B. \quad (3.10)$$

Secondly, we choose $g_k(M) = A(BM)^k C$ and successively use $K_1(M)$:

$$K_k(M) = \text{str} \left(\frac{\partial}{\partial M} A(BM)^k C \right) = \sum_{\ell=1}^k \text{str} \left(A(BM)^{\ell-1} B \right) \text{str} \left((BM)^{k-\ell} C \right). \quad (3.11)$$

We finally set $g(M) = A(x - BM)^{-1} C = \sum_{k \geq 0} x^{-k-1} A(BM)^k C$, so that

$$K(M) = \sum_{k \geq 1} \frac{1}{x^{k+1}} K_k(M) = \sum_{k \geq 0} \sum_{\ell=0}^k \frac{1}{x^{\ell+1}} \text{str} \left(A(BM)^\ell B \right) \frac{1}{x^{k-\ell+1}} \text{str} \left((BM)^{k-\ell} C \right), \quad (3.12)$$

which is equivalent to equation we wanted to prove. \square

Lemma 11. *Using the above notation, suppose that*

$$g(M) = A \text{str} \left(\frac{1}{x - BM} C \right) \quad (3.13)$$

Then we have the “merging rule”

$$K(M) = \text{str} \left(A \frac{1}{x - BM} C \frac{1}{x - BM} B \right). \quad (3.14)$$

Proof. Recall Eqs. (3.4) and (3.5). Direct manipulations lead to

$$K_1(M) = \text{str}(AB) \quad \text{if} \quad g_1(M) = A \text{str}(MB). \quad (3.15)$$

and, as a consequence,

$$K_k(M) = \sum_{\ell=1}^k \text{str} \left(A(BM)^{k-\ell} C (BM)^{\ell-1} B \right) \quad \text{if} \quad g_k(M) = A \text{str} \left((BM)^k C \right). \quad (3.16)$$

Now set $g(M) = A \text{str} \left((x - BM)^{-1} C \right)$. Hence

$$K(M) = \sum_{k \geq 1} \frac{1}{x^{k-1}} K_k(M) = \sum_{k \geq 0} \sum_{\ell=0}^k \text{str} \left(\frac{1}{x^{k-\ell+1}} A(BM)^{k-\ell} \frac{1}{x^{\ell+1}} C (BM)^\ell B \right) \quad (3.17)$$

and the lemma follows. \square

Let us find the effect of the transformation $f : M \mapsto M' = M + \epsilon g(M)$ on matrix integrals. We define the general expectation value of an analytic function G as

$$\left\langle G(M) \right\rangle_M = \int dM e^{-\frac{1}{\hbar} \text{str } V(IM)} G(IM) / \int dM e^{-\frac{1}{\hbar} \text{str } V(IM)} \quad (3.18)$$

Note that the potential V is a rational function. The average of the identity matrix is proportional to

$$\begin{aligned} \int dM' e^{-\frac{1}{\hbar} \text{str } V(IM')} &= \int dM e^{-\frac{1}{\hbar} \text{str } V(IM)} \left(1 + \epsilon K(M) \right. \\ &\quad \left. - \frac{\epsilon}{\hbar} \sum_{i,j} [I g(M)]_{ij} \frac{\partial}{\partial (IM)_{ij}} V(IM) + \mathcal{O}(\epsilon^2) \right) \end{aligned} \quad (3.19)$$

However, the measure is invariant under reparametrisation, which means

$$\langle G(M) \rangle_M = \langle G(M') \rangle_{M'}. \quad (3.20)$$

Hence, the following equation must be satisfied:

$$\left\langle \left(K(I^\dagger M) - \sum_{i,j} \left(I g(I^\dagger M) \right)_{ij} \frac{\partial}{\partial M_{ij}} \text{str} V(M) \right) \right\rangle_M = 0. \quad (3.21)$$

Suppose additionally that

$$V(M) = \sum_{k \geq 0} g_k \text{str} M^k - \text{str} MY. \quad (3.22)$$

From

$$\frac{\partial}{\partial M_{ij}} \text{str} M^k = k \sigma(i) M^{k-1}_{ji} \quad \text{and} \quad \frac{\partial}{\partial M_{ij}} \text{str} MY = \sigma(i) Y_{ji}, \quad (3.23)$$

we get, for any supermatrix A ,

$$\sum_{i,j} A_{ij} \frac{\partial}{\partial M_{ij}} \text{str} V(M) = \text{str} AV'(M). \quad (3.24)$$

The substitution of the last relation into Eq. (3.21) leads to the following Schwinger-Dyson equation, also known as loop equation.

Lemma 12. *Supermatrix model satisfies the following loop equations:*

$$\langle K(I^\dagger M) \rangle_M = \frac{1}{\hbar} \langle \text{str} I g(I^\dagger M) V'(M) \rangle_M. \quad (3.25)$$

Notice that since the infinitesimal Berezinian K satisfies the same split and merge rule as usual matrix models, we already have that supermatrix models satisfy the same loop equations as usual matrix models.

3.2. Loop equations for the supermatrix model in an external field. Here, we are interested in $V(M) = \text{str} v(M) - MY$.

Moreover, in order to close the set of loop equations, it was found in [10] that one should consider loop equations for the following expectation values, or more precisely their connected parts or (joint) cumulants $\langle G \rangle^c$.³ Specifically, we consider

$$\bar{w}(z_1, \dots, z_k) = \left\langle \prod_{i=1}^k \text{str} \frac{1}{z_i - M} \right\rangle_M^c \quad (3.26)$$

$$\bar{u}(x, y; z_1, \dots, z_k) = \left\langle \text{str} \frac{1}{x - M} \frac{\mu(y)}{y - Y} \prod_{i=1}^k \text{str} \frac{1}{z_i - M} \right\rangle_M^c \quad (3.27)$$

$$\bar{p}(x, y; z_1, \dots, z_k) = \left\langle \text{str} \frac{v'(x) - v'(M)}{x - M} \frac{\mu(y)}{y - Y} \prod_{i=1}^k \text{str} \frac{1}{z_i - M} \right\rangle_M^c \quad (3.28)$$

³Cumulants can be defined via $\langle G_1(M) \dots G_n(M) \rangle = \sum_{\pi \in \pi_{\{1, \dots, n\}}} \prod_{J \in \pi} \langle G_{j_1} G_{j_2} \dots \rangle^c$, where the sum is over all partitions π of the set $\{1, \dots, n\}$ while $J = \{j_1, j_2, \dots\}$ is an element of π . For instance $\langle AB \rangle = \langle AB \rangle^c + \langle A \rangle^c \langle B \rangle^c$ and $\langle ABC \rangle = \langle ABC \rangle^c + \langle AB \rangle^c \langle C \rangle^c + \langle AC \rangle^c \langle B \rangle^c + \langle BC \rangle^c \langle A \rangle^c + \langle A \rangle^c \langle B \rangle^c \langle C \rangle^c$.

where $\mu(y) = \mu(y; Y)$ is the minimal polynomial of Y , i.e. the polynomial $\prod_j (y - y_j)$, where the product is over the distinct eigenvalues of Y .

Notice that \bar{u} and \bar{p} are polynomials in the variable y , and, if $v'(x)$ is a rational fraction of x , then $\bar{p}(x, y; z_1, \dots, z_k)$ is also a rational fraction of x with the same poles, and with degree one less than $v'(x)$.

In terms of those expectation values, we have the following loop equations:

Proposition 13. *Let Y and M be Hermitian supermatrices of size $p + q$. In Eq. (3.18), set*

$$V(M) = v(M) - MY. \quad (3.29)$$

Then, for every set of variables $J = \{z_1, \dots, z_k\}$, we have the loop equation:

$$\begin{aligned} \bar{u}(x, y; J \cup \{x\}) + \sum_{I \subset J} \bar{u}(x, y; I) \bar{w}(x, J \setminus I) + \sum_{j=1}^k \frac{\partial}{\partial z_j} \frac{\bar{w}(x, J \setminus \{z_j\}) - \bar{w}(z_j, J \setminus \{z_j\})}{x - z_j} \\ = \frac{1}{\hbar} \left[(v'(x) - y) \bar{u}(x, y; J) - \bar{p}(x, y; J) + \mu(y) \bar{w}(x, J) \right] \end{aligned} \quad (3.30)$$

which is the same loop equation as the usual 1-matrix model in an external field.

Proof. We choose

$$g(M) = I^\dagger \frac{1}{x - IM} \frac{\mu(y)}{y - Y} \prod_{j=1}^k \text{str} \frac{1}{z_j - M} \quad (3.31)$$

and apply the splitting rule of Lemma 10 to the Schwinger-Dyson equation of Lemma 12. A few manipulations complete the proof. \square

Since loop equations arise from local changes of variables, it is clear that loop equations may have many solutions, in fact as many as possible open integration domains in which matrices are integrated. Here, the integration domain is specified by defining our matrix integral as formal series, such that each term in the series is a polynomial moment of a Gaussian integral, like in Eq. (2.35).

Moreover we have seen from theorem 8, that our formal supermatrix integrals have a topological expansion

$$\bar{w}(x_1, \dots, x_n) = \sum_{g=0}^{\infty} \hbar^{2g-2+n} \bar{w}^{(g)}(x_1, \dots, x_n) \quad (3.32)$$

It was found in [10], that there is a unique formal power series solution of loop equations having such a topological expansion, and that unique solution was computed in terms of the "symplectic invariants" of a spectral curve. We explain below how to find the spectral curve.

3.3. Spectral curve. The spectral curve can be found from the loop equation with $J = \emptyset$; that is,

$$\hbar \bar{u}(x, y; x) = (v'(x) - y - \hbar \bar{w}(x)) \bar{u}(x, y) - \bar{p}(x, y) + \mu(y) \bar{w}(x) \quad (3.33)$$

and if we expand it into powers of \hbar , to leading order we have:

$$0 = (v'(x) - y - \bar{w}^{(0)}(x)) \bar{u}^{(0)}(x, y) - \bar{p}^{(0)}(x, y) + \mu(y) \bar{w}^{(0)}(x) \quad (3.34)$$

We see this functional equation is greatly simplified if the second term disappears, i.e., if we choose $y = v'(x) - \bar{w}^{(0)}(x)$. Moreover, in order to obtain algebraic relations, we introduce $D(x)$, the denominator of $v'(x)$.

Corollary 14. *Define two scalar functions of one and two complex variables respectively:*

$$\mathcal{Y}(x) = v'(x) - \bar{w}^{(0)}(x) \quad (3.35)$$

and E_{ext} which is a polynomial of its two variables such that

$$D(x)^{-1} E_{\text{ext}}(x, y) = (v'(x) - y) \mu(y) - \bar{p}^{(0)}(x, y). \quad (3.36)$$

Then, the following algebraic equation holds:

$$E_{\text{ext}}(x, \mathcal{Y}(x)) = 0. \quad (3.37)$$

The algebraic plane curve defined by this equation is called the spectral curve.

As we said, the unique formal series solution of those loop equations of the form (3.30), having a topological expansion in \hbar^2 , was computed in [10] in terms of the "symplectic invariants" of the spectral curve:

$$\mathcal{E}(x, y) = E_{\text{ext}}(x, y) = 0. \quad (3.38)$$

In fact, to any spectral curve \mathcal{E} , one can associate an infinite sequence of numbers $\mathcal{F}^{(g)}(\mathcal{E})$, $g = 0, 1, 2, \dots$. The $\mathcal{F}^{(g)}$'s are computed in terms of the spectral curve, and are residues of birational expressions of x and y . We refer the reader to [10] for detailed computations of the $\mathcal{F}^{(g)}$'s. The result is that:

$$\ln Z = \sum_{g=0}^{\infty} \hbar^{2g-2} \mathcal{F}^{(g)}(\mathcal{E}) \quad (3.39)$$

The functions $\mathcal{F}^{(g)}$ are called the symplectic invariants of the spectral curve because, as exposed in the following theorem, they remain unchanged if one changes the spectral curve without changing the symplectic form $dx \wedge dy$.

Theorem 15. [10] *For all $g \geq 2$, the free energy $\mathcal{F}^{(g)}(\mathcal{E})$ is invariant under the following transformations of the algebraic equation $\mathcal{E}(x, y) = 0$:*

$$\begin{aligned} (1) \quad & x \mapsto x, \quad y \mapsto y + R(x) \\ (2) \quad & x \mapsto cx, \quad y \mapsto y/c \\ (3) \quad & x \mapsto -x, \quad y \mapsto y \\ (4) \quad & x \mapsto y, \quad y \mapsto x \end{aligned} \quad (3.40)$$

where R is a rational function and c is a complex number. $\mathcal{F}^{(0)}$ is invariant under the four transformations if R is replaced by a polynomial P . $\mathcal{F}^{(1)}$ is invariant under the four transformations up to an additive factor of $i\pi/12$. These transformations preserve, up to a sign, the symplectic form $dx \wedge dy$.

We stress that previous theorem implies that for all $g \geq 0$, $\mathcal{F}^{(g)}(\mathcal{E})$ is invariant under the exchange of x and y in the $\mathcal{E}(x, y) = 0$. This invariance will be exploited for proving the duality for the Gaussian model.

4. GAUSSIAN MODEL WITH SOURCES AND EXTERNAL FIELDS

4.1. Spectral curve. We now focus on the study of the partition function given in Eq. (1.6). For this, we choose

$$V(M) = v(M) - MY, \quad v(M) = \frac{1}{2}M^2 - \hbar \ln \prod_{i=1}^{m+n} (x_i - M)^{\sigma_{m,n}(i)} \quad (4.1)$$

where M is a Hermitian supermatrix of size $p + q$. We suppose that the variables x_i 's are the eigenvalues of a Hermitian matrix of size $m + n$. Amongst these eigenvalues only $m' + n'$, say, are distinct. This means that

$$\text{sdet}(z - X) = \prod_{i=1}^{m+n} (z - x_i)^{\sigma_{m,n}(i)} = \prod_{i=1}^{m'+n'} (z - x_i)^{a_i} \quad (4.2)$$

where the signed multiplicities a_i are such that

$$m = \sum_{i=1}^{m'} a_i \quad \text{and} \quad n = - \sum_{i=m'+1}^{m'+n'} a_i. \quad (4.3)$$

Similarly,

$$\text{sdet}(z - Y) = \prod_{i=1}^{p+q} (z - y_i)^{\sigma_{p,q}(i)} = \prod_{i=1}^{p'+q'} (z - y_i)^{b_i}. \quad (4.4)$$

Thus, the minimal polynomial of Y and the denominator of v' are respectively given by

$$\mu(y) = \mu(y; Y) = \prod_{i=1}^{p'+q'} (y - y_i) \quad \text{and} \quad D(x) = \mu(x; X) = \prod_{j=1}^{m'+n'} (x - x_j) \quad (4.5)$$

The spectral curve given in Corollary 14, now becomes

$$\begin{aligned} \mathcal{E}(x, y) = E_{\text{ext}}(x, y) = \prod_i (x - x_i) \prod_j (y - y_j) & \left(x - \hbar \sum_i \frac{a_i}{x - x_i} \right. \\ & \left. - y - \hbar \sum_j \frac{b_j}{y - y_j} + \hbar^2 \sum_{i,j} \frac{a_i}{x - x_i} \frac{b_j}{y - y_j} \left\langle \left(\frac{1}{x_j - M} \right)_{jj} \right\rangle \right) \end{aligned} \quad (4.6)$$

where it is assumed that $i \in \{1, \dots, m' + n'\}$ and $j \in \{1, \dots, p' + q'\}$.

Remark 16. This is more or less the same spectral curve as in the usual hermitian matrix model in an external field, with one notable difference. In the usual matrix model, the coefficients b_j are necessarily positive integers, and here, supermatrix models allow more general spectral curves, where b_j 's can also be negative integers.

4.2. Geometry of the spectral curve. The geometry of spectral curves of the type 4.6 has been studied many times, and is a standard exercise of Riemann geometry [11, 12]. Here, we only briefly summarize the main points, and we follow the same lines as [10].

The spectral curve $\mathcal{E}(x, y) = 0$ defines a unique compact Riemann surface. Generically, this algebraic Riemann surface has genus at most $(m' + n')(p' + q') - 1$.

The genus can be lower than that. In particular, if our supermatrix model is defined as perturbation of a Gaussian integral near $M = 0$, (as we did in Proposition 9), then the spectral curve must have genus 0, i.e. it must be a rational spectral curve.

But in general, the genus can be anything between 0 and $(m' + n')(p' + q') - 1$.

Notice that in Eq. (4.6), the coefficients $\left\langle \left(\frac{1}{x_j - M} \right)_{jj} \right\rangle$ have not been determined. Those coefficients cannot be determined by loop equations, they are related to the integration domain for the supermatrix integral. Those coefficients are in 1-1 correspondence with the "filling fractions":

$$\epsilon_i = \frac{1}{2i\pi} \oint_{\mathcal{A}_i} y dx \quad (4.7)$$

where $\mathcal{A}_i, i = 1, \dots, \text{genus}$ is a set of independent non-contractible cycles on the Riemann surface.

A choice of integration domain, is equivalent to a choice of those coefficients, and thus is equivalent to a choice of filling fractions.

The spectral curve is then described by this Riemann surface, and by two meromorphic functions $x(z)$ and $y(z)$ defined on that surface. Those two functions can be completely described by their poles and by their cycle integrals (4.7).

4.3. Poles. The spectral curve can be studied by determining the singularity structure of the algebraic equation. More precisely, let two complex function x and y . Let z belong to a the Riemann surface associated to the algebraic equation if $\mathcal{E}(x(z), y(z)) = 0$ for all z on the surface.

In our case, it is clear that the algebraic equation (4.6) has only three types of singularity, all being poles. First, it is obvious that the polynomial $\mathcal{E}(x, y)$ diverges when both x and y become infinite. The equation $\mathcal{E}(x, y) = 0$ gives in that limit:

$$y \sim x - \frac{\hbar(\sum_i a_i + \sum_j b_j)}{x} + O(1/x^2) = x - \frac{\hbar(m - n + p - q)}{x} + O(1/x^2) \quad (4.8)$$

Second, we see that \mathcal{E} also diverges when x tends to x_i . We call ξ_i the point on the surface such that $x(\xi_i) = x_i$ and, in order to comply with the algebraic equation $\mathcal{E}(x, y) = 0$, we must have in that limit:

$$y \sim -\frac{\hbar a_i}{x - x_i} + O(1) \quad (4.9)$$

Third, the polynomial goes to infinity if y approaches y_i , which correspond to a diverging x . We thus set $y(\eta_i) = y_i$ and we have in this limit:

$$x \sim \frac{\hbar b_i}{y - y_i} + O(1) \quad (4.10)$$

The above equations yield the following characterization of x and y and, as a consequence, of the spectral curve.

Lemma 17. *The meromorphic functions x and y , have simple poles at the points:*

$$\begin{aligned} z = \infty & : x = \infty, \quad y = \infty \\ z = \xi_i & : x = x_i, \quad y = \infty \\ z = \eta_j & : x = \infty, \quad y = y_j. \end{aligned} \quad (4.11)$$

The spectral curve $\mathcal{E}_{(m|n),(p|q),(X,Y,\epsilon)}$ is completely characterized by the residues

$$\begin{aligned} \operatorname{Res}_{z \rightarrow \infty} y dx &= \hbar(m - n + p - q) \\ \operatorname{Res}_{z \rightarrow \infty} x dy &= -\hbar(m - n + p - q) \\ \operatorname{Res}_{z \rightarrow \xi_i} y dx &= -\hbar a_i \\ \operatorname{Res}_{z \rightarrow \eta_i} x dy &= \hbar b_i \end{aligned} \quad (4.12)$$

and the filling fractions

$$\epsilon_i = \frac{1}{2i\pi} \oint_{\mathcal{A}_i} y dx \quad (4.13)$$

where we recall that a choice of integration domain, is equivalent to a choice of filling fractions.

5. DUALITY

We have determined the spectral curve, which allows in principle to construct the free energy via the following expansion: Then, when we have determined the spectral curve, we have:

$$\ln(Z_{(m|n),(p|q)}(X, Y, \epsilon)) = \sum_{g=0}^{\infty} \hbar^{2g-2} \mathcal{F}_g(\mathcal{E}_{(m|n),(p|q),(X,Y,\epsilon)}), \quad (5.1)$$

where $\mathcal{F}_g(\mathcal{E}_{(m|n),(p|q),(X,Y,\epsilon)})$ denotes the symplectic invariant $\mathcal{F}_g(\mathcal{E})$ defined in [10] for the particular spectral curve $\mathcal{E} = \mathcal{E}_{(m|n),(p|q),(X,Y,\epsilon)}$.

Theorem 18. *The following duality holds:*

$$Z_{(m|n),(p|q)}(X, Y, \epsilon) = Z_{(p|q),(m|n)}(Y, X, -\epsilon) \quad (5.2)$$

Proof. Looking at the spectral curve characterized by data given in Lemma 17, we see that $\mathcal{E}_{(m|n),(p|q),(X,Y,\epsilon)}$ and $\mathcal{E}_{(p|q),(m|n),(Y,X,-\epsilon)}$ are just obtained from one another by the exchange of x and y . We now from Theorem 15 that the \mathcal{F}_g are invariant under such a transformation, so that the result follows from Eq. (5.1). \square

The change $\epsilon \rightarrow -\epsilon$ is just the change of orientation for the integration contours used to define the integrals.

In case we are studying the perturbative supermatrix integral (small deformation of the Gaussian integral), we need a genus zero spectral curve. Indeed, in such instance, the parameter z belongs to the complex plane, and $x(z)$ and $y(z)$ are rational fractions of z whose poles are fixed by the analysis performed in the previous section, i.e. by equations (4.11) to (4.12). We therefore find:

Lemma 19. *For the perturbative matrix integral, the rational spectral curve can be parametrized as follows:*

$$\mathcal{E}_{(m|n),(p|q),(X,Y)} = \begin{cases} x(z) &= z + \hbar \sum_i \frac{b_i}{y'(\eta_i)(z-\eta_i)} \\ y(z) &= z - \hbar \sum_i \frac{a_i}{x'(\xi_i)(z-\xi_i)}. \end{cases} \quad (5.3)$$

where the complex numbers ξ_i, η_i are obtained by solving $x(\xi_i) = x_i$ and $y(\eta_i) = y_i$.

This means that in the rational case, there is no filling fraction. The duality exposed in the introduction is thus a corollary of Theorem 18 and Lema 19.

We end this section with a simple application of the duality: we show that the expectation of a product of characteristic polynomials in a Gaussian supermatrix model formally tends to a generalization of the Kontsevich model (matrix Airy function) when $1/(p-q) \rightarrow 0$. We first make use of Eq. (B.13),

$$Z_{(m|n),(p|q)}(X, 0) = Z_{(p|q),(m|n)}(0, X), \quad \text{and} \quad \sum_{i=1}^{p+q} \sigma(i) = p - q,$$

which yields

$$Z_{(m|n),(p|q)}(iA, 0) = \frac{e^{\frac{1}{2\hbar} \text{str} A^2}}{z_{m,n}(\hbar)} \int_{H(m|n)} dN e^{-\frac{1}{2\hbar} \text{str}(IN)^2 + \frac{i}{\hbar} \text{str} INA} \text{sdet}(-IN)^{p-q}, \quad (5.4)$$

In the last equation, $A = \text{diag}(a_1, \dots, a_{m+n})$ and $z_{m,n}(\hbar)$ stands for the normalization coefficient defined in Eq. (B.14). Now, let W and X be a Hermitian supermatrix of size $m+n$ and a diagonal matrix X with $m+n$ complex entries, respectively. We also set

$$\hbar = (p-q)^{-1}, \quad IN = i + \hbar^{1/3}W, \quad \text{and} \quad A = 2 + \hbar^{2/3}X. \quad (5.5)$$

Finally, we formally expand the integrand in Eq. (5.4) in powers of $\hbar = (p-q)^{-1}$ and conclude that, as $\hbar \rightarrow 0$,

$$\frac{e^{-\frac{1}{\hbar^{1/3}} \text{str} X}}{\bar{z}_{m,n}(\hbar)} Z_{(m|n),(p|q)}(2i + i\hbar^{1/3}X, 0) = \text{Ai}(X) + O(\hbar^{1/3}), \quad (5.6)$$

where

$$\text{Ai}(X) = \int_{H(m|n)} dW e^{\frac{i}{3} \text{str} W^3 + i \text{str} WX} \quad (5.7)$$

and

$$\bar{z}_{m,n}(\hbar) = \frac{e^{\frac{m-n}{2\hbar} i^{(m-n)(\hbar^{-1}-n)}}}{\hbar^{(m-n)^2/3}} z_{m,n}(\hbar). \quad (5.8)$$

6. CONCLUSION

We have proved that gaussian supermatrix integrals with external fields and sources, respectively denoted by $Y = \text{diag}(y_1, \dots, y_{p+q})$ and $X = \text{diag}(x_1, \dots, x_{m+n})$ for some complex numbers y_i and z_i , satisfy a duality formula which extends that of [4, 7]. Usual hermitian matrices with sources at both numerators and denominators could not have this duality, because we see that numerators and denominators are transformed, under this duality, into variables of different signs, which can be only obtained with supermatrices. In some sense supermatrices allow eigenvalues with negative multiplicities. We conjecture that the supermatrix duality proved in the article extends to the case where the external sources and fields, X and Y , are arbitrary supermatrices.

ACKNOWLEDGMENTS

The authors would like to thank N. Orantin for useful and fruitful discussions on this subject. The work of B.E. is partly supported by the Enigma European network MRT-CT-2004-5652, by the ANR project Géométrie et intégrabilité en physique mathématique ANR-05-BLAN-0029-01, by the European Science Foundation through the Misgam program, by the Quebec government with the FQRNT. The work of P.D. is supported by the Fondo Nacional de Desarrollo Científico y Tecnológico (FONDECYT) Grant #1090034. The project was initiated while P.D. was a postdoctoral fellow at the IPhT, CEA-Saclay; P.D. wishes to thank the members of the IPhT for their kind generosity and hospitality.

APPENDIX A. GRASSMANN VARIABLES

The Grassmann algebra of order n , denoted $\Gamma = \Gamma(n; \mathbb{C})$, is the algebra over \mathbb{C} generated by 1 and n quantities θ_i , called Grassmann variables, which satisfy

$$\theta_i \theta_j = -\theta_j \theta_i. \quad (\text{A.1})$$

Note in particular that $\theta_i^2 = 0$. Let c be a complex number. We adopt the following convention for the complex conjugation:

$$(c\theta_i)^* = c^* \theta_i^*, \quad (\theta_i \theta_j)^* = \theta_j^* \theta_i^*, \quad \theta_i^{**} = \theta_i. \quad (\text{A.2})$$

Γ has 2^n generators: Every element x can be decomposed as

$$x = x^{(0)} + \sum_{i_1} x^{(i_1)} \theta_{i_1} + \sum_{i_1 < i_2} x^{(i_1, i_2)} \theta_{i_1} \theta_{i_2} + \dots + x^{(1, \dots, n)} \theta_1 \dots \theta_n \quad (\text{A.3})$$

with $x^{(i_1, i_2, \dots)} \in \mathbb{C}$. We say that x is even (or bosonic) if it contains only monomials with an even number of θ_i ; x is odd (fermionic) if it contains only monomials with an odd number of θ_i . Elements x_i of the Grassmann algebra satisfy

$$x_i x_j = (-1)^{(\deg x_i \cdot \deg x_j)} x_j x_i \quad (\text{A.4})$$

where $\deg x = 0$ if x is even while $\deg x = 1$ if x is odd. Note that we also write

$$\deg x = \epsilon(x) \quad \text{and} \quad (-1)^{\deg x} = \sigma(x). \quad (\text{A.5})$$

The (left) derivative and the integration with respect to the Grassmann variables are respectively defined by

$$\frac{\partial}{\partial \theta_i} (\theta_{j_1} \theta_{j_2} \dots \theta_{j_k}) = \delta_{i, j_1} (\theta_{j_2} \dots \theta_{j_k}) - \delta_{i, j_2} (\theta_{j_1} \theta_{j_3} \dots \theta_{j_k}) + (-1)^k \delta_{i, j_k} (\theta_{j_1} \dots \theta_{j_{k-1}}) \quad (\text{A.6})$$

and

$$\int d\theta_i \theta_j = - \int \theta_j d\theta_i = \delta_{i, j}. \quad (\text{A.7})$$

With the latter definition, one can obtain the following integral representation for the determinant of a $N \times N$ matrix X :

$$\det X = \int d\theta^\dagger d\theta e^{-\theta^\dagger X \theta} \quad (\text{A.8})$$

where θ (resp. θ^\dagger) is interpreted as a column (resp. row) vector with N fermionic components. The bosonic counterpart of the latter formula is the usual Gaussian integral involving complex variables z_i ; that is, if X is Hermitian,

$$\frac{1}{\det X} = \frac{1}{(2\pi i)^N} \int dz^\dagger dz e^{-z^\dagger X z}. \quad (\text{A.9})$$

APPENDIX B. SUPERMATRICES

Let X denote an even (bosonic) square supermatrix of size $(p+q)$. It can be written as

$$X = \left(X_{ij} \right)_{1 \leq i, j \leq p+q} = \begin{pmatrix} A & B \\ C & D \end{pmatrix} \quad (\text{B.1})$$

where A and D are respectively $p \times p$ and $q \times q$ matrices with even Grassmann elements, while B and C are respectively $p \times q$ and $q \times p$ matrices with Grassmann odd elements. The following notation is useful:

$$(-1)^{\deg X_{ij}} = \sigma(i)\sigma(j) \quad (\text{B.2})$$

where

$$\sigma(i) = (-1)^{\epsilon(i)} = \begin{cases} +1, & i = 1, \dots, p, \\ -1, & i = p+1, \dots, p+q. \end{cases} \quad (\text{B.3})$$

The supertrace is given by

$$\text{str } X = \sum_{i=1}^{p+q} \sigma(i) X_{ii} = \text{tr } A - \text{tr } D \quad (\text{B.4})$$

and satisfies

$$\text{str}(X+Y) = \text{str } X + \text{str } Y, \quad \text{str}(XY) = \text{str}(YX). \quad (\text{B.5})$$

The superdeterminant, which exists only if A as well as D are invertible, is given by

$$\text{sdet } X = \frac{\det(A - BD^{-1}C)}{\det(D)} = \frac{\det(A)}{\det(D - CA^{-1}B)}. \quad (\text{B.6})$$

One can show that

$$\text{sdet}(XY) = \text{sdet } X \text{ sdet } Y \quad \text{and} \quad \det(\exp X) = \exp(\text{str } X). \quad (\text{B.7})$$

We use the following definitions for the transpose and the adjoint of a supermatrix:

$$X^t = \begin{pmatrix} A^t & C^t \\ B^t & D^t \end{pmatrix} \quad \text{and} \quad X^\dagger = \begin{pmatrix} A^\dagger & C^\dagger \\ B^\dagger & D^\dagger \end{pmatrix} \quad (\text{B.8})$$

where A^\dagger means $(A^t)^*$. One easily shows that

$$(X^\dagger)^\dagger = X, \quad (XY)^\dagger = Y^\dagger X^\dagger, \quad \text{sdet } X^\dagger = (\text{sdet } X)^*. \quad (\text{B.9})$$

However, $(XY)^t \neq Y^t X^t$ and $\text{sdet } X^t \neq \text{sdet } X$ in general.⁴ A supermatrix X is Hermitian if $X^\dagger = X$; it is unitary if $X^\dagger = X^{-1}$. The set of all invertible even supermatrices of size $p+q$, whose elements belong to a Grassman algebra over \mathbb{C} , form the general linear supergroup $GL(p|q)$. All unitary supermatrices form the superunitary group $U(p|q)$.

⁴Other non equivalent definitions for the transpose and the adjoint are possible. They lead, for instance, to a distinct unitary supergroup, namely $sU(p|q)$. [3, 13].

Let $\xi^\dagger = (z_1^*, \dots, z_p^*, \theta_1^*, \dots, \theta_q^*)$ be the adjoint of the supervector ξ . Then, the superdeterminant of a Hermitian supermatrix X has the following integral representation:

$$\frac{1}{\text{sdet } X} = \frac{1}{(2\pi i)^p} \int d\xi^\dagger d\xi e^{-\xi^\dagger X \xi}. \quad (\text{B.10})$$

The measure for Hermitian supermatrices is given by the product $\prod_{i,j} dX_{i,j}$ which is equal, up to a multiplicative constant, to the product of real independent differential elements. Explicitly, if $X \in H(p|q)$,

$$dX = \prod_{1 \leq i \leq p+q} dX_{ii} \prod_{1 \leq i < j \leq p} dX_{ij} dX_{ij}^* \prod_{\substack{1 \leq i \leq p \\ p+1 \leq j \leq p+q}} dX_{ij} dX_{ij}^*. \quad (\text{B.11})$$

For instance, by using the bosonic and fermionic Gaussian integrals,

$$\int_{\mathbb{R}} dx e^{-x^2+xy} = \sqrt{\pi} e^{\frac{1}{4}y^2} \quad \text{and} \quad \int d\theta d\theta^* e^{\theta^*\theta + \theta^*\eta + \eta^*\theta} = e^{\eta\eta^*}, \quad (\text{B.12})$$

where $\deg \eta = \deg \eta^* = 1$, one readily shows that the following formulas hold for any (not necessarily Hermitian) supermatrix Y of size $p+q$:

$$\int dX e^{-\frac{1}{2\hbar} \text{str}(IX)^2} e^{\text{str} IXY} = z_{p,q}(\hbar) e^{\frac{\hbar}{2} \text{str} Y^2}, \quad (\text{B.13})$$

where

$$z_{p,q}(\hbar) = 2^{(p+q)/2} i^{pq} \pi^{(p^2+q^2)/2} \hbar^{(p-q)^2/2}, \quad (\text{B.14})$$

so that

$$\langle e^{\text{str} XY} \rangle_{X \in GU(p|q)} = \frac{\int dX e^{-\frac{1}{2\hbar} \text{str}(IX)^2} e^{\text{str} IXY}}{\int dX e^{-\frac{1}{2\hbar} \text{str}(IX)^2}} = e^{\frac{\hbar}{2} \text{str} Y^2}. \quad (\text{B.15})$$

REFERENCES

- [1] J. Alfaro, R. Medina, and L. F. Urrutia, *The Itzykson-Zuber integral for $U(m|n)$* , J. Math. Phys. **36** (1995), 3085–3093; *Orthogonality relations and supercharacter formulas of $U(m|n)$ representations*, J. Math. Phys. **38** (1997) 5319–5349.
- [2] L. Alvarez-Gaumé and J. L. Mañes, *Supermatrix Models*, Mod. Phys. Letters **A 6** (1991) 2039–2049.
- [3] F. A. Berezin, *Introduction to Superanalysis*, Springer, 1987.
- [4] E. Brzin, S. Hikami, *Intersection theory from duality and replica*, Commun. Math. Phys. **283** (2008) 507–521.
- [5] L. Chekhov, B. Eynard, and N. Orantin, *Free energy topological expansion for the 2-matrix model*, JHEP **12** (2006) 053 1–31.
- [6] A. D’Adda, *Comments on supersymmetric vector and matrix models*, Class. Quantum Grav. **9** (1991) L21–L25.
- [7] P. Desrosiers, *Duality in random matrix ensembles for all β* , Nucl. Phys. **B 817** (2009) 224–251.
- [8] K. Efetov, *Supersymmetry in Disorder and Chaos*, Cambridge University Press, 1997.
- [9] B. Eynard, *Topological expansion for the 1-hermitian matrix model correlation functions*, JHEP11 (2004) 031 1–35.
- [10] B. Eynard and N. Orantin, *Invariants of algebraic curves and topological expansion*, Commun. Number Theory Phys. **1** (2007), 347–452.
- [11] H. M. Farkas and I. Kra, *Riemann surfaces*, 2nd edition, Springer 1992.
- [12] J. D. Fay, *Theta Functions on Riemann Surfaces*, Springer 1973.
- [13] L. Frappat, A. Sciarrino, and P. Sorba, *Dictionary on Lie Algebras and Superalgebras*, Academic Press 2000.
- [14] J. McGreevy, S. Murthy, and H. Verlinde, *Two-dimensional superstrings and the supersymmetric matrix model*, JHEP04 (2004) 015 1–20.

- [15] S. K. Lando, A. K. Zvonkin, *Graphs on surfaces and their applications*, Springer 2004.
- [16] Y. Makeenko, *Strings, matrix models, and meanders*, Nucl. Phys. Proc. Suppl. **49** (1996) 226–237.
- [17] J. C. Plefka, *Supersymmetric Generalizations of Matrix Models*, Ph.D. Thesis, University of Hannover (1996) [arXiv:hep-th/9601041](https://arxiv.org/abs/hep-th/9601041), 53 pages.
- [18] S. A. Yost, *Supermatrix Models*, Int. J. Mod. Phys. A **7** 6105-6120.

INSTITUTO MATEMÁTICA Y FÍSICA, UNIVERSIDAD DE TALCA, 2 NORTE 685, TALCA, CHILE.

INSTITUT DE PHYSIQUE THÉORIQUE, CEA–SACLAY, 91191 GIF-SUR-YVETTE CEDEX, FRANCE.

E-mail address: `patrick.desrosiers@inst-mat.otalca.cl`

E-mail address: `bertrand.eynard@cea.fr`