

An involution for symmetry of hook length and part length of pointed partitions

Heesung Shin and Jiang Zeng

November 21, 2018

Abstract

A *pointed partition* of n is a pair (λ, v) where $\lambda \vdash n$ and v is a cell in its Ferrers diagram. We construct an involution on pointed partitions of n exchanging “hook length” and “part length”. This gives a bijective proof of a recent result of Bessenrodt and Han.

1 Introduction

A partition λ is a sequence of positive integers $\lambda = (\lambda_1, \lambda_2, \dots, \lambda_\ell)$ such that $\lambda_1 \geq \lambda_2 \geq \dots \geq \lambda_\ell > 0$. The integers $\lambda_1, \dots, \lambda_\ell$ are called the parts of λ , the number ℓ of parts is denoted by $\ell(\lambda)$ and called the length of λ . The sum of parts is denoted by $|\lambda|$. If $|\lambda| = n$, we say that λ is a partition of n and write $\lambda \vdash n$. Each partition can be represented by its *Ferrers diagram*, we shall identify a partition with its Ferrers diagram. We refer the reader to Andrews’ book [And98] for general reference on partitions.

A *pointed partition* of n is a pair (λ, v) where $\lambda \vdash n$ and v is a cell in its Ferrers diagram. Let \mathcal{F}_n be the set of pointed partitions of n . For each pointed partition (λ, v) , we define the arm length $a_v := a_v(\lambda)$ (resp. leg length l_v , coarm length m_v , coleg length g_v) to be the number of cells lying in the same row as v and to the right of v (resp. in the same column as v and above v , in the same row as v and to the left of v , in the same column as v and under v), see Figure 1. The *hook length* h_v and *part length* p_v of v in λ are defined by $h_v = l_v + a_v + 1$ and $p_v = m_v + a_v + 1$, respectively. The joint distribution of (h_v, p_v) on \mathcal{F}_4 is given in Figure 2, where (h_v, p_v) is written in (λ, v) .

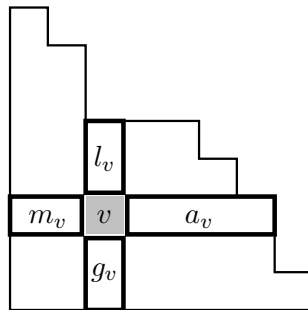

Figure 1: The arm, leg, coarm and coleg length of (λ, v)

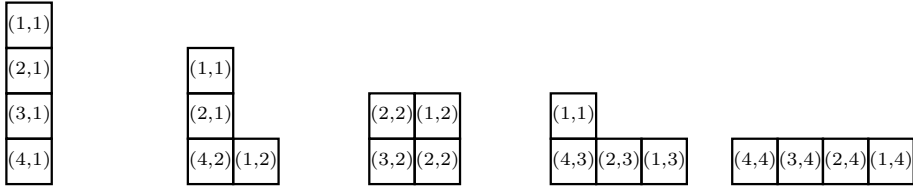

Figure 2: The distribution of (h_v, p_v) on \mathcal{F}_4

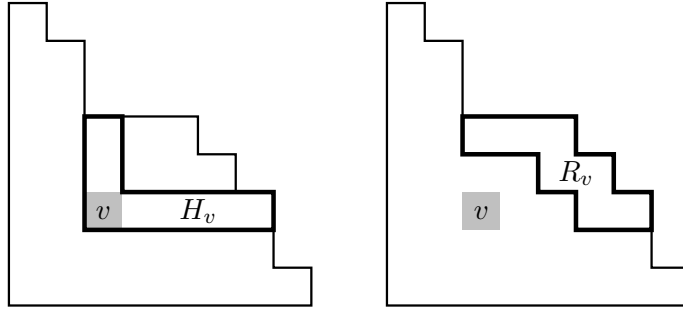

Figure 3: The hook and rim hook of (λ, v)

In a recent paper, generalizing the result of Bessenrodt [Bes98], Bessenrodt and Han [BH09] showed that the bivariate joint distribution (h_v, p_v) over \mathcal{F}_n is *symmetric*, that is,

$$\sum_{(\lambda, v) \in \mathcal{F}_n} x^{h_v} y^{p_v} = \sum_{(\lambda, v) \in \mathcal{F}_n} x^{p_v} y^{h_v}.$$

Since the proof in [BH09] uses a generating function argument, this raises the natural question of finding a bijective proof of their result. The aim of this paper is to construct an involution Φ on \mathcal{F}_n exchanging hook length and part length and give bijective proofs of the main results in [BH09].

2 Hook and rim hook

Let λ be a partition. Denote its *conjugate* by $\lambda' = (\lambda'_1, \lambda'_2, \dots)$, where λ'_i is the number of parts of λ that are $\geq i$. For a cell $v \in \lambda$, the *hook* $H_v := H_v(\lambda)$ of the cell v in λ is the set of all cells of λ lying in the same column above v or in the same row to the right of v , including v itself. Obviously, the number of all cells in a hook H_v equals the hook length h_v for any v in λ . A cell v in λ is called *boundary cell* if the upright corner of v is in boundaries of λ . A *border strip* is a sequence x_0, x_1, \dots, x_m of boundary cells in λ such that x_{j-1} and x_j have a common side for $1 \leq j \leq m$. The *rim hook* $R_v := R_v(\lambda)$ of (λ, v) is a border strip x_0, x_1, \dots, x_m of cells in λ such that x_0 (resp. x_m) is the uppermost (resp. rightmost) cell of the hook H_v . The *rim hook length* r_v of v in λ is defined to be the number of all cells in the rim hook R_v . It is easy to see that the hook H_v and the rim hook R_v have the same length, same height (or number of rows), and same width (or number of columns). See Figure 3.

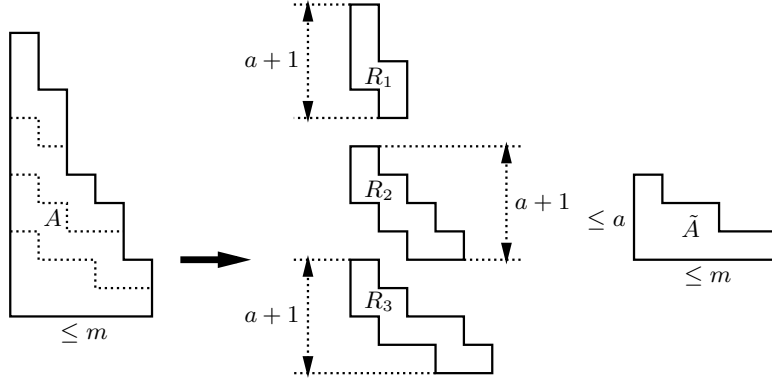

Figure 4: Move out rim hooks from A to get $(\tilde{A}; r_1, \dots, r_t)$

For a given nonnegative integers a and m , let \mathcal{A} be the set of partitions whose largest part is bounded by m , $\tilde{\mathcal{A}}$ the set of partitions whose largest part is bounded by m and parts are at most a , and \mathcal{R} the set of nondecreasing sequences (r_1, \dots, r_t) , $t \geq 0$, with

$$a + 1 \leq r_1 \leq r_2 \leq \dots \leq r_t \leq a + m.$$

We first describe an important algorithm, called *Peeling Algorithm*, which will be used in the construction of the involution Φ . From the leftmost top cell of the diagram of $A \in \mathcal{A}$, remove a rim hook of height $a + 1$, if any, in such a way that what remains is a diagram of a partition, and continue removing rim hooks of height $a + 1$ in this way as long as possible. Denote the remained partition by \tilde{A} as shown in Figure 4. Clearly, the length of \tilde{A} is less than or equal to a and $\tilde{A} \in \tilde{\mathcal{A}}$.

Each removed rim hook in the above transformation corresponds to some cell in the first column of A . Let v_1, \dots, v_t be the cells from top to bottom corresponding to removed rim hooks. If r_1, \dots, r_t are the lengths of removed rim hooks R_1, \dots, R_t , then

$$r_i = a_{v_i} + a + 1 \quad \text{for all } 1 \leq i \leq t.$$

Since A is a partition with largest part bounded by m , we have

$$0 \leq a_{v_1} \leq a_{v_2} \leq \dots \leq a_{v_t} \leq m - 1$$

and $(r_1, \dots, r_t) \in \mathcal{R}$.

Lemma 1 (Peeling Algorithm). *The mapping $A \mapsto (\tilde{A}; r_1, \dots, r_t)$ is a bijection from \mathcal{A} to $\tilde{\mathcal{A}} \times \mathcal{R}$.*

Proof. It is sufficient to construct the inverse of peeling algorithm.

Starting from $(\tilde{A}; r_1, \dots, r_t) \in \tilde{\mathcal{A}} \times \mathcal{R}$, let $A_t := \tilde{A} = (\lambda_1, \dots, \lambda_\ell)$ with $\ell \leq a$. If there exists a cell whose arm length $< r_t - a - 1$, let $v_t := (1, \alpha)$ be the lowest such cell. Otherwise, let $v_t := (1, \alpha)$ with $\alpha = \ell(A_t) + 1$. Since the length of A_t is less than or equal to a , we have $l_{v_t}(A_t) < a$. Define the partition

$$A_{t-1} := (\lambda_1, \dots, \lambda_{\alpha-1}, r_t - a, \lambda_\alpha + 1, \dots, \lambda_{\alpha+a-1} + 1),$$

where $\lambda_i := 0$ for $i > \ell$. Clearly

$$l_{v_t}(A_{t-1}) = a \quad \text{and} \quad a_{v_t}(A_{t-1}) = r_t - a - 1. \quad (1)$$

Next, we proceed by induction on i from $t - 1$ to 1. Suppose that we have found $A_{t-1}, A_{t-2}, \dots, A_i = (\lambda_1, \dots, \lambda_\ell)$ with

$$l_{v_{i+1}}(A_i) = a \quad \text{and} \quad a_{v_{i+1}}(A_i) = r_{i+1} - a - 1. \quad (2)$$

If there exists a cell whose arm length $< r_i - a - 1$, let $v_i := (1, \alpha)$ be the lowest such cell. Otherwise, let $v_i := (1, \alpha)$ with $\alpha = \ell(A_i) + 1$. Since we have $a_{v_{i+1}}(A_i) = r_{i+1} - a - 1 \geq r_i - a - 1$ by (2), the cell v_i is above v_{i+1} . Also, since $l_{v_{i+1}}(A_i) = a$ by (2), we have $l_{v_i}(A_i) < a$. Let

$$A_{i-1} := (\lambda_1, \dots, \lambda_{\alpha-1}, r_i - a, \lambda_\alpha + 1, \dots, \lambda_{\alpha+a-1} + 1),$$

where $\lambda_i := 0$ for $i > \ell$. Clearly,

$$l_{v_i}(A_{i-1}) = a \quad \text{and} \quad a_{v_i}(A_{i-1}) = r_i - a - 1. \quad (3)$$

Finally, define $A := A_0 \in \mathcal{A}$. Applying peeling algorithm to such a partition A induced from $(\tilde{A}; r_1, \dots, r_t)$, by (1) and (3), we get $(\tilde{A}; r_1, \dots, r_t)$ again. \square

For nonnegative integers m and n , the q -ascending factorial is defined by $(a; q)_n = (1 - a)(1 - aq) \cdots (1 - aq^{n-1})$ and the q -binomial coefficient is defined by

$$\begin{bmatrix} n \\ m \end{bmatrix}_q = \frac{(q; q)_n}{(q; q)_m (q; q)_{n-m}} \quad \text{for } 0 \leq m \leq n.$$

Remark. The peeling algorithm gives a bijective proof of the formula

$$\begin{aligned} \frac{1}{(q; q)_m} &= \begin{bmatrix} m+a \\ a \end{bmatrix}_q \times \frac{1}{(q^{a+1}; q)_m} \\ &= \begin{bmatrix} m+a \\ a \end{bmatrix}_q \times \sum_{t \geq 0} q^{t(a+1)} \begin{bmatrix} m-1+t \\ t \end{bmatrix}_q, \end{aligned}$$

where t means the number of removed rim hooks. See [And98, Eq. (3.3.7)].

3 Main result

Let $\mathcal{F}_n(a, l, m)$ be the set of pointed partitions (λ, v) of n such that $a_v = a$, $l_v = l$ and $m_v = m$. We shall divide the construction of the involution Φ in three basic steps.

Step 1: Bessenrodt-Han decomposition $\varphi_{a,l,m} : (\lambda, v) \mapsto (A, B, C, D, E)$

Let $\mathcal{Q}_n(a, l, m)$ be the set of quintuples (A, B, C, D, E) such that A is a partition whose largest part is bounded by m , B is a partition whose diagram fits inside an $l \times a$ rectangle, C is a partition whose all parts are greater than or equal to $m + a + 1$, D is a partition whose diagram is an $(l + 1) \times (m + 1)$ rectangle, E is a partition whose diagram is an $1 \times a$ rectangle, and

$$|A| + |B| + |C| + |D| + |E| = n.$$

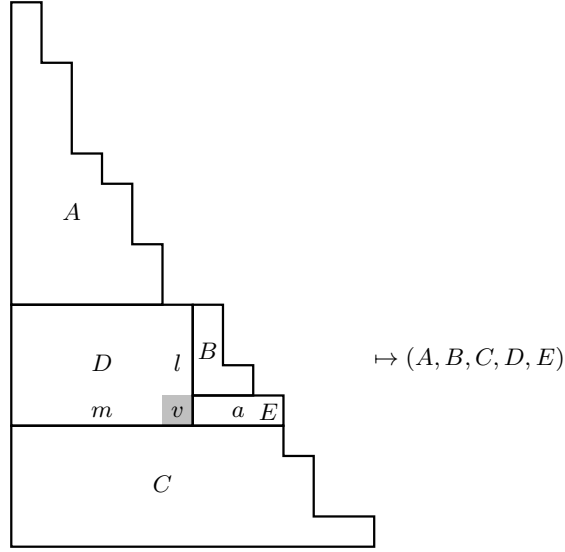

Figure 5: Bessenrodt-Han decomposition of a pointed partition (λ, v)

Suppose that $(\lambda, v) \in \mathcal{F}_n(a, l, m)$. First of all, we decompose the diagram of λ into five regions (A, B, C, D, E) as shown in Figure 5, modified slightly from the decomposition made in [BH09], in which E is implicit. Denote this decomposition by $\varphi_{a,l,m}$.

Merging the other partitions B, C, D , and E in bottom of A , we recover a pointed partition (λ, v) . So $\varphi_{a,l,m}$ is a bijection from $\mathcal{F}_n(a, l, m)$ to $\mathcal{Q}_n(a, l, m)$.

Example. For the pointed partition $(\lambda, v) \in \mathcal{F}_{101}(3, 3, 5)$ with

$$\lambda = (12, 10, 10, 9, 9, 8, 7, 7, 5, 5, 4, 4, 3, 2, 2, 2, 1, 1) \quad \text{and} \quad v = (6, 5),$$

the decomposition is given by (A, B, C, D, E) with $A = (5, 5, 4, 4, 3, 2, 2, 2, 1, 1)$, $B = (2, 1, 1)$, $C = (12, 10, 10, 9)$, $D = (6, 6, 6, 6)$ and $E = (3)$.

Step 2: Transformation $\psi_{a,l,m} : (A, B, C, D, E) \mapsto (\tilde{A}, B, \tilde{C}, D, E)$

Let $\tilde{\mathcal{Q}}_n(a, l, m)$ be the set of quintuples $(\tilde{A}, B, \tilde{C}, D, E)$ such that \tilde{A} is a partition whose diagram fits inside an $a \times m$ rectangle, B is a partition whose diagram fits inside an $l \times a$ rectangle, \tilde{C} is a partition whose all parts are greater than or equal to $a + 1$, D is a partition whose diagram is an $(l + 1) \times (m + 1)$ rectangle, E is a partition whose diagram is an $1 \times a$ rectangle, and

$$|\tilde{A}| + |B| + |\tilde{C}| + |D| + |E| = n.$$

Note that the partitions \tilde{A}, B, \tilde{C} , and E could be empty. The mapping $\psi_{a,l,m}$ from $\mathcal{Q}_n(a, l, m)$ to $\tilde{\mathcal{Q}}_n(a, l, m)$ is defined by $\psi_{a,l,m}(A, B, C, D, E) = (\tilde{A}, B, \tilde{C}, D, E)$ as follows:

- Applying the peeling algorithm to A , we have $(\tilde{A}; r_1, \dots, r_t)$. In the above example, we have $\tilde{A} = (5, 3, 1)$ and $(r_1, r_2, r_3) = (5, 7, 8)$ with $t = 3$.
- Gluing r_t, \dots, r_1 to C , we get the partition $\tilde{C} = (C, r_t, r_{t-1}, \dots, r_1)$ obtained by adding r_i 's to the partition C . Clearly, all parts of \tilde{C} are greater than or equal to $a + 1$.

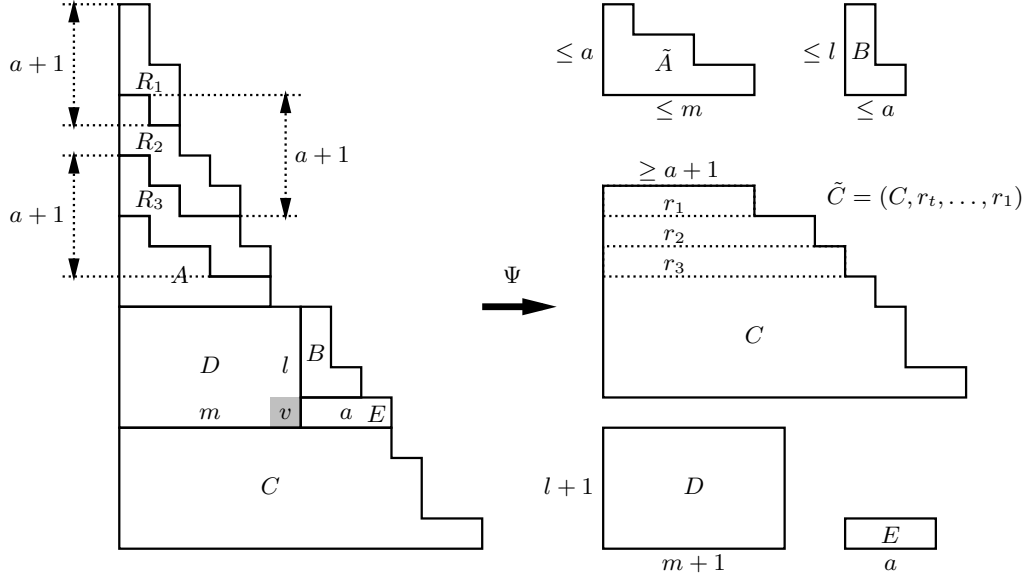

Figure 6: Pointed partition (λ, v) and its corresponding quintuples $(\tilde{A}, B, \tilde{C}, D, E)$ by Ψ

We can construct the inverse of the mapping $\psi_{a,l,m}$ as follows: Move out all parts r_i , $i = 1, \dots, t$, of size at most $a + m$ from a partition \tilde{C} and denote the remained partition by C . By Lemma 1, A can be recovered from $(\tilde{A}; r_1, \dots, r_t)$.

Example. Continuing the previous example, we have $(r_1, r_2, r_3) = (5, 7, 8)$, $(\tilde{A}, B, \tilde{C}, D, E) \in \mathcal{Q}_{101}(3, 3, 5)$ with $\tilde{A} = (5, 3, 1)$, $B = (2, 1, 1)$, $\tilde{C} = (12, 10, 10, 9, 8, 7, 5)$, $D = (6, 6, 6, 6)$ and $E = (3)$.

So every pointed partition $(\lambda, v) \in \mathcal{F}_n(a, l, m)$ can be transformed into five partitions $(\tilde{A}, B, \tilde{C}, D, E) \in \tilde{\mathcal{Q}}_n(a, l, m)$ by $\psi_{a,l,m} \circ \varphi_{a,l,m}$, as shown in Figure 6. Let $\tilde{\mathcal{Q}}_n$ be the disjoint union of the sets $\tilde{\mathcal{Q}}_n(a, l, m)$ for all $a, l, m \geq 0$. Define the bijection Ψ from \mathcal{F}_n to $\tilde{\mathcal{Q}}_n$ by

$$\Psi(\lambda, v) = \psi_{a,l,m} \circ \varphi_{a,l,m}(\lambda, v) \quad \text{if } (\lambda, v) \in \mathcal{F}_n(a, l, m).$$

Step 3: The involution $\rho : (\tilde{A}, B, \tilde{C}, D, E) \mapsto (B', \tilde{A}', \tilde{C}, D', E)$

Define the involution ρ on $\tilde{\mathcal{Q}}_n$ by

$$\rho(\tilde{A}, B, \tilde{C}, D, E) = (B', \tilde{A}', \tilde{C}, D', E),$$

where X' is the conjugate of the partition X .

Example. Continuing the previous example, we have $\rho(\tilde{A}, B, \tilde{C}, D, E) = (B', \tilde{A}', \tilde{C}, D', E)$, where

$$B' = (3, 1), \quad \tilde{A}' = (3, 2, 2, 1, 1), \quad D' = (4, 4, 4, 4, 4, 4).$$

Theorem 2. For all $n \geq 0$, the mapping $\Phi = \Psi^{-1} \circ \rho \circ \Psi$ is an involution on \mathcal{F}_n such that if $\Phi : (\lambda, v) \mapsto (\mu, u)$ then

$$(a_v, l_v, m_v)(\lambda) = (a_u, m_u, l_u)(\mu). \quad (4)$$

In particular, the mapping Φ also satisfies

$$(h_v, p_v)(\lambda) = (p_u, h_u)(\mu). \quad (5)$$

Proof. By definition, the restriction of ρ on $\tilde{\mathcal{Q}}_n(a, l, m)$ is a bijection from $\tilde{\mathcal{Q}}_n(a, l, m)$ to $\tilde{\mathcal{Q}}_n(a, m, l)$. Hence, for any $(\lambda, v) \in \mathcal{F}_n(a, l, m)$, we have

$$\begin{aligned} \Phi(\lambda, v) &= \Psi^{-1} \circ \rho \circ \Psi(\lambda, v) \\ &= \varphi_{a,m,l}^{-1} \circ \psi_{a,m,l}^{-1} \circ \rho \circ \psi_{a,l,m} \circ \varphi_{a,l,m}(\lambda, v) \in \mathcal{F}_n(a, m, l). \end{aligned}$$

Clearly the mapping Φ is an involution on \mathcal{F}_n satisfying (4) and (5). \square

Remark. In other words, we have the following diagram:

$$\begin{array}{ccccc} & \mathcal{F}_n(a, l, m) & \xrightarrow{\Phi} & \mathcal{F}_n(a, m, l) & \\ \varphi_{a,l,m} \swarrow & & & & \swarrow \varphi_{a,m,l}^{-1} \\ \mathcal{Q}_n(a, l, m) & & & & \mathcal{Q}_n(a, m, l) \\ \psi_{a,l,m} \searrow & \Psi \downarrow & & \uparrow \Psi^{-1} & \nearrow \psi_{a,m,l}^{-1} \\ & \tilde{\mathcal{Q}}_n(a, l, m) & \xrightarrow{\rho} & \tilde{\mathcal{Q}}_n(a, m, l) & \end{array}$$

Example. Continuing the above example, we have $\Phi(\lambda, v) = (\mu, u) \in \mathcal{F}_{101}(3, 5, 3)$ with

$$\mu = (12, 10, 10, 9, 8, 7, 7, 7, 6, 6, 5, 5, 3, 2, 2, 1, 1) \quad \text{and} \quad u = (4, 7).$$

To end this section we draw a graph on \mathcal{F}_4 to illustrate the bijection Φ on \mathcal{F}_4 by connecting each (λ, v) to $\Phi(\lambda, v)$ (see Figure 2) as follows:

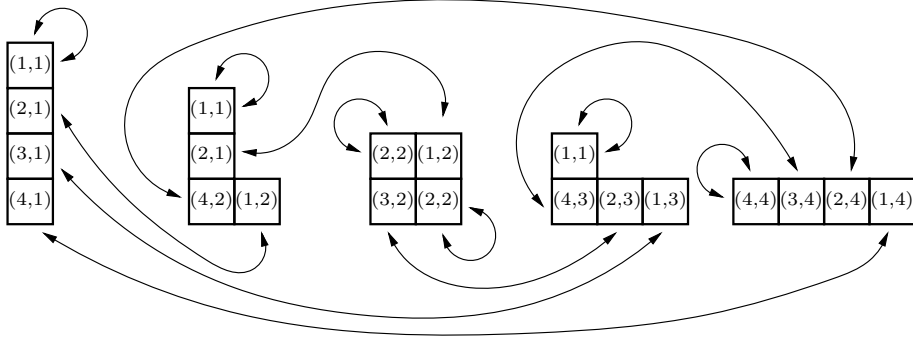

4 Some consequences

We derive immediately the following result of Bessenrodt and Han [BH09, Theorem 3].

Corollary 3. *The triple statistic (a_v, l_v, m_v) has the same distribution as (a_v, m_v, l_v) over \mathcal{F}_n . In other words, the polynomial*

$$Q_n(x, y, z) = \sum_{(\lambda, v) \in \mathcal{F}_n} x^{a_v} y^{l_v} z^{m_v}$$

is symmetric in y and z .

Let $f_n(a, l, m)$ be the cardinality of $\mathcal{F}_n(a, l, m)$, that is, $f_n(a, l, m)$ is the coefficient of $x^a y^l z^m$ in $Q_n(x, y, z)$. We can apply the bijection Φ to give a different proof of Bessenrodt and Han's formula [BH09, Theorem 2] for $\sum_{n \geq 0} f_n(a, l, m) q^n$.

Corollary 4. *The generating function of $f_n(a, l, m)$ is given by the following formula*

$$\sum_{n \geq 0} f_n(a, l, m) q^n = \frac{1}{(q^{a+1}; q)_\infty} \begin{bmatrix} m+a \\ a \end{bmatrix}_q \begin{bmatrix} l+a \\ a \end{bmatrix}_q q^{(m+1)(l+1)+a},$$

where $(a; q)_\infty := \prod_{i=0}^{\infty} (1 - aq^i)$.

Proof. By the bijection ψ the generating function $\sum_{\lambda} q^{|\lambda|}$, where $(\lambda, v) \in \mathcal{F}_n(a, l, m)$, is equal to the product of the corresponding generating functions of the five partitions A, B, \tilde{C}, D and E . In view of the basic facts about partitions (see [And98, Chapter 3]), it is easy to see that $D(q) = q^{(m+1)(l+1)}$, $E(q) = q^a$, and

$$A(q) = \begin{bmatrix} m+a \\ a \end{bmatrix}_q; \quad B(q) = \begin{bmatrix} l+a \\ a \end{bmatrix}_q; \quad \tilde{C}(q) = \frac{1}{(q^{a+1}; q)_\infty}.$$

Multiplying the five generating functions yields the result. \square

A polynomial $P(x, y)$ in two variables x and y is *super-symmetric* if

$$[x^\alpha y^\beta] P(x, y) = [x^{\alpha'} y^{\beta'}] P(x, y)$$

when $\alpha + \beta = \alpha' + \beta'$. Clearly, any super-symmetric polynomial is also symmetric.

It is known (see [Bes98, BM02, BH09]) that the generating function for the pointed partitions of \mathcal{F}_n by the two joint statistics arm length and coarm length (resp. leg length) is super-symmetric. In other words, the polynomial

$$\sum_{(\lambda, v) \in \mathcal{F}_n} x^{a_v} y^{m_v} \quad (\text{resp.} \quad \sum_{(\lambda, v) \in \mathcal{F}_n} x^{a_v} y^{l_v})$$

is super-symmetric. Note that the above two polynomials are actually equal due to Corollary 2.

Let $\mathcal{F}_n(a, *, m)$ (resp. $\mathcal{F}_n(a, l, *)$) be the set of pointed partitions (λ, v) of n such that $a_v = a$ and $m_v = m$ (resp. $a_v = a$ and $l_v = l$).

It is easy to give a combinatorial proof of the super-symmetry of the first polynomial $\sum_{(\lambda, v) \in \mathcal{F}_n} x^{a_v} y^{m_v}$. Indeed, if $\alpha + \beta = \alpha' + \beta'$ and $(\lambda, v) \in \mathcal{F}_n(\alpha, *, \beta)$, let u be the unique cell on the same row as v satisfying $a_u(\lambda) = \alpha'$ and $m_u(\lambda) = \beta'$, then $\tau_{\alpha, \beta, \alpha', \beta'} : (\lambda, v) \mapsto (\lambda, u)$, is a bijection from $\mathcal{F}_n(\alpha, *, \beta)$ to $\mathcal{F}_n(\alpha', *, \beta')$.

Combining the bijection $\tau_{\alpha, \beta, \alpha', \beta'}$ with the involution Φ we can prove bijectively the super-symmetry of the polynomial $\sum_{(\lambda, v) \in \mathcal{F}_n} x^{a_v} y^{l_v}$. More precisely we have the following result.

Theorem 5. *If $\alpha + \beta = \alpha' + \beta'$, the mapping $\zeta_{\alpha, \beta, \alpha', \beta'} = \Phi \circ \tau_{\alpha, \beta, \alpha', \beta'} \circ \Phi$ is a bijection from $\mathcal{F}_n(\alpha, \beta, *)$ to $\mathcal{F}_n(\alpha', \beta', *)$.*

Proof. Fix nonnegative integers α, β, α' , and β' satisfying $\alpha + \beta = \alpha' + \beta'$. By Theorem 2, the mapping Φ is a bijection from $\mathcal{F}(\alpha, \beta, *)$ to $\mathcal{F}_n(\alpha, *, \beta)$ and also a bijection from $\mathcal{F}(\alpha', *, \beta')$ to $\mathcal{F}_n(\alpha', \beta', *)$. Since the mapping $\tau_{\alpha, \beta, \alpha', \beta'}$ is a bijection from $\mathcal{F}(\alpha, *, \beta)$ to $\mathcal{F}_n(\alpha', *, \beta')$, it

is obvious that the mapping $\zeta_{\alpha,\beta,\alpha',\beta'} = \Phi \circ \tau_{\alpha,\beta,\alpha',\beta'} \circ \Phi$ is a bijection from $\mathcal{F}_n(\alpha, \beta, *)$ to $\mathcal{F}_n(\alpha', \beta', *)$. The bijection $\zeta_{\alpha,\beta,\alpha',\beta'}$ is illustrated as follows:

$$\begin{array}{ccc} \mathcal{F}_n(\alpha, \beta, *) & \xrightarrow{\zeta_{\alpha,\beta,\alpha',\beta'}} & \mathcal{F}_n(\alpha', \beta', *) \\ \Phi \downarrow & & \uparrow \Phi \\ \mathcal{F}_n(\alpha, *, \beta) & \xrightarrow{\tau_{\alpha,\beta,\alpha',\beta'}} & \mathcal{F}_n(\alpha', *, \beta') \end{array} .$$

We are done. □

Theorem 4 yields that the generating function of \mathcal{F}_n by the bivariate joint distribution of arm length and leg length is super-symmetric.

Acknowledgement

This work is supported by la Région Rhône-Alpes through the program “MIRA Recherche 2008”, project 08 034147 01.

References

- [And98] George E. Andrews, *The theory of partitions*, Cambridge Mathematical Library, Cambridge University Press, Cambridge, 1998, Reprint of the 1976 original.
- [Bes98] Christine Bessenrodt, *On hooks of Young diagrams*, Ann. Comb. **2** (1998), no. 2, 103–110.
- [BH09] Christine Bessenrodt and Guo-Niu Han, *Symmetry distribution between hook length and part length for partitions*, Discrete Mathematics (2009), doi:10.1016/j.disc.2009.05.012.
- [BM02] Roland Bacher and Laurent Manivel, *Hooks and powers of parts in partitions*, Sémin. Lothar. Combin. **47** (2001/02), Article B47d, 11 pp. (electronic).