

Phoenix Cloud: Consolidating Heterogeneous Workloads of Large Organizations on Cloud Computing Platforms

Jianfeng Zhan, Lei Wang, Bibo Tu, Yong Li, Peng Wang, Wei Zhou, Dan Meng

Institute of Computing Technology
Chinese Academy of Sciences, Beijing 100190, China
jfzhan@ncic.ac.cn

About this document

This document is dated from 08/13/08 and contains an early summary of experiences of this project. The extended version of this paper with the title of “PhoenixCloud: Provisioning Runtime Environments for Heterogeneous Cloud Workloads” is under review of IEEE Transaction on Service Computing, which can be downloaded from <http://arxiv4.library.cornell.edu/abs/1003.0958>

ABSTRACT

For a large organization, different departments often maintain dedicated cluster systems for different workloads, for example parallel batch jobs or Web services. In this paper, we design and implement an innovative cloud computing system software, *Phoenix Cloud*, to consolidate heterogeneous workloads of the same organization on the cloud computing platform. For Phoenix Cloud, we propose cooperative resource provision and management policies for the affiliated departments of a large organization to share the cluster system. The simulation experiments show: comparing with the previous solution, Phoenix Cloud significantly decreases the configuration scale of the cluster system through consolidating heterogeneous workloads of the same organization, and at the same time increases the number of completed jobs for parallel workload while provisioning enough resources to Web service with varying load.

1. INTRODUCTION

In 2007, a client from a large organization, which we keep anonymous at its request, inquired us whether it is possible to help them consolidate two heterogeneous workloads on a shared cluster system. This large organization has two representative departments: one maintaining a batch queuing system for scientific computing, and the other one responsible of providing Web service, of which the ratio of the peak load to normal load is high. Two representative departments from this big organization have operated two clusters with independent administration staffs and found many annoying problems: first, the resource utilization rates of two cluster systems are varying. For peak load of Web service, the dedicated cluster can not provision

enough resource, while for normal load lots of resources are idle; secondly, the number of administration staffs for two separated cluster systems is high.

At same time, we have noticed that many famous IT companies are advocating and experiencing cloud computing. For example, Amazon [1] has provided cloud computing services like elastic computing cloud (EC2) and simple storage service (S3) to end users. What is the link between the service provided by Amazon and the requirement of our anonymous client? In our opinion, driven by the cost, the cloud computing is a new wave of reconstructing and consolidating data center. Traditional cluster system software is self-containing [2], inadequate for adapting to this change. EC2 and S3 are big efforts of providing consolidated hosting environments for end users, but there lies no one-fit-all solution.

In this paper, we focus on developing cloud computing system software, which enables the consolidation of heterogeneous workloads on the shared cluster system for a large organization, and we stress that *we do not target the design of capability-oriented system software stack* [3]. To the best of our knowledge, this is the first paper to propose the cloud computing system software to consolidate heterogeneous workloads on the shared cluster system. The paper of [4] proposes the utility computing service framework to facilitate the code reuse in the context of traditional data center, but do not consider how to enable the consolidation of heterogeneous workloads. The papers of [5] [6] propose the COD (Cluster on Demand) as the new mechanism for dynamical cluster resource management in the context of Internet hosting center [5] or scientific computing [6], but their works mainly focus on

the dynamic resource provision in the context of homogeneous computing workloads.

The distinguished difference of our system and architecture from others is that: we develop the *common service framework* as the foundation of cloud computing system software. With the support of common service framework, we create two *cloud management services* respectively for parallel batch jobs and Web service, which cooperatively share the cluster resource. The contribution of this paper can be concluded as:

- (1) We design and implement a cloud computing system software, Phoenix Cloud, to consolidate parallel batch jobs and Web services on the shared cluster system.
- (2) We propose cooperative resource provision and management policies for the affiliated departments of large organizations to share the cluster system.
- (3) Our simulation experiments show: comparing with previous solution, the consolidation of parallel batch jobs and Web services can significantly decrease the configuration scales of cluster systems of large organizations, and at the same time increase the number of completed jobs for parallel workloads while provisioning enough resource to Web service with varying load.

This structure of our paper includes four sections. In Section 2, we explain the design and implementation issue of Phoenix Cloud. In Section 3, we evaluate the new system. In Section 4, we draw a conclusion.

2. PHOENIX CLOUD DESIGN AND IMPLEMENTATION

In Section 2.1, we introduce the layered architecture of Phoenix Cloud. In Section 2.2, we propose cooperative resource provision and management policy of Phoenix Cloud.

2.1. The layered architecture of Phoenix Cloud

For a large organization, we divide the cloud computing system software into three independent layers: the shared infrastructure, the cloud management services for service providers, different departments, and the client tool for end users. Figure 1 shows the macro-level architecture of our new system as follows:

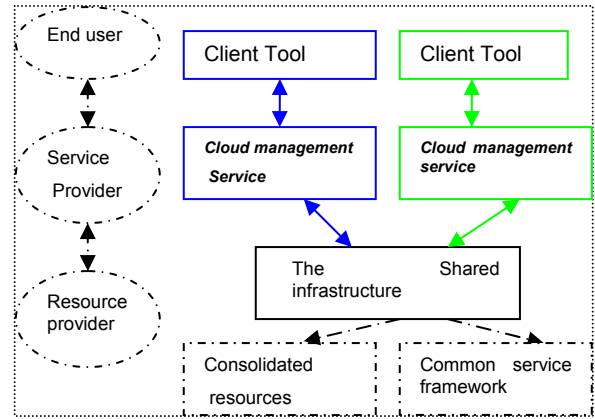

Fig.1. Layered architecture of Phoenix Cloud.

- (1) The *shared infrastructure* is provided by the resource provider, which includes the *shared resources* and the *common services framework*. The *shared resources* include hardware resources, e.g. CPU, memory, and system software, e.g. host operating system.
- (2) The *common services framework* is provided by the resource provider as a set of services to manage and monitor the shared resources, provision resources to different *cloud management services* of different service providers.
- (3) The *cloud management service (CMS)* is the management service for specific workload.
- (4) The *Client tool*: each end user uses the client tool to access services or submit jobs.

Fig.2 shows the micro-level architecture of Phoenix Cloud when two cloud management services share a cluster system and reuse common service framework. The one is the cloud management service for parallel batch jobs (PB CMS), including the PB Server and the scheduler, and the other is the cloud management service for Web services (WS CMS), including the WS Server and the load balancer

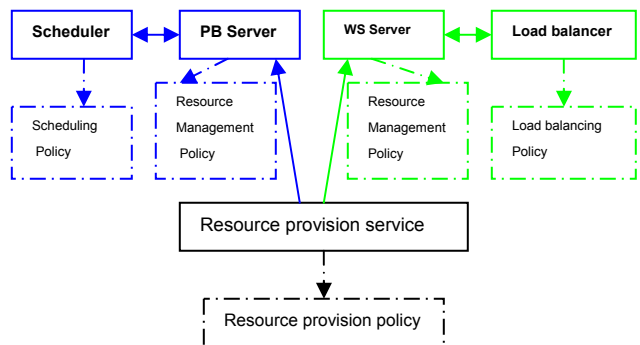

Fig.2. Micro-architecture of Phoenix Cloud.

- (1) Among the common service framework, a service that is named *the resource provision service* with the customized *resource provision policy* acts as the proxy of a large organization, responsible for managing and provisioning resources to different cloud management services.

- (2) The *resource provision policy* determines when the resource provision service will provision how many resources to different cloud management services in what priority.
- (3) The *cloud management service* with the customized *resource management policy* and *scheduling/load balancing policy* behaves as the representative of a service provider, responsible for managing resource, scheduling jobs or distributing requests for load balancing.
- (4) The *resource management policy* of a service provider determines when the Server, the PB Server or the WS Server, obtains or returns how many resources to the resource provision service according to what criteria.
- (5) The *Scheduling policy* determines the scheduler of a PB CMS when and how to choose parallel batch job for running.
- (6) The *Load balancing policy* determines the load balancer of WS CMS how to distribute requests and adjust the number of Web service instances according to what criteria.

Phoenix Cloud evolves from our previous Phoenix system [8] [9]. Based on the Phoenix common service framework, we have developed two different cloud management services respectively for parallel batch jobs and Web service on the shared cluster system. Fig.3 shows the architecture of PB CMS and WS CMS based on the Phoenix common service framework. The function of PB CMS is similar to OpenPBS [10], while the function of WS CMS is similar to Océano [11]. But the distinguished differences of Phoenix Cloud have two points: (1) Phoenix Cloud supports the consolidation of heterogeneous workloads on the shared system; (2) different cloud management services reuse the same common service framework.

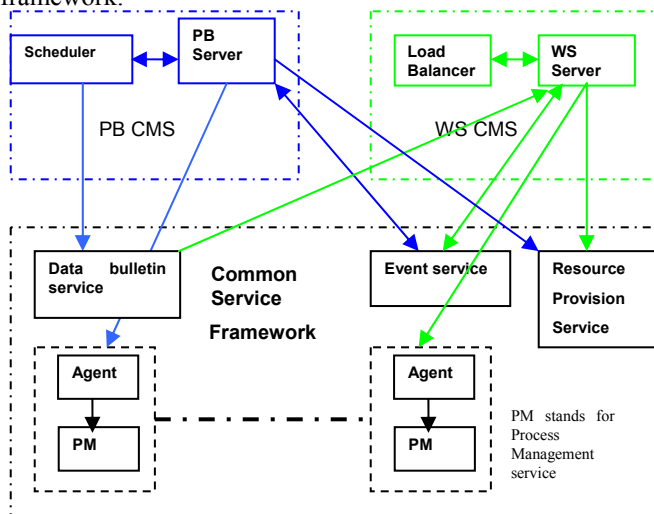

Fig.3. For Phoenix Cloud, two cloud management services reuse and share the common service framework.

2.2. The cooperative resource provision and management policy

In this section, we propose a cooperative resource provision and management policy for the large organization. As shown in Fig.2, we can specify the resource provision policy for the resource provision service, different resource management policies for the PB Server and the WS Server. The resource provision policy is as follows:

- The resource provision service allocates resources to the PB Server and the WS Server within the limit of the *fixed baseline size* (in short, FBS).
- The resource demands of the WS Server have higher priority than that of the PB Server.
- If there are idle resources for the resource provision service, it will provision all idle resources to the PB Server.
- If the WS Server requests urgent resources, the resource provision service will force the PB Server to return the resources with the size claimed by the WS Server and then reallocate those resources to the WS Server.

The resource management policy of the PB Server is as follows:

- The PB Server proactively receives the resources provisioned by the resource provision service.
- If the resource provision service forces the PB Server to return resources, the latter will return resources immediately with the size demanded by the resource provision service.
- If there are no enough idle resources for the PB Server, it will kill jobs in turn from the beginning of job with minimum size of resource demand, and return enough resources to the resource provision service. If there is more than one job with the same size of resource demand, it will firstly kill the job with the shortest running time.

The resource management policy of the WS Server is as follows:

- If there are idle resources for the WS Server, it returns resource to the resource provision service immediately. If the WS Server needs more resources, it will request enough resources from the resource provision service.

3. EVALUATION AND DISCUSSION

In this section, we will demonstrate that consolidating parallel batch jobs and Web services with Phoenix Cloud can decrease the configuration scales of cluster systems for large organizations, comparing with the case that each

department maintains its own dedicated cluster system, of which we call *DCS*.

3.1. The benefit and cost models

For a large organization, we briefly use the configuration scale of a cluster system to measure the cost of owning cluster systems.

For parallel batch jobs, we use *the number of completed jobs* to measure the *benefit* of a job-execution service provider; at the same time, we use *the reciprocal of the average turnaround time per job* to measure the benefit of end user.

For Web services, we briefly use the *throughput in term of request/second* to measure the benefit of Web service provider; at the same time we use *the average response time per requests* to measure the *benefit* of end user.

3.2. Experiment method and workload traces

Our experiments include two parts: first, in Section 3.3 we obtain the real resource consumption of Web service under varying load on the testbed. Secondly, based on the real resource consumption of Web service obtained in section 3.3, we use the simulation method to obtain the real resource consumption when consolidating parallel batch jobs and Web services from different departments on the shared cluster system.

The synthetic *workload trace of Web service* is obtained from the real trace of World Cup load of two week from June 7 to June 20 in 1998 [12] with a scaling factor of 2.22, of which the ratio of peak load to normal load is high.

The workload trace of parallel batch jobs is the real trace of SDSC BLUE of two weeks from Apr 25 15:00:03 PDT 2000 on the web site of <http://www.cs.huji.ac.il/labs/parallel/workload/logs.html>.

3.3. The resource consumption of Web service under varying load

The testbed is as follows: All nodes are connected with a 1 Gb/s switch. Each node has same configuration: CPU-8×Intel(R) Xeon(R) (2.00GHz); memory- 2G; OS- 64-bit Linux with kernel of 2.6.18-xen. On each node, we deploy eight XEN [13] virtual machines. The configuration of XEN virtual machine is: CPU-1×Intel(R) Xeon(R)(2.00GHz); memory- 256M; the guest operating system is 64-bit CentOS with kernel version of 2.6.18.

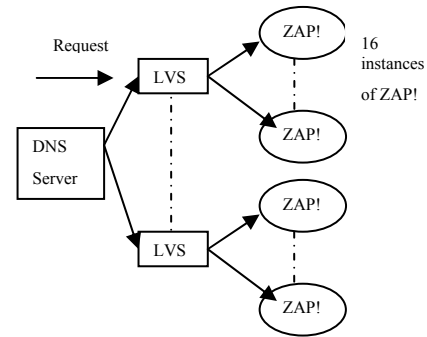

Fig.4. The system deployment diagram.

Fig.4 shows the system deployment diagram. We choose httpperf [14] as a load generator. LVS [15] with direct route mode is responsible for distributing requests to Web service with the least-connection scheduling policy. The DNS server is responsible for distributing connection from each user to one of the four LVS with the round robin policy. We choose open source software ZAP! [7] as the target application, and each instance of ZAP! is deployed on a virtual machine.

The WS Server adjusts the number of Web service instances according to the criterion of average utilization rate of CPU consumed by instances of Web service. We presume that the current number Web service instances of is n . If the average utilization rate of CPUs consumed by Web service instances exceeds 80% in the past twenty seconds, the WS Server will increase one instance. If the average utilization rate of CPUs consumed by Web service instances is lower than 80% $(n-1)/n$ in the past twenty seconds, the WS Server will decrease one instance until the number of current instances is equal to one.

We use *the workload trace of Web service* described in Section 3.2. Fig.5 shows the varying resource consumption in two weeks for Web services workload trace, of which the peak resource demand is 64 virtual machines.

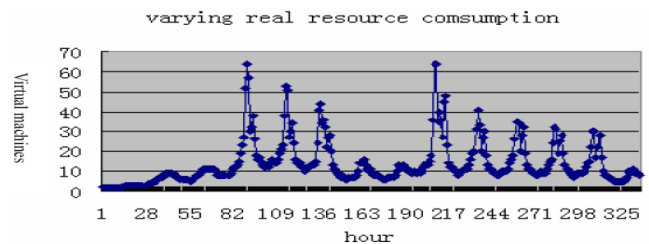

Fig.5. The resource consumption of Web service trace in two weeks.

3.4. The simulation experiments of consolidating workloads

We use the simulation method to verify the advantage of consolidating heterogeneous workloads from different

departments of a large organization on the shared cluster system. Fig.6 shows the architecture of our simulation system, which includes one cloud management service for parallel batch jobs (PB CMS) and one cloud management service for Web service (WS CMS). In comparison with the real Phoenix Cloud system, our simulated system maintains the resource provision service, the WS Server, the PB Server and the scheduler, while other services are removed or substituted.

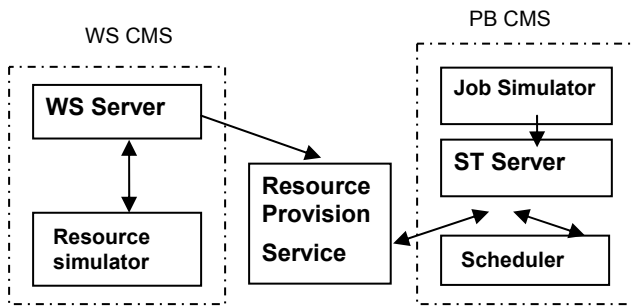

Fig.6. The hybrid experiment system.

For WS CMS, the resource simulator simulates the varying resource demand of WS CMS and drive the WS Server to obtain or return resources from and to the resource provision service. We use the real resource consumption of Fig.5 as the input to the resource simulator.

For PB CMS, the scheduler is specified with the First-Fit scheduling policy, and a job simulator is used to simulate the process of submitting jobs. To accelerate the experiment, we speed up the submission and completion of jobs by a factor of 100. This speedup allows the trace of two weeks to complete in about three hours. The trace of parallel batch jobs is introduced in Section 3.2.

We presume that the software package of Web service are pre-deployed on those reallocated nodes, so the time of reallocating nodes from the PB Server to the WS Server is only seconds, includes the time of killing jobs and communicating among the WS Server, the PB Server and the resource provision service.

In our simulation experiment, for Phoenix Cloud, we respectively set the fixed baseline size (in short, FBS) , allocated to Web service and parallel batch jobs , as 200, 190, 180, 170, 160 and 150. Fig.7 shows the number of completed jobs and average turnaround time per job in two weeks when we set different FBS.

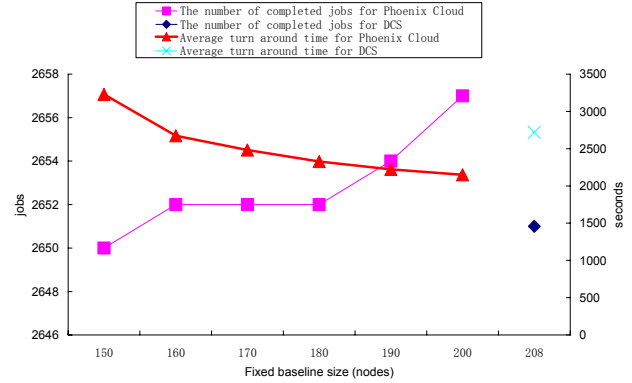

Fig.7. For parallel batch jobs trace, the number of jobs completed and average turnaround time per job in two weeks V.S. FBS.

For the parallel batch jobs trace, 2672 jobs are submitted to the PB Server. For Phoenix Cloud, when the FBS decreases to 160, only 76.9% of that of DCS, the number of completed jobs of Phoenix Cloud in two weeks is still higher than that of DCS; while the benefit of end user in term of the reciprocal of average turnaround time per job is still higher than that of DCS. As shown in Fig.8, with the value of FBS decreases, the number of killed jobs increases in general.

For Web services, the throughput in terms of requests per second is unchanging, since we just use the real resource consumption in Section 3.3 as the input of the resource simulator.

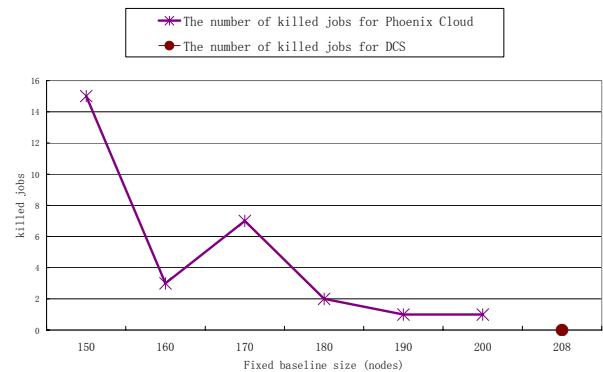

Fig.8. For parallel batch jobs trace, the number of killed jobs in two weeks V.S. FBS.

4. CONCLUSION

In this paper, we have designed and implemented an innovative cloud computing system software, Phoenix Cloud, to consolidate heterogeneous workloads of large organizations on the shared cluster system. We have proposed cooperative resource provision and management polices for the affiliated departments of a large organization to share the cluster system.

Our experiments show: comparing with the DCS case that each department maintains its dedicated cluster system, our system Phoenix Cloud with cooperative resource provision and management policy can significantly decrease the configuration scale of cluster systems for large organizations, at the same time it increases the number of completed jobs for parallel workloads while provisioning enough resources to Web service with varying load.

5. ACKNOWLEDGMENTS

This paper is supported by the National Science Foundation for Young Scientists of China (Grant No. 60703020).

6. REFERENCES

- [1] Amazon: <http://aws.amazon.com/>
- [2] Raghavan, B., Vishwanath etc. , Cloud control with distributed rate limiting. In *Proceedings of SIGCOMM '07*. ACM, New York, NY, 337-348.
- [3] Jean-Charles Tournier, Patrick G. Bridges etc, Towards a Framework for Dedicated Operating Systems Development in High-End Computing Systems, *ACM SIGOPS Operating Systems Review*, Volume 40 , Issue 2, April 2006
- [4] Eilam, T., Appleby etc, Using a utility computing framework to develop utility systems. *IBM Syst. J.* 43, 1 (Jan. 2004), 97-120.
- [5] Chase, J. S., Anderson, D. C., Thakar, P. N., Vahdat, A. M., and Doyle, R. P. 2001. Managing energy and server resources in hosting centers. *SOSP '01*. ACM, New York, NY, 103-116.
- [6] Chase, J. S., Irwin etc., Dynamic Virtual Clusters in a Grid Site Manager. *HPDC 03*.
- [7] <http://www.indexdata.dk/>
- [8] Jianfeng Zhan, Ninghui Sun, Fire Phoenix Cluster Operating System Kernel and its Evaluation, *Proceeding of IEEE Cluster 2005*, Boston, MA, USA.
- [9] Jianfeng Zhan, Lei Wang etc, The Design Methodology of Phoenix System Software Stack, *Workshop on High Performance Computing in China: Solution Approaches to Impediments for High Performance Computing in conjunction with SC 07*.
- [10] OpenPBS: <http://www-unix.mcs.anl.gov/openpbs/>
- [11] K. Appleby, S. Fakhouri, L. Fong, G. Goldszmidt, M. Kalantar, S. Krishnakumar, D. P. Pazel, J. Pershing, B. Rochwerger, "Océano--SLA Based Management of a Computing Utility," *Proceedings of the 7th IFIP/IEEE International Symposium on Integrated Network Management*, IEEE, New York (2001).
- [12] Martin Arlitt, Tai Jin, *Workload Characterization of the 1998 World Cup Web Site*, Copyright Hewlett-Packard Company, 1999
- [13] XEN: <http://www.xen.org>
- [14] <http://www.hpl.hp.com/research/linux/httpperf/>
- [15] LVS: <http://www.linuxvirtualserver.org/>