

# A Cherenkov Radiation Detector with High Density Aerogels

Lucien Cremaldi *Member, IEEE*, David A. Sanders *Member, IEEE*, Peter Sonnek, Don J. Summers, Jim Reidy, Jr.

**Abstract**—We have designed a threshold Cherenkov detector at the Rutherford-Appleton Laboratory to identify muons with momenta between 230 and 350 MeV/c. We investigated the properties of three aerogels for the design. The nominal indexes of refraction were  $n = 1.03$ ,  $1.07$ ,  $1.12$ , respectively. Two of the samples are of high density aerogel not commonly used for Cherenkov light detection. We present results of an examination of some optical properties of the aerogel samples and present basic test beam results.

**Index Terms**—Aerogels, Cherenkov detectors, Mesons, Particle identification, Particle beam measurements

## I. INTRODUCTION

COOLED muons are required for a Neutrino Factory based on a muon storage ring [1], [2], [3] and for a muon collider [4], [5], [6], [7]. The Muon Ionization Cooling Experiment (MICE) [8], [9] at Rutherford-Appleton Lab is the first test of the ionization cooling concept for muon beams. To establish muon cooling a high purity muon beam is positively identified in the momentum range 230 to 350 MeV/c by both time-of-flight and Cherenkov techniques. Silica aerogel has been successfully used in Cherenkov particle identification detectors in the past [10], [11], [12], [13]. The Spherical Neutral Detector (SND) also uses high density silica aerogel [14]. Based on these and our work with gas threshold Cherenkov counters [15], we chose high density silica aerogels from the Matsushita Electric Works [16] for its high quality and hydrophobicity (water repellent nature).

We selected aerogels with indexes of refraction  $n=1.07$  ( $p_{th}^\mu=278$  MeV/c) and  $n=1.12$  ( $p_{th}^\mu=210$  MeV/c), these aerogels nicely filling the gap between gas and liquid radiators for our momentum range. These high density aerogels scatter heavily in the UV and visible and it is not well known if they can be effectively used for Cherenkov radiators. In our work we compared the scattering and absorptive properties of our high density samples to a commonly used silica aerogel with index  $n=1.03$ . The panel sizes were nominally 115 mm x 115 mm x 11.5 mm. We report on index of refraction, transmission, and scattering measurements, and we measure the light collection yields with particle beams. The panels are displayed below in Fig. 1.

## II. INDEX OF REFRACTION MEASUREMENTS

The index of refraction of the aerogel samples was measured in a straight-forward method using the total internal reflection

Lucien Cremaldi, David A. Sanders, Peter Sonnek, and Donald J. Summers are with the Department of Physics and Astronomy, University of Mississippi, University, MS, 38677 USA  
(email: cremaldi@phy.olemiss.edu, tel: +1-662-915-5311)

Jim Reidy, Jr. is with Oxford High School, Oxford, MS, 38655 USA

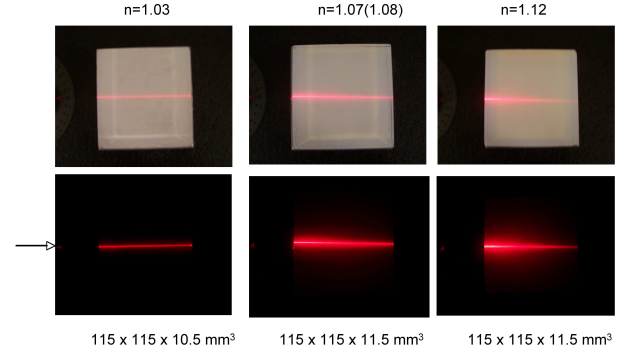

Fig. 1. Photograph of the aerogel panels under study with incident laser light. The beam is incident from the left.

technique described below. A red laser diode (638 nm) was mounted on a rotating platform with angle scale shown in Fig. 2. We could pinpoint the angle of total internal reflection  $r$  to a fraction of a degree. The angle  $p$  was determined by swiveling the laser beam until the point of total internal reflection (angle  $s = 90^\circ$ ). Using the relation

$$n = 1 + \sin^2(p) \quad (1)$$

we determined the index of refraction relating index  $n$  to angle  $p$ . The method has the advantage of yielding a small measurement error  $\Delta n \leq 0.005$  once the aerogel block is carefully aligned w.r.t. the laser beam. Due to slight irregularity at the aerogel edge we could measure the angle  $p$  to within  $\pm 0.5^\circ$ . The results are reported in Table I.

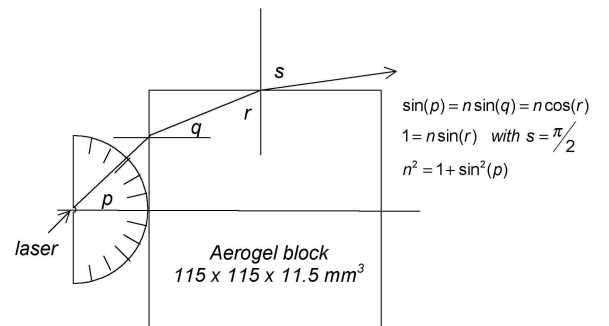

Fig. 2. Schematic of index of refraction measurement by total internal reflection method. Angle  $s$  is adjusted to  $\pi/2$  by the method.

Our measurement for the  $n=1.03$  aerogel (as certified by Matsushita [16]) agreed well at wavelength 638 nm. The change in index (chromatic dispersion) for the 1.03 aerogel is

TABLE I

TABLE I: INDEX OF REFRACTION MEASUREMENTS WITH THE INTERNAL REFRACTION TECHNIQUE ( $\lambda = 638 \text{ nm}$ ) OF THE  $n=1.03, 1.07, 1.12$  AEROGEL SAMPLES FROM MATSUSHITA.

Aerogel	$p$ degrees	$n$
Aerogel 1.03 (YI-30)	$14.0^\circ \pm 0.5^\circ$	$1.029 \pm 0.002$
Aerogel 1.07 (HY-80)	$22.2^\circ \pm 0.5^\circ$	$1.069 \pm 0.003$
Aerogel 1.12 (HY-120)	$29.1^\circ \pm 0.5^\circ$	$1.112 \pm 0.004$

TABLE II

TABLE II: DETERMINATION OF THE INDEX OF REFRACTION WITH THE DENSITY TECHNIQUE.

Aerogel	$V(\text{cc})$	$m(\text{g})$	$\rho \text{ (g/cc)}$	$n=1.000 + 0.279\rho$ [16]
$n=1.03$	138.86	15.634	$0.113 \pm 0.003$	$1.032 \pm 0.007$
$n=1.07$	152.08	38.792	$0.255 \pm 0.005$	$1.071 \pm 0.005$
$n=1.12$	152.08	56.293	$0.370 \pm 0.005$	$1.103 \pm 0.005$

reported [17] to be  $\Delta n = 0.0015$  over the range (325-635) nm, well within errors of our measurement technique.

### III. INDEX OF REFRACTION BY DENSITY

It is known that the aerogel index of refraction tracks with density in a linear approximation where coefficient  $\alpha \approx 0.28$ - $0.30$  for many aerogel samples

$$n = 1 + \alpha \times \rho . \quad (2)$$

We carefully measured the dimensions of the aerogel samples with optical technique and determine they were within  $\pm 500 \mu\text{m}$  of our 11.5 cm specification to Matsushita. Some thickness variation over the surface was noticed of order 100-200  $\mu\text{m}$ . The sample masses were measured on a precision scale to find the aerogel density  $\rho = m/V$  in (g/cc).

The indexes in Table II are determined from a Matsushita linear extrapolation  $n = 1.000 + 0.279\rho$  which works well for  $\rho \leq 0.25 \text{ g/cc}$ . For the higher density aerogel 112 sample our index measurement and density measurement may indicate some quadratic correction is needed, but still within error of the linear approximation.

### IV. MEASUREMENTS OF FORWARD TRANSMITTANCE

We performed a transmission  $T$  scan of the 11.5 mm thick aerogel tiles with a UV/VIS Spectrophotometer [18] to extract the aerogel scattering coefficients. The samples are positioned in the spectrometer so only the forward-going light cone ( $\Delta\theta_{1/2} \leq 3^\circ$ ) is accepted in to the spectrophotometer integrating sphere. We define this as a working definition of transmission  $T$  and do not correct for reflection at the sample interfaces  $\leq 0.7\%$  or surface scattering effects  $\leq 0.3\%$ . This yields a systematic measuring error on  $T$  of about 0.8%, well within our survey goal. The results are shown in Fig. 3.

If we assume Rayleigh scattering off small aerogel mesopores (2-50 nm) and macropores ( $d \approx 80 \pm 10 \text{ nm}$ ) the thin sample scattering intensity  $I$  at distance  $R$  and angle  $\theta$  can be described by the well known formula [13]:

$$I = I_0 \left( \frac{1 + \cos^2(\theta)}{2R^2} \right) \left( \frac{2\pi}{\lambda} \right)^4 \left( \frac{n^2 - 1}{n^2 + 2} \right)^2 \left( \frac{d}{2} \right)^6 , \quad (3)$$

TABLE III

TABLE III: TRANSMISSION FITS TO EQUATION 4 ( $\lambda(\text{nm})$ ).

Aerogel	$t(\text{cm})$	$T_0 \%$	$C(10^{10})$	$X_0(500 \text{ nm})$	$\chi^2$
$n=1.03$ (350-700 nm)	1.05	97.56	0.36	17.4 cm	1.5
$n=1.07$ (350-700 nm)	1.15	98.05	2.47	2.5 cm	2.7
$n=1.12$ (500-700 nm)	1.15	96.98	6.16	1.0 cm	0.7

displaying the angular, wavelength, and refractive index dependence. Following Eq. 3, the compounded forward transmission  $T$  through an aerogel of thickness  $t$  can be parameterized by [13]:

$$T = T_0 e^{-C t/\lambda^4} . \quad (4)$$

where  $T_0$  is the wavelength independent transmittance, and  $C$  is the Rayleigh scattering coefficient. We fit each transmission curves to Eq. 4. Fits to the  $n=1.12$  aerogel are reported for  $\lambda \geq 500 \text{ nm}$  due to poor fit  $\chi^2$ 's below this value. The results are given in Table III. We also calculate the wavelength dependent Rayleigh transmission length  $X_0 = \lambda^4/C$  at 500 nm in Table III for comparison.

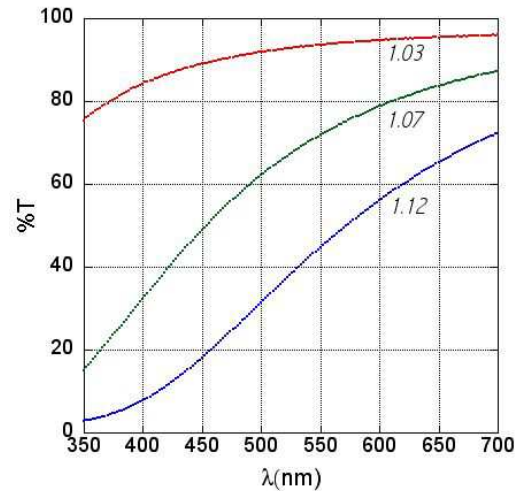

Fig. 3. Measurement of aerogel percent transmissions versus wavelength for the three aerogel tiles.

### V. SCATTERING LENGTH

Although Eq.(4) is a good parameterization of the data for the different aerogel samples, we take a second and more direct approach and define a scattering length  $X_0 (= \lambda^4/C)$  by  $T = T_0 e^{-t/X_0}$ . To extract  $X_0$  we take the ratio of the transmission spectrum of a single tile  $T_1$  to the transmission spectrum of two tiles  $T_2$ . The ratio  $T_2/T_1$  yields the aerogel scattering length  $X_0 = -t/\ln(T_2/T_1)$  as a function of wavelength. The results are plotted in Fig. 4. The fit and ratio method of section IV. are in reasonable agreement.

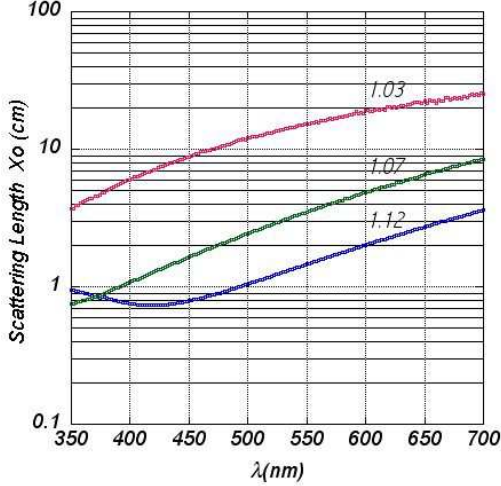

Fig. 4. Measurement of the scattering length  $X_0$  versus wavelength for the three aerogel samples.

## VI. INTENSITY VERSUS SCATTERING ANGLE

To investigate the angular scattering pattern of the aerogel, green light (532 nm) from a laser diode was directed with incidence normal to the face of an aerogel  $n=1.12$  tile (11.5 mm thick), as depicted in Fig. 5. The light intensity versus scattering angle  $\theta$  was measured by a photodiode (PD) located at a distance of 10cm from the sample in the plane. The results are shown in Fig. 6 for the in-plane measurements. The photo detector subtended a solid angle of  $\Delta\Omega=0.08\pi$  capturing about 2% of the scattered light. The forward laser transmission was measured to be  $I/I_0 = 32\%$ , indicating a scattering length of  $X_0 \approx 1.3\text{cm}$ , consistent with previous measurements at 532 nm (see Fig. 4).

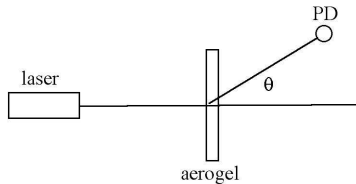

Fig. 5. Apparatus sketch for measuring the in-plane light intensity vs. angle.

Although the measurement errors are large, one can see the light intensity is strongly peaked in the forward direction  $\theta = 0^\circ$ , within a few degrees of the beam, as expected. The light scatter versus angle shows a strong forward-backward scatter as predicted by the Rayleigh law, suggesting that back-scattered Cherenkov light can be collected by a properly designed reflector. A small measurement asymmetry about  $\theta=90^\circ$  was noticed suggesting misalignment or some other systematic in the measurement. The data was not corrected for optical path length difference versus angle.

## VII. BEAM TEST

A small prototype Cherenkov detector was used to measure photoelectron response of the aerogel samples in cosmic rays

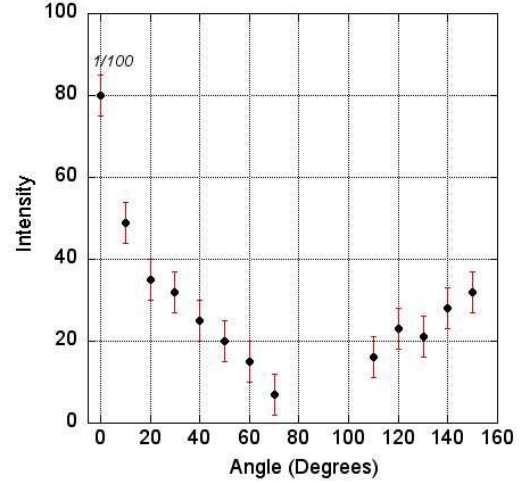

Fig. 6. Intensity(unscaled) versus angle in the light plane for the  $n=1.12$  aerogel tile. The measurement at  $\theta=0$  is scaled by  $1/100$ .

(the results not given here) and a 120 GeV/c proton beam ( $\beta = 1$ ) at Fermilab. The apparatus, depicted in Fig. 7, consisted of two chambers. In chamber *A* an 8 inch PMT [19] was placed with dome extending in to the second aerogel sample chamber *B*. In the sample chamber *B* two aerogel tiles were mounted to the top face at the center of the compartment. A 1/2 mil PVC window covered the aerogel, held it in place and protected it from contaminants. The compartment *B* was lined with a Tyvek [20] diffuse reflector. It was found that a simple angled Tyvek baffle increased the light collection by 10% and was inserted. A 2-fold trigger was set up between two scintillator paddles SCI-1 and SCI-2 which matched the aerogel's 11.5 x 11.5  $\text{cm}^2$  dimension. The data were collected with a LRS 2249 charge integrating ADC with a 60 ns gate (1/4 pC/channel). The PMT was run at a moderate gain of +1600V. The ADC was gated on the beam coincidence in the trigger counters.

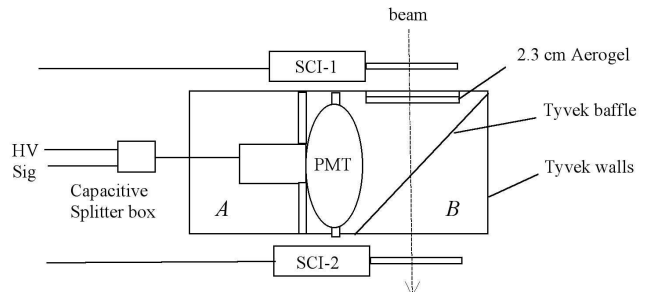

Fig. 7. Apparatus for cosmic ray and beam test of aerogel panel.

Based on a predicted photo-electron (pe) yield of  $N_{pe} \approx 90(1 - \frac{1}{n^2})L \cdot \epsilon$  for vertical  $\beta = 1$  protons with 100% collection efficiency  $\epsilon=1$ , a proton beam would generate 26, 39 photoelectrons in the aerogel  $n=1.07$  and  $n=1.12$  samples, respectively (see Table IV). We measured  $22 \pm 2$  and  $27 \pm 2$ , with a  $\pm 2$  uncertainty from our gain calibration (see Fig. 8).

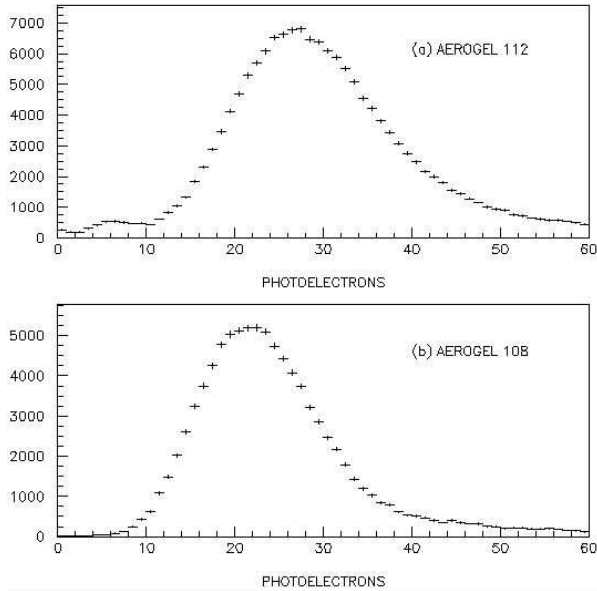

Fig. 8. 120 GeV/c proton beam exposure.  $\beta = 1$  photo-electron peaks correspond to  $27 \pm 2$  and  $22 \pm 2$  photoelectrons respectively for the 2.3cm thick aerogel (a)  $n=1.12$  and (b)  $n=1.07$  samples, respectively.

TABLE IV  
TABLE IV: BEAM TEST RESULT

Aerogel	$L(\text{cm})$	$N_{pe}^{pred}$	$N_{pe}^{meas} \cdot \epsilon$	$\epsilon$
		$(\epsilon = 1)$		
$n=1.07$	2.3	26.2	$22 \pm 2$	$0.84 \pm 0.08$
$n=1.12$	2.3	39.0	$27 \pm 2$	$0.69 \pm 0.05$

The measurement results and estimated light collection efficiencies  $\epsilon$  are listed in Table IV. In this configuration the efficiencies are about  $70 \pm 10\%$ , typical for a diffusely reflecting collection box. This gives good evidence that the light absorption in the aerogel 1.12 and 1.07 panels is small.

### VIII. SUMMARY

We have made some of the the first measurements on high density aerogel  $n=1.07$  and  $n=1.12$  samples, from Matsushita, to be used in a beamline Cherenkov application. The transmission and scattering properties were investigated and compared to standard  $n=1.03$  aerogel. Little evidence for strong light absorption in the high density aerogels was found in our test beam exposure, indicating the possibility of further uses of the high density aerogels in particle detector and beamline applications.

We want to thank Mac Yamauchi and Hiroshi Yokogawa at Matsushita Electric Works and the Panasonic Corporation for their help in preparation of the aerogel samples. We also thank Koji Yoshimura at KEK-Tsukuba for his help in obtaining the samples.

### REFERENCES

- [1] D. Ayres *et al.*, "Expression of interest for R & D towards a Neutrino Factory based on a storage ring and a muon collider," physics/9911009, Nov 1999.
- [2] C. H. Albright *et al.*, "The Neutrino Factory and Beta Beam experiments and development," physics/0411123, Nov. 2004.
- [3] J. S. Berg *et al.*, "A cost-effective design for a Neutrino Factory," *Phys. Rev. ST Accel. Beams*, vol. 9, art. 011001, 2006.
- [4] D. V. Neuffer and R. B. Palmer, "A high-energy high-luminosity  $\mu^+\mu^-$  collider," EPAC04-London, pp. 52-54, Jun. 1994.
- [5] C. M. Ankenbrandt *et al.*, "Status of muon collider research and development and future plans," *Phys. Rev. ST Accel. Beams*, vol. 2, art. 081001, 1999.
- [6] D. J. Summers *et al.*, "6D muon ionization cooling with an inverse cyclotron," Cool05-Galena, *AIP Conf. Proc.*, vol. 821, pp. 432-436, 2006.
- [7] R. B. Palmer *et al.*, "A complete scheme of ionization cooling for a muon collider," PAC07-Albuquerque, arXiv:0711.4275, Jun. 2007.
- [8] P. Drumm, "MICE: The International Muon Ionisation Cooling Experiment," PAC 05-Knoxville, hep-ex/0509021, May 2005.
- [9] M. Yoshida, "The International Muon Ionization Cooling Experiment (MICE)," NuFact04-Osaka, *Nucl. Phys. Proc. Suppl.* vol. 149, pp. 94-98, 2005.
- [10] M. Cantin *et al.*, "Silica aerogels used as Cherenkov radiators," *Nucl. Instrum. Methods*, vol. 118, pp. 177-182, 1974.
- [11] H. Burkhardt *et al.*, "The TASSO gas and aerogel Cherenkov counters," *Nucl. Instrum. Methods*, vol. 184, pp. 319-331, 1981.
- [12] T. Sumiyoshi *et al.*, "Silica aerogel Cherenkov counter for the KEK B-Factor Experiment," *Nucl. Instrum. Methods Phys. Res. A*, vol. 433, pp. 385-391, 1999.
- [13] <http://eetd.lbl.gov/ecs/aerogels/sa-optical.html> and references within.
- [14] A. Yu. Barnyakov *et al.*, "High density aerogel for ASHIPH SND: Test results," *Nucl. Instrum. Methods Phys. Res. A*, vol. 598, pp. 163-165, 2009.
- [15] David Bartlett *et al.*, "Performance of the Cherenkov counters in the Fermilab Tagged Photon Spectrometer Facility," *Nucl. Instrum. Methods Phys. Res. A*, vol. 260, pp. 55-75, 1987.
- [16] Samples donated by the Matsushita Electric Works Ltd., 1048 Kadoma, Osaka, 571-8686, Japan.
- [17] R.D. Leo, V. Capozzi, C. Casalino, E. Cisbani *et al.*, "Chromatic aberration and forward scattering of light in silica aerogel," *Nucl. Instrum. Methods Phys. Res. A*, vol. 447, pp. 52-56, 2001.
- [18] PERKIN ELMER UV-VIS Spectrophotometer, Model Lambda 18.
- [19] Electron Tubes Inc. 9356KB Photomultiplier Tube.
- [20] Tyvek, a trademark of the 3M Corporation, Minneapolis MN.