

Syntax for Split Preorders

KOSTA DOŠEN and ZORAN PETRIĆ

Mathematical Institute, SANU
Knez Mihailova 36, p.f. 367, 11001 Belgrade, Serbia
email: {kosta, zpetric}@mi.sanu.ac.yu

Abstract

A split preorder is a preordering relation on the disjoint union of two sets, which function as source and target when one composes split preorders. The paper presents by generators and equations the category $SplPre$, whose arrows are the split preorders on the disjoint union of two finite ordinals. The same is done for the subcategory Gen of $SplPre$, whose arrows are equivalence relations, and for the category Rel , whose arrows are the binary relations between finite ordinals, and which has an isomorphic image within $SplPre$ by a map that preserves composition, but not identity arrows. It was shown previously that $SplPre$ and Gen have an isomorphic representation in Rel in the style of Brauer.

The syntactical presentation of Gen and Rel in this paper exhibits the particular Frobenius algebra structure of Gen and the particular bialgebraic structure of Rel , the latter structure being built upon the former structure in $SplPre$. This points towards algebraic modelling of various categories motivated by logic, and related categories, for which one can establish coherence with respect Rel and Gen . It also sheds light on the relationship between the notions of Frobenius algebra and bialgebra. The completeness of the syntactical presentations is proved via normal forms, with the normal form for $SplPre$ and Gen being in some sense orthogonal to the composition-free, i.e. cut-free, normal form for Rel . The paper ends by showing that the assumptions for the algebraic structures of $SplPre$, Gen and Rel cannot be extended with new equations without falling into triviality.

Mathematics Subject Classification (2000): 18B10, 18C15, 16W30, 03F05

Keywords: split preorder, normal form, monad, comonad, Frobenius algebra, bialgebra

1 Introduction

A *split preorder* is a preorder, i.e. a reflexive and transitive binary relation, on the disjoint union of two sets. The two disjoint subsets into which the domain

of such a relation is split are conceived as *source* and *target* for the purpose of composing such relations. Here is an example of a split preorder:

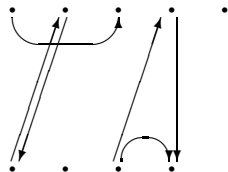

Our convention in such pictures is to conceive the source as being in the top and the target in the bottom line. Another convention is not to draw loops that correspond to the pairs (x, x) . Composition of split preorders will be considered (and illustrated) in the next section.

The category *SplPre*, whose objects are the finite ordinals, and whose arrows are the split preorders on the disjoint union of two finite ordinals, has as a subcategory the category *Gen*, whose arrows are the *split equivalences* of *SplPre*, i.e. the arrows of *SplPre* that are equivalence relations. Another category included in *SplPre* is a category isomorphic to the category *Rel*, whose arrows are the relations between the finite ordinals, composed in the usual way. “Relation” in this paper means *binary* relation (but we will sometimes emphasize that we are dealing with binary relations). This isomorphic image of *Rel* is not a subcategory of *SplPre* because, though its composition is the composition of *SplPre*, it does not have the same identity arrows as *SplPre*. Let us explain why this is the case. In this explanation one can see how split preorders arise naturally when we draw binary relations.

In the isomorphic image of *Rel* in *SplPre* we replace an ordered pair (x, y) by the ordered pair $((x, 1), (y, 2))$, which for short we write (x_1, y_2) . This way we insure that the source and target sets are disjoint. This is what we do quite naturally when we represent binary relations by bipartite graphs. For example, the binary relation $R \subseteq \{0, 1, 2\} \times \{0, 1, 2\}$ given by the set of ordered pairs $\{(0, 0), (0, 1), (1, 1), (1, 2)\}$ would often be represented as follows:

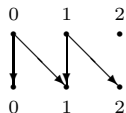

This picture induces a split preorder on the union of the source set $\{0_1, 1_1, 2_1\}$ and the target set $\{0_2, 1_2, 2_2\}$, which may be conceived as the disjoint union of $\{0, 1, 2\}$ with itself.

To get the split preorder induced by R , we just have to add the pairs (x, x) for every x in the source and target sets. These (x, x) loops are not usually drawn, and we do not put them in our pictures. We may either take them for granted, or we may take that we are dealing with irreflexive relations corresponding bijectively to preorders—their *strict* variants with respect to reflexivity.

A strict preorder in this sense is an irreflexive relation S that satisfies *strict transitivity*:

$$\forall x, y, z((xSy \ \& \ ySz \ \& \ x \neq z) \Rightarrow xSz).$$

A strict equivalence relation is a strict preorder that is moreover symmetric. (An irreflexive and transitive relation—transitive in the ordinary sense—is a strict *partial* order; for preorders we do not assume antisymmetry.)

A preorder determines uniquely a strict preorder on the same domain: we just eliminate the pairs (x, x) . Conversely, a strict preorder determines uniquely a preorder, provided the domain is specified: we just add the pairs (x, x) for every element x of the domain. The same holds when “preorder” is replaced by “equivalence relation”.

Note that $(0, 1)$ and $(1, 2)$ belong to R in the example above, without $(0, 2)$ belonging to R . So transitivity does not hold for R , but it will hold for the corresponding split preorder, where instead of the two pairs $(0, 1)$ and $(1, 2)$ we find the two pairs $(0_1, 1_2)$ and $(1_1, 2_2)$.

It will be shown in the next section that split preorders are composed so that when we restrict ourselves to those that correspond to binary relations between the source and target, their composition amounts to the ordinary composition of relations. However, the identity relation on the ordinal n , which is an identity arrow of Rel , is represented in $SplPre$ by the split preorder corresponding to

$$\begin{array}{ccc} 0 & 1 & n-1 \\ \downarrow & \downarrow & \downarrow \\ 0 & 1 & n-1 \end{array} \quad \dots$$

which is not an identity arrow of $SplPre$. The identity split preorder on n is the split equivalence corresponding to

$$\begin{array}{ccc} 0 & 1 & n-1 \\ \updownarrow & \updownarrow & \updownarrow \\ 0 & 1 & n-1 \end{array} \quad \dots$$

We will consider this matter in more detail in the next section and in Section 15.

Functions conceived as a special kind of binary relation between the domain and the codomain are represented isomorphically by split preorders, as all binary relations are. We have however for functions the possibility to represent them isomorphically also in another manner by split equivalences, so that we have in the same equivalence class a copy of the value of the function together with copies of all the arguments with that value. In this manner we obtain for the subcategory of Rel whose arrows are functions an isomorphic image in Gen (see the end of the next section).

We have relied on the categories Rel and Gen in our work on categorial coherence for various fragments of logic, and related structures (see [6], [7], [8],

[9], [10], and references therein). The interest of the category $SplPre$ in this perspective is that it is a common, natural, extension of both Rel and Gen . Moreover, for this category, as well as for Gen , one can give an isomorphic representation in Rel in the style of Brauer (see [3] and [4]). We believe this representation is important, because it is tied to algebraic models for deductions in logic, and for related structures. Among these related structures, we find in particular monads and comonads combined so as to yield Frobenius algebras or bialgebras.

In this paper we present $SplPre$, Gen and Rel by generators and equations. In other words, we provide a syntax for the arrows of these categories, and axiomatize the equations between these arrows. Our syntactical presentations make manifest the particular Frobenius algebra structure of Gen and the particular bialgebraic structure of Rel . These structures are very regular, rather simple, and belong to a field much investigated in contemporary algebra.

The category Gen is characterized by reference to Frobenius algebras. It is isomorphic to the category of the commutative separable Frobenius monad, with the additional bialgebraic unit-counit homomorphism condition, freely generated by a single object (see Sections 3 and 9). The category Rel is characterized by reference to bialgebras. It is isomorphic to the category of the commutative bialgebraic monad, which satisfies an additional condition analogous to separability in Frobenius monads, freely generated by a single object (see Sections 4 and 14). The bialgebraic structure of Rel in $SplPre$ is built upon the Frobenius structure of Gen . This bialgebraic structure has a Frobenius foundation.

This points towards algebraic models for categories motivated by logic, and related categories, that were proved coherent with respect to Rel and Gen . It also sheds light on the coherence results obtained for commutative Frobenius monads with respect to 2-cobordisms (see [13], [10], and references therein). We believe it also sheds light on the relationship between the notions of Frobenius algebra and bialgebra. Finally, it gives for split preorders a result akin to Reidemeister's characterization of equivalence between knots (see [1], Chapter 1, or another textbook in knot theory). Our axioms are, like Reidemeister moves, the building blocks of equality between split preorders. Derivations of equations between arrows in this paper will often be illustrated by pictures, and passing from one picture to another by applying an equation corresponds to making a move like a Reidemeister move (see in particular Sections 6 and 12). These pictures are easy to understand (and draw by hand—but not in Latex).

In the present context, these pictures are more useful than the usual categorial diagrams, which besides the names of the arrows specify just their sources and targets. If the sources and targets are specified in the names of the arrows, then ordinary categorial diagrams carry no more information than equations between arrows. The sources and targets in this paper amount just to natural numbers, with no more structure than given by addition.

The structure of the axiomatization results of this paper is the following. On the one hand, we have a syntactically defined, freely generated category. In the

main result, we consider commutative separable Frobenius monads over which is built the structure of a separable bialgebraic monad, and we take the category of a monad of this kind freely generated by a single object. (As a matter of fact, we provide two syntaxes—the usual one, and another one, presented in more detail, in which normal form for arrow terms is easily reached; the two syntaxes are proved equivalent.) On the other hand, we have the model category $SplPre$. We prove with a technique based on normal form in the syntactical category that this category is isomorphic to $SplPre$. From a logical point of view, this is a completeness result. From a categorial point of view, this is a perfect coherence result—perfect, because we do not have only a faithful functor from the syntactical category to the model category, but an isomorphism (see [6]). The structure of the results for Gen and Rel is the same.

The technique by which we prove the completeness of our syntactical presentations of $SplPre$, Gen and Rel is based on two kinds of normal form, which may both be taken as inspired by linear algebra. Both are a kind of sum of basic components. In the *eta normal form* for $SplPre$ and Gen (see Section 7), the role of the sum is played by composition of arrows, while in the *iota normal form* for Rel (see Section 13), this role is played by an operation on arrows, which, for good reasons, we call union. Both kinds of sum happen to have properties of a semilattice operation with unit. The two normal forms are analogous, but in a certain sense orthogonal, to each other. In the pictures of the eta normal form, the horizontal basic components are arranged vertically one above the other, while, in the pictures of the iota normal form, the vertical basic components are arranged horizontally next to each other. The former arrangement suits $SplPre$ and Gen very well, and is not suitable for Rel , while the later arrangement suits Rel very well, and is not suitable for $SplPre$ and Gen . The iota normal form is composition-free, and is akin to Gentzen’s cut-free normal forms.

At the end of the paper, we show that the algebraic structures of $SplPre$, Gen and Rel are complete in a syntactical sense. We cannot assume further equations for these structures without falling into triviality with respect to equality of arrows.

In the next section we define precisely split preorders and prove that their composition is associative, so that they make the arrows of a category. That section is about elementary foundational matters, and it is in the realm of logic. A reader who trusts that $SplPre$ is a category may however go quickly through the section, and skip the details, the lemmata and the proofs, on which the understanding of the rest of the paper does not depend.

Otherwise, the style of our exposition, especially in the completeness proofs, is not a rigorously formal style, by which logic used to be recognized in the preceding century. In general we favour this style, but our subject matter is not only logical—it belongs more to the categorial foundations of algebra—and we do not want to discomfort by our style readers of an already pretty long paper who are perhaps not logicians. So we rely to a great extent on pictures, and pursue precision only up to a point where no doubt should be left that

formalization can be achieved, without going into all its details.

We presuppose the reader is acquainted with the basics of category theory. They may be found in [16] (whose terminology we shall try to follow), but in other textbooks as well. An acquaintance with the notions of Frobenius algebra and bialgebra, and with the categorial notions abstracted for them, is desirable only for the sake of motivation. Our references point to areas where further motivation may be found. The exposition of the results of the paper is however self-contained.

2 The categories *SplPre*, *Gen* and *Rel*

It is easy to define precisely the category *Rel*, and we will do that first. Its objects are the finite ordinals, its arrows are the binary relations between finite ordinals, and composition of these arrows is the usual composition of relations:

$$R_2 \circ R_1 = \{(x, y) \mid \exists z((x, z) \in R_1 \ \& \ (z, y) \in R_2)\}.$$

It is very well known that this composition is associative, and that, with identity arrows being identity relations, *Rel* is a category.

The precise definition of the categories *SplPre* and *Gen* is a more involved matter, though their arrows are not that unusual, and the natural composition of these arrows is intuitively easy to understand. Here is an illustrated example of composition of split preorders:

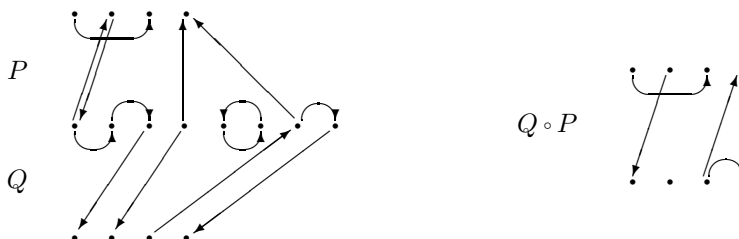

It is rather clear intuitively that this composition is associative, but to define it precisely, and prove that it is associative, as we do below, requires some preparation and some effort. An indirect proof of the associativity of composition in *SplPre* and *Gen*, alternative to the direct proof given below, may be found in [4]. This alternative proof is based on the Brauerian representation of *SplPre* in *Rel*.

For R a set of ordered pairs, let the *domain* DR of R be the set

$$\{x \mid \exists y((x, y) \in R \ \text{or} \ (y, x) \in R)\}.$$

It is clear that $D(X^2) = X$ (where, as usual, X^2 is $X \times X$), and that $D(R_1 \cup R_2) = DR_1 \cup DR_2$.

A set R of ordered pairs is a *preorder* when it is reflexive (which means of course that for every x in DR we have $(x, x) \in R$), and transitive (which means as usual that, for every x, y and z , if $(x, y) \in R$ and $(y, z) \in R$, then $(x, z) \in R$). We will use P, Q, S, \dots for reflexive sets of ordered pairs.

For A, B, \dots arbitrary sets and i, j, \dots natural numbers, let A_i, B_j, \dots stand for the sets $A \times \{i\}, B \times \{j\}, \dots$. For $i \neq j$, a *preorder oriented from A_i to B_j* is a preorder P such that $DP = A_i \cup B_j$, together with the ordered pair (i, j) . We call P here the *basic preorder* of the oriented preorder, and (i, j) is its *orientation*. Since A_i and B_j are disjoint, $A_i \cup B_j$ may be conceived as the disjoint union of A and B .

For the basic preorders of preorders oriented from A_i to B_j we write $P_{A_i, B_j}, Q_{A_i, B_j}, \dots$. With this notation it is redundant to mention the orientation of the oriented preorder *based* on the basic preorder. Note that different oriented preorders, different in their orientation, may be based on the same basic preorder designated by P_{A_i, B_j} or P_{B_j, A_i} .

The sets A and B in P_{A_i, B_j} may be the same, but A_i will always be disjoint from B_j . Hence A_i and B_j always differ, except when $A = B = \emptyset$, since then $A_i = B_j = \emptyset$, and $P_{A_i, B_j} = \emptyset$ too.

The oriented preorders based on P_{A_i, B_j} and Q_{A_k, B_l} are *equivalent* when for the bijection $\beta: A_i \cup B_j \rightarrow A_k \cup B_l$ given by $\beta(a, i) = (a, k)$ and $\beta(b, j) = (b, l)$ we have that $(x, y) \in P_{A_i, B_j}$ iff $(\beta(x), \beta(y)) \in Q_{A_k, B_l}$. We write $P_{A_i, B_j}, P_{A_k, B_l}, \dots$ for the basic preorders of equivalent oriented preorders.

A *split preorder from A to B* is a preorder oriented from A_1 to B_2 . This preorder oriented from A_1 to B_2 is the canonical representative of the class of equivalent oriented preorders whose members are oriented from A_i to B_j , with $i \neq j$.

A notion more general than split preorder is the notion of split relation. A *split relation from A to B* is any set of ordered pairs included in $(A_1 \cup B_2)^2$, together with the orientation $(1, 2)$.

The split preorder from A to A which is the *identity split preorder on A* is the preorder oriented from A_1 to A_2 based on

$$I_{A_1, A_2} =_{df} \{((a, i), (a, j)) \mid a \in A \ \& \ i, j \in \{1, 2\}\}.$$

Note that this set of ordered pairs, besides being a preorder, is also symmetric in the usual sense (see the end of the section).

Let *SplPre* be the category whose objects are the finite ordinals, and whose arrows from n to m are the split preorders from n to m . The identity arrow $\mathbf{1}_n: n \rightarrow n$ of *SplPre* is the identity split preorder on n .

Our next task is to define composition in *SplPre*, and for that we need to introduce some auxiliary notions. This notion of composition corresponds exactly in special cases to the usual notion of composition of binary relations and of functions.

For a reflexive set of ordered pairs P , the *transitive closure* $\text{Tr}P$ is the intersection of the family of all preorders S such that $DS = DP$ and $P \subseteq S$; i.e., we have

$$\text{Tr}P =_{df} \{(x, y) \mid \forall S((S \text{ preorder} \ \& \ DS = DP \ \& \ P \subseteq S) \Rightarrow (x, y) \in S)\}.$$

It is easy to see that the intersection of any family of preorders is a preorder, and so $\text{Tr}P$ is a preorder, with the same domain as P ; i.e. we have $D\text{Tr}P = DP$. We also have that

$$\begin{aligned} (\text{Tr } 1) \quad & P \subseteq \text{Tr}P, \\ (\text{Tr } 2) \quad & \text{Tr}\text{Tr}P \subseteq \text{Tr}P, \\ (\text{Tr } 3) \quad & P \subseteq Q \Rightarrow \text{Tr}P \subseteq \text{Tr}Q. \end{aligned}$$

For $n \geq 2$, a *chain in P from x_1 to x_n* is a sequence x_1, x_2, \dots, x_n of (not necessarily distinct) elements of DP such that for every $i \in \{1, \dots, n-1\}$ we have $(x_i, x_{i+1}) \in P$. An alternative, constructive, characterization of $\text{Tr}P$ is given by

$$\text{Tr}P = \{(x, y) \mid \text{there is a chain in } P \text{ from } x \text{ to } y\}.$$

Let $P \bar{\cup} Q$ be $\text{Tr}(P \cup Q)$ (for P and Q reflexive, $P \cup Q$ is of course reflexive too). We need this operation and the operation $^{-X}$ below to define composition of split preorders, and we need the lemmata concerning these operations to prove that this composition is associative. We have first the following.

LEMMA 1. $\text{Tr}(P \cup \text{Tr}Q) = \text{Tr}(P \cup Q)$.

PROOF. We have $P \cup \text{Tr}Q \subseteq \text{Tr}(P \cup Q)$, by using (Tr 1) and (Tr 3), from which, by using (Tr 3) and (Tr 2), we obtain

$$\text{Tr}(P \cup \text{Tr}Q) \subseteq \text{Tr}(P \cup Q).$$

For the converse inclusion we use (Tr 1) and (Tr 3). -1

As an immediate consequence of this lemma we have the following.

LEMMA 2. $P \bar{\cup} (Q \bar{\cup} S) = (P \bar{\cup} Q) \bar{\cup} S$.

For R an arbitrary set of ordered pairs and X an arbitrary set, let

$$R^{-X} =_{df} \{(x, y) \in R \mid x \notin X \ \& \ y \notin X\}.$$

The following holds.

LEMMA 3. If $P = \text{Tr}P$ and $Q = Q^{-X}$, then

$$(\text{Tr}(P \cup Q))^{-X} = \text{Tr}((P \cup Q)^{-X}).$$

PROOF. For the inclusion from left to right, suppose that (x, y) belongs to the left-hand side. So there is a chain x_1, x_2, \dots, x_n in $P \cup Q$ from x to y , with $x_1 = x$ and $x_n = y$. We may assume that for this chain we never have $(x_i, x_{i+1}) \in P$ and $(x_{i+1}, x_{i+2}) \in P$ for $x_{i+1} \in X$. If we have that, then we replace our chain by a shorter chain where x_{i+1} is omitted; we have $(x_i, x_{i+2}) \in P$. Since x and y do not belong to X , no member of our chain x_1, x_2, \dots, x_n belongs to X . So our chain is in $(P \cup Q)^{-X}$, from which we conclude that (x, y) belongs to the right-hand side.

For the converse inclusion we use essentially (Tr 3) and $(\text{Tr}(S^{-X}))^{-X} = \text{Tr}(S^{-X})$. -1

We prove easily the following.

LEMMA 4. *If $R_2 = R_2^{-X}$, then $R_1^{-X} \cup R_2 = (R_1 \cup R_2)^{-X}$.*

LEMMA 5. $(R^{-X})^{-Y} = R^{-(X \cup Y)} = (R^{-Y})^{-X}$.

It is also easy to see that if P is a preorder, then P^{-X} is a preorder too, since $P^{-X} = P \cap (DP - X)^2$, and $(DP - X)^2$ is a preorder.

The split preorder from A to C which is the *composition* of the split preorder from A to B based on P_{A_1, B_2} and of the split preorder from B to C based on Q_{B_1, C_2} is the preorder oriented from A_1 to C_2 based on

$$Q_{B_1, C_2} \circ P_{A_1, B_2} =_{df} (P_{A_1, B_i} \bar{\cup} Q_{B_i, C_2})^{-B_i}, \text{ for } i \neq 1 \text{ and } i \neq 2.$$

It is clear that this definition does not depend on the choice of the index i on the right-hand side, provided that $i \neq 1$ and $i \neq 2$. According to our convention, for every $i \neq 1$, the oriented preorder based on P_{A_1, B_i} is equivalent to the oriented preorder based on P_{A_1, B_2} , and, for every $i \neq 2$, the oriented preorder based on Q_{B_i, C_2} is equivalent to the oriented preorder based on Q_{B_1, C_2} . By the definition of $\bar{\cup}$ and by what we have said in the preceding paragraph, we can ascertain that we have defined indeed a split preorder. Note that composition of split preorders based on discrete preorders (i.e., we have only the pairs (x, x) in them) amounts to symmetric difference of sets.

In the example of composition of split preorders given in the picture at the beginning of the section, we may take that in the top part on the left we have the oriented preorder based on $P_{4_1, 8_3}$, while in the bottom part we have the oriented preorder based on $Q_{8_3, 4_2}$. The points at the top stand for the elements of $\{(0, 1), \dots, (3, 1)\}$, those in the middle for the elements of $\{(0, 3), \dots, (7, 3)\}$, and those at the bottom for the elements of $\{(0, 2), \dots, (3, 2)\}$. On the right, we have the oriented preorder, i.e. split preorder, based on $Q_{8_1, 4_2} \circ P_{4_1, 8_2}$, with the elements of $\{(0, 1), \dots, (3, 1)\}$ represented by points at the top, and the elements of $\{(0, 2), \dots, (3, 2)\}$ by points at the bottom.

We take composition so defined to be composition of arrows in the category $SplPre$. Let us now verify that we may do that.

For the identity split preorders on A and B it is easy to verify that

$$P_{A_1, B_2} \circ I_{A_1, A_2} = P_{A_1, B_2} = I_{B_1, B_2} \circ P_{A_1, B_2}.$$

We also have the following.

PROPOSITION. *Composition of split preorders is associative.*

PROOF. We have

$$\begin{aligned} S_{C_1, D_2} \circ (Q_{B_1, C_2} \circ P_{A_1, B_2}) &= (\text{Tr}((\text{Tr}(P_{A_1, B_3} \cup Q_{B_3, C_4}))^{-B_3} \cup S_{C_4, D_2}))^{-C_4}, \\ &\quad \text{by definitions,} \\ &= ((P_{A_1, B_3} \sqcup Q_{B_3, C_4}) \sqcup S_{C_4, D_2})^{-B_3 \cup C_4}, \\ &\quad \text{by Lemmata 4, 3 and 5.} \end{aligned}$$

We obtain analogously

$$(S_{C_1, D_2} \circ Q_{B_1, C_2}) \circ P_{A_1, B_2} = (P_{A_1, B_3} \sqcup (Q_{B_3, C_4} \sqcup S_{C_4, D_2}))^{-B_3 \cup C_4},$$

and then we apply Lemma 2. \dashv

So *SplPre* is indeed a category.

There is an injection from binary relations to split preorders, which maps a binary relation $R \subseteq A \times B$ to the split preorder from A to B based on

$$\begin{aligned} R_{A_1, B_2} =_{df} \{ &((a, 1), (b, 2)) \mid (a, b) \in R\} \cup \{((a, 1), (a, 1)) \mid a \in A\} \\ &\cup \{((b, 2), (b, 2)) \mid b \in B\} \end{aligned}$$

(see the example in Section 1). This gives an injection from the arrows of *Rel* to those of *SplPre*.

For the binary relations $R \subseteq A \times B$ and $S \subseteq B \times C$ we have that

$$(S \circ R)_{A_1, C_2} = S_{B_1, C_2} \circ R_{A_1, B_2},$$

where \circ on the left-hand side is the usual composition of relations, and on the right-hand side it comes from composition of split preorders, as defined above. So composition of relations amounts to composition of split preorders. In particular, if R and S are functions (which means as usual that they are totally defined and single-valued), then composition of functions amounts to composition of split preorders.

Note however that for E being the identity relation on A , which is defined as usual by $E = \{(a, a) \mid a \in A\}$, the basic preorder of the split preorder from A to A delivered by our injection:

$$\begin{aligned} E_{A_1, A_2} = \{ &((a, 1), (a, 2)) \mid a \in A\} \cup \{((a, 1), (a, 1)) \mid a \in A\} \\ &\cup \{((a, 2), (a, 2)) \mid a \in A\} \end{aligned}$$

is not the basic preorder I_{A_1, A_2} of the identity split preorder on A . The set of pairs $\{((a, 2), (a, 1)) \mid a \in A\}$ is missing. We have considered this matter already in Section 1, and we will return to it in Section 15, where the exact relationship between Rel and $SplPre$ induced by the injection above will be spelled out.

A split preorder from A to B may alternatively be defined as a specific cospan from A to B , for A and B conceived as discrete preorders, in the base category of preorders and order-preserving maps of their domains (see [16], Section XII.7). The specificity of such a cospan

$$A \xrightarrow{f} DP \xleftarrow{g} B$$

is that f and g induce a bijection between $A+B$ and DP . Composition of split preorders so defined will not reduce to a pushout only (which corresponds to transitive closure), but to a pushout followed by the deletion of the part over which the preorders were glued in the pushout (this deletion corresponds to our operation $^{-B_i}$). The cospans over the base category of graphs, which one finds in [17], are more general than our specific cospans, and they do not involve the deletion just mentioned.

A *split equivalence* from A to B is a split preorder from A to B based on a symmetric set of ordered pairs; i.e., this set is an equivalence relation. (As usual, a set of ordered pairs R is *symmetric* when, for every x and y , if $(x, y) \in R$, then $(y, x) \in R$.) Identity split preorders are split equivalences, and it is easy to see that composition of split equivalences yields a split equivalence.

We call Gen the subcategory of $SplPre$ whose objects are the objects of $SplPre$ and whose arrows are split equivalences. (This category was investigated in [3], where it was named Gen because of its connection with *generality* of proofs.)

Let Fun be the subcategory of Rel whose arrows are functions. The injection given above restricted to Fun gives an injection from the arrows of Fun to the arrows of $SplPre$. Besides this injection, there is another injection from the arrows of Fun to the arrows of Gen , which is given by the injection that assigns to a function $f: A \rightarrow B$ the split equivalence from A to B based on

$$\begin{aligned} f_{A_1, B_2} =_{df} & \{((a, 1), (b, 2)) \mid f(a) = b\} \cup \{((b, 2), (a, 1)) \mid f(a) = b\} \\ & \cup \{((a, 1), (a', 1)) \mid f(a) = f(a')\} \cup \{((b, 2), (b, 2)) \mid b \in B\}. \end{aligned}$$

In the partition induced by f_{A_1, B_2} we find in the same equivalence class a value of f , indexed by 2, together with all the arguments having that value, all of them indexed by 1.

For the functions $f: A \rightarrow B$ and $g: B \rightarrow C$ we have

$$(g \circ f)_{A_1, C_2} = g_{B_1, C_2} \circ f_{A_1, B_2},$$

where \circ on the left-hand side is the usual composition of functions, and on the right-hand side it comes from composition of split equivalences. So composition

of functions amounts here to composition of split equivalences. By the new injection, the identity relation on A , which is also the identity function on A , is mapped to the identity split preorder on A , which happens to be a split equivalence. With the new injection, we obtain that Fun is isomorphic to a subcategory of Gen , which induces a faithful functor from the category of finite sets with functions into the category Gen .

3 The categories \mathcal{PF} and \mathcal{EF}

In this section we define the categories \mathcal{PF} and \mathcal{EF} , which are categorial abstractions of certain notions of Frobenius algebras. These are the categories for which we will prove that they are isomorphic with the categories $SplPre$ and Gen respectively. We start with the definition of \mathcal{EF} , which is simpler, and is incorporated into the definition of \mathcal{PF} .

A *Frobenius monad* is given by a category \mathcal{A} and an endofunctor M of \mathcal{A} such that $\langle \mathcal{A}, M, \nabla, ! \rangle$ is a monad, $\langle \mathcal{A}, M, \Delta, \mathfrak{i} \rangle$ is a comonad, and moreover the *Frobenius equations*, connecting the monad and comonad structures, are satisfied:

$$M\nabla \circ \Delta_M = \Delta \circ \nabla = \nabla_M \circ M\Delta.$$

(Our notation here for $\nabla, \Delta, !$ and \mathfrak{i} follows [17]; in [10] we used respectively the symbols $\delta^\diamond, \delta^\square, \varepsilon^\diamond$ and ε^\square .)

To understand equations like the Frobenius equations it helps to have in mind their interpretation in $SplPre$. We will represent the corresponding split preorders by pictures where

$$\begin{array}{c} \downarrow \end{array} \text{ stands for } \begin{array}{c} \Downarrow \end{array}$$

and where we do not draw the loops that correspond to the pairs (x, x) (see Section 1). For $I_{\mathcal{A}}$ being the identity endofunctor of \mathcal{A} , we have the following pictures for the natural transformations of our monad and comonad:

$$\begin{array}{ccc} \nabla: MM \dot{\rightarrow} M & \begin{array}{c} \triangle \\ \circ \end{array} & \Delta: M \dot{\rightarrow} MM & \begin{array}{c} \triangle \\ \circ \end{array} \\ \mathfrak{i}: I_{\mathcal{A}} \dot{\rightarrow} M & \circ & \mathfrak{i}: M \dot{\rightarrow} I_{\mathcal{A}} & \circ \end{array}$$

For M^k being a sequence of $k \geq 0$ occurrences of M , and for θ being a natural transformation, we obtain the picture for $M^n\theta_{M^m}$ out of the picture for θ in the following manner:

$$\begin{array}{c} \overbrace{\downarrow \dots \downarrow}^n \quad \square \quad \overbrace{\downarrow \dots \downarrow}^m \\ \theta \end{array}$$

We then have the pictures below for the *monadic equations*:

$$\nabla \circ \nabla_M = \nabla \circ M\nabla$$

$$\nabla \circ !_M = \mathbf{1}_M = \nabla \circ M!$$

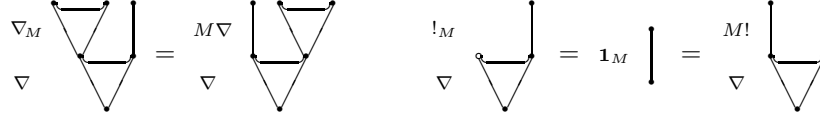

and the pictures for the dual *comonadic equations* are the same pictures upside down. The picture for an equation is made of pictures for its two sides.

For the Frobenius equations we have the following pictures:

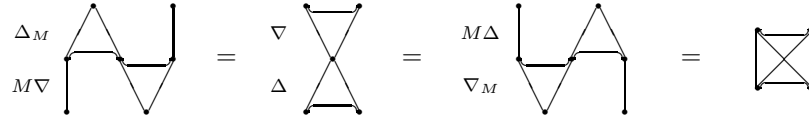

A *commutative* Frobenius monad has moreover a natural symmetry isomorphism

$$\tau: MM \xrightarrow{\cdot} MM,$$

inverse to itself, which satisfies besides the *Yang-Baxter equation*

$$M\tau \circ \tau_M \circ M\tau = \tau_M \circ M\tau \circ \tau_M,$$

the following *symmetrization equations*, connecting τ with the monad and comonad structures:

$$\nabla \circ \tau = \nabla,$$

$$\tau \circ \Delta = \Delta,$$

$$\tau \circ \nabla_M = M\nabla \circ \tau_M \circ M\tau,$$

$$\Delta_M \circ \tau = M\tau \circ \tau_M \circ M\Delta,$$

$$\tau \circ !_M = M!,$$

$$i_M \circ \tau = Mi.$$

The two symmetrization equations in the first line are the *commutativity equations*.

The picture corresponding to the interpretation of τ in *SplPre* is , and the pictures for the symmetrization equations involving ∇ and $!$ are:

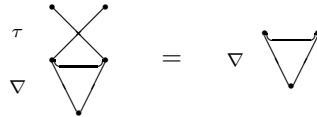

The pictures for the remaining symmetrization equations, which involve Δ and i , are the same pictures upside down.

A commutative Frobenius monad is *separable* when the following *separability equation* holds, for which we have the picture on the right:

$$\nabla \circ \Delta = \mathbf{1}_M \quad \begin{array}{c} \Delta \\ \nabla \end{array} \quad \begin{array}{c} \circlearrowleft \\ \circlearrowright \end{array} = \mathbf{1}_M \quad \Big|$$

(see [2], [17], and references therein).

An *equivalential Frobenius monad* is a separable commutative Frobenius monad that satisfies moreover the following *unit-counit homomorphism equation*, appropriate for bialgebras, for which in the picture on the right the right-hand side next to $\mathbf{1}$ is empty:

$$(0 \cdot 0) \quad i \circ ! = \mathbf{1} \quad \begin{array}{c} ! \\ i \end{array} \circ = \mathbf{1}$$

This equation is analogous to the separability equation.

Let \mathcal{EF} be the category of the equivalential Frobenius monad freely generated by a single object. The existence of this freely generated category is guaranteed by the purely equational assumptions we have made to define equivalential Frobenius monads. It is constructed out of syntactical material; its arrows are equivalence classes of arrow terms (see Section 5 below and [6], Chapter 2). The situation will be analogous with the definitions of the categories \mathcal{PF} , later in this section, and \mathcal{RB} , in the next section. (The assumptions involved will again be purely equational, and we will not mention any more that this guarantees the existence of these categories.)

We will show in Section 8 that the category \mathcal{EF} is isomorphic to the category *Gen* of the preceding section. (This explains the denomination “equivalential”.) This result should be compared to an analogous result of [14] (Example 5.4) and

[17] (Proposition 3.1), which connects separable commutative Frobenius monads and the category $\text{Cospan}(\text{Sets}_{\text{fin}})$.

A *preordering Frobenius monad* is an equivalential Frobenius monad that has an additional natural transformation

$$\downarrow: M \dot{\rightarrow} M,$$

which satisfies the equations we are now going to give. For the interpretation of \downarrow in SplPre we have the picture:



This natural transformation satisfies, first, the *downarrow-idempotence equation*, with the picture on the right:

$$\downarrow \circ \downarrow = \downarrow$$

and the following additional *symmetrization equation*, with the picture on the right:

$$\tau \circ \downarrow_M = M \downarrow \circ \tau$$

For the following definition, we have the picture on the right:

$$\uparrow =_{df} M i \circ M \nabla \circ M \downarrow_M \circ \Delta_M \circ !_M$$

since for $i \circ \nabla$ and $\Delta \circ !$ we have the pictures:

There is an alternative, equivalent, definition of \uparrow , with the picture:

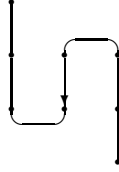

With the definition of \uparrow , we have the *up-and-down equation*:

$$\nabla \circ M\downarrow \circ \uparrow_M \circ \Delta = \mathbf{1}_M$$

$$= \text{I}$$

for which, since $M\downarrow \circ \uparrow_M$ corresponds to $\uparrow \downarrow$, we have the picture on the right above. This equation is analogous up to a point to the separability equation.

With the definitions

$$\nabla^\downarrow =_{df} \nabla \circ M\downarrow \circ \downarrow_M,$$

$$\Delta^\downarrow =_{df} M\downarrow \circ \downarrow_M \circ \Delta,$$

for which we have the pictures:



we have the three bialgebraic *multiplication-comultiplication homomorphism equations*, which for short we call the *mch equations*:

$$(2\cdot 0) \quad i \circ \nabla^\downarrow = i \circ Mi,$$

$$(0\cdot 2) \quad \Delta^\downarrow \circ ! = M! \circ !,$$

$$(2\cdot 2) \quad \Delta^\downarrow \circ \nabla^\downarrow = M\nabla^\downarrow \circ \nabla^\downarrow_{MM} \circ M\tau_M \circ MM\Delta^\downarrow \circ \Delta^\downarrow_M.$$

(The order of figures in the names of these equations is from left to right, while categorical equations are, unfortunately, written from right to left. We have the usual order in these names to make them parallel to a natural nomenclature for analogous equations later in the paper; see Sections 5-7, and compare also with the end of this section.) These three equations, for which the pictures follow, make together with the unit-counit homomorphism equation (0·0) the four *bialgebraic homomorphism equations*:



Finally, we have one more equation involving bialgebraic multiplication and comultiplication, i.e. ∇^\downarrow and Δ^\downarrow , which we call *bialgebraic separability*, with the picture on the right:

This equation is analogous to the separability equation given above for Frobenius multiplication and comultiplication, i.e. ∇ and Δ . This concludes the definition of a preordering Frobenius monad.

Let \mathcal{PF} be the category of the preordering Frobenius monad freely generated by a single object. We will show in Section 8 that \mathcal{PF} is isomorphic to the category *SplPre* of the preceding section. (This explains the denomination “preordering”.)

We are now going to show that we have in \mathcal{PF} four important equations, related to the four bialgebraic homomorphism equations. First we have an easier derivation given in pictures by:

- ¹ by bialgebraic separability and \downarrow -idempotence,
- ² by the *mch* equation (0·2) and a monadic equation.

We also have in \mathcal{PF} the derivation given in pictures by:

- ¹ by bialgebraic separability and \downarrow -idempotence,
- ² by the *mch* equation (2·2), symmetrization equations for \downarrow and \downarrow -idempotence,
- ³ by a monadic equation and a commutativity equation,
- ⁴ by \downarrow -idempotence and bialgebraic separability.

With these and analogous derivations, we have shown that we have in \mathcal{PF} the equations:

$$\begin{array}{ll}
(2\cdot 1) & \downarrow \circ \nabla^\downarrow = \nabla^\downarrow, & (1\cdot 2) & \Delta^\downarrow \circ \downarrow = \Delta^\downarrow, \\
(0\cdot 1) & \downarrow \circ ! = !, & (1\cdot 0) & i \circ \downarrow = i.
\end{array}$$

These equations show that, besides idempotence, \downarrow has in \mathcal{PF} further properties of an identity arrow. They enable us to show too that ∇^\downarrow and $!$ carry a monad structure, and that Δ^\downarrow and i carry a comonad structure (see the next section and Section 15). Note that in the derivations of these equations we have used bialgebraic separability and commutativity equations. (In the absence of these assumptions, we would have to consider assuming independently the four equations.)

In the style of the nomenclature of these four equations and of the bialgebraic homomorphism equations above, the \downarrow -idempotence equation should be named (1·1). This equation is derivable if bialgebraic separability is assumed in the form

$$\nabla \circ M \downarrow \circ \downarrow_M \circ \Delta = \downarrow,$$

and the bialgebraic homomorphism (2·2) is assumed in the form where the superscripts \downarrow on the right-hand side are omitted and $M\tau_M$ is replaced by

$$M\tau_M \circ MMM \downarrow \circ MM \downarrow_M \circ M \downarrow_{MM} \circ \downarrow_{MMM}.$$

4 The category \mathcal{RB}

In this section we define the category \mathcal{RB} , which is a categorial abstraction of a particular notion of bialgebra. This is the category for which we will prove that it is isomorphic with the category *Rel*.

We call *commutative bialgebraic monad* a structure given by a category \mathcal{A} , an endofunctor M^\downarrow of \mathcal{A} (associated in pictures with \downarrow), and the natural transformations

$$\begin{array}{ll}
\nabla^\downarrow: M^\downarrow M^\downarrow \rightarrow M^\downarrow, & \Delta^\downarrow: M^\downarrow \rightarrow M^\downarrow M^\downarrow, \\
!: I_{\mathcal{A}} \rightarrow M^\downarrow, & i: M^\downarrow \rightarrow I_{\mathcal{A}}
\end{array}$$

such that $\langle \mathcal{A}, M^\downarrow, \nabla^\downarrow, ! \rangle$ is a monad, $\langle \mathcal{A}, M^\downarrow, \Delta^\downarrow, i \rangle$ is a comonad; moreover, we have a natural symmetry isomorphism

$$\tau: M^\downarrow M^\downarrow \rightarrow M^\downarrow M^\downarrow,$$

inverse to itself, which satisfies the Yang-Baxter equation and the symmetrization equations of the preceding section for ∇ , Δ , $!$ and i with the superscript \downarrow added to M , ∇ and Δ , and, finally, we have the four bialgebraic homomorphism equations of the preceding section with the superscript \downarrow added to M . This defines commutative bialgebraic monads.

A *relational bialgebraic monad* is a commutative bialgebraic monad that satisfies moreover the following version of the bialgebraic separability equation:

$$\nabla^\downarrow \circ \Delta^\downarrow = \mathbf{1}_{M^\downarrow}.$$

The identity $\mathbf{1}_{M^\downarrow}$ of \mathcal{RB} corresponds in pictures to \downarrow . In general, all lines in pictures are arrows oriented from top to bottom (see Section 11).

Let \mathcal{RB} be the category of the relational bialgebraic monad freely generated by a single object. We will show in Section 14 that \mathcal{RB} is isomorphic to the category Rel , defined at the beginning of Section 2. (This explains the denomination “relational”.)

5 The category \mathcal{PF}_H

We introduce in this section a syntactically defined category \mathcal{PF}_H , for which we will show that it is isomorphic to the category \mathcal{PF} of the preordering Frobenius monad freely generated by a single object (see Section 3). In \mathcal{PF}_H , which is just another syntactical variant of \mathcal{PF} , we will obtain in Section 7 a normal form for arrows, which will enable us to prove in Section 8 the isomorphism of \mathcal{PF}_H and \mathcal{PF} with the category $SplPre$.

We designate the generating object of \mathcal{PF} with 0, and an object of \mathcal{PF} , which is of the form $M^n 0$, where M^n is a sequence of $n \geq 0$ occurrences of M , may be identified with the finite ordinal n . The objects of \mathcal{PF}_H will be just the finite ordinals, and are hence the same as those of $SplPre$.

Next we define inductively words that we call *arrow terms* of \mathcal{PF}_H . To every arrow term we assign a single *type*, which is an ordered pair (n, m) of finite ordinals; n is here the *source*, and m the *target*. That an arrow term f is of type (n, m) is, as usual, written $f: n \rightarrow m$.

First we have that the following, for every $n, m \geq 0$, are the *primitive arrow terms* of \mathcal{PF}_H :

$$\begin{aligned} {}_n \mathbf{1}_m &: n+m \rightarrow n+m, \\ {}_n !_m &: n+m \rightarrow n+1+m, & {}_n i_m &: n+1+m \rightarrow n+m, \\ {}_n \tau_m &: n+2+m \rightarrow n+2+m, \\ {}_n H_m &: n+2+m \rightarrow n+2+m. \end{aligned}$$

The remaining arrow terms of \mathcal{PF}_H are defined with the following inductive clause:

if $f: n \rightarrow m$ and $g: m \rightarrow k$ are arrow terms, then so is $g \circ f: n \rightarrow k$.

We use the following notation for $\theta \in \{\mathbf{1}, !, i, \tau, \mathbf{H}\}$:

$$\begin{aligned} n(k\theta)_m &=_{df} n+k\theta_{l+m} \\ n(g \circ f)_m &=_{df} n g_m \circ n f_m. \end{aligned}$$

To abbreviate notation, the left or right subscript 0 may be omitted.

To understand the equations of \mathcal{PF}_H we are going to give below, it helps very much to have in mind the split preorders of *SplPre* that correspond to the arrow terms. We have first:

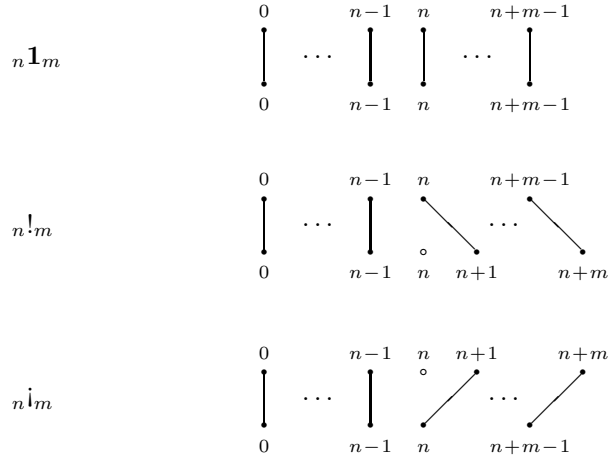

For τ and \mathbf{H} , which are ${}_0\tau_0$ and ${}_0\mathbf{H}_0$, we have:

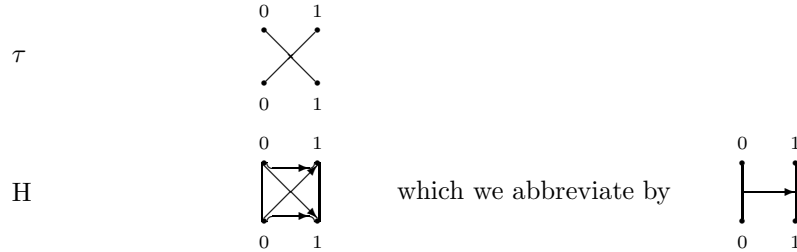

Out of the picture for $f: k \rightarrow l$ we obtain as follows the picture for $n f_m: n+k+m \rightarrow n+l+m$:

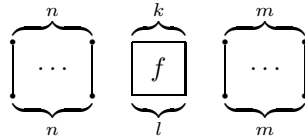

If n is 0, then there are no new lines on the left, and if m is 0, then there are no new lines on the right. The picture for ${}_n\mathbf{1}_m$ above may be obtained by this procedure from the empty picture, which corresponds to $\mathbf{1}$, i.e. ${}_0\mathbf{1}_0$, and analogously for $!$ and i . With that we have interpreted all the primitive arrow terms of \mathcal{PF}_H in $SplPre$, and \circ is of course interpreted as composition of split preorders. (With that interpretation we will define the functor G from \mathcal{PF}_H to $SplPre$ in Section 8.)

The arrows of \mathcal{PF}_H will be equivalence classes of arrow terms of \mathcal{PF}_H such that the *equations of \mathcal{PF}_H* , which we are now going to define, are satisfied. First we have a list of *axiomatic equations*, which is accompanied on the right by pictures of the corresponding split preorders of $SplPre$, except for the first two equations, where the pictures are much too simple. Our list starts with $f = f$, for every arrow term $f: n \rightarrow m$, and continues with the following equations:

$$(cat\ 1) \quad f \circ \mathbf{1}_n = f = \mathbf{1}_m \circ f,$$

$$(fun\ 1) \quad \mathbf{1}\mathbf{1} = \mathbf{1}_1,$$

for $\xi: p \rightarrow q$ and $\theta: k \rightarrow l$ such that $\xi, \theta \in \{!, i, \tau, H\}$, and $r \geq 0$,

$$(fl) \quad q+r\theta \circ \xi_{r+k} = \xi_{r+l} \circ p+r\theta$$

$$(\tau\tau) \quad \tau \circ \tau = \mathbf{1}_2$$

$$(\tau\ YB) \quad \mathbf{1}\tau \circ \tau_1 \circ \mathbf{1}\tau = \tau_1 \circ \mathbf{1}\tau \circ \tau_1$$

$$(\tau\ !) \quad \tau \circ !_1 = \mathbf{1}!$$

$$(\tau\ i) \quad i_1 \circ \tau = \mathbf{1}i$$

(H *idemp*) $H \circ H = H$ 

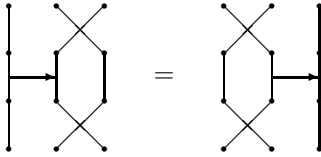
(H *YB*) ${}_1\tau \circ H_1 \circ {}_1\tau = \tau_1 \circ {}_1H \circ \tau_1$ 

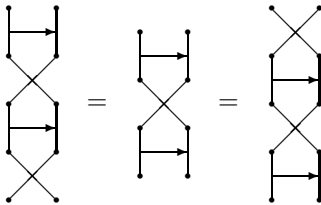
(H *com*) $\tau \circ H \circ \tau \circ H = H \circ \tau \circ H$
 $= H \circ \tau \circ H \circ \tau$ 

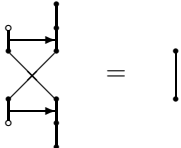
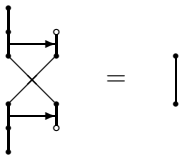
(H *bond*) ${}_1i \circ H \circ \tau \circ H \circ {}_1! = \mathbf{1}_1$
or, alternatively,
 ${}_1i \circ H \circ \tau \circ H \circ {}_1! = \mathbf{1}_1$ 

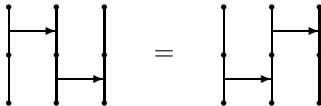
(HH) ${}_1H \circ H_1 = H_1 \circ {}_1H$ 

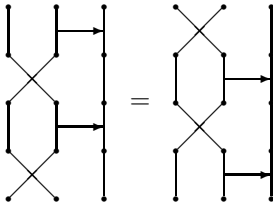
(HH *in*) $\tau_1 \circ {}_1H \circ \tau_1 \circ {}_1H = {}_1H \circ \tau_1 \circ {}_1H \circ \tau_1$ 

$$(HH \text{ out}) \quad {}_1\tau \circ H_1 \circ {}_1\tau \circ H_1 = H_1 \circ {}_1\tau \circ H_1 \circ {}_1\tau$$

The diagram shows two equivalent configurations of four vertical lines. The left side consists of two crossings, one above the other, with horizontal lines connecting the lines between crossings. The right side consists of two crossings, one to the right of the other, with horizontal lines connecting the lines between crossings.

$$(0 \cdot 0) \quad i \circ ! = \mathbf{1} \quad \circ =$$

The diagram shows a crossing of two lines with a dot on the top-right line, followed by a dot on the bottom-left line, which is equal to the identity (two parallel lines).

$$(H \ 2 \cdot 0) \quad {}_2i \circ {}_1H \circ \tau_1 \circ {}_1H \circ {}_2! = \tau$$

The diagram shows a sequence of crossings and horizontal lines involving two lines, which is equal to a single crossing of the two lines.

$$(H \ 0 \cdot 2) \quad i_2 \circ H_1 \circ {}_1\tau \circ H_1 \circ !_2 = \tau$$

The diagram shows a sequence of crossings and horizontal lines involving two lines, which is equal to a single crossing of the two lines.

$$(H \ 2 \cdot 2) \quad {}_2i_2 \circ {}_2H_1 \circ {}_1H_2 \circ {}_3\tau \circ \tau_3 \circ {}_2H_1 \circ {}_1H_2 \circ {}_2!_2 =$$

$${}_1H_1 \circ {}_2\tau \circ {}_1H_1 \circ {}_2\tau \circ \tau_2 \circ {}_1H_1 \circ {}_2\tau \circ {}_1H_1$$

The diagram shows a complex sequence of crossings and horizontal lines involving four lines, representing the equality of two different ways to compose these operations.

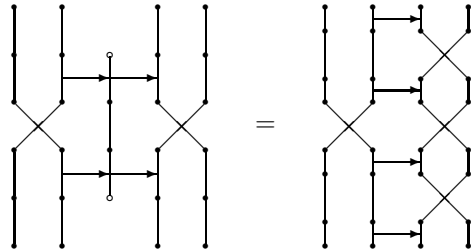

This concludes our list of axiomatic equations of \mathcal{PF}_H . To obtain all the equations of \mathcal{PF}_H , we assume that they are closed under symmetry and transitivity of equality, and under the *congruence rules*:

$$\text{if } f = g, \text{ then } {}_n f_m = {}_n g_m,$$

$$\text{if } f = g \text{ and } f' = g', \text{ then } f' \circ f = g' \circ g,$$

provided that the compositions $f' \circ f$ and $g' \circ g$ are defined. This concludes the definition of the equations of \mathcal{PF}_H .

For \mathcal{PF}_H to be a category, we must have that composition \circ is associative. This is however automatically guaranteed by our notation, in which we do not write parentheses associated with \circ .

The equation (fl) guarantees that for $f: n \rightarrow m$ and $g: k \rightarrow l$ we have in \mathcal{PF}_H

$${}_m g \circ f_k = f_l \circ {}_n g,$$

and we may choose either of the two sides of this equation as our definition of $f+g$. Together with $+$ on objects, this gives a biendofunctor of \mathcal{PF}_H . With the biendofunctor $+$ and 0 as the unit, \mathcal{PF}_H is strictly monoidal, in the sense that its associativity isomorphisms and its monoidal isomorphisms involving $+$ and 0 are identity arrows; \mathcal{PF}_H is moreover symmetric monoidal.

6 Derivation of \mathcal{PF}_H

In this section we show that, with appropriate definitions of the arrows of \mathcal{PF}_H , we have in the category \mathcal{PF} of Section 3 all the equations of \mathcal{PF}_H . Here are these definitions in \mathcal{PF} :

$$\begin{aligned} {}_n \theta_m &=_{df} M^n \theta_m, \quad \text{for } \theta \in \{\mathbf{1}, \nabla, \Delta, !, i, \tau, \downarrow\}, \\ {}_n H_m &=_{df} {}_{n+1} \nabla_m \circ {}_{n+1} \downarrow_{1+m} \circ {}_n \Delta_{1+m}, \end{aligned}$$

and here is the picture for the right-hand side of the second definition:

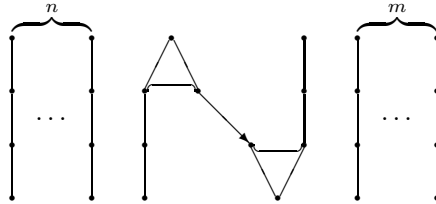

For an arbitrary arrow h of \mathcal{PF} , the notation ${}_n h_m$, introduced for \mathcal{PF}_H in the preceding section, is transposed to \mathcal{PF} with the old clauses for ${}_n ({}_k \theta_l)_m$ and ${}_n (g \circ f)_m$, save that now θ is in $\{\mathbf{1}, \nabla, \Delta, !, i, \tau, \downarrow\}$, and the new clause:

$${}_n (Mf)_m =_{df} {}_{n+1} f_m.$$

We derive then rather straightforwardly in \mathcal{PF} the equations of \mathcal{PF}_H . We give as an example some derivations that are more involved, and for the remaining equations we will make just brief indications.

As an auxiliary equation for the derivation in \mathcal{PF} of the axiomatic equations $(H \text{ com})$ and $(H \text{ bond})$, we have the following equation in \mathcal{PF} :

$$(\nabla \text{ circ}) \quad \nabla = \nabla \circ_1 (\downarrow \circ \nabla \circ \downarrow_1) \circ \Delta_1.$$

Here are the pictures that correspond to the derivation of this equation in \mathcal{PF} :

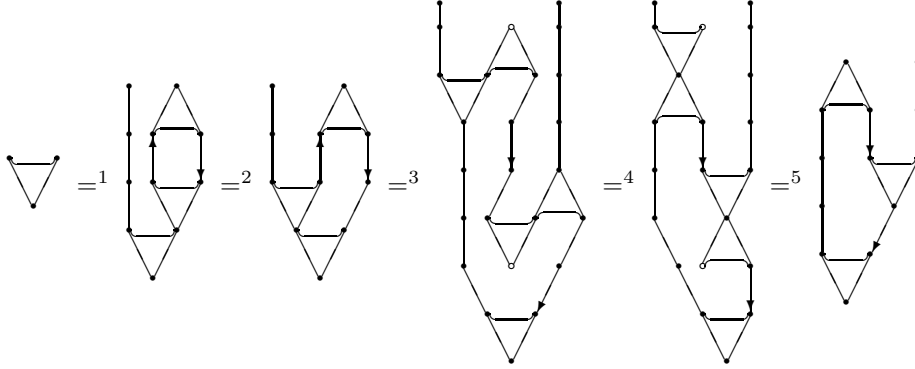

- ¹ by the up-and-down equation,
- ² by a monadic equation,
- ³ with the definition of \uparrow and naturality,
- ⁴ by applying twice a Frobenius equation,
- ⁵ by monadic and comonadic equations.

The up-and-down equation, which we have used in this derivation, can conversely be derived in \mathcal{PF} from $(\nabla \text{ circ})$ and the remaining equations; so $(\nabla \text{ circ})$ could replace the up-and-down equation in the presentation of \mathcal{PF} in Section 3.

To derive the equation $(H \text{ com})$ in \mathcal{PF} we rely on commutativity equations and on:

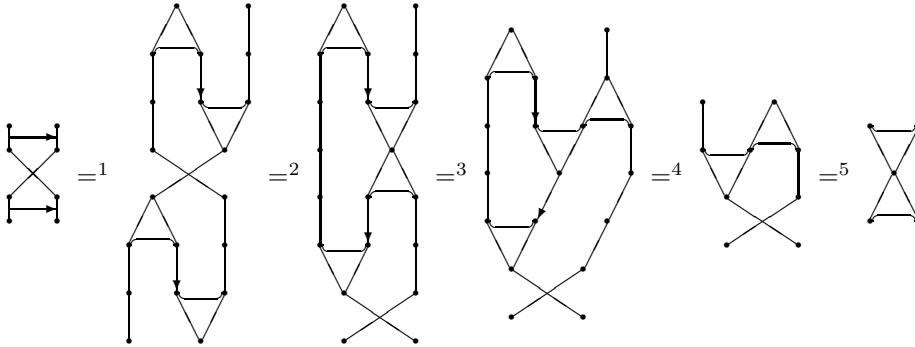

- ¹ by definition,
- ² by symmetrization equations,
- ³ by a Frobenius equation,
- ⁴ by $(\nabla \text{ circ})$,
- ⁵ by a Frobenius equation and a commutativity equation.

For (H *bond*) we then have

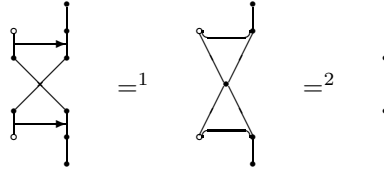

- ¹ as above,
- ² by monadic and comonadic equations.

As one more example, we sketch here the derivation in \mathcal{PF} of the equation (H 2·2). The left-hand side of this equation corresponds to the picture below on the left, while the right-hand side, with the help of monadic and comonadic equations, corresponds to the picture on the right:

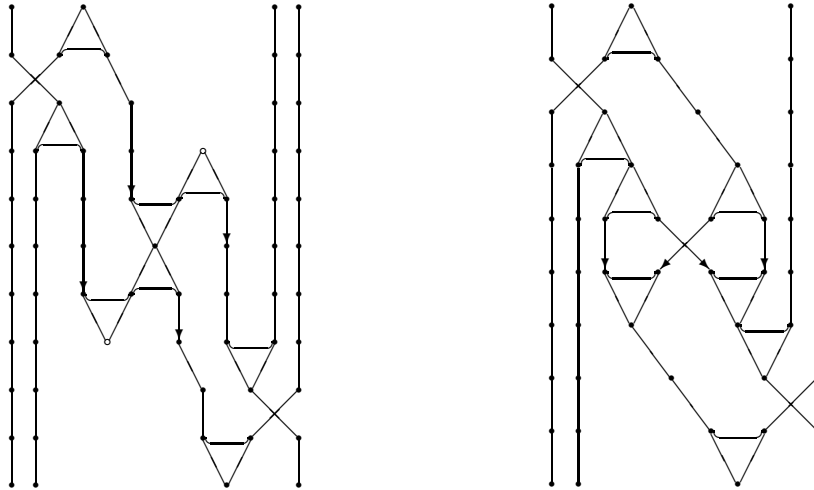

and we obtain (H 2·2) with the derivation corresponding to the following:

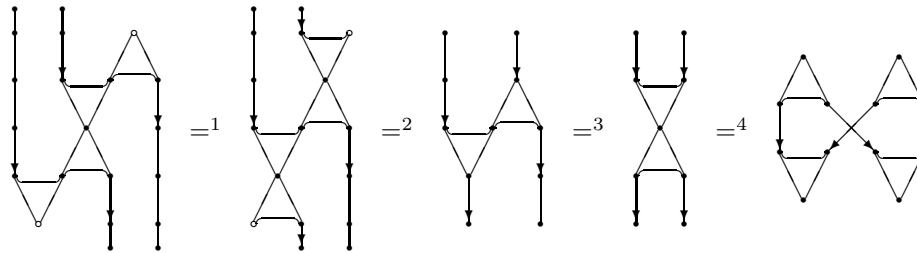

- ¹ by applying twice a Frobenius equation,
- ² by monadic and comonadic equations,
- ³ by a Frobenius equation,
- ⁴ by the *mch* equation (2.2).

For the remaining axiomatic equations of \mathcal{PF}_H we have that all those in the list from $f = f$ up to (τi) are established immediately in \mathcal{PF} ; the equation (f) follows from naturality equations. For $(H \text{ idemp})$ we use the monadic and comonadic equations and bialgebraic separability, while for $(H \text{ YB})$, (HH) , $(HH \text{ in})$ and $(HH \text{ out})$ we use the Frobenius equations and the symmetrization equations. The equation $(0 \cdot 0)$ is the unit-counit homomorphism equation we have assumed in \mathcal{PF} , while for the equations $(H \text{ 2} \cdot 0)$ and $(H \text{ 0} \cdot 2)$ we use besides monadic and comonadic equations the *mch* equations (2.0) and (0.2). Closure under transitivity and symmetry of equality, and under the congruence rules of \mathcal{PF}_H , is established immediately for \mathcal{PF} . With that we have established that all the equations of \mathcal{PF}_H hold in \mathcal{PF} .

To obtain in \mathcal{PF}_H the structure of a preordering Frobenius monad, i.e. the structure of \mathcal{PF} , we have the following definitions, with the corresponding pictures on the right:

$Mn =_{df} n+1,$	$Mf =_{df} !f,$
$\nabla =_{df} !_1 \circ H \circ \tau \circ H$	
$\Delta =_{df} H \circ \tau \circ H \circ !_1$	
$\downarrow =_{df} !_1 \circ H \circ !_1$	

We will not derive in \mathcal{PF}_H the equations of \mathcal{PF} . That, with the definitions we have just given, these equations hold in \mathcal{PF}_H will be quite easy to establish once we have proved the isomorphism of \mathcal{PF}_H with *SplPre* in Section 8. It will be enough to verify that the split preorders corresponding to the two sides of an equation of \mathcal{PF} are equal, and this we have already done to a great extent when we presented \mathcal{PF} in Section 3; it remains practically nothing to do.

To finish showing that \mathcal{PF} and \mathcal{PF}_H are isomorphic categories, we have to check that we have in \mathcal{PF} the equations of \mathcal{PF} obtained from the definitions

in \mathcal{PF}_H given above when the right-hand sides are defined in \mathcal{PF} , as at the beginning of this section. For example, we have to check that we have in \mathcal{PF}

$$\nabla = i_1 \circ_1 \nabla \circ_1 \downarrow_1 \circ \Delta_1 \circ \tau \circ_1 \nabla \circ_1 \downarrow_1 \circ \Delta_1,$$

which is derived as (H *com*). For the analogous equation of \mathcal{PF}_H obtained from the definition of ${}_n H_m$ in \mathcal{PF} , at the beginning of this section, it will be trivial to verify that it holds in \mathcal{PF}_H after establishing the isomorphism of \mathcal{PF}_H with *SplPre* (see the end of Section 8).

7 Eta normal form

We introduce in this section a normal form for the arrow terms of the category \mathcal{PF}_H , which we use in the next section to prove the isomorphism of \mathcal{PF}_H with the category *SplPre*. For example, an eta normal form for the arrow term H of \mathcal{PF}_H is an arrow term of \mathcal{PF}_H that corresponds to the picture:

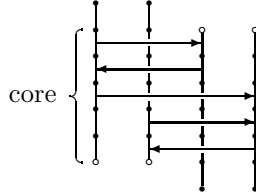

The core of this arrow term is a composition of arrow terms that can be associated in pictures with capital letters eta whose horizontal bar bridges vertical lines. These arrow terms stand for what we will call *eta arrows*. Before we define these arrows and our normal form based on them, we must deal with some preliminary matters.

If $m \geq 1$, then for $n \geq 0$ let $\pi: n+2 \rightarrow n+2$ be a composition of m arrow terms of \mathcal{PF}_H of the form ${}_p \tau_q$ where $p+q = n$, and let π^{-1} be obtained from π by reversing the order in the composition. We allow m also to be 0, in which case for $n \geq 0$ let π and π^{-1} both be $\mathbf{1}_n: n \rightarrow n$. Besides π , we use also ρ and σ for arrow terms like π .

We have seen in Section 3 that π corresponds to a permutation, which we may understand either as a split equivalence $G_e \pi: n+2 \rightarrow n+2$ of *Gen*, or as a function $G_f \pi: n+2 \rightarrow n+2$ of *Fun* (see the end of Section 2). We have, for example, the following picture:

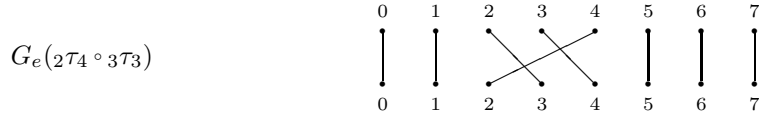

and the picture for $G_f(2\tau_4 \circ 3\tau_3)$ is the same with the lines $|$ replaced by \downarrow . The equation (fl) (i.e., the naturality of τ), the equation $(\tau\tau)$ (i.e. τ 's being inverse to itself) and the Yang-Baxter equation $(\tau \text{ YB})$ guarantee that we have $\pi = \rho$ in \mathcal{PF}_H iff $G_e\pi = G_e\rho$ iff $G_f\pi = G_f\rho$. For our exposition here, we will rely on the G_f interpretation, which is more handy, and we will write $\pi(i) = j$ when $(G_f\pi)(i) = j$. We can prove the following.

LEMMA 1. *For every $\pi: n+2 \rightarrow n+2$ such that $\pi(0) = k$ and $\pi(1) = k+1$, the following equation holds in \mathcal{PF}_H :*

$${}_kH_{n-k} \circ \pi = \pi \circ H_n.$$

PROOF. We proceed by induction on k . If $k = 0$, then either π is equal to a composition of arrow terms of the form ${}_{2+p}\tau_q$ for $2+p+q = n$, and we can apply the equation (fl) , or π is $\mathbf{1}_{n+2}$, in which case we apply $(cat 1)$.

If $k > 0$, then we know that π is equal to ${}_{k-1}\tau_{n-k+1} \circ {}_k\tau_{n-k} \circ \pi'$ for $\pi'(0) = k-1$ and $\pi'(1) = k$. The picture is:

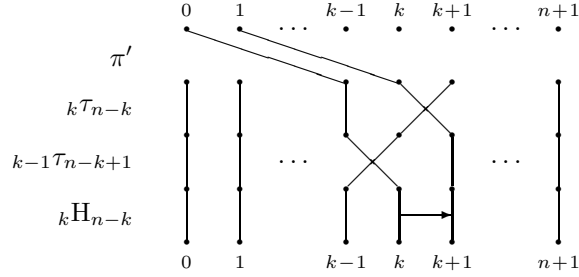

Then we apply the equation $(H \text{ YB})$ and the induction hypothesis. \dashv

LEMMA 2. *For every $\pi, \rho: n+2 \rightarrow n+2$ such that $\pi^{-1}(k) = \rho^{-1}(l)$ and $\pi^{-1}(k+1) = \rho^{-1}(l+1)$, the following equation holds in \mathcal{PF}_H :*

$$\pi^{-1} \circ {}_kH_{n-k} \circ \pi = \rho^{-1} \circ {}_lH_{n-l} \circ \rho.$$

PROOF. Let $\pi^{-1}(k) = \rho^{-1}(l) = i$ and $\pi^{-1}(k+1) = \rho^{-1}(l+1) = j$, and consider any σ such that $\sigma(0) = i$ and $\sigma(1) = j$. Then, since $(\pi \circ \sigma)(0) = \pi(i) = k$ and $(\pi \circ \sigma)(1) = \pi(j) = k+1$, by Lemma 1 above we have in \mathcal{PF}_H

$$\sigma^{-1} \circ \pi^{-1} \circ {}_kH_{n-k} \circ \pi \circ \sigma = H_n,$$

and, since $(\rho \circ \sigma)(0) = \rho(i) = l$ and $(\rho \circ \sigma)(1) = \rho(j) = l+1$, by Lemma 1 we have in \mathcal{PF}_H

$$\sigma^{-1} \circ \rho^{-1} \circ {}_lH_{n-l} \circ \rho \circ \sigma = H_n.$$

From that the lemma follows. \dashv

For $\pi: n+1 \rightarrow n+1$ such that $\pi(k) = l$, let $\pi^{-(k,l)}: n \rightarrow n$ correspond intuitively to the permutation obtained from the permutation of π by removing the

pair (k, l) (see the example below, after Lemma 3). More precisely, for $n \geq 1$, we have $\pi^{-(k,l)}(i) = j$ iff

$$\begin{aligned} \pi(i) &= j && \text{for } i < k \text{ and } j < l, \\ \pi(i) &= j+1 && \text{for } i < k \text{ and } j \geq l, \\ \pi(i+1) &= j && \text{for } i \geq k \text{ and } j < l, \\ \pi(i+1) &= j+1 && \text{for } i \geq k \text{ and } j \geq l; \end{aligned}$$

for $n = 0$, let $\pi^{-(k,l)}$, which is $\mathbf{1}_1^{-(0,0)}$, be $\mathbf{1}_0$.

According to this definition, for $n = 1$ we obtain also that $\pi^{(k,l)}$ is $\mathbf{1}_n$. We can prove the following.

LEMMA 3. *For every $\pi: n+1 \rightarrow n+1$ such that $\pi(k) = l$, the following equations hold in \mathcal{PF}_H :*

$$\begin{aligned} \pi \circ k!_{n-k} &= l!_{n-l} \circ \pi^{-(k,l)}, \\ l!_{n-l} \circ \pi &= \pi^{-(k,l)} \circ k!_{n-k}. \end{aligned}$$

In the proof of this lemma we use essentially the equations $(\tau!)$ and (τi) . We have, for example:

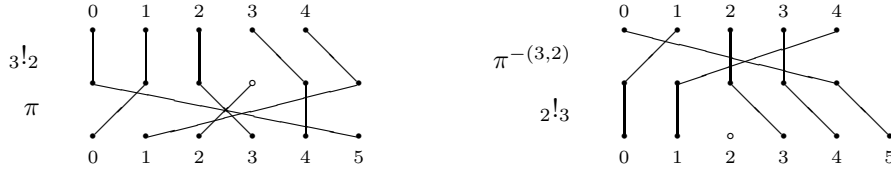

We have now finished with preliminary matters, and we are ready to give our definition eta arrows.

For $i, j \in \{0, \dots, n+1\}$, where $n \geq 0$, such that $i \neq j$, and $\pi: n+2 \rightarrow n+2$ such that $\pi(i) = k \leq n$ and $\pi(j) = k+1$, let

$$(i, j)^{n+2} =_{df} \pi^{-1} \circ k!_{n-k} \circ \pi: n+2 \rightarrow n+2.$$

By Lemma 2 above, for any $k \in \{0, \dots, n\}$, and any π satisfying the conditions in the definition we have just given, we obtain the same arrow of \mathcal{PF}_H . We call this arrow $(i, j)^{n+2}$ an *eta arrow*.

For $(i, j)^{n+2}$ we have the pictures on the left, with a definition illustrated on the right:

for $i < j$,

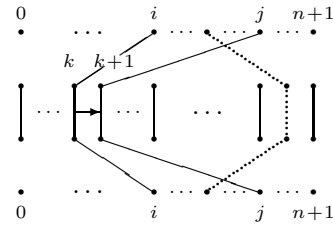
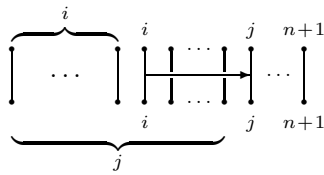

for $j < i$,

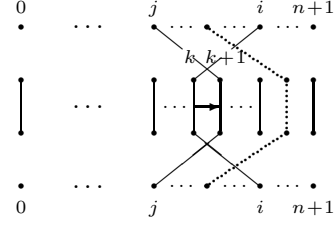
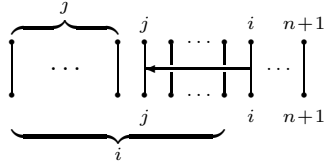

We define ${}_k(i, j)_l^{n+2}$ as $(k+i, k+j)^{k+n+2+l}$. Note that we have $H = (0, 1)^2 = \mathbf{1}_2 \circ H \circ \mathbf{1}_2$, which yields the following equation of \mathcal{PF}_H :

$$(H \text{ def}) \quad {}_n H_m = (n, n+1)^{n+2+m},$$

the right-hand side of which may be defined as $\mathbf{1}_{n+2+m} \circ {}_n H_m \circ \mathbf{1}_{n+2+m}$.

We have in \mathcal{PF}_H also the following equation, whose picture is on the right:

$$\tau = i_2 \circ (2, 0)^3 \circ (0, 2)^3 \circ 2!$$

which yields the following equation of \mathcal{PF}_H :

$$(\tau \text{ def}) \quad {}_n \tau_m = {}_n i_{2+m} \circ (n+2, n)^{n+3+m} \circ (n, n+2)^{n+3+m} \circ {}_{n+2} !_m.$$

So, by (H def) and (τ def), every arrow of \mathcal{PF}_H is equal to a composition of eta arrows and arrows of the forms ${}_n \mathbf{1}_m$, ${}_n !_m$ and ${}_n i_m$. The first step we take in our reduction to eta normal form is to pass to such a composition.

We deal next with a number of equations concerning eta arrows, which will serve for further steps in the reduction. For $l, p \geq 0$, let

$$l \overleftarrow{p} 1 = \begin{cases} l-1 & \text{if } l > p, \\ l & \text{if } l \leq p. \end{cases}$$

If $\min(i, j) < p < \max(i, j)$, then the following equations hold in \mathcal{PF}_H :

$$(\eta !) \quad (i, j)^{p+1+q} \circ {}_p !_q = {}_p !_q \circ (i \overleftarrow{p} 1, j \overleftarrow{p} 1)^{p+q},$$

$$(\eta i) \quad {}_p i_q \circ (i, j)^{p+1+q} = (i \overleftarrow{p} 1, j \overleftarrow{p} 1)^{p+q} \circ {}_p i_q.$$

Here is an example illustrating the first equation:

To derive the equations $(\eta !)$ and (ηi) we apply essentially Lemma 3 above. We also have in \mathcal{PF}_H :

$$\begin{aligned} (\eta \text{ idemp}) \quad & (i, j)^m \circ (i, j)^m = (i, j)^m, \\ (\eta \text{ perm}) \quad & (i, j)^m \circ (k, l)^m = (k, l)^m \circ (i, j)^m. \end{aligned}$$

The equation $(\eta \text{ idemp})$ follows easily from $(H \text{ idemp})$, while for the second equation we have the following.

PROOF OF $(\eta \text{ perm})$. Since $i \neq j$ and $k \neq l$, the following cases exhaust all the possibilities for i, j, k and l :

- (1) i, j, k and l are all distinct,
- (2) $i = l$ and $j = k$,
- (3) $(i \neq l \text{ and } j = k)$ or $(i = l \text{ and } j \neq k)$,
- (4) $i = k$ and $j = l$,
- (5) $(i \neq k \text{ and } j = l)$ or $(i = k \text{ and } j \neq l)$.

In all cases we find a $\pi: m \rightarrow m$ satisfying certain conditions, and define $(i, j)^m$ and $(k, l)^m$ in terms of it.

In case (1) we have $m \geq 4$, and

$$\begin{aligned} \pi(i) = 0, \pi(j) = 1, \pi(k) = 2 \text{ and } \pi(l) = 3, \\ (i, j)^m = \pi^{-1} \circ H_{m-2} \circ \pi, \\ (k, l)^m = \pi^{-1} \circ {}_2H_{m-4} \circ \pi. \end{aligned}$$

We rely then on the equation (fl) .

In case (2) we have $m \geq 2$, and

$$\begin{aligned} \pi(i) = \pi(l) = 0 \text{ and } \pi(j) = \pi(k) = 1, \\ (i, j)^m = \pi^{-1} \circ H_{m-2} \circ \pi, \\ (k, l)^m = \pi^{-1} \circ \tau_{m-2} \circ H_{m-2} \circ \tau_{m-2} \circ \pi. \end{aligned}$$

We rely then on the equation $(H \text{ com})$.

In case (3) we have $m \geq 3$, and for $i \neq l$ and $j = k$

$$\begin{aligned} \pi(i) = 0, \pi(j) = \pi(k) = 1 \text{ and } \pi(l) = 2, \\ (i, j)^m = \pi^{-1} \circ H_{m-2} \circ \pi, \\ (k, l)^m = \pi^{-1} \circ {}_1H_{m-3} \circ \pi. \end{aligned}$$

We rely then on the equation (HH) . We proceed analogously for $i = l$ and $j \neq k$.

Case (4) is trivial, and in case (5) we proceed as in case (3) by relying on the equations $(HH \text{ in})$ and $(HH \text{ out})$. -1

A set A of arrows of \mathcal{PF}_H , all of the same type $n \rightarrow n$ for some $n \geq 0$, is *commutative* when for every $f, g \in A$ we have $f \circ g = g \circ f$ in \mathcal{PF}_H . For such a commutative set A , let A° be the arrow of \mathcal{PF}_H obtained by composing all the arrows of A in an arbitrary order; if A is empty, then let A° be $\mathbf{1}_n$.

Then for every $k, l \geq 1$ we have in \mathcal{PF}_H the following with $m_i \neq p$ for every $i \in \{1, \dots, k\}$ and $p \neq r_j$ for every $j \in \{1, \dots, l\}$:

$$(\eta \ k \cdot l) \quad {}_p i_q \circ \{(m_i, p)^{p+1+q} \mid 1 \leq i \leq k\}^\circ \circ \{(p, r_j)^{p+1+q} \mid 1 \leq j \leq l\}^\circ \circ {}_p!_q = \\ \{(m_i \overline{p} 1, r_j \overline{p} 1)^{p+q} \mid 1 \leq i \leq k \ \& \ 1 \leq j \leq l \ \& \ m_i \overline{p} 1 \neq r_j \overline{p} 1\}^\circ.$$

PROOF. For the following simple instance of $(\eta \ k \cdot l)$:

$$(\eta \ 1 \cdot 2) \quad {}_1 i_2 \circ (0, 1)^4 \circ (1, 2)^4 \circ (1, 3)^4 \circ {}_1!_2 = (0, 1)^3 \circ (0, 2)^3,$$

whose picture is:

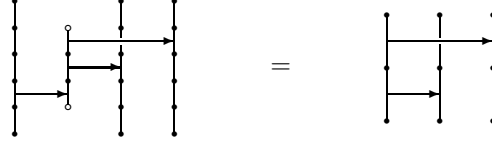

we have in \mathcal{PF}_H the derivation corresponding to:

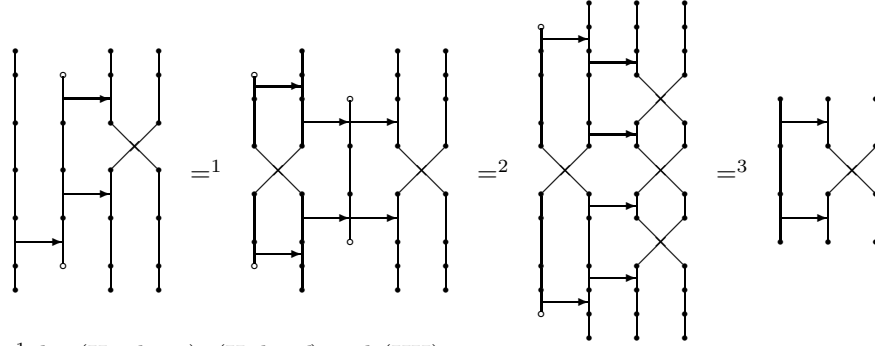

¹ by (H *idemp*), (H *bond*) and (HH),

² by (H 2.2),

³ by (HH), (H *bond*), (HH *out*), $(\tau\tau)$ and (H *idemp*).

We derive analogously the following equation:

$$(\eta \ 2 \cdot 1) \quad {}_2 i_1 \circ (0, 2)^4 \circ (1, 2)^4 \circ (2, 3)^4 \circ {}_2!_1 = (0, 2)^3 \circ (1, 2)^3,$$

whose picture is

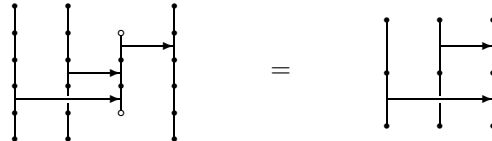

and the following equation, with its picture on the right:

$$(\eta \ 1 \cdot 1) \quad {}_1i_1 \circ (0, 1)^3 \circ (1, 2)^3 \circ {}_1!_1 = (0, 1)^2 \quad \begin{array}{c} | \\ \hline \rightarrow \circ \rightarrow \\ \hline | \end{array} = \begin{array}{c} | \\ \hline \rightarrow \\ \hline | \end{array}$$

With a well chosen π , with Lemma 3, and with $(\eta \ 1 \cdot 1)$, $(\eta \ 2 \cdot 1)$, $(\eta \ 1 \cdot 2)$ and $(H \ 2 \cdot 2)$, we can then derive every instance of $(\eta \ k \cdot l)$ where $k, l \in \{1, 2\}$.

If $k > 2$ or $l > 2$, then we apply essentially $(\eta \ 2 \cdot 1)$ or $(\eta \ 1 \cdot 2)$ to decrease k or l , until we obtain $k, l \in \{1, 2\}$. \dashv

For every $k, l \geq 1$ we have in \mathcal{PF}_H also the following analogous equations with $m_i \neq p$ for every $i \in \{1, \dots, k\}$ and $p \neq r_j$ for every $j \in \{1, \dots, l\}$:

$$(\eta \ k \cdot 0) \quad {}_pi_q \circ \{(m_i, p)^{p+1+q} \mid 1 \leq i \leq k\}^\circ \circ {}_p!_q = {}_p\mathbf{1}_q,$$

$$(\eta \ 0 \cdot l) \quad {}_pi_q \circ \{(p, r_j)^{p+1+q} \mid 1 \leq j \leq l\}^\circ \circ {}_p!_q = {}_p\mathbf{1}_q.$$

PROOF. To derive these equations for $k = l = 2$ we use $(H \ 2 \cdot 0)$ and $(H \ 0 \cdot 2)$. For $k = l = 1$, we use $(H \ idemp)$ and $(H \ bond)$ as in the derivation of $(\eta \ 1 \cdot 2)$ in the proof above in order to increase k and l to 2. This enables us to derive with the help of $(H \ 2 \cdot 0)$ and $(H \ 0 \cdot 2)$ the following simple instances of $(\eta \ k \cdot 0)$ and $(\eta \ 0 \cdot l)$, with their pictures on the right:

$$(\eta \ 1 \cdot 0) \quad {}_1i \circ (0, 1)^2 \circ {}_1! = \mathbf{1}_1 \quad \begin{array}{c} | \\ \hline \rightarrow \circ \\ \hline | \end{array} = \begin{array}{c} | \\ \hline \\ \hline | \end{array}$$

$$(\eta \ 0 \cdot 1) \quad {}_i1 \circ (0, 1)^2 \circ {}_1! = \mathbf{1}_1 \quad \begin{array}{c} \circ \rightarrow \\ \hline | \end{array} = \begin{array}{c} | \\ \hline \\ \hline | \end{array}$$

Then, with a well chosen π and with Lemma 3, we derive every instance of $(\eta \ k \cdot 0)$ and $(\eta \ 0 \cdot l)$ where $k, l \in \{1, 2\}$.

If $k > 2$ and $l > 2$, then, as in the previous proof, we apply $(\eta \ 2 \cdot 1)$ and $(\eta \ 1 \cdot 2)$ to decrease k and l , until we obtain $k = 2$ and $l = 2$. \dashv

The following equation of \mathcal{PF}_H :

$$(H \ Tr) \quad H_1 \circ {}_1H = H_1 \circ {}_1H \circ (0, 2)^3$$

is derived as in the following pictures:

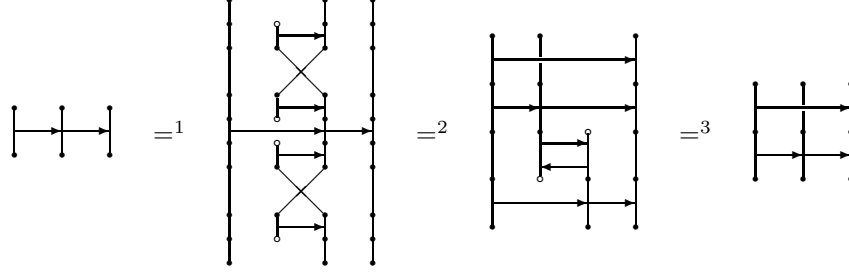

- ¹ by (H *bond*),
- ² by ($\eta!$), (ηi), (H *com*), ($\eta k \cdot l$) and ($\eta perm$),
- ³ by (H *bond*) and (H *idemp*).

Here is a generalization of this equation:

$$(\eta Tr) \quad (m, p)^n \circ (p, r)^n = (m, p)^n \circ (p, r)^n \circ (m, r)^n,$$

which is derived in \mathcal{PF}_H from (H *Tr*) with a well chosen π . We have this equation when all the eta arrows in it are defined, which means in particular that m must be different from r .

We have now enough equations for our reduction to eta normal form, but we still need the following definitions:

$$\begin{aligned} !^0 &= \mathbf{1}, & i^0 &= \mathbf{1}, \\ !^{n+1} &= !_n \circ !^n, & i^{n+1} &= i^n \circ i_n, \end{aligned}$$

$$0^{n,m} =_{df} !^m \circ i^n : n \rightarrow m,$$

$$\overline{(i, j)}^{n+2} =_{df} (i, j)^{n+2} \circ (j, i)^{n+2},$$

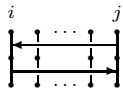
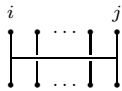
with the picture  abbreviated by 

$$\natural^0 =_{df} \mathbf{1},$$

$$\text{for } n \geq 1, \quad \natural^n =_{df} i_n^n \circ \overline{(n-1, 2n-1)}^{2n} \circ \dots \circ \overline{(0, n)}^{2n} \circ_n !^n,$$

with the picture:

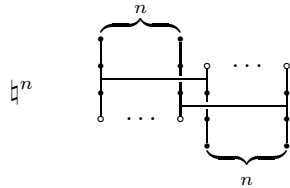

By relying essentially on (H *bond*), in \mathcal{PF}_H we can derive $\natural^n = \mathbf{1}_n$. So for $f: n \rightarrow m$ an arbitrary arrow term of \mathcal{PF}_H we have

$$\begin{aligned} f &= \natural^m \circ f \circ \natural^n, \\ &= i_m^n \circ f' \circ n!^m, \quad \text{by } (fl), \end{aligned}$$

for an arrow term $f': n+m \rightarrow n+m$ (see the examples below). With that we will make the second step in our reduction to eta normal form.

As the first step in our reduction, we have seen earlier in this section that, by (H *def*) and (τ *def*), every arrow of \mathcal{PF}_H is equal to a composition of eta arrows and arrows of the forms $p\mathbf{1}_q$, $p!_q$ and $p!_q$. We may take that f in the equation $f = i_m^n \circ f' \circ n!^m$ of \mathcal{PF}_H , which we have just derived, is such a composition, and f' too will be such a composition. With that we have made the second step in our reduction.

If $n \geq 1$, then a composition $f_n \circ \dots \circ f_1: k \rightarrow k$ such that for every $i \in \{1, \dots, n\}$ the factor $f_i: k \rightarrow k$ is an eta arrow is an *eta composition*. We allow also that $n = 0$, in which case $\mathbf{1}_k$ is an *empty eta composition*.

The form of f' above is particular. This form is made clear by the corresponding picture (see the examples below), where every vertical line except the first n lines on the left and the last m lines on the right is tied to a single $p!_q$ at the top and a single $p'i_{q'}$ at the bottom. The first n and last m vertical lines are not tied to any $p!_q$ or $p'i_{q'}$. All the factors of the forms $p!_q$ and $p'i_{q'}$ in f' , which come in pairs $(p!_q, p'i_{q'})$ tied to the same vertical line in the picture, are bound to disappear by applying essentially the equations $(\eta k \cdot l)$, $(\eta k \cdot 0)$, $(\eta 0 \cdot l)$ and $(0 \cdot 0)$, for which the ground is prepared by $(\eta !)$, (ηi) , $(\eta perm)$ and (fl) . One could devise a syntactical criterion to recognize which pair $(p!_q, p'i_{q'})$ of factors in f' is tied to the same vertical line in the picture, but all one has to do essentially is to push in the composition $p!_q$ factors to the left and $p'i_{q'}$ factors to the right, by using the equations $(\eta !)$ and (ηi) from left to right and the equation (fl) , until these factors cannot be pushed any more. We may then need further preparations with $(\eta !)$, (ηi) , $(\eta perm)$ and (fl) , until in the pairs $(p!_q, p'i_{q'})$ tied to the same vertical line p becomes equal to p' and q equal to q' , and no horizontal bar of an eta bridges this vertical line. We are then ready to apply $(\eta k \cdot l)$, $(\eta k \cdot 0)$, $(\eta 0 \cdot l)$ and $(0 \cdot 0)$.

In this way we obtain that $f' = f''$ in \mathcal{PF}_H for an eta composition $f'': n+m \rightarrow n+m$ (possibly empty). With that we have made the third, crucial, step in our reduction to eta normal form.

Here is an example in pictures of passing from f to $i_m^n \circ f'' \circ n!^m$:

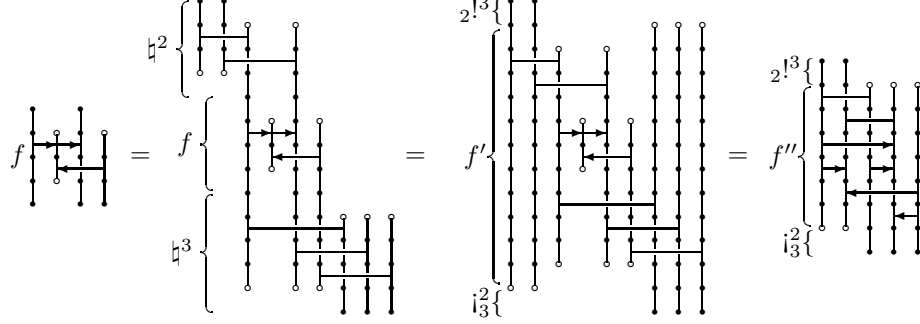

If $f: n \rightarrow m$ happens to be equal in \mathcal{PF}_H to $0^{n,m}$, then $f'' = \mathbf{1}_{n+m}$. For example:

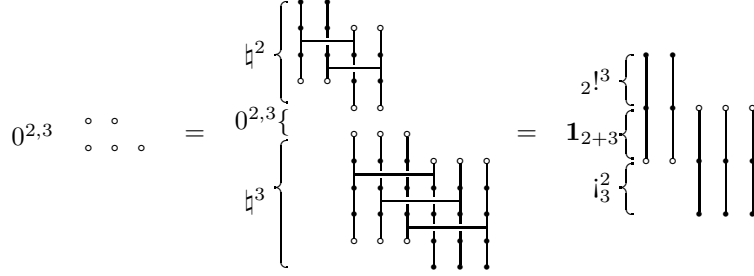

In particular, if $n = m = 0$, then f must be equal to $0^{0,0}$, and

$$i_3^n = i_3^m = n!^m = i_m^n = f'' = \mathbf{1}.$$

We will say that an eta composition $g: n \rightarrow n$ is *closed for strict transitivity* (see Section 1) when the following holds:

if for some factors $(m, p)^n$ and $(p, r)^n$ of g we have $m \neq r$, then there is a factor $(m, r)^n$ of g .

The eta composition f'' we have produced above is closed for strict transitivity, but we are not obliged to prove that, because if it were not, then we could rely on (ηTr) to obtain an eta composition closed for strict transitivity equal to f'' in \mathcal{PF}_H . So we may assume first that f'' is closed for strict transitivity. Next, because of $(\eta idemp)$, for which the ground is prepared by $(\eta perm)$, we may assume that there are no repetitions among the factors of f'' . Finally, because of $(cat 1)$, we may assume that either all the factors of f'' are eta arrows or f'' is the identity arrow $\mathbf{1}_{n+m}$. An eta composition satisfying all the three assumptions of this paragraph is said to be *pure*.

Since we have $(\eta perm)$, the pure eta composition f'' is of the form B° for a commutative set B of eta arrows. This is the set of eta arrows of f'' . This set is empty when f'' is $\mathbf{1}_{n+m}$.

So we have established that for every arrow f of \mathcal{PF}_H there is a pure eta composition f'' such that in \mathcal{PF}_H

$$f = i_m^n \circ f'' \circ n!^m.$$

With that we have made the fourth, and final, step in our reduction to eta normal form.

An arrow term of the form of the right hand-side of the displayed equation is in *eta normal form*. It is an eta normal form of the arrow term f of \mathcal{PF}_H , and f'' is the *eta core* of this eta normal form. An illustrated example of an eta normal form is given in the next section.

An eta normal form could be taken as a specific arrow term by choosing particular arrow terms that stand for eta arrows, and by choosing a particular order for these arrow terms in the eta core of the eta normal form. These choices are however arbitrary, and we need not make them for our purposes.

With reduction to eta normal form we have as a matter of fact yet another alternative syntactic formulation of the category \mathcal{PF} , for which \mathcal{PF}_H is just a bridge. The first step in our reduction procedure introduces us into this alternative language. The primitive arrow terms in this formulation would be $n\mathbf{1}_m, n!^m, n i_m$ and terms for eta arrows, with perhaps $n\mathbf{1}_m$ omitted; arrow terms would be closed under composition, and the appropriate axiomatic equations can be gathered from our reduction procedure.

Our eta normal forms are not unique as arrow terms, but after we have proved the Key Lemma in the next section, we will be able to assert that if f'' and g'' are the eta cores of eta normal forms of the same arrow of \mathcal{PF}_H , then the sets of eta arrows of f'' and g'' are equal. Before we prove the Key lemma, it is not even clear whether $f'' = g''$ in \mathcal{PF}_H .

It is however clear that if f'' and g'' are the eta cores of eta normal forms of the arrow terms f and g of \mathcal{PF}_H of the same type, and the sets of eta arrows of f'' and g'' are equal, then $f'' = g''$, and hence also $f = g$, in \mathcal{PF}_H . For that we use (η perm).

8 The isomorphism of \mathcal{PF} , \mathcal{PF}_H and $SplPre$

Let the functor G from \mathcal{PF}_H to $SplPre$ be identity on objects. To define it on arrows, let it assign to the arrow terms of \mathcal{PF}_H the split preorders corresponding to the pictures we have given in Section 5. Formally, G is defined by induction on the complexity of the arrow term. We have that $G\mathbf{1}_n$ is the identity split preorder on n (see Section 2), and $G(g \circ f) = Gg \circ Gf$, where \circ on the right-hand side is composition of split preorders.

By induction on the length of derivation we can then easily verify that

$$(G) \quad \text{if } f = g \text{ in } \mathcal{PF}_H, \text{ then } Gf = Gg \text{ in } SplPre.$$

Most of the work for this induction is in the basis, when $f = g$ is an axiomatic equation, and we have already gone through that in our pictures accompanying the axiomatic equations in Section 5. So G is indeed a functor. We will now prove the following.

PROPOSITION. *The functor G from \mathcal{PF}_H to $SplPre$ is an isomorphism.*

To prove this proposition we establish first that G is onto on arrows. This is done by representing every arrow of $SplPre$ in a form corresponding to the eta normal form of the preceding section. For every split preorder $P: n \rightarrow m$, it is easy to see that P is equal to the split preorder $G_4^m \circ P \circ G_4^n$, which is equal to a split preorder corresponding to an arrow term of \mathcal{PF}_H in eta normal form. For example, the split preorders given by the following two pictures are equal:

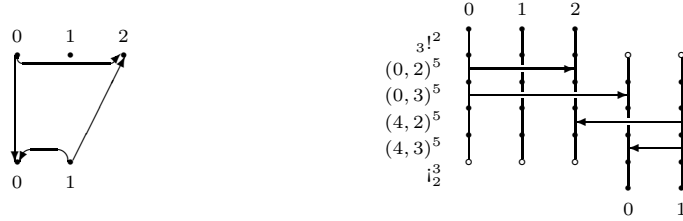

There are however other ways to show that G is onto on arrows (see Section 14).

For an arrow term $f: n \rightarrow m$ of \mathcal{PF}_H , let $G_s f$ be the set $\{(x, y) \in Gf \mid x \neq y\}$. The set $G_s f$ belongs to the split strict preorder corresponding to the split preorder Gf (see Section 1). It is determined uniquely by Gf , and it determines Gf uniquely, provided the type $n \rightarrow m$ is given. Let B be the set of eta arrows of the eta core f'' of an eta normal form of f (see the preceding section). It is straightforward to establish the following.

KEY LEMMA. *There is a bijection $\beta: G_s f \rightarrow B$ such that*

$$\begin{aligned} \beta(k_1, l_1) &= (k, l)^{n+m}, \\ \beta(k_1, l_2) &= (k, n+l)^{n+m}, \\ \beta(k_2, l_1) &= (n+k, l)^{n+m}, \\ \beta(k_2, l_2) &= (n+k, n+l)^{n+m}. \end{aligned}$$

This lemma is illustrated by the example in the following pictures, which we have already considered above:

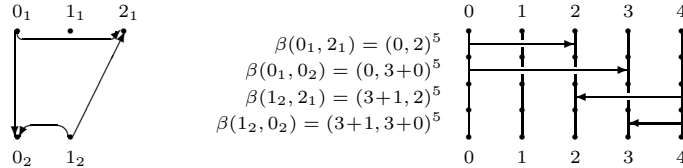

We are now ready to prove that G is one-one on arrows; i.e. the converse of the implication (G) above. For f and g arrow terms of \mathcal{PF}_H of the same type, let f'' and g'' be the eta cores of eta normal forms of f and g , and let B and C be the sets of eta arrows of f'' and g'' . If $Gf = Gg$, then $G_s f = G_s g$, and the bijection of the Key Lemma establishes that $B = C$. Hence, as we have remarked at the end of the preceding section, $f = g$ in \mathcal{PF}_H . With this our proposition is proved.

With the help of this Proposition we can ascertain that \mathcal{PF}_H is isomorphic to the category \mathcal{PF} of the preordering Frobenius monad freely generated by a single object (see Section 3). We have derived already in Section 6 all the equations of \mathcal{PF}_H in \mathcal{PF} . It remains to verify that all the equations of \mathcal{PF} hold in \mathcal{PF}_H , with M, ∇, Δ and \downarrow defined in \mathcal{PF}_H as in Section 6. We have to verify also that the following equation obtained from the definition at the beginning of Section 6 holds in \mathcal{PF}_H :

$$H = {}_1(i_1 \circ H \circ \tau \circ H) \circ {}_1(i_1 \circ H \circ !)_1 \circ (H \circ \tau \circ H \circ !)_1.$$

All these verifications are made easily via *SplPre*, by relying on the Proposition above. We have no need for lengthy derivations in \mathcal{PF}_H . Suppose $f = g$ is an equation assumed for \mathcal{PF} or the equation we have just displayed. To show that $f = g$ holds in \mathcal{PF}_H , it is enough to verify easily that the split preorders Gf and Gg are the same, and we have gone through this verification to a great extent when we presented \mathcal{PF} in Section 3. So we have the following.

THEOREM. *The categories \mathcal{PF} , \mathcal{PF}_H and *SplPre* are isomorphic.*

9 The isomorphism of \mathcal{EF} , \mathcal{EF}_H and *Gen*

We introduce now, by simplifying the definition of the category \mathcal{PF}_H of Section 5, a syntactically defined category \mathcal{EF}_H , for which we will show that it is isomorphic to the category \mathcal{EF} of the equivalential Frobenius monad freely generated by a single object (see Section 3). In \mathcal{EF}_H , which is just a syntactical variant of \mathcal{EF} , we will have a normal form analogous to the eta normal form of Section 7, which will enable us to prove the isomorphism of \mathcal{EF}_H and \mathcal{EF} with the subcategory *Gen* of *SplPre* (see the end of Section 2).

The objects of \mathcal{EF}_H are the finite ordinals, as for \mathcal{PF}_H . The arrow terms of \mathcal{EF}_H are defined as those of \mathcal{PF}_H , save that ${}_n H_m$ is replaced by ${}_n \bar{H}_m$, which is of the same type $n+2+m \rightarrow n+2+m$. The split equivalence of *Gen* corresponding to \bar{H} is given by:

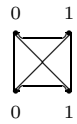

which we abbreviate by

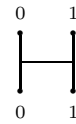

In \mathcal{PF}_H we can define ${}_n\bar{H}_m$ as ${}_n(H \circ \tau \circ H)_m$, which by (H *com*) is equal to ${}_n(\tau \circ H \circ \tau \circ H)_m$ and ${}_n(H \circ \tau \circ H \circ \tau)_m$, and by the definition in Section 7 to $(\bar{n}, \bar{n} + \bar{1})^{n+2+m}$.

The arrows of \mathcal{EF}_H are equivalence classes of arrow terms of \mathcal{EF}_H such that the equations \mathcal{EF}_H , which we are now going to define, are satisfied. We obtain these equations by starting with a list of axiomatic equations, which from $f = f$ up to (τi) coincides with the list of axiomatic equations of \mathcal{PF}_H in Section 5 (for (f) we replace H by \bar{H}); we take over from the previous list the axiomatic equation (0·0) too. The remaining axiomatic equations, which involve \bar{H} , are the following, with the pictures of the corresponding split equivalences of *Gen* on the right:

$$\begin{array}{ll}
(\bar{H} \text{ idemp}) & \bar{H} \circ \bar{H} = \bar{H} \qquad \begin{array}{c} | \\ \hline | \\ \hline | \end{array} = \begin{array}{c} | \\ \hline | \end{array} \\
(\bar{H} \text{ YB}) & {}_1\tau \circ \bar{H}_1 \circ {}_1\tau = \tau_1 \circ {}_1\bar{H} \circ \tau_1 \qquad \begin{array}{c} | \quad | \\ \diagdown \quad \diagup \\ | \quad | \\ \diagup \quad \diagdown \\ | \quad | \end{array} = \begin{array}{c} | \quad | \\ \diagup \quad \diagdown \\ | \quad | \\ \diagdown \quad \diagup \\ | \quad | \end{array} \\
(\bar{H} \text{ com}) & \tau \circ \bar{H} = \bar{H} = \bar{H} \circ \tau \qquad \begin{array}{c} | \\ \diagdown \quad \diagup \\ | \quad | \end{array} = \begin{array}{c} | \\ \hline | \end{array} = \begin{array}{c} | \quad | \\ \diagup \quad \diagdown \\ | \quad | \end{array} \\
(\bar{H} \text{ bond}) & i_1 \circ \bar{H} \circ !_1 = \mathbf{1}_1 \qquad \begin{array}{c} | \\ \hline | \\ | \end{array} = \begin{array}{c} | \end{array} \\
& \text{or, alternatively,} \\
& {}_1i \circ \bar{H} \circ {}_1! = \mathbf{1}_1 \qquad \begin{array}{c} | \\ | \quad | \\ \hline | \end{array} = \begin{array}{c} | \end{array} \\
(\bar{H}\bar{H}) & {}_1\bar{H} \circ \bar{H}_1 = \bar{H}_1 \circ {}_1\bar{H} \qquad \begin{array}{c} | \quad | \\ \hline | \quad | \\ \hline | \quad | \end{array} = \begin{array}{c} | \quad | \\ \hline | \quad | \end{array}
\end{array}$$

With this list of axiomatic equations we assume transitivity and symmetry of equality and the congruence rules of Section 5 to obtain all the equations of \mathcal{EF}_H .

In \mathcal{EF} of Section 3 we have the following definitions, with the picture for the right-hand side of the second definition on the right:

$${}_n\theta_m =_{df} M^n\theta_m, \quad \text{for } \theta \in \{\mathbf{1}, \nabla, \Delta, !, i, \tau\},$$

$${}_n\bar{H}_m =_{df} {}_n\Delta_m \circ {}_n\nabla_m$$

With these definitions, we derive straightforwardly in \mathcal{EF} the equations of \mathcal{EF}_H . As an example, we give with the following pictures the derivation of $(\bar{H} \text{ YB})$, which is slightly more involved:

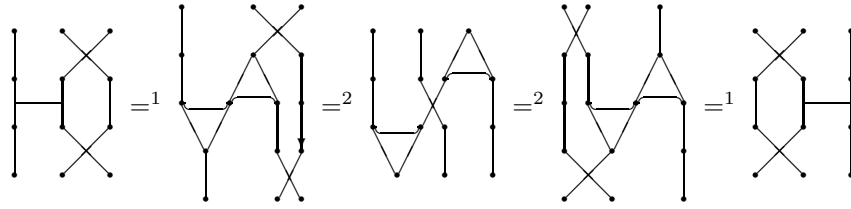

¹ by a Frobenius equation,

² by a symmetrization equation and the isomorphism of τ .

For the remaining axiomatic equations of \mathcal{EF}_H we have that all those at the beginning of the list, which are taken over from \mathcal{PF}_H , are immediate to establish. For $(\bar{H} \text{ idemp})$ we use the separability equation, for $(\bar{H} \text{ com})$ we use the commutativity equations, for $(\bar{H} \text{ bond})$ we use monadic and comonadic equations, and for $(\bar{H}\bar{H})$ we use the Frobenius equations and monadic and comonadic equations. Closure under transitivity and symmetry of equality, and under the congruence rules of \mathcal{EF}_H , is established immediately for \mathcal{EF} , and hence all the equations of \mathcal{EF}_H hold in \mathcal{EF} .

To obtain in \mathcal{EF}_H the structure of an equivalential Frobenius monad, i.e. the structure of \mathcal{EF} , we have the following definitions in \mathcal{EF}_H , with the corresponding pictures on the right:

$$\nabla =_{df} i_1 \circ \bar{H}$$

$$\Delta =_{df} \bar{H} \circ !_1$$

while Mn and Mf are defined as in \mathcal{PF}_H . By using monadic and comonadic equations, we obtain easily in \mathcal{EF} the equations

$$\nabla = i_1 \circ \Delta \circ \nabla, \quad \Delta = \Delta \circ \nabla \circ !_1,$$

which are obtained from the definitions we have just given by defining the right-hand sides in \mathcal{EF} .

To define the eta normal form for the arrow terms of \mathcal{EF}_H we proceed quite analogously to what we had in Section 7. What we need now are the overlined eta arrows $\overline{(i, j)^{n+2}}$, which are defined in \mathcal{EF}_H as $(i, j)^{n+2}$ in Section 7 with H replaced by \bar{H} . The split equivalences of Gen corresponding to these new overlined eta arrows are the split equivalences corresponding to the overlined eta arrows defined in \mathcal{PF}_H in Section 7. The arrows $\overline{(i, j)^{n+2}}$ and $\overline{(j, i)^{n+2}}$ were equal in \mathcal{PF}_H , and they are equal in \mathcal{EF}_H too.

We can derive in \mathcal{EF}_H the equations $(H \text{ def})$, $(\tau \text{ def})$, $(\eta !)$, (ηi) , $(\eta \text{ idemp})$, $(\eta \text{ perm})$, $(\eta k \cdot l)$, $(\eta k \cdot 0)$, $(\eta 0 \cdot l)$ and (ηTr) with the old eta arrows replaced by the new overlined eta arrows. Note that in \mathcal{EF}_H we have the derivation corresponding to the following pictures:

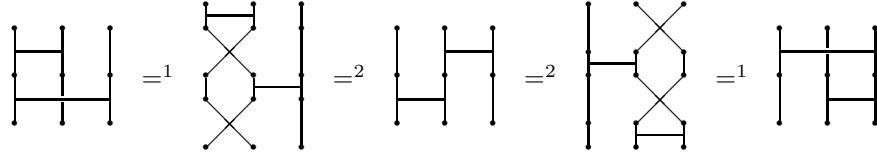

- ¹ by definition,
- ² by $(\bar{H} \text{ com})$ and $(\bar{H}\bar{H})$.

The derivation corresponding to the following pictures is analogous:

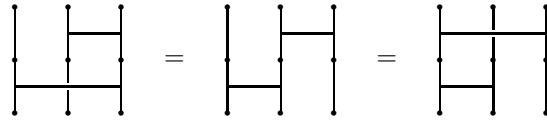

The equations obtained by these derivations enable us to get in \mathcal{EF}_H the effect of the equations $(H 2 \cdot 0)$, $(H 0 \cdot 2)$ and $(H 2 \cdot 2)$ with $(\bar{H} \text{ bond})$ alone. With the help of $(\bar{H} \text{ idemp})$, we then obtain easily the equation corresponding to the following picture:

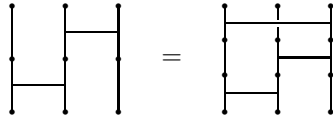

which we need for $(\eta \text{ Tr})$ with the old eta arrows replaced by the new overlined ones.

The remainder of the proof of the isomorphism of \mathcal{EF}_H with the categories Gen and \mathcal{EF} is then quite analogous to what we had in Sections 7 and 8. The functor G from \mathcal{EF}_H to Gen , for which we show that it is an isomorphism, amounts to a restriction of the functor G from \mathcal{PF}_H to $SplPre$.

To obtain the bijection in the analogue of the Key Lemma we take that $G_s f$ is the set $\{\{x, y\} \mid (x, y) \in Gf \& x \neq y\}$. This set of unordered pairs is what we draw when we replace $\uparrow\downarrow$ by $|$. It is obtained from the split strict equivalence relation corresponding to the split equivalence Gf (see Section 1). It is determined uniquely by Gf , and it determines Gf uniquely, provided the type of f is given.

So we have the following.

THEOREM. *The categories \mathcal{EF} , \mathcal{EF}_H and Gen are isomorphic.*

10 Remark on Jones monads

Let a *Jones monad* be a Frobenius monad that satisfies the separability equation $\nabla \circ \Delta = \mathbf{1}_M$ and the unit-counit homomorphism equation $(0 \cdot 0)$, i.e. $i \circ ! = \mathbf{1}$. So the difference with equivalential Frobenius monads is that here symmetry is missing. The name of Jones monads is derived from the connection of these monads with the monoid \mathcal{J}_ω of [5] (named with the initial of Jones' name); this monoid is closely related to monoids introduced in [12] (p. 13), which are called Jones monoids in [15] (as suggested by [5]).

It can be shown that the category \mathcal{J} of the Jones monad freely generated by a single object is isomorphic to a subcategory of Gen . The arrows of this subcategory are split equivalences between finite ordinals that are nonintersecting in the sense of [10] (Section 6). This isomorphism is demonstrated via a normal form $f_2 \circ f_1$ where all the occurrences of ∇ and i are in f_1 , and all the occurrences of Δ and $!$ are in f_2 . (This is analogous to the proof of $S5_{\square, \diamond}$ Coherence in [9], Section 6.)

Instead of proceeding via \mathcal{EF}_H , one could rely on an analogous normal form $f_2 \circ g \circ f_1$ to prove that the category \mathcal{EF} of Section 3 is isomorphic to Gen . In this normal form, instead of ∇ and Δ , we have their generalizations, to which the following pictures correspond:

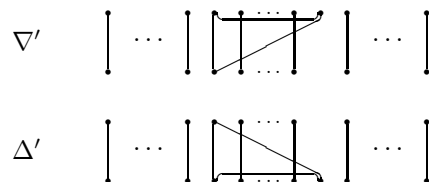

All the occurrences of ∇' and \mathfrak{i} are in f_1 , all the occurrences of Δ' and $!$ are in f_2 , and all the occurrences of τ are in g .

11 The category \mathcal{RB}_I

In this and in the next four sections we deal with the category *Rel*. We introduce first in this section a syntactically defined category \mathcal{RB}_I , which is a syntactical variant of the category \mathcal{RB} of the relational bialgebraic monad freely generated by a single object (see Section 4), and for which we will show that it is isomorphic to \mathcal{RB} . We will introduce in Section 13 a normal form for the arrow terms of \mathcal{RB}_I , which will enable us to prove in Section 14 the isomorphism of \mathcal{RB}_I and \mathcal{RB} with the category *Rel*. The category \mathcal{RB}_I is analogous up to a point to \mathcal{PF}_H and \mathcal{EF}_H , but its general inspiration is rather different.

The objects of \mathcal{RB}_I are the finite ordinals. The arrow terms of \mathcal{RB}_I are defined inductively as follows. For $n, m, k \geq 0$, the primitive arrow terms of \mathcal{RB}_I are

$$\begin{aligned} {}_n\mathbf{1}_m &: n+m \rightarrow n+m, \\ {}_n\nabla_m^k &: n+2k+m \rightarrow n+k+m, & {}_n\Delta_m^k &: n+k+m \rightarrow n+2k+m, \\ {}_n!_m^k &: n+m \rightarrow n+k+m, & {}_n\mathfrak{i}_m^k &: n+k+m \rightarrow n+m. \end{aligned}$$

The remaining arrow terms of \mathcal{RB}_I are defined with the same inductive clause we had for the arrow terms of \mathcal{PF}_H in Section 5 (closure under composition). For an arbitrary arrow term h of \mathcal{RB}_I , the notation ${}_nh_m$, introduced for \mathcal{PF}_H in Section 5, is transposed to \mathcal{RB}_I with the same clause for ${}_n({}_k\theta_l)_m$, where $\theta \in \{\mathbf{1}, \nabla^k, \Delta^k, !^k, \mathfrak{i}^k\}$, and the same clause for ${}_n(g \circ f)_m$.

To understand the equations of \mathcal{RB}_I it helps to have in mind the relations of *Rel* that correspond to the primitive arrow terms of \mathcal{RB}_I . For ${}_n\mathbf{1}_m$ we have the same picture we had in Section 5, while for the rest we have:

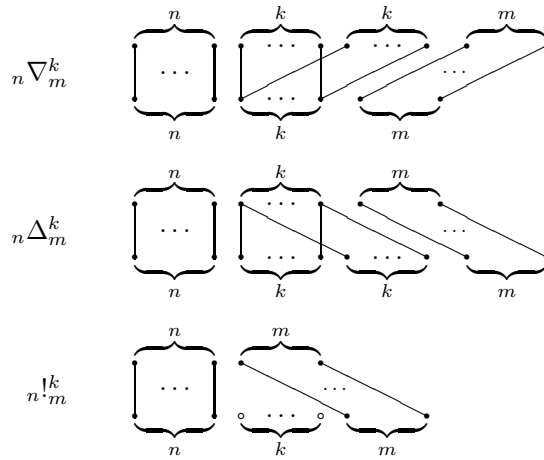

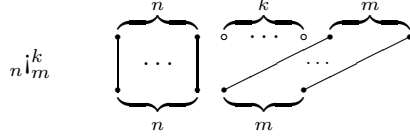

The pictures for $n!_m^1$ and $n!_m^1$ are the same as the pictures for $n!_m$ and $n!_m$ respectively in Section 5. The pictures for $n\nabla_m^0$, $n\Delta_m^0$, $n!_m^0$ and $n!_m^0$ are the same as the pictures for $n\mathbf{1}_m$. We interpret the pictures we have just given as standing for binary relations whose domain is at the top and the codomain at the bottom. Every line \downarrow joining the top with the bottom should be read as \downarrow .

The arrows of \mathcal{RB}_I will be equivalence classes of arrow terms of \mathcal{RB}_I such that the equations of \mathcal{RB}_I , which we are now going to define, are satisfied. For most of the axiomatic equations of \mathcal{RB}_I , we will give on the right the pictures of the corresponding relations of Rel . First, for every arrow term $f: n \rightarrow m$ of \mathcal{RB}_I , we have the axiomatic equations $f = f$, $(cat\ 1)$, $(fun\ 1)$ and (fl) for $\xi, \theta \in \{\nabla^k, \Delta^k, !^k, i^k\}$ (see Section 5); next, with $+$ defined as in Section 5, we have the axiomatic equations:

($\nabla\ nat$) $f \circ \nabla^n = \nabla^m \circ (f + f)$ =

($\Delta\ nat$) $\Delta^m \circ f = (f + f) \circ \Delta^n$, with the picture for ($\nabla\ nat$) turned upside down,

($!\ nat$) $f \circ !^n = !^m$ =

($i\ nat$) $i^m \circ f = i^n$, with the picture for ($!\ nat$) turned upside down,

($\nabla! 1$) $\nabla^k \circ_k !^k = \mathbf{1}_k$ =

($\nabla! 2$) $\nabla^k \circ !_k^k = \mathbf{1}_k$ =

$$(\nabla! 12) \quad \nabla^{k+l} \circ ({}_k!^l + !_l^k) = \mathbf{1}_{k+l}$$

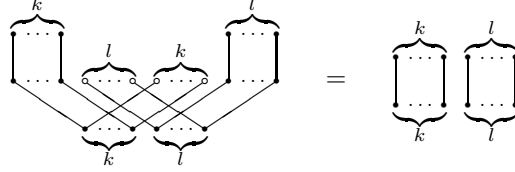

$$(\Delta i 1) \quad {}_k i^k \circ \Delta^k = \mathbf{1}_k,$$

$$(\Delta i 2) \quad !_k^k \circ \Delta^k = \mathbf{1}_k,$$

$$(\Delta i 12) \quad ({}_k i^l + !_l^k) \circ \Delta^{k+l} = \mathbf{1}_{k+l},$$

$$(0) \quad !^0 = i^0 = \mathbf{1},$$

with the pictures for $(\Delta i 1)$, $(\Delta i 2)$ and $(\Delta i 12)$ being those of the preceding three equations turned upside down.

These equations state that $+$ in \mathcal{RB}_I is a biproduct, i.e. a product and a coproduct, and that 0 is a null object, i.e. both initial and terminal. Hence we have that $\nabla^0 = \Delta^0 = \mathbf{1}$. Finally, we have the axiomatic equation

$$(\nabla\Delta) \quad \nabla^k \circ \Delta^k = \mathbf{1}_k.$$

This concludes the list of the axiomatic equations of \mathcal{RB}_I . To obtain all the equations of \mathcal{RB}_I we assume that they are closed under symmetry and transitivity of equality and under the congruence rules given for \mathcal{PF}_H in Section 5. As for \mathcal{PF}_H and \mathcal{EF}_H , it is automatically guaranteed by our notation that composition \circ is associative in \mathcal{RB}_I .

The category \mathcal{RB}_I is a category with finite biproducts strictified in its monoidal structure (i.e., the associativity isomorphisms for the biproduct and the isomorphisms involving the biproduct and the null object are identity arrows). We have moreover the *generalized bialgebraic separability* equation $(\nabla\Delta)$.

12 Derivation of \mathcal{RB}_I

In this section we show that, with appropriate definitions of the arrows of \mathcal{RB}_I , we have in the category \mathcal{RB} of Section 4 all the equations of \mathcal{RB}_I . To obtain the structure of \mathcal{RB}_I in \mathcal{RB} we have the following definitions, accompanied on the right in important cases by pictures of the corresponding binary relations:

$${}_n \theta_m =_{df} (M^\downarrow)^n \theta_m, \quad \text{for } \theta \in \{\mathbf{1}, \nabla^\downarrow, \Delta^\downarrow, !, i, \tau\},$$

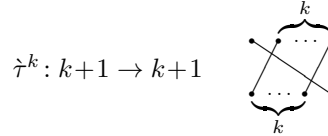
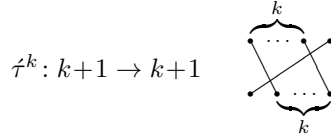

$$\begin{aligned} \hat{\tau}^0 &= \mathbf{1}_1, & \hat{\tau}^{k+1} &= \tau_k \circ_1 \hat{\tau}^k \end{aligned} \quad \begin{array}{c} \text{--- } k \text{ ---} \\ \text{--- } \dots \text{ ---} \\ \text{--- } \dots \text{ ---} \\ \text{--- } \dots \text{ ---} \end{array} \quad \begin{aligned} \hat{\gamma}^0 &= \mathbf{1}_1, & \hat{\gamma}^{k+1} &= {}_k\tau \circ \hat{\gamma}_1^k \end{aligned} \quad \begin{array}{c} \text{--- } k \text{ ---} \\ \text{--- } \dots \text{ ---} \\ \text{--- } \dots \text{ ---} \\ \text{--- } \dots \text{ ---} \end{array}$$

We can prove by induction on the complexity of $f: n \rightarrow m$ that the following equations hold in \mathcal{RB} :

$$(\hat{\tau} \text{ nat}) \quad {}_1f \circ \hat{\tau}^n = \hat{\tau}^m \circ {}_1f, \quad (\hat{\gamma} \text{ nat}) \quad f_1 \circ \hat{\gamma}^n = \hat{\gamma}^m \circ {}_1f.$$

Then we have the following definitions in \mathcal{RB} :

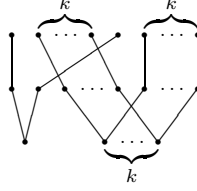
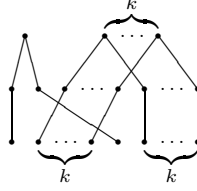
$$\begin{aligned} \nabla^0 &= \mathbf{1}_0, & \Delta^0 &= \mathbf{1}_0, \\ \nabla^{k+1} &= (\nabla^\downarrow + \nabla^k) \circ_1 \hat{\tau}_k^k, & \Delta^{k+1} &= {}_1\hat{\tau}_k^k \circ (\Delta^\downarrow + \Delta^k) \end{aligned}$$

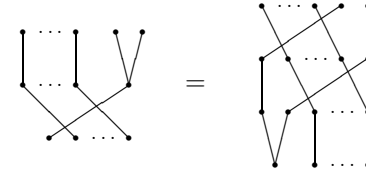

We can then prove that the equations $(\nabla \text{ nat})$ and $(\Delta \text{ nat})$ of the preceding section hold in \mathcal{RB} by induction on the complexity of f . In the course of this induction we use auxiliary equations like the following, which are established by induction on m :

$${}_{\tau^m} \circ_m \nabla^\downarrow = \nabla_m^\downarrow \circ_1 \hat{\tau}^m \circ \hat{\tau}_1^m$$

For $!^k$ and i^k defined in \mathcal{RB} as in Section 7, we can prove that the equations $(! \text{ nat})$ and $(i \text{ nat})$ hold in \mathcal{RB} by induction on the complexity of f . It is established immediately that the axiomatic equations $(cat 1)$, $(fun 1)$ and (fl) hold in \mathcal{RB} , and we have dealt with $(\nabla \text{ nat})$, $(\Delta \text{ nat})$, $(! \text{ nat})$ and $(i \text{ nat})$ above. We establish that the remaining axiomatic equations of \mathcal{RB}_I hold in \mathcal{RB} by induction on k , except for (0) , which is established by definition. Closure under the congruence rules is established immediately, and hence all the equations of \mathcal{RB}_I hold in \mathcal{RB} .

To obtain in \mathcal{RB}_1 the structure of a relational bialgebraic monad, i.e. the structure of \mathcal{RB} , we have the definitions

$$\begin{aligned}
M^\downarrow n &=_{df} n+1, & M^\downarrow f &=_{df} \mathbf{1}f, \\
\nabla^\downarrow &=_{df} \nabla^1, & \Delta^\downarrow &=_{df} \Delta^1, \\
! &=_{df} !^1, & i &=_{df} i^1, \\
\tau &=_{df} \nabla^2 \circ (!^1_1 + \mathbf{1}!), & & \text{with the picture } \begin{array}{c} \circ \quad \downarrow \quad \downarrow \quad \circ \\ \diagdown \quad \diagup \end{array}
\end{aligned}$$

(there is a dual definition of τ in terms of Δ^2 and i^1). It is easy to establish that in \mathcal{RB} we have the equations obtained from these definitions by defining the right-hand sides in \mathcal{RB} .

We will not derive in \mathcal{RB}_1 the equations of \mathcal{RB} . That these equations hold in \mathcal{RB}_1 will be easy to establish once we have proved the isomorphism of \mathcal{RB}_1 with *Rel*.

13 Iota normal form

We introduce in this section a normal form for the arrow terms of \mathcal{RB}_1 , which we use in the next section to prove the isomorphism of \mathcal{RB}_1 with the category *Rel*. We call it *iota normal form*, because it is a union of arrow terms we will call *iota terms*. We will define union and *iota terms* in a moment. The binary relations corresponding to arrows of \mathcal{RB}_1 designated by *iota terms* are given by a single ordered pair (see the next section for an example).

We have first the following definition in \mathcal{RB}_1 , accompanied by a picture of the corresponding relation, of the *union* of the arrow terms $f, g: n \rightarrow m$ of \mathcal{RB}_1 :

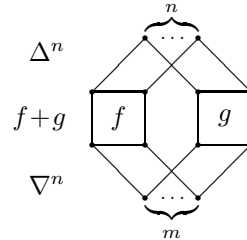
$$f \cup g =_{df} \nabla^m \circ (f+g) \circ \Delta^n$$

We can then derive in \mathcal{RB}_1 that for \cup we have associativity, commutativity and idempotence, and that the *zero terms* $0^{n,m}: n \rightarrow m$, defined by $!^m \circ i^n$, as in Section 7, can be omitted in unions:

$$f \cup 0^{n,m} = f.$$

We say that zero terms are *empty unions*.

We have in \mathcal{RB}_1 that \circ *distributes over unions*, possibly empty, on the left and on the right:

$$\begin{aligned}
f \circ (g \cup h) &= (f \circ g) \cup (f \circ h), & (g \cup h) \circ f &= (g \circ f) \cup (h \circ f), \\
f \circ 0^{k,n} &= 0^{k,m}, & 0^{m,k} \circ f &= 0^{n,k}.
\end{aligned}$$

Note that $0^{n,m}$ exists not only in \mathcal{RB}_I and \mathcal{RB} , but also in \mathcal{EF} and \mathcal{PF} , but there, since 0 is not a null object, $0^{n,m}$ is not a zero arrow, which it is in \mathcal{RB}_I .

Next, we have in \mathcal{RB}_I the following definition of *iota terms*, accompanied by a picture of the corresponding relation, for $0 \leq i < n$ and $0 \leq j < m$:

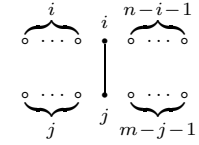
$$\binom{i}{j}^{n,m} =_{df} 0^{i,j} + \mathbf{1}_1 + 0^{n-i-1, m-j-1}: n \rightarrow m$$

We are now going to establish the equations of \mathcal{RB}_I that we need for reduction to iota normal form.

The following equations hold in \mathcal{RB}_I , as a simple consequence of $(\nabla! 12)$ and $(\Delta i 12)$:

$$\nabla^k = {}_k!^k \cup {}_k!^k, \quad \Delta^k = {}_k!^k \cup {}_k!^k.$$

The following equations too hold in \mathcal{RB}_I :

$${}_1(f \cup g) = {}_1f \cup {}_1g, \quad (f \cup g)_1 = f_1 \cup g_1.$$

For the first equation we show that

$${}_1(f \cup g) \circ {}_1!^k = ({}_1f \cup {}_1g) \circ {}_1!^k, \quad {}_1(f \cup g) \circ {}_1!^k = ({}_1f \cup {}_1g) \circ {}_1!^k,$$

and then we use $\nabla^l \circ ((h \circ {}_1!^k) + (h \circ {}_1!^k)) = h$; for the second equation we proceed analogously. All these equations enable us to obtain in \mathcal{RB}_I :

$$(\nabla \Delta \text{ def}) \quad {}_n\nabla_m^k = {}_{n+k}!_m^k \cup {}_n!_{k+m}^k, \quad {}_n\Delta_m^k = {}_{n+k}!_m^k \cup {}_n!_{k+m}^k.$$

Next we have the following equations in \mathcal{RB}_I , for $n+m \geq 1$:

$$\begin{aligned}
(i! \text{ def}) \quad {}_n!_m^k &= \bigcup_{0 \leq i \leq n-1} \binom{i}{i}^{n+m, n+k+m} \cup \bigcup_{n \leq i \leq n+m-1} \binom{i}{i+k}^{n+m, n+k+m}, \\
{}_n!_m^k &= \bigcup_{0 \leq i \leq n-1} \binom{i}{i}^{n+k+m, n+m} \cup \bigcup_{n \leq i \leq n+m-1} \binom{i+k}{i}^{n+k+m, n+m}, \\
!^k &= 0^{0,k}, \quad !^k = 0^{k,0}, \\
(\mathbf{1} \text{ def}) \quad {}_n\mathbf{1}_m &= \bigcup_{0 \leq i \leq n+m-1} \binom{i}{i}^{n+m, n+m}, \quad \mathbf{1} = 0^{0,0}.
\end{aligned}$$

For their derivation we use essentially $(\nabla! 12)$ and $(\Delta i 12)$, which for $f: n \rightarrow m$ and $g: k \rightarrow l$ delivers:

$$f + g = (f + 0^{k,l}) \cup (0^{n,m} + g);$$

for the equations involving zero terms we use (0) and (*cat 1*). We may now describe the reduction to iota normal form.

Every arrow term f of \mathcal{RB}_1 is a composition $f_u \circ \dots \circ f_1$ of primitive arrow terms. If $u > 1$, we use first (*cat 1*) to delete superfluous factors of the form ${}_n\mathbf{1}_m$; if $u = 1$ and f is ${}_n\mathbf{1}_m$, then we apply (*1 def*). In other cases, we apply ($\nabla\Delta$ *def*) and (*!i def*), in that order, and the distributivity of \circ over unions. In any case, we obtain a union f' (possibly empty) of compositions of iota terms such that f' is equal to f in \mathcal{RB}_1 .

Then we use the following equations of \mathcal{RB}_1 :

$$\binom{k}{l}^{q,r} \circ \binom{n}{m}^{p,q} = \begin{cases} \binom{n}{l}^{p,r} & \text{if } m = k, \\ 0^{p,r} & \text{if } m \neq k, \end{cases}$$

$$\binom{k}{l}^{q,r} \circ 0^{p,q} = 0^{q,r} \circ \binom{n}{m}^{p,q} = 0^{q,r} \circ 0^{p,q} = 0^{p,r},$$

together with the associativity, commutativity and idempotence of \cup , and the omitting of zero terms in unions, in order to obtain a union f'' (possibly empty) of iota terms without repetitions such that f'' is equal to f in \mathcal{RB}_1 .

This arrow term f'' is a *iota normal form* of f . The set of iota terms of f'' is empty when f'' is an empty union, i.e. a zero term. An example of iota normal form is given in the next section. We may call f'' a *iota union*, by analogy with eta composition in Section 7.

A iota normal form would be made more specific by choosing a particular order for its iota terms, and a specific association of parentheses for unions. These choices are however arbitrary, and we need not make them for our purposes.

With reduction to iota normal form we have as a matter of fact yet another alternative syntactic formulation of the category \mathcal{RB} , for which \mathcal{RB}_1 is just a bridge. Applying our equations with *def* in the reduction procedure introduces us into this alternative language. The primitive arrow terms in this formulation would be iota terms and zero terms, with perhaps ${}_n\mathbf{1}_m$ added; arrow terms would be closed under union and composition, and the appropriate axiomatic equations can be gathered from the reduction procedure.

Iota normal forms are not unique as arrow terms, but after we have proved the Key Lemma in the next section we will be able to ascertain that if f'' and g'' are iota normal forms of the same arrow of \mathcal{RB}_1 , then the sets of iota terms of f'' and g'' are equal.

For the time being, we can assert that if for the iota normal forms f'' and g'' of the arrow terms f and g of \mathcal{RB}_1 of the same type the sets of iota terms of f'' and g'' are equal, then $f'' = g''$, and hence also $f = g$, in \mathcal{RB}_1 . For that we use the associativity and commutativity of \cup .

Another syntactical description of *Rel*, obtained from [6] (Chapter 13), is that it is a zero-mix dicartesian category with \wedge and \vee equal to $+$, the objects \top and \perp equal to 0 , where moreover the monoidal structure of $+$ and 0 is strictified, and mix arrows are identity arrows. The category *Rel* is the free category of

that kind generated by a single object. A normal form that is practically the same as the iota normal form may be found in [6] (Chapter 13).

14 The isomorphism of \mathcal{RB} , \mathcal{RB}_I and Rel

Let the functor G from \mathcal{RB}_I to Rel be identity on objects. To define it on arrows, let it assign to the arrow terms of \mathcal{RB}_I the binary relations between finite ordinals corresponding to the pictures we have given in Section 11. Formally, G is defined by induction on the complexity of the arrow term. This means that $G\mathbf{1}_n$ is the identity relation on n and $G(g \circ f)$ is the composition of the binary relations Gf and Gg . We verify easily by induction on the length of derivation of an equation of \mathcal{RB}_I that G is indeed a functor.

We will now prove the following.

PROPOSITION. *The functor G from \mathcal{RB}_I to Rel is an isomorphism.*

To prove this proposition, we establish first that G is onto on arrows. This is done by representing every arrow of Rel in a form corresponding to the iota normal form of the preceding section. For example, the relations given by the following two pictures are equal:

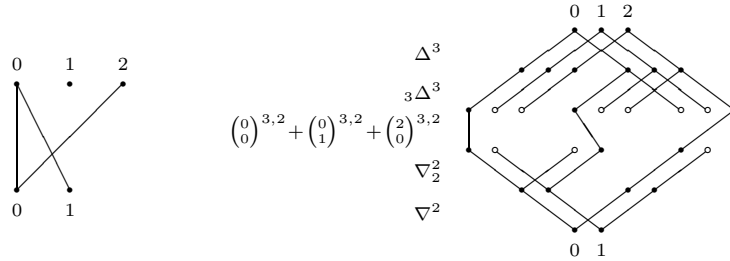

An analogous form could be used for split preorders. In the zones corresponding to ${}_3\Delta^3 \circ \Delta^3$ and $\nabla^2 \circ \nabla_2^2$ we would have Δ and ∇ instead of Δ^\downarrow and ∇^\downarrow , and in the middle zone corresponding to $\binom{0}{0}^{3,2} + \binom{0}{1}^{3,2} + \binom{2}{0}^{3,2}$ we would have also cups \cup and caps \cap (which correspond respectively to $\downarrow \circ \nabla$ and $\Delta \circ !$), together with \downarrow and \uparrow (which is defined in Section 3). The top and bottom layers of this middle zone would contain \downarrow and \uparrow .

For an arrow term $f: n \rightarrow m$ of \mathcal{RB}_I , let B be the set of iota terms of a iota normal form of f (see the preceding section). It is straightforward to establish the following.

KEY LEMMA. *There is a bijection $\beta: Gf \rightarrow B$ such that*

$$\beta(k, l) = \binom{k}{l}^{n,m}.$$

This lemma is illustrated by the example given in the picture above, where the right-hand side corresponds to the iota normal form

$$\begin{pmatrix} 0 \\ 0 \end{pmatrix}^{3,2} \cup \begin{pmatrix} 0 \\ 1 \end{pmatrix}^{3,2} \cup \begin{pmatrix} 2 \\ 0 \end{pmatrix}^{3,2}.$$

We are now ready to prove that G is one-one on arrows. For f and g arrow terms of \mathcal{RB}_I of the same type, let f'' and g'' be iota normal forms of f and g , and let B and C be the sets of iota terms of f'' and g'' . If $Gf = Gg$, then the bijection of the Key Lemma establishes that $B = C$. Hence, as we have remarked at the end of the preceding section, $f = g$ in \mathcal{RB}_I . With this our Proposition is proved.

With the help of this Proposition we can ascertain that \mathcal{RB}_I is isomorphic to the category \mathcal{RB} of the relational bialgebraic monad freely generated by a single object (see Section 4). We have derived already in Section 12 all the equations of \mathcal{RB}_I in \mathcal{RB} . It remains to verify that all the equations of \mathcal{RB} hold in \mathcal{RB}_I , with M^\downarrow , ∇^\downarrow , Δ^\downarrow , $!$, i and τ defined as in Section 12. We have to verify also that the equations derived from the definitions in \mathcal{RB} at the beginning of Section 12 hold in \mathcal{RB}_I when ∇^\downarrow , Δ^\downarrow , $!$, i and τ on the right-hand sides are defined in \mathcal{RB}_I . Because of the number of these definitions, and because of their inductive nature, this would be quite demanding if we had to make all the derivations in \mathcal{RB}_I . But thanks to the isomorphism of \mathcal{RB}_I with Rel , established by our Proposition, all this becomes an easy task. It is enough to verify that the relations of Rel corresponding to the two side of an equation are the same. So we have the following.

THEOREM. *The categories \mathcal{RB} , \mathcal{RB}_I and Rel are isomorphic.*

15 *Rel* in *SplPre*

We will now explain and name the exact relationship between *Rel* and *SplPre*. A *semi-functor* F from a category \mathcal{A} to a category \mathcal{B} is defined like a functor save that $F\mathbf{1}_a$ need not be $\mathbf{1}_{Fa}$ (see [11] and references therein). If the objects and arrows of \mathcal{A} are included respectively among the objects and arrows of \mathcal{B} , then we say that \mathcal{A} is a *semi-subcategory* of \mathcal{B} if there is a semi-functor from \mathcal{A} to \mathcal{B} , called the *inclusion semi-functor*, which sends each object and each arrow of \mathcal{A} to itself. If “semi-functor” in this definition is replaced by “functor” we obtain the standard notion of subcategory.

The category *Rel* is isomorphic to a semi-subcategory of *SplPre*. The semi-functor S from *Rel* to *SplPre*, which amounts to the inclusion semi-functor, is defined as follows via \mathcal{RB} and \mathcal{PF} . We have:

$$\begin{aligned} Sn &= n, & S\mathbf{1} &= \mathbf{1}, \\ S\nabla^\downarrow &= \nabla^\downarrow, & S\Delta^\downarrow &= \Delta^\downarrow, \end{aligned}$$

where ∇^\downarrow and Δ^\downarrow on the right-hand sides are those that are defined in \mathcal{PF} (see Section 3),

$$S! = !, \quad Si = i,$$

for $f: n \rightarrow m$,

$$SM^\downarrow f = MSf \circ \downarrow_n = \downarrow_m \circ MSf, \quad S(g \circ f) = Sg \circ Sf.$$

So $S\mathbf{1}_a = \downarrow$, and since \downarrow is not an identity arrow in $SplPre$, but only an idempotent, S is not a functor, but only a semi-functor.

In \mathcal{PF} we may define a semi-endofunctor M^\downarrow by stipulating that

$$M_n^\downarrow =_{df} n+1, \quad \text{and, for } f: n \rightarrow m, \quad M^\downarrow f =_{df} Mf \circ \downarrow_n = \downarrow_m \circ Mf.$$

The \downarrow -idempotence equation delivers that $M^\downarrow(g \circ f) = M^\downarrow g \circ M^\downarrow f$, and the equations (2·1), (1·2), (0·1) and (1·0), derived at the end of Section 3, deliver the monadic equations for ∇^\downarrow and $!$, and the comonadic equations for Δ^\downarrow and i . We cannot however say that $\langle \mathcal{PF}, M^\downarrow, \nabla^\downarrow, ! \rangle$ is a monad, since M^\downarrow is not a functor, but only a semi-functor: $M^\downarrow \mathbf{1}$ is \downarrow . The semi-endofunctor M^\downarrow restricted to the semi-subcategory of \mathcal{PF} isomorphic to \mathcal{RB} amounts to the endofunctor M^\downarrow of \mathcal{RB} , and $\langle \mathcal{RB}, M^\downarrow, \nabla^\downarrow, ! \rangle$ is a monad; the same holds for the comonad structure of Δ^\downarrow and i .

For the subcategory Fun of Rel , whose arrows are the functions between finite ordinals, we have two possibilities. We may either take it as isomorphic to a semi-subcategory of $SplPre$, by proceeding as for Rel , or we may take Fun as isomorphic to an ordinary subcategory of Gen , and hence of $SplPre$, as indicated at the end of Section 2.

16 The maximality of \mathcal{PF} , \mathcal{EF} and \mathcal{RB}

We conclude the paper by proving for the categories \mathcal{PF} , \mathcal{EF} and \mathcal{RB} an interesting property via their isomorphism with the categories $SplPre$, Gen and Rel . We call this property *maximality* (see [6], Section 9.3, for a general discussion of maximality).

Let \mathcal{S} be one of the categories \mathcal{PF} , \mathcal{EF} and \mathcal{RB} . If for v and w arrow terms of \mathcal{S} of the same type we add to the definition of \mathcal{S} a new axiomatic equation $v = w$, then we obtain a category $\mathcal{S} + \{v = w\}$. Except for the new axiomatic equation, $\mathcal{S} + \{v = w\}$ is defined in the same manner as \mathcal{S} . We assume that the equations of $\mathcal{S} + \{v = w\}$, including the new equation $v = w$, are closed under the congruence rules we have assumed for \mathcal{S}_H (see Section 5). Closure under “if $f = g$, then $_n f = _n g$ ” is guaranteed by the functoriality of M or M^\downarrow , while closure under “if $f = g$, then $f_m = g_m$ ” is guaranteed if we take the equations of $\mathcal{S} + \{v = w\}$, including the new equation $v = w$, to be equations between natural transformations, as in Sections 3 and 4.

A category is a preorder when there is at most one arrow with a given source and target. Note that neither of the categories \mathcal{PF} , \mathcal{EF} and \mathcal{RB} is a preorder. This is clear from their isomorphism with $SplPre$, Gen and Rel . We have however the following.

MAXIMALITY FOR \mathcal{S} . *If $v = w$ does not hold in \mathcal{S} , then $\mathcal{S} + \{v = w\}$ is a preorder.*

In the remainder of this section, and of the whole paper, we prove this proposition. We do it first for \mathcal{RB} , and then for \mathcal{EF} and \mathcal{PF} .

PROOF OF MAXIMALITY FOR \mathcal{RB} . We show first that if for $v, w: n \rightarrow m$ arrow terms of \mathcal{RB} we do not have $v = w$ in \mathcal{RB} , then in $\mathcal{RB} + \{v = w\}$ we have the equation

$$\mathbf{1}_1 = 0^{1,1} = ! \circ i.$$

Suppose $v = w$ does not hold in \mathcal{RB} . By the isomorphism of \mathcal{RB} with Rel , we have that the binary relations Gv and Gw are different. So $n, m > 0$, since otherwise $Gv = Gw = \emptyset$. Suppose $(i, j) \in Gv$ and $(i, j) \notin Gw$. Then for the following arrows of \mathcal{RB} , with the pictures of the corresponding relations on the right:

$$\begin{array}{l}
 h^s =_{df} !^i + \mathbf{1}_1 + !^{n-i-1}: 1 \rightarrow n \\
 \\
 h^t =_{df} !^j + \mathbf{1}_1 + !^{m-j-1}: m \rightarrow 1
 \end{array}
 \qquad
 \begin{array}{c}
 0 \\
 \downarrow \\
 \underbrace{\circ \dots \circ}_i \quad \underbrace{\circ \dots \circ}_{n-i-1} \\
 \underbrace{\circ \dots \circ}_j \quad \underbrace{\circ \dots \circ}_{m-j-1} \\
 \downarrow \\
 0
 \end{array}$$

in $\mathcal{RB} + \{v = w\}$ we obtain

$$h^t \circ v \circ h^s = h^t \circ w \circ h^s,$$

from which, by the isomorphism of \mathcal{RB} with Rel , in $\mathcal{RB} + \{v = w\}$ we obtain $\mathbf{1}_1 = 0^{1,1}$.

If $\mathbf{1}_1 = 0^{1,1}$ holds in $\mathcal{RB} + \{v = w\}$, then it is easy to conclude that in $\mathcal{RB} + \{v = w\}$ we have also $\mathbf{1}_k = 0^{k,k}$ for every $k \geq 0$ (we have already $\mathbf{1}_0 = 0^{0,0}$ in \mathcal{RB}). The arrows $0^{k,l}$ are zero arrows in \mathcal{RB} , and so, for every arrow term $f: k \rightarrow l$ of \mathcal{RB} , in \mathcal{RB} , and hence also in $\mathcal{RB} + \{v = w\}$, we have $f \circ 0^{k,k} = 0^{k,l}$ and $0^{l,l} \circ f = 0^{k,l}$. With either of these equations, we obtain $f = g$ in $\mathcal{RB} + \{v = w\}$ for all arrow terms f and g of \mathcal{RB} of the same type. \dashv

PROOF OF MAXIMALITY FOR \mathcal{EF} . Note first that if either of the following two equations holds in $\mathcal{EF} + \{v = w\}$

$$(\nabla i) \quad i \circ \nabla = i \circ i, \quad (\Delta!) \quad \Delta \circ ! = !_1 \circ !,$$

then $\mathbf{1}_1 = 0^{1,1}$ holds in $\mathcal{EF} + \{v = w\}$. (When we add the superscript \downarrow to ∇ and Δ , the equations (∇i) and $(\Delta!)$ become the *mch* equations (2.0) and (0.2) of Section 3, which hold in \mathcal{PF} .) For the equation (∇i) we have the picture on the left, which yields the picture on the right:

and from the equation corresponding to the picture on the right we obtain $\mathbf{1}_1 = 0^{1,1}$. We proceed analogously with $(\Delta!)$.

We show next that if for $v, w: n \rightarrow m$ arrow terms of \mathcal{EF} we do not have $v = w$ in \mathcal{EF} , then in $\mathcal{EF} + \{v = w\}$ we have $\mathbf{1}_1 = 0^{1,1}$. Suppose $v = w$ does not hold in \mathcal{EF} . By the isomorphism of \mathcal{EF} with *Gen*, we have that the split equivalences Gv and Gw from n to m are different. Suppose $((i, p), (j, q)) \in Gv$ and $((i, p), (j, q)) \notin Gw$. If $p \neq q$, which means intuitively that one of i and j is in the source of Gv and Gw while the other is in the target, then to obtain $\mathbf{1}_1 = 0^{1,1}$ we proceed as in the preceding proof for \mathcal{RB} . If $p = q = 1$, which means intuitively that i and j are both in the source of Gv and Gw , then we must have $i \neq j$, because Gw is a split equivalence, and hence reflexive. If $i < j$, then for the following arrow of \mathcal{EF} , with the picture of the corresponding split equivalence on the right:

$$h =_{df} !^i + !_1^{j-i-1} + !^{n-j-1}: 2 \rightarrow n$$

in $\mathcal{EF} + \{v = w\}$ we obtain

$$i^m \circ v \circ h = i^m \circ w \circ h,$$

from which, by the isomorphism of \mathcal{EF} with *Gen*, in $\mathcal{EF} + \{v = w\}$ we obtain (∇i) , and hence, as we have shown above, $\mathbf{1}_1 = 0^{1,1}$. If $p = q = 2$, which means intuitively that i and j are both in the target of Gv and Gw , then we proceed analogously via $(\Delta!)$.

From $\mathbf{1}_1 = 0^{1,1}$ in $\mathcal{EF} + \{v = w\}$ we obtain $\mathbf{1}_k = 0^{k,k}$ in $\mathcal{EF} + \{v = w\}$, for every $k \geq 0$. Although $0^{k,k}$ is not a zero arrow of \mathcal{EF} , for every arrow term $f: k \rightarrow l$ of \mathcal{EF} we have in \mathcal{EF} , and hence also in $\mathcal{EF} + \{v = w\}$, the equation

$$0^{l,l} \circ f \circ 0^{k,k} = 0^{k,l}.$$

To verify this, note that the split equivalences corresponding to the two sides are the same discrete split equivalence (we have only pairs (x, x) in them). So,

from $\mathbf{1}_1 = 0^{1,1}$ in $\mathcal{EF} + \{v = w\}$, we obtain $f = g$ in $\mathcal{EF} + \{v = w\}$ for all arrow terms f and g of \mathcal{EF} of the same type. \dashv

PROOF OF MAXIMALITY FOR \mathcal{PF} . We proceed in principle as in the preceding proof for \mathcal{EF} . To show that the new equation $v = w$ that does not hold in \mathcal{PF} yields $\mathbf{1}_1 = 0^{1,1}$ in $\mathcal{PF} + \{v = w\}$, we have that either of the equations to which the following pictures correspond:

$$\begin{array}{c} \downarrow \\ \circ \end{array} = \begin{array}{c} \circ \\ \downarrow \end{array} \quad \begin{array}{c} \uparrow \\ \circ \end{array} = \begin{array}{c} \circ \\ \uparrow \end{array} \quad \begin{array}{c} \downarrow \\ \downarrow \end{array} = \begin{array}{c} \uparrow \\ \uparrow \end{array} \quad \begin{array}{c} \uparrow \\ \uparrow \end{array} = \begin{array}{c} \downarrow \\ \downarrow \end{array} \quad \begin{array}{c} \downarrow \\ \downarrow \end{array} = \begin{array}{c} \uparrow \\ \uparrow \end{array}$$

yields $\mathbf{1}_1 = 0^{1,1}$ in $\mathcal{PF} + \{v = w\}$. For that we use the up-and-down equation of Section 3. \dashv

Maximality for \mathcal{PF} , \mathcal{EF} and \mathcal{RB} means that the corresponding notions of monad are not only complete with respect to the models *SplPre*, *Gen* and *Rel*, but they are also complete in a syntactical sense. In the languages in which these notions are formulated, there are no further nontrivial varieties of these notions.

Acknowledgement. Work on this paper was supported by the Ministry of Science of Serbia (Grants 144013 and 144029).

References

- [1] G. BURDE and H. ZIESCHANG, *Knots*, de Gruyter, Berlin, 1985
- [2] A. CARBONI, *Matrices, relations and group representations*, *Journal of Algebra*, vol. 136 (1991), pp. 497-529
- [3] K. DOŠEN and Z. PETRIĆ, *Generality of proofs and its Brauerian representation*, *The Journal of Symbolic Logic*, vol. 68 (2003), pp. 740-750 (available at: <http://arXiv.org/math.LO/0211090>)
- [4] ———, *A Brauerian representation of split preorders*, *Mathematical Logic Quarterly*, vol. 49 (2003), pp. 579-586 (available at: <http://arXiv.org/math.LO/0211277>)
- [5] ———, *Self-adjunctions and matrices*, *Journal of Pure and Applied Algebra*, vol. 184 (2003), pp. 7-39 (unabridged version available at: <http://arXiv.org/math.GT/0111058>)
- [6] ———, *Proof-Theoretical Coherence*, KCL Publications (College Publications), London, 2004 (revised version of 2007 available at: <http://www.mi.sanu.ac.yu/~kosta/coh.pdf>)

- [7] ———, *Proof-Net Categories*, Polimetrica, Monza, 2007 (preprint of 2005 available at: <http://www.mi.sanu.ac.yu/~kosta/pn.pdf>)
- [8] ———, *Coherence in linear predicate logic*, to appear in *Annals of Pure and Applied Logic* (available at: <http://arXiv.org/arXiv:0709.1421>)
- [9] ———, *Coherence for modalities*, preprint, 2008 (available at: <http://arXiv.org/arXiv:0809.2494>)
- [10] ———, *Ordinals in Frobenius monads*, preprint, 2008 (available at: <http://arXiv.org/arXiv:0809.2495>)
- [11] R. HOOFMAN, *The theory of semi-functors*, *Mathematical Structures in Computer Science*, vol. 3 (1993), pp. 93-128
- [12] V.F.R. JONES, *Index for subfactors*, *Inventiones Mathematicae*, vol. 72 (1983), pp. 1-25
- [13] J. KOCK, *Frobenius Algebras and 2D Topological Quantum Field Theories*, Cambridge University Press, Cambridge, 2003
- [14] S. LACK, *Composing PROPs*, *Theory and Applications of Categories*, vol. 13 (2004), pp. 147-163
- [15] K.W. LAU and D.G. FITZGERALD, *Ideal structure of the Kauffman and related monoids*, *Communications in Algebra*, vol. 34 (2006), pp. 2617-2629
- [16] S. MAC LANE, *Categories for the Working Mathematician*, expanded second edition, Springer, Berlin, 1998
- [17] R. ROSEBRUGH, N. SABADINI and R.F.C. WALTERS, *Generic commutative separable algebras and cospans of graphs*, *Theory and Applications of Categories*, vol. 15 (2005), pp. 164-177