

# Optimal Encoding Schemes for Several Classes of Discrete Degraded Broadcast Channels

Bike Xie, Student Member, IEEE and Richard D. Wesel, Senior Member, IEEE

## Abstract

Let  $X \rightarrow Y \rightarrow Z$  be a discrete memoryless degraded broadcast channel (DBC) with marginal transition probability matrices  $T_{YX}$  and  $T_{ZX}$ . This paper explores encoding schemes for DBCs. We call a DBC encoder in which symbols from independent codebooks each using the same alphabet as  $X$  are combined using the same single-letter function that adds distortion to the channel a natural encoding (NE) scheme. This paper shows that NE schemes achieve the boundary of the capacity region for the multi-user broadcast channel, the two-user group-additive DBC, and the two-user discrete multiplicative DBC. This paper also defines and studies the input-symmetric DBC and introduces a permutation encoding approach for the input-symmetric DBC and proves its optimality.

Denote  $q$  as the distribution of the channel input  $X$ . Inspired by Witsenhausen and Wyner, this paper defines and studies the function  $F$ . For any given  $q$ , and  $H(Y|X) = s = H(Y)$ , where  $H(Y|X)$  is the conditional entropy of  $Y$  given  $X$  and  $H(Y)$  is the entropy of  $Y$ , define the function  $F_{T_{YX}; T_{ZX}}(q; s)$  as the minimum of  $H(Z|U)$ , the conditional entropy of  $Z$  given  $U$  with respect to all discrete random variables  $U$  such that a)  $H(Y|U) = s$ , and b)  $U$  and  $Y; Z$  are conditionally independent given  $X$ . This paper studies the function  $F$ , its properties and its calculation. This paper then represents the capacity region of the DBC  $X \rightarrow Y \rightarrow Z$  using the function  $F_{T_{YX}; T_{ZX}}$ . Finally, this paper applies these results to several classes of DBCs and their encoders as discussed above.

## Keywords

Degraded broadcast channel, natural encoding, broadcast channel, input-symmetric, group-additive degraded broadcast channel, discrete multiplicative degraded broadcast channel.

## I. Introduction

In the 70's, Cover [1], Bergmans [2] and Gallager [3] established the capacity region for degraded broadcast channels (DBC). A common optimal transmission strategy to achieve the boundary of the capacity region for degraded broadcast channels is the joint encoding scheme presented in [4]. Specifically, the data sent to the user with the most degraded channel is encoded first. Given the codeword selected for that user, an appropriate codebook for the user with the second most degraded channel is selected, and so forth.

This work was supported by the Defence Advanced Research Project Agency SPAWAR System Center, San Diego, California under Grant N66001-02-1-8938. The authors are with the Electrical Engineering Department, University of California, Los Angeles, CA 90095 USA (e-mail: xie@ee.ucla.edu; wesel@ee.ucla.edu).

An independent-encoding scheme can also achieve the capacity of any DBC, as described in Appendix I [5]. This scheme essentially embeds all symbols from all the needed codebooks for the less-degraded user into a single super-symbol (but perhaps with a large alphabet). Then a single-letter function uses the input symbol from the more-degraded user to extract the needed symbol from the super symbol provided by the less-degraded user.

Cover [6] introduced an independent-encoding scheme for two-user broadcast channels. When applied for two-user degraded broadcast channels, this scheme independently encodes users' messages, and then combines these resulting codewords by applying a single-letter function. This scheme does not specify what codebooks to use or what single-letter function to use. It is a general independent-encoding approach, which includes the independent-encoding scheme in Appendix I.

A simple encoding scheme that is optimal for some common DBCs is an independent-encoding approach in which symbols from independent codebooks each with the same alphabet as  $X$  are combined using the same single-letter function that adds distortion to the channel. We refer to this encoding scheme as the natural encoding (NE) scheme. As an example, the NE scheme for a two-receiver broadcast Gaussian channel has as each transmitted symbol the real addition of two real symbols from independent codebooks.

The NE scheme is known to achieve the boundary of the capacity region for several broadcast channels including broadcast Gaussian channels [7], broadcast binary-symmetric channels [2] [8] [9] [10], discrete additive degraded broadcast channels [11] and two-user broadcast Z channels [12] [13]. This paper shows that NE schemes also achieve the boundary of the capacity region for the multi-user broadcast Z channel, the two-user group-additive DBC, and the two-user discrete multiplicative DBC.

Shannon's entropy power inequality (EPI) [14] gives a lower bound on the differential entropy of the sum of independent random variables. In Bergmans's remarkable paper [7], he applied EPI to establish a converse showing the optimality of the scheme given by [1] [2]

(the NE scheme) for broadcast Gaussian channels. \textit{Mrs. Gerber's Lemma} [15] provides a lower bound on the entropy of a sequence of binary-symmetric channel outputs. Wyner and Ziv obtained \textit{Mrs. Gerber's Lemma} and applied it to establish a converse showing that the NE scheme for broadcast binary-symmetric channels suggested by Cover [1] and Bergmans [2] achieves the boundary of the capacity region [8]. EPI and \textit{Mrs. Gerber's Lemma} play the same significant role in proving the optimality of the NE schemes for broadcast Gaussian channels and broadcast binary-symmetric channels. Witsenhausen and Wyner studied a conditional entropy bound for the channel output of a discrete channel and applied the results to establish an outer bound of the capacity region for DBCs [9] [10]. For broadcast binary-symmetric channels, this outer bound coincides with the capacity region. This paper extends ideas from Witsenhausen and Wyner [10] to study a conditional entropy bound for the channel output of a discrete DBC and represent the capacity region of discrete DBCs with this conditional entropy bound. This paper simplifies the expression of the conditional entropy bound for broadcast binary-symmetric channels and broadcast Z channels. For broadcast Z channels, the simplified expression of the conditional entropy bound demonstrates that the NE scheme provided in [12], which is optimal for two-user broadcast Z channels, is also optimal for multi-user broadcast Z channels.

Witsenhausen and Wyner made two seminal contributions in [9] and [10]: the notion of minimizing one entropy under the constraint that another related entropy is fixed and the use of input symmetry as a way of solving an entire class of channels with a single unifying approach. Benzel [11] used the first idea to study discrete additive degraded broadcast channels. Recently Liu and Ulukus [16] [17] used both ideas together to extend Benzels results to include the larger class of discrete degraded interference channels (DDIC). Our paper defines what it means for a degraded broadcast channel to be input-symmetric (IS) and provides an independent-encoding scheme which achieves the capacity region of all input-symmetric DBCs.

The input-symmetric channel was introduced by Witsenhausen and Wyner [10] and studied in [16] [17] and [18]. This paper extends the definition of the input-symmetric channel to the definition of the input-symmetric DBC. This paper introduces an independent-encoding scheme employing permutation functions of independently encoded streams (the permutation encoding approach) for the input-symmetric DBC and proves its optimality. The discrete additive DBC [11] is a special case of the input-symmetric DBC, and the optimal encoding approach for the discrete additive DBC [11] is also a special case of the permutation encoding approach. The group-additive DBC is a class of input-symmetric DBCs whose channel outputs are group additions of the channel input and noise. The permutation encoding approach for the group-additive DBC is the group-addition encoding approach, which is the NE scheme for the group-additive DBC.

The discrete multiplicative DBC is a discrete DBC whose channel outputs are discrete multiplications (multiplications in a finite field) of the channel input and noise. This paper studies the conditional entropy bound for the discrete multiplicative DBC, and proves that the NE scheme achieves the boundary of the capacity region for discrete multiplicative DBCs.

This paper is organized as follows: Section II defines the conditional entropy bound  $F^*(\cdot)$  for the channel output of a discrete DBC and represents the capacity region of the discrete DBC with the function  $F^*$ . Section III establishes a number of theorems concerning various properties of  $F^*$ . Section IV evaluates  $F^*(\cdot)$  and indicates the optimal transmission strategy for the discrete DBC. For the multi-user broadcast Z channel, Section V proves the optimality of the NE scheme. Section VI introduces the input-symmetric DBC, provides the permutation encoding approach, an independent-encoding scheme for the input-symmetric DBC and proves its optimality. Section VII studies the discrete multiplicative DBC and shows that the NE scheme achieves the boundary of the capacity region for the discrete multiplicative DBC. Section VIII delivers the conclusions.

## II. The Conditional Entropy Bound $F(\cdot)$

Let  $X \rightarrow Y \rightarrow Z$  be a discrete memoryless DBC where  $X \in \mathcal{X}$ ,  $Y \in \mathcal{Y}$ , and  $Z \in \mathcal{Z}$ . Let  $T$  be an  $n \times k$  stochastic matrix with entries  $T_{YX}(j;i) = \Pr(Y = j | X = i)$  and  $T_{ZX}$  be an  $m \times k$  stochastic matrix with entries  $T_{ZX}(j;i) = \Pr(Z = j | X = i)$ . Thus,  $T_{YX}$  and  $T_{ZX}$  are the marginal transition probability matrices of the degraded broadcast channel.

**Definition 1:** Let vector  $q$  in the simplex  $\mathcal{S}_k$  of probability  $k$ -vectors be the distribution of the channel input  $X$ . Define the function  $F_{T_{YX}, T_{ZX}}(q; s)$  as the infimum of  $H(Z | U)$ , the conditional entropy of  $Z$  given  $U$ , with respect to all discrete random variables  $U$  such that

a)  $H(Y | U) = s$ ;

b)  $U$  and  $Y; Z$  are conditionally independent given  $X$ , i.e., the sequence  $U; X; Y; Z$  form a Markov chain  $U \rightarrow X \rightarrow Y \rightarrow Z$ .

For any fixed vector  $q$ , the domain of  $F_{T_{YX}, T_{ZX}}(q; s)$  in  $s$  is the closed interval  $[H(Y | X); H(Y)]$ , where  $H(Y | X)$  is the conditional entropy of  $Y$  given  $X$  and  $H(Y)$  is the entropy of  $Y$ . This will be proved later in Lemma 3. The function  $F(\cdot)$  is an extension to the function  $F(\cdot)$  introduced in [10]. We will use  $F_{T_{YX}, T_{ZX}}(q; s)$ ,  $F(q; s)$  and  $F(s)$  interchangeably.

**Theorem 1:**  $F_{T_{YX}, T_{ZX}}(q; s)$  is monotonically nondecreasing in  $s$  and the infimum in its definition is a minimum. Hence,  $F_{T_{YX}, T_{ZX}}(q; s)$  can be taken as the minimum  $H(Z | U)$  with respect to all discrete random variables  $U$  such that

a)  $H(Y | U) = s$ ;

b)  $U$  and  $Y; Z$  are conditionally independent given  $X$ .

The proof of Theorem 1 will be given in Section III.

**Theorem 2:** The capacity region for the discrete memoryless degraded broadcast channel

$X \rightarrow Y \rightarrow Z$  is the closure of the convex hull of all rate pairs  $(R_1; R_2)$  satisfying

$$0 \leq R_1 \leq I(X; Y); \quad (1)$$

$$R_2 \leq H(Z) - F_{T_{YX}; T_{ZX}}(q; R_1 + H(Y|X)); \quad (2)$$

for some  $q \in \mathcal{P}(\mathcal{X})$ , where  $I(X; Y)$  is the mutual information of between  $X$  and  $Y$ ,  $H(Y|X)$  is the conditional entropy of  $Y$  given  $X$ , and  $H(Z)$  is the entropy of  $Z$  resulting from the channel input's distribution  $q$ . Thus, for a fixed input distribution  $q$  and for  $\lambda \geq 0$ , finding the maximum of  $R_2 + \lambda R_1$  is equivalent to finding the minimum of  $F(q; s)$  as follows:

$$\begin{aligned} \max(R_2 + \lambda R_1) &= \max(H(Z) - F(q; R_1 + H(Y|X)) + \lambda R_1 + H(Y|X) - H(Y|X)) \\ &= H(Z) - H(Y|X) + \max(F(q; R_1 + H(Y|X)) - (\lambda R_1 + H(Y|X))) \\ &= H(Z) - H(Y|X) - \min(F(q; s) - s) \end{aligned} \quad (3)$$

Proof: The capacity region for the DBC is known in [1] [3] [4] as

$$\text{co} \left[ \bigcup_{p(u), p(x|u)} \{ (R_1; R_2) : R_1 \leq I(X; Y|U); R_2 \leq I(U; Z) \} \right]; \quad (4)$$

where  $\text{co}$  denotes the closure of the convex hull operation, and  $U$  is the auxiliary random variable which satisfies the Markov chain  $U \rightarrow X \rightarrow Y \rightarrow Z$  and  $|U| \leq \min(|X|, |Y|, |Z|)$ .

Rewrite (4) and we have

$$\begin{aligned}
& \infty^4 \int_{\mathcal{R}_1, \mathcal{R}_2} f(\mathcal{R}_1; \mathcal{R}_2) : R_1 \quad I(X; Y | \mathcal{J}); R_2 \quad I(U; Z) g^5 \\
& \stackrel{2}{=} \infty^4 \int_{\mathcal{R}_1, \mathcal{R}_2} \int_{\mathcal{U}, \mathcal{Z}} \left[ f(\mathcal{R}_1; \mathcal{R}_2) : R_1 \quad I(X; Y | \mathcal{J}); R_2 \quad I(U; Z) g \right]_{p_X = q}^{p(u) p(z)} \\
& \stackrel{3}{=} \infty^4 \int_{\mathcal{R}_1, \mathcal{R}_2} \int_{\mathcal{U}, \mathcal{Z}} \left[ f(\mathcal{R}_1; \mathcal{R}_2) : R_1 \quad H(Y | \mathcal{J}) \quad H(Y | \mathcal{X}); R_2 \quad H(Z) \quad H(Z | \mathcal{J}) g \right]_{p_X = q}^{p(u, z) \text{ with } p_X = q} \\
& \stackrel{6}{=} \infty^4 \int_{\mathcal{R}_1, \mathcal{R}_2} \int_{\mathcal{U}, \mathcal{Z}} \left[ f(\mathcal{R}_1; \mathcal{R}_2) : R_1 \quad s \quad H(Y | \mathcal{X}); R_2 \quad H(Z) \quad F_{T_{YX}, T_{ZX}}(q; s) \right]_{p_X = q}^{p(u, z) \text{ with } p_X = q} \\
& \stackrel{7}{=} \infty^4 \int_{\mathcal{R}_1, \mathcal{R}_2} \left[ f(\mathcal{R}_1; \mathcal{R}_2) : 0 \quad R_1 \quad I(X; Y); R_2 \quad H(Z) \quad F_{T_{YX}, T_{ZX}}(q; R_1 + H(Y | \mathcal{X})) \right]_{p_X = q}^{3}
\end{aligned}
\tag{8}$$

where  $p_X$  is the vector expression of the distribution of channel input  $X$ . Some of these steps are justified as follows:

- (5) follows from the equivalence of  $\int_{\mathcal{R}_1, \mathcal{R}_2} \int_{\mathcal{U}, \mathcal{Z}} p(u) p(z)$  and  $\int_{\mathcal{R}_1, \mathcal{R}_2} \int_{\mathcal{U}, \mathcal{Z}} p(u, z) \text{ with } p_X = q$ ;
- (6) follows from the definition of the conditional entropy bound  $F$ ;
- (7) follows from the nondecreasing property of  $F(s)$  in Theorem 1, which allows the substitution  $s = R_1 + H(Y | \mathcal{X})$  in the argument of  $F$ . Q.E.D.

Note that for a fixed distribution  $p_X = q$  of the channel input  $X$ , the terms  $I(X; Y)$ ,  $H(Z)$  and  $H(Y | \mathcal{X})$  in (8) are constants. This theorem provides the relationship between the capacity region and the conditional entropy bound  $F$  for a discrete degraded broadcast channel. It also motivates the further study of  $F$ .

### III. Some Properties of $F(\cdot)$

In this section, we will extend ideas from [10] to establish several properties of the conditional entropy bound  $F(\cdot)$ . In [10], Witsenhausen and Wyner defined a conditional entropy bound  $F(\cdot)$  for a pair of discrete random variables and provided some properties of  $F(\cdot)$ . The definition of  $F(\cdot)$  is restated here. Let  $X \rightarrow Z$  be a discrete memoryless channel with the  $m \times k$  transition probability matrix  $T$ , where the entries  $T(j;i) = \Pr(Z = j | X = i)$ . Let  $q$  be the distribution of  $X$ . For any  $q \in \mathcal{P}_k$ , and  $0 \leq s \leq H(X)$ , the function  $F_T(q; s)$  is the minimum of  $H(Z | J)$  with respect to all discrete random variables  $U$  such that  $H(X | J) = s$  and the sequence  $U, X, Z$  is a Markov chain. By definition,  $F_T(q; s) = F_{I, T}(q; s)$ , where  $I$  is an identity matrix. Since  $F(\cdot)$  is the extension of  $F(\cdot)$ , most of the properties of  $F(\cdot)$  in this section are generalizations of properties of  $F(\cdot)$  in [10].

For any choice of the integer  $l \geq 1$ ,  $w = [w_1; \dots; w_l]^T \in \mathcal{P}_l$  and  $p_j \in \mathcal{P}_k$  for  $j = 1; \dots; l$ , let  $U$  be a  $l$ -ary random variable with distribution  $w$ , and let  $T_{X|U} = [p_1 \dots p_l]$  be the transition probability matrix from  $U$  to  $X$ . We can compute

$$p = p_X = T_{X|U} w = \sum_{j=1}^l w_j p_j \quad (9)$$

$$= H(Y | J) = \sum_{j=1}^l w_j h_n(T_{Y|X} p_j) \quad (10)$$

$$= H(Z | J) = \sum_{j=1}^l w_j h_m(T_{Z|X} p_j) \quad (11)$$

where  $h_n : \mathcal{P}_n \rightarrow \mathbb{R}$  is the entropy function, i.e.,  $h_n(p_1; \dots; p_n) = -\sum_{i=1}^n p_i \ln p_i$ . Thus the choices of  $U$  satisfying conditions a) and b) in the definition of  $F_{T_{Y|X}, T_{Z|X}}(q; s)$  corresponds to the choices of  $l, w$  and  $p_j$  for which (9)–(10) yields  $p = q$  and  $s = s$ .

Let  $S = \{(p; h_n(T_{Y|X} p); h_m(T_{Z|X} p)) \in \mathcal{P}_k \times [0; \ln n] \times [0; \ln n] \mid p \in \mathcal{P}_k\}$ . Since  $\mathcal{P}_k$  is  $(k-1)$ -dimensional,  $\mathcal{P}_k \times [0; \ln n] \times [0; \ln n]$  is a  $(k+1)$ -dimensional convex polytope. The mapping  $p \mapsto (p; h_n(T_{Y|X} p); h_m(T_{Z|X} p))$  assigns a point in  $S$  for each  $p \in \mathcal{P}_k$ . Because this mapping



is continuous and the domain of the mapping,  $\mathcal{K}$ , is compact and connected, the image  $S$  is also compact and connected.

Let  $C$  be the set of all  $(p; \lambda)$  satisfying  $\emptyset$  (10) and (11) for some choice of  $l, w$  and  $p_j$ . By definition, the set  $C$  is the convex hull of the set  $S$ . Thus,  $C$  is compact, connected, and convex.

Lemma 1:  $C$  is the convex hull of  $S$ , and thus  $C$  is compact, connected, and convex.

Lemma 2: i) Every point of  $C$  can be obtained by (9) (10) and (11) with  $l \leq k + 1$ . In other words, one only need to consider random variables  $U$  taking at most  $k + 1$  values.

ii) Every extreme point of the intersection of  $C$  with a two-dimensional plane can be obtained with  $l \leq k$ .

The proof of Lemma 2 is the same as the proof of a similar lemma for  $F(\cdot)$  in [0]. The details of the proof are given in Appendix II.

Let  $C = \{(q; s) | j(q; s) \geq C\}$  be the projection of the set  $C$  onto the  $(q; s)$ -plane. Let  $C_q = \{(q; s) | j(q; s) \geq C\}$  be the projection onto the  $(q; s)$ -plane of the intersection of  $C$  with the two-dimensional plane  $p = q$ . By definition,  $C = \bigcap_{q \in \mathcal{K}} C_q$ . Also,  $C$  and  $C_q$  are compact and convex. By definition,  $F_{T_{YX}, T_{ZX}}(q; s)$  is the infimum of all  $C$ , for which  $C_q$  contains the point  $(q; s)$ . Thus

$$F_{T_{YX}, T_{ZX}}(q; s) = \inf_{C} j(q; s) \geq C = \inf_{C_q} j(q; s) \geq C_q \quad (12)$$

Lemma 3: For any fixed  $q$  as the distribution of  $X$ , the domain of  $F_{T_{YX}, T_{ZX}}(q; s)$  in  $s$  is the closed interval  $[H(Y|X); H(Y)]$ , i.e.,  $[\sum_{i=1}^P q_i h_n(T_{YX} e_i); h_n(T_{YX} q)]$ , where  $e_i$  is a vector, for which the  $i^{\text{th}}$  entry is 1 and all other entries are zeros.

Proof: For any Markov chain  $U \rightarrow X \rightarrow Y$ , by the Data Processing Theorem [19],  $H(Y|U) \leq H(Y|X)$  and the equality is achieved when the random variable  $U = X$ . One also has  $H(Y|U) \leq H(Y)$  and the equality is achieved when  $U$  is a constant. Thus, the domain of  $F_{T_{YX}, T_{ZX}}(q; s)$  in  $s$  is  $[H(Y|X); H(Y)]$  for a fixed distribution of channel input

$X$ . Since  $q$  is the distribution of  $X$ ,  $H(Y|X) = \sum_{i=1}^k q_i h_n(T_{YX} e_i)$  and  $H(Y) = h_n(T_{YX} q)$ .  
 Q E D .

**Theorem 3:** The function  $F_{T_{YX}, T_{ZX}}(q; s)$  is defined on the compact convex domain  $f(q; s) \in \mathbb{R}^2$   $q; \sum_{i=1}^k q_i h_n(T_{YX} e_i) \leq s \leq h_n(T_{YX} q)g$  and for each  $(q; s)$  in this domain, the minimum in its definition is a minimum, attainable with  $U$  taking at most  $k + 1$  values.

**Proof:** By Lemma 3, the function  $F$  is defined on the compact domain  $f(q; s) \in \mathbb{R}^2$   $q; \sum_{i=1}^k q_i h_n(T_{YX} e_i) \leq s \leq h_n(T_{YX} q)g$ . This domain is convex because  $\mathbb{R}^k$  is convex, the entropy function  $h_n(T_{YX} q)$  is concave in  $q$  and  $\sum_{i=1}^k q_i h_n(T_{YX} e_i)$  is linear in  $q$ . For each  $(q; s)$  in this domain, the set  $f(j(s); \mathbb{R}^2) \cap C_q g$  is non-empty. It is in fact a compact interval since  $C_q$  is compact. Therefore,

$$F_{T_{YX}, T_{ZX}}(q; s) = \inf_{(j(s); \mathbb{R}^2) \cap C_q} g = \min_{(j(s); \mathbb{R}^2) \cap C_q} g = \min_{(q; s; \mathbb{R}^2) \cap C_q} g: \quad (13)$$

By Lemma 2 i), this minimum is attained with  $U$  taking at most  $k + 1$  values. Q E D .

By Lemma 2 ii), the extreme points of  $C_q$  can be attained by convex combinations of at most  $k$  points of  $S$ . Thus, every linear function of  $(; )$  could attain its minimum with  $U$  taking at most  $k$  value since every linear function of  $(; )$  achieves its minimum over  $C_q$  at an extreme point of the compact set  $C_q$ .

**Lemma 4:** The function  $F_{T_{YX}, T_{ZX}}(q; s)$  is jointly convex in  $(q; s)$ .

**Proof:**  $F_{T_{YX}, T_{ZX}}(q; s)$  is jointly convex in  $(q; s)$  because  $C$  is a convex set. In particular, the domain of  $F$  is convex by Theorem 3. For any two points  $(q_1; s_1)$  and  $(q_2; s_2)$  in the

domain, and for any  $0 \leq \lambda \leq 1$ ,

$$\begin{aligned}
 & F_{T_{YX}, T_{ZX}}(\lambda q_1 + (1-\lambda)q_2; \lambda s_1 + (1-\lambda)s_2) \\
 &= \min_{j \in \mathcal{J}} \mathbb{E}[(\lambda q_1 + (1-\lambda)q_2; \lambda s_1 + (1-\lambda)s_2; j)^2 | Cg] \\
 &= \min_{j \in \mathcal{J}} \lambda \mathbb{E}[(q_1; s_1; j)^2 | Cg] + (1-\lambda) \mathbb{E}[(q_2; s_2; j)^2 | Cg] \\
 &= \lambda F_{T_{YX}, T_{ZX}}(q_1; s_1) + (1-\lambda) F_{T_{YX}, T_{ZX}}(q_2; s_2).
 \end{aligned}$$

Therefore,  $F_{T_{YX}, T_{ZX}}(q; s)$  is jointly convex in  $(q; s)$ . Q.E.D.

Now we give the proof of Theorem 1. Since Theorem 3 has shown that the minimum in the definition of  $F$  is a minimum, it suffices to show that  $F(q; s) = F_{T_{YX}, T_{ZX}}(q; s)$  is monotonically nondecreasing in  $s$ . For any fixed  $q$ , the domain of  $s$  is  $[\mathbb{H}(Y; X); \mathbb{H}(Y)]$ . On the one hand,

$$\begin{aligned}
 F(q; \mathbb{H}(Y; X)) &= \min_{j \in \mathcal{J}} \mathbb{E}[(Z; j)^2 | p_X = q; \mathbb{H}(Y; X)] = \mathbb{H}(Z; X) \\
 &= \min_{j \in \mathcal{J}} \mathbb{E}[(Z; j)^2 | p_X = q; U = X] \\
 &= \mathbb{H}(Z; X). \tag{14}
 \end{aligned}$$

On the other hand, for any  $s \in [\mathbb{H}(Y; X); \mathbb{H}(Y)]$ ,

$$\begin{aligned}
 F(q; s) &= \min_{j \in \mathcal{J}} \mathbb{E}[(Z; j)^2 | p_X = q; \mathbb{H}(Y; X)] = \mathbb{H}(Z; X) \\
 &= \min_{j \in \mathcal{J}} \mathbb{E}[(Z; j; X)^2 | p_X = q; \mathbb{H}(Y; X)] = \mathbb{H}(Z; X) \tag{15}
 \end{aligned}$$

$$= \mathbb{H}(Z; X); \tag{16}$$

where (15) follows from  $\mathbb{H}(Z; j) \leq \mathbb{H}(Z; j; X)$  and (16) follows from the conditional independence between  $Z$  and  $U$  given  $X$ . Inequalities (14) and (16) imply that for any

$s \in [H(Y|X); H(Y)]$ ,

$$F(q; s) = F(q; H(Y|X)) \tag{17}$$

Combining (17) and the fact that  $F(q; s)$  is convex in  $s$  for any fixed  $q$ , we have  $F(q; s)$  is monotonically nondecreasing in  $s$ . Q.E.D.

The proof of Theorem 1 also gives an endpoint of  $F(s)$ ,

$$F(q; H(Y|X)) = H(Z|X); \tag{18}$$

which is achieved when  $U = X$ . The following theorem will provide the other endpoint,

$$F(q; H(Y)) = H(Z); \tag{19}$$

which is obtained when  $U$  is a constant.

**Theorem 4:** For  $H(Y|X) \leq s \leq H(Y)$ , a lower bound of  $F(s)$  is

$$F(s) \geq s + H(Z) - H(Y); \tag{20}$$

$F(s)$  is differentiable at all but at most countably many points. At differentiable points of  $F(s)$ ,

$$0 \leq \frac{dF(s)}{ds} \leq 1; \tag{21}$$

**Proof:**

$$I(U; Z) \leq I(U; Y) \tag{22}$$

$$\leq H(Z) - H(Z|U) + H(Y) - H(Y|U)$$

$$\leq H(Z|U) + H(Y|U) + H(Z) - H(Y)$$

$$\leq F(s) - s + H(Z) - H(Y); \tag{23}$$

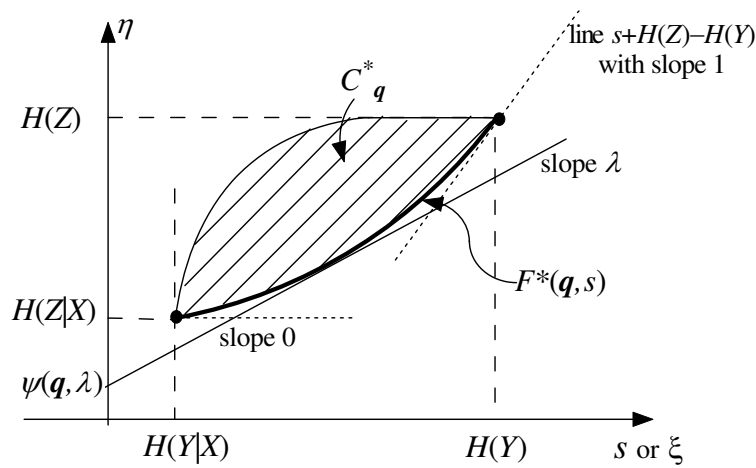

Fig. 1

Illustrations of the curve  $F^*(q; s) = F_{T_{YX}, T_{ZX}}(q; s)$  shown in bold, the region  $C_q$ , and the point  $(0; \psi(q; \lambda))$ .

Some of these steps are justified as follows:

(2) follows from the Data Processing Theorem [19];

(3) follows from the definition of  $F^*(s)$ .

When the random variable  $U$  is a constant,  $H(Y|U) = H(Y)$  and  $H(Z|U) = H(Z)$ . Thus, equality in (23) is attained when  $s = H(Y)$ . Since  $F^*(s)$  is convex in  $s$ , it is differentiable at all but at most countably many points. If  $F^*(s)$  is differentiable at  $s = H(Y)$ , then  $\frac{dF^*(s)}{ds} \Big|_{s=H(Y)} = 1$  because the line  $s + H(Z) - H(Y)$  with slope 1 supports the curve  $F^*(s)$  at its endpoint  $(H(Y); F^*(H(Y)))$ . For any  $H(Y|X) < s < H(Y)$  where  $F^*(s)$  is differentiable, since  $F^*(s)$  is convex, the slope of the supporting line at the point  $(s; F^*(s))$  is less than or equal to the slope of the supporting line  $s + H(Z) - H(Y)$  at the point  $(H(Y); F^*(H(Y)))$ . Thus, for any  $H(Y|X) < s < H(Y)$  where  $F^*(s)$  is differentiable

$$\frac{dF^*(s)}{ds} \leq 1: \quad (24)$$

$\frac{dF^*(s)}{ds} \geq 0$  because  $F^*(s)$  is monotonically nondecreasing. The illustrations of the function

$F^*(s) = F_{T_{YX}, T_{ZX}}(q; s)$  and  $C_q$  are shown in Fig. 1. Q E D .

For  $X = q$ , where  $q$  is a fixed vector, by Theorem 2, finding the maximum of  $R_2 + R_1$  is equivalent to finding the minimum of  $F(q; s)$ . Theorem 4 indicates that for every  $\epsilon > 0$ , the minimum of  $F(q; s)$  is attained when  $s = H(Y)$  and  $F(s) = H(Z)$ , i.e.,  $U$  is a constant. Thus, the non-trivial range of  $\epsilon$  is  $0 < \epsilon < 1$ .

The following theorem is the key to the applications in Section V and is an extension and generalization of Theorem 2.4 in [10]. Let  $X = (X_1; \dots; X_N)$  be a sequence of channel inputs to the degraded broadcast channel  $X \rightarrow Y \rightarrow Z$ . The corresponding channel outputs are  $Y = (Y_1; \dots; Y_N)$  and  $Z = (Z_1; \dots; Z_N)$ . Thus, the sequence of the channel outputs  $(Y_i; Z_i)$ ,  $i = 1; \dots; N$ , are conditionally independent of each other given the channel inputs  $X$ . Note that the channel outputs  $(Y_i; Z_i)$  do not have to be identically or independently distributed since  $X_1; \dots; X_N$  could be correlated and have different distributions. Denote  $q_i$  as the distribution of  $X_i$  for  $i = 1; \dots; N$ . Thus,  $q = \frac{1}{N} \sum_{i=1}^N q_i$  is the average of the distribution of the channel inputs. For any  $q \in \mathcal{K}$ , define  $F_{T_{YX}^{(N)}, T_{ZX}^{(N)}}(q; N, s)$  be the minimum of  $H(Z^N | U)$  with respect to all random variables  $U$  and all possible channel inputs  $X$  such that  $H(Y^N | U) = Ns$ , the average of the distribution of the channel inputs is  $q$  and  $U \rightarrow X \rightarrow Y \rightarrow Z$  is a Markov chain.

Theorem 5: For all  $N = 1; 2; \dots$ ; and all  $T_{YX}^{(N)}, T_{ZX}^{(N)}, q$ , and  $H(Y^N | X) \leq H(Y)$ , one has

$$F_{T_{YX}^{(N)}, T_{ZX}^{(N)}}(q; N, s) = N F_{T_{YX}, T_{ZX}}(q; s) \quad (25)$$

Proof: We first prove that  $F_{T_{YX}^{(N)}, T_{ZX}^{(N)}}(q; N, s) \geq N F_{T_{YX}, T_{ZX}}(q; s)$ . Since

$$Ns = H(Y^N | U) = \sum_{i=1}^N H(Y_i | X_i; U) \quad (26)$$

$$= \sum_{i=1}^N s_i \quad (27)$$

where  $s_i = H(Y_i|Z_i; U)$  and (26) follows from the chain rule of entropy [4],

$$H(Z|J) = \sum_{i=1}^N H(Z_i|Z_{1:i}; U) \quad (28)$$

$$\leq \sum_{i=1}^N H(Z_i|Z_{1:i}; Y_{1:i}; U) \quad (29)$$

$$= \sum_{i=1}^N H(Z_i|Y_{1:i}; U) \quad (30)$$

$$\leq \sum_{i=1}^N F_{T_{YX}, T_{ZX}}(q_i; s_i) \quad (31)$$

$$\leq N F_{T_{YX}, T_{ZX}}\left(\sum_{i=1}^N q_i; \sum_{i=1}^N s_i\right) \quad (32)$$

$$= N F_{T_{YX}, T_{ZX}}(q; s) \quad (33)$$

Some of these steps are justified as follows:

(28) follows from the chain rule of entropy [4];

(29) holds because conditional entropy decreases when the conditioning increases;

(30) follows from the fact that  $Z_i$  and  $Z_{1:i}; U$  are conditionally independent given  $Y_{1:i}; U$ ;

(31) follows from the definition of  $F_{T_{YX}, T_{ZX}}$  if considering the Markov chain  $(U; Y_{1:i}; Z_i; X_i; Y_i; Z_i)$ ;

(32) results from applying Jensen's inequality to the convex function  $F_{T_{YX}, T_{ZX}}$ .

By the definition of  $F_{T_{YX}^{(N)}, T_{ZX}^{(N)}}(q; s)$ , Equation (33) implies that

$$F_{T_{YX}^{(N)}, T_{ZX}^{(N)}}(q; s) \leq N F_{T_{YX}, T_{ZX}}(q; s) \quad (34)$$

On the other hand, in the case that  $U$  is composed of  $N$  independently identically distributed (i.i.d.) random variables  $(U_1; \dots; U_N)$  and each  $U_i; X_i$  achieves  $p_{X_i} = q$ ,  $H(Y_i|J_i) = s$

and  $H(Z_i|J_i) = F_{T_{YX}, T_{ZX}}(q; s)$ , one has  $H(Y|J) = N s$  and  $H(Z|J) = N F_{T_{YX}, T_{ZX}}(q; s)$ .

Since  $F_{T_{YX}, T_{ZX}}^{(N)}$  is defined by taking the minimum,

$$F_{T_{YX}, T_{ZX}}^{(N)}(q; N s) = N F_{T_{YX}, T_{ZX}}(q; s). \quad (35)$$

Combining (34) and (35), one has  $F_{T_{YX}, T_{ZX}}^{(N)}(q; N s) = N F_{T_{YX}, T_{ZX}}(q; s)$ . Q.E.D.

Theorem 5 indicates that if using the degraded broadcast channel  $X \rightarrow Y \rightarrow Z$  for  $N$  times, and for a fixed  $q$  as the average of the distribution of the channel inputs, the conditional entropy bound  $F_{T_{YX}, T_{ZX}}^{(N)}(q; N s)$  is achieved when the channel is used independently and identically for  $N$  times, and single use of the channel at each time achieves the conditional entropy bound  $F_{T_{YX}, T_{ZX}}(q; s)$ .

#### IV. Evaluation of $F(\cdot)$

In this section, we evaluate  $F(s) = F_{T_{YX}, T_{ZX}}(q; s)$  via a duality technique, which is also used for evaluating  $F(\cdot)$  in [0]. This duality technique also provides the optimal transmission strategy for the DBC  $X \rightarrow Y \rightarrow Z$  to achieve the maximum of  $R_2 + R_1$  for any  $s \geq 0$ .

Theorem 3 shows that

$$F_{T_{YX}, T_{ZX}}(q; s) = \min_j \{j(s) - C_q\} = \min_j \{j(q; s) - C_q\} \quad (36)$$

Thus, the function  $F_{T_{YX}, T_{ZX}}(q; s)$  is determined by the lower boundary of  $C_q$ . Since  $C_q$  is convex, its lower boundary can be described by the lines supporting its graph from the below. The line with slope  $s$  in the  $(q; C_q)$ -plane supporting  $C_q$  as shown in Fig. 1 has the equation

$$C_q = s q + (q; s); \quad (37)$$

where  $(q; s)$  is the  $-$ intercept of the tangent line with slope  $s$  for the function  $F_{T_{YX}, T_{ZX}}(q; s)$ .



Thus,

$$F(q; s) = \min_{(q; s)} F(q; s) \quad H(Y, X) \quad H(Y)g \quad (38)$$

$$= \min_{(q; s)} j(q; s) \quad Cg \quad (39)$$

$$= \min_{(q; s)} j(q; s) \quad Cg: \quad (40)$$

For  $H(Y, X) \leq H(Y)$ , the function  $F(s) = F_{T_{YX}, T_{ZX}}(q; s)$  can be represented as

$$F(s) = \max_{(q; s)} (q; s) + sj \quad 1 < s < 1 \quad g: \quad (41)$$

Theorem 1 shows that the graph of  $F(s)$  is supported at  $s = H(Y, X)$  by a line of slope 0, and Theorem 4 shows that the graph of  $F(s)$  is supported at  $s = H(Y)$  by a line of slope 1. Thus, for  $H(Y, X) \leq H(Y)$ ,

$$F(s) = \max_{(q; s)} (q; s) + sj \quad 1g: \quad (42)$$

Let  $L$  be a linear transformation  $(q; s) \rightarrow (q; s)$ . It maps  $C$  and  $S$  onto the sets

$$C = f(q; s) \quad j(q; s) \quad Cg; \quad (43)$$

and

$$S = f(q; h_m(T_{ZX} q) \quad h_n(T_{YX} q)) \quad j \quad 2 \quad k \quad g: \quad (44)$$

The lower boundaries of  $C$  and  $S$  are the graphs of  $(q; s)$  and  $(q; s) = h_m(T_{ZX} q) \quad h_n(T_{YX} q)$  respectively. Since  $C$  is the convex hull of  $S$ , and thus  $C$  is the convex hull of  $S$ ,  $(q; s)$  is the lower convex envelope of  $(q; s)$  on  $k$ .

In conclusion,  $(q; s)$  can be obtained by forming the lower convex envelope of  $(q; s)$  for each  $q$  and  $F(q; s)$  can be reconstructed from  $(q; s)$  by (42). This is the dual approach to

the evaluation of  $F^*$ .

Theorem 2 represents the capacity region for a DBC by the function  $F^*(q; s)$ . Since  $(q; s)$  and  $F^*(q; s)$  can be constructed by each other from (38) and (42), for any  $s \geq 0$ , the associated point on the boundary of the capacity region may be found (from its unique value of  $R_2 + R_1$ ) as follows

$$\begin{aligned}
 & \max_{q^2} \max_k R_2 + R_1 \dot{p}_X = qg \\
 & = \max_{q^2} \max_k H(Z) - F^*(q; s) + s H(Y|X)g \\
 & = \max_{q^2} (H(Z) - H(Y|X) - \min F^*(q; s) - sg) \\
 & = \max_{q^2} (H(Z) - H(Y|X) - (q; s)): \tag{45}
 \end{aligned}$$

We have shown the relationship among  $F^*$ , and the capacity region for the DBC. Now we state a theorem which provides the relationship among  $F^*(q; s)$ ,  $(q; s)$ ,  $(q; s)$ , and the optimal transmission strategies for the DBC.

Theorem 6: i) For any  $0 \leq \lambda \leq 1$ , if a point of the graph of  $(q; s)$  is the convex combination of  $l$  points of the graph of  $(q; s)$  with arguments  $p_j$  and weights  $w_j$ ,  $j = 1, \dots, l$ , then

$$F_{T_{YX}, T_{ZX}} \sum_j w_j p_j; \sum_j w_j h_n(T_{YX} p_j) = \sum_j w_j h_m(T_{ZX} p_j): \tag{46}$$

Furthermore, for a fixed channel input distribution  $q = \sum_j^P w_j p_j$ , the optimal transmission strategy to achieve the maximum of  $R_2 + R_1$  is determined by  $w_j$  and  $p_j$ . In particular, an optimal transmission strategy has  $\forall j = 1, \dots, l, Pr(U = j) = w_j$  and  $p_{X|U=j} = p_j$ , where  $p_{X|U=j}$  denotes the conditional distribution of  $X$  given  $U = j$ .

ii) For a predetermined channel input distribution  $q$ , if the transmission strategy  $\forall j = 1, \dots, l, Pr(U = j) = w_j$  and  $p_{X|U=j} = p_j$  achieves  $\max \sum_j^P w_j p_j = qg$ , then the point  $(q; (q; s))$  is the convex combination of  $l$  points of the graph of  $(q; s)$  with arguments  $p_j$

and weights  $w_j, j = 1, \dots, l$ .

The proof is given in Appendix III.

Note that if for some pair  $(q; \lambda)$ ,  $(q; \lambda) = (q; \lambda)$ , then the corresponding optimal transmission strategy has  $l = 1$ , which means  $U$  is a constant. Thus, the line  $U = U + (q; \lambda)$  supports the graph of  $F(q; \lambda)$  at its endpoint  $(H(Y); H(Z)) = (h_n(\Gamma_{YX} q); h_m(\Gamma_{ZX} q))$ .

#### A. Example: broadcast binary-symmetric channel

For the broadcast binary-symmetric channel  $X \rightarrow Y \rightarrow Z$  with

$$T_{YX} = \begin{bmatrix} 1 & 2 \\ 1 & 1 \end{bmatrix}; T_{ZX} = \begin{bmatrix} 1 & 2 \\ 2 & 1 \end{bmatrix}; \quad (47)$$

where  $0 < \alpha < \beta < 1/2$ , one has

$$\begin{aligned} (p; \lambda) &= (p; 1-p)^T; \\ &= h_m(\Gamma_{ZX} q) - h_n(\Gamma_{YX} q) \\ &= h((1-\beta)p + \beta(1-p)) - h((1-\alpha)p + \alpha(1-p)); \end{aligned} \quad (48)$$

where  $h(x) = -x \ln x - (1-x) \ln(1-x)$  is the binary entropy function. Taking the second derivative of  $(p; \lambda)$  with respect to  $p$ , we have

$$\begin{aligned} \frac{\partial^2}{\partial p^2} (p; \lambda) &= \frac{(1-2\beta)^2}{((1-\beta)p + (1-\beta)(1-p))((1-\beta)p + \beta(1-p))} \\ &+ \frac{(1-2\alpha)^2}{((1-\alpha)p + (1-\alpha)(1-p))((1-\alpha)p + \alpha(1-p))}; \end{aligned} \quad (49)$$

which has the sign of

$$(p; \lambda) = \left( \frac{1}{1-2\alpha} - p \right) \left( \frac{1}{1-2\alpha} + p \right) + \left( \frac{1}{1-2\beta} - p \right) \left( \frac{1}{1-2\beta} + p \right); \quad (50)$$

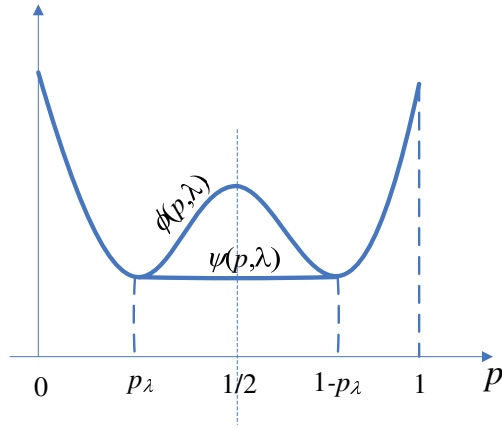

Fig. 2

For any  $0 < \lambda < 1$ ,

$$\min_p (p; \lambda) = \frac{1}{4(1 - 2\lambda)^2} \quad (51)$$

Thus, for  $(1 - 2\lambda)^2 = (1 - 2\lambda_1)^2$ ,  $\min_p (p; \lambda) = 0$  for all  $0 \leq p \leq 1$ , and so  $(p; \lambda) = (p; \lambda_1)$ . In this case, the optimal transmission strategy achieving the maximum of  $R_1$  also achieves the maximum of  $R_2 + R_1$ , and thus the optimal transmission strategy has  $l = 1$ , which means  $U$  is a constant.

Note that  $(1 - 2 + p; \lambda) = (1 - 2 - p; \lambda)$ . For  $\lambda < (1 - 2\lambda)^2 = (1 - 2\lambda_1)^2$ ,  $(p; \lambda)$  has negative second derivative on an interval symmetric about  $p = 1/2$ . Let  $p = \arg \min_p (p; \lambda)$  with  $p > 1/2$ . Thus  $p$  satisfies  $\frac{\partial}{\partial p} (p; \lambda) = 0$ .

By symmetry, the envelope  $(p; \lambda)$  is obtained by replacing  $(p; \lambda)$  on the interval  $(p; 1 - p)$  by its minimum over  $p$ , which is shown in Fig. 2. Therefore, the lower envelope of  $(p; \lambda)$  is

$$(p; \lambda) = \begin{cases} \frac{1}{4(1 - 2\lambda)^2} & \text{for } p \in [p, 1 - p] \\ (p; \lambda) & \text{otherwise} \end{cases} \quad (52)$$

For the predetermined distribution of  $X$ ,  $p_x = q = (q; 1 - q)^T$  with  $p < q < 1 - p$ ,  $(q; (q; \lambda))$  is the convex combination of the points  $(p; (p; \lambda))$  and  $(1 - p; (1 - p; \lambda))$ .

Therefore, by Theorem 6,  $F(q; s) = h_2(T_{ZX}(p; 1-p)^T) = h(\alpha + (1-\alpha_2)p)$  for  $s = h_2(T_{YX}(p; 1-p)^T) = h(\alpha_1 + (1-\alpha_2_1)p)$ , and  $0 \leq p \leq q$  or  $1-q \leq p \leq 1$ . This defines  $F(q; \cdot)$  on its entire domain  $[h(\alpha_1); h(\alpha_1 + (1-\alpha_2_1)q)]$ , i.e.,  $[H(Y|X); H(Y)]$ . For the predetermined distribution of  $X$ ,  $q = (q; 1-q)^T$  with  $q < p$  or  $q > 1-p$ , one has  $F(q; \cdot) = F(q; \cdot)$ , which means that a line with slope  $\alpha$  supports  $F(q; \cdot)$  at point  $s = H(Y) = h(\alpha_1 + (1-\alpha_2_1)q)$ , and thus the optimal transmission strategy has  $l=1$ , which means  $U$  is a constant.

## V. Broadcast Z Channels

The Z channel, shown in Fig. 3(a), is a binary asymmetric channel which is noiseless when symbol 1 is transmitted but noisy when symbol 0 is transmitted. The channel output  $Y$  is the binary OR of the channel input  $X$  and Bernoulli distributed noise with parameter  $\alpha$ . The capacity of the Z channel was studied in [20]. The Broadcast Z channel is a class of discrete memoryless broadcast channels whose component channels are Z channels. A two-user broadcast Z channel with marginal transition probability matrices

$$T_{YX} = \begin{bmatrix} \alpha & \alpha_1 & \alpha_2 \\ 0 & 1 & 1 \end{bmatrix}; T_{ZX} = \begin{bmatrix} \alpha & \alpha_2 & \alpha_1 \\ 0 & 1 & 2 \end{bmatrix}; \quad (53)$$

where  $0 < \alpha_1 < \alpha_2 < 1$ , is shown in Fig 3(b). The two-user broadcast Z channel is stochastically degraded and can be modeled as a physically degraded broadcast channel as shown in Fig. 4, where  $\alpha = (\alpha_2 - \alpha_1) = (1 - \alpha_1)$  [12]. In the NE scheme for broadcast Z channels, the transmitter first independently encodes users' information messages into binary codewords and then broadcasts the binary OR of these encoded codewords. The NE scheme achieves the whole boundary of the capacity region for the two-user broadcast Z channel [12] [13]. In this section, we will show that the NE scheme also achieves the boundary of the capacity region for multi-user broadcast Z channels.

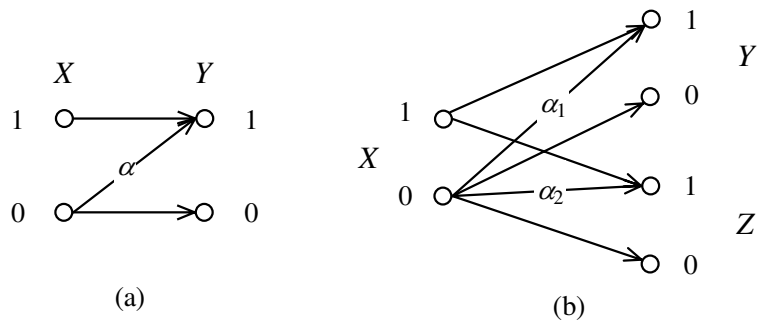

Fig. 3  
The broadcast Z channel

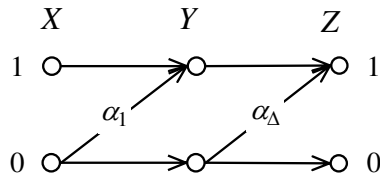

Fig. 4  
The degraded version of the broadcast Z channel

A . F for the broadcast Z channel

For the broadcast Z channel  $X \rightarrow Y \rightarrow Z$  shown in Fig. 3 (b) and Fig. 4 with

$$T_{YX} = \begin{bmatrix} 1 & \alpha_1 \\ 0 & 1 \end{bmatrix}; T_{ZX} = \begin{bmatrix} 1 & \alpha_2 \\ 0 & 1 \end{bmatrix}; \quad (54)$$

where  $0 < \alpha_1 < 1$ ,  $\alpha_2 = 1 - \alpha_1$ , and  $\alpha_\Delta = 1 - \alpha_2$ , one has

$$I(p; \alpha) = (1 - p_2)I(p; \alpha_1) + p_2 I(p; \alpha_2); \quad (55)$$

Taking the second derivative of  $I(p; \alpha)$  with respect to  $p$ , we have

$$I''(p; \alpha) = \frac{2}{(1 - p_2)p_2} - \frac{2}{(1 - p_1)p_1}; \quad (56)$$

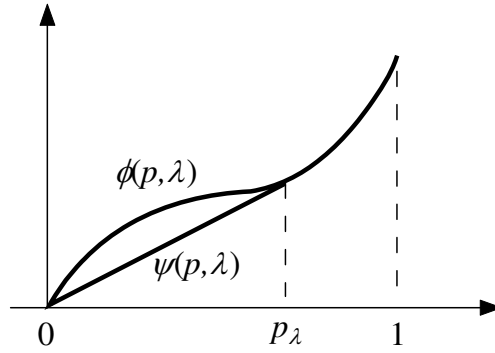

Fig. 5

Illustrations of  $(\cdot; \cdot)$  and  $(\cdot; \cdot)$  for the broadcast Z channel

which has the sign of

$$(\rho; \cdot) = p_1 \rho_2 (1 - \rho_1) + \rho_1 \rho_2 : \quad (57)$$

Let  $\rho_1 = \rho_2 = \rho$ . For the case of  $\rho > 1/2$ ,  ${}^0(\rho; \cdot) \geq 0$  for all  $0 \leq p \leq 1$ . Hence,  $(\rho; \cdot)$  is convex in  $p$  and thus  $(\rho; \cdot) = ({}^0(\rho; \cdot))$  for all  $0 \leq p \leq 1$ . In this case, the optimal transmission strategy achieving the maximum of  $R_1$  also achieves the maximum of  $R_2 + R_1$ , and the optimal transmission strategy has  $l = 1$ , i.e.,  $U$  is a constant. Note that the transmission strategy with  $l = 1$  is a special case of the NE scheme in which the only codeword for the second user is an all-ones codeword.

For the case of  $0 < \rho < 1/2$ ,  $(\rho; \cdot)$  is concave in  $p$  on  $[0; \frac{2\rho}{1-\rho}]$  and convex on  $[\frac{2\rho}{1-\rho}; 1]$ . The graph of  $(\rho; \cdot)$  in this case is shown in Fig. 5. Since  $(0; \cdot) = 0$ ,  $(\rho; \cdot)$ , the lower convex envelope of  $(\rho; \cdot)$ , is constructed by drawing the tangent through the origin. Let  $(p; (\rho; \cdot))$  be the point of contact. The value of  $p$  is determined by  ${}^0_p(\rho; \cdot) = (\rho; \cdot) = p$ , i.e.,

$$\ln(1 - \rho p) = \ln(1 - \rho p) : \quad (58)$$

Let  $q = (1 - q; q)^T$  be the distribution of the channel input  $X$ . For  $q \leq p$ ,  $(q; \cdot)$  is

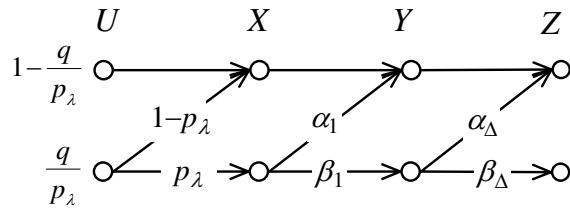

Fig. 6

The optimal transmission strategy for the two-user broadcast Z channel

obtained as a convex combination of points  $(0; 0)$  and  $(p; (p; ))$  with weights  $(p - q)=p$  and  $q=p$ . By Theorem 6, it corresponds to  $s = [(p - q)=p]0 + [q=p]h(1-p) = qh(1-p)=p$  and  $F(q; s) = q=p h(2p)$ . Hence, for the broadcast Z channel,

$$F_{T_{YX}, T_{ZX}}(q; qh(1-p)=p) = qh(2p)=p \quad (59)$$

for  $p \in [q; 1]$ , which defines  $F_{T_{YX}, T_{ZX}}(q; )$  on its entire domain  $[qh(1); h(q-1)]$ . Also by Theorem 6, the optimal transmission strategy  $U \rightarrow X$  achieving  $\max R_2 + R_1 \sum_{j=1}^P w_j p_j = qg$  is determined by  $l=2, w_1 = (p - q)=p, w_2 = q=p, p_1 = (1; 0)^T$  and  $p_2 = (1 - p; p)^T$ . Since the optimal transmission strategy  $U \rightarrow X$  is a Z channel as shown in Fig. 6, the random variable  $X$  could also be constructed as the OR operation of two Bernoulli random variables with parameters  $(p - q)=p$  and  $1 - p$  respectively. Hence, the optimal transmission strategy for the broadcast Z channel is still the NE scheme in this case. For  $q > p$ ,  $(q; ) = (q; )$  and so the optimal transmission strategy has  $l=1$ , i.e.,  $U$  is a constant. Therefore, we provide an alternative proof to show that the NE scheme achieves the whole boundary of the two-user broadcast Z channel.

### B. Multi-user broadcast Z channel

Let  $X = (X_1; \dots; X_N)$  be a sequence of channel inputs to the broadcast Z channel  $X \rightarrow Y \rightarrow Z$  satisfying (54). The corresponding channel outputs are  $Y = (Y_1; \dots; Y_N)$  and  $Z = (Z_1; \dots; Z_N)$ . Thus, the sequence of the channel outputs  $(Y_i; Z_i), i = 1; \dots; N$ ,



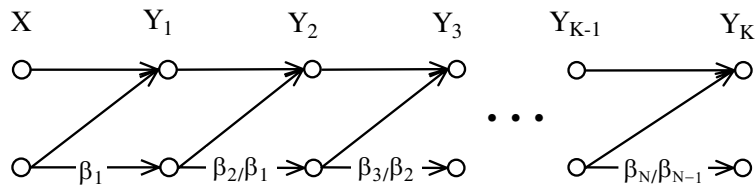

Fig. 7  
The K-user broadcast Z channel

are conditionally independent with each other given the channel inputs  $X$ . Note that the channel outputs  $(Y_i; Z_i)$  do not have to be identically or independently distributed since  $X_1; \dots; X_N$  could be correlated and have different distributions.

Lemma 5: Consider the Markov chain  $U \rightarrow X \rightarrow Y \rightarrow Z$  with  $\Pr(X_i = 0) = \frac{q}{p}$ , if

$$H(Y|X) \geq N \frac{q}{p} h\left(\frac{q}{p}\right); \quad (60)$$

for some  $p \in [q, 1]$ , then

$$H(Z|X) \geq N \frac{q}{p} h\left(\frac{q}{p}\right) \quad (61)$$

$$= N \frac{q}{p} h\left(\frac{q}{p}\right); \quad (62)$$

The proof is given in Appendix IV.

Consider a K-user broadcast Z channel with marginal transition probability matrices

$$T_{Y_j X} = \begin{bmatrix} 2 & 3 \\ 4 & 5 \\ 0 & j \end{bmatrix}; \quad (63)$$

where  $0 < \alpha_1 < \dots < \alpha_K < 1$ , and  $j = 1 - \alpha_j$  for  $j = 1; \dots; K$ . The K-user broadcast Z channel is stochastically degraded and can be modeled as a physically DBC as shown in Fig. 7. The NE scheme for the K-user broadcast Z channel is to independently encode the K users' information messages into K binary codewords and broadcast the binary OR of these

$K$  encoded codewords. The  $j^{\text{th}}$  user then successively decodes the messages for User  $K$ , User  $K-1$ , ..., and finally for User  $j$ . The codebook for the  $j^{\text{th}}$  user is designed by random coding technique according to the binary random variable  $X^{(j)}$  with  $\Pr\{X^{(j)} = 0\} = q^{(j)}$ . Denote  $X^{(i)} \oplus X^{(j)}$  as the OR of  $X^{(i)}$  and  $X^{(j)}$ . Hence, the channel input  $X$  is the OR of  $X^{(j)}$  for all  $1 \leq j \leq K$ , i.e.,  $X = X^{(1)} \oplus \dots \oplus X^{(K)}$ . From the coding theorem for DBCs [2] [3], the achievable region of the NE scheme for the  $K$ -user broadcast Z channel is determined by

$$R_j \leq I(Y_j; X^{(j)} | X^{(j+1)}); \quad (64)$$

$$= H(Y_j | X^{(j+1)}; X) - H(Y_j | X^{(j)}; X^{(j+1)}; X) \quad (65)$$

$$= \sum_{i=j+1}^K q^{(i)} h(j, q^{(i)}) - \sum_{i=j}^K q^{(i)} h(j, q^{(i)}) \quad (66)$$

$$= \frac{q}{t_j} h(j, t_j) - \frac{q}{t_{j-1}} h(j, t_{j-1}) \quad (67)$$

where  $t_j = \prod_{i=1}^j q^{(i)}$  for  $j = 1, \dots, K$ , and  $q = \Pr\{X = 0\} = \prod_{i=1}^K q^{(i)}$ . Denote  $t_0 = 1$ . Since  $0 < q^{(1)} < \dots < q^{(K)} < 1$ , one has

$$1 = t_0 - t_1 + t_1 - t_2 + \dots + t_{K-1} - t_K + t_K = \sum_{j=1}^K (t_{j-1} - t_j) q^{(j)} \quad (68)$$

We now state and prove that the achievable region of the NE scheme is the capacity region for the multi-user broadcast Z channel. Fig. 8 shows the communication system for the  $K$ -user broadcast Z channel.  $X = (X_1, \dots, X_N)$  is a length- $N$  codeword determined by the messages  $W_1, \dots, W_K$ .  $Y_1, \dots, Y_K$  are the channel outputs corresponding to the channel input  $X$ .

**Theorem 7:** If  $\sum_{i=1}^K \Pr\{X_i = 0\} = Nq = 1$ , then no point  $(R_1, \dots, R_K)$  such that

$$\begin{aligned} R_j &\leq \frac{q}{t_j} h(j, t_j) - \frac{q}{t_{j-1}} h(j, t_{j-1}); \quad j = 1, \dots, K \\ R_d &\leq \frac{q}{t_d} h(d, t_d) - \frac{q}{t_{d-1}} h(d, t_{d-1}) + \epsilon; \quad \text{for some } d \in \{1, \dots, K\}; \quad \epsilon > 0 \end{aligned} \quad (69)$$

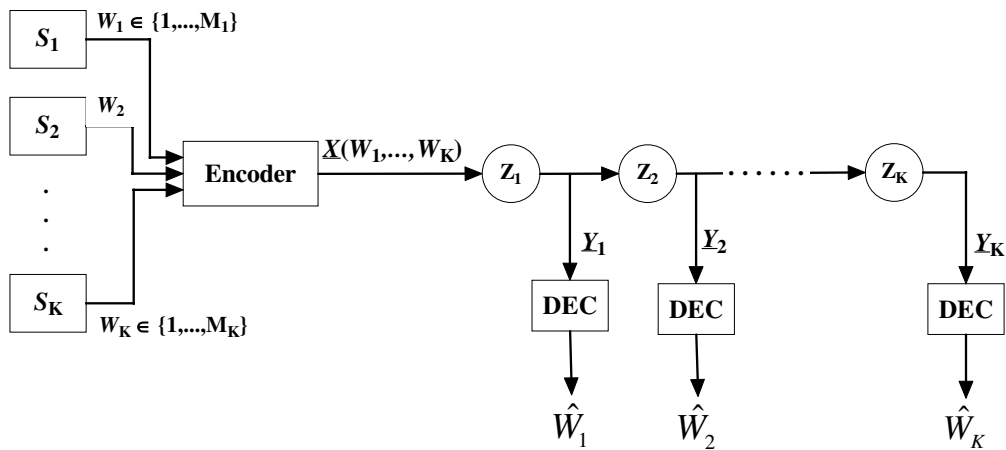

Fig. 8

The communication system for the multi-user broadcast Z channel

is achievable, where the  $t_j$  are as in (67) and (68).

Proof (by contradiction): This proof borrows the idea of proving the converse of the coding theorem for broadcast Gaussian channels [2]. Lemma 5 plays the same role in this proof as the entropy power inequality does in the proof for broadcast Gaussian channels.

We suppose that the rates of (69) are achievable, which means that the probability of decoding error for each receiver can be upper bounded by an arbitrarily small  $\epsilon$  for sufficiently large  $N$

$$\Pr\{\hat{W}_j \notin \mathcal{W}_j | Y_j\} < \epsilon; \quad j = 1, \dots, K \quad (70)$$

By Fano's inequality, this implies that

$$H(W_j | Y_j) \leq h(\epsilon) + \ln(M_j - 1); \quad j = 1, \dots, K \quad (71)$$

Let  $o(\cdot)$  represent any function of  $\epsilon$  such that  $o(\epsilon) \rightarrow 0$  and  $o(\epsilon) \neq 0$  as  $\epsilon \rightarrow 0$ . Equation (71) implies that  $H(W_j; Y_j), j = 1; \dots; K$ , are all  $o(\epsilon)$ . Therefore,

$$H(W_j) = H(W_j; W_{j+1}; \dots; W_K) \quad (72)$$

$$= I(W_j; Y_j; W_{j+1}; \dots; W_K) + H(W_j; Y_j; W_{j+1}; \dots; W_K) \quad (73)$$

$$= I(W_j; Y_j; W_{j+1}; \dots; W_K) + H(W_j; Y_j) \quad (74)$$

$$= H(Y_j; W_{j+1}; \dots; W_K) + H(Y_j; W_j; W_{j+1}; \dots; W_K) + o(\epsilon); \quad (75)$$

where (72) follows from the independence of the  $W_j, j = 1; \dots; K$ . From (75) and the fact that  $N R_j = H(W_j)$ ,

$$H(Y_j; W_{j+1}; \dots; W_K) + H(Y_j; W_j; W_{j+1}; \dots; W_K) = N \frac{q}{t_j} h(\frac{q}{t_j}) + N \frac{q}{t_{j-1}} h(\frac{q}{t_{j-1}}) + o(\epsilon); \quad (76)$$

Next, using Lemma 5 and (76), we show in the Appendix V that

$$H(Y_K) = N h(\frac{q}{t_K}) + N o(\epsilon); \quad (77)$$

where  $q = t_K = \prod_{i=1}^K \Pr(X_i = 0) = \epsilon^N$ . Since  $\epsilon$  can be arbitrarily small for sufficiently large  $N$ ,  $o(\epsilon) \neq 0$  as  $N \rightarrow \infty$ . For sufficiently large  $N$ ,  $H(Y_K) = N h(\frac{q}{t_K}) + N o(\epsilon) = 2$ . However, it contradicts

$$H(Y_K) = \sum_{i=1}^K H(Y_{K,i}) \quad (78)$$

$$= \sum_{i=1}^K h(\frac{q}{t_K} \Pr(X_i = 0)) \quad (79)$$

$$= N h(\frac{q}{t_K} \prod_{i=1}^K \Pr(X_i = 0) = \epsilon^N) \quad (80)$$

$$= N h(\frac{q}{t_K} \epsilon): \quad (81)$$

Some of these steps are justified as follows:

(78) follows from  $Y_K = (Y_{K,1}; \dots; Y_{K,N})$ ;

(80) is obtained by applying Jensen's inequality to the concave function  $h(\cdot)$ ;

(81) follows from  $q = \frac{1}{N} \sum_{i=1}^N \Pr(X_i = 0)$ .

The desired contradiction has been obtained, so the theorem is proved.

## V I. Input-Symmetric Degraded Broadcast Channels

The input-symmetric channel was first introduced in [10] and studied further in [16] [17] [18]. The definition of the input-symmetric channel is as follows: Let  $\mathcal{S}_n$  denote the symmetric group of permutations of  $n$  objects by the  $n \times n$  permutation matrices. An  $n$ -input  $m$ -output channel with transition probability matrix  $T_{m \times n}$  is input-symmetric if the set

$$G_T = \{G \in \mathcal{S}_n \times \mathcal{S}_m; \text{ s.t. } TG = Tg\} \quad (82)$$

is transitive, which means each element of  $\mathcal{S}_n \times \mathcal{S}_m$  can be mapped to every other element of  $\mathcal{S}_n \times \mathcal{S}_m$  by some permutation matrix in  $G_T$ . An important property of input-symmetric channel is that the uniform distribution achieves capacity.

Extend the definition of the input-symmetric channel to the input-symmetric DBC as follows:

**Definition 2: Input-Symmetric Degraded Broadcast Channel:** A discrete memoryless DBC  $X \rightarrow Y \rightarrow Z$  with  $|X| = k$ ,  $|Y| = n$  and  $|Z| = m$  is input-symmetric if the set

$$G_{T_{YX}, T_{ZX}} = G_{T_{YX}} \setminus G_{T_{ZX}} \quad (83)$$

$$= \{G \in \mathcal{S}_k \times \mathcal{S}_n \times \mathcal{S}_m; \text{ s.t. } T_{YX}G = G_{YX}T_{YX}; T_{ZX}G = G_{ZX}T_{ZX}\} \quad (84)$$

is transitive.

**Lemma 6:**  $G_{T_{YX}, T_{ZX}}$  is a group under matrix multiplication.

Proof: Every closed subset of a group is a group. Since  $G_{T_{YX}, T_{ZX}}$  is a subset of  $k$ , which is a group under matrix multiplication, it suffices to show that  $G_{T_{YX}, T_{ZX}}$  is closed under matrix multiplication. Suppose  $G_1, G_2 \in G_{T_{YX}, T_{ZX}}$  such that  $T_{YX} G_1 = \gamma_{YX,1} T_{YX}$ ,  $T_{ZX} G_1 = \gamma_{ZX,1} T_{ZX}$ ,  $T_{YX} G_2 = \gamma_{YX,2} T_{YX}$  and  $T_{ZX} G_2 = \gamma_{ZX,2} T_{ZX}$ . Thus,

$$T_{YX} G_1 G_2 = \gamma_{YX,1} \gamma_{YX,2} T_{YX}; \quad (85)$$

and

$$T_{ZX} G_1 G_2 = \gamma_{ZX,1} \gamma_{ZX,2} T_{ZX}; \quad (86)$$

Therefore,  $G_1 G_2 \in G_{T_{YX}, T_{ZX}}$ . Q.E.D.

Let  $I = \{G_{T_{YX}, T_{ZX}}\}$  and  $G_{T_{YX}, T_{ZX}} = \bigcup_{i=1}^k G_i$ .

Lemma 7:  $\sum_{i=1}^k G_i = \frac{1}{k} \mathbf{1} \mathbf{1}^T$ , where  $\frac{1}{k}$  is an integer and  $\mathbf{1}$  is an all-ones vector.

Proof: Since  $G_{T_{YX}, T_{ZX}}$  is a group, for all  $j = 1, \dots, k$ ,

$$G_j \sum_{i=1}^k G_i = \sum_{i=1}^k G_j G_i = \sum_{i=1}^k G_i; \quad (87)$$

Hence,  $\sum_{i=1}^k G_i$  has  $k$  identical columns and  $k$  identical rows since  $G_{T_{YX}, T_{ZX}}$  is transitive.

Therefore,  $\sum_{i=1}^k G_i = \frac{1}{k} \mathbf{1} \mathbf{1}^T$ . Q.E.D.

Definition 3: A subset of  $G_{T_{YX}, T_{ZX}} : \bigcup_{i=1}^{l_s} G_i$  is a smallest transitive subset of  $G_{T_{YX}, T_{ZX}}$  if

$$\sum_{j=1}^{l_s} G_{i_j} = \frac{1}{k} \mathbf{1} \mathbf{1}^T; \quad (88)$$

where  $\frac{1}{k}$  is the smallest possible integer for which (88) is satisfied.

#### A. Examples: broadcast binary-symmetric channels and broadcast binary-erasure channels

The class of input-symmetric DBCs includes most of the common discrete memoryless DBCs. For example, the broadcast binary-symmetric channel  $X \rightarrow Y \rightarrow Z$  with marginal

transition probability matrices

$$T_{YX} = \begin{matrix} & 2 & & 3 \\ 4 & 1 & 1 & 5 \\ & 1 & 1 & 1 \end{matrix} \text{ and } T_{ZX} = \begin{matrix} & 2 & & 3 \\ 4 & 1 & 2 & 5 \\ & 2 & 1 & 2 \end{matrix};$$

where  $0 \leq a_1 \leq a_2 \leq 1$ , is input-symmetric since

$$G_{T_{YX}; T_{ZX}} = \begin{matrix} 8 & 2 & 3 & 2 & 3 & 9 \\ & 4 & 1 & 0 & 5 & 4 \\ & & & & & 0 \\ & & & & & 1 \\ & & & & & 5 \\ & & & & & 0 \end{matrix}; \quad (89)$$

is transitive.

Another interesting example is the broadcast binary-erasure channel with marginal transition probability matrices

$$T_{YX} = \begin{matrix} & 2 & & 3 \\ 6 & 1 & a_1 & 0 \\ 6 & & & 7 \\ 6 & a_1 & & a_1 \\ 4 & & & 5 \\ & 0 & 1 & a_1 \end{matrix} \text{ and } T_{ZX} = \begin{matrix} & 2 & & 3 \\ 6 & 1 & a_2 & 0 \\ 6 & & & 7 \\ 6 & a_2 & & a_2 \\ 4 & & & 5 \\ & 0 & 1 & a_2 \end{matrix};$$

where  $0 \leq a_1 \leq a_2 \leq 1$ . It is input-symmetric since its  $G_{T_{YX}; T_{ZX}}$  is the same as that of the broadcast binary-symmetric channel shown in (89).

### B. Example: group-additive DBC

**Definition 4:** Group-additive degraded Broadcast Channel: A degraded broadcast channel  $X \rightarrow Y \rightarrow Z$  with  $X, Y, Z \in \mathbb{F}_2^n$ ;  $\mathbb{F}_2^n$  is a group-additive degraded broadcast channel if there exist two  $n$ -ary random variables  $N_1$  and  $N_2$  such that  $Y = X \oplus N_1$  and  $Z = Y \oplus N_2$  as shown in Fig. 9, where  $\stackrel{d}{=}$  denotes identical distribution and  $\oplus$  denotes group addition.

The class of group-additive DBCs includes the broadcast binary-symmetric channel and the discrete additive DBC [1] as special cases.

**Theorem 8:** Group-additive DBCs are input-symmetric.

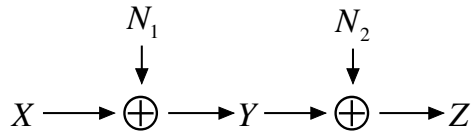

Fig. 9

The group-additive degraded broadcast channel.

Proof: For the group-additive DBC  $X \rightarrow Y \rightarrow Z$  with  $X, Y, Z \in \mathbb{F}_q^n$ , let  $\{G_x\}_{x \in \mathbb{F}_q^n}$  be  $n \times n$  matrices with entries

$$G_x(i; j) = \begin{cases} 1 & \text{if } j = x + i \\ 0 & \text{otherwise} \end{cases} \quad \text{for } i, j = 1, \dots, n \quad (90)$$

$G_x$  for  $x \in \mathbb{F}_q^n$ , are actually permutation matrices and have the property that  $G_{x_1} G_{x_2} = G_{x_2} G_{x_1} = G_{x_1 + x_2}$ . Let  $(p; \pi_1)^T$  be the distribution of  $N_1$ . Since  $Y$  has the same distribution as  $X + N_1$ , one has

$$T_{YX} = \sum_{x \in \mathbb{F}_q^n} p_x G_x \quad (91)$$

Hence,  $T_{YX} G_x = G_x T_{YX}$  for all  $x \in \mathbb{F}_q^n$ . Similarly, we have  $T_{ZX} = G_x T_{ZX}$  for all  $x \in \mathbb{F}_q^n$ , and so

$$\mathcal{G} = \{G_x\}_{x \in \mathbb{F}_q^n} \quad (92)$$

Since the set  $\mathcal{G}$  is transitive by definition,  $\mathcal{G}_{T_{YX}, T_{ZX}}$  is also transitive and hence the group-additive degraded broadcast channel is input-symmetric. Q.E.D.

By definition,  $\sum_{j=1}^n G_j = 11^T$ , and hence,  $\mathcal{G}$  is a smallest transitive subset of  $\mathcal{G}_{T_{YX}, T_{ZX}}$  for the group-additive DBC.



C . Exam ple: IS-DBC not covered in [16] [17]

The class of DDICs and the corresponding DBCs studied in [16] [17] have to satisfy the condition that the transition probability matrix  $T_{ZY}$  is input-symmetric, i.e.,  $G_{T_{ZY}}$  is transitive. The input-symmetric DBC, however, does not have to satisfy this condition. The following example provides an IS-DBC which is not covered in [16] [17]. Consider a DBC  $X \rightarrow Y \rightarrow Z$  with transition probability matrices

$$T_{YX} = \begin{matrix} & \begin{matrix} 2 & 3 \end{matrix} \\ \begin{matrix} a \\ b \\ c \\ d \end{matrix} & \begin{matrix} c \\ d \\ a \\ b \end{matrix} \\ \begin{matrix} 4 \\ 5 \end{matrix} & \end{matrix}; T_{ZY} = \begin{matrix} & \begin{matrix} 2 & 3 \end{matrix} \\ \begin{matrix} e \\ f \\ g \\ h \end{matrix} & \begin{matrix} h \\ e \\ f \\ g \end{matrix} \\ \begin{matrix} 5 \\ 4 \end{matrix} & \end{matrix};$$

and

$$T_{ZX} = T_{ZY} T_{YX} = \begin{matrix} & \begin{matrix} 2 & 3 \end{matrix} \\ \begin{matrix} 4 \\ 5 \end{matrix} & \begin{matrix} 5 \\ 4 \end{matrix} \end{matrix}; \quad (93)$$

where  $a + c = b + d = 1, e + f + g + h = 1, \alpha = ae + bf + cg + dh$  and  $\beta = ag + bh + ce + df$ .

This DBC is input-symmetric since its  $G_{T_{YX}, T_{ZX}}$  is the same as that of the broadcast binary-symmetric channel shown in (89). It is not covered in [16] [17] because

$$G_{T_{ZY}} = \begin{matrix} & \begin{matrix} 8 & 2 & & & 3 & 2 & & & 3 & 9 \end{matrix} \\ \begin{matrix} \uparrow \\ \downarrow \\ \leftarrow \\ \rightarrow \\ \bullet \end{matrix} & \begin{matrix} 1 & 0 & 0 & 0 \\ 0 & 1 & 0 & 0 \\ 0 & 0 & 1 & 0 \\ 0 & 0 & 0 & 1 \end{matrix} & \begin{matrix} \uparrow \\ \downarrow \\ \leftarrow \\ \rightarrow \\ \bullet \end{matrix} & \begin{matrix} 0 & 0 & 1 & 0 \\ 0 & 0 & 0 & 1 \\ 1 & 0 & 0 & 0 \\ 0 & 1 & 0 & 0 \end{matrix} & \begin{matrix} \uparrow \\ \downarrow \\ \leftarrow \\ \rightarrow \\ \bullet \end{matrix} \\ \begin{matrix} 4 \\ 5 \end{matrix} & & \begin{matrix} 4 \\ 5 \end{matrix} & & \begin{matrix} 5 \\ 4 \end{matrix} & & \begin{matrix} 5 \\ 4 \end{matrix} \end{matrix}; \quad (94)$$

is not transitive.

D. Optimal input distribution and capacity region

Consider the input-symmetric DBC  $X \rightarrow Y \rightarrow Z$  with the marginal transition probability matrices  $T_{YX}$  and  $T_{ZX}$ . Recall that the set  $C$  is the set of all  $(p; \lambda)$  satisfying  $\theta$ ) (10) and (11) for some choice of  $l, w$  and  $p_j, j = 1; \dots; l$ , the set  $C_q = \{ (p; \lambda) \in C \mid p = q \}$  is the projection of the set  $C$  on the  $(p; \lambda)$ -plane, and the set  $C_q = \{ (p; \lambda) \in C \mid p = q \}$  is the projection on the  $(p; \lambda)$ -plane of the intersection of  $C$  with the two-dimensional plane  $p = q$ .

Lemma 8: For any permutation matrix  $G \in \mathbb{R}^{l \times l}$  and  $(p; \lambda) \in C$ , one has  $(Gp; \lambda) \in C$ .

Proof: Since  $(p; \lambda)$  satisfying  $\theta$ ) (10) and (11) for some choice of  $l, w$  and  $p_j$ ,

$$\sum_{j=1}^l w_j G p_j = G p \tag{95}$$

$$\sum_{j=1}^l w_j h_n(T_{YX} G p_j) = \sum_{j=1}^l w_j h_n(T_{YX} p_j) \tag{96}$$

$$\sum_{j=1}^l w_j h_m(T_{ZX} G p_j) = \sum_{j=1}^l w_j h_m(T_{ZX} p_j) \tag{97}$$

Hence,  $(Gp; \lambda)$  satisfying  $\theta$ ) (10) and (11) for the choice of  $l, w$  and  $G p_j, j = 1; \dots; l$ . Q.E.D.

Corollary 1: If  $G \in \mathbb{R}^{l \times l}$  and  $G \in \mathbb{R}^{l \times l}$ , one has  $C_{Gp} = C_p$ , and so  $F(Gp; s) = F(p; s)$  for any  $H(Y; X) = s = H(Y)$ .

Lemma 9: For any input-symmetric DBC,  $C = C_u$ , where  $u$  denotes the uniform distribution.

Proof: For any  $(p; \lambda) \in C$ , there exists a distribution  $p$  such that  $(p; \lambda) \in C$ . Let  $G_{T_{YX}, T_{ZX}} = \{G_j\}_{j=1}^l$ . By Corollary 1,  $(G_j p; \lambda) \in C$  for all  $j = 1; \dots; l$ . By the convexity of the set  $C$ ,

$$(q; \lambda) = \left( \sum_{j=1}^l G_j p; \lambda \right) \in C \tag{98}$$

where  $q = \prod_{j=1}^P G_{jp}$ . Since  $G_{T_{YX}, T_{ZX}}$  is a group, for any permutation matrix  $G^0 \in G_{T_{YX}, T_{ZX}}$ ,

$$G^0 q = \prod_{j=1}^{X^1} G^0 G_{jp} = \prod_{j=1}^{X^1} G_{jp} = q \quad (99)$$

Since  $G^0 q = q$ , the  $i^{\text{th}}$  entry and the  $j^{\text{th}}$  entry of  $q$  are the same if  $G^0$  permutes the  $i^{\text{th}}$  row to the  $j^{\text{th}}$  row. Since the set  $G_{T_{YX}, T_{ZX}}$  for an input-symmetric DBC is transitive, all the entries of  $q$  are the same, and so  $q = u$ . This implies that  $(; ) \in C_u$ . Since  $(; )$  is arbitrarily taken from  $C$ , one has  $C \subseteq C_u$ . On the other hand, by definition,  $C \subseteq C_u$ . Therefore,  $C = C_u$ . Q.E.D.

Now we state and prove that the uniformly distributed  $X$  is optimal for input-symmetric DBCs.

**Theorem 9:** For any input-symmetric DBC, its capacity region can be achieved by using the transmission strategies such that the broadcast signal  $X$  is uniformly distributed. As a consequence, the capacity region is

$$\text{co} \{ (R_1; R_2) : R_1 \leq h_n(T_{YX} e_1); R_2 \leq h_m(T_{ZX} u) \mid F_{T_{YX}, T_{ZX}}(u; s); h_n(T_{YX} e_1) \leq \ln(n) \} \quad (100)$$

where  $e_1 = (1; 0; \dots; 0)^T$ ,  $h = \sum_j h_j$ , and  $m = \sum_j j$ .

**Proof:** Let  $q = (q_1; \dots; q_k)^T$  be the distribution of the channel input  $X$  for the input-symmetric DBC  $X \rightarrow Y \rightarrow Z$ . Since  $G_{T_{YX}}$  is transitive, the columns of  $T_{YX}$  are permutations

of each other.

$$H(Y; X) = \sum_{i=1}^{X^k} H(Y; X = i) \quad (101)$$

$$= \sum_{i=1}^{X^k} q_i h_n(T_{YX} e_i) \quad (102)$$

$$= \sum_{i=1}^{X^k} q_i h_n(T_{YX} e_1) \quad (103)$$

$$= h_n(T_{YX} e_1); \quad (104)$$

which is independent of  $q$ . Let  $l = \mathcal{G}_{T_{YX}; T_{ZX}}$  and  $G_{T_{YX}; T_{ZX}} = fG_1; \quad \mathcal{G}G$

$$H(Z) = h_m(T_{ZX} q) \quad (105)$$

$$= h_m(T_{ZX} q) \quad (106)$$

$$= \frac{1}{l} \sum_{i=1}^{X^1} h_m(T_{ZX} G_i q) \quad (107)$$

$$h_m(T_{ZX} \frac{1}{l} \sum_{i=1}^{X^1} G_i q) \quad (108)$$

$$= h_m(T_{ZX} u); \quad (109)$$

where (108) follows from Jensen's inequality. Since  $C = C_u$  for the input-symmetric DBC,

$$F(q; s) = F(u; s); \quad (110)$$

Plugging (104), (109) and (110) into (7), the expression of the capacity region for the DBC, the capacity region for input-symmetric DBCs is

$$\infty^4 \int_{P_X = q^{2-k}}^2 (R_1; R_2) : R_1 \leq H(Y|X); R_2 \leq H(Z) - F_{T_{YX}, T_{ZX}}(q; s) \quad (111)$$

$$\infty^4 \int_{P_X = q^{2-k}}^2 (R_1; R_2) : R_1 \leq h_n(T_{YX} e_1); R_2 \leq h_m(T_{ZX} u) - F_{T_{YX}, T_{ZX}}(u; s) \quad (112)$$

$$= \infty (R_1; R_2) : R_1 \leq h_n(T_{YX} e_1); R_2 \leq h_m(T_{ZX} u) - F_{T_{YX}, T_{ZX}}(u; s) \quad (113)$$

$$= \infty^2 (R_1; R_2) : p_X = u; R_1 \leq H(Y|X); R_2 \leq H(Z) - F_{T_{YX}, T_{ZX}}(u; s) \quad (114)$$

$$\infty^4 \int_{P_X = q^{2-k}}^2 (R_1; R_2) : R_1 \leq H(Y|X); R_2 \leq H(Z) - F_{T_{YX}, T_{ZX}}(q; s) \quad (115)$$

Note that (111) and (115) are identical expressions, hence (111 - 115) are all equal. Therefore, (100) and (113) express the capacity region for the input-symmetric DBC, which also means that the capacity region can be achieved by using transmission strategies where the broadcast signal  $X$  is uniformly distributed. Q.E.D.

### E. Permutation encoding approach and its optimality

The permutation encoding approach is an independent-encoding scheme which achieves the capacity region for input-symmetric DBCs. The block diagram of this approach is shown in Fig. 10. In Fig. 10,  $W_1$  is the message for User 1, which sees the better channel  $T_{YX}$ , and  $W_2$  is the message for User 2, which sees the worse channel  $T_{ZX}$ . The permutation encoding approach is first to independently encode these two messages into two codewords  $X_1$  and  $X_2$ , and then to combine these two independent codewords using a single-letter operation.

Let  $G_s$  be a smallest transitive subset of  $G_{T_{YX}, T_{ZX}}$ . Denote  $k = |G_s|$  and  $l_s = |G_s^c|$ . Use a random coding technique to design the codebook for User 1 according to the  $k$ -ary random

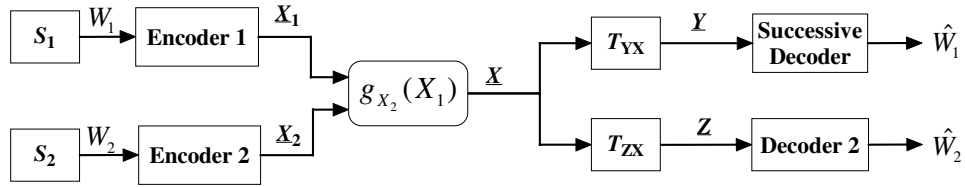

Fig. 10

The block diagram of the permutation encoding approach

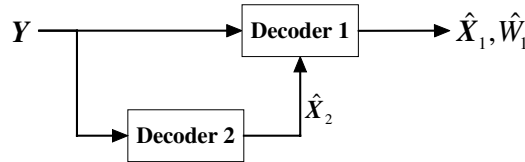

Fig. 11

The structure of the successive decoder for input-symmetric DBCs

variable  $X_1$  with distribution  $p_1$  and the codebook for User 2 according to the  $k$ -ary random variable  $X_2$  with uniform distribution. Let  $G_s = [G_1; \dots; G_k]$ . Define the permutation function  $g_{x_2}(x_1) = x$  if the permutation matrix  $G_{x_2}$  maps the  $x_1^{\text{th}}$  column to the  $x^{\text{th}}$  column, where  $x_2 \in \{1, \dots, k\}$  and  $x \in \{1, \dots, k\}$ . Hence,  $g_{x_2}(x_1) = x$  if and only if the  $x_1^{\text{th}}$  row,  $x^{\text{th}}$  column entry of  $G_{x_2}$  is 1. The permutation encoding approach is then to broadcast  $X$  which is obtained by applying the single-letter permutation function  $X = g_{X_2}(X_1)$  on symbols of codewords  $X_1$  and  $X_2$ . Since  $X_2$  is uniformly distributed and  $\sum_{j=1}^k G_j = \frac{1}{k} \mathbf{1}\mathbf{1}^T$ , the broadcast signal  $X$  is also uniformly distributed.

User 2 receives  $Z$  and decodes the desired message directly. User 1 receives  $Y$  and successively decodes the message for User 2 and then for User 1. The structure of the successive decoder is shown in Fig. 11. Note that Decoder 1 in Fig. 11 is not a joint decoder even though it has two inputs  $Y$  and  $\hat{X}_2$ .

In particular, for the group-additive DBC with  $Y = X \oplus N_1$  and  $Z = Y \oplus N_2$ , the permutation function  $g_{x_2}(x_1)$  is the group addition  $x_2 \oplus x_1$ . Hence the permutation encoding approach for the group-additive DBC is the NE scheme for the group-additive DBC. The

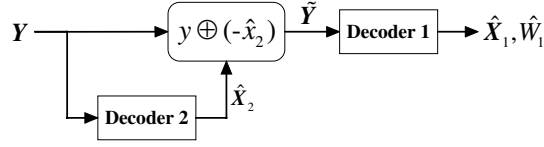

Fig. 12

The structure of the successive decoder for degraded group-addition channels

successive decoder for the group-additive DBC is shown in Fig. 12, where

$$\tilde{y} = y \oplus (-\hat{x}_2); \quad (116)$$

From the coding theorem for DBCs [2] [3], the achievable region of the permutation encoding approach for the input-symmetric DBC is determined by

$$R_1 = I(X; Y | X_2) \quad (117)$$

$$= H(Y | X_2) - H(Y | X) \quad (118)$$

$$= \sum_{x_2=1}^{X^k} \Pr(X_2 = x_2) H(Y | X_2 = x_2) - \sum_{x=1}^{X^k} \Pr(X = x) H(Y | X = x) \quad (119)$$

$$= \sum_{x_2=1}^{X^k} \Pr(X_2 = x_2) h_n(T_{Y X} G_{x_2} p_1) - \sum_{x=1}^{X^k} \Pr(X = x) h_n(T_{Y X} e_x) \quad (120)$$

$$= \sum_{x_2=1}^{X^k} \Pr(X_2 = x_2) h_n(T_{Y X} p_1) - \sum_{x=1}^{X^k} \Pr(X = x) h_n(T_{Y X} e_1) \quad (121)$$

$$= h_n(T_{Y X} p_1) - h_n(T_{Y X} e_1); \quad (122)$$

and

$$R_2 = I(X_2; Z) \tag{123}$$

$$= H(Z) - H(Z|X_2) \tag{124}$$

$$= h_m(T_{ZX} u) - \sum_{x_2=1}^{X^1} \Pr(X_2 = x_2) h_m(T_{ZX} G_{x_2} p_1) \tag{125}$$

$$= h_m(T_{ZX} u) - \sum_{x_2=1}^{X^1} \Pr(X_2 = x_2) h_m(T_{ZX} T_{ZX} p_1) \tag{126}$$

$$= h_m(T_{ZX} u) - h_m(T_{ZX} p_1); \tag{127}$$

$$\tag{128}$$

where  $u$  is the  $k$ -ary uniform distribution,  $p_1$  is the distribution of  $X_1$ , and  $e_x$  is a 0-1 vector such that the  $x^{\text{th}}$  entry is 1 and all other entries are 0. Hence, the achievable region is

$$\text{conv}_{p_1 \in \mathcal{P}_k} \left[ \left( R_1 = h_n(T_{YX} p_1) - h_n(T_{YX} e_1); R_2 = h_m(T_{ZX} u) - h_m(T_{ZX} p_1) \right) \right] \tag{129}$$

Define  $F^*(s)$  as the minimum of  $h_m(T_{ZX} p_1)$  with respect to all distributions  $p_1$  such that  $h_n(T_{YX} p_1) = s$ . Hence the achievable region (129) can be expressed as

$$\text{conv}_{p_1 \in \mathcal{P}_k} \left[ \left( R_1 = s - h_n(T_{YX} e_1); R_2 = h_m(T_{ZX} u) - \underline{\text{env}} F^*(s); h_n(T_{YX} e_1) \leq s \leq h_n(T_{YX} u) \right) \right]; \tag{130}$$

where  $\underline{\text{env}} F^*(s)$  denotes the lower convex envelope of  $F^*(s)$ . In order to show that the achievable region (130) is the same as the capacity region (100) for the input-symmetric DBC, it suffices to show that

$$\underline{\text{env}} F^*(s) = F^*(u; s) \tag{131}$$



For any  $U \rightarrow X$  with uniformly distributed  $X$ ,

$$H(Z|J) = \sum_U \Pr(U = u) H(Z|J = u) \quad (132)$$

$$= \sum_U \Pr(U = u) h_m(T_{ZX} p_{X|J=u}) \quad (133)$$

$$= \sum_U \Pr(U = u) F^*(h_n(T_{YX} p_{X|J=u})) \quad (134)$$

$$= \sum_U \Pr(U = u) \underline{\text{env}} F^*(h_n(T_{YX} p_{X|J=u})) \quad (135)$$

$$\underline{\text{env}} F^*\left(\sum_U \Pr(U = u) h_n(T_{YX} p_{X|J=u})\right) \quad (136)$$

$$= \underline{\text{env}} F^*(H(Y|J)); \quad (137)$$

where  $p_{X|J=u}$  is the conditional distribution of  $X$  given  $U = u$ . Some of these steps are justified as follows:

(134) follows from the definition of  $F^*(s)$ ;

(136) follows from Jensen's inequality.

Therefore, by definition,  $\underline{\text{env}} F^*(s) = F^*(u; s)$ .

The results of this subsection may be summarized in the following theorem.

**Theorem 10:** The permutation encoding approach achieves the capacity region for input-symmetric DBCs, which is expressed in (129) (130) and (100).

**Corollary 2:** The group-addition encoding approach achieves the capacity region for group-additive degraded broadcast channels.

**Conjecture 1:** The alphabet size of the code for User 2,  $l_s$ , is equal to the alphabet size of the channel input,  $k$ , in a permutation encoding approach for any input-symmetric DBC. In other words, a smallest transitive subset  $\{G_j\}_{j=1}^{l_s}$  of  $G_{T_{YX}; T_{ZX}}$  for any input-symmetric DBC has

$$\prod_{j=1}^{l_s} G_j = 11^T; \quad (138)$$

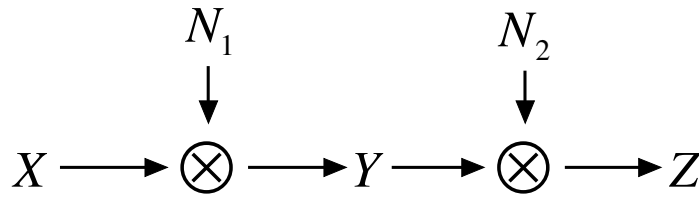

Fig.13  
The discrete degraded broadcast multiplication channel.

### V II. D iscrete M ultiplicative D egraded B roadcast C hannels

De nition 5: D iscrete M ultiplicative D egraded B roadcast C hannel: A discrete DBC  $X \rightarrow Y \rightarrow Z$  with  $X, Y, Z \in \mathbb{F}_q$ ;  $\mathbb{F}_q$  is a discrete multiplicative degraded broadcast channel if there exist two  $(n + 1)$ -ary random variables  $N_1$  and  $N_2$  such that  $Y = X \cdot N_1$  and  $Z = Y \cdot N_2$  as shown in Fig.13, where  $\cdot$  denotes discrete multiplication.

By the de nition of discrete multiplication and group addition, the multiplication of zero and any element in  $\mathbb{F}_q$  is always zero and  $\mathbb{F}_q$  under the discrete multiplication operation forms a group. Hence, the discrete DBC  $X \rightarrow Y \rightarrow Z$  has the channel structure as shown in Fig.14. The sub-channel  $X \rightarrow Y \rightarrow Z$  is a group-additive DBC with marginal distributions  $T_{YX}$  and  $T_{ZX} = T_{ZY} T_{YX}$ , where  $X, Y, Z \in \mathbb{F}_q$ . For the discrete multiplicative DBC  $X \rightarrow Y \rightarrow Z$ , if the channel input  $X$  is zero, the channel outputs  $Y$  and  $Z$  are zeros for sure. If the channel input is a non-zero symbol, the channel output  $Y$  is zero with probability  $\alpha_1$  and  $Z$  is zero with probability  $\alpha_2$ , where  $\alpha_2 = \alpha_1 + (1 - \alpha_1) \beta$ . Therefore, the marginal transmission probability matrices for  $X \rightarrow Y \rightarrow Z$  are

$$T_{YX} = \begin{bmatrix} \alpha_1 & 1 - \alpha_1 \\ 0 & (1 - \alpha_1)T_{YX} \end{bmatrix}; T_{ZY} = \begin{bmatrix} \alpha_2 & 1 - \alpha_2 \\ 0 & (1 - \alpha_2)T_{ZY} \end{bmatrix}; \quad (139)$$

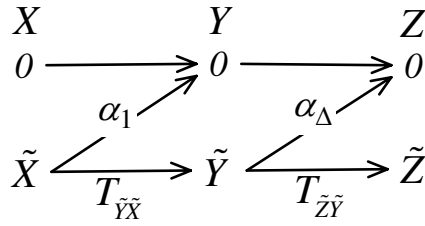

Fig. 14  
The channel structure of a DBC with erasures.

and

$$T_{ZX} = T_{ZY} T_{YX} = \begin{pmatrix} 2 & & 3 & 2 & & 3 \\ 4 & 1 & 1^T & 5 & 4 & 1 & 1^T & 5 & 4 & 1 & 2^T & 5 \\ 0 & (1 & 1)T_{YX} & 0 & (1 & 1)T_{ZY} & 0 & (1 & 2)T_{ZY} \end{pmatrix}; \quad (140)$$

where  $1$  is an all-ones vector and  $0$  is an all-zeros vector.

#### A . Optimal input distribution

The sub-channel  $X \rightarrow Y \rightarrow Z$  is a group-additive DBC, and hence,  $G_{T_{YX}, T_{ZX}}$  is transitive. For any  $n \times n$  permutation matrix  $G \in G_{T_{YX}, T_{ZX}}$  with  $T_{YX}G = T_{YX}$  and  $T_{ZX}G = T_{ZX}$ , the  $(n+1) \times (n+1)$  permutation matrix

$$G = \begin{pmatrix} 2 & 3 \\ 4 & 1 & 0^T & 5 \\ 0 & G \end{pmatrix} \quad (141)$$

has

$$T_{YX}G = \begin{pmatrix} 2 & & 3 & 2 & & 3 \\ 4 & 1 & 1^T & 5 & 4 & 1 & 0^T & 5 \\ 0 & (1 & 1)T_{YX} & 0 & G & 0 & T_{YX} \end{pmatrix}; \quad (142)$$

and so  $G \in G_{T_{YX}}$ . Similarly,  $G \in G_{T_{ZX}}$ , and hence  $G \in G_{T_{YX}, T_{ZX}}$ . Therefore, any non-zero element in  $f_0; 1; \dots; n; g$  can be mapped to any other non-zero element in  $f_0; 1; \dots; n; g$  by some permutation matrix in  $G_{T_{YX}, T_{ZX}}$ , however, no matrix in  $G_{T_{YX}, T_{ZX}}$  maps zero to non-zero

element or non-zero element to zero. Hence, any permutation matrix  $G \in \mathbb{R}^{2 \times 2}$  has

$$G = \begin{bmatrix} 1 & 0 \\ 0 & G \end{bmatrix}; \quad (143)$$

for some  $G \in \mathbb{R}^{2 \times 2}$ . These results may be summarized in the following Lemma:

Lemma 10: Let  $G_{T_{YX}, T_{ZX}} = fG_1; \quad G_1 \in \mathbb{R}^{2 \times 2}$ . Hence,  $G_{T_{YX}, T_{ZX}} = fG_1; \quad G_1 \in \mathbb{R}^{2 \times 2}$  where

$$G_j = \begin{bmatrix} 1 & 0 \\ 0 & G_j \end{bmatrix}; \quad (144)$$

for  $j = 1, \dots, l$ .

Now we state and prove that the uniformly distributed  $X$  is optimal for the discrete degraded broadcast multiplication channel.

Lemma 11: Let  $p_X = (1 - q; q\mathbf{u}^T)^T \in \mathbb{R}^{n+1}$  be the distribution of channel input  $X$ , where  $p_X$  is the distribution of  $X$ . For any discrete multiplicative DBC,  $C_{p_X} = C_{(1 - q; q\mathbf{u}^T)^T}$  and  $C = \int_{q \in [0,1]} C_{(1 - q; q\mathbf{u}^T)^T} d\mu(q)$ , where  $\mu \in \mathbb{R}^n$  denotes the uniform distribution.

The proof of Lemma 11 is similar to that of Lemma 9 and the details are given in Appendix VI.

Theorem 11: The capacity region of the discrete multiplicative degraded broadcast channel can be achieved by using transmission strategies where  $X$  is uniformly distributed, i.e., the distribution of  $X$  has  $p_X = (1 - q; q\mathbf{u}^T)^T$  for some  $q \in [0,1]$ . As a consequence, the capacity region is

$$\begin{aligned} \text{co} \left\{ \int_{q \in [0,1]} (R_1; R_2) d\mu(q) \right\} &= \int_{q \in [0,1]} (R_1; R_2) d\mu(q); \\ R_1 &= h((1 - q)\mathbf{u}) + q h(\mathbf{u}); \\ R_2 &= h((1 - q)\mathbf{u}) + q h(\mathbf{u}) - F_{T_{YX}, T_{ZX}}((1 - q; q\mathbf{u}^T)^T; \mathbf{s}); \end{aligned} \quad (145)$$

Proof: Let  $p_X = (1 - q; q)^n$  be the distribution of the channel input  $X$ , where  $p_X = (p_1; \dots; p_n)^T$ . Since  $G_{T_{YX}}$  is transitive and the columns of  $T_{YX}$  are permutations of each other.

$$H(Y|X) = \sum_{i=0}^{X^n} H(Y|X = i) \quad (146)$$

$$= (1 - q)H(Y|X = 0) + \sum_{i=1}^{X^n} q p_i h_n(T_{YX} e_i) \quad (147)$$

$$= \sum_{i=1}^{X^n} q p_i h_n(T_{YX} e_i) \quad (148)$$

$$= q h_n(T_{YX} e_1); \quad (149)$$

which is independent of  $p_X$ . Let  $G_{T_{YX}; T_{ZX}} = fG_1; \dots; gG$

$$H(Z) = h_{n+1}(T_{ZX} p_X) \quad (150)$$

$$= \sum_{i=1}^{X^1} h_{n+1}(T_{ZX} G_i p_X) \quad (151)$$

$$h_{n+1}(T_{ZX} \sum_{i=1}^{X^1} G_i p_X) \quad (152)$$

$$= h_{n+1}(T_{ZX} (1 - q; q)^T)^T \quad (153)$$

$$= h((1 - 2)q) + (1 - 2)q \ln(n) \quad (154)$$

where (152) follows from Jensen's inequality. Since  $C_{p_X} = C_{(1 - q; q)^T}$  for the discrete multiplicative DBC,

$$F(p_X; s) = F((1 - q; q)^T; s); \quad (155)$$

Plugging (149), (154) and (155) into (7), the capacity region for discrete multiplicative DBCs is

$$\begin{aligned} \text{co} \left[ \right. & \left. \begin{aligned} & (R_1; R_2) : R_1 \leq H(Y|X); \\ & R_2 \leq H(Z) - F_{T_{YX}; T_{ZX}}(q; s) \end{aligned} \right. \quad (156) \\ & \left. \begin{aligned} & (R_1; R_2) : R_1 \leq h_n(T_{YX} e_1); \\ & R_2 \leq h((1-\alpha)q) + (1-\alpha)q \ln(n) \\ & \quad F_{T_{YX}; T_{ZX}}((1-\alpha)q; \alpha q u^T; s) \end{aligned} \right. \quad (157) \end{aligned}$$

$$\begin{aligned} & \text{co} \left[ \begin{aligned} & (R_1; R_2) : R_1 \leq h_n(T_{YX} e_1); \\ & R_2 \leq h((1-\alpha)q) + (1-\alpha)q \ln(n) \\ & \quad F_{T_{YX}; T_{ZX}}((1-\alpha)q; \alpha q u^T; s) \end{aligned} \right. \quad (158) \\ & \left. \begin{aligned} & (R_1; R_2) : R_1 \leq H(Y|X); \\ & R_2 \leq H(Z) - F_{T_{YX}; T_{ZX}}(q; s) \end{aligned} \right. \quad (159) \end{aligned}$$

$$\begin{aligned} \text{co} \left[ \begin{aligned} & (R_1; R_2) : R_1 \leq H(Y|X); \\ & R_2 \leq H(Z) - F_{T_{YX}; T_{ZX}}(q; s) \end{aligned} \right. \quad (160) \end{aligned}$$

where  $\text{co}$  denotes the convex hull of the closure. Note that (156) and (160) are identical expressions, hence (156 – 160) are all equal. Therefore, (158) expresses the capacity region for the DM-DBC, which also means that the capacity region can be achieved by using transmission strategies where the broadcast signal  $X$  has distribution  $p_X = (1-\alpha)q; \alpha q u^T)^T$  for some  $\alpha \in [0; 1]$ . Q.E.D.

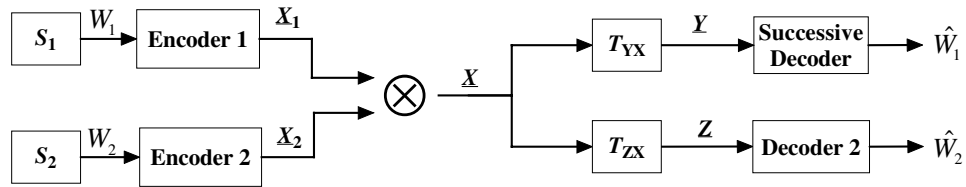

Fig. 15

The block diagram of the NE scheme for the discrete multiplicative DBC .

### B . Optimality of the NE scheme for DM -DBC s

The NE scheme for the discrete multiplicative DBC is shown in Fig. 15.  $W_1$  is the message for User 1 who sees the better channel  $T_{YX}$  and  $W_2$  is the message for User 2 who sees the worse channel  $T_{ZX}$ . The NE scheme is first to independently encode these two messages into two codewords  $X_1$  and  $X_2$  respectively, and then to broadcast  $X$  which is obtained by applying the single-letter multiplication function  $X = X_2 \cdot X_1$  on symbols of codewords  $X_1$  and  $X_2$ . The distribution of  $X_2$  is constrained to be  $p_{X_2} = (1 - q; qu^T)^T$  for some  $q \in [0; 1]$  and hence the distribution of the broadcast signal  $X$  also has  $p_X = (1 - q; qu^T)^T$  for some  $q \in [0; 1]$ , which was proved to be the optimal input distribution for the discrete multiplicative DBC. User 2 receives  $Z$  and decodes the desired message directly. User 1 receives  $Y$  and successively decodes the message for User 2 and then for User 1.

Let  $p_X = (1 - q; qp_{X'})^T$  be the distribution of the channel input  $X$ , where  $p_{X'}$  is the

distribution of sub-channel input  $X$ . For the discrete multiplicative DBC  $X \rightarrow Y \rightarrow Z$ ,

$$(p_X; \gamma) = h_{n+1}(\Gamma_{ZX} p_X) - h_{n+1}(\Gamma_{YX} p_X) \quad (161)$$

$$= h_{n+1} \left( \frac{1}{q} \log \frac{q + q^2}{5} \right) - h_{n+1} \left( \frac{1}{q} \log \frac{q + q^1}{5} \right) \quad (162)$$

$$= h(q \Gamma_{ZX} p_X) - h(q \Gamma_{YX} p_X)$$

$$= h(q \Gamma_{ZX} p_X) - h(q \Gamma_{YX} p_X) \quad (163)$$

$$= h(q \Gamma_{ZX} p_X) - h(q \Gamma_{YX} p_X) \quad (164)$$

where  $\Gamma_{ZX} = \frac{1}{q} \log \frac{q + q^2}{5}$  and  $\Gamma_{YX} = \frac{1}{q} \log \frac{q + q^1}{5}$ .

For the sub-channel  $X \rightarrow Y \rightarrow Z$ , define  $\tilde{h}(p_X; \frac{1}{q}) = h_n(\Gamma_{ZX} p_X) - \frac{1}{q} h_n(\Gamma_{YX} p_X)$ .

Define  $h'(q; p_X; \gamma)$  as follows:

$$h'(q; p_X; \gamma) = h(q \Gamma_{ZX} p_X) - h(q \Gamma_{YX} p_X) + \tilde{h}(p_X; \frac{1}{q}); \quad (165)$$

where  $\tilde{h}$  is the lower envelope of  $\tilde{h}(p_X; \frac{1}{q})$  in  $p_X$ . With this definition, note that  $h(p_X; \gamma)$ , the lower envelope of  $h(p_X; \gamma)$ , is also the lower envelope of  $h'(q; p_X; \gamma)$ .

Lemma 12:  $(\frac{1}{q} \log \frac{q + q^T}{5})^T$ , the lower envelope of  $h(p_X; \gamma)$  in  $p_X$  at  $p_X = (\frac{1}{q} \log \frac{q + q^T}{5})^T$  is on the lower envelope of  $h'(q; u; \gamma)$  in  $q$ .

The proof is given in Appendix V II. Lemma 12 indicates that the lower envelope of  $h(p_X; \gamma)$  at  $p_X = (\frac{1}{q} \log \frac{q + q^T}{5})^T$  can be decomposed into two steps. First, for any fixed  $q$ , the lower envelope of  $h(p_X; \gamma)$  in  $p_X$  is  $h'(q; p_X; \gamma)$ . Second, for  $p_X = u$ , the lower envelope of  $h'(q; u; \gamma)$  in  $q$  coincides with  $h(p_X; \gamma)$ , the lower envelope of  $h(p_X; \gamma)$  in  $p_X$ .

Now we state and prove that the NE scheme is optimal for the discrete multiplicative DBC.

Theorem 12: The NE scheme with time sharing achieves the boundary of the capacity



region for the discrete multiplicative degraded broadcast channel.

Proof: Theorem 11 shows that the boundary of the capacity region for the discrete multiplicative DBC can be achieved by using transmission strategies with uniformly distributed  $X$ , i.e., the input distribution  $p_X = (1 - q; qu^T)^T$ . For  $p_X = (1 - q; qu^T)^T$ ,  $((1 - q; qu^T)^T; )$  can be attained by the convex combination of points on the graph of  $'(q; u; )$ . Since

$$'(q; u; ) = h(q_2) - h(q_1) + q_2 \tilde{u}(u; \frac{1}{1}); \quad (166)$$

which is the sum of  $'(q; )$  for the broadcast Z channel and  $q$  times the constant  $\tilde{u}(u; \frac{1}{1})$ . Hence, by a discussion analogous to Section V,  $((1 - q; qu^T)^T; )$  can be attained by the convex combination of 2 points on the graph of  $'(q; u; )$ . One point is at  $q = 0$  and  $'(0; u; ) = 0$ . The other point is at  $q = p$ , where  $p$  is determined by  $\ln(1 - p) = \ln(1 - p)$ .

Note that the point  $(0,0)$  on the graph of  $'(q; u; )$  is also on the graph of  $(p_X; )$ . By Theorem 6, the point  $(p; '(p; u; ))$  is the convex combination of  $n$  points on the graph of  $(p_X; )$ , which corresponds to the group-addition encoding approach for the sub-channel  $X \rightarrow Y \rightarrow Z$  because the group-addition encoding approach is the optimal NE scheme for the group-additive DBC  $X \rightarrow Y \rightarrow Z$ . Therefore, by Theorem 6, an optimal transmission strategy for the discrete multiplicative DBC  $X \rightarrow Y \rightarrow Z$  has the NE structure as shown in Fig. 16. Q.E.D.

If the auxiliary random variable  $U = 0$ , then the channel input  $X = 0$ . If  $U$  is a non-zero symbol, then  $X = 0$  with probability  $1 - p$ . In the case where  $U$  and  $X$  are both non-zero,  $X$  can be obtained as  $X = U \nabla$ , where  $\nabla$  is a group operation equivalent to group addition in the group-additive degraded broadcast sub-channel  $X \rightarrow Y \rightarrow Z$ ,  $U$  is uniformly distributed and  $\nabla$  is an  $n$ -ary random variable.

Since the NE scheme is optimal for discrete multiplicative DBCs, its achievable rate region is the capacity region for discrete multiplicative DBCs. Hence, the capacity region for the

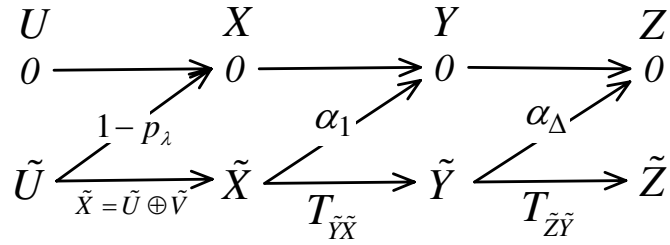

Fig. 16

The optimal transmission strategy for the discrete multiplicative degraded broadcast channel

discrete multiplicative DBC in Fig. 13 is

$$\begin{aligned}
 & \text{h} \quad [ \\
 & \infty \quad (R_1; R_2) : R_2 \quad H(U, V, N_2) \quad H(U, V, N_2, j) \\
 & \quad P_U = (1 - p_{\lambda})^T \quad P_V = 2^{-n+1} \\
 & R_1 \quad H(U, V, N_1, j) \quad H(U, V, N_1, j, V) : \quad (167)
 \end{aligned}$$

### V III. C onclusions

This paper explores relatively simple optimal encoders for the degraded broadcast channel. By extending the input-symmetry and F ( ) ideas of Wyner and Witsenhausen, this paper introduced and proved the optimality of the permutation encoding approach for input-symmetric DBCs and showed that natural encoding can achieve the boundary of the capacity region for the multi-user broadcast Z channel, any two-user group-additive DBC, and (by combining the previous two results) the two-user discrete multiplicative DBC. Along the way, this paper has provided closed-form expressions for the capacity regions of these DBCs. In conclusion, natural encoding achieves the capacity region of DBCs much more often than has been previously known. In fact, it would seem that there are more such cases where natural encoding achieves the DBC capacity region waiting to be identified. It remains an open problem to prove a general theorem establishing the optimality of natural encoding over a suitably large class of DBCs. The results of this paper also open interesting problems

in channel coding to find practical channel codes for the DBCs examined in this paper.

## IX . Acknowledgment

The authors would like to thank Emre Telatar and Tom Courtade for their helpful comments.

## Appendices

### Appendix I

The appendix presents a simple independent encoding scheme made known to us by Telatar [5] which achieves the capacity region for DBCs. The scheme generalizes to any number of receivers, but showing the two-user case suffices to explain the approach. It indicates that any achievable rate pair  $(R_1; R_2)$  for a DBC can be achieved by combining symbols from independent encoders with a single-letter function. The independent encoders operate using two codebooks  $\{v_1^n(i) : i = 1; \dots; 2^{nR_1}\}$ ,  $\{u_1^n(j) : j = 1; \dots; 2^{nR_2}\}$  and a single-letter function  $f(v; u)$ . In order to transmit the message pair  $(i; j)$ , the transmitter sends the sequence  $f(v_1^n(i); u_1^n(j)); \dots; f(v_n^n(i); u_n^n(j))$ . The scheme is described below :

**Lemma 13:** Suppose  $U$  and  $X$  are discrete random variables with joint distribution  $p_{U;X}$ . There exist  $V$  independent of  $U$  and a deterministic function  $f$  such that the pair  $(U; f(V; U))$  has joint distribution  $p_{U;X}$ . [5]

**Proof:** Suppose  $U$  and  $X$  take values in  $\{1; \dots; l\}$  and  $\{1; \dots; k\}$  respectively. Let  $V = (V_1; \dots; V_l)$  independent of  $U$ , be a random variable taking values in  $\{1; \dots; l\}$ .

with  $\Pr(V_j = i) = p_{X_j}(i|j)$ . Set  $f(v_1; \dots, v_n; u) = v_u$ . Then we have

$$\begin{aligned}
 \Pr(U = u; f(V;U) = x) &= \Pr(U = u; V_u = x) \\
 &= \Pr(U = u) \Pr(V_u = x) \\
 &= p_U(u) p_{X_j}(x|j) \\
 &= p_{U_X}(u; x):
 \end{aligned} \tag{168}$$

Q E D .

If the rate pair  $(R_1; R_2)$  is achievable for a degraded broadcast channel  $X \rightarrow Y \rightarrow Z$ , there exists an auxiliary random variable  $U$  such that

$$\begin{aligned}
 &(a) U \rightarrow X \rightarrow Y \rightarrow Z; \\
 &(b) I(X; Y|U) \leq R_1; \\
 &(c) I(U; Z) \leq R_2:
 \end{aligned} \tag{169}$$

Use Lemma 13 to find  $V$  independent of  $U$  and the deterministic function  $f(v; u)$  such that the pair  $(U; f(V;U))$  has the same joint distribution as that of  $(U; X)$ . Randomly and independently choose codewords  $v^n(1); \dots, v^n(n) \in \mathcal{V}^{nR_1}$  according to  $p(v^n) = p_V(v_1) \dots p_V(v_n)$ , and choose codewords  $u^n(1); \dots, u^n(n) \in \mathcal{U}^{nR_2}$  according to  $p(u^n) = p_U(u_1) \dots p_U(u_n)$ . To send message pair  $(i; j)$ , the encoder transmits  $f(v_1(i); u_1(j)); \dots; f(v_n(i); u_n(j))$ .

Using a typical-set-decoding random coding argument, the weak decoder, given  $z^n$ , searches for the unique  $j^0$  such that  $(z^n; u^n(j^0))$  is jointly typical. The error probability converges to zero as  $n$  goes to infinity since  $R_2 \leq I(U; Z)$ . The strong decoder, given  $y^n$ , also searches for the unique  $j^0$  such that  $(y^n; u^n(j^0))$  is jointly typical, and then searches for the unique  $i^0$  such that  $(y^n; v^n(i^0))$  is jointly typical given  $u^n(j^0)$ . The error probability converges to zero

as  $n$  goes to infinity since

$$R_2 = I(U;Z) = I(U;Y); \quad (170)$$

and

$$\begin{aligned} R_1 &= I(X;Y \cup J) \\ &= H(Y \cup J) = H(Y \cap (V;U);U) \\ &= H(Y \cup J) = H(Y \cap (V;U);U;V) \\ &= H(Y \cup J) = H(Y \cup J;V) \\ &= I(V;Y \cup J); \end{aligned} \quad (171)$$

## Appendix II

Proof of Lemma 2: Part i) is a consequence of Lemma 1 by applying the Fenchel-Eggleston strengthening of Caratheodory's Theorem [21] (Theorem 18 (i) (ii), p. 35). If a compact set  $S$  has  $d$  or fewer connected components, and the set  $C$  with dimension  $d$  is the convex hull of  $S$ , then the Fenchel-Eggleston Theorem shows that every point in  $C$  is a convex combination of  $d$  or fewer points of  $S$ . Since the dimension of  $C$  in this paper is  $d = k + 1$ , every point of  $C$  can be achieved by (9) (10) and (11) with  $l = k + 1$ .

ii) Dubins' Theorem [19] (Theorem 3.6.20, p.116) shows that if a set  $C$  is convex and compact, then every extreme point of the intersection of  $C$  with  $d$  hyperplanes is a convex combination of  $d + 1$  or fewer extreme points of  $C$ . A two-dimensional plane in  $(k + 1)$  dimensions can be considered as the intersection of  $(k + 1) - 2 = k - 1$  hyperplanes. Thus every extreme point of the intersection of  $C$  with a two-dimensional plane is a convex combination of  $1 - k$  extreme points of  $C$ . Part ii) is then proved by the fact that every extreme point of  $C$  belongs to  $S$ . Q E D .

### Appendix III

Proof of Theorem 6: i) The point  $(q; (q; ))$  is a point on the lower boundary of  $C$  which is obtained as a convex combination of the points  $(p_j; (p_j; ))$  of  $S$  with weights  $w_j$ . By (45), the transmission strategy  $U \in \mathcal{X}$  determined by  $\forall j=1, \dots, L, \Pr(U=j) = w_j$  and  $p_{X|Y=j} = p_j, j=1, \dots, L$  achieves the maximum of  $R \in \mathbb{R}_1$  subject to the constraint  $p_X = q$ . Thus, the point  $(q; \sum_{j=1}^L w_j h_n(T_{YX} p_j); \sum_{j=1}^L w_j h_m(T_{ZX} p_j))$  is on the lower boundary of  $C$ , and hence of  $C_q$ . It implies that the graph of  $F(q; )$  is supported by a line of slope  $\alpha$  at that point, and thus (46) holds. For Part ii), if the transmission strategy  $U \in \mathcal{X}$  determined by  $\forall j=1, \dots, L, \Pr(U=j) = w_j$  and  $p_{X|Y=j} = p_j, j=1, \dots, L$  achieves the maximum of  $R \in \mathbb{R}_1$  subject to the constraint  $p_X = q$ , the point  $(q; \sum_{j=1}^L w_j h_n(T_{YX} p_j); \sum_{j=1}^L w_j h_m(T_{ZX} p_j))$  is on the lower boundary of  $C_q$ , and at this point the graph of  $F(q; )$  is supported by a line of slope  $\alpha$ . Thus, the point  $(q; (q; ))$  is the convex combination of  $L$  points of the graph of  $F(\cdot; )$  with arguments  $p_j$  and weights  $w_j, j=1, \dots, L$ . Q.E.D.

### Appendix IV

Proof of Lemma 5: Lemma 5 is the consequence of Theorem 5 for the broadcast  $Z$  channel. Since  $H(Y|J) = N \log \frac{q}{p} h_1(p)$ ,

$$H(Z|J) = F_{T_{YX}^{(N)}, T_{ZX}^{(N)}}(q; N \log \frac{q}{p} h_1(p)) \quad (172)$$

$$= N F_{T_{YX}, T_{ZX}}(q; \log \frac{q}{p} h_1(p)) \quad (173)$$

$$= N \frac{q}{p} h_2(p) \quad (174)$$

$$= N \frac{q}{p} h_1(p \alpha): \quad (175)$$

These steps are justified as follows:

(172) follows from the definition of  $F$ ;

(173) follows from Theorem 5;

(174) follows from the expression of the function  $F$  for the broadcast Z channel in (59);

(175) follows from  $\Pr\{Z = 0\} = 0, \Pr\{Z = 1\} = 1$ .

## Appendix V

Proof of (77): Plugging  $j = 1$  in (76), we have

$$H(Y_1; W_2) - H(Y_1; W_1) = N \frac{q}{t_1} h(t_1) - N q h(t_1) + o(N) \quad (176)$$

or

$$H(Y_1; W_2) - H(Y_1; W_1) = N \frac{q}{t_1} h(t_1) + o(N); \quad (177)$$

since

$$H(Y_1; W_1) = H(Y_1; X) \quad (178)$$

$$= \sum_{i=1}^N H(Y_{1,i}; X_i) \quad (179)$$

$$= \sum_{i=1}^N H(Y_{1,i}; X_i) \quad (180)$$

$$= \sum_{i=1}^N \Pr(X_i = 0) h(t_1) \quad (181)$$

$$= N q h(t_1); \quad (182)$$

Some of these steps are justified as follows:

(178) follows from the fact that  $X$  is a function of  $(W_1, W_2)$ ;

(179) follows from the conditional independence of  $Y_{1,i}, i = 1, \dots, N$ , given  $X$ ;

(180) follows from the conditional independence of  $Y_{1,i}$  and  $(X_1, \dots, X_{i-1}, X_{i+1}, \dots, X_N)$  given  $X_i$ .

Inequality (177) indicates that

$$H(Y_j | \mathcal{W}_{j+1}; \mathcal{W}) \leq N \frac{q}{t_j} h(t_j) + o(\cdot); \quad (183)$$

is true for  $j = 1$ . The rest of the proof is by induction. We assume that (183) is true for  $j$ , which means

$$H(Y_j | \mathcal{W}_{j+1}; \mathcal{W}) \leq N \frac{q}{t_j} h(t_j) + \frac{o(\cdot)}{N} \quad (184)$$

$$= N \frac{q}{t_j + \frac{(\cdot)}{N}} h\left(t_j + \frac{(\cdot)}{N}\right); \quad (185)$$

where the function  $(\cdot) \rightarrow 0$  as  $(\cdot) \rightarrow 0$ , since  $\frac{q}{t_j} h(t_j)$  is continuous in  $t_j$ . Applying Lemma 5 to the Markov chain  $(\mathcal{W}_{j+1}; \mathcal{W} \rightarrow X \rightarrow Y_j \rightarrow Y_{j+1})$ , we have

$$H(Y_{j+1} | \mathcal{W}_{j+1}; \mathcal{W}) \leq N \frac{q}{t_j + \frac{(\cdot)}{N}} h\left(t_j + \frac{(\cdot)}{N}\right) \quad (186)$$

$$= N \frac{q}{t_j} h(t_j) + o(\cdot); \quad (187)$$

Considering (76) for  $j + 1$ , we have

$$H(Y_{j+1} | \mathcal{W}_{j+2}; \mathcal{W}) \leq H(Y_{j+1} | \mathcal{W}_{j+1}; \mathcal{W}) \leq N \frac{q}{t_{j+1}} h(t_{j+1}) + N \frac{q}{t_j} h(t_j) + o(\cdot); \quad (188)$$

Substitution of (187) in (188) yields

$$H(Y_{j+1} | \mathcal{W}_{j+2}; \mathcal{W}) \leq N \frac{q}{t_{j+1}} h(t_{j+1}) + o(\cdot); \quad (189)$$

which establishes the induction. Finally, for  $j = d, N$  should be added to the right side of (184) because of the presence of  $(\cdot)$  in (69) for  $j = d$ , and hence, of  $N$  in (76).



## Appendix V I

Proof of Lemma 11: Let  $G_{T_{YX}; T_{ZX}} = fG_1; \dots; G_n$ . For any  $(q; i) \in C_{p_X}$ , where  $p_X = (1 \ q; qp_X^T)^T$ , one has  $(p_X; i) \in C$ . Since Lemma 8 and Corollary 1 also hold for the discrete multiplicative DBC,  $(G_j p_X; i) \in C$  for all  $j = 1; \dots; n$ . By the convexity of the set  $C$ ,

$$(q; i) = \left( \prod_{j=1}^{X^1} G_j p_X; i \right) \in C; \quad (190)$$

where  $q = \prod_{j=1}^{X^1} G_j p_X$ . Since  $G_{T_{YX}; T_{ZX}}$  is a group, for any permutation matrix  $G^0 \in G_{T_{YX}; T_{ZX}}$ ,

$$G^0 q = \prod_{j=1}^{X^1} G^0 G_j p_X = \prod_{j=1}^{X^1} G_j p_X = q; \quad (191)$$

Hence, the  $i^{\text{th}}$  entry and the  $j^{\text{th}}$  entry of  $q$  are the same if  $G^0$  permutes the  $i^{\text{th}}$  row to the  $j^{\text{th}}$  row. Since, for any discrete multiplicative DBC, the set  $G_{T_{YX}; T_{ZX}}$  maps any non-zero element in  $\{0; 1\}^n$  to any other non-zero element, all entries except the first entry of  $q$  are the same as each other. Furthermore, no matrix in  $G_{T_{YX}; T_{ZX}}$  maps the zero element to a non-zero element, hence the first entry of  $q$  is the same as the first entry of  $p_X$ . Therefore,  $q = (1 \ q; qu^T)^T$ . This implies that  $(q; i) \in C_{(1 \ q; qu^T)^T}$ , and hence  $C_{p_X} \subseteq C_{(1 \ q; qu^T)^T}$ . Therefore,  $C = \bigcup_{q \in \{0; 1\}^n} C_{(1 \ q; qu^T)^T}$ . Q E D.

## Appendix V II

Proof of Lemma 12:  $(p_X; i)$  is the lower envelope of  $\{(q; p_X; i)\}$  in  $p_X$ . For  $p_X = (1 \ q; qu^T)^T$ , suppose the point  $(p_X; i)$  is the convex combination of  $n + 1$  points  $\{(q_i; p_i; i)\}$  on the graph of  $\{(q; p_X; i)\}$  with weights  $w_i$  for  $i = 1; \dots; n + 1$ . Therefore,

$$q = \sum_{i=1}^{n+1} w_i q_i; \quad (192)$$

$$u = \sum_{i=1}^{X+1} w_i p_i; \quad (193)$$

$$(p_X; ) = \sum_{i=1}^{X+1} w_i' (q_i; p_i; ): \quad (194)$$

Since  $\tilde{(p; )} \sim \tilde{(u; )}$  for the group-additive degraded broadcast sub-channel,

$$' (q_i; p_i; ) \sim ' (q_i; u; ): \quad (195)$$

Therefore, the convex combination of  $n + 1$  points  $((q_i; u; ) ; ' (q_i; u; ))$  with weights  $w_i$  has

$$\sum_{i=1}^{X+1} w_i q_i = q; \quad (196)$$

and

$$\sum_{i=1}^{X+1} w_i' (q_i; u; ) + \sum_{i=1}^{X+1} w_i' (q_i; p_i; ) = (p_X; ): \quad (197)$$

On the other hand, since  $(p_X; )$  is the lower envelope of  $' (q; p_X; )$  in  $p_X$ ,  $\sum_{i=1}^{X+1} w_i' (q_i; u; )$   $(p_X; )$  and hence  $\sum_{i=1}^{X+1} w_i' (q_i; u; ) = (p_X; )$ . Therefore,  $((1 - q; q u^T)^T; )$ , the lower envelope of  $(p_X; )$  in  $p_X$  at  $p_X = (1 - q; q u^T)^T$  can be attained as the convex combination of points on the graph of  $' (q; u; )$  in the dimension of  $q$ . Q E D .

## References

- [1] T.M. Cover. Broadcast channels. IEEE Trans. Inform. Theory, IT-18:2{14, January 1972.
- [2] P.P. Bergmans. Random coding theorem for broadcast channels with degraded components. IEEE Trans. Inform. Theory, IT-19:197{207, March 1973.
- [3] R.G. Gallager. Capacity and coding for degraded broadcast channels. Probl. Pered. Inform., 10:3{14, July{Sept. 1974.
- [4] T.M. Cover and J.A. Thomas. Elements of Information Theory. Wiley-Interscience, 1991.
- [5] E. Telatar. Private Communication.

- [6] T.M. Cover. An achievable rate region for the broadcast channel. *IEEE Trans. Inform. Theory*, IT-21:399{404, 1975.
- [7] P.P. Bergmans. A simple converse for broadcast channels with additive white Gaussian noise. *IEEE Trans. Inform. Theory*, IT-20:279{280, March 1974.
- [8] A.D. Wyner. A theorem on the entropy of certain binary sequences and applications: Part II. *IEEE Trans. Inform. Theory*, IT-19:772{777, Nov 1973.
- [9] H. Witsenhausen. Entropy inequalities for discrete channels. *IEEE Trans. Inform. Theory*, IT-20(5):610{616, Sep 1974.
- [10] H. Witsenhausen and A. Wyner. A conditional entropy bound for a pair of discrete random variables. *IEEE Trans. Inform. Theory*, IT-21(5):493{501, Sep 1975.
- [11] R. Benzel. The capacity region of a class of discrete additive degraded interference channels. *IEEE Trans. Inform. Theory*, IT-25:228{231, 1979.
- [12] B. Xie, M. Griot, A. I. Vila Casado and R. D. Wesel. Optimal transmission strategy and capacity region for broadcast Z channels. In *IEEE Information Theory Workshop 2007, Lake Tahoe, USA, Sep 2007*.
- [13] B. Xie, M. Griot, A. I. Vila Casado and R. D. Wesel. Optimal transmission strategy and explicit capacity region for broadcast Z channels. *IEEE Trans. Inform. Theory*, 53:4296{4304, 2008.
- [14] C.E. Shannon. A mathematical theory of communication. *Bell System Technical Journal*, 27:623{656, Oct 1948.
- [15] A.D. Wyner and J. Ziv. A theorem on the entropy of certain binary sequences and applications: Part I. *IEEE Trans. Inform. Theory*, IT-19:769{772, Nov 1973.
- [16] N. Liu and S. Ulukus. The capacity region of a class of discrete degraded interference channels. In *Information Theory and Applications 2007, UCSD, San Diego, USA, Jan 29-Feb 2 2007*.
- [17] N. Liu and S. Ulukus. The capacity region of a class of discrete degraded interference channels. *IEEE Trans. Inform. Theory*, 54(9):4372{4378, Sep 2008.
- [18] B. Xie and R. D. Wesel. A mutual information invariance approach to symmetry in discrete memoryless channels. In *Information Theory and Application 2008, UCSD, San Diego, USA, Jan. 27-Feb. 1 2008*.
- [19] R. G. Gallager. *Information Theory and Reliable Communication*. New York: Wiley, 1968.
- [20] S. W. Golomb. The limiting behavior of the Z-channel. *IEEE Trans. Inform. Theory*, IT-26:372, May 1980.
- [21] H. G. Eggleston. *Convexity*. New York: Cambridge Univ., 1963.