

# FINITE SQUARE LATTICE VERTEX COVER BY A BASELINE SET DEFINED WITH A MINIMUM SUBLATTICE

RICHARD J. MATHAR

ABSTRACT. Each straight infinite line defined by two vertices of a finite square point lattice contains (covers) these two points and a—possibly empty—subset of points that happen to be collinear to these. This work documents vertex subsets of minimum order such that the sum of the infinite straight lines associated with the edges of their complete subgraph covers the entire set of vertices (nodes). This is an abstraction to the problem of sending a light signal to all stations (receivers) in a square array with a minimum number of stations also equipped with transmitters to redirect the light to other transmitters.

## 1. GEOMETRY OF THE OPTIMIZATION PROBLEM

Given a  $(n+1) \times (n+1)$  regular square lattice, we aim at a quantitative assessment of the following optimization problem considered by Alon [1]: a subset of vertices of minimum size (order)  $t$  is to be found such that each of the  $(n+1)^2$  vertices of the square lattice lies on at least one of the infinite lines defined by connecting all pairs of the  $t$  points. The number of these lines is generally  $\binom{t}{2} = t(t-1)/2$ , once a subset of vertices has been selected, but may actually be smaller if some of the vertices of that subset are collinear.

The requirement that solutions cover points by straight lines puts this in the category of geometric optimizations rather than reduction problems in graph theory which deal with the topology and connectivity of the full square lattice. It also defines this as a model for distribution of a signal via classical optical (straight) light from one of the vertices to all the others, supposed that (i) most of them are of some kind of semi-transparent receivers, and (ii) those that we selected as a sublattice (transmitters) can in addition dispatch (redirect) the signal to others of their kind. Our optimization calls for the cheapest solution, which minimizes the number of—supposedly more versatile and more expensive—transmitters. It also minimizes broadcast times if the signal is distributed along some Eulerian trail between the transmitters.

Solutions to this task are not necessarily unique. First, there is a generic multiplicity of solutions associated with the symmetry group  $4mm$  of the square [6]: there are up to 8 equivalent (congruential) geometries, when any setup with a sublattice of  $t(n)$  vertices is rotated by multiples of 90 degrees (operations  $\delta_4^1, \delta_4^2, \delta_4^3$ ) or flipped into its mirror image (operations  $m_x$  or  $m_y$  flip along the horizontal or vertical mid axis,  $m_d$  or  $m_{d'}$  along the main or secondary diagonal). The actual multiplicity depends on how far the sublattice itself shows the full symmetry of the

---

*Date:* October 24, 2018.

*2000 Mathematics Subject Classification.* Primary 52C05, 52C15; Secondary 51M04, 05C90.

*Key words and phrases.* square lattice, covering, sublattice, minimization.

square or ‘breaks’ this symmetry. Second, as we shall see, sets of incongruent solutions may display the same minimum count  $t(n)$  of vertices to span the lines.

The results are put into two categories: Section 2 summarizes minimum solutions for the cases of small lattices  $n = 3$  to  $n = 6$  for which the entire configuration space has been scanned: the corresponding  $t(n)$  are proven to be minimum at those individual  $n$ . One representative of each of the incongruent solutions will be drawn for  $n = 3$  to 5, and some incongruent solutions for  $n = 6$ . Section 3 addresses larger  $n$  in the range  $n = 7$  to 110, where solutions have been searched by a mixture of heuristics; those small  $t(n)$  actually found establish only upper bounds since even smaller  $t(n)$  may have evaded detection.

## 2. OPTIMUM SOLUTIONS

The graphs show the general square lattice vertices as grey squares, the vertices of the spanning sublattice in Red—darker in black&white printouts.

All base lines between the vertices of the red sublattice are drawn, which allows a visual verification of the matching requirement that each vertex is hit by at least one line. (Unlike some associated ‘attacking Queens’ problems on chess boards, the slope of the lines is not constrained to multiples of 45 degrees.)

The obvious two incongruent solutions for  $n = 2$  with sublattices of  $t(2) = 4$  are shown in Figure 1, and the two incongruent solutions for  $n = 3$  with  $t(3) = 4$  in Figure 2.

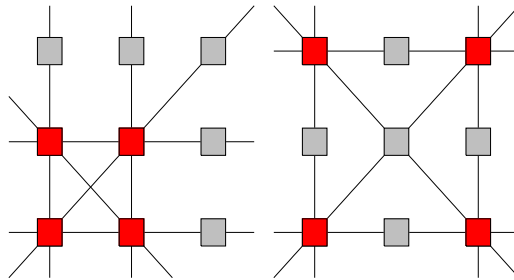

FIGURE 1.  $t(2) = 4$ .

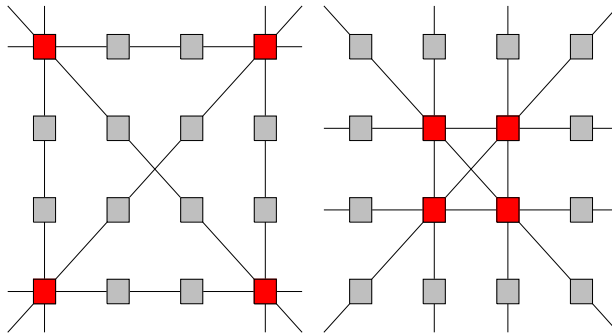
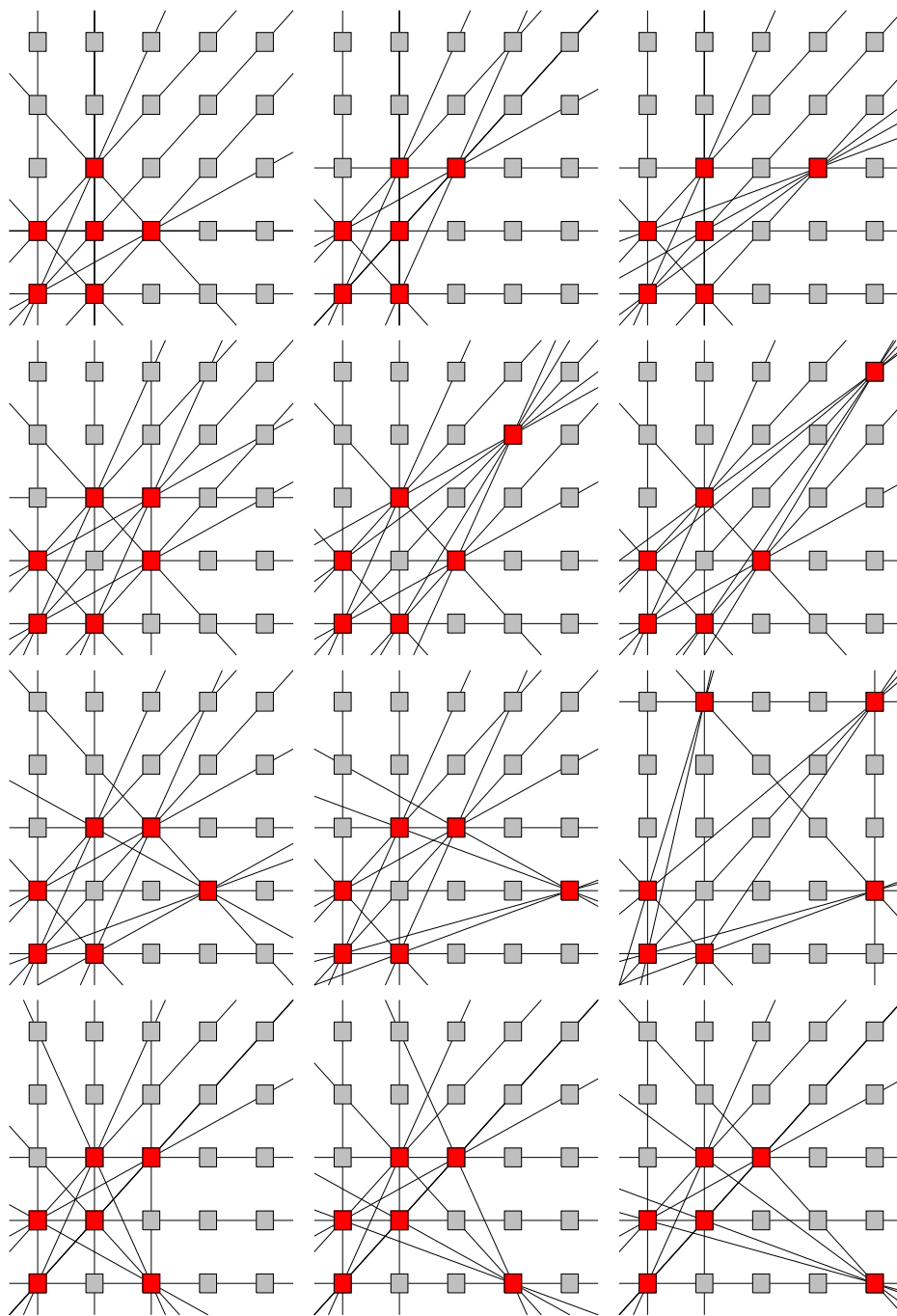
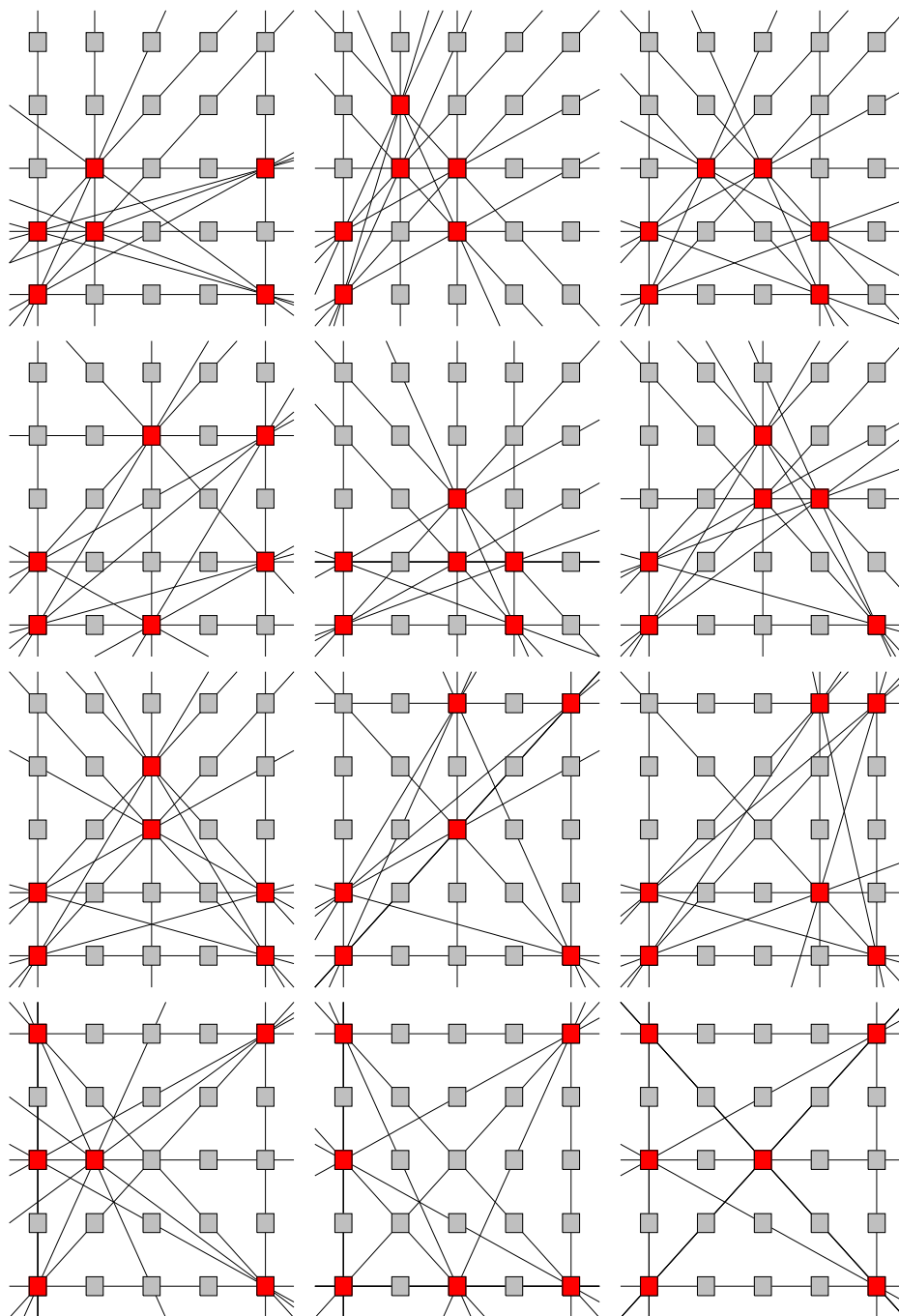
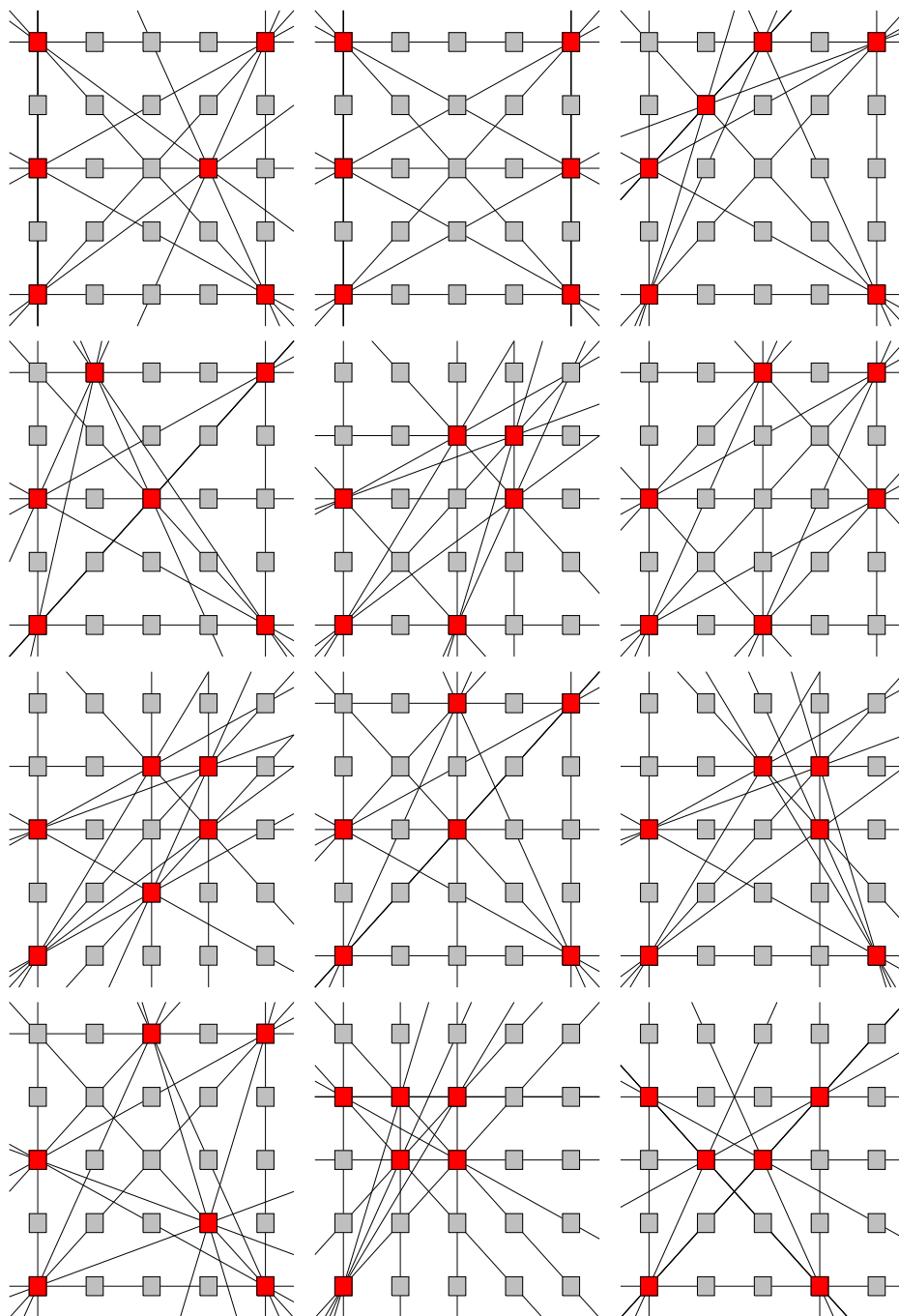

FIGURE 2.  $t(3) = 4$ .

FIGURE 3.  $t(4) = 6$ .

59 incongruential choices of selecting  $t(4) = 6$  vertices are known: Figures 3–7.

FIGURE 4.  $t(4) = 6$  (continued).

FIGURE 5.  $t(4) = 6$  (continued).

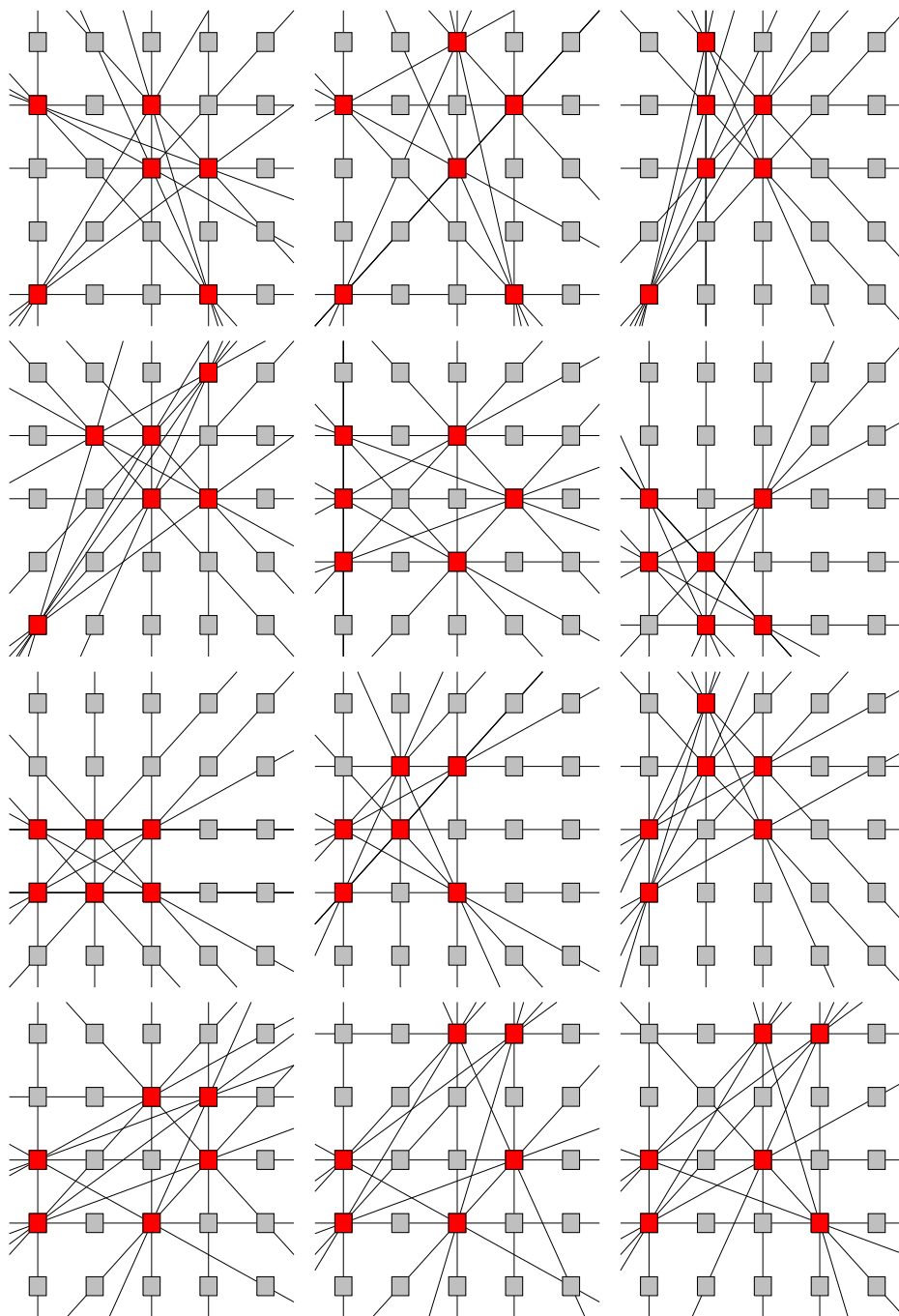
FIGURE 6.  $t(4) = 6$  (continued).

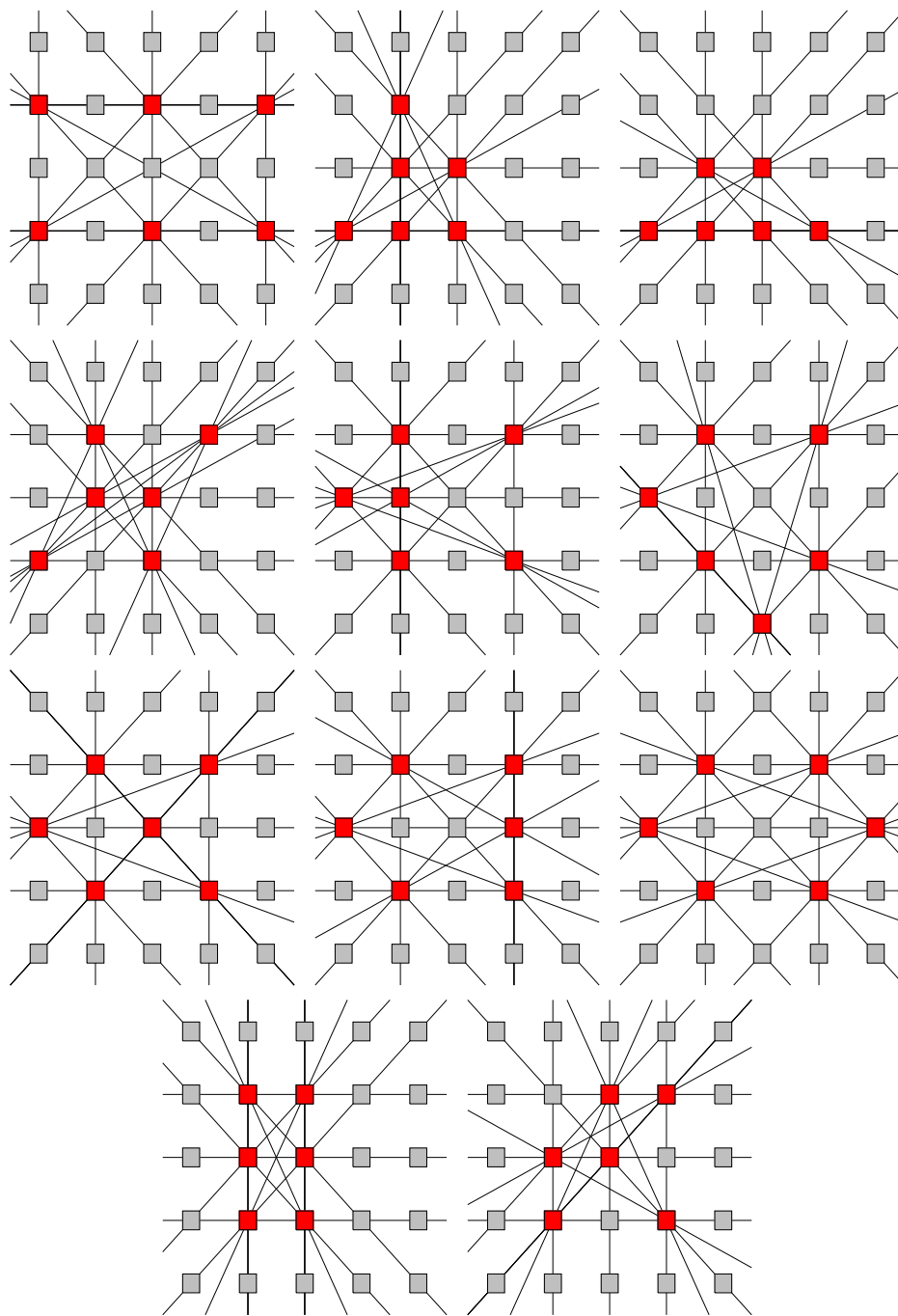
FIGURE 7.  $t(4) = 6$  (continued).

At  $n = 5$ , all 4 incongruent choices of coverage by  $t(5) = 6$  vertices are shown in Fig. 8. For three of these, the sublattice points fit already in the smaller  $n = 4$  lattice: the upper left is found in the second row, third column of Fig. 5. The upper right is found in the second row, third column of Fig. 6, in the third row second column of Fig. 6, and in the last row of Fig. 7. The last is found in the third row, first column of Fig. 6 and in the last row of Fig. 7.

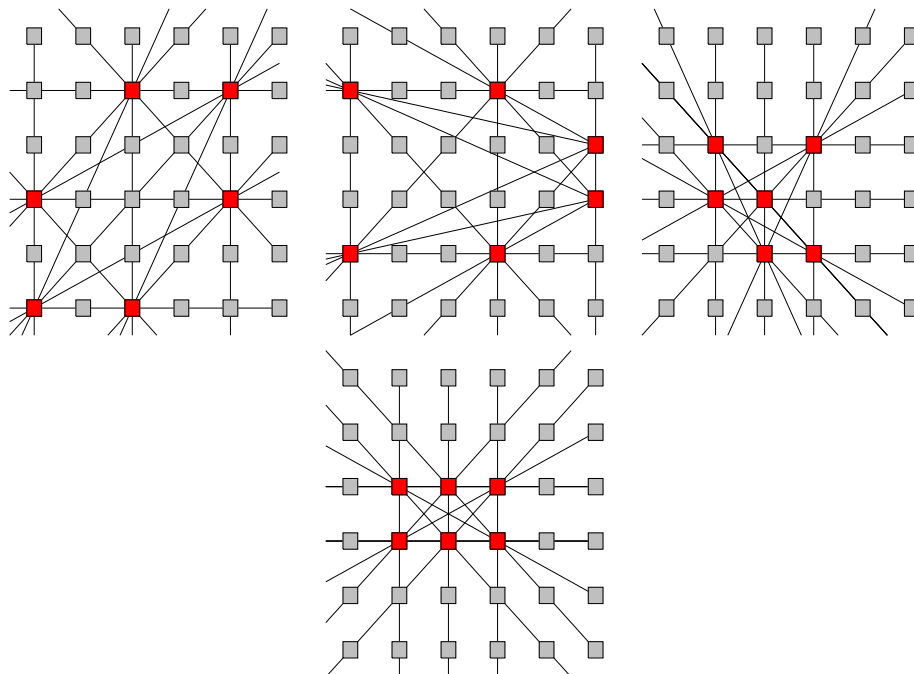

FIGURE 8.  $t(5) = 6$ .



Moving on to  $n = 6$ , some (but perhaps not all) choices of coverage by  $t(6) = 7$  vertices follow in Figure 9.

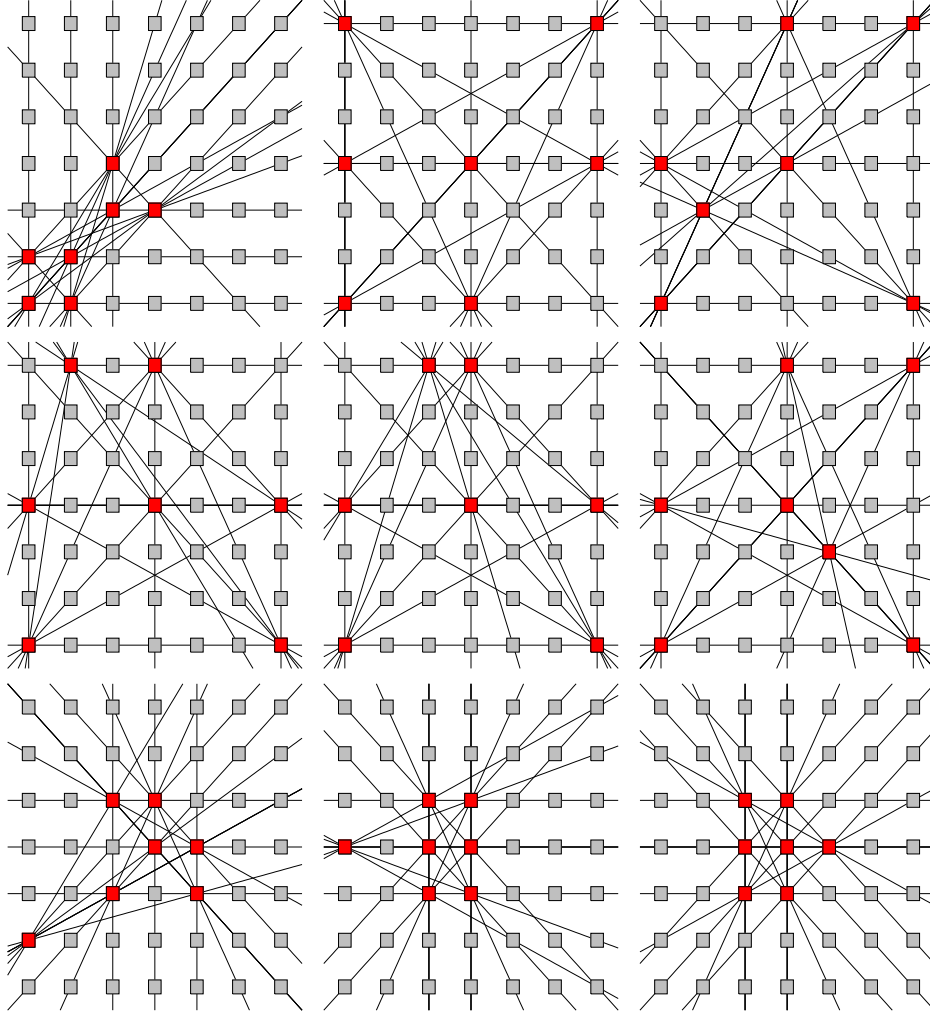

FIGURE 9.  $t(6) = 7$ . Two solutions have  $m_d$  or  $m_d'$  symmetry, two others  $m_x$  symmetry.

### 3. UPPER BOUNDS

**3.1. From Symmetric Design.** The upper bound

$$(1) \quad t(n) \leq 2n; \quad n \geq 2,$$

is found by selecting  $2n$  of the vertices along the two main diagonals of the lattice, with the exception of a column nearest to the middle vertical if  $n$  is odd, or with the exception of the middle vertical if  $n$  is even. Coverage is demonstrated by Figure 10.

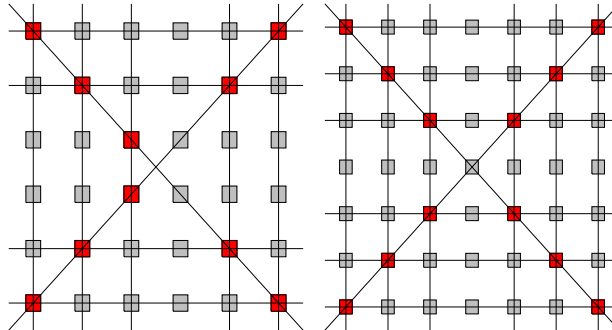

FIGURE 10. Symmetric, generally non-optimum solutions for odd  $n$  (left) or even  $n$  (right). Not all of the  $\binom{t}{2}$  base lines are shown, only the vertical, horizontal and diagonal ones which suffice to cover the lattice.

**3.2. From Recursion: Tapering Corners.** Once a covering for some  $n$  is found, a covering for  $n + 1$  is obtained by adding one row and one column to the lattice, and choosing three additional sublattice vertices: (i) at the intersection of the new row and column, (ii) one additional vertex of the new row, and (iii) one additional vertex of the new column. These obviously add (at least) two new lines which cover the new row and column:

$$(2) \quad t(n) \leq t(n-1) + 3.$$

This is often a weaker bound than (1) because the growth of (1) is only  $t(n) \sim t(n-1) + 2$ . This kind of relative growth estimate may result in better bounds if small  $t(n-1)$  have been found by any of the other means.

In an improved variant of this technique, one may upgrade any solution for a  $(n-1) \times (n-1)$  lattice to a solution for a  $(n+1) \times (n+1)$  lattice by placing four additional sublattice vertices just outside the four corners of the smaller lattice [5]. Coverage of the two new rows and two new columns that circumnavigate the four edges is ensured—see Fig. 11:

$$(3) \quad t(n) \leq t(n-2) + 4.$$

Fig. 10 could be bootstrapped by this synthesis.

Although it needs one more sublattice point than (2), it generally is advantageous since the index of  $t$  has been advanced by 2, not just by 1 as in (2).

**3.3. Areal Subdivision (Tiling).** If  $n$  is odd, the lattice can be subdivided into four square blocks (Northeast, Northwest, Southeast, Southwest) of size  $(n+1)/2 \times (n+1)/2$  each. Covering each of these blocks with  $t[(n-1)/2]$  vertices ensures coverage of the entire lattice. The same construction with partially overlapping 4 square blocks of size  $(n/2 + 1) \times (n/2 + 1)$  works for even  $n$ , so

$$(4) \quad t(n) \leq 4t(\lfloor n/2 \rfloor).$$

Similar formulas can be worked out by subdivision into 9, 16, 25 etc square blocks for  $n$  larger than some evident minimum.

Another aspect of this approach is that solutions equipped with sublattice vertices at each of the 4 corners can be stacked horizontally and vertically with one

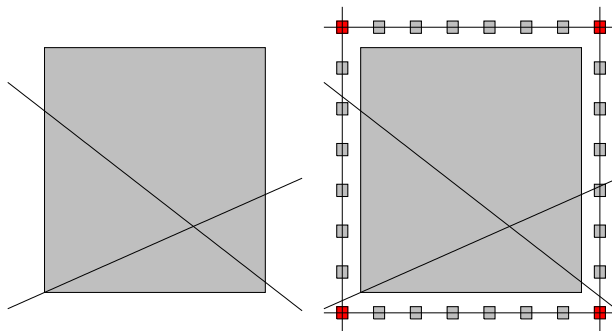

FIGURE 11. Generation of solutions for  $(n + 1) \times (n + 1)$  lattices from  $(n - 1) \times (n - 1)$  lattices associated with (3). The two random lines symbolize inheritance of base line coverage of the smaller lattice (left) to the larger one (right).

column and one row overlap, exploiting sublattice vertices points of these overlaps more than once. Taking the left case of Figure 2 as the building block, we arrive at designs with  $n = 3, 6, 9, \dots$  and the estimate

$$(5) \quad t(3i) \leq (i + 1)^2; \quad i = 1, 2, 3, \dots$$

Taking tiles from one of the three figures at the bottom row of Fig. 4 or the top left row of Fig. 5 we get

$$(6) \quad t(4i) \leq (i + 1)^2 + 2i^2; \quad i = 1, 2, 3, \dots$$

where  $(i + 1)^2$  counts the sublattice vertices at all the block's edges and  $2i^2$  the 'interstitial' vertices in each of the  $i^2$  blocks. Use of the additional shared edge vertex of the tile of the middle top row of Fig. 5 leads to a slightly better estimate

$$(7) \quad t(4i) \leq (i + 1)^2 + i(i + 1); \quad i = 1, 2, 3, \dots$$

The generic disadvantage of these estimates from subdivision is that they grow with some second order polynomial of  $n$ , so eventually they are not found to be competitive with the other approaches.

**3.4. From Central Star.** If one places one base line point at the lattice center ( $n$  even) or at a point closest to the center ( $n$  odd), coverage of the lattice is ensured if lines originating from there include the finite set of inclinations  $m = \Delta y / \Delta x$  needed to reach the other vertices displaced by  $\Delta x$  horizontally and  $\Delta y$  vertically from there [2, 3]. Scanning only one quadrant from one such vintage vertex (say, the Northeast, that is, under the constraint  $\Delta y > 0, \Delta x \geq 0$ ) yields a number of directions with 'visible' vertices essentially counted by sequence A049632 in the Online Encyclopedia of Integer Sequences [4], including the central vertex itself. Moving this vertex near the middle of the lattice takes advantage of the fact that the lines also cut backwards into the opposite quadrant, reduces the size of the quadrant to monitor to  $\lfloor (n + 3)/2 \rfloor \times \lfloor (n + 3)/2 \rfloor$ , and needs to scan one more quadrant to cover the full  $(n + 1) \times (n + 1)$  lattice. The number of reduced fractions  $\Delta y / \Delta x$ , plus one for the center point, provides another upper bound,

$$(8) \quad t(n) \leq 1 + 4 \times A002088(\lfloor (n + 1)/2 \rfloor),$$

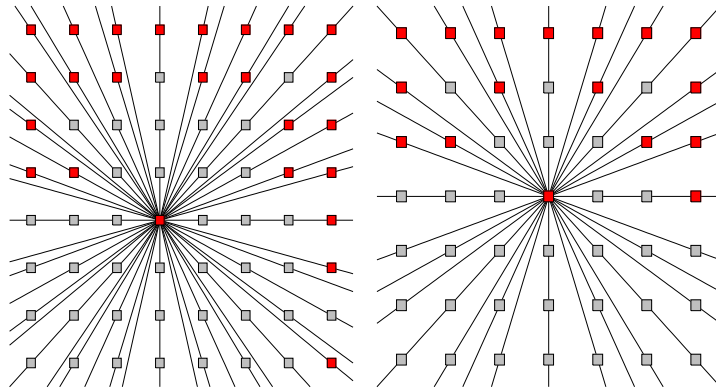

FIGURE 12. One central vertex and one more for each different value of line ascensions  $\Delta y/\Delta x$ . An example for odd  $n$  shown at the left, for even  $n$  at the right. Not all  $\binom{t}{2}$  lines are shown, only those that connect to the central vertex.

with reference to another sequence of Sloane's data base [4].

Obviously there is no improvement in comparison to (1) if no further pruning of vertices is possible.

**3.5. Monte Carlo Samples.** Distribution of red vertices randomly as an alternative to a massive complete search of all possible configurations leads to additional bounds, with examples in the final Figures 13–18. These are results of two search strategies, one allowing for random placement of the sublattice nodes, and a ‘symmetric’ version which ensures that they are placed as pairs on opposite sides of one of the two diagonals or pairs on opposite sides of the horizontal or vertical through the center. (This is inspired by the experience that at least one of the optimum solutions of the smaller  $n$  is of this class.)

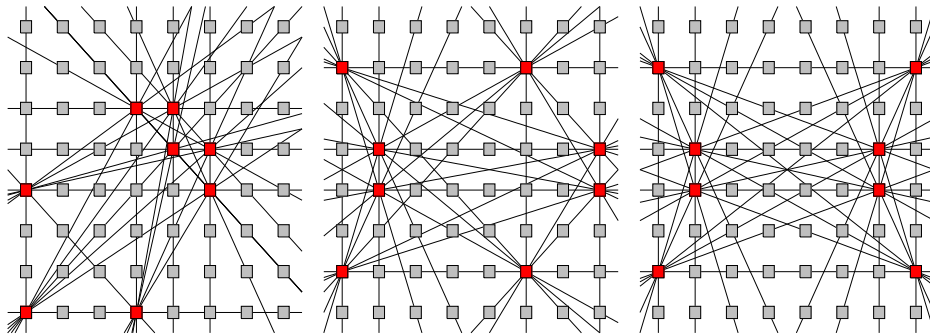
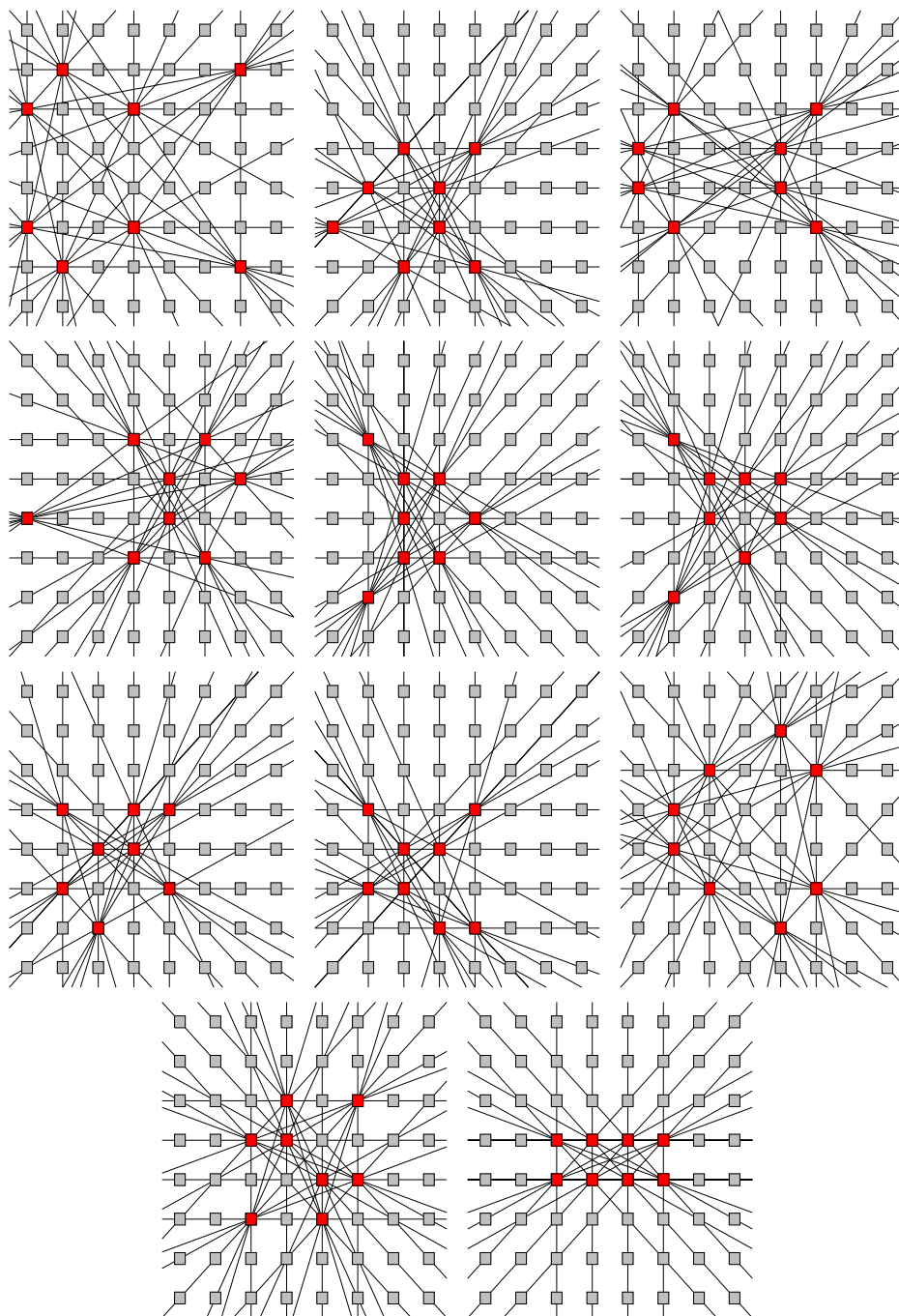
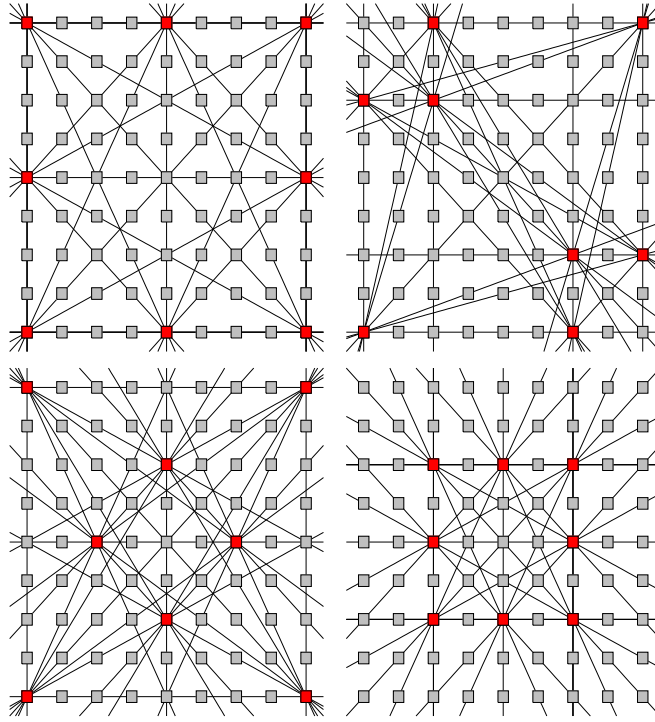
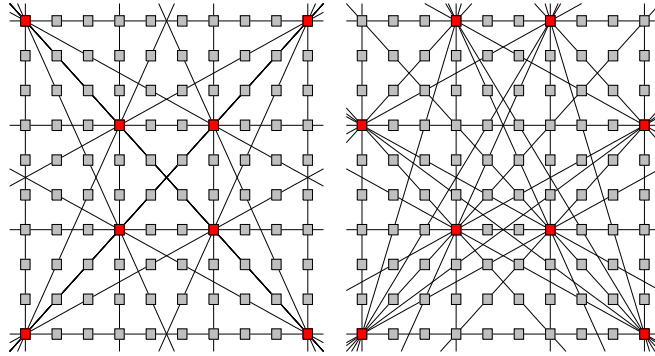
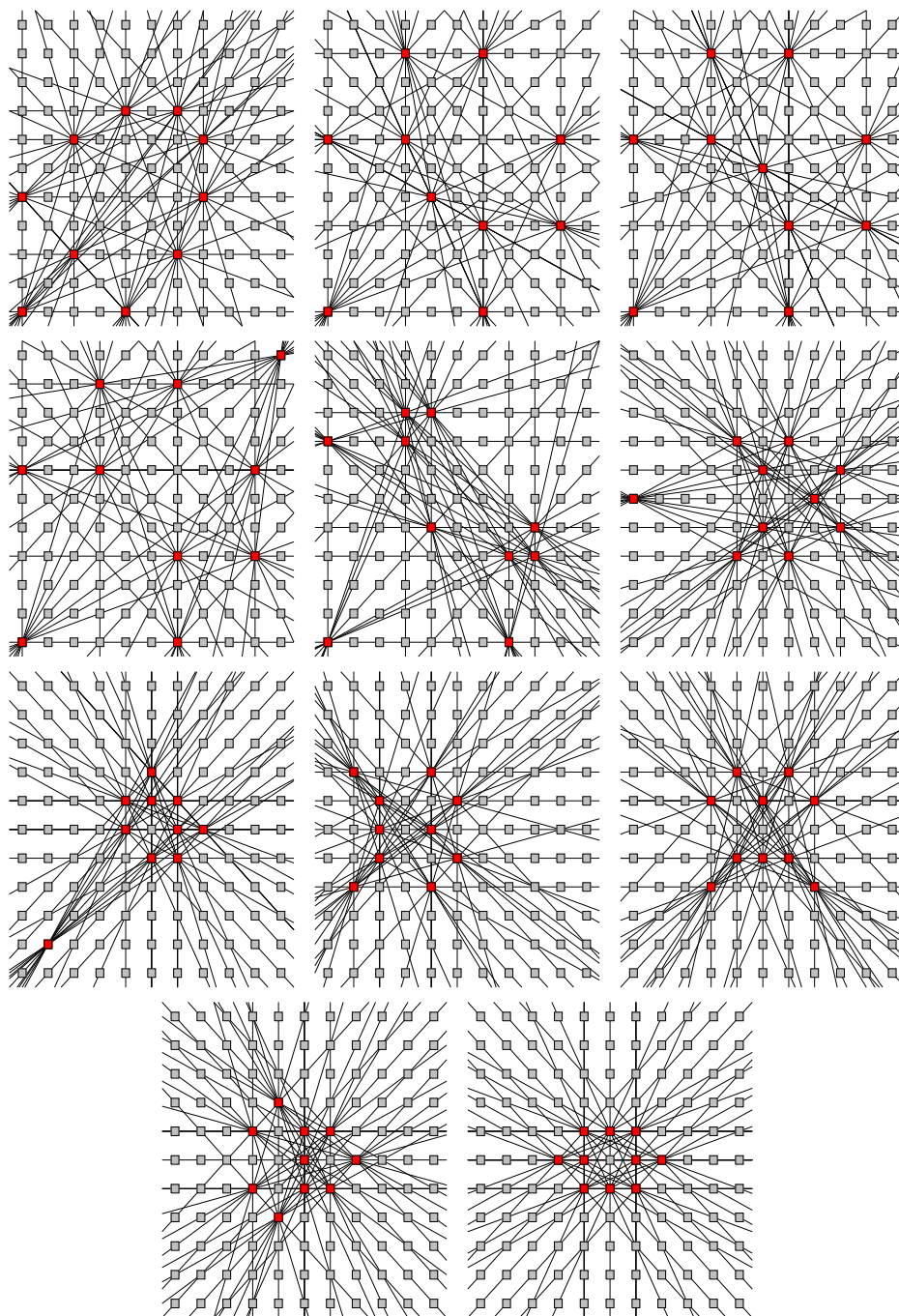

FIGURE 13.  $t(7) \leq 8$ .

FIGURE 14.  $t(7) \leq 8$  (continued).

FIGURE 15.  $t(8) \leq 8$ .FIGURE 16.  $t(9) \leq 8$ .

FIGURE 17.  $t(10) \leq 10$ .



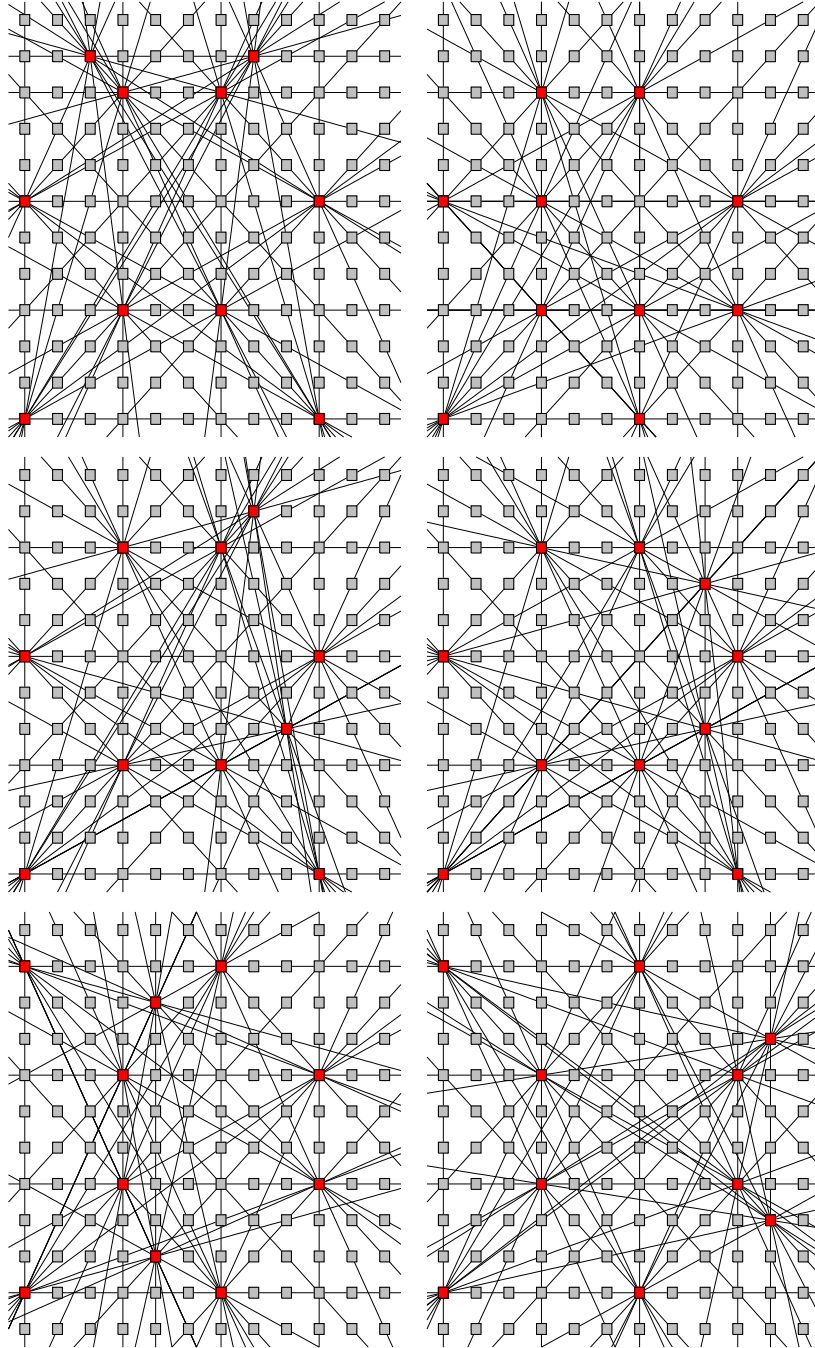

FIGURE 18.  $t(11) \leq 10$ . Cutting off the top row and right column generates solutions that might be added to Fig. 17.



One solution for each  $n$  in the range 12 to 36, then in larger steps up to  $n = 110$  is put into Table 1. This rendering of results saves space in comparison to figurative presentations, but symmetries of the sublattices are no longer evident.

$n$	$t(n)$	sublattice coordinates
12	$\leq 11$	(0,0) (0,3) (2,12) (3,6) (3,9) (6,3) (6,12) (9,6) (9,9) (12,0) (12,3)
13	$\leq 12$	(1,1) (2,5) (2,8) (3,10) (5,2) (5,11) (7,6) (8,2) (8,11) (11,5) (11,8) (12,12)
14	$\leq 13$	(4,4) (4,8) (5,5) (5,7) (6,6) (6,7) (6,8) (7,5) (7,6) (7,8) (8,4) (8,6) (8,7)
15	$\leq 13$	(5,7) (5,8) (6,6) (6,7) (6,9) (7,7) (7,8) (7,9) (8,6) (8,7) (8,9) (9,7) (9,8)
16	$\leq 14$	(0,6) (0,9) (3,3) (3,12) (5,6) (6,0) (6,12) (6,15) (9,0) (9,15) (12,3) (12,12) (15,6) (15,9)
17	$\leq 15$	(0,7) (0,10) (3,4) (3,13) (6,1) (6,16) (9,1) (9,16) (12,4) (12,13) (13,8) (13,9) (14,8) (15,7) (15,10)
18	$\leq 16$	(0,4) (2,8) (2,11) (3,7) (4,4) (5,5) (5,14) (8,2) (8,17) (9,15) (11,2) (11,17) (14,5) (14,14) (17,8) (17,11)
19	$\leq 16$	(1,3) (1,16) (2,8) (2,11) (5,5) (5,14) (8,2) (8,17) (11,2) (11,17) (14,5) (14,14) (16,3) (16,16) (17,8) (17,11)
20	$\leq 17$	(0,0) (0,7) (0,20) (5,5) (5,10) (6,13) (7,7) (7,13) (10,5) (10,15) (13,6) (13,7) (13,13) (15,10) (15,15) (20,0) (20,20)
21	$\leq 18$	(0,0) (0,21) (1,6) (3,9) (3,12) (6,6) (6,15) (9,3) (9,18) (12,3) (12,9) (12,18) (15,6) (15,15) (18,9) (18,12) (21,0) (21,21)
22	$\leq 19$	(0,2) (0,16) (1,4) (1,9) (1,14) (6,4) (6,14) (6,19) (10,7) (10,11) (11,4) (11,14) (12,5) (16,4) (16,14) (16,19) (17,8) (21,9) (21,14)
23	$\leq 21$	(0,1) (0,11) (0,16) (5,1) (5,6) (5,21) (10,16) (10,21) (11,20) (13,4) (15,1) (15,6) (15,21) (17,12) (19,14) (19,23) (20,1) (20,6) (20,11) (20,16) (23,12)
24	$\leq 21$	(0,6) (0,15) (2,8) (2,18) (7,3) (7,8) (7,13) (7,18) (7,23) (10,14) (11,16) (12,3) (12,23) (13,16) (17,3) (17,8) (17,13) (17,18) (17,23) (22,8) (22,18)
25	$\leq 21$	(0,0) (0,25) (4,11) (5,10) (5,15) (5,20) (6,6) (10,5) (10,10) (10,20) (11,9) (15,5) (15,15) (15,20) (19,16) (19,19) (20,5) (20,10) (20,15) (25,0) (25,25)
26	$\leq 23$	(0,0) (0,15) (0,25) (5,10) (5,20) (6,7) (6,18) (10,5) (10,15) (10,25) (13,17) (14,14) (14,18) (15,5) (15,10) (15,15) (15,20) (20,0) (20,10) (20,20) (25,5) (25,15) (25,25)
27	$\leq 23$	(0,8) (0,18) (5,3) (5,8) (5,13) (5,18) (5,23) (10,3) (10,8) (10,18) (10,23) (15,3) (15,8) (15,18) (15,23) (20,3) (20,8) (20,13) (20,18) (20,23) (25,8) (25,13) (25,18)
28	$\leq 24$	(1,4) (1,9) (1,14) (1,19) (2,8) (2,16) (2,21) (6,4) (6,9) (6,24) (11,19) (11,24) (16,4) (16,9) (16,24) (18,15) (21,4) (21,9) (21,14) (21,19) (24,7) (24,21) (26,9) (26,19)
29	$\leq 25$	(0,4) (2,2) (2,12) (2,22) (7,12) (7,17) (7,22) (7,27) (12,2) (12,7) (12,22) (12,27) (17,2) (17,7) (17,12) (19,28) (22,7) (22,22) (22,27) (27,12) (27,17) (27,22) (28,4) (28,13) (28,19)

Table 1...

$n$	$t(n)$	sublattice coordinates
30	$\leq 25$	(0,2) (0,12) (4,3) (5,17) (5,22) (5,27) (10,2) (10,7) (10,22) (10,27) (15,2) (15,7) (15,22) (20,17) (20,22) (20,27) (25,2) (25,7) (25,12) (25,17) (25,22) (29,6) (29,24) (30,12) (30,22)
31	$\leq 26$	(2,7) (2,12) (2,17) (2,22) (7,2) (7,7) (7,12) (7,17) (7,22) (7,27) (12,2) (12,7) (12,22) (12,27) (17,2) (17,7) (17,12) (17,17) (17,22) (17,27) (22,7) (22,12) (22,17) (22,22) (27,12) (27,17)
32	$\leq 27$	(0,8) (0,13) (0,18) (0,23) (5,3) (5,18) (5,23) (5,28) (10,3) (10,8) (10,13) (11,19) (15,8) (15,23) (15,28) (20,8) (20,23) (20,28) (25,3) (25,8) (25,13) (25,28) (29,10) (30,13) (30,18) (30,23) (30,28)
33	$\leq 28$	(0,14) (0,19) (1,15) (5,9) (5,24) (8,13) (8,20) (9,21) (10,9) (10,14) (10,19) (10,24) (11,18) (12,26) (15,9) (15,19) (15,24) (20,4) (20,9) (20,29) (25,4) (25,19) (25,24) (25,29) (30,9) (30,14) (30,19) (30,24)
34	$\leq 28$	(0,5) (0,15) (0,20) (5,0) (5,25) (10,10) (10,15) (10,20) (10,25) (15,0) (15,5) (15,10) (15,25) (15,30) (19,22) (20,5) (20,10) (24,17) (25,5) (25,10) (25,15) (25,20) (25,25) (25,30) (30,10) (30,15) (30,20) (30,25)
35	$\leq 29$	(0,5) (1,1) (1,6) (1,11) (6,11) (6,16) (6,21) (6,26) (11,1) (11,6) (11,11) (11,16) (11,21) (11,26) (16,6) (16,11) (16,26) (16,31) (21,6) (21,11) (21,31) (26,6) (26,11) (26,16) (26,26) (26,31) (31,16) (31,21) (31,26)
36	$\leq 30$	(3,3) (3,13) (3,18) (3,28) (7,27) (8,13) (8,18) (8,23) (8,28) (10,11) (13,3) (13,28) (18,3) (18,8) (18,23) (18,28) (18,33) (20,29) (23,8) (23,13) (23,18) (23,23) (23,28) (23,33) (28,8) (28,13) (28,18) (28,23) (33,8) (33,23)
40	$\leq 33$	(2,10) (2,17) (2,24) (9,3) (9,10) (9,17) (9,24) (9,31) (10,9) (15,30) (16,3) (16,10) (16,17) (16,24) (16,31) (16,38) (23,3) (23,10) (23,17) (23,24) (23,31) (23,38) (24,30) (30,3) (30,10) (30,17) (30,24) (30,31) (36,9) (37,10) (37,17) (37,24) (37,31)
50	$\leq 41$	(0,6) (0,20) (0,34) (6,10) (7,13) (7,27) (7,34) (7,41) (7,48) (14,6) (14,13) (14,18) (14,20) (14,34) (14,41) (21,6) (21,13) (21,27) (21,34) (21,41) (21,48) (28,6) (28,13) (28,34) (28,41) (28,48) (35,6) (35,13) (35,20) (35,34) (35,41) (35,48) (40,45) (42,13) (42,20) (42,27) (42,34) (42,41) (49,6) (49,13) (49,20)
60	$\leq 52$	(0,12) (0,26) (0,40) (0,47) (1,26) (1,33) (7,5) (7,12) (7,47) (7,54) (14,5) (14,19) (14,26) (14,47) (14,54) (21,5) (21,12) (21,19) (21,26) (21,33) (21,40) (24,10) (28,19) (28,40) (28,54) (35,12) (35,19) (35,26) (35,33) (35,40) (35,47) (35,54) (42,5) (42,12) (42,19) (42,26) (42,33) (42,40) (42,47) (43,43) (44,38) (45,25) (49,19) (49,40) (49,47) (54,15) (56,5) (56,19) (56,40) (56,54) (59,8) (59,59)
63	$\leq 55$	(2,6) (2,52) (2,55) (5,3) (5,14) (5,25) (5,36) (5,47) (5,58) (11,34) (11,61) (13,20) (13,52) (14,4) (16,3) (16,14) (16,25) (16,36) (16,47) (16,58) (17,20) (20,28) (27,3) (27,14) (27,25) (27,36) (27,47) (27,58) (29,52) (34,41) (38,3) (38,14) (38,25) (38,36) (38,47) (38,58) (43,21) (45,2) (49,3) (49,14) (49,25) (49,36) (49,47) (49,58) (55,6) (57,8) (57,61) (59,49) (59,53) (60,3) (60,14) (60,25) (60,36) (60,47) (60,58)

Table 1...

$n$	$t(n)$	sublattice coordinates		
70	$\leq 63$	(0,9) (6,3) (6,14) (6,25) (6,36) (6,47) (6,58) (6,69) (7,12) (8,62)		
		(10,62) (11,58) (16,42) (17,3) (17,14) (17,25) (17,36) (17,47) (17,58)		
		(17,69) (20,28) (22,43) (27,9) (28,3) (28,14) (28,25) (28,36) (28,47)		
		(28,58) (28,66) (28,69) (29,37) (33,31) (35,1) (36,18) (39,3) (39,14)		
		(39,25) (39,36) (39,47) (39,58) (39,69) (40,63) (47,19) (50,3) (50,14)		
		(50,25) (50,36) (50,47) (50,58) (50,69) (56,52) (57,66) (58,65)		
		(59,43) (60,12) (60,13) (61,3) (61,14) (61,25) (61,36) (61,47) (61,58)		
		80	$\leq 69$	(0,4) (0,51) (1,1) (1,12) (1,23) (1,34) (1,67) (5,7) (6,31) (6,42)
				(12,1) (12,23) (12,45) (12,56) (12,67) (12,78) (18,72) (20,18) (22,0)
				(23,1) (23,12) (23,23) (23,34) (23,45) (23,56) (23,67) (23,78) (29,4)
				(29,80) (34,12) (34,23) (34,34) (34,45) (34,56) (34,67) (34,78)
				(38,42) (38,74) (40,13) (45,1) (45,23) (45,34) (45,56) (45,67) (45,78)
				(49,31) (49,74) (56,12) (56,23) (56,34) (56,45) (56,56) (56,67)
(56,78) (61,49) (67,1) (67,12) (67,23) (67,34) (67,56) (67,67) (67,78)				
(69,51) (69,80) (73,71) (78,12) (78,23) (78,45) (78,67)				
90	$\leq 80$			(1,3) (1,59) (9,2) (9,65) (10,3) (10,72) (16,16) (16,23) (16,30)
				(16,37) (16,44) (16,51) (16,58) (16,65) (16,72) (19,13) (23,16)
				(23,23) (23,30) (23,37) (23,65) (23,67) (23,72) (23,79) (28,27)
				(28,67) (30,9) (30,16) (30,23) (30,30) (30,37) (30,44) (30,51) (30,58)
				(30,65) (37,9) (37,30) (37,51) (37,79) (40,23) (41,27) (41,58) (42,6)
		(42,26) (44,16) (44,54) (44,58) (44,65) (51,23) (51,30) (51,44)		
		(51,65) (51,72) (51,79) (54,44) (56,26) (56,59) (58,9) (58,16) (58,44)		
		(58,58) (65,23) (65,30) (65,44) (65,58) (65,65) (65,72) (65,79)		
		(68,40) (72,16) (72,23) (72,58) (72,65) (72,72) (79,2) (79,23) (79,44)		
		(79,51) (86,9) (86,44)		
		101	$\leq 90$	(0,5) (0,16) (0,27) (0,60) (0,71) (0,82) (2,7) (10,89) (11,5) (11,14)
				(11,27) (11,38) (11,60) (11,71) (11,82) (11,93) (14,88) (22,5) (22,11)
				(22,16) (22,27) (22,38) (22,49) (22,60) (22,71) (22,82) (22,93)
(26,46) (30,4) (30,14) (32,64) (33,5) (33,16) (33,27) (33,49) (33,60)				
(33,71) (33,82) (33,93) (44,5) (44,16) (44,27) (44,38) (44,93) (49,24)				
(49,55) (50,54) (55,16) (55,27) (55,38) (55,49) (55,60) (55,71)				
(55,82) (55,93) (56,96) (62,100) (66,16) (66,27) (66,49) (66,71)				
(66,82) (66,93) (72,30) (74,68) (76,48) (77,5) (77,16) (77,27) (77,38)				
(77,49) (77,60) (77,82) (84,45) (85,89) (88,16) (88,27) (88,49)				
(88,71) (88,82) (88,93) (89,42) (90,38) (91,46) (91,54) (99,38)				
(99,49) (99,60) (99,71) (99,82)				

Table 1...

$n$	$t(n)$	sublattice coordinates
110	$\leq 100$	(1,4) (1,91) (4,94) (6,22) (18,6) (20,4) (20,21) (38,73) (40,58) (41,54) (42,48) (44,44) (44,55) (46,10) (46,44) (46,46) (47,33) (47,47) (47,50) (48,28) (48,42) (48,45) (48,49) (49,48) (49,55) (50,24) (50,34) (50,45) (51,45) (51,48) (51,49) (52,48) (52,49) (52,51) (52,54) (53,43) (53,48) (53,50) (53,52) (53,53) (54,39) (54,43) (54,47) (54,49) (54,50) (54,51) (55,21) (55,39) (55,40) (55,42) (55,46) (55,49) (55,53) (56,45) (56,47) (56,53) (56,55) (57,43) (57,44) (57,47) (58,30) (58,46) (58,47) (58,49) (58,50) (58,53) (59,46) (59,50) (59,51) (59,52) (60,24) (60,34) (60,41) (60,49) (61,41) (61,50) (61,51) (61,62) (62,28) (62,40) (62,42) (63,42) (63,44) (63,47) (64,10) (64,46) (64,48) (65,42) (65,50) (66,45) (66,77) (69,64) (70,52) (70,76) (74,76) (80,7) (91,11) (92,6) (106,94) (109,91)

Table 1: Examples of coverage of some larger arrays. The sublattice points' Cartesian coordinates  $(x, y)$  are listed in the range  $0 \leq x, y \leq n$ .

#### 4. SUMMARY

Square lattices of size  $3 \times 3$  or  $4 \times 4$  can be covered by base lines spanned by sublattices of order  $t = 4$ . For square lattices of size  $5 \times 5$  or  $6 \times 6$ , sublattices must be at least of order  $t = 6$ , for size  $7 \times 7$  of order  $t = 7$ . For all other  $(n+1) \times (n+1)$  lattices studied, the order stayed below an upper limit of  $t(n) < (n+1)^{2/3} \log(n+1)$ .

#### REFERENCES

1. N. Alon, *Economical coverings of sets of lattice points*, Geom. Func. Anal. **1** (1991), no. 3, 225–230. MR 1118729 (92g:52017)
2. X. W. C. Faber, *On the finite field Kakeya problem in two dimensions*, arXiv:math/0510356 [math.NT] (2005).
3. ———, *On the finite field Kakeya problem in two dimensions*, J. Number Theory **124** (2007), no. 1, 248–257. MR 2321004
4. Neil J. A. Sloane, *The On-Line Encyclopedia Of Integer Sequences*, Notices Am. Math. Soc. **50** (2003), no. 8, 912–915, <http://www.research.att.com/~njas/sequences/>. MR 1992789 (2004f:11151)
5. Stefan Steinerberger, priv. commun., 4 February 2008.
6. T. Terzibaschian and R. Enderlein, *The irreducible representations of the two-dimensional space group of crystal surfaces*, phys. stat. sol. b **133** (1986), no. 2, 443–461.  
URL: <http://www.strw.leidenuniv.nl/~mathar>

LEIDEN OBSERVATORY, LEIDEN UNIVERSITY, P.O. BOX 9513, 2300 RA LEIDEN, THE NETHERLANDS