

THE PLANAR ALGEBRA OF GROUP-TYPE SUBFACTORS

DIETMAR BISCH, PARAMITA DAS, AND SHAMINDRA KUMAR GHOSH

ABSTRACT. If G is a countable, discrete group generated by two finite subgroups H and K and P is a II_1 factor with an outer G -action, one can construct the group-type subfactor $P^H \subset P \rtimes K$ introduced in [3]. This construction was used in [3] to obtain numerous examples of infinite depth subfactors whose standard invariant has exotic growth properties. We compute the planar algebra (in the sense of Jones [11]) of this subfactor and prove that any subfactor with an abstract planar algebra of "group type" arises from such a subfactor. The action of Jones' planar operad is determined explicitly.

1. INTRODUCTION

The technique of *composing subfactors* pioneered in [3] led to a zoo of exotic subfactors of the hyperfinite II_1 factor. In particular, the first examples of irreducible, amenable subfactors that are not strongly amenable (in the sense of [17]) were constructed in this way in [3]. The idea is simple: Let H and K be two finite groups with an outer action on a II_1 factor P (e.g. the hyperfinite II_1 factor) and consider the composition of the fixed-point subfactor $P^H \subset P$ with the crossed product subfactor $P \subset P \rtimes K$ to obtain, what we will call here, a *group-type subfactor* $P^H \subset P \rtimes K$. If P is hyperfinite, analytical properties of this subfactor, such as amenability and property (T) in the sense of Popa ([17], [18]), were proved to be equivalent to the corresponding properties (amenability, property (T) in the sense of Kazhdan) of the group G generated by H and K in the outer automorphism group of P ([3], [6]). Note that a group-type subfactor is obtained from the two fixed-point subfactors $P^H \subset P$ and $P^K \subset P$ by performing the basic construction of [10] to one of them. A group-type subfactor is therefore an invariant for the relative position of the two fixed-point subfactors. For more on this, see [12].

The main invariant for a subfactor is the so-called *standard invariant* (see for instance [9], [8], [13]). It is a very sophisticated mathematical object that can be portrayed in a number of seemingly quite different ways. For example, it has descriptions as a certain category of bimodules ([14], see also [2]), as a lattice of algebras ([16]), or as a planar algebra ([11]). Jones' planar algebra technology has become a very efficient tool to capture and analyze the standard invariant of a subfactor.

Composition of subfactors was the motivating idea that led to the results in [4]. It was proved there that two standard invariants without extra structure, i.e. consisting of just the Temperley-Lieb algebras, can always be composed freely to form a new standard invariant – namely the one generated by the Fuss-Catalan algebras of [4]. This concept of *free composition* was then pushed much further in

Key words and phrases. planar algebra, planar operad, subfactor, IRF model.
The authors were supported by NSF under Grant No. DMS-0301173.

[5], where it is shown that any two planar algebras arising from subfactors can be composed freely to form a new subfactor planar algebra.

The principal graphs of a subfactor encode the algebraic information contained in the standard invariant ([9]), and their structure determines the growth properties of the invariant. It was shown in [3] that subfactors whose standard invariants have very exotic growth properties exist by constructing concrete group-type subfactors. The principal graphs of these subfactors were computed there. In this paper we go a step further and give a concrete description of the standard invariant (or equivalently the planar algebra) of the group-type subfactors. We concentrate on the case when the group G , generated by H and K in the automorphism group of P , has an outer action on P . Note that any group G generated by two finite subgroups H and K has such an action on the hyperfinite II_1 factor (for instance by a Bernoulli shift action). We find a description of the planar algebra of these group-type subfactors that is reminiscent of an IRF (interaction round a face) model in statistical mechanics. The general case, where G is generated by H and K in the *outer* automorphism group of P , and hence may or may not lift to an action of G on P , is much more elaborate and will be treated in a separate paper.

Here is a more detailed outline of the sections of this paper. We review in section 2 the basic notions of planar algebras. In section 3, we define an abstract planar algebra \mathcal{P} associated to a countable, discrete group G and two of its finite subgroups H and K which generate G . The vector spaces underlying the planar algebra are spanned by alternating words in H and K that multiply to the identity element. The action of Jones' planar operad is given explicitly by a particular labelling of planar tangles that can be viewed as an IRF-like model. It takes some work to show that the action of planar tangles is well-defined and preserves composition. The latter is achieved by showing that the action respects composition with certain elementary tangles that generate any annular tangle. We then analyze the filtered $*$ -algebra structure of \mathcal{P} and determine the action of Jones projection and conditional expectation tangles.

In section 4 we compute the basic construction and higher relative commutants of a group-type subfactor $P^H \subset P \rtimes K$. We exhibit a nice basis which is used in section 5 to prove that the abstract group-type planar algebra of section 3 is indeed isomorphic to the concrete one computed in section 4. Moreover, we prove in section 5 that if the standard invariant of an arbitrary subfactor is isomorphic to a group-type planar algebra, then the subfactor is indeed of group-type. This is proved using results on intermediate subfactors from [1], [5], [7].

2. PLANAR ALGEBRA BASICS

In this section, we will give a very brief overview of planar algebras; the reader is encouraged to see [11] for details. Let us first describe the key ingredients that constitute a *planar tangle*.

- There is an external disc, several (possibly none) internal discs and a collection of disjoint smooth curves.
- To each disc - internal or external, we attach a non-negative integer. This integer will be referred to as the 'color' of the disc. If a disc has color $k > 0$, there will be $2k$ points on the boundary of the disc marked $1, 2, \dots, 2k$ counted clockwise, starting with a distinguished marked point, which is

decorated with ‘*’. A disc having color 0 will have no marked points on its boundary.

- Each of the curves is either closed, or joins a marked point on the boundary of a disc to another such point, meeting the boundary of the disc transversally. Each marked point must be the endpoint of exactly one curve.
- The whole picture has to be planar, in the sense that there should be no crossing of curves or overlapping of discs.
- Finally, we will not distinguish between pictures obtained from one another by planar isotopy preserving the *’s.

The data of such a picture will be termed as a *planar k -tangle*, where k refers to the color of its external disc.

Remark 2.1. We can induce a black-and-white shading on the complement of the union of the internal discs and curves in the external disc by specifying that the region between the last and first marked point be left unshaded. This leaves a scope for ambiguity in the case of 0-discs, thus, 0-discs may be of two types depending on whether the region surrounding their boundary is shaded or unshaded.

Given a planar k -tangle T - one of whose internal discs have color k_i - and a k_i -tangle S , one can define the k -tangle $T \circ_i S$ by isotoping S so that its boundary, together with the marked points and the ‘*’ coincides with that of D_i and then erasing the boundary of D_i . The collection of tangles - along with the composition defined thus - is called the *colored operad of planar tangles*.

A planar algebra is a collection of vector spaces $\{P_k\}_{k \geq 0}$ such that every k -tangle T that has b internal discs D_1, D_2, \dots, D_b having colors k_1, k_2, \dots, k_b respectively gives rise to a multilinear map $Z_T : P_{n_1} \times P_{n_2} \times \dots \times P_{n_b} \rightarrow P_{n_0}$. The collection of maps is required to be compatible with substitution of tangles and renumbering of internal discs.

3. AN ABSTRACT PLANAR ALGEBRA

In this section we will abstractly define a planar algebra which will be identified in section 5 to be the one corresponding to the *group-type subfactor* $P^H \subset P \rtimes K$ of [3].

Let G be a group generated by two of its finite subgroups H and K and e denote the identity element of G . Let us define

$$S_n = \begin{cases} \{e\} & \text{if } n = 0 \\ \underbrace{K \times H \times K \times H \times \dots}_{(n \text{ factors})} & \text{if } n \geq 1 \end{cases}$$

$$S = \prod_{n \geq 0} S_n$$

$$L_n = \begin{cases} K, & \text{if } n \text{ is even} \\ H, & \text{otherwise} \end{cases}$$

Let $\mu : S \rightarrow G$ be the multiplication map. With the above notation, we are ready to define the planar algebra but first we would need some terminology.

Terminology: By a *face* in an unlabelled tangle T , we will mean a connected component of $D_0 \setminus [(\cup_{i=1}^b D_i) \cup \mathcal{S}]$ where D_0 is the external disc, D_i is the i -th internal disc for $i = 0, 1, 2, \dots, b$ and \mathcal{S} is the set of strings of (an element in the isotopy class of) T . By an *opening* in a tangle, we will mean the subset of the boundary of a disc lying between two consecutive marked points. An opening will be called *internal* (resp., *external*) if it is a subset of the boundary of the internal (resp., external) disc. Note that the boundary of a generic face may be disconnected due to the presence of loops or networks inside it (see Figure 1). The set of connected components of the boundary of each face will have a single *outer component* and several (possibly none) *inner component(s)*.

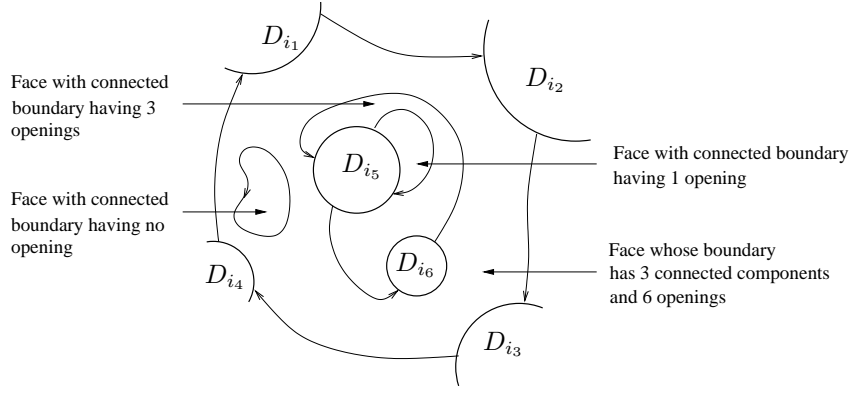

FIGURE 1. Example of faces in a tangle

Definition 3.1. A *state* f on a tangle T is a function $f : \{\text{all openings in } T\} \rightarrow H \amalg K$ such that following holds:

- (i) $f(\alpha) \in \begin{cases} K, & \text{if the face containing } \alpha \text{ is shaded,} \\ H, & \text{otherwise.} \end{cases}$
- (ii) *Triviality on the outer component of the boundary of a face:*
Let $\alpha_1, \alpha_2, \dots, \alpha_m$ be the openings on the outer component of the boundary of a face counted clockwise, then we must have

$$f(\alpha_1)^{\eta_1} f(\alpha_2)^{\eta_2} \dots f(\alpha_m)^{\eta_m} = e$$

$$\text{where } \eta_i = \begin{cases} +1, & \text{if } \alpha_i \text{ is an external opening,} \\ -1, & \text{otherwise.} \end{cases}$$

- (iii) *Triviality on internal discs:*
 f induces a map $\partial f : \{D_0, D_1, \dots, D_b\} \rightarrow \amalg_{n \geq 0} S_n$ defined by

$$\partial f(D_i) = (f(\alpha_1^{(i)}), f(\alpha_2^{(i)}), \dots, f(\alpha_{2n_i}^{(i)})) \in S_{2n_i}$$

where $\alpha_1^{(i)}, \alpha_2^{(i)}, \dots, \alpha_{2n_i}^{(i)}$ are consecutive openings counted clockwise such that $\alpha_1^{(i)}$ is the opening between the first and the second marked points of ∂D_i .
We demand that $\mu(\partial f(D_i)) = e$, for all $i = 1, 2, \dots, b$.

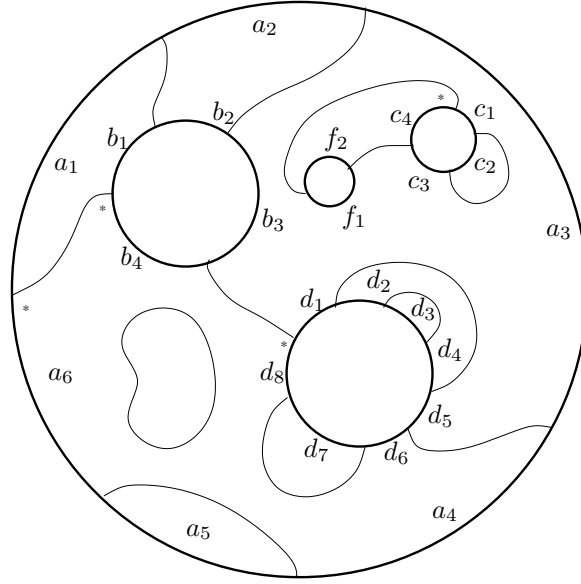

FIGURE 2. An example of a state on an unlabelled tangle

Note that triviality on the external disc and every boundary component of every face follows (see Remark 3.2 for a proof of this fact).

The above definition also applies to networks (positively or negatively oriented).

Figure 2 illustrates conditions (ii) and (iii) of Definition 3.1; triviality on internal discs give $b_1 b_2 b_3 b_4 = c_1 c_2 c_3 c_4 = d_1 d_2 d_3 d_4 d_5 d_6 d_7 d_8 = f_1 f_2 = e$ and triviality on the outer component of the boundaries of faces give $a_1 b_1^{-1} = a_2 b_2^{-1} = a_3 d_5^{-1} d_1^{-1} b_3^{-1} = c_4^{-1} f_2^{-1} = c_2 = d_2^{-1} d_4^{-1} = d_3 = a_4 a_6 b_4^{-1} d_8^{-1} d_6^{-1} = d_7 = a_5 = e$. Note that the above relations also imply $a_1 a_2 a_3 a_4 a_5 a_6 = e$, and $c_1^{-1} c_3^{-1} f_1^{-1} = e$.

As the computation involving Figure 2 suggests, triviality on inner boundaries of a face and on the external disc are actually consequences of the definition of a state. This is made precise in the following remark.

Remark 3.2. Let f be a state on a tangle or a network. Then the following conditions hold:

- (ii)' *Triviality on every inner component of the boundary of a face:*
For every inner component of the boundary of a face with openings $\alpha_1, \alpha_2, \dots, \alpha_m$ counted clockwise, we have $f(\alpha_1) f(\alpha_2) \cdots f(\alpha_m) = e$.
- (iii)' *Triviality on the external disc:*
This is just a restatement of condition (iii) in Definition 3.1 applied to the external disc only if its color is greater than zero.

We prove the above remark using planar graphs. Without loss of generality, we may start with a tangle or a network which is *connected*. By a network or a tangle (with non-zero color on its external disc) being connected, we mean that the union of the boundaries of all the discs and strings is a connected set; a 0-tangle is said to be connected if the network obtained after removing its external disc is connected.

To each tangle or network, we associate a planar graph whose vertex set is the set of all marked points on the internal and external discs, and the edges are the openings and the strings. Further, we make this graph a directed one in such a way that the directions on the edges arising from the openings are induced by clockwise orientation on the boundary of the discs, and the remaining edges (coming from the strings) are free to have any direction. Any state f assigns group elements to edges arising from openings; we label each of the remaining edges by e and that is why we did not put any restriction on the direction of such edges. Note that the definition of the state implies the following condition on the group labelled planar directed graph:

*Triviality on the boundary each bounded face of the graph*¹:

If g_1, g_2, \dots, g_m are the group elements assigned to consecutive edges around a face read clockwise, then

$$g_1^{\eta_1} g_2^{\eta_2} \cdots g_m^{\eta_m} = e$$

where $\eta_i = \begin{cases} +1, & \text{if } i\text{-th edge induces clockwise orientation in the face,} \\ -1, & \text{otherwise.} \end{cases}$

To establish Remark 3.2, it is enough to prove *triviality on the boundary of the unbounded face*. To see this, we first consider a pair of bounded faces which have at least one vertex or edge in common. If this pair is considered as a separate graph, then using triviality on each face, it is easy to check triviality on the boundary of the unbounded face of this pair. One can then use this fact inductively to deduce the desired result for the whole graph.

Next, we give the definition of the planar algebra. Let the set of states on a tangle T be denoted by $\mathcal{S}(T)$.

The vector spaces: For $n \geq 0$, define $P_n = \mathbb{C}\{\underline{s} \in S_{2n} : \mu(\underline{s}) = e\}$.

Action of tangles: Let T be an unlabelled tangle with (possibly zero) internal disc(s) D_1, D_2, \dots, D_b and external disc D_0 where the color of D_i is n_i . Then T defines a multilinear map, denoted by $Z_T : P_{n_1} \times P_{n_2} \cdots \times P_{n_b} \rightarrow P_{n_0}$. We will define $Z_T(\underline{s}_1, \underline{s}_2, \dots, \underline{s}_b) \in P_{n_0}$, where $\underline{s}_i \in S_{2n_i}$ such that $\mu(\underline{s}_i) = e$. Infact, we will just prescribe the coefficient of $\underline{s}_0 \in S_{2n_0}$ (such that $\mu(\underline{s}_0) = e$) in the expansion of $Z_T(\underline{s}_1, \underline{s}_2, \dots, \underline{s}_b)$ in terms of the canonical basis mentioned above.

We choose and fix a representative in the isotopy class of T and call it the *standard form* of T , denoted by \tilde{T} . It is assumed to satisfy the following properties:

- \tilde{T} is in rectangular form - meaning that - all of its discs are replaced by boxes and it is placed in \mathbb{R}^2 in such a way that the boundaries of the boxes are parallel to the co-ordinate axes.
- The first marked point on the boundary of each box is on the top left corner.
- The collection of strings have finitely many local maxima or minima.
- The external box can be sliced by horizontal lines in such a way that each maxima, minima, internal box is in a different slice.

To each local maximum or minimum of a string with end-points, we assign a scalar according to Figure 3. Let $p(T)$ denote the product of all scalars arising from the local maxima or minima and $n_+(T)$ (resp., $n_-(T)$) be the number of non-empty

¹Since we started with a connected tangle or network, the associated planar graph will be connected; in particular, boundary of each face of the graph will be connected

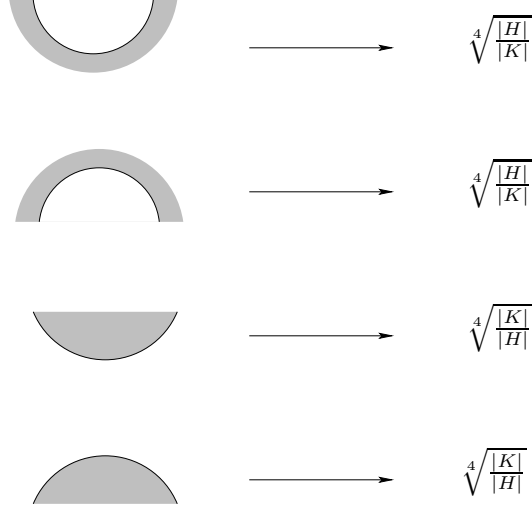

FIGURE 3. Assigning scalars to maxima or minima

connected positively (resp., negatively) oriented network(s) in the tangle \tilde{T} . Then, the coefficient $\langle Z_T(\underline{s}_1, \underline{s}_2, \dots, \underline{s}_b) | \underline{s}_0 \rangle$ of \underline{s}_0 in $Z_T(\underline{s}_1, \underline{s}_2, \dots, \underline{s}_b)$ is given by:

$$p(T) |H|^{n_+(T)} |K|^{n_-(T)} |\{f \in \mathcal{S}(T) : \partial f(D_i) = \underline{s}_i \text{ for all } i = 0, 1, \dots, b\}|$$

Note that there could be several standard form representatives for T . However, one standard form representative for T can be transformed into another by a finite sequence of moves of the following three types:

- I. Horizontal or vertical sliding of boxes,
- II. Wiggling of the strings,
- III. Rotation of an internal box by a multiple of 360° .

It is easy to check that the above three moves do not alter the number of connected networks and keeps $|\{f \in \mathcal{S}(T) : \partial f(D_i) = \underline{s}_i \text{ for all } i = 0, 1, \dots, b\}|$ unaltered. So, it remains to show that $p(T)$ is unchanged under the moves. Type I moves are the easiest because they do not generate any new local maxima or minima. In each of the moves of type II and III, there arises pair(s) of local maximum and minimum in such a way that the two scalars assigned to each pair are inverses of each other; as a result, $p(T)$ remains unchanged.

Action of the tangles preserve composition: For S an n_0 -tangle with internal discs D_1, D_2, \dots, D_b having colors n_1, n_2, \dots, n_b respectively, and T an n_j -tangle for some $j \in \{1, 2, \dots, b\}$, we would like to show $Z_{S \circ_{D_j} T} = Z_S \circ (id_{P_{n_1}} \times \dots \times Z_T \times \dots \times id_{P_{n_b}})$. For this, we first identify a set \mathcal{E} of annular tangles (with the distinguished internal disc as D_1) which we call *elementary tangles*, namely,

(i) Capping tangles:

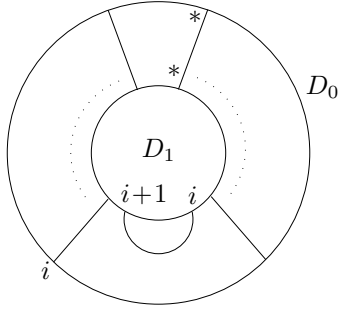

with $col(D_1) = n \geq 1$, $col(D_0) = n - 1$, and $1 \leq i \leq 2n - 1$ ($col(D_1) = 1$ just means that there are no strings connecting the internal disc to the external disc).

(ii) Cap inclusion tangles:

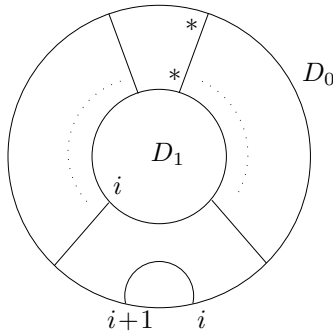

with $col(D_1) = n \geq 0$, $col(D_0) = n + 1$, and $1 \leq i \leq 2n + 1$.

If $i = 1$ in (i) or (ii) then the pictures should be interpreted as simply not having the bunch of $(i - 1)$ straight strings joining the marked points of the internal disc and the corresponding points of the external disc.

(iii) Left inclusion tangles:

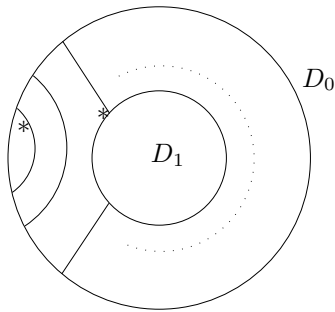

with $col(D_1) = n \geq 0$, $col(D_0) = n + 2$.

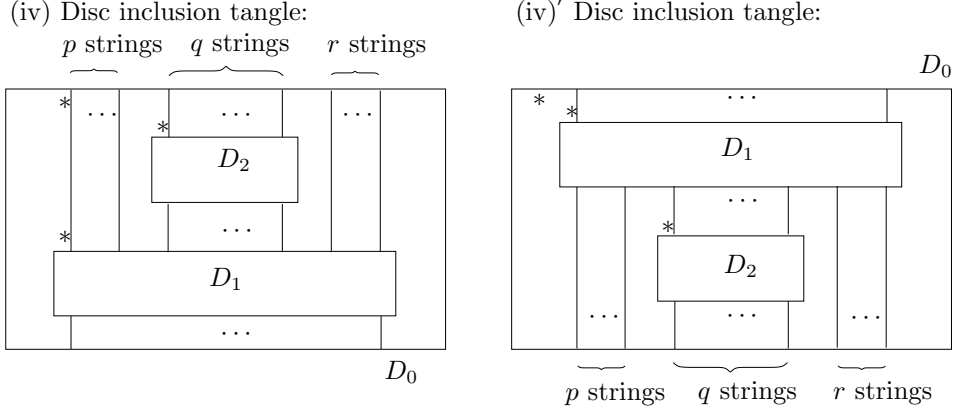

with $col(D_1) = col(D_0) = n \geq 0$, $col(D_2) = q$, where $p \geq 0, q \geq 0, r \geq 0$ such that $p + q + r = n$ and p is even.

Note that any annular tangle can be expressed as a composition of the elementary tangles. To see this, express the annular tangle in standard form and cut it into horizontal strips each of which contains at most one internal disc or one local maxima or minima. Now, the strip containing the distinguished internal disc inside the annular tangle can be obtained by composition of elementary tangles of type (iii) and type (ii) (more specifically, the inclusion tangles); one can then glue the other strips consecutively one after the other along the lines of cutting to get back the original tangle. Each such gluing operation is given by composition of an elementary tangle of types (i), (ii), (iv) or (iv)'. So, to prove that the action of the tangles preserve composition, it is enough to prove $Z_{E \circ_{D_1} T} = Z_E \circ Z_T$ (resp., $Z_{E \circ_{D_1} T} = Z_E \circ (Z_T \times id_{P_q})$) for any tangle T and any $E \in \mathcal{E}$ of type (i), (ii) or (iii) (resp. (iv) or (iv)') whenever the composition makes sense.

We fix an n -tangle T with internal discs D'_1, D'_2, \dots, D'_b with colors n_1, n_2, \dots, n_b respectively, and an n_0 -tangle $E \in \mathcal{E}$ such that both T and E are in standard forms and color of D_1 in E is n . Let us consider the standard form on $E \circ_{D_1} T$ induced by the standard forms of E and T . Our goal is to show:

$$\langle Z_{E \circ_{D_1} T}(\underline{s}_1, \underline{s}_2, \dots, \underline{s}_b) | \underline{s}_0 \rangle = \sum_{\substack{\underline{s} \in S_{2n} \\ \text{s.t. } \mu(\underline{s}) = e}} \langle Z_E(\underline{s}) | \underline{s}_0 \rangle \langle Z_T(\underline{s}_1, \underline{s}_2, \dots, \underline{s}_b) | \underline{s} \rangle$$

if E is of type (i), (ii) or (iii), and

$$\langle Z_{E \circ_{D_1} T}(\underline{s}_1, \underline{s}_2, \dots, \underline{s}_b, \underline{t}) | \underline{s}_0 \rangle = \sum_{\substack{\underline{s} \in S_{2n} \\ \text{s.t. } \mu(\underline{s}) = e}} \langle Z_E(\underline{s}, \underline{t}) | \underline{s}_0 \rangle \langle Z_T(\underline{s}_1, \underline{s}_2, \dots, \underline{s}_b) | \underline{s} \rangle$$

if E is of type (iv) or (iv)' where $\underline{s}_j \in S_{2n_j}$ for $0 \leq j \leq b$ and $\underline{t} \in S_q$ such that $\mu(\underline{s}_j) = e = \mu(\underline{t})$ for all j . An interesting situation arises when we pick elementary tangles of type (i), since composition of tangles in this case may lead to a change in the number of connected networks. The reasoning in the other cases is either similar or straightforward.

For E being type (i) elementary tangle, the above equation is equivalent to:

$$\begin{aligned}
& p(E \circ_{D_1} T) |H|^{n_+(E \circ_{D_1} T)} |K|^{n_-(E \circ_{D_1} T)} \left| \left\{ f \in \mathcal{S}(E \circ_{D_1} T) \left| \begin{array}{l} \partial f(D'_j) = \underline{s}_j \\ \text{for } 1 \leq j \leq \underline{b}, \\ \partial f(D_0) = \underline{s}_0 \end{array} \right. \right\} \right| \\
&= p(E) p(T) |H|^{n_+(E)+n_+(T)} |K|^{n_-(E)+n_-(T)} \\
& \cdot \sum_{\substack{\underline{s} \in S_{2n} \\ \text{s.t. } \mu(\underline{s})=e}} \left| \left\{ f \in \mathcal{S}(E) \left| \begin{array}{l} \partial f(D_1) = \underline{s} \\ \partial f(D_0) = \underline{s}_0 \end{array} \right. \right\} \right| \left| \left\{ f \in \mathcal{S}(T) \left| \begin{array}{l} \partial f(D'_j) = \underline{s}_j \\ \text{for } 1 \leq j \leq \underline{b}, \\ \partial f(D'_0) = \underline{s} \end{array} \right. \right\} \right|
\end{aligned}$$

where D'_0 denotes the external disc of T . First, observe that $p(E \circ_{D_1} T) = p(E) p(T)$. To show the equality of the remaining scalars, we consider the following two cases.

Case 1: The string which connects the i -th and the $(i+1)$ -th points on D_1 in E , does not produce any new network in $E \circ_{D_1} T$ other than those that are already present in T .

Clearly, $n_\epsilon(E \circ_{D_1} T) = n_\epsilon(T)$ (since no new network appears in $E \circ_{D_1} T$) and $n_\epsilon(E) = 0$ for $\epsilon \in \{+, -\}$.

A typical example of such a case can be viewed in the following picture where we label the openings on the internal discs of T by group elements coming from the coordinates of \underline{s}_j for $1 \leq j \leq b$, and the openings on D_0 of E by coordinates of $\underline{s}_0 = (g_1, g_2, \dots, g_{2n-2})$.

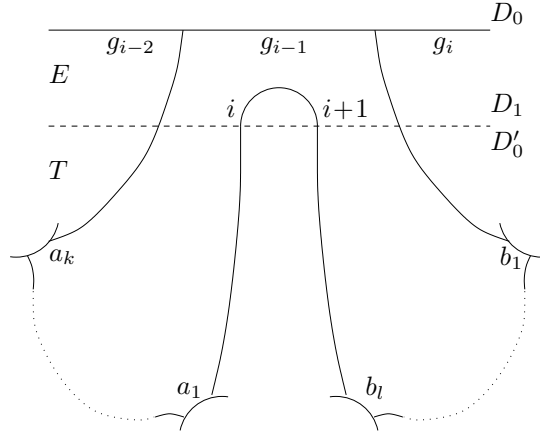

FIGURE 4.

Using triviality on the boundary of faces in the definition of a state, we get

$$\begin{aligned}
& \left| \left\{ f \in \mathcal{S}(E) \left| \begin{array}{l} \partial f(D_1) = \underline{s} \\ \partial f(D_0) = \underline{s}_0 \end{array} \right. \right\} \right| \neq 0 \iff \left| \left\{ f \in \mathcal{S}(E) \left| \begin{array}{l} \partial f(D_1) = \underline{s} \\ \partial f(D_0) = \underline{s}_0 \end{array} \right. \right\} \right| = 1 \\
& \iff \underline{s} = (g_1, \dots, g_{i-2}, (g_{i-1}g), e, g^{-1}, g_i, \dots, g_{2n-2}) \in S_{2n} \text{ for some } g \in L_i.
\end{aligned}$$

Define $\underline{s}^g = (g_1, \dots, g_{i-2}, (g_{i-1}g), e, g^{-1}, g_i, \dots, g_{2n-2})$ for $g \in L_i$. So, it is enough to check

$$\left| \left\{ f \in \mathcal{S}(E \circ_{D_1} T) \left| \begin{array}{l} \partial f(D'_j) = \underline{s}_j \\ \text{for } 1 \leq j \leq \underline{b}, \\ \partial f(D_0) = \underline{s}_0 \end{array} \right. \right\} \right| = \sum_{g \in L_i} \left| \left\{ f \in \mathcal{S}(T) \left| \begin{array}{l} \partial f(D'_j) = \underline{s}_j \\ \text{for } 1 \leq j \leq \underline{b}, \\ \partial f(D'_0) = \underline{s}^g \end{array} \right. \right\} \right|$$

Carefully observing Figure 4 and using triviality on the boundary of faces once again, we get

$$\begin{aligned} & \left| \left\{ f \in \mathcal{S}(E \circ_{D_1} T) \left| \begin{array}{l} \partial f(D'_j) = \underline{s}_j \\ \text{for } 1 \leq j \leq \underline{b}, \\ \partial f(D_0) = \underline{s}_0 \end{array} \right. \right\} \right| \neq 0, \text{ equivalently, equals to } 1 \\ \implies & \left| \left\{ f \in \mathcal{S}(T) \left| \begin{array}{l} \partial f(D'_j) = \underline{s}_j \\ \text{for } 1 \leq j \leq \underline{b}, \\ \partial f(D'_0) = \underline{s}^g \end{array} \right. \right\} \right| = \delta_{g, b_1^{\eta_1} b_2^{\eta_2} \dots b_i^{\eta_i}} \end{aligned}$$

where $\eta_j = \pm 1$ according as the corresponding opening is external or internal. Con-

versely, if $\sum_{g \in L_i} \left| \left\{ f \in \mathcal{S}(T) \left| \begin{array}{l} \partial f(D'_j) = \underline{s}_j \\ \text{for } 1 \leq j \leq \underline{b}, \\ \partial f(D'_0) = \underline{s}^g \end{array} \right. \right\} \right|$ is non-zero, then it has to equal

to 1 since g must be $b_1^{\eta_1} b_2^{\eta_2} \dots b_i^{\eta_i}$ by triviality on the boundary of faces in T ; from the unique state on T which makes the above sum non-zero, one can easily induce a well-

defined state on $E \circ_{D_1} T$, and hence $\left| \left\{ f \in \mathcal{S}(E \circ_{D_1} T) \left| \begin{array}{l} \partial f(D'_j) = \underline{s}_j \\ \text{for } 1 \leq j \leq \underline{b}, \\ \partial f(D_0) = \underline{s}_0 \end{array} \right. \right\} \right| = 1$.

This completes the proof of Case 1.

Case 2: The string which connects the i -th and the $(i+1)$ -th points on D_1 in E , produces a new (connected) network in $E \circ_{D_1} T$ other than those that are already present in T .

First, let us assume that the new network is positively oriented, equivalently, i is odd. Clearly, $n_-(E \circ_{D_1} T) = n_-(T)$ (since no new negatively oriented network appears in $E \circ_{D_1} T$), and $n_+(E \circ_{D_1} T) = n_+(T) + 1$.

Further, assume that $\text{col}(D_0) \geq 1$. In this case, $n_\epsilon(E) = 0$ for $\epsilon \in \{+, -\}$. A typical example of this case can be viewed in the following picture where we label the openings on the internal discs of T by group elements coming from the coordinates of \underline{s}_j for $1 \leq j \leq b$, and the openings on D_0 of E by coordinates of $\underline{s}_0 = (g_1, g_2, \dots, g_{2n-2})$. So, in this case, it is enough to check

$$|H| \left| \left\{ f \in \mathcal{S}(E \circ_{D_1} T) \left| \begin{array}{l} \partial f(D'_j) = \underline{s}_j \\ \text{for } 1 \leq j \leq \underline{b}, \\ \partial f(D_0) = \underline{s}_0 \end{array} \right. \right\} \right| = \sum_{g \in H} \left| \left\{ f \in \mathcal{S}(T) \left| \begin{array}{l} \partial f(D'_j) = \underline{s}_j \\ \text{for } 1 \leq j \leq \underline{b}, \\ \partial f(D'_0) = \underline{s}^g \end{array} \right. \right\} \right|$$

If $\left\{ f \in \mathcal{S}(E \circ_{D_1} T) \left| \begin{array}{l} \partial f(D'_j) = \underline{s}_j \\ \text{for } 1 \leq j \leq \underline{b}, \\ \partial f(D_0) = \underline{s}_0 \end{array} \right. \right\}$ is non-empty (equivalently, singleton), from

Figure 5, we have $a_1 a_2 \dots a_k = e$ and $g_{i-1} b_1^{\eta_1} b_2^{\eta_2} \dots b_i^{\eta_i} = e$ where $\eta_j = \pm 1$ according as the corresponding opening is external or internal. For any $g \in H$, define f^g by setting $\partial f(D'_j) = \underline{s}_j$ for $1 \leq j \leq b$ and $\partial f(D'_0) = \underline{s}^g$. To check whether f^g is a

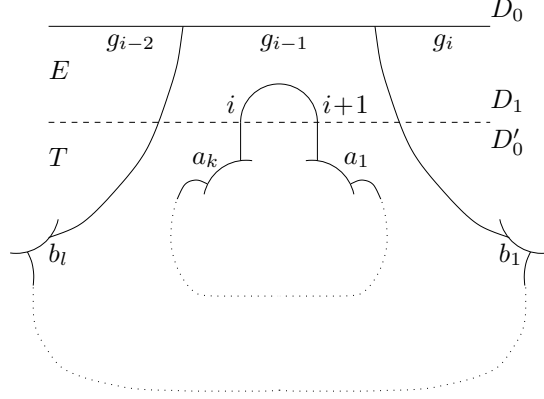

FIGURE 5.

state, we consider the face in T appearing in Figure 5; triviality on the boundary of this face is given by the equation $g^{-1}b_1^{\eta_1}b_2^{\eta_2} \cdots b_l^{\eta_l}(g_{i-1}g)a_1a_2 \cdots a_k = e$ which indeed holds. Triviality on all other discs or faces are induced by the

existence of the state on $E \circ_{D_1} T$. Thus, $\left| \left\{ f \in \mathcal{S}(T) \left| \begin{array}{l} \partial f(D'_j) = \underline{s}_j \\ \text{for } 1 \leq j \leq b, \\ \partial f(D'_0) = \underline{s}^g \end{array} \right. \right\} \right| = 1$

for all $g \in H$. Conversely, if the right hand side is non-zero, then there exists $g \in H$ such that f^g (defined earlier) is a state on T . Analyzing Figure 5, we get $g^{-1}b_1^{\eta_1}b_2^{\eta_2} \cdots b_l^{\eta_l}(g_{i-1}g)a_k^{-1} \cdots a_2^{-1}a_1^{-1} = e$. Note that the opening between the i -th and the $(i+1)$ -th points of the disc D'_0 of T , is assigned e . Now, if we consider the network appearing in Figure 5 separately, then we have triviality on each of its internal faces and discs (induced by f^g being a state); by Remark 3.2 (ii)', we also have $a_1a_2 \cdots a_k = e$ (triviality on the internal boundary of the external face of the network). This implies $b_1^{\eta_1}b_2^{\eta_2} \cdots b_l^{\eta_l}g_{i-1} = e$; as a result, f^h is a state for every $h \in H$. So, if right hand side is non-zero, then it has to be $|H|$; moreover, we get $b_1^{\eta_1}b_2^{\eta_2} \cdots b_l^{\eta_l}g_{i-1} = e$ which plays an important role in showing that

$$\left| \left\{ f \in \mathcal{S}(E \circ_{D_1} T) \left| \begin{array}{l} \partial f(D'_j) = \underline{s}_j \\ \text{for } 1 \leq j \leq b, \\ \partial f(D_0) = \underline{s}_0 \end{array} \right. \right\} \right| \neq 0 \text{ (equivalently, equals to 1).}$$

This finishes the proof for the case where i is odd. For i even, the proof is exactly similar, except that one has to interchange $|H|$ and $|K|$.

The subcase that deserves separate treatment is when $\text{col}(D_0) = 0$. In this case, $n_+(E) = 1$ and $|\{f \in \mathcal{S}(E) : \partial f(D_1) = \underline{s}\}| = \delta_{\underline{s},(e,e)}$. Therefore, it is enough to show

$$\left| \left\{ f \in \mathcal{S}(E \circ_{D_1} T) \left| \begin{array}{l} \partial f(D'_j) = \underline{s}_j \\ \text{for } 1 \leq j \leq b \end{array} \right. \right\} \right| = \left| \left\{ f \in \mathcal{S}(T) \left| \begin{array}{l} \partial f(D'_j) = \underline{s}_j \\ \text{for } 1 \leq j \leq b, \\ \partial f(D'_0) = (e, e) \end{array} \right. \right\} \right|$$

The proof of the equality of the two sides is similar and is left to the reader.

We now analyze the filtered $*$ -algebra structure of P and the action of Jones projection tangles and conditional expectation tangles which will be useful in section

5 to show that P is isomorphic to the planar algebra arising from a group-type subfactor. We start with laying some notations. Define

$$\widetilde{S}_n = \begin{cases} \{e\} & \text{if } n = 0 \\ \underbrace{\cdots \times H \times K \times H \times K}_{(n \text{ factors})} & \text{if } n \geq 1 \end{cases}$$

$$T_n = \begin{cases} \{e\} & \text{if } n = 0 \\ \underbrace{H \times K \times H \times K \times \cdots}_{(n \text{ factors})} & \text{if } n \geq 1 \end{cases}$$

Define $\sim : S_n \rightarrow \widetilde{S}_n$ by $(s_1, s_2, \dots, s_n) \sim (s_n^{-1}, \dots, s_2^{-1}, s_1^{-1})$ for $(s_1, s_2, \dots, s_n) \in S_n$ and let $^- : \widetilde{S}_n \rightarrow S_n$ denote its inverse.

Remark 3.3. We describe below the main structural features of the planar algebra P .

(i) *Identity:*

$$1_{P_n} = \begin{cases} e & \text{if } n = 0 \\ \sum_{\underline{s} \in S_{n-1}} (\underline{s}, e, \widetilde{\underline{s}}, e) & \text{if } n \geq 1 \end{cases}$$

(ii) **-structure:* Define $*$ on P by defining on the basis as

$$\underline{s}^* = (s_{2n-1}^{-1}, \dots, s_2^{-1}, s_1^{-1}, s_{2n}^{-1})$$

where $\underline{s} = (s_1, s_2, \dots, s_{2n}) \in S_{2n}$ such that $\mu(\underline{s}) = e$ for $n \geq 1$, and then extend conjugate linearly. Clearly, $*$ is an involution. One also needs to verify whether the action of a tangle T preserves $*$, that is, $Z_{T^*} \circ (* \times \cdots \times *) = * \circ Z_T$; in particular, $\langle Z_{T^*}(\underline{s}_1^*, \dots, \underline{s}_b^*) | \underline{s}_0^* \rangle = \langle Z_T(\underline{s}_1, \dots, \underline{s}_b) | \underline{s}_0 \rangle$. It is enough to check this equation for the cases when T has no internal disc or closed loops, and when T is an elementary tangle. The actual verification in each of these cases is completely routine and is left to the reader.

(iii) *Multiplication:*

$$(\underline{a}_1, l_1, \underline{b}_1, h_1) \cdot (\underline{a}_2, l_2, \underline{b}_2, h_2) = \delta_{\underline{b}_1, \widetilde{\underline{a}_2}} (\underline{a}_1, l_1 l_2, \underline{b}_2, h_2 h_1)$$

where $\underline{a}_i \in S_{n-1}$, $\underline{b}_i \in \widetilde{S_{n-1}}$, $l_i \in L_{n-1}$, $h_i \in H$ such that $\mu(\underline{a}_i, l_i, \underline{b}_i, h_i) = e$ for $i = 1, 2$ and $n \geq 1$ (where we consider the elements \underline{a}_i and \underline{b}_i to be void in the case of $n = 1$),

(iv) *Inclusion:*

$$P_n \ni \underline{s} \mapsto \sum_{\substack{l_1, l_2 \in L_{n-1} \\ \text{such that } l_1 l_2 = s_n}} (s_1, s_2, \dots, s_{n-1}, l_1, e, l_2, s_{n+1}, \dots, s_{2n}) \in P_{n+1}$$

where $\underline{s} = (s_1, s_2, \dots, s_{2n}) \in S_{2n}$ such that $\mu(\underline{s}) = e$ for $n \geq 1$,

(v) *Jones Projection Tangle:*

For P_2 ,

$$\begin{array}{c}
 1 \quad 2 \\
 \hline
 \begin{array}{c} \text{---} \\ \text{---} \end{array} \\
 \hline
 \end{array}
 = \sqrt{\frac{|K|}{|H|}} \sum_{h \in H} (e, h, e, h^{-1})$$

and for P_{n+1} for $n > 1$,

$$\begin{array}{c}
 1 \quad 2 \quad \dots \quad n \quad n+1 \\
 \hline
 \begin{array}{c} | \quad | \quad \dots \quad | \quad | \\ \text{---} \\ | \quad | \quad \dots \quad | \quad | \\ \text{---} \end{array} \\
 \hline
 \end{array}
 = \sqrt{\frac{|L_{n-1}|}{|L_n|}} \sum_{\substack{\underline{s} \in S_{n-2} \\ l_1, l_2, l_3 \in L_n \\ \text{s.t. } l_1 l_2 l_3 = e}} (\underline{s}, l_1, e, l_2, e, l_3, \underline{\tilde{s}}, e)$$

(vi) *Conditional Expectation Tangle from P_{n+1} onto P_n :*

For $n \geq 1$, let $\underline{s}_1 \in S_{n-1}$, $\underline{s}_2 \in \widetilde{S}_{n-1}$, $m_1, m_2 \in L_{n-1}$, $l \in L_n$, $h \in H$ such that $\mu(\underline{s}_1, m_1 m_2, \underline{s}_2, h) = e$. Then,

$$\begin{array}{c}
 1 \quad 2 \quad \dots \quad n \\
 \hline
 \begin{array}{c} * \quad | \quad \dots \quad | \\ * \quad | \quad \dots \quad | \\ \text{---} \\ | \quad | \quad \dots \quad | \quad | \\ \text{---} \end{array} \\
 \hline
 \end{array}
 = \delta_{l,e} \sqrt{\frac{|L_n|}{|L_{n-1}|}} (\underline{s}_1, m_1 m_2, \underline{s}_2, h)$$

and for $n = 0$,

$$\begin{array}{c}
 * \\
 \hline
 \begin{array}{c} \text{---} \\ \text{---} \end{array} \\
 \hline
 \end{array}
 = \delta_{h,e} \delta_{k,e} \sqrt{\frac{|K|}{|H|}} e$$

(vii) *Conditional Expectation Tangle from P_n onto $P_{1,n}$:*

For $n \geq 2$ let $k_1, k_2 \in K$, $\underline{t} \in T_{2n-3}$, $h \in H$ such that $\mu(k_1, \underline{t}, k_2, h) = e$. Then,

$$\begin{array}{c}
 1 \quad 2 \quad \dots \quad n \\
 \hline
 \begin{array}{c} * \quad | \quad \dots \quad | \\ * \quad | \quad \dots \quad | \\ \text{---} \\ | \quad | \quad \dots \quad | \quad | \\ \text{---} \end{array} \\
 \hline
 \end{array}
 = \delta_{h,e} \sqrt{\frac{|H|}{|K|}} \sum_{\substack{k', k'' \in K \\ \text{s.t. } k'' k' = k_2 k_1}} (k', \underline{t}, k'', e)$$

and for $n = 1$,

$$= \delta_{h,e} \delta_{k,e} \sqrt{\frac{|H|}{|K|}} e$$

4. ITERATED BASIC CONSTRUCTION AND HIGHER RELATIVE COMMUTANTS OF GROUP-TYPE SUBFACTORS

Let P be a II_1 factor and G a countable discrete group with an outer action on P , and suppose G is generated by two of its finite subgroups H and K . Consider the associated group-type subfactor $P^H \subset P \rtimes K$. In this section we will give a concrete realization of the Jones tower associated to this subfactor and compute its higher relative commutants. See also [19] for related results.

First, let us recall the following characterization of the basic construction of a finite index subfactor ([15]).

Lemma 4.1. *Let $N \subset M$ be a finite index subfactor with $\mathbb{E} : M \rightarrow N$ being the trace-preserving conditional expectation, B be a II_1 factor containing M as a subfactor and f be a projection in B satisfying:*

- (i) $fxf = \mathbb{E}(x)f$ for all $x \in M$,
- (ii) B is the algebra generated by M and f .

Then, B is isomorphic to the basic construction M_1 of $N \subset M$.

Second, we recall some basic facts and notations for the crossed product construction. Unless otherwise specified, we will reserve the symbol e for the identity element of a group. The crossed product $P \rtimes K$ can be realized as the von Neumann subalgebra of $\mathcal{L}(l^2(K) \otimes L^2(P))$ ($\cong M_K(\mathbb{C}) \otimes \mathcal{L}(L^2(P))$) generated by the images of P and K in the following way:

$$(4.1) \quad P \ni x \mapsto \sum_{k \in K} E_{k,k} \otimes k^{-1}(x) \in M_K(\mathbb{C}) \otimes \mathcal{L}(L^2(P))$$

$$(4.2) \quad K \ni k \mapsto \lambda_k \otimes 1 \in M_K(\mathbb{C}) \otimes \mathcal{L}(L^2(P))$$

where we set the convention of considering $k(x)$ as the element of P obtained by applying the automorphism k on x (in P) and λ_k is the matrix in $M_K(\mathbb{C})$ corresponding to left multiplication by k . Consequently, the following commutation relation holds in $P \rtimes K$:

$$(4.3) \quad kxk^{-1} = k(x) \text{ for all } x \in P, k \in K.$$

However, $P \rtimes K$ can also be viewed as the vector space generated by elements of the form $\sum_{k \in K} x_k k$ where $x_k \in P$ where the multiplication structure is given by the relation (4.3). The unique trace on $P \rtimes K$ is given by:

$$\text{tr}\left(\sum_{k \in K} x_k k\right) = \text{tr}(x_e)$$

and the unique trace-preserving conditional expectation is given by:

$$\mathbb{E}_P^{P \rtimes K}\left(\sum_{k \in K} x_k k\right) = x_e.$$

If P^K denotes the fixed point subalgebra of P , then $P \rtimes K$ is isomorphic to the basic construction of $P^K \subset P$ where the Jones projection is given by:

$$e_1 = \frac{1}{|K|} \sum_{k \in K} k \in P \rtimes K$$

implementing the conditional expectation:

$$\mathbb{E}_{P \rtimes K}^P(x) = \frac{1}{|K|} \sum_{k \in K} k(x) \in P^K \text{ for all } x \in P.$$

The basic construction of $P \subset P \rtimes K$ is isomorphic to $M_K(\mathbb{C}) \otimes P$ where the inclusion $P \rtimes K \hookrightarrow M_K(\mathbb{C}) \otimes P$ is given by the maps (4.1), (4.2), and the corresponding Jones projection is given by $e_2 = E_{e,e} \otimes 1 \in M_K(\mathbb{C}) \otimes P$ implementing the conditional expectation $\mathbb{E}_P^{P \rtimes K}$. The next element in the tower of basic construction is given by $M_K(\mathbb{C}) \otimes (P \rtimes K)$ where the inclusion $M_K(\mathbb{C}) \otimes P \hookrightarrow M_K(\mathbb{C}) \otimes (P \rtimes K)$ is induced by the inclusion $P \subset P \rtimes K$ and the Jones projection is given by:

$$(4.4) \quad e_3 = \frac{1}{|K|} \sum_{k \in K} \rho_{k^{-1}} \otimes k \in M_K(\mathbb{C}) \otimes (P \rtimes K)$$

implementing the conditional expectation:

$$(4.5) \quad \mathbb{E}_{P \rtimes K}^{M_K(\mathbb{C}) \otimes P}(E_{k_1, k_2} \otimes x) = \frac{1}{|K|} k_1 x k_2^{-1} \in P \rtimes K \text{ for all } x \in P, k_1, k_2 \in K$$

where ρ_k is the matrix in $M_K(\mathbb{C})$ corresponding to right multiplication by k .

Coming back to the context of group-type subfactors we consider the unital inclusions $P^H \hookrightarrow P \rtimes K \hookrightarrow M_K(\mathbb{C}) \otimes (P \rtimes H)$ where the second inclusion factors through $M_K(\mathbb{C}) \otimes P$ in the obvious way.

Lemma 4.2. $M_K(\mathbb{C}) \otimes (P \rtimes H)$ is the basic construction for $P^H \subset P \rtimes K$ with Jones projection $e_1 = E_{e,e} \otimes \frac{1}{|H|} \sum_{h \in H} h$.

Proof: We need to show that conditions (i) and (ii) of Lemma 4.1 are satisfied. To show (i), let us assume that $\tilde{x} = \sum_{k \in K} x_k k$ denotes a typical element of $P \rtimes K$.

$$\begin{aligned} e_1 \tilde{x} e_1 &= \left(E_{e,e} \otimes \frac{1}{|H|} \sum_{h \in H} h \right) \tilde{x} \left(E_{e,e} \otimes \frac{1}{|H|} \sum_{h' \in H} h' \right) \\ &= \left(E_{e,e} \otimes \frac{1}{|H|} \sum_{h \in H} h \right) \left(\sum_{\substack{k' \in K \\ k \in K}} E_{k', k'} \lambda_k \otimes k'^{-1}(x_k) \right) \left(E_{e,e} \otimes \frac{1}{|H|} \sum_{h' \in H} h' \right) \\ &= \left(\sum_{k \in K} E_{e,e} \lambda_k E_{e,e} \otimes \frac{1}{|H|^2} \sum_{\substack{h \in H \\ h' \in H}} h x_k h' \right) \\ &= \left(E_{e,e} \otimes \frac{1}{|H|^2} \sum_{\substack{h \in H \\ h' \in H}} h(x_e) h h' \right) \end{aligned}$$

whereas

$$\begin{aligned}\mathbb{E}(\tilde{x})e_1 &= \left(\sum_{k \in K} E_{k,k} \otimes \frac{1}{|H|} \sum_{h \in H} k^{-1}(h(x_e)) \right) \left(E_{e,e} \otimes \frac{1}{|H|} \sum_{h' \in H} h' \right) \\ &= \left(E_{e,e} \otimes \frac{1}{|H|^2} \sum_{\substack{h \in H \\ h' \in H}} h(x_e)h' \right)\end{aligned}$$

Therefore, LHS = RHS.

To show (ii), it is enough to show that elements of the form $E_{k_1, k_2} \otimes xh$ for $x \in P$, $h \in H$, $k_1, k_2 \in K$ are in the algebraic span of $P \rtimes K$ and e_1 . Let us denote the Jones projection in $P \rtimes H$ corresponding to the inclusion $P^H \subset P$ by $f = \frac{1}{|H|} \sum_{h \in H} h$. Thus,

$$e_1 = E_{e,e} \otimes f \in M_K(\mathbb{C}) \otimes P \rtimes H.$$

This implies

$$Pe_1P = E_{e,e} \otimes PfP = E_{e,e} \otimes P \rtimes H \subset M_K(\mathbb{C}) \otimes P \rtimes H$$

where P in the left hand side is identified with its image inside $M_K(\mathbb{C}) \otimes P \rtimes H$ (namely, the prescription given by (4.1)). Thus the algebraic span of $P \rtimes K$ and e_1 contains elements of the type $E_{e,e} \otimes xh$ for $x \in P$, $h \in H$. To obtain elements of the form $E_{k_1, k_2} \otimes xh$, note that the relation $\lambda_{k_1} E_{e,e} \lambda_{k_2}^{-1} = E_{k_1, k_2}$ holds in $M_K(\mathbb{C})$. \square

Lemma 4.3. $M_K(\mathbb{C}) \otimes M_H(\mathbb{C}) \otimes (P \rtimes K)$ is the basic construction for $P \rtimes K \subset M_K(\mathbb{C}) \otimes (P \rtimes H)$ where the Jones projection is given by $e_2 = \frac{1}{|K|} \sum_{k \in K} \rho_{k^{-1}} \otimes E_{e,e} \otimes k$.

Proof: The conditional expectation $\mathbb{E}_{P \rtimes K}^{M_K(\mathbb{C}) \otimes (P \rtimes H)}$ is the composition $\mathbb{E}_{P \rtimes K}^{M_K(\mathbb{C}) \otimes P} \circ \mathbb{E}_{M_K(\mathbb{C}) \otimes P}^{M_K(\mathbb{C}) \otimes (P \rtimes H)}$. Therefore, $\mathbb{E}(E_{k_1, k_2} \otimes xh) = \delta_{h,e} \frac{1}{|K|} k_1 x k_2^{-1}$.

To show condition (i) of Lemma 4.1,

$$\begin{aligned}& e_2(E_{k_1, k_2} \otimes xh)e_2 \\ &= \frac{1}{|K|^2} \left(\sum_{k' \in K} \rho_{k'^{-1}} \otimes E_{e,e} \otimes k' \right) \left(\sum_{h' \in H} E_{k_1, k_2} \otimes E_{h', h'} \lambda_h \otimes h'^{-1}(x) \right) \\ & \quad \left(\sum_{k'' \in K} \rho_{k''^{-1}} \otimes E_{e,e} \otimes k'' \right) \\ &= \delta_{h,e} \frac{1}{|K|^2} \left(\sum_{k', k'' \in K} \rho_{k'^{-1}} E_{k_1, k_2} \rho_{k''^{-1}} \otimes E_{e,e} \lambda_h E_{e,e} \otimes k' x k'' \right) \\ &= \delta_{h,e} \frac{1}{|K|^2} \left(\sum_{k', k'' \in K} E_{k_1 k'^{-1}, k_2 k''} \otimes E_{e,e} \otimes k' x k'' \right)\end{aligned}$$

whereas

$$\begin{aligned}
& \mathbb{E}(E_{k_1, k_2} \otimes xh)e_2 \\
&= \delta_{h,e} \frac{1}{|K|^2} \left(\sum_{h' \in H} \sum_{k \in K} \lambda_{k_1} E_{k,k} \lambda_{k_2}^{-1} \otimes E_{h', h'} \otimes h'^{-1}(k^{-1}(x)) \right) \left(\sum_{k' \in K} \rho_{k'^{-1}} \otimes E_{e,e} \otimes k' \right) \\
&= \delta_{h,e} \frac{1}{|K|^2} \left(\sum_{k \in K} \lambda_{k_1} E_{k,k} \lambda_{k_2}^{-1} \rho_{k'^{-1}} \otimes E_{e,e} \otimes k^{-1}(x)k' \right) \\
&= \delta_{h,e} \frac{1}{|K|^2} \left(\sum_{k, k' \in K} E_{k_1 k, k_2 k k'} \otimes E_{e,e} \otimes k^{-1} x k k' \right)
\end{aligned}$$

and the two sides are the same after renaming the indices.

To show condition (ii), note that $M_K(\mathbb{C}) \otimes (P \rtimes K)$ is algebraically generated by $M_K(\mathbb{C}) \otimes P$ and $\frac{1}{|K|} \sum_{k \in K} \rho_{k^{-1}} \otimes k$ (by the remarks preceding Equation (4.4)). The following holds in $M_K(\mathbb{C}) \otimes M_H(\mathbb{C}) \otimes (P \rtimes K)$ because of this fact and the way P sits inside $M_H(\mathbb{C}) \otimes P$ (since in the second tensor component we get expressions of the form $\sum_{h, h' \in H} E_{h,h} E_{e,e} E_{h', h'}$ which reduces to $E_{e,e}$):

$$\begin{aligned}
(M_K(\mathbb{C}) \otimes P)e_2(M_K(\mathbb{C}) \otimes P) &= M_K(\mathbb{C}) \otimes E_{e,e} \otimes (P \rtimes K) \\
\Rightarrow (M_K(\mathbb{C}) \otimes P \rtimes H)e_2(M_K(\mathbb{C}) \otimes P \rtimes H) &= M_K(\mathbb{C}) \otimes M_H(\mathbb{C}) \otimes (P \rtimes K)
\end{aligned}$$

where the last implication is again due to the relation $\lambda_{h_1} E_{e,e} \lambda_{h_2}^{-1} = E_{h_1, h_2}$ in $M_H(\mathbb{C})$. \square

Thus, we have the first two levels in the tower of basic construction:

$$P^H \subset P \rtimes K \subset M_K(\mathbb{C}) \otimes (P \rtimes H) \subset M_{K \times H}(\mathbb{C}) \otimes (P \rtimes K)$$

where we identify $M_{K \times H}(\mathbb{C})$ with $M_K(\mathbb{C}) \otimes M_H(\mathbb{C})$. The next levels in the tower are obvious generalizations and we gather everything in the following proposition.

Proposition 4.4. *Let G be a group acting outerly on the II_1 factor P and assume G is generated by two of its finite subgroups H and K . Then the n -th element of the tower of basic construction of the group-type subfactor $N = P^H \subset P \rtimes K = M$ is given by:*

$$M_n \cong M_{S_n}(\mathbb{C}) \otimes (P \rtimes L_n)$$

where the inclusion of M_n inside M_{n+1} is as follows:

$$M_n \ni E_{\underline{s}, \underline{t}} \otimes x \mapsto \sum_{l \in L_n} E_{\underline{s}, \underline{t}} \otimes E_{l,l} \otimes l^{-1}(x) \in M_{n+1} \text{ for all } x \in P, \underline{s}, \underline{t} \in S_n$$

$$M_n \ni E_{\underline{s}, \underline{t}} \otimes l \mapsto E_{\underline{s}, \underline{t}} \otimes \lambda_l \otimes e \in M_{n+1} \text{ for all } l \in L_n, \underline{s}, \underline{t} \in S_n$$

and the n -th Jones projection is:

$$M_n \ni e_n = \begin{cases} \frac{1}{|L_n|} \sum_{l \in L_n} I_{M_{S_{n-2}}} \otimes \rho_{l^{-1}} \otimes E_{e,e} \otimes l, & \text{if } n > 1 \\ \frac{1}{|H|} \sum_{h \in H} E_{e,e} \otimes h, & \text{if } n = 1. \end{cases}$$

Proof: We use induction. The case of $n = 1$ is a little different from the rest and is proved in Lemma 4.2 and the $n = 2$ case is proved in Lemma 4.3. Suppose the statement of the above proposition holds upto a level $n (> 2)$. Now, the subfactor $M_{n-1} \subset M_n$ is isomorphic to:

$$M_{S_{n-1}} \otimes P \rtimes L_{n-1} \subset M_{S_{n-1}} \otimes M_{L_{n-1}} \otimes P \rtimes L_n$$

where we identify $M_{S_{n-1}} \otimes M_{L_{n-1}}$ with M_{S_n} and the inclusion is induced by identity over $M_{S_{n-1}}$ tensored with the inclusion of the subfactor $P \rtimes L_{n-1} \subset M_{L_{n-1}} \otimes P \rtimes L_n$. Using Lemma 4.3 for $K = L_{n-1}$ and $H = L_n$, it is clear that the statement of the proposition holds for level $n + 1$. \square

Remark 4.5. The formula for the unique trace-preserving conditional expectation is:

$$\mathbb{E}_{M_{n-1}}^{M_n}(E_{\underline{s_1}, \underline{s_2}} \otimes E_{m_1, m_2} \otimes xl) = \delta_{l, e} \frac{1}{|L_n|} E_{\underline{s_1}, \underline{s_2}} \otimes m_1 x m_2^{-1}$$

where $\underline{s_1}, \underline{s_2} \in S_{n-1}$, $m_1, m_2 \in L_{n-1}$, $l \in L_n$ and $x \in P$ and the unique trace on M_n is given by:

$$tr_{M_n}(E_{\underline{s_1}, \underline{s_2}} \otimes xl) = \frac{1}{|S_n|} \delta_{l, e} \delta_{\underline{s_1}, \underline{s_2}} tr_M(x)$$

where $\underline{s_1}, \underline{s_2} \in S_n$, $l \in L_n$ and $x \in P$.

We will now compute the higher relative commutants using the above model of the Jones tower. To this end, we need the following two lemmas, where we denote the set of automorphisms of $M \supset N$ that fixes elements of N pointwise by $Gal(N \subset M)$.

Lemma 4.6. *Let $N \subset M$ be a finite index subfactor and $\theta \in Gal(N \subset M)$, then the bimodule ${}_M L^2(\theta)_M$ (where the module is $L^2(M)$ with usual left action of M but right action is twisted by θ) is a 1-dimensional irreducible sub-bimodule of ${}_M L^2(M_1)_M$.*

Proof: Define $u_\theta : L^2(M) \rightarrow L^2(M)$ by $u_\theta(x\Omega) = \theta(x)\Omega$ for $x \in M$ where Ω is the cyclic and separating vector in the GNS construction with respect to the canonical trace tr . Note that $u_\theta(n_1 \cdot x\Omega \cdot n_2) = u_\theta(n_1 x n_2 \Omega) = n_1 \cdot \theta(x)\Omega \cdot n_2$ for $n_1, n_2 \in N$, $x \in M$. This implies $u_\theta \in N' \cap M_1$. Now define $T : {}_M L^2(\theta)_M \rightarrow {}_M L^2(M_1)_M$ by $T(x\Omega) = x u_\theta \Omega_1$ for $x \in M$. It is completely routine to check that T is a well-defined M - M linear isometry and we leave this to the reader. \square

Corollary 4.7. $H = Gal(P^H \subset P)$

Proof: Clearly $H \subset Gal(P^H \subset P)$. Let $\theta \in Gal(P^H \subset P)$. Note that ${}_P L^2(P \rtimes H)_P \cong \oplus_{h \in H} {}_P L^2(h)_P$. Thus by Lemma 4.6, ${}_P L^2(\theta)_P \cong {}_P L^2(h)_P$ for some $h \in H$. This implies $\theta h^{-1} \in Inn(P) \cap Gal(P^H \subset P) = \{id_P\}$ since $P^H \subset P$ is irreducible. Hence, $\theta \in H$. \square

Lemma 4.8. *Let $N \subset M$ be an irreducible subfactor, i.e $N' \cap M \cong \mathbb{C}$ and $\theta \in Aut(M)$. For $x \in M$, the following are equivalent:*

- (i) $x \neq 0$ and $x\theta(y) = yx$ for all $y \in N$,
- (ii) $x_0 := \frac{x}{\|x\|} \in \mathcal{U}(M)$ and $Ad_{x_0} \circ \theta \in Gal(N \subset M)$.

Proof (ii) \Rightarrow (i) part is easy.

For (i) \Rightarrow (ii), note that we also have $\theta(y)x^* = x^*y$ for all $y \in N$. Thus, $x^*x \in \theta(N)' \cap M$ and $xx^* \in N' \cap M$. Since $N' \cap M \cong \mathbb{C}$, $xx^* = x^*x = \|x\|^2$. Hence, $x_0 \in \mathcal{U}(M)$ and $x_0 \theta(y) x_0^* = y$ for all $y \in N$. This implies $Ad_{x_0} \circ \theta \in Gal(N \subset M)$. \square

Proposition 4.9. *For the group-type subfactor $N = P^H \subset P \rtimes K = M$, the relative commutants $N' \cap M_n$ and $M' \cap M_n$ are given by:*

$$N' \cap M_n \cong \begin{cases} \mathbb{C}, & \text{if } n = -1 \\ \text{span} \left\{ E_{\underline{s}_1, \underline{s}_2} \otimes l \mid \begin{array}{l} \underline{s}_1, \underline{s}_2 \in S_n, \\ l \in L_n, \\ \mu(\underline{s}_1)l\mu(\underline{s}_2)^{-1} \in H \end{array} \right\}, & \text{if } n \geq 0 \end{cases}$$

$$M' \cap M_n \cong \begin{cases} \mathbb{C}, & \text{if } n = 0 \\ \text{span} \left\{ \sum_{k \in K} E_{k, kk_0} \otimes E_{\underline{t}_1, \underline{t}_2} \otimes l \mid \begin{array}{l} \underline{t}_1, \underline{t}_2 \in T_{n-1}, \\ \mu(\underline{t}_1)l\mu(\underline{t}_2)^{-1} \in K, \\ k_0 = \mu(\underline{t}_1)l\mu(\underline{t}_2)^{-1} \end{array} \right\}, & \text{if } n \geq 1. \end{cases}$$

Proof: We compute the relative commutants in relation to the concrete model of the basic construction described in Proposition 4.4. Consider the inclusion

$$N = P^H \ni x \mapsto \sum_{\underline{s} \in S_n} E_{\underline{s}, \underline{s}} \otimes \mu(\underline{s})^{-1}(x) \in M_{S_n}(\mathbb{C}) \otimes (P \rtimes L_n) = M_n.$$

$$\text{Let } w = \sum_{\substack{\underline{s}_1, \underline{s}_2 \in S_n \\ l \in L_n}} E_{\underline{s}_1, \underline{s}_2} \otimes x_{\underline{s}_1, \underline{s}_2}^l l \in N' \cap M_n, \text{ for some } x_{\underline{s}_1, \underline{s}_2}^l \in P.$$

Then, $wy = yw$ for all $y \in N$

$$\begin{aligned} \Leftrightarrow & \sum_{\substack{\underline{s}_1, \underline{s}_2 \in S_n \\ l \in L_n}} E_{\underline{s}_1, \underline{s}_2} \otimes (x_{\underline{s}_1, \underline{s}_2}^l l) \mu(\underline{s}_2)^{-1}(y) = \sum_{\substack{\underline{s}_1, \underline{s}_2 \in S_n \\ l \in L_n}} E_{\underline{s}_1, \underline{s}_2} \otimes \mu(\underline{s}_1)^{-1}(y) x_{\underline{s}_1, \underline{s}_2}^l l \text{ for all } y \in N \\ \Leftrightarrow & x_{\underline{s}_1, \underline{s}_2}^l (l \mu(\underline{s}_2)^{-1})(y) = \mu(\underline{s}_1)^{-1}(y) x_{\underline{s}_1, \underline{s}_2}^l \text{ for all } y \in N, \underline{s}_1, \underline{s}_2 \in S_n, l \in L_n \\ \Leftrightarrow & \mu(\underline{s}_1)(x_{\underline{s}_1, \underline{s}_2}^l) (\mu(\underline{s}_1)l\mu(\underline{s}_2)^{-1})(y) = y \mu(\underline{s}_1)(x_{\underline{s}_1, \underline{s}_2}^l) \text{ for all } y \in N, \underline{s}_1, \underline{s}_2 \in S_n, l \in L_n \end{aligned}$$

Now, by Lemma 4.8 and Corollary 4.7, for $\underline{s}_1, \underline{s}_2 \in S_n$ and $l \in L_n$,

$$x_{\underline{s}_1, \underline{s}_2}^l \neq 0 \Leftrightarrow Ad_{x_0} \circ (\mu(\underline{s}_1)l\mu(\underline{s}_2)^{-1}) \in H \text{ where } x_0 = \frac{\mu(\underline{s}_1)(x_{\underline{s}_1, \underline{s}_2}^l)}{\|\mu(\underline{s}_1)(x_{\underline{s}_1, \underline{s}_2}^l)\|}.$$

Moreover, $x_{\underline{s}_1, \underline{s}_2}^l \neq 0 \Rightarrow Ad_{x_0} \in G \cap Inn(P) = \{id_P\}$. Since P is a factor, $x_0 \in \mathbb{C}1$. Thus, $x_{\underline{s}_1, \underline{s}_2}^l$ will be nonzero only if $\mu(\underline{s}_1)l\mu(\underline{s}_2)^{-1} \in H$ and in such cases $x_{\underline{s}_1, \underline{s}_2}^l$ will be a scalar multiple of identity. Hence, $N' \cap M_n$ is spanned by the linearly independent set $\{E_{\underline{s}_1, \underline{s}_2} \otimes l : \underline{s}_1, \underline{s}_2 \in S_n, l \in L_n, \mu(\underline{s}_1)l\mu(\underline{s}_2)^{-1} \in H\}$.

For $M' \cap M_n$ where $n \geq 1$, we consider the inclusion

$$M = P \rtimes K \supset P \ni x \mapsto \sum_{\underline{s} \in S_n} E_{\underline{s}, \underline{s}} \otimes \mu(\underline{s})^{-1}(x) \in M_{S_n}(\mathbb{C}) \otimes (P \rtimes L_n) = M_n$$

$$M = P \rtimes K \supset K \ni k \mapsto \lambda_k \otimes I_{T_{n-1}} \otimes 1 \in M_{S_n}(\mathbb{C}) \otimes (P \rtimes L_n) = M_n$$

Let

$$w = \sum_{\substack{\underline{s}_1, \underline{s}_2 \in S_n \\ l \in L_n}} E_{\underline{s}_1, \underline{s}_2} \otimes x_{\underline{s}_1, \underline{s}_2}^l l \in M' \cap M_n, \text{ for some } x_{\underline{s}_1, \underline{s}_2}^l \in P.$$

Using arguments similar to those for the calculations for the case of $N' \cap M_n$ it follows that

$$\begin{aligned} & wy = yw \text{ for all } y \in P \\ \Leftrightarrow & \mu(\underline{s}_1)(x_{\underline{s}_1, \underline{s}_2}^l) (\mu(\underline{s}_1)l\mu(\underline{s}_2)^{-1})(y) = y \mu(\underline{s}_1)(x_{\underline{s}_1, \underline{s}_2}^l) \text{ for all } y \in P, \underline{s}_1, \underline{s}_2 \in S_n, l \in L_n \end{aligned}$$

and hence $x_{\underline{s}_1, \underline{s}_2}^l \neq 0 \Leftrightarrow \mu(\underline{s}_1)l\mu(\underline{s}_2)^{-1} = e$ since P is a factor; further, in such cases, $x_{\underline{s}_1, \underline{s}_2}^l$ is a scalar multiple of 1. Now,

$$\begin{aligned}
& wk = kw \text{ for all } k \in K \\
\Leftrightarrow & k^{-1}wk = w \text{ for all } k \in K \\
\Leftrightarrow & \sum_{\substack{\underline{s}_1, \underline{s}_2 \in S_n, \\ l \in L_n}} (\lambda_k^{-1} \otimes I_{T_{n-1}} \otimes 1)(E_{\underline{s}_1, \underline{s}_2} \otimes x_{\underline{s}_1, \underline{s}_2}^l l)(\lambda_k \otimes I_{T_{n-1}} \otimes 1) \\
& = \sum_{\substack{\underline{s}_1, \underline{s}_2 \in S_n \\ l \in L_n}} E_{\underline{s}_1, \underline{s}_2} \otimes x_{\underline{s}_1, \underline{s}_2}^l l \text{ for all } k \in K \\
\Leftrightarrow & \sum_{\substack{k_1, k_2 \in K, \\ \underline{t}_1, \underline{t}_2 \in T_{n-1}, \\ l \in L_n}} \lambda_k^{-1} E_{k_1, k_2} \lambda_k \otimes E_{\underline{t}_1, \underline{t}_2} \otimes x_{(k_1, \underline{t}_1), (k_2, \underline{t}_2)}^l l \\
& = \sum_{\substack{k_1, k_2 \in K, \\ \underline{t}_1, \underline{t}_2 \in T_{n-1}, \\ l \in L_n}} E_{k_1, k_2} \otimes E_{\underline{t}_1, \underline{t}_2} \otimes x_{(k_1, \underline{t}_1), (k_2, \underline{t}_2)}^l l \text{ for all } k \in K \\
\Leftrightarrow & \sum_{\substack{k_1, k_2 \in K, \\ \underline{t}_1, \underline{t}_2 \in T_{n-1}, \\ l \in L_n}} E_{k^{-1}k_1, k^{-1}k_2} \otimes E_{\underline{t}_1, \underline{t}_2} \otimes x_{(k_1, \underline{t}_1), (k_2, \underline{t}_2)}^l l \\
& = \sum_{\substack{k_1, k_2 \in K, \\ \underline{t}_1, \underline{t}_2 \in T_{n-1}, \\ l \in L_n}} E_{k_1, k_2} \otimes E_{\underline{t}_1, \underline{t}_2} \otimes x_{(k_1, \underline{t}_1), (k_2, \underline{t}_2)}^l l \text{ for all } k \in K \\
\Leftrightarrow & x_{(k_1, \underline{t}_1), (k_2, \underline{t}_2)}^l = x_{(kk_1, \underline{t}_1), (kk_2, \underline{t}_2)}^l \text{ for all } k, k_1, k_2 \in K, \underline{t}_1, \underline{t}_2 \in T_{n-1}, l \in L_n
\end{aligned}$$

Finally, combining the conditions that we get from considering commutation of w with elements of P and K , we can express w as a linear combination of elements of the form:

$$\sum_{k \in K} E_{kk_1, kk_2} \otimes E_{\underline{t}_1, \underline{t}_2} \otimes l$$

where $k_1, k_2 \in K$, $\underline{t}_1, \underline{t}_2 \in T_{n-1}$, $l \in L_n$ such that $k_1\mu(\underline{t}_1)l\mu(\underline{t}_2)^{-1}k_2^{-1} = e$. Equivalently, w can be realized as a linear combination of:

$$\sum_{k \in K} E_{kk_0^{-1}, k} \otimes E_{\underline{t}_1, \underline{t}_2} \otimes l = \sum_{k \in K} E_{k, kk_0} \otimes E_{\underline{t}_1, \underline{t}_2} \otimes l$$

where $\underline{t}_1, \underline{t}_2 \in T_{n-1}$, $l \in L_n$ such that $\mu(\underline{t}_1)l\mu(\underline{t}_2)^{-1} \in K$ and $k_0 = \mu(\underline{t}_1)l\mu(\underline{t}_2)^{-1}$. \square

Remark 4.10. (i) The set $\left\{ E_{\underline{s}_1, \underline{s}_2} \otimes l \left| \begin{array}{l} \underline{s}_1, \underline{s}_2 \in S_n, \\ l \in L_n, \\ \mu(\underline{s}_1)l\mu(\underline{s}_2)^{-1} \in H \end{array} \right. \right\}$ (resp. $\left\{ \sum_{k \in K} E_{k, kk_0} \otimes E_{\underline{t}_1, \underline{t}_2} \otimes l \left| \begin{array}{l} \underline{t}_1, \underline{t}_2 \in T_{n-1}, \\ \mu(\underline{t}_1)l\mu(\underline{t}_2)^{-1} \in K, \\ k_0 = \mu(\underline{t}_1)l\mu(\underline{t}_2)^{-1} \end{array} \right. \right\}$) forms a basis of $N' \cap M_n$ (resp. $M' \cap M_n$).

(ii) The unique trace-preserving conditional expectation from $N' \cap M_n$ onto $M' \cap M_n$ is given by:

$$\mathbb{E}_{M' \cap M_n}^{N' \cap M_n}(E_{k_1, k_2} \otimes E_{\underline{t}_1, \underline{t}_2} \otimes l) = \delta_{k_1 \mu(\underline{t}_1) l, k_2 \mu(\underline{t}_2)} \frac{1}{|K|} \sum_{k \in K} E_{k, k k_1^{-1} k_2} \otimes E_{\underline{t}_1, \underline{t}_2} \otimes l$$

where $k_1, k_2 \in K$, $\underline{t}_1, \underline{t}_2 \in T_{n-1}$, $l \in L_n$ such that $k_1 \mu(\underline{t}_1) l \mu(\underline{t}_2)^{-1} k_2^{-1} \in H$.

To see (ii), we need to check that for $\underline{t}_1', \underline{t}_2' \in T_{n-1}$ and $k_0' = \mu(\underline{t}_1') l' \mu(\underline{t}_2')^{-1} \in K$,

$$\begin{aligned} & \text{tr} \left[\left(\sum_{k' \in K} E_{k', k' k_0'} \otimes E_{\underline{t}_1', \underline{t}_2'} \otimes l' \right) (E_{k_1, k_2} \otimes E_{\underline{t}_1, \underline{t}_2} \otimes l) \right] \\ &= \delta_{l' l, e} \delta_{\underline{t}_2', \underline{t}_1} \delta_{\underline{t}_1', \underline{t}_2} \delta_{k_2 k_0', k_1} \frac{1}{|S_n|} \\ &= \delta_{k_1 \mu(\underline{t}_1) l, k_2 \mu(\underline{t}_2)} \delta_{l' l, e} \delta_{\underline{t}_1, \underline{t}_2'} \delta_{\underline{t}_2, \underline{t}_1'} \delta_{e, k_0' k_1^{-1} k_2} \frac{1}{|S_n|} \\ &= \text{tr} \left[\left(\sum_{k' \in K} E_{k', k' k_0'} \otimes E_{\underline{t}_1', \underline{t}_2'} \otimes l' \right) (\delta_{k_1 \mu(\underline{t}_1) l, k_2 \mu(\underline{t}_2)} \frac{1}{|K|} \sum_{k \in K} E_{k, k k_1^{-1} k_2} \otimes E_{\underline{t}_1, \underline{t}_2} \otimes l) \right] \end{aligned}$$

which is a routine computation using the second part of Remark 4.5.

5. THE PLANAR ALGEBRA OF GROUP-TYPE SUBFACTORS

In this section, our main goal is to show that the planar algebra defined in section 3, is isomorphic to the one arising from the group-type subfactor $P^H \subset P \rtimes K$. Conversely, we will show that any subfactor whose standard invariant is given by such planar algebra, is indeed of this type.

We will use the following well-known fact regarding isomorphism of two planar algebras and Theorem 4.2.1 of [11] describing the planar algebra arising from an extremal finite index subfactor.

Fact: Let P^1 and P^2 be two planar algebras. Then $P^1 \cong P^2$ if and only if there exist a vector space isomorphism $\psi : P^1 \rightarrow P^2$ such that:

- (i) ψ preserves the filtered algebra structure,
- (ii) ψ preserves the actions of all possible Jones projection tangles and the (two types of) conditional expectation tangles.

If P_1 and P_2 are $*$ -planar algebras, then we consider such ψ that are $*$ -preserving to be a $*$ -planar algebra isomorphism.

Let us denote the planar algebra in section 3 by P^{BH} and the one arising from the group-type subfactor $N = P^H \subset P \rtimes K = M$ by $P^{N \subset M}$.

Theorem 5.1. $P^{N \subset M} \cong P^{BH}$.

Proof: By Theorem 4.2.1 of [11] we have that $P_n^{N \subset M} = N' \cap M_n$ where the n -th Jones projection tangle is given by δ_{e_n} , the conditional expectation tangle from $P_n^{N \subset M}$ onto $P_{n-1}^{N \subset M}$ is $\delta \mathbb{E}_{N' \cap M_n}^{N' \cap M_{n+1}}$ and the conditional expectation tangle from $P_n^{N \subset M}$ onto $P_{1,n}^{N \subset M}$ is $\delta \mathbb{E}_{M' \cap M_{n+1}}^{N' \cap M_{n+1}}$.

Define the map

$$\begin{aligned} \psi : P^{N \subset M} &\rightarrow P^{BH} \\ &\cup \quad \cup \quad \text{by } \psi_n(E_{\underline{s}_1, \underline{s}_2} \otimes l) = (\underline{s}_1, l, \tilde{s}_2, h) \\ \psi_n : P_n^{N \subset M} &\rightarrow P_n^{BH} \end{aligned}$$

where $n \geq 0$, $\underline{s}_1, \underline{s}_2 \in S_n$, $l \in L_n$ such that $\mu(\underline{s}_1)l\mu(\underline{s}_2)^{-1} \in H$ and $\mu(\underline{s}_1)l\mu(\underline{s}_2)^{-1}h = e$.

Clearly, ψ is a vector space isomorphism by definition. In order to check that ψ is a filtered $*$ -algebra isomorphism, we use Remark 3.3 (i), (ii), (iii) and (iv). For instance, to show that ψ_n is an algebra homomorphism, we need to show

$$\begin{aligned} \psi_n(E_{\underline{s}_1, \underline{s}_2} \otimes l_1 \cdot E_{\underline{s}_3, \underline{s}_4} \otimes l_2) &= \psi_n(E_{\underline{s}_1, \underline{s}_2} \otimes l_1) \cdot \psi_n(E_{\underline{s}_3, \underline{s}_4} \otimes l_2) \\ \Leftrightarrow \delta_{\underline{s}_2, \underline{s}_3}(\underline{s}_1, l_1 l_2, \tilde{s}_4, \mu(\underline{s}_4)l_2^{-1}l_1^{-1}\mu(\underline{s}_1)^{-1}) \\ &= (\underline{s}_1, l_1, \tilde{s}_2, \mu(\underline{s}_2)l_1^{-1}\mu(\underline{s}_1)^{-1}) \cdot (\underline{s}_3, l_2, \tilde{s}_4, \mu(\underline{s}_4)l_2^{-1}\mu(\underline{s}_3)^{-1}) \end{aligned}$$

which indeed holds by Remark 3.3 (iii).

Now, it remains to be shown that ψ preserves the action of Jones projection tangles and the two types of conditional expectation tangles. For this, we use Remark 3.3 (v), (vi) and (vii). Proof of each of the three kinds of tangles, is completely routine; however, we will discuss the action of conditional expectation tangle in details. Let us consider the conditional expectation tangle from $n+1$ (colour of the internal disc) to colour n (colour of the external disc) applied to the element $E_{\underline{s}_1, \underline{s}_2} \otimes E_{m_1, m_2} \otimes l \in P_{n+1}^{N \subset M} = N' \cap M_n$; by Jones's theorem (4.2.1 of [11]) and Remark 4.5, the output should be

$$\begin{aligned} \delta_{l, e} \sqrt{\frac{|L_n|}{|L_{n+1}|}} E_{\underline{s}_1, \underline{s}_2} \otimes m_1 m_2^{-1} \\ \xrightarrow{\psi_n} \delta_{l, e} \sqrt{\frac{|L_n|}{|L_{n+1}|}} (\underline{s}_1, m_1 m_2^{-1}, \tilde{s}_2, \mu(\underline{s}_2) m_2 m_1^{-1} \mu(\underline{s}_1)^{-1}) \end{aligned}$$

On the other hand, by Remark 3.3 (vi), the conditional expectation tangle applied to $\psi_{n+1}(E_{\underline{s}_1, \underline{s}_2} \otimes E_{m_1, m_2} \otimes l) = (\underline{s}_1, m_1, l^{-1}, m_2^{-1}, \tilde{s}_2, \mu(\underline{s}_2) m_2 l m_1^{-1} \mu(\underline{s}_1)^{-1})$ is given by $\delta_{l, e} \sqrt{\frac{|L_n|}{|L_{n+1}|}} (\underline{s}_1, m_1 m_2^{-1}, \tilde{s}_2, \mu(\underline{s}_2) m_2 m_1^{-1} \mu(\underline{s}_1)^{-1})$.

This completes the proof. \square

Corollary 5.2. *Given any countable discrete group G generated by two of its finite subgroups, there exists a hyperfinite subfactor with standard invariant described by P^{BH} . Moreover, P^{BH} is a spherical C^* planar algebra.*

Proof: The proof follows from the fact that any countable discrete group G has an outer action on the hyperfinite II_1 factor. \square

Theorem 5.3. *Given a subfactor $N \subset M$ with standard invariant isomorphic to P^{BH} , there exists an intermediate subfactor $N \subset P \subset M$ and outer actions of H and K on P such that $(N \subset M) \simeq (P^H \subset P \rtimes K)$.*

Proof: Let $P^{N \subset M}$ denote the planar algebra of $N \subset M$ formed by its relative commutants and $\phi : P^{N \subset M} \rightarrow P^{BH}$ be a planar algebra isomorphism. Consider the element $q = \phi^{-1}(e, e, e, e) \in N' \cap M_1$. Clearly, (i) q is a projection, (ii) $q e_1 = e_1$ and

(iii) $\mathbb{E}_M(q) = |K|^{-1}1$. Using action of tangles and the planar algebra isomorphism ϕ , it also follows that

$$(iv) \quad \begin{array}{c} | \\ | \\ \text{* } \boxed{q} \text{*} \\ | \\ | \end{array} \begin{array}{c} | \\ | \\ \text{* } \boxed{q} \text{*} \\ | \\ | \end{array} = \sqrt{\frac{|H|}{|K|}} \begin{array}{c} | \\ | \\ \text{* } \boxed{q} \text{*} \\ | \\ | \end{array}$$

The conditions (i) - (iv) asserts that q is an *intermediate subfactor projection* as described in [1]. Define $P = M \cap \{q\}'$. To show P is a factor, first note that

$$P' \cap P \subset N' \cap P = N' \cap M \cap \{q\}' = \phi(P_1^{BH} \cap \{(e, e, e, e)\}')$$

So, it is enough to show that $P_1^{BH} \cap \{(e, e, e, e)\}' = \mathbb{C}1$. If $x = \sum_{g \in K \cap H} (g, g^{-1}) \in P_1^{BH} \cap \{(e, e, e, e)\}'$, then

$$(e, e, e, e) \cdot x = x \cdot (e, e, e, e) \Rightarrow \sum_{g \in K \cap H} \lambda_g(e, e, g, g^{-1}) = \sum_{g \in K \cap H} \lambda_g(g, e, e, g^{-1})$$

Hence, $\lambda_g = \delta_{g,e} \lambda_e$ for all $g \in K \cap H$ and $x \in \mathbb{C}1$.

It remains to establish that N (resp. M) is the fixed-point subalgebra (resp. crossed-product algebra) of P with respect to an outer action of the group H (resp. K). It is easy to prove (see [11]) that if the standard invariant of a subfactor $\tilde{N} \subset \tilde{M}$ is given by the planar algebra corresponding to the fixed-point subfactor (resp. crossed-product subfactor) with respect to a finite group \tilde{G} , then there exist an outer action of \tilde{G} on \tilde{M} (resp. \tilde{N}) such that \tilde{N} (resp. \tilde{M}) is isomorphic to fixed-point subalgebra (crossed-product algebra) of the action. Again, if $\tilde{N} \subset \tilde{P} \subset \tilde{M}$ is an intermediate subfactor and \tilde{q} is its corresponding intermediate subfactor projection, then the planar algebra of $\tilde{N} \subset \tilde{P}$ (resp. $\tilde{P} \subset \tilde{M}$) is given by the range of the idempotent tangle

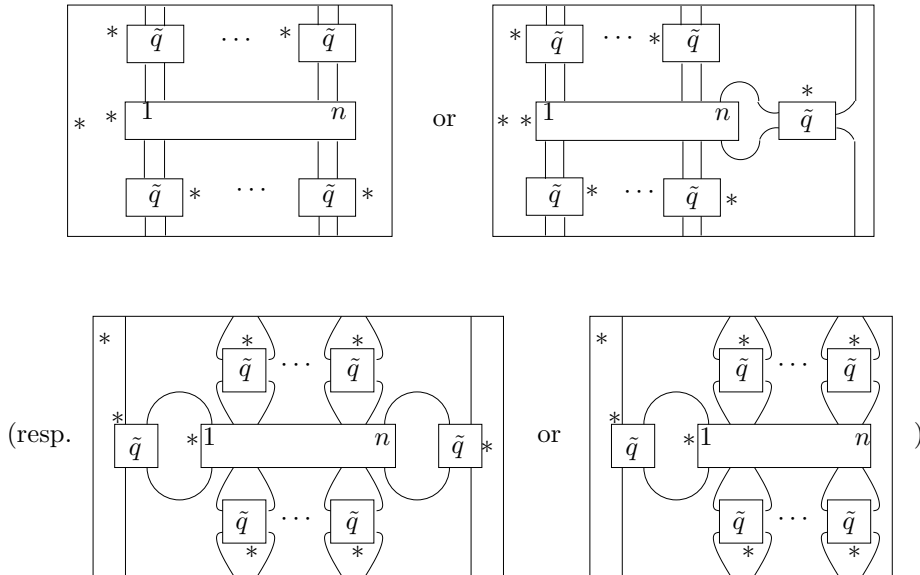

according as n is even or odd ([5], see also [7]).

Getting back to our context, to get the planar algebra of $N \subset P$ (resp. $P \subset M$), the elements in the image of the above idempotent tangles are given by the words with letters coming from K and H alternately where every element coming from K (respectively H) must necessarily be e . Such a planar algebra is the same as P^{BH} with $K = \{e\}$ (resp. $H = \{e\}$); by Theorem 5.1 this is indeed the planar algebra corresponding to fixed-point subfactor (resp. crossed-product subfactor) with respect to H (resp. K). \square

REFERENCES

1. D. Bisch, *A note on intermediate subfactors*, Pacific J. Math. 163 (2), (1994), 201–216.
2. D. Bisch, *Bimodules, higher relative commutants and the fusion algebra associated to a subfactor*, Operator algebras and their applications, 13–63, Fields Inst. Commun., 13, Amer. Math. Soc., Providence, RI, 1997.
3. D. Bisch, U. Haagerup, *Composition of subfactors: New examples of infinite depth subfactors*, Ann. scient. Éc. Norm. Sup., 29, (1996), 329–383.
4. D. Bisch, V. Jones, *Algebras associated to intermediate subfactors* Invent. Math. 128 (1997), no. 1, 89–157.
5. D. Bisch, V. Jones, *The free product of planar algebras, and subfactors*, in preparation.
6. D. Bisch, S. Popa, *Examples of subfactors with Property (T) standard invariant*, Geom. Func. Anal. 9, (1999), 215–225.
7. B. Bhattacharyya, Z. Landau *Intermediate standard invariants and intermediate planar algebras*, preprint.
8. D. Evans, Y. Kawahigashi, *Quantum symmetries on operator algebras*, Oxford Mathematical Monographs. Oxford Science Publications. Oxford University Press, New York, 1998. xvi+829 pp.
9. F. Goodman, P. de la Harpe, V. Jones, *Coxeter graphs and towers of algebras. Mathematical Sciences Research Institute Publications*, 14. Springer-Verlag, New York, 1989. x+288 pp.
10. V. Jones, *Index for subfactors*, Invent. Math., 72, (1983), 1–25.
11. V. Jones, *Planar Algebras*, arxiv:math/9909027v1.
12. V. Jones, *Two subfactors and the algebraic decomposition of bimodules over II_1 factors*, preprint.
13. V. Jones, V.S. Sunder, *Introduction to subfactors*, LMS Lecture Note Series 234, (1997), ISBN: 0-521-58420-5.
14. A. Ocneanu, *Quantized groups, string algebras and Galois theory for algebras*, Operator algebras and applications, Vol. 2, 119–172, London Math. Soc. Lecture Note Ser., 136, Cambridge Univ. Press, Cambridge, 1988.
15. M. Pimsner, S. Popa, *Iterating the basic construction*, Trans. Amer. Math. Soc. 310 (1988), no. 1, 127–133.
16. S. Popa, *An axiomatization of the lattice of higher relative commutants of a subfactor*, Invent. Math., 120, (1995), 427–445.
17. S. Popa, *Classification of amenable subfactors of type II*, Acta Math. 172, (1994), 163–255.
18. S. Popa, *Some properties of the symmetric enveloping algebra of a subfactor, with applications to amenability and property T*, Doc. Math. 4 (1999), 665–744.
19. J.-M. Vallin, *Relative matched pairs of finite groups from depth two inclusions of von Neumann algebras to quantum groupoids*, preprint.

VANDERBILT UNIVERSITY, DEPARTMENT OF MATHEMATICS, SC 1326, NASHVILLE, TN 37240, USA

E-mail address: dietmar.bisch@vanderbilt.edu

E-mail address: paramita.das@vanderbilt.edu

E-mail address: shamindra.k.ghosh@vanderbilt.edu