

Drawing Binary Tanglegrams: An Experimental Evaluation

Martin Nöllenburg^{1*}, Danny Holten², Markus Völker¹, and Alexander Wolff²

¹ Fakultät für Informatik, Universität Karlsruhe, Germany.
{ noellenburg, mvoelker }@iti.uka.de

² Faculteit Wiskunde en Informatica, TU Eindhoven, The Netherlands.
d.h.r.holten@tue.nl, <http://www.win.tue.nl/~awolff>

Abstract. A *binary tanglegram* is a pair $\langle S, T \rangle$ of binary trees whose leaf sets are in one-to-one correspondence; matching leaves are connected by inter-tree edges. For applications, for example in phylogenetics or software engineering, it is required that the individual trees are drawn crossing-free. A natural optimization problem, denoted *tanglegram layout problem*, is thus to minimize the number of crossings between inter-tree edges.

The tanglegram layout problem is NP-hard and is currently considered both in application domains and theory. In this paper we present an experimental comparison of a recursive algorithm of Buchin et al. [2], our variant of their algorithm, the algorithm hierarchy sort of Holten and van Wijk [8], and an integer quadratic program that yields optimal solutions.

1 Introduction

In this paper we are interested in evaluating the performance of two recently suggested algorithms for drawing so-called *tanglegrams* [11], that is, pairs of trees whose leaf sets are in one-to-one correspondence. The need to visually compare pairs of trees arises in applications such as the analysis of software projects, phylogenetics, or clustering. In the first application, trees may represent package-class-method hierarchies or the decomposition of a project into layers, units, and modules. The aim is to analyze changes in hierarchy over time or to compare human-made decompositions with automatically generated ones. Whereas trees in software analysis can have nodes of arbitrary degree, trees from our second application, that is, (rooted) phylogenetic trees, are binary trees. This makes binary tanglegrams an interesting special case, see Fig. 1. Hierarchical clusterings, our third application, are usually visualized by a binary tree-like structure called *dendrogram*, where elements are represented by the leaves and each internal node of the tree represents the cluster containing the leaves in its subtree. Pairs of dendrograms stemming from different clustering processes of the same data can be compared visually using tanglegrams.

From the application point of view it makes sense to insist that (a) the trees under consideration are drawn plane, that is, without edge crossings, (b) each leaf of one tree is connected by an *inter-tree* edge to the corresponding leaf in the other tree, and (c) the number of crossings among the inter-tree edges is minimized. Following the

* Supported by grant WO 758/4-3 of the German Research Foundation (DFG).

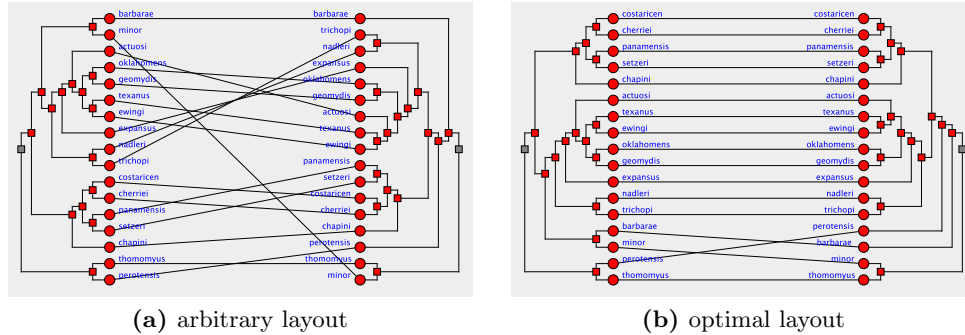

Fig. 1: A binary tanglegram of phylogenetic trees for lice of pocket gophers [7].

bioinformatics literature (e.g., [11, 10]), we call this the *tanglegram layout* problem; Fernau et al. [5] refer to it as *two-tree crossing minimization*.

Problem: (Tanglegram Layout (TL)). Given a tanglegram $\langle S, T \rangle$ consisting of two rooted trees S and T on n leaves and a bijection between their leaf sets, find a tanglegram layout, that is, two plane drawings of S and T , such that

1. the drawing of S is to the left of the line $x = 0$ with all leaves on $x = 0$;
2. the drawing of T is to the right of the line $x = 1$ with all leaves on $x = 1$;
3. the inter-tree edges are drawn as straight-line segments;
4. the number of inter-tree edge crossings is minimum.

Given a tree T , we say that a linear order of its leaves is *compatible* with T if for each node v of T the nodes in the subtree of v form an interval in the order. Note that TL is a purely combinatorial problem. In short, given two trees S and T , TL consists of finding an order σ of the leaves of S compatible with S and an order τ of the leaves of T compatible with T such that the number of inversions between τ and σ is minimum [5, 2]. Let the *crossing number* of a tanglegram $\langle S, T \rangle$ be the minimum number of inter-tree edge crossings of any tanglegram layout of $\langle S, T \rangle$.

In the following we restrict our attention to *binary* tanglegrams such as, for example, pairs of phylogenetic trees or clustering dendrograms. The restriction of TL to binary trees is denoted as *binary TL*. After presenting related work (Section 2), we introduce the algorithms that we want to compare experimentally (Section 3). We first sketch a recursive algorithm of Buchin et al. [2]. Then, in an algorithm engineering process we adapt their algorithm to the needs of unbalanced trees in order to achieve better results. We apply branch-and-bound to speed up the improved variant. Next, we introduce hierarchy sort, a crossing-reduction heuristic used in the visualization tool of Holten and van Wijk [8], and a quadratic integer program that solves binary TL optimally. Finally, we provide a detailed description of the results of our experimental comparison of these algorithms, see Section 4.

2 Related Work

In graph drawing the so-called *two-sided crossing minimization problem* (2SCM) is an important NP-hard problem that occurs when computing layered graph layouts. Such layouts have been introduced by Sugiyama et al. [12] and are widely used for drawing hierarchical graphs. In 2SCM, vertices of a bipartite graph are to be placed on two parallel lines (called *layers*) such that for each vertex on one line all its adjacent vertices lie on the other line. As in TL the objective is to minimize the number of edge crossings provided that edges are drawn as straight-line segments. In one-sided crossing minimization (1SCM) the order of the vertices on one of the layers is fixed. Even 1SCM is NP-hard [4]. Jünger and Mutzel [9] performed an experimental comparison of exact and heuristic algorithms for both 1SCM and 2SCM. The main findings were that for 1SCM the exact solution can be computed quickly for up to 60 vertices in the free layer, and for 2SCM an iterated barycenter heuristic is the method of choice for instances with more than 15 vertices in each layer.

The main difference between TL and 2SCM is that in TL, the possible orders of the leaves are limited to those that are compatible with the two input trees. Furthermore the inter-tree edges are usually restricted to be a matching of the leaves. Dwyer and Schreiber [3] studied drawing a series of tanglegrams in 2.5 dimensions, that is, the trees are drawn on a set of stacked two-dimensional planes. They considered a one-sided version of binary TL by fixing the layout of the first tree in the stack, and then, layer-by-layer, computing an optimal compatible leaf order of the next tree in $O(n^2 \log n)$ time each. Fernau et al. [5] showed that binary TL is NP-hard and gave a fixed-parameter algorithm that runs in $O^*(c^k)$ time, where the O^* -notation ignores polynomial factors, c is a constant that Fernau et al. estimate to be 1024, and k is the minimum number of crossings in any drawing of the given tanglegram. They further showed that the problem can be solved in $O(n \log^2 n)$ time if the leaf order of one tree is fixed. This improves the result of Dwyer and Schreiber [3]. They also made the simple observation that the edges of the tanglegram can be directed from one root to the other. Thus the existence of a planar drawing can be verified using a linear-time upward-planarity test for single-source directed acyclic graphs [1]. Later, apparently not knowing these previous results, Lozano et al. [10] gave a quadratic-time algorithm for the same special case, to which they refer as *planar tanglegram layout*. Recently, Buchin et al. [2] showed that binary TL remains NP-hard even if both trees are complete binary trees. For this case they gave an $O(n^3)$ -time factor-2 approximation algorithm and a simple $O^*(4^k)$ -time fixed-parameter algorithm, where k is the minimum number of crossings as before. Their approximation algorithm is based on recursive splitting of the instance and can also be used as a heuristic for general binary trees. Holten and van Wijk [8] present a tanglegram visualization tool for the comparison of two (not necessarily binary) trees that uses local optimization to reduce inter-tree crossings and an edge-bundling technique to reduce visual clutter.

3 Algorithms

In this section we describe the recursive splitting algorithm of Buchin et al. [2] and our improved variant of it, then the algorithm hierarchy sort of Holten and van

Wijk [8], and finally a simple integer quadratic program (IQP) that provides us with exact solutions for the experimental comparison that follows in Section 4.

3.1 Recursive Splitting Algorithm

The main idea behind the recursive splitting algorithm is to recursively consider for an instance $\langle S, T \rangle$ the four possible orders of the two subtrees S_1, S_2 of S and T_1, T_2 of T below the roots v_S and v_T of S and T as in Fig. 2. Each order gives rise to a certain number of crossings at that level of the recursion (called *current-level crossings*), which is added to the number of crossings of both recursively solved subproblems induced by that order (called *lower-level crossings*). Each current-level crossing has the property that it can be removed

by swapping the subtrees of v_S or v_T . For example the crossing depicted in Fig. 2 can be removed by swapping the subtrees of v_S and placing S_2 above S_1 . Of course such a swap generally introduces other current-level crossings. The minimum of the four possibilities will be returned to the previous level of the recursion. The two subproblems that arise from each recursive split are not independent. Nevertheless, they are treated independently by the algorithm. This obviously

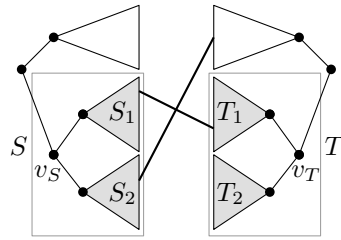

Fig. 2: A subinstance $\langle S, T \rangle$ with a current-level crossing.

introduces an error with respect to the actual number of crossings, which, for the case of *complete* binary trees, can be bounded by the number of crossings in an optimal solution [2]. For complete binary trees the recursive algorithm thus yields a 2-approximation. Obviously, the depth of the recursion equals the minimum height h of the two trees. The recursion tree is of size $O(8^h)$ since each instance starts eight recursive calls (two for each of the four subtree arrangements). The computation of all current-level crossings is done in $O(4^h n)$ time, resulting in a total running time of $O(8^h + 4^h n)$. For complete trees with $h = \log n$ this resolves to $O(n^3)$ time.

In applications most binary TL instances do not consist of *complete* binary trees. The above recursive algorithm can be applied to any pair of binary trees as a heuristic but an approximation guarantee cannot be given any more. Under the Unique Games Conjecture a constant-factor approximation does not even exist for general binary trees [2]. The original algorithm always divides an instance into an upper and a lower subinstance, that is, the two problems $\langle S_1, T_1 \rangle$ and $\langle S_2, T_2 \rangle$ in the example of Fig. 2. For unbalanced trees this can lead to an unnecessarily high number of ignored crossings as Fig. 3 shows. The original algorithm aligns the leaves (nodes 7 and 8) attached directly to the roots since this causes no current-level crossings. All 14 crossings in Fig. 3b are crossings that the algorithm does not take into account. A small modification of our algorithm weakens this effect (and yields the optimum solution in the given example). Instead of always dividing into an upper and a lower subinstance, we can also consider dividing into the two *diagonal* subinstances $\langle S_1, T_2 \rangle$ and $\langle S_2, T_1 \rangle$ in the example of Fig. 2. The improved algorithm always selects among the two possible splits the one that has the higher total number of edges between its two subinstances. This modification not only improves the algorithm performance,

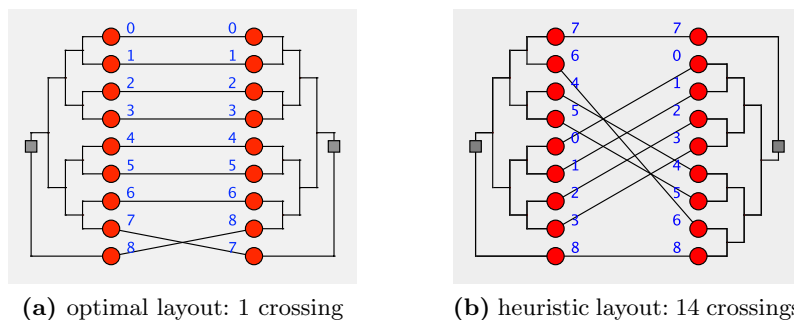

Fig. 3: Example of a binary tree for which the original heuristic performs badly.

but it also allows us to precompute in $O(n^2h)$ time all required numbers of current-level crossings for a constant-time lookup. Thus the total running time reduces to $O(8^h + n^2h)$, which still equals $O(n^3)$ for complete trees. Interestingly, it can be proved (omitted here) that the approximation factor of 2 still holds for this modified algorithm in the case of complete trees.

In our most refined implementation of the improved algorithm we additionally make use of a branch-and-bound technique in order to prune large parts of the search tree as early as possible. This considerably sped up the naive implementation, see Section 4.3. Let's consider an instance of the problem with roots $v_{S'}$ and $v_{T'}$. Instead of computing the number of crossings for all four possible arrangements of the respective subtrees of $v_{S'}$ and $v_{T'}$ we first consider the one that yields the lowest number of current-level crossings and recurse. This gives us an initial upper bound on the number of crossings once the leaf level is reached. Now at each level we can immediately prune the respective parts of the search tree for those arrangements that exceed this upper bound. The rest of the search tree is examined further, and each time a better solution is found the upper bound is updated accordingly.

3.2 Hierarchy Sort

The algorithm hierarchy sort of Holten and van Wijk [8] performs a number of collapse-and-expand cycles on both trees of the binary tanglegram. During each step of these cycles, the well-known barycentric method of Sugiyama et al. [12] for 1SCM is used by successively fixing one tree, optimizing the leaf order of the other, and then changing the trees' roles until no further crossing reduction is possible. We illustrate the algorithm using the example in Fig. 4.

Figure 4a shows a binary tanglegram with 13 inter-tree edge crossings. Figures 4b to 4p illustrate the hierarchy sorting algorithm using one full collapse-and-expand cycle. Since crossings are to be reduced on *corresponding* levels in the two trees, the numbers of levels of the two trees need to be equalized. This is done by introducing dummy nodes that bring all leaves to the lowest level. In our example, this results in a tanglegram consisting of two four-level binary trees, see Fig. 4b.

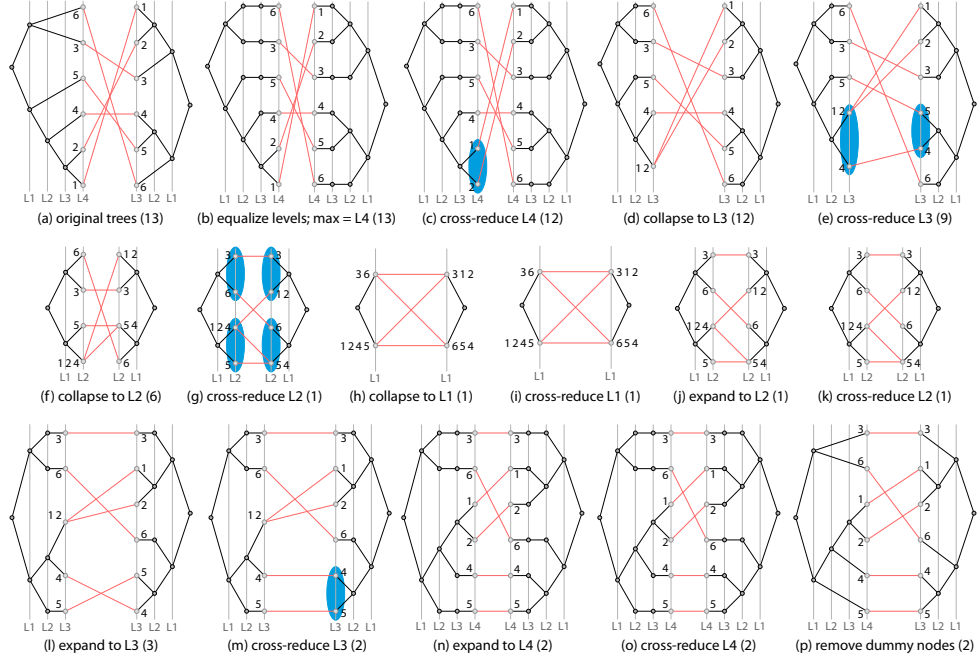

Fig. 4: Step-by-step crossing reduction (CR) using hierarchy sort. Nodes that are swapped during CR are encircled. The numbers of crossings after each step are given in parentheses.

Crossing reduction (CR) is now performed per level by employing the barycentric method on corresponding levels. Due to the hierarchical structure of the data that we consider, only nodes having the same parent may be swapped. Nodes that are swapped during CR are encircled in Fig. 4.

After having completed CR at the lowest level, we move up one level in both trees. We do this by *collapsing* both levels, that is, by contracting all edges ending in leaves (see the step from Fig. 4c to 4d, for example). CR can now proceed. Collapsing and CR are repeated until the levels below the roots are reached (Fig. 4i). At this point, the process is reversed and levels are expanded again (with in-between CR) until the leaf levels are reached. This is illustrated in Figs. 4j to 4o. Such collapse-and-expand cycles are repeated until the number of crossings does not decrease any further.

A last step remains: the original number of levels in both hierarchies needs to be restored, that is, all dummy nodes are contracted (see Fig. 4p). In our example the hierarchy sorting algorithm has reduced the number of crossings from 13 to 2.

The asymptotic running time of this algorithm depends of course on the number N of collapse-and-expand cycles and the maximum number N' of executions of the linear-time barycentric heuristic on each level. In our experiments (see Section 4) it turned out that in all instances we had $N \leq 2$ and $N' \leq 2$. Under the condition that both N and N' are constants, hierarchy sort runs in $O(n \cdot H)$ time, where H is the maximum height of the two trees. In the case of complete trees $H = \log n$, and the running time is $O(n \log n)$.

3.3 Integer Quadratic Program

For the IQP we introduce a binary variable x_u for each inner node of SUT . If $x_u = 1$, the two subtrees of u change their order with respect to the input drawing, otherwise the order of the input drawing is kept. Let ab and cd be two inter-tree edges with $a, c \in S$ and $b, d \in T$. Let $v \in S$ and $w \in T$ be the lowest common ancestors of the leaves a and c , and of b and d , respectively. Assume that ab and cd cross each other in the original drawing. Then ab and cd cross each other in the solution encoded by the IQP if and only if $x_u \cdot x_v = 1$ or $(1 - x_u) \cdot (1 - x_v) = 1$. Otherwise, if ab and cd do not cross each other originally, they will cross in the solution encoded by the IQP if and only if $x_u \cdot (1 - x_v) = 1$ or $(1 - x_u) \cdot x_v = 1$. Thus the total number of edge crossings can be expressed as the sum of these products for all pairs of edges. The IQP minimizes this sum as its objective function. No further constraints, apart from the variables being binary, are necessary.

4 Experimental Results

The recursive splitting algorithms were written in Java 1.5 and executed in SuSE Linux 9.3 running on an AMD Opteron 248 2.2 GHz system with 4 GB RAM. The hierarchy sorting algorithm was implemented in Delphi 7.0 and executed in Windows XP on an Intel Pentium 4 2.8 GHz system with 1 GB RAM. The quadratic program was solved with the mathematical programming software CPLEX 9.1 running on the above Linux system.

4.1 Data

We generated four sets (A–D) of random tanglegrams. Set A contains ten pairs of complete binary trees with random leaf orders for each $n = 16, 32, \dots, 256$. In set B we simulated tree mutations by starting with two identical complete binary trees and then randomly swapping the positions of up to 20% of the leaves of one tree. This is done as follows: we first pick a leaf uniformly at random and then iteratively climb up the tree with probability 0.75 in each step. From the node thus reached we climb back down and flip a coin at each node to choose its left or right child until we reach another leaf. This leaf and the leaf picked in the beginning are swapped. Thus the probability of two leaves being swapped decreases with their distance in the tree. Set C contains ten pairs of general binary trees for each $n = 20, 40, \dots, 200$. The trees are constructed from a set of nodes, initially containing the n leaves, by iteratively joining two random nodes in a new parent node that replaces its children in the set. This process generates trees that resemble phylogenetic trees or clustering dendrograms. Set D is similar to set C but again in each tanglegram the second tree is a mutation of the first tree, where up to 10% of the leaves can swap positions as done in set B and up to 25% of the subtrees can reattach to another edge. This edge is selected in a random walk starting at the subtree’s old position. The walk continues with probability 0.75 and chooses the left or right edge by tossing a coin. Trees in this set are of interest since real-world tanglegrams often consist of two related and rather similar trees. The average crossing numbers of the trees in sets A–D are given in Fig. 8 in the appendix.

Our real-world examples comprise three sets (E–G) of tanglegrams. Set E contains six pairs of dendrograms of a hierarchically clustered social network based on email communication of 21 subjects [6]. Sets F and G contain six and ten pairs of phylogenetic trees for 15 species of pocket gophers and 17 species of lice, respectively [7]. (Fig. 1 shows a tanglegram in set G.) While the email tanglegrams have between 23 and 45 crossings in an optimal solution, the phylogenetic trees can be drawn with at most two crossings, most of them even without any crossings.

4.2 Performance

In the following we denote the original recursive algorithm of Buchin et al. [2] by *rec-split* and our modification for unbalanced trees by *rec-split-improved*. The algorithm of Holten and van Wijk is *hierarchy sort*. Let n be the size of an instance, that is, the number of leaves per tree.

To each tanglegram we applied the three algorithms and the IQP, and recorded the crossing numbers c_i in their respective solutions for $i = \textit{rec-split}, \textit{rec-split-improved}, \textit{hierarchy sort}$. We then computed for each tanglegram the performance ratios $(c_i + 1)/(c_{\text{opt}} + 1)$, where c_{opt} denotes the optimal number of crossings obtained from solving the IQP. Note that we add one to both crossing numbers in order to have a well-defined ratio also for crossing-free instances.

The results for sets A–D are shown in Fig. 5. For complete binary trees (sets A and B) *rec-split* and *rec-split-improved* achieved similar performance ratios that tend to 1 as the size of the trees grows. Recall that on these complete instances both algorithms are 2-approximations. On average both methods performed slightly better on mutated trees (B) than on random trees (A). In several cases the instances in set B could be solved optimally. The average performance ratio of *hierarchy sort* was slightly worse for the random trees of set A and drastically worse for the mutated trees of set B with average values between 2.23 and 4.4 in comparison to values between 1 and 1.05 for the recursive algorithms. Furthermore, *hierarchy sort* performed better on random trees rather than on mutated trees. Note that the absolute number of crossings is lower for mutated trees; thus a difference of only 1 or 2 to the optimum can already lead to relatively large ratios for small n .

For general binary trees the performance ratios of *rec-split* and *rec-split-improved* are no longer upper-bounded by 2 but at least for random trees (C) the ratios were on average well below 2. As expected, *rec-split-improved* outperformed *rec-split* due to the modification for unbalanced trees. Algorithm *rec-split* attained performance ratios close to 1 for most random instances but it had some outliers as well. The solutions of *rec-split-improved* were not only closer to the optimum, they also spread much less. Note that due to excessive computation times of several hours we did not record the results of *rec-split* for $n \geq 110$. The hierarchy sorting algorithm yielded results that were clearly inferior to those of the recursive algorithms. But it still achieved performance ratios below 1.2 as n grows. In general, the behavior of both *rec-split-improved* and *hierarchy sort* did not differ much between sets A and C and thus the completeness of the trees seems of low impact on the solution quality. In contrast *rec-split* performed worse on general trees than on complete trees.

For the mutated trees of set D with relatively fewer crossings in the optimal solution we use a logarithmic scale for the performance ratio. The results were generally

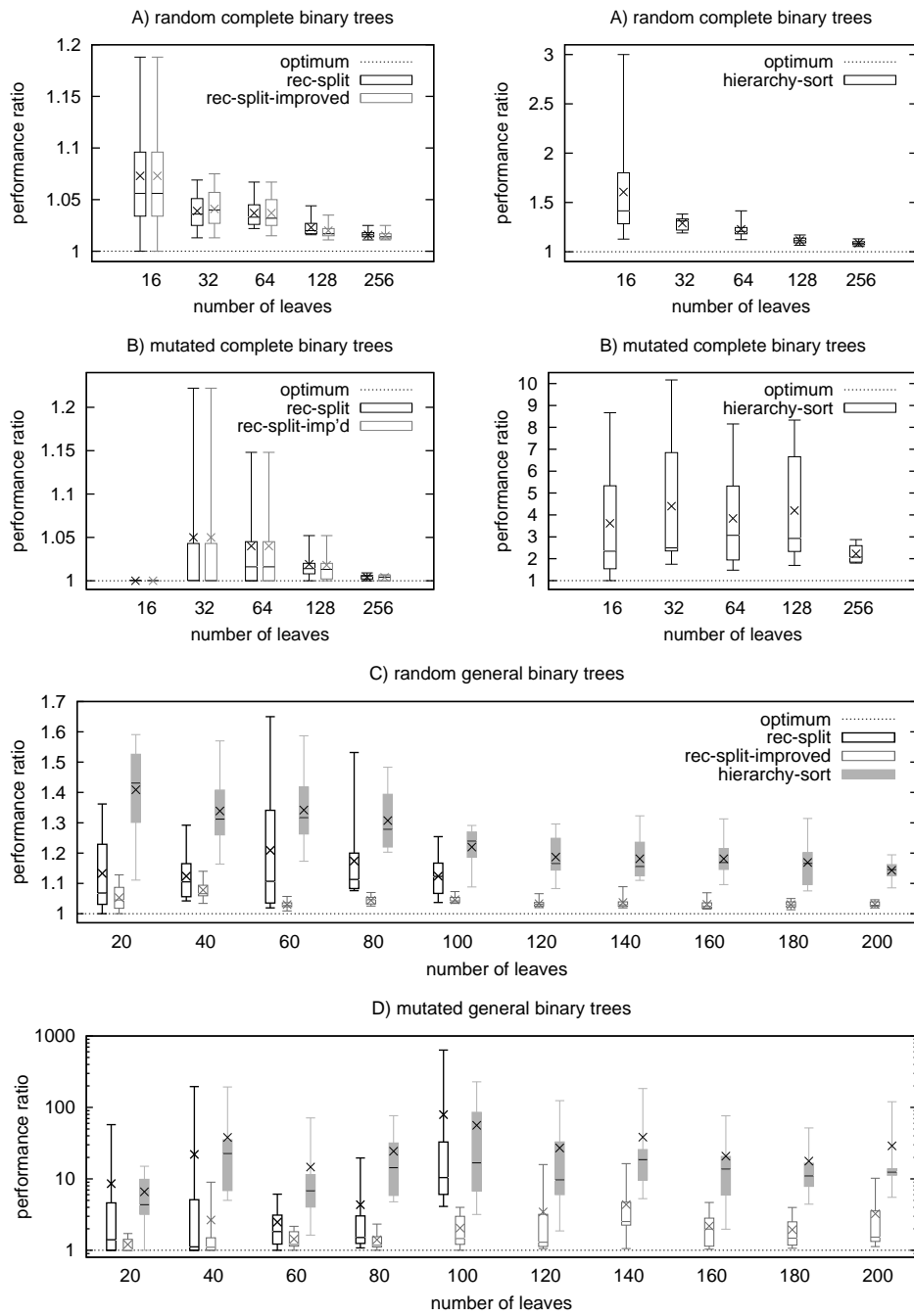

Fig. 5: Performance ratios of the three algorithms *rec-split*, *rec-split-improved*, and *hierarchy sort*. The boxplots show medians, first and third quartiles, minimum and maximum values. Arithmetic means are indicated by crosses.

worse and spread a lot more for all three algorithms, but still *rec-split-improved* had the best performance with the upper quartile of the ratios mostly below 3. On the other hand the upper quartile of *hierarchy sort* reached values mostly above 20 and up to 85 for $n = 100$. Algorithm *rec-split* reached performance ratios between those of the other two algorithms. For $n \geq 90$ we stopped considering *rec-split* since its computation times became again too high.

The relative performance of the algorithms for random non-complete trees was confirmed by the results for the sets E–G of real-world examples, see Fig. 6. For the clustering data of set E with an average of 33.5 crossings *rec-split-improved* reached an average performance ratio of 1.06, *rec-split* was slightly worse with 1.15, and *hierarchy sort* had an average ratio of 1.86. The phylogenetic data of sets F and G can often be drawn without crossings and thus have average crossing numbers of only 0.17 and 0.7, respectively. This explains the relatively high performance ratios. Still, *rec-split-improved* found an optimum layout for four of the six examples in set F and solved all ten instances in set G optimally.

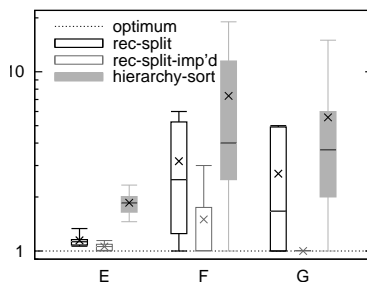

Fig. 6: Performance ratios for real-world examples.

4.3 Running Time

Although the number of crossings is the main aspect to assess the quality of TL algorithms, their running time is also important—especially if the layouts are to be produced interactively. Figure 7 shows plots of the running times of *rec-split*, *rec-split-improved*, *rec-split-bb* (the branch-and-bound implementation of *rec-split-improved*), *hierarchy sort*, and the IQP for all four classes of random tanglegrams. Note the use of log scales. Recall that *hierarchy sort* was written in Delphi instead of Java and executed on a different system. Hence the absolute running times of *hierarchy sort* are to be taken with a grain of salt.

By far the fastest algorithm in all our examples was *hierarchy sort*, which took at most 12 ms for complete trees and less than 90 ms for arbitrary trees. No difference in terms of the running time could be seen between random pairs and mutated pairs of trees. In contrast, the measured running times of the branch-and-bound algorithm *rec-split-bb* were about ten times higher for complete trees and between four and six times higher for general trees. Still, the median running time of *rec-split-bb* was less than 360 ms for all instances. In the direct comparison of random (C) and mutated (D) pairs of non-complete trees with the same number of leaves, the random pairs, which have a much larger crossing number, required between 50 and 100% more computation time.

The naive recursive implementations of *rec-split* and *rec-split-improved* were far slower than *hierarchy sort* and *rec-split-bb*. For complete binary trees they both grow at a cubic rate in n , but *rec-split-improved* is about three times faster than *rec-split*. This is due to the additional $O(n^2h)$ -time preprocessing step mentioned in Section 3.1. Both algorithms are not influenced by the class of the complete trees

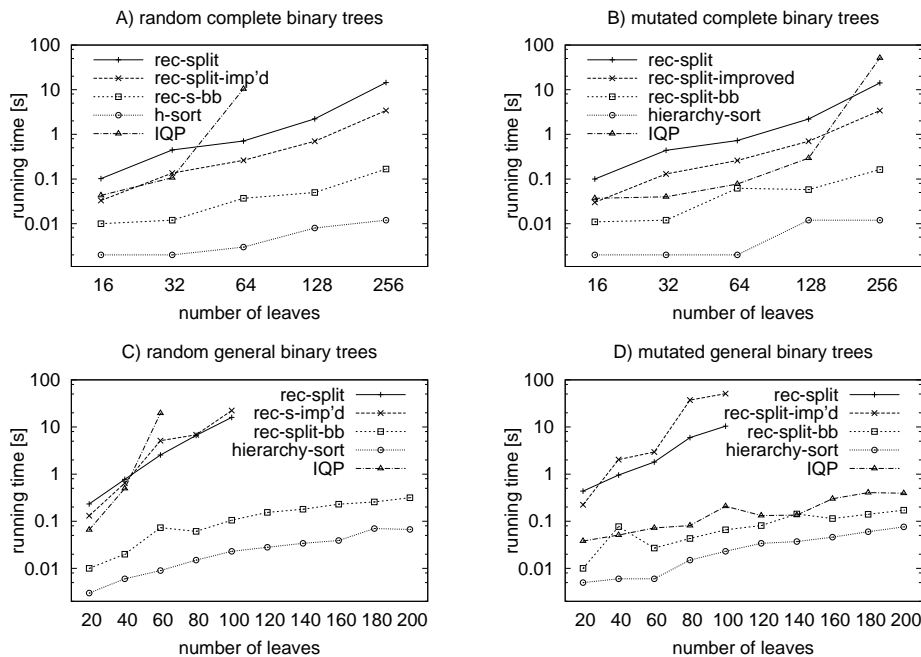

Fig. 7: Median running times of the algorithms *rec-split*, *rec-split-improved*, *rec-split-bb*, *hierarchy sort*, and IQP (in seconds). Note the use of log scales.

(A or B) as to be expected from their definitions. For general binary trees their running times quickly grew up to several hours, at least for some of the instances, which is due to the fact that the running time is exponential in the tree height. Thus complete trees with 256 leaves could be solved as fast as some random trees with only 50 leaves. The better performance in terms of crossings of *rec-split-improved* for unbalanced trees is paid for by higher running times in comparison to *rec-split*.

Interestingly, layouts for pairs of mutated and thus rather similar trees took much more time to compute than layouts for two random trees. One explanation is that for a subinstance $\langle S', T' \rangle$ the smaller of the heights of S' and T' determines the recursion depth. Thus for two similar trees with similar heights the recursion depth will be larger on average than for two random trees with fairly different heights. It is also noteworthy that the running time of *rec-split-bb* in our experiments was dominated by the above mentioned $O(n^2h)$ -time preprocessing step, which unlike the recursive algorithms does not depend exponentially on the height.

Finally, we look at the running times of the IQP. In contrast to the recursive algorithms the running time of the IQP is independent of the height (and thus the completeness) of the trees. Rather it is the value of the objective function, that is, the crossing number, that influences the solution time. Therefore all mutated trees, which have relatively small crossing numbers, could be solved optimally within the time limits of ten minutes. On the other hand for random tanglegrams optimality could only be proven for $n \leq 64$. For larger instances a slowly increasing gap between the best found integer solution and the fractional solution remained, see Fig. 8 (top).

5 Conclusions

The experimental evaluation shows that in terms of crossing reduction our improvement of the recursive splitting algorithm of Buchin et al. [2] clearly has the best performance for all instances that were included in the tests. Moreover, our branch-and-bound implementation is fast enough (less than 0.4 seconds for trees with 200 leaves each) to be used interactively. Thus it is the method of choice for drawing binary tanglegrams with up to a few hundred leaves. Still, in terms of running time the hierarchy sorting heuristic of Holten and van Wijk [8] outperforms the recursive splitting algorithm; it can thus also be used for very large trees if the number of crossings is not the main optimization criterion. Also, it is currently the only method that can draw non-binary tanglegrams. For medium-sized tanglegrams that consist of two similar trees and thus have a rather small crossing number it is worth to give it a try and solve the very simple integer quadratic program to obtain the optimal solution—often this takes but a few seconds.

References

1. P. Bertolazzi, G. Di Battista, C. Mannino, and R. Tamassia. Optimal upward planarity testing of single-source digraphs. *SIAM J. Comput.*, 27(1):132–169, 1998.
2. K. Buchin, M. Buchin, J. Byrka, M. Nöllenburg, Y. Okamoto, R. I. Silveira, and A. Wolff. Drawing binary tanglegrams: Hardness, approximation, fixed-parameter tractability. Available at <http://arxiv.org/abs/0806.0920>
3. T. Dwyer and F. Schreiber. Optimal leaf ordering for two and a half dimensional phylogenetic tree visualization. *Proc. Australasian Sympos. Inform. Visual. (In Vis. au'04)*, volume 35 of *CRPIT*, pages 109–115. Australian Computer Society, 2004.
4. P. Eades and N. Wormald. Edge crossings in drawings of bipartite graphs. *Algorithmica*, 10:379–403, 1994.
5. H. Fernau, M. Kaufmann, and M. Poths. Comparing trees via crossing minimization. In *Proc. 25th Intern. Conf. Found. Softw. Techn. Theoret. Comput. Sci. (FSTTCS'05)*, volume 3821 of *Lecture Notes Comput. Sci.*, pages 457–469, 2005.
6. R. Görke, M. Gaertler, and D. Wagner. LunarVis – Analytic Visualizations of Large Graphs. In *Proc. 15th Internat. Sympos. Graph Drawing (GD'07)*, volume 4875 of *Lecture Notes Comput. Sci.*, pages 352–364. Springer-Verlag, 2008.
7. M. S. Hafner, P. D. Sudman, F. X. Villablanca, T. A. Spradling, J. W. Demastes, and S. A. Nadler. Disparate rates of molecular evolution in cospeciating hosts and parasites. *Science*, 265:1087–1090, 1994.
8. D. Holten and J. J. van Wijk. Visual comparison of hierarchically organized data. In *Proc. 10th Eurographics/IEEE-VGTC Sympos. Visualization (EuroVis'08)*, pages 759–766, 2008.
9. M. Jünger and P. Mutzel. 2-layer straightline crossing minimization: Performance of exact and heuristic algorithms. *J. Graph Algorithms Appl.*, 1(1):1–25, 1997.
10. A. Lozano, R. Y. Pinter, O. Rokhlenko, G. Valiente, and M. Ziv-Ukelson. Seeded tree alignment and planar tanglegram layout. In *Proc. 7th Internat. Workshop Algorithms Bioinformatics (WABI'07)*, volume 4645 of *Lecture Notes Comput. Sci.*, pages 98–110. Springer-Verlag, 2007.
11. R. D. M. Page, editor. *Tangled Trees: Phylogeny, Cospeciation, and Coevolution*. University of Chicago Press, 2002.
12. K. Sugiyama, S. Tagawa, and M. Toda. Methods for visual understanding of hierarchical system structures. *IEEE Trans. Systems, Man, and Cybernetics*, 11(2):109–125, 1981.

Appendix

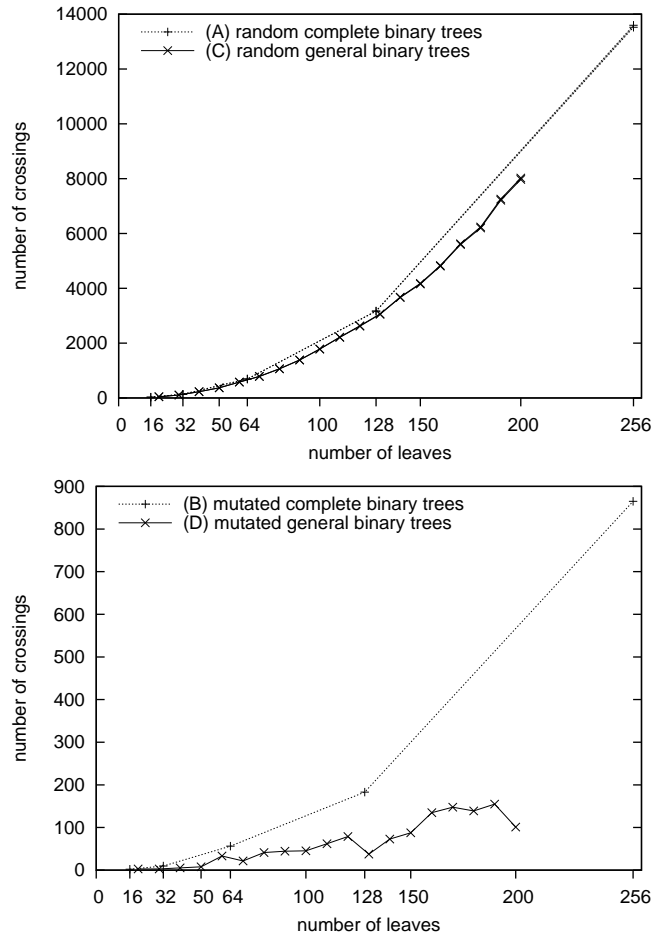

Fig. 8: Average crossing numbers of our randomly-generated instances. For random (non-mutated) trees in sets A and C (top) with $n \geq 70$ there is a remaining gap between the best found integer solution and the best fractional solution. Both values are plotted; however, the gap is relatively small (less than 70 for $n \leq 256$) and hardly visible.