

THE NON-TRIVIALITY OF THE GROPE FILTRATIONS OF THE KNOT AND LINK CONCORDANCE GROUPS

PETER D HORN

ABSTRACT. We consider the Grope filtration of the classical knot concordance group that was introduced in a paper of Cochran, Orr and Teichner. Our main result is that successive quotients at each stage in this filtration have infinite rank. We also establish the analogous result for the Grope filtration of the concordance group of string links consisting of more than one component.

1. INTRODUCTION

We work in the smooth category. A knot is a smooth embedding of the circle in the three-sphere. Two knots are isotopic if there is a smooth isotopy of the three-sphere taking one knot to the other. Isotopy is a three-dimensional notion of knot equivalence. In this paper, we study a four-dimensional notion of knot equivalence called *concordance*. Two knots K_0 and K_1 are concordant if there exists a smooth embedding of an annulus $A = S^1 \times [0, 1]$ into $S^3 \times [0, 1]$ such that $A \cap (S^3 \times \{i\}) = K_i$ for $i = 0, 1$. One can check that isotopic knots are concordant, and one can find counterexamples to the converse. Given two knots, one can combine them via the connect sum operation, denoted $\#$. See [Rol76, p 39] for more details. The set of knots modulo concordance, equipped with the connect sum operation, forms an abelian group. We wish to study this *concordance group* \mathcal{C} .

In [COT03], Cochran, Orr, and Teichner introduced two filtrations of the knot concordance group by subgroups. The (n) -solvable filtration

$$\cdots \subset \mathcal{F}_{n.5} \subset \mathcal{F}_n \subset \cdots \subset \mathcal{F}_1 \subset \mathcal{F}_{0.5} \subset \mathcal{F}_0 \subset \mathcal{C}$$

is defined loosely by $K \in \mathcal{F}_n$ if 0-surgery on K bounds a 4-manifold whose first and second homology groups satisfy certain conditions related to the n -th derived subgroup of that 4-manifold. The precise definition will be provided in Section 2. It is true that a slice knot lies in \mathcal{F}_n for all $n \in \frac{1}{2}\mathbb{N}$. In other words, this filtration measures how far *algebraically* a knot is from being slice (take, for example, the highest n for which $K \in \mathcal{F}_n$ but $K \notin \mathcal{F}_{n.5}$).

The other filtration defined in [COT03] is the Grope filtration

$$\cdots \subset \mathcal{G}_{n.5} \subset \mathcal{G}_n \subset \cdots \subset \mathcal{G}_3 \subset \mathcal{G}_{2.5} \subset \mathcal{G}_2 \subset \mathcal{G}_{1.5} \subset \mathcal{C}$$

which is defined by $K \in \mathcal{G}_n$ if K bounds a Grope of height n in D^4 . A Grope is a 2-complex that will be defined in Section 2. As in the (n) -solvable filtration, a slice knot lies in \mathcal{G}_n for all n , and so the highest n for which $K \in \mathcal{G}_n$ but $K \notin \mathcal{G}_{n.5}$ is some measure on how far *geometrically* K is from being slice.

The non-triviality of the (n) -solvable filtration has been a topic of study since its introduction. That $\mathcal{F}_n/\mathcal{F}_{n.5}$ has infinite rank was proved by Jiang in [Jia81] for $n = 1$, by Cochran, Orr and Teichner in [COT04, Theorem 4.1] for $n = 2$, and by Cochran, Harvey and Leidy in [CHL07, Theorem 8.1] for all n . Our main result is an analogous statement for the Grope filtration.

Theorem 4.2. *For every $n \geq 2$, $\mathcal{G}_n/\mathcal{G}_{n.5}$ has infinite rank.*

Our main result improves upon previous results regarding the non-triviality of the Grope filtration. For example, Cochran and Teichner proved in [CT07, Theorem 1.4] the existence of knots of infinite order in $\mathcal{G}_n/\mathcal{G}_{n.5}$. Our method of constructing knots bounding Gropes is similar to that of Cochran and Teichner. Since $\mathcal{G}_{n+2} \subset \mathcal{F}_n$ [COT03, Theorem 8.11], we are able to adapt Cochran, Harvey and Leidy's

technique [CHL07] to prove that no non-trivial linear combination of these knots lies in $\mathcal{F}_{n.5}$, hence not in $\mathcal{G}_{n+2.5}$.

Remark 1. We construct knots that bound smooth embeddings of gropes in D^4 . We state our main result so that is easy to read, but as stated, it is not the strongest possible assertion. The result of Cochran, Harvey and Leidy implies that no non-trivial linear combination of these knots is even topologically $(n.5)$ -solvable, hence does not bound even a topologically flat embedding of a height $n.5$ grope in D^4 .

For the Grope filtration of the group of m -component string links with $m > 1$, Harvey showed in [Har08, Theorem 6.13] that for all n , $\mathcal{G}_n^m/\mathcal{G}_{n+2}^m$ contains an infinitely generated subgroup. Let \mathcal{BG}_n^m denote the subgroup of \mathcal{G}_n^m whose elements are boundary links. Combining [Har08, Theorem 6.13] and [CH08, Theorem 4.4], it is known that for each $m > 1$ and $n \geq 2$, the abelianization of $\mathcal{BG}_n^m/\mathcal{BG}_{n+1.5}^m$ has infinite rank. We improve the result by narrowing the index gap.

Theorem 5.2. *For each $m > 1$ and $n \geq 2$, the abelianization of $\mathcal{BG}_n^m/\mathcal{BG}_{n.5}^m$ has infinite rank; hence $\mathcal{G}_n^m/\mathcal{G}_{n.5}^m$ contains an infinitely generated subgroup.*

2. DEFINITIONS

If G is a group, the **derived series of G** is defined recursively by $G^{(0)} = G$ and $G^{(i+1)} = [G^{(i)}, G^{(i)}]$.

Let M be closed, connected, orientable 3-manifold. Recall from [COT03] the definition of an (n) -solution for M .

Definition 2.1. A smooth, spin 4-manifold W with $\partial W = M$ is an (n) -**solution** for M if the inclusion-induced map $i_* : H_1(M) \rightarrow H_1(W)$ is an isomorphism and if there are embedded surfaces L_i and D_i (with product neighborhoods) for $i = 1, \dots, m$ that satisfy the following conditions:

- (1) the homology classes $\{[L_1], [D_1], \dots, [L_m], [D_m]\}$ form an ordered basis for $H_2(W)$,
- (2) the intersection form $(H_2(W), \cdot)$ with respect to this ordered basis is a direct sum of hyperbolics,
- (3) $L_i \cap D_j$ is empty if $i \neq j$,
- (4) for each i , L_i and D_i intersect transversely at a point, and
- (5) each L_i and D_i are (n) -**surfaces**, i.e. $\pi_1(L_i) \subset \pi_1(W)^{(n)}$ and $\pi_1(D_i) \subset \pi_1(W)^{(n)}$.

If, in addition, $\pi_1(L_i) \subset \pi_1(W)^{(n+1)}$ for each i , we say W is an $(n.5)$ -**solution** for M .

There is a slight generalization of n -solvability, called **rational n -solvability**. For the purposes of this paper, it suffices to know that an n -solution is also a rational n -solution. If the above conditions hold except for the isomorphism on first homology, W is called an (n) -**bordism** for M .

If a closed, orientable 3-manifold bounds an (n) -solution, we say M is (n) -**solvable**. A knot K in S^3 is said to be an (n) -**solvable knot** if 0-surgery on K is (n) -solvable.

As in [COT03], the set of all (n) -solvable knots is denoted \mathcal{F}_n , where it was shown that these \mathcal{F}_n filter the topological knot concordance group \mathcal{C} , i.e. the \mathcal{F}_n form a nested series of subgroups of \mathcal{C} :

$$\{0\} \subset \dots \subset \mathcal{F}_{n.5} \subset \mathcal{F}_n \subset \dots \subset \mathcal{F}_{1.5} \subset \mathcal{F}_1 \subset \mathcal{F}_{0.5} \subset \mathcal{F}_0 \subset \mathcal{C}$$

The following definition is modified from the definition in [FT95]:

Definition 2.2. A **grope** is a special pair (2-complex, base circle). A grope has a **height** $n \in \frac{1}{2}\mathbb{N}$. A grope of height 1 is precisely a compact, oriented surface Σ with a single boundary component (the base circle). For $n \in \mathbb{N}$, a grope of height $n+1$ is defined recursively as follows: let $\{\alpha_i, \beta_i : i = 1, \dots, 2(g-1)\}$ be a symplectic basis of curves for Σ , the first stage of the grope. Then a grope of height $n+1$ is formed by attaching gropes of height n to each α_i and β_i along the base circles.

A grope of height 1.5 is formed by attaching gropes of height 1 (i.e. surfaces) to a Lagrangian of a symplectic basis of curves for Σ . That is, a grope of height 1.5 is a surface with surfaces glued to ‘half’ of the basis curves (i.e. the α_i). In general, a grope of height $n+1.5$ is obtained by attaching gropes of height n to the α_i and gropes of height $n+1$ to the β_i .

Given a 4-manifold W with boundary M and a framed circle $\gamma \subset M$, we say that γ bounds a **Grope** (note the capital ‘G’) in W if γ extends to a smooth embedding of a grope with its untwisted framing. That is, parallel push-offs of Gropes can be taken in W . Knots in S^3 are always equipped with the zero framing.

Cochran, Orr, and Teichner [COT03] also defined the Grope filtration of \mathcal{C} . The set of all knots that bound Gropes of height n in D^4 is denoted \mathcal{G}_n , which is a subgroup of \mathcal{C} . Observe the following connection between gropes and the derived series: if a curve ℓ bounds a (map of a) grope of height n in a space X , then $[\ell] \in \pi_1(X)^{(n)}$. It was shown in [COT03, Theorem 8.11] that $\mathcal{G}_{n+2} \subset \mathcal{F}_n$ (for all $n \in \frac{1}{2}\mathbb{N}$).

We will also use a few definitions from [CT07].

Definition 2.3. An **annular grope of height n** is a grope of height n that has an extra boundary component on its first stage. We say that the two boundary components of an annular grope cobound an annular grope. Two knots K_0 and K_1 are **height n Grope concordant** if they cobound a height n annular Grope G in $S^3 \times [0, 1]$ such that $G \cap (S^3 \times \{i\}) = K_i$ for $i = 0, 1$. For example, if K is height n Grope concordant to a slice knot, then $K \in \mathcal{G}_n$. The capital ‘G’ in ‘annular Grope’ indicates the untwisted framing.

Let G be a height n Grope in $S^3 \times [0, 1]$ bounded by a knot $K \subset S^3 \times \{0\}$. The union of sets of basis curves for each n -th stage surface of G is called a **set of tips** for G . If the tips lie on annuli in $S^3 \times [0, 1]$ that are disjoint from each other and disjoint from the Grope (except at the tips) and the other boundary components of the annuli lie in $S^3 \times \{1\}$, we say ‘the tips are isotopic’ to the the link determined by the other boundary components of these annuli (a link in $S^3 \times \{1\}$).

A **capped Grope** is the union of a Grope and a disjoint union of discs where the boundaries of the discs form a full set of tips of the Grope. The interiors of these discs must not intersect the Grope except perhaps on one of the boundary components of the Grope’s first stage. These discs are called the ‘caps’ of the Grope. For example, if K bounds a Grope, the caps are allowed to hit K .

The construction of our examples relies on a technique known as *infection*. Let R be a fixed knot or link and K be a fixed knot in S^3 . Suppose α is a simple closed curve in $S^3 - R$ such that α is itself the unknot. Some number m of strands of R pierce the disc bounded by α . Let $R(\alpha, K)$ denote the knot obtained by replacing the m trivial strands of R by m strands ‘tied into the knot K .’ See Figure 1. More precisely, one obtains $R(\alpha, K)$ by removing a regular neighborhood of α and gluing in $S^3 - K$ in such a way that identifies the meridian of α with the longitude of K and the longitude of α with the meridian of K . We say $R(\alpha, K)$ is the result of infecting R by K along α .

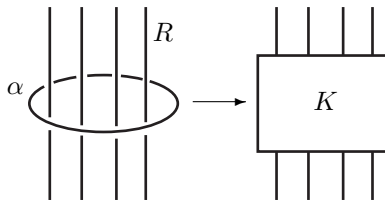

FIGURE 1. Infecting R by K along α

Let (H, J) denote the zero-framed, ordered Hopf link in the complement of a knot or link R in Figure 2. Surgery on (H, J) is homeomorphic to S^3 [Kir78, §4, Proposition 2], so the image of R after performing this Hopf surgery is a new knot or link in S^3 . By sliding the strands of R (that pass through J) over H and cancelling the Hopf pair, one sees the effect of Hopf surgery in Figure 2. We will use the terminology ‘performing the handle cancellation $J - H$ ’ to mean ‘performing (H, J) Hopf surgery.’ This convention matches [CT07, p 350].

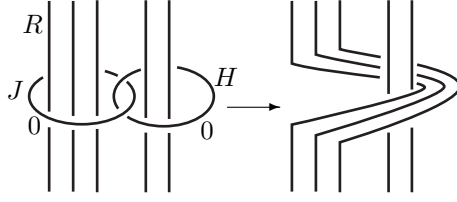
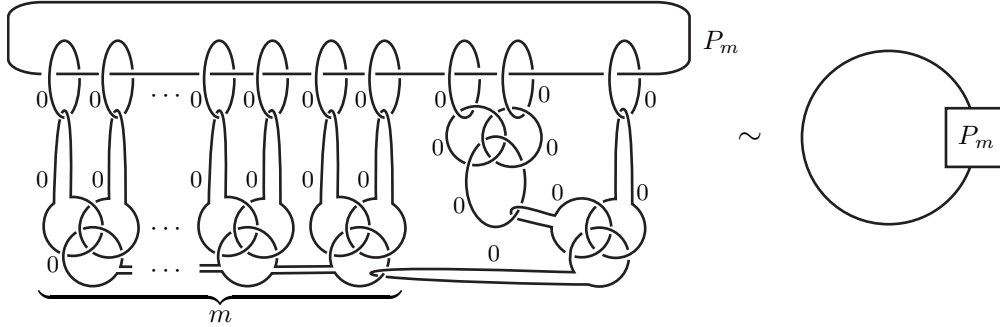

FIGURE 2. The effect of a Hopf surgery

3. KNOTS BOUNDING GROPE OF HEIGHT $n + 2$

Fix an $m \geq 1$. For each $n \geq 1$, we will construct a knot K_m^n by infecting a seed knot R along certain curves in $\pi_1(S^3 - R)^{(1)}$ by a knot K_m^{n-1} . Roughly speaking, we construct a height $n + 2$ Grope bounded by K_m^n in two stages. First we prove each K_m^{n-1} bounds a height $n + 1$ Grope whose tips are isotopic to meridians of K_m^{n-1} . When we infect R by K_m^{n-1} , we will see that the tips of this Grope are isotopic to the infection curves, which we will then prove bound capped Gropes of height 1. Gluing these height 1 capped Gropes onto the tips of the height $n + 1$ Gropes for K_m^{n-1} (and gluing a few annuli and slice discs) will result in a height $n + 2$ Grope bounded by K_m^n .

3.1. The infecting knots P_m . Let P_m be the knot defined in Figure 3. A priori, we have described P_m as a knot in some closed, oriented 3-manifold that is the image of U after performing 0-surgery on the $(10 + 4m)$ -component link in Figure 3. Using Kirby's calculus of framed links (see, for example, [GS99, Chapter 5]), one can check that this 3-manifold is S^3 .

FIGURE 3. A surgery description of P_m

Proposition 3.1. *Each P_m cobounds with the unknot a height 2 annular Grope in $S^3 \times [0, 1]$ whose tips are isotopic to a set of disjoint copies of meridians of P_m .*

Proof. We claim that Figure 5 depicts a height 2 annular grope in S^3 between P_m and U . Let L denote the $(10 + 4m)$ -component link $L = (H_0, \dots, H_{9+4m})$ in Figure 4; the link L is isotopic to the link defining P_m in Figure 3. In Figure 4, we have shaded in some punctured surfaces bounded by the components H_0, H_4 , and H_9 . Once we perform 0-surgery on L , these punctured surfaces will become closed surfaces, and these surfaces will be used to construct a height 2 Grope.

We perform $2m + 2$ handle cancellations,

$$H_7 - H_5, \quad H_8 - H_6, \quad H_{12} - H_{10}, \quad H_{13} - H_{11}, \quad \dots, \quad H_{8+4m} - H_{6+4m}, \quad H_{9+4m} - H_{7+4m},$$

to arrive at Figure 5 (ignore the U and shaded parts for now). What remains is a 6-component link $N = (H_0, H_1, H_2, H_3, H_4, H_9)$. Let N' denote the link $N - \{H_0, H_1\}$; N' consists of two separated Hopf links, thus 0-surgery on N' (denoted $S_{N'}^3$) is homeomorphic to S^3 . Let U be the knot in Figure 5 that

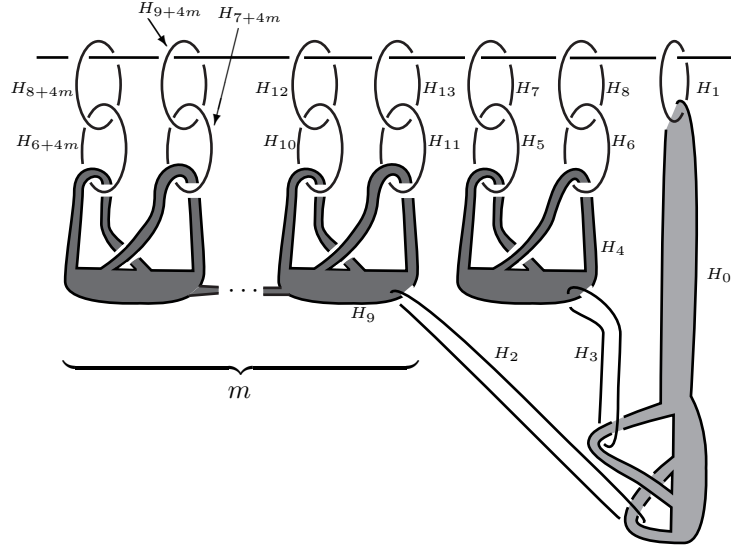
 FIGURE 4. The link L

deviates only slightly from P_m . The resulting knot U' after 0-surgery on N' is the unknot in $S^3 \cong S^3_{N'}$, since U does not hit the discs bounded by H_1 , H_2 and H_3 .

There is a punctured annulus in S^3 bounded by U and P_m ; the lightest shade of grey in Figure 5 is *part* of this annulus. The other part of this annulus has been collapsed to simplify the diagram. To the puncture, glue one boundary component of a tube. Push this annulus over H_1 , and glue the other boundary component to the circle where H_1 punctures the torus on which H_0 lies (second darkest shade of grey in Figure 5). So far we have a height 1 (and genus 1) annular grope between P_m and the unknot in S^3 .

One may take the obvious symplectic basis elements for the aforementioned torus, tube them over H_2 and H_3 and attach them to puncture the surfaces for H_4 and H_9 (the darkest shade of grey in Figure 5). Recall that after zero surgery on the link, H_4 and H_9 lie on closed surfaces. Now we have a height 2 annular grope in S^3 between P_m and the unknot. Figure 5 shows that the tips of this annular grope are isotopic to meridians of P_m .

One can push the U boundary of component of this annular grope in the positive I direction and the P_m boundary component in the negative I direction to arrive at the desired result. \square

3.2. The seed knot R and the infection curves. Our examples are inspired by Cochran, Harvey and Leidy's family J_n . They construct their family inductively by infecting the 9_{46} knot along the curves α and β in Figure 6. Note that the obvious tori in $S^3 - 9_{46}$ bounded by α and β intersect. For our construction of the Gropes for K_m^n , it is necessary that our infection curves bound disjoint surfaces in the complement of 9_{46} . We homotope α and β to arrive at different infection curves α' and β' .

Let $R = 9_{46}$. By Figure 7, the curves α' and β' bound tori that are disjoint and that miss R . The torus bounded by α' has a symplectic basis x_1, x_2 (the curve x_2 has been isotoped off of the torus) of curves that inherit the zero framing from the torus. The torus bounded by β' has a similar symplectic basis y_1, y_2 . It is clear from Figure 7 that the curves x_1, x_2, y_1, y_2 bound disjoint discs that hit the knot R transversely. Thus, α' and β' bound disjoint capped tori in the complement of R .

3.3. Knots bounding Gropes of height $n+2$. We now describe our family of knots K_m^n for $n, m \geq 1$ with the property that $K_m^n \in \mathcal{G}_{n+2}$. Recall $R = 9_{46}$, and α' and β' be from Figure 6. The curves α' and β' bound punctured tori that are disjointly embedded in $S^3 - R$. Let K_m^1 denote R infected along α'

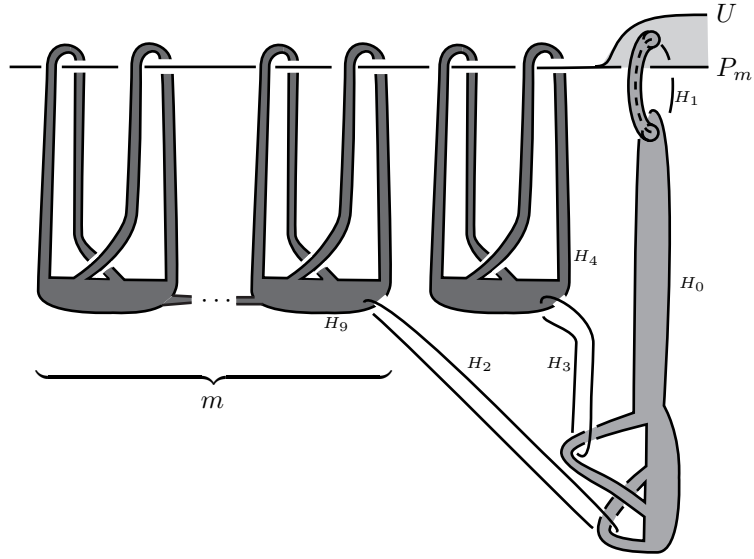

FIGURE 5. A height 2 Grope concordance from the unknot U to P_m

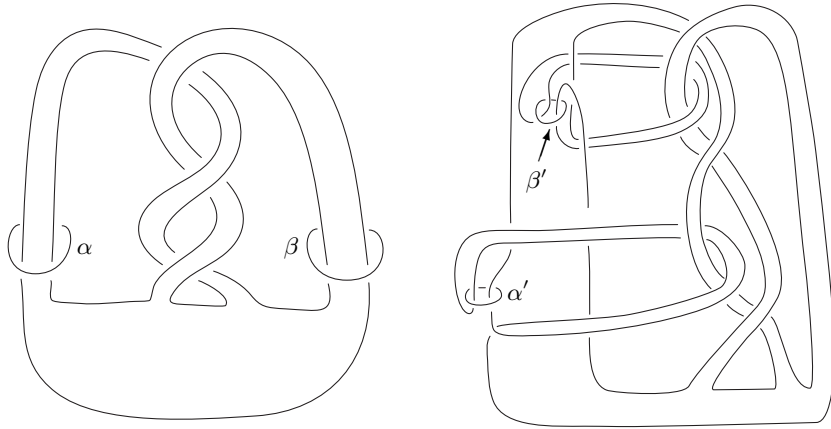

FIGURE 6. The infection curves α and β , and homotopic infection curves α' and β'

and β' by our knot P_m . Define K_m^{n+1} by infecting R along α' and β' by K_m^n . Observe that $g(K_m^n) \leq 3$ since α' and β' miss a genus three Seifert surface for R .

Proposition 3.2. *Let R be a knot in S^3 , α an unknotted curve in $S^3 - R$. If K and J are knots that are height n Grope concordant, then the results of infection $R(\alpha, K)$ and $R(\alpha, J)$ are height n Grope concordant.*

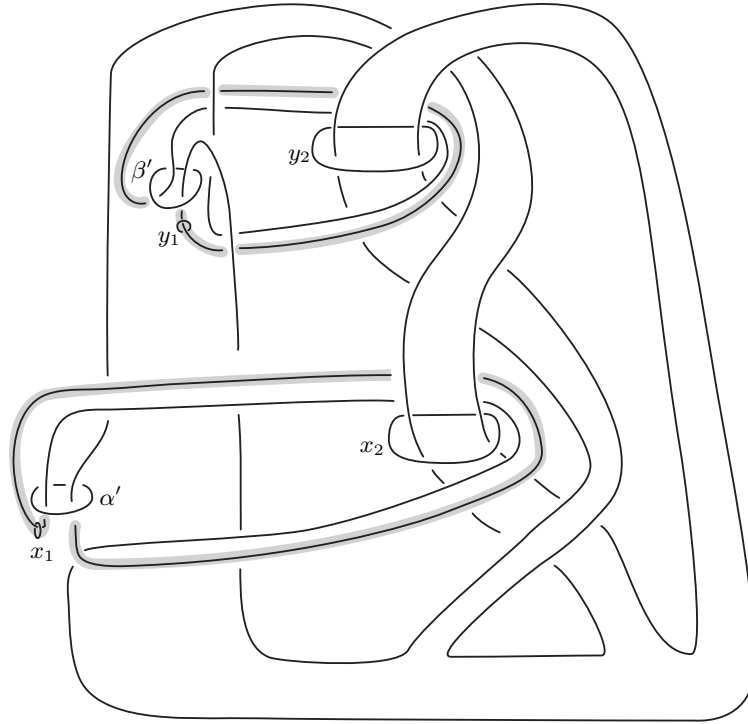
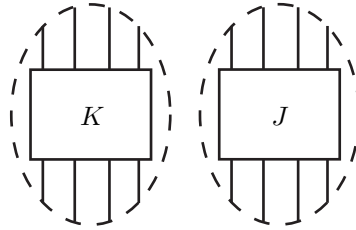

FIGURE 7. Infection curves bound disjoint capped tori

Sketch of Proof. The knots $R(\alpha, K)$ and $R(\alpha, J)$ differ by what happens inside a fixed ball D^3 :



Let (D^3, mK) denote the left-hand side of this diagram, i.e. a 3-ball with m arcs tied into K . Since K and J are height n Grope concordant, so are (D^3, mK) and (D^3, mJ) . We see this by slitting a height n Grope concordance from K to J , which turns it into a ‘height n slit Grope concordance’ from one knotted arc to another. Taking parallel copies of this slit Grope concordance in $D^3 \times [0, 1]$ yields G , the ‘height n slit Grope concordance’ in $D^3 \times [0, 1]$ from $(D^3, mK) \times \{0\}$ to $(D^3, mJ) \times \{1\}$. We simply glue this G to $(R - (R \cap D^3)) \times [0, 1]$ to arrive at a height n Grope concordance from $R(\alpha, K)$ to $R(\alpha, J)$. \square

Proposition 3.3. *Let $R = 9_{46}$ and K_m^1 be defined as above. Then K_m^1 is height 3 capped Grope concordant to R .*

Proof. For simplicity, let $K = K_m^1$. K is R infected along α' and β' by P_m . We will first concentrate on the infection along the α' curve. Let K' denote R infected along α' by P_m . We will infect along β' later, arriving at K . Consider a diagram for the link R, α' . The knot K' can be described by replacing

the infection curve with the framed $(10 + 4m)$ -component link that defines P_m . Figure 8 depicts this operation.

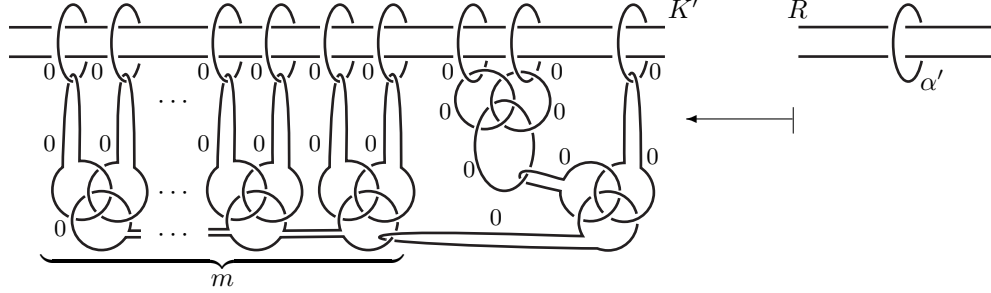

FIGURE 8. The knot K as infection on R

One may form a new knot L by pulling the 2 strands of K' out of the upper-right-most 0-framed curve in Figure 8. This is an ‘2-stranded analogue’ of what is done in Figure 5. As in Proposition 3.1, there is a punctured annulus in S^3 between K' and L (it is punctured twice). These punctures are 2 parallel copies of a meridian of the 0-framed curve through which we pulled the 2 strands of K' . Float these punctures downward in the I direction so that each puncture is in a different $S^3 \times \{*\}$ level. To each puncture, one can glue the height 2 Grope for P_m described in Proposition 3.1. As before, the tips of the Grope in the $S^3 \times \{*\}$ level are isotopic to parallel copies of the infection curve $\alpha' \times \{*\}$. Now, we may float each of these $\alpha' \times \{*\}$ disjointly down to the $S^3 \times \{1\}$ level. Since each of the pieces of the Grope (and the tips) miss K' and L , we may glue $L \times [0, 1]$ to this Grope. The result is a height 2 Grope concordance from $K' \times \{0\}$ to $L \times \{1\}$ whose tips are disjointly isotopic to parallel copies of $\alpha' \times \{1\}$.

We claim that L is in fact R . The proof of this fact is similar to the proof that the U from Figure 5 and Proposition 3.1 is the unknot. Namely, we have expressed L as surgery on separated Hopf links, and for each of these Hopf pairs, L does not pass through one of the components. Thus, performing the surgery does not change L locally, and away from the surgery link, L is identically R .

At this point we have proven $K' = R(\alpha', P_m)$ is height 2 Grope concordant to R , and the tips of this Grope concordance (which we name G) are isotopic to parallel copies of α' . We can view K as $K'(\beta', P_m)$. An argument similar to the one above yields a height 2 Grope concordance (which we name H) between K and K' whose tips are isotopic to parallel copies of β' . We can glue $H \subset S^3 \times [0, 1]$ to $G \subset S^3 \times [1, 2]$ and float the tips of H down through $S^3 \times [1, 2]$ so that they miss G . In order to justify this, we recall from the proof of Proposition 3.2 that G was constructed by gluing pieces of $R \times I$ (which miss β') to something that lived in $D^3 \times I$, where $\alpha' \subset D^3$ and β' was contained in $S^3 - D^3$. Thus, $G \cap (\beta' \times [1, 2]) = \emptyset$. We see that $J := G \cup H \cup (\beta' \times [1, 2]) \sqcup \dots \sqcup \beta' \times [1, 2]$ is a height 2 Grope concordance between K_m^1 and R with punctured caps, and these punctures are parallel copies of β' union parallel copies of α' such that the punctures lie in $(S^3 - R) \times \{2\}$. The result is a height 2 Grope concordance between $K = K_m^1$ and R whose tips are the union of parallel copies of α' and parallel copies of β' . A schematic of J is depicted in Figure 9, with $n = 0$. Pushing further down into $S^3 \times [2, 3]$, we can glue parallel copies of the capped tori to the copies α' and β' . The reader will recall that these capped tori miss R . Since we attached a capped torus to each tip of J , we are left with a height 3 capped Grope concordance between K_m^1 and R , as desired. \square

Theorem 3.4. *For each $n, m \geq 1$, K_m^n is height $n+2$ capped Grope concordant to $R = 9_{46}$. In particular, K_m^n bounds a Grope of height $n+2$ in D^4 .*

Proof. We induct on n . The claim is true in the case $n = 1$ by Proposition 3.3. Assume that the claim is true for K_m^n .

By definition K_m^{n+1} is R infected along α' and β' by K_m^n . As in the proof of Proposition 3.3, we first concentrate on the infection along α' . Let $K' = R(\alpha', K_m^n)$. By the inductive hypothesis on K_m^n and by Proposition 3.2, K' and $R = R(\alpha, \text{unknot})$ are height $n+2$ Grope concordant. This Grope concordance is built using the height $n+2$ capped Grope concordance L between K_m^n and R . Each cap of L hits R transversely, and removing neighborhoods of the intersection points from the cap yields a planar surface with boundary equal to a tip of L and copies of the meridian of R . The meridians of R can float along L to be meridians of K_m^n . Under the infection of R along α' by K_m^n , the meridian of K_m^n is identified with (the longitude of a regular neighborhood of) α' . Let G denote the union of L and these planar surfaces reaching out from the tips. By the ‘punctures of G ,’ we mean the punctures of these punctured caps, each of which is a copy of α' .

As for the infection along β' , between $K_m^{n+1} = K'(\beta', K_m^n)$ and K' there is a height $n+2$ Grope concordance H with punctured caps whose punctures are copies of β' . Since infecting along β' is a local operation near β' , H misses $\alpha' \times [0, 1]$.

We now describe the height $n+3$ capped Grope concordance between K_m^{n+1} and R . Figure 9 shows a schematic of the ultimate Grope. We start with the height $n+2$ Grope concordance H between K_m^{n+1} and K' . Imagine that H is embedded in $S^3 \times [0, 1]$ so that $H \cap S^3 \times \{0\} = K_m^{n+1}$ and $H \cap S^3 \times \{1\} = K'$. The punctures of H are parallel copies of β' in $S^3 \times \{1\}$. Now imagine that G , which is the Grope concordance between K' and R , is imbedded in $S^3 \times [1, 2]$ so that $G \cap S^3 \times \{1\} = K'$ and $G \cap S^3 \times \{2\} = R$. The punctures of G are parallel copies of α' in $S^3 \times \{2\}$. We claim that we can ‘float down the punctures of H ’ into the $S^3 \times \{2\}$ level *while missing* G . A justification of this was given in the proof of Proposition 3.3. We see that $J := G \cup H \cup (\beta' \times [1, 2] \sqcup \cdots \sqcup \beta' \times [1, 2])$ is a height $n+2$ Grope concordance between K_m^{n+1} and R with punctured caps, and these punctures are parallel copies of β' union parallel copies of α' such that the punctures lie in $(S^3 - R) \times \{2\}$.

Since α' and β' bound disjoint capped torus in $S^3 - R$, we can glue parallel copies of the capped torus (in $S^3 \times [2, 3]$) to J along the punctures of J . To summarize, we have attached capped surfaces to each tip in the height $n+2$ Grope concordance J . What we have is a height $n+3$ capped Grope concordance between K_m^{n+1} and R . We have proven the inductive step, and the claim is true for all n .

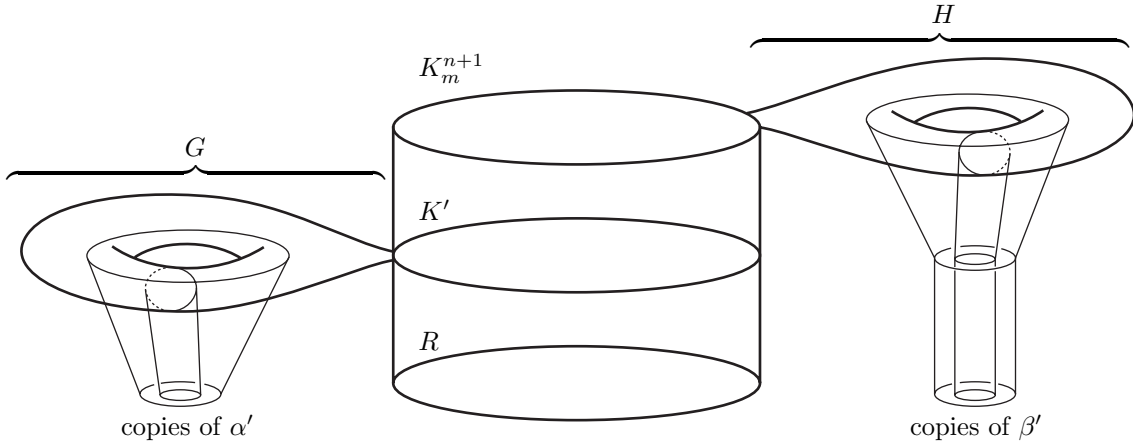

FIGURE 9. A schematic of the height $n+2$ Grope concordance, J , from K_m^{n+1} to R

□

4. ALGEBRAIC INVARIANTS

We outline a proof that K_m^n (or a subsequence of similar knots) are linearly independent in $\mathcal{G}_{n+2}/\mathcal{G}_{n+2.5}$. The following arguments are adapted from Cochran, Harvey and Leidy’s proof that $\mathcal{F}_n/\mathcal{F}_{n.5}$ has infinite rank (cf. [CHL07, Theorem 8.1]).

Definition 4.1. Let K be a knot in S^3 and $G = \pi_1(M_K)$. The real number $\rho^1(K)$ is the first-order $L^{(2)}$ -signature given by the Cheeger-Gromov invariant $\rho(M_K, \phi : G \rightarrow G/G^{(2)})$.

Theorem 4.2. For $n \geq 0$, $\mathcal{G}_{n+2}/\mathcal{G}_{n+2.5}$ has infinite rank.

We produce an infinite family of knots in \mathcal{G}_{n+2} whose members are linearly independent in $\mathcal{G}_{n+2}/\mathcal{G}_{n+2.5}$. This family is a subsequence of $\{K_m^n\}_{m=1}^\infty$, or possibly a subsequence of a related family (see the proof below for a discussion). To avoid unnecessary reproduction of previous results, we will give a brief outline of the proof and refer the reader to [CHL07, Theorem 8.1] for the details. We merely push through the proof given by Cochran, Harvey and Leidy in [CHL07], just to verify that their argument may be used to show that no non-trivial linear combination of the K_m^n lie in $\mathcal{F}_{n.5}$, hence not in $\mathcal{G}_{n+2.5}$.

Sketch of proof. First, we must find a genus one ribbon knot R with $\rho^1(R) \neq 0$. If $\rho^1(9_{46}) \neq 0$, we can set $R = 9_{46}$. Otherwise, we can tie one band of 9_{46} into the right-handed trefoil knot, as shown in Figure 10; the result, R , is a ribbon knot with $\rho^1(R) \neq 0$.

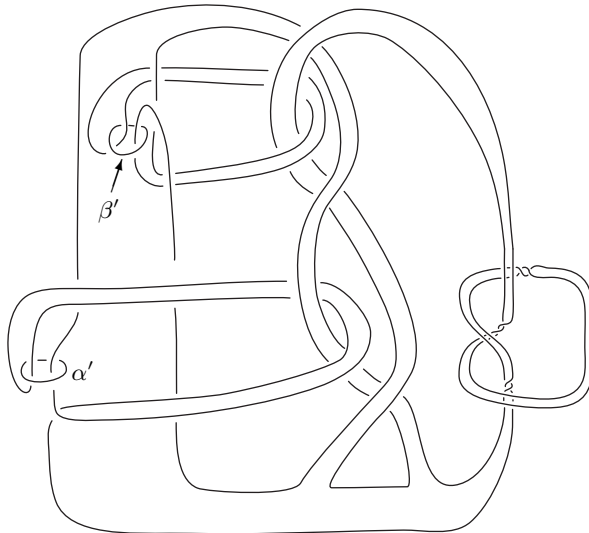

FIGURE 10. Tying one band of 9_{46} into a trefoil

Second, we must find an infinite set \mathcal{P} of knots P_m such that no non-trivial rational linear combination of $\{\rho_0(P_m)\}$ is a rational multiple of $\rho^1(R)$. These ρ_0 invariants are discussed in Lemma 6.2. Lemma 6.2 provides an infinite subset of the knots P_m defined in Section 3.1 that satisfy this property.

For each $n \geq 0$, we define a family of knots $\{K_m^n : m \geq 1\} \subset \mathcal{G}_{n+2}$. This family is defined as in Section 3.3, except using the knot R as the seed knot. It should be noted that (possibly) having tied a trefoil in one of the bands does not affect the conclusions of any of the results in Section 3. In particular, these K_m^n lie in \mathcal{G}_{n+2} .

Now we must prove that no non-trivial linear combination of the knots K_m^n is (even rationally) $(n.5)$ -solvable. Since $\mathcal{G}_{n+2.5} \subset \mathcal{F}_{n.5}$, it will follow that no such combination of these knots lies in $\mathcal{G}_{n+2.5}$, hence these knots are linearly independent in $\mathcal{G}_{n+2}/\mathcal{G}_{n+2.5}$. Suppose that a finite sum $\tilde{K} = \sum_{m=1}^\infty j_m K_m^n$ is rationally $(n.5)$ -solvable. We may assume that $j_1 \geq 0$. We construct a family of 4-manifolds W_i and reach a contradiction. Let us abbreviate $M_{K_m^n} = M_m^n$.

Consider W_n with boundary $M_1^0 \sqcup M_1^0 \sqcup M_R$. Recall that $M_1^0 = M_{K_1^0} = M_{P_1}$. Let $\pi = \pi_1(W_n)$ and consider $\phi : \pi \rightarrow \pi/\pi_r^{(n+1)}$. Then by property (3) of Proposition 4.3,

$$(1) \quad \rho(M_{P_1}, \phi_{\alpha'}) + \rho(M_{P_1}, \phi_{\beta'}) + \rho(M_R, \phi_R) = \rho(\partial W_n, \phi) = - \sum_m C_m \rho_0(P_m)$$

where $C_1 \geq 0$ and $\phi_R : \pi_1(M_R) \rightarrow \pi/\pi_r^{(n+1)}$ is induced by inclusion (and similarly for $\phi_{\alpha'}$ and $\phi_{\beta'}$). By property (2) of Proposition 4.3, $j_*(\pi_1(M_{P_1})) \subset \pi^{(n)}$, implying that the restrictions $\phi_{\alpha'}$ and $\phi_{\beta'}$ factor through the respective abelianizations. Additionally by property (2), at least one of these coefficient systems is non-trivial. Hence, by Proposition 4.3,

$$\rho(M_{P_1}, \phi_{\alpha'}) + \rho(M_{P_1}, \phi_{\beta'}) = \epsilon \rho_0(P_1)$$

where ϵ is equal to one or two. Thus we can simplify equation 1 to yield

$$(2) \quad (\epsilon + C_1) \rho_0(P_1) + \sum_{m>1} C_m \rho_0(P_m) = -\rho(M_R, \phi_R)$$

where $\epsilon + C_1 \geq 1$. Also by property (2) of Proposition 4.3,

$$j_*(\pi_1(M_R)) \subset \pi^{(n-1)}$$

so ϕ_R factors through $G/G^{(2)}$ where $G = \pi(M_R)$. Since $\ker(\phi_R) \subset G^{(1)}$, ϕ_R is determined by the kernel, denoted A , of the induced map

$$\overline{\phi_R} : G^{(1)}/G^{(2)} \rightarrow \text{im}(\phi_R)$$

A is a submodule of the Alexander module $G^{(1)}/G^{(2)}$. Since the Alexander polynomial of R is $(2t-1)(t-2)$, the product of two irreducible coprime factors, the Alexander module of R has only four submodules: the trivial submodule, A itself, and $\langle \alpha' \rangle$ and $\langle \beta' \rangle$. One can examine these four possibilities for A and conclude that $\rho(M_R, \phi_R) \in \{0, \rho^1(R)\}$. Combining this with equation 2, we have

$$(\epsilon + C_1) \rho_0(P_1) + \sum_{m>1} C_m \rho_0(P_m) = C_0 \rho^1(R)$$

where $C_0 \in \{0, 1\}$. Since $\epsilon + C_1 \geq 1$, we have written a multiple of $\rho^1(R)$ as a non-trivial linear combination of $\{\rho_0(P_m)\}$, a contradiction. \square

Proposition 4.3. (Proposition 8.2 of [CHL07]). *If \tilde{K} is rationally $(n, 5)$ -solvable, then for each $0 \leq i \leq n$, there is a 4-manifold W_i with the following properties. Let $\pi = \pi_1(W_i)$.*

- (1) W_i is a rational (n) -bordism where, for $i < n$, $\partial W_i = M_1^n$ and $\partial W_n = M_1^0 \sqcup M_1^0 \sqcup M_R$,
- (2) under the inclusion(s) $j : M_1^{n-i} \subset \partial W_i \rightarrow W_i$,

$$j_* : \pi_1(M_1^{n-i}) \subset \pi^{(i)},$$

and for each i (at least one of the copies of) $M_1^{n-i} \subset \partial W_i$,

$$j_* : (\pi_1(M_1^{n-i})) \cong \mathbb{Z} \subset \pi^{(i)}/\pi_r^{(i+1)}$$

and under the inclusion $j : M_R \subset \partial W_n \rightarrow W_n$,

$$j_* : (\pi_1(M_R)) \cong \mathbb{Z} \subset \pi^{(n-1)}/\pi_r^{(n)}$$

- (3) for any PTFA coefficient system $\phi : \pi_1(W_i) \rightarrow \Gamma$ with $\Gamma_r^{(n+1)} = 1$,

$$\rho(\partial W_i, \phi) = \sigma_{\Gamma}^{(2)}(W_i, \phi) - \sigma(W_i) = - \sum_m C_m \rho_0(P_m)$$

for some integers C_m (depending on ϕ) with $C_1 \geq 0$.

We refer the reader to [CHL07] for a proof of this proposition.

5. STRING LINKS

We follow the notation of [Har08]. Let $\mathcal{C}(m)$ denote the group of m -component string links modulo concordance (the group operation is concatenation). If $L \in \mathcal{C}(m)$, let \widehat{L} denote the closure of L ; \widehat{L} is obtained by attaching the m -component trivial link to the ends of L in the obvious way. Let \mathcal{G}_n^m denote the subset of $\mathcal{C}(m)$ defined by $L \in \mathcal{G}_n^m$ if the components of \widehat{L} bound disjoint Gropes of height n in D^4 . It can be shown that the Grope filtration of $\mathcal{C}(m)$

$$0 \subset \cdots \subset \mathcal{G}_{n.5}^m \subset \mathcal{G}_n^m \subset \cdots \subset \mathcal{G}_{1.5}^m \subset \mathcal{G}_1^m \subset \mathcal{C}(m)$$

is a filtration of $\mathcal{C}(m)$ by normal subgroups. If $\mathcal{B}(m)$ denotes the subgroup of $\mathcal{C}(m)$ consisting of boundary string links, we define $\mathcal{BG}_n^m = \mathcal{G}_n^m \cap \mathcal{B}(m)$.

There is also the (n) -solvable filtration of $\mathcal{C}(m)$, whose definition we omit, that is related to the Grope filtration by $\mathcal{G}_{n+2}^m \subset \mathcal{F}_n^m$ for all $n \in \frac{1}{2}\mathbb{N}$. Let $\mathcal{BF}_n^m = \mathcal{F}_n^m \cap \mathcal{B}(m)$.

Remark 2. For each $n \in \mathbb{Z}$, Harvey [Har08, Definition 3.11] defined a link invariant $\rho_n(L) \in \mathbb{R}$. The salient features of this ρ_n are listed below:

- (1) [Har08, Corollary 6.7] For each $n \geq 0$ and $m \geq 1$, $\rho_n : \mathcal{B}(m) \rightarrow \mathbb{R}$ is a homomorphism,
- (2) [CH08, Theorem 4.4] $\rho_n(L)$ vanishes for all $L \in \mathcal{BF}_{n.5}^m$.
- (3) [Har08, Theorem 5.8] If T is the identity element of $\mathcal{B}(m)$, η an unknotted circle in the complement of T that lies in $\pi_1(D^2 \times I - T)^{(n)} - \pi_1(D^2 \times I - T)^{(n+1)}$, and $T(\eta, K)$ denotes T infected along η by the knot K , then $\rho_n(T(\eta, K)) = \rho_0(K)$, where $\rho_0(K)$ is the classical signature discussed in Lemma 6.2.

Harvey proved that the Grope filtration of the string link concordance group is a non-trivial filtration.

Theorem 5.1 (6.13 of [Har08] and 4.4 of [CH08]). *For each $n \geq 1$ and $m \geq 2$, the abelianization of $\mathcal{BG}_n^m / \mathcal{BG}_{n+1.5}^m$ has infinite rank; hence $\mathcal{BG}_n^m / \mathcal{BG}_{n+1.5}^m$ is an infinitely generated subgroup of $\mathcal{G}_n^m / \mathcal{G}_{n+1.5}^m$.*

With our knots $P_m \in \mathcal{G}_2$, we are able to close the index gap.

Theorem 5.2. *For each $n \geq 2$ and $m \geq 2$, the abelianization of $\mathcal{BG}_n^m / \mathcal{BG}_{n+0.5}^m$ has infinite rank; hence $\mathcal{BG}_n^m / \mathcal{BG}_{n+0.5}^m$ is an infinitely generated subgroup of $\mathcal{G}_n^m / \mathcal{G}_{n+0.5}^m$.*

Proof. For $n = 2$, let L_k denote the m -component boundary string link whose closure is the union of the $(m-1)$ -component trivial link and the knot P_k as defined in Section 3.1. Since $P_k \in \mathcal{G}_2$, the components of the closure of L_k bound disjoint Gropes of height 2, $m-1$ of which are discs. Thus $L_k \in \mathcal{BG}_2^m$. The linear independence of the L_k in $\mathcal{BG}_2^m / \mathcal{BG}_{2.5}^m$ follows from the argument below when $n \geq 3$.

Assume $n \geq 1$. We prove the statement for $n+2$. Let F denote the free group on m generators, and T be the trivial m -component string link, so that $F \cong \pi_1(D^2 \times I - T)$. Pick an element $[\eta] \in F^{(n)} - F^{(n+1)}$. By [CT07, Lemma 3.9], we may pick an embedded curve η in $D^2 \times I - T$ that bounds a disk in $D^2 \times I$ and that bounds a Grope of height n in $D^2 \times I - T$. Let $S_\eta = \{T(\eta, P_k) : P_k \text{ as defined in Section 3.1}\}$ where $T(\eta, K)$ is defined by item 3 of Remark 2. Since $\eta \in F^{(1)}$, there are disjoint surfaces bounded by the components of T that miss the curve η . Thus each $L \in S_\eta$ is a boundary string link. Since $P_k \in \mathcal{G}_2$, we have that if $L \in S_\eta$, then $\widehat{L} \in \mathcal{G}_{n+2}^m$. Thus, $S_\eta \subset \mathcal{BG}_{n+2}^m$.

By items 1 and 2 of Remark 2, $\rho_{n+2} : \mathcal{BG}_{n+2}^m / \mathcal{BG}_{n+2.5}^m \rightarrow \mathbb{R}$ is a well-defined homomorphism. By item 3 of Remark 2, the image of S_η under this homomorphism is $\rho_{n+2}(S_\eta) = \{\rho_0(P_k)\}$, which contains a \mathbb{Q} -linearly independent subset of \mathbb{R} by Lemma 6.2. The conclusion follows. \square

6. CALCULATION OF ρ -INVARIANTS

We now calculate the classical signatures of the P_m and discuss why they are linearly independent.

Lemma 6.1. *The 0-th-order signature of P_m is given by $\rho_0(P_m) = 2 - 2\frac{\theta_m}{\pi}$ where θ_m is the number satisfying $\cos(\theta_m) = \frac{2\sqrt[3]{m}-1}{2\sqrt[3]{m}}$ and $0 < \theta_m < \pi$.*

Proof. Let E_m denote the exterior of P_m . Recall that P_m is defined by surgery on the link in Figures 3 and 4. Depicted in Figure 11 is that link, isotoped for convenience.

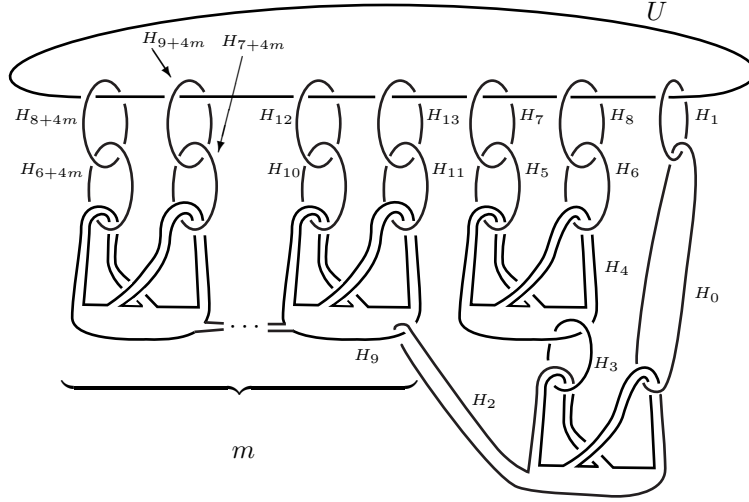

FIGURE 11. The surgery link defining P_m

After performing the handle cancellations

$$H_1 - H_0, H_7 - H_5, H_8 - H_6, H_{12} - H_{10}, H_{13} - H_{11}, H_{8+4m} - H_{6+4m}, H_{9+4m} - H_{7+4m},$$

we arrive at the link in Figure 12. Thus, we can describe E_m as the image of $S^3 - U$ after 0-surgery on the two component link $\{H_9, H_2\}$ as in Figure 12. This link is the result after performing 0-surgery on all components of the link in Figure 3 except for the bottom-most two. As discussed in the proof of Proposition 3.1, the link $\{H_9, H_2\}$ is a link in S^3 .

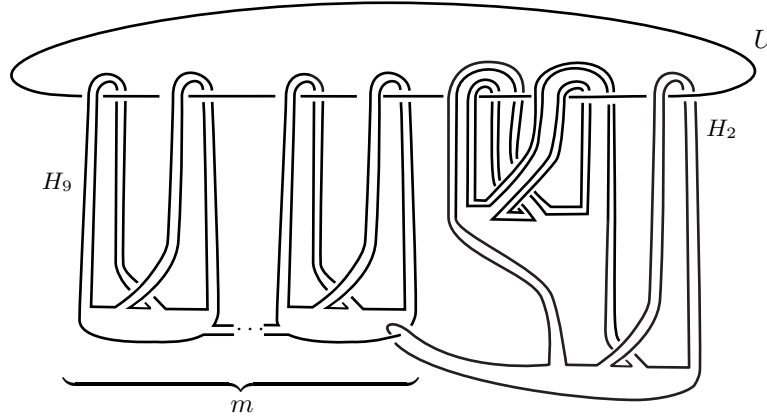

FIGURE 12. Zero surgery on the link $\{H_2, H_9\}$ yields E_m

As in [Rol76, §7.C], we can compute the Alexander module of E_m using these surgery instructions. Let α denote a lift of H_9 in the infinite cyclic cover of U , and let β denote the lift of H_2 that links α once. Let τ denote a generator of the group of covering translations. Recall that the matrix

$$\lambda = \begin{pmatrix} a + \sum_{i \in \mathbb{Z} - \{0\}} \text{lk}(\alpha, \tau^i \alpha) t^i & \sum_{i \in \mathbb{Z}} \text{lk}(\alpha, \tau^i \beta) t^i \\ \sum_{i \in \mathbb{Z}} \text{lk}(\beta, \tau^i \alpha) t^i & b + \sum_{i \in \mathbb{Z} - \{0\}} \text{lk}(\beta, \tau^i \beta) t^i \end{pmatrix}$$

where $a + \sum_{i \in \mathbb{Z} - \{0\}} \text{lk}(\alpha, \tau^i \alpha)$ equals the framing of H_9 and $b + \sum_{i \in \mathbb{Z} - \{0\}} \text{lk}(\beta, \tau^i \beta)$ equals the framing of H_2 , is a presentation matrix for the Alexander module of E_m .

Displayed in Figure 13 is the link $\{U, H_9, H_2\}$ after an isotopy. Figure 14 depicts the infinite cyclic cover of E_m .

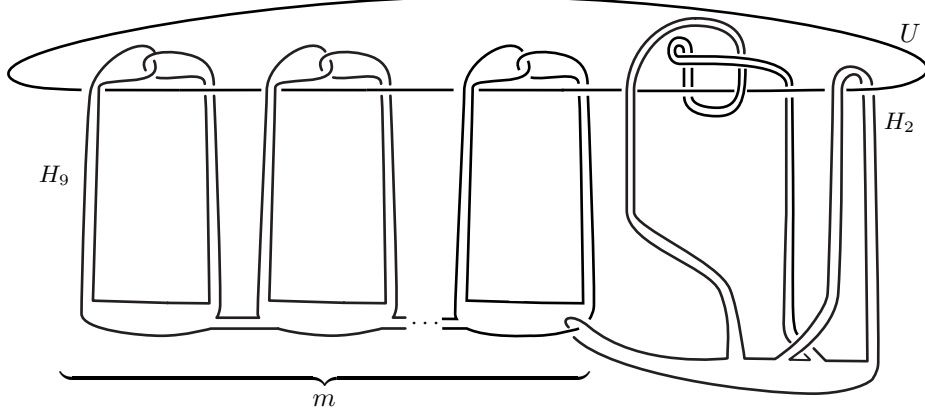

FIGURE 13. An isotopic image of the link from Figure 12

From Figure 14, one computes the Alexander matrix to be

$$\lambda = \begin{pmatrix} m(2 - t - t^{-1}) & 1 \\ 1 & t^2 + t^{-2} - 4(t + t^{-1}) + 6 \end{pmatrix}$$

The Alexander polynomial of P_m is

$$\Delta_m(t) = \det \lambda = m \left((t^3 + t^{-3}) - 6(t^2 + t^{-2}) + 15(t + t^{-1}) - \frac{20m - 1}{m} \right)$$

Recall that ρ_0 of a knot is equal to the integral of the Levine-Tristram signature function over the unit circle (normalized to have length one), and that this function is constant away from the roots of the Alexander polynomial. We claim that the polynomial $\Delta_m(t)$ has exactly two roots on the unit circle, namely $e^{\pm i\theta_m}$, where $\cos(\theta_m) = \frac{2\sqrt[3]{m} - 1}{2\sqrt[3]{m}}$ and $0 < \theta_m < \pi$. After proving this claim, we can conclude

the signature of λ is $+2$ when substituting $t = -1$, thus $\rho_0(P_m) = 2 - 2\frac{\theta_m}{\pi}$.

It is easy to verify that $e^{\pm i\theta_m}$ are roots of $\Delta_m(t)$ and that $\Delta_m(t)$ factors as

$$(3) \quad \Delta_m(t) = m \left(t - \frac{2\sqrt[3]{m} - 1}{\sqrt[3]{m}} + t^{-1} \right) \left(t^2 + t^{-2} - \left(4 + \frac{1}{\sqrt[3]{m}} \right) (t + t^{-1}) + 6 + \frac{2}{\sqrt[3]{m}} + \frac{1}{\sqrt[3]{m^2}} \right)$$

Assume that $e^{i\psi}$, where $\psi \in \mathbb{R}$, is a root of the second factor in Equation (3). Then ψ must satisfy the equation

$$4(\cos \psi)^2 - \left(8 + \frac{2}{\sqrt[3]{m}} \right) \cos \psi + 4 + \frac{1}{\sqrt[3]{m^2}} + \frac{2}{\sqrt[3]{m}} = 0$$

The quadratic formula yields $\cos \psi = \frac{4\sqrt[3]{m} + 1 \pm i\sqrt{3}}{4\sqrt[3]{m}}$. This implies that $\psi \notin \mathbb{R}$, and we conclude that $\Delta_m(t)$ has no other roots on the unit circle. \square

Lemma 6.2. *There is a subsequence of P_{m_j} of the knots P_m whose set of 0-th-order signatures is linearly independent over \mathbb{Q} .*

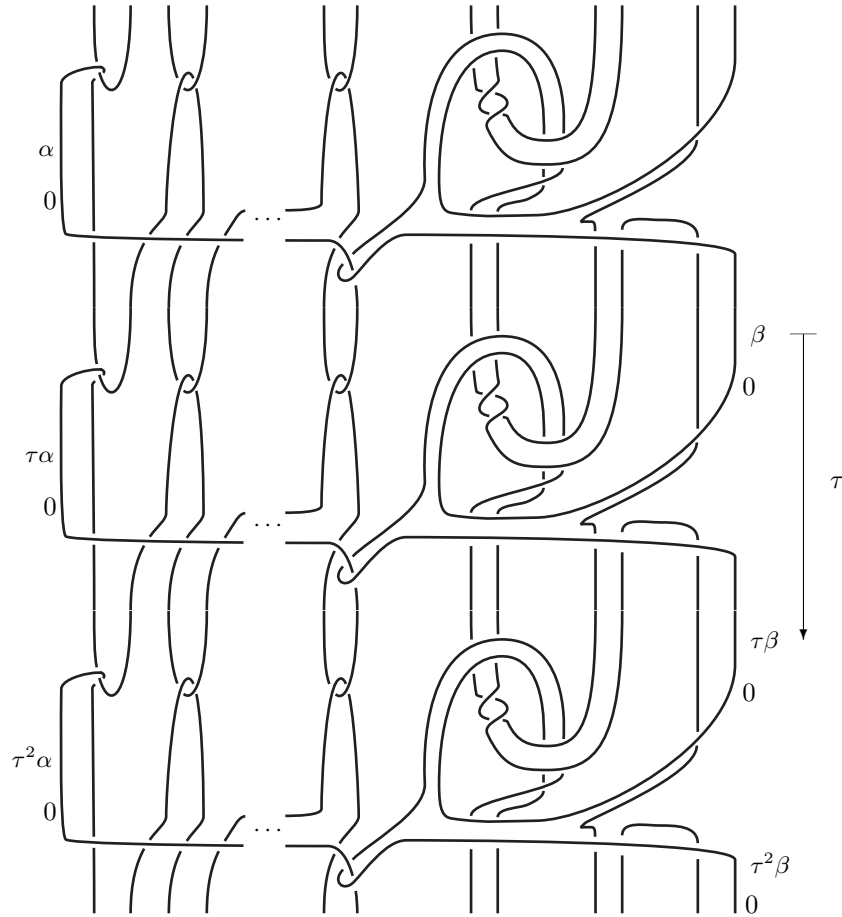

FIGURE 14. The infinite cyclic cover of E_m

Proof. By Lemma 6.1, it is sufficient to find a set $\{\theta_{m_j}\}_{j=1}^\infty$ that is linearly independent over \mathbb{Q} . Let $5 = p_1 < p_2 < p_3 < \dots$ be a sequence of prime integers satisfying $p_j \equiv 1 \pmod{4}$ for all j , and set $m_j = \frac{1}{64}(p_j - 1)^6 \in \mathbb{Z}$. It was shown in [COT04, Proposition 2.6] that $\{\theta_{m_j}\}_{j=1}^\infty$ is linearly independent over \mathbb{Q} . \square

REFERENCES

- [CH08] Tim Cochran and Shelly Harvey, *Homology and derived series of groups II: Dwyer's theorem*, *Geometry and Topology* **12** (2008), 199–232.
- [CHL07] Tim Cochran, Shelly Harvey, and Constance Leidy, *Knot concordance and higher-order Blanchfield duality*, Available at <http://arxiv.org/abs/0710.3082>, 2007.
- [COT03] Tim Cochran, Kent Orr, and Peter Teichner, *Knot concordance, Whitney towers and L^2 -signatures*, *Annals of Mathematics* **157** (2003), 433–519.
- [COT04] ———, *Structure in the classical knot concordance group*, *Commentarii Mathematici Helvetici* **79** (2004), 105–123.
- [CT07] Tim Cochran and Peter Teichner, *Knot concordance and von Neumann ρ -invariants*, *Duke Mathematical Journal* **137** (2007), no. 2, 337–379.
- [FT95] Michael Freedman and Peter Teichner, *4-manifold topology I: Subexponential groups*, *Inventiones Mathematicae* **122** (1995), 509–529.
- [GS99] Robert Gompf and András Stipsicz, *4-manifolds and Kirby calculus*, *Graduate Studies in Mathematics*, vol. 20, American Mathematical Society, 1999.

- [Har08] Shelly Harvey, *Homology cobordism invariants and the Cochran-Orr-Teichner filtration of the link concordance group*, *Geometry and Topology* **12** (2008), 387—430.
- [Jia81] Boju Jiang, *A simple proof that the concordance group of algebraically slice knots is infinitely generated*, *Proceedings of the American Mathematical Society* **83** (1981), no. 1, 189–192.
- [Kir78] Robion Kirby, *A calculus for framed links in S^3* , *Inventiones Mathematicae* **45** (1978), 35–56.
- [Rol76] Dale Rolfsen, *Knots and links*, Publish or Perish, Berkeley, CA, 1976.

DEPARTMENT OF MATHEMATICS, RICE UNIVERSITY, 6100 S. MAIN STREET, HOUSTON, TX 77005

E-mail address: `phorn@rice.edu`

URL: `http://math.rice.edu/~phorn`