

The Web of Connections between Tourism Companies in Elba: Structure and Dynamics

Luciano da Fontoura Costa

*Institute of Physics at São Carlos, University of São Paulo, P.O. Box 369,
São Carlos, São Paulo, 13560-970 Brazil. Email: luciano@ifsc.usp.br*

Rodolfo Baggio

*Master in Economics and Tourism, Bocconi University, via Sarfatti,
25, 20136 Milan, Italy. Email: rodolfo.baggio@unibocconi.it*

(Dated: 24th Mar 2008)

Tourism destination networks are amongst the most complex dynamical systems, involving a myriad of human-made and natural resources. In this work we report a complex network-based systematic analysis of the Elba (Italy) tourism destination network, including the characterization of its structure in terms of a set of several traditional measurements, the investigation of its modularity, as well as its comprehensive study in terms of the recently reported superedges approach. In particular, structural (the number of paths of distinct lengths between pairs of nodes, as well as the number of reachable companies) and dynamical features (transition probabilities and the inward/outward activations and accessibilities) are measured and analyzed, leading to a series of important findings related to the interactions between tourism companies. Among the several reported results, it is shown that the type and size of the companies influence strongly their respective activations and accessibilities, while their geographical position does not seem to matter. It is also shown that the Elba tourism network is largely fragmented and heterogeneous, so that it could benefit from increased integration.

Keywords: New applications of statistical physics, nonlinear dynamics, socio-economic networks, complex networks.

PACS numbers: 89.75.Hc, 89.75.Fb, 89.75.-k, 01.75.+m

*‘Make voyages! Attempt them! - there’s nothing else...’
(T. Williams)*

I. INTRODUCTION

Tourism is today probably the largest economic sector of the world economy. This economic system has fairly indefinite boundaries and comprises a wide diversity of organizations offering various products and services which exhibit very little homogeneity [1]. A tourism destination, loosely defined as the goal of a traveler, is considered a fundamental unit of analysis for the understanding of the whole tourism sector [2]. From a socio-economic viewpoint it consists of a number of companies and organizations (public and private) who manage different attractions and services to be offered a visitor [3]. A tourism destination is a complex adaptive system sharing many (if not all) of the characteristics usually associated with it: non-linear relationships among the components (companies and organizations), self organization and emergence of organizational structures, robustness to external shocks [3, 4]. The dynamic set of relationships which form the connective tissue holding together the system’s elements suggests a network approach to be indispensable for the understanding of a tourism destination. Several authors have used this perspective, mostly at a qualitative level [5, 6, 7]. Only a few, however,

have started applying quantitative methods and tools of this area in order to improve our knowledge of the structure and the dynamic behavior of a tourism system [8, 9, 10, 11, 12]. Today, more than ever, strong international competition induces an imperative to innovate to remain competitive. Many authors recognize that a pre-requisite for innovation is the capability to cooperate and collaborate efficiently and effectively. Tourism, more than most economic sectors, involves the development of formal and informal collaborations, partnerships and networks, and, rather obviously, the understanding of the patterns of linkages among the destination components and the assessment of the system’s structure are crucial points [9, 11, 13, 14]. Not less important is the effective access to local information and knowledge maintained by each participant of this intricate system.

With its origins going back to Flory [15] and Erdős-Rényi [16] works on random graphs, the area of complex networks [17, 18, 19, 20, 21] has established itself as one of the most dynamic and exciting alternatives for representing the structure and dynamics of the most diverse natural and human-made complex systems. One of the main reasons for the growing popularity and success of complex networks investigations consists in its generality for representing and modeling virtually any system composed of discrete parts (e.g. [22]), encompassing from protein-protein interaction (e.g. [23]) to scientific collaboration (e.g. [24]). In addition, by representing any type

of connectivity, complex networks are intrinsically suited for the investigation of more general types of dynamics, as opposite to the consideration of regular lattices adopted by the majority of previous works. As a matter of fact, growing attention in complex networks research has been focused on investigations of relationships between the structure and dynamics (e.g. [18, 20, 21]). Three of the most important subjects currently pursued by complex network scientists correspond to: (i) the characterization of the structure of complex systems by using several topological measurements (e.g. [19]); (ii) the investigation of the modularity (i.e. community finding) of complex networks; and (iii) studies of the relationship between structure and dynamics of complex systems.

The current work reports a complex network approach to the comprehensive investigation of the complex system corresponding to the tourism destinations in the Island of Elba. Each tourism agent is represented as a node, while the relationships between such agents are expressed by undirected edges. Our investigation is considered from the perspective of all the three main approaches identified above, namely structural characterization in terms of several measurements, identification of communities, and investigation of the relationship between structure and function by using the *superedges* concept introduced recently [25]. The work starts by describing the construction of the tourism destination network and proceeds by reporting the characterization of its structure and modularity, followed by the superedges approach to the structure:dynamics investigation.

II. THE TOURISM DESTINATION NETWORK

The destination analyzed here is the island of Elba, Italy. It belongs to the Tuscany Archipelago National Park (located in the central Tyrrhenian sea) and is the third Italian island. It is an important environmental resource and a significant contributor to the country’s economy. Almost 500,000 tourists spend some 3 million nights per year in several hundred accommodation establishments. Elba is considered a mature tourism destination with a long history and which has gone through a number of different expansion and reorganization cycles. The great majority of the stakeholders are small and medium sized companies, mostly family-run. Several associations and consortia operate on the island and try to recommend and develop different types of collaboration programs in an attempt to overcome the excessive ‘independence’ of the local companies [10, 26]. The destination network was built in the following way. The core tourism companies and associations operating at Elba are considered the nodes of a network whose ties are the relationships among them. According to the local tourism board, the list of companies comprises 1028 items. The links reflect ‘business’ relations between organizations. They were collected by consulting publicly available sources such as associations listings, management board compo-

sitions, catalogs of travel agencies, marketing leaflets and brochures, official corporate records (to assess the belonging to industrial groups). These data were then verified with a series of in-depth interviews to ‘knowledgeable informants’: director of tourism board, directors of associations, tourism consultants etc. This triangulation [27] allowed to validate existing linkages and uncover others. The so-obtained network can be reasonably estimated to be nearly 90% complete.

Finally, based on the information available, all the nodes were recorded along with their belonging to a specific type of business (8 types: e.g. hotels, travel agencies, associations etc.), geographical location (9 areas reflecting Elba’s municipalities) and size (small, medium, large, estimated on the real size of the company). Overall, 8 different types, 9 geographical areas and 3 sizes are present. Table I shows the different node groupings according to the three main classifications.

TABLE I: Types of Elba network operators.

Type of business		Geography		Size	
ID	Type	ID	Location	ID	Size
1	Associations	1	Porto Azzurro	1	Large
2	Cultural resources	2	Portoferraio	2	Medium
3	Food and Beverage	3	Capoliveri	3	Small
4	Hospitality	4	Rio Marina		
5	Intermediaries	5	Rio nell’Elba		
6	Public Organizations	6	Campo nell’Elba		
7	Transports/Rentals	7	Marciana		
8	Other services	8	Marciana Marina		
		9	All island		

III. CHARACTERIZATION OF THE TOURISM DESTINATION NETWORK

Complex network analysis methods were used to assess the topological characteristics of the system (for definitions and formulas see for example [19]). The obtained measurements, shown in Table II, were calculated by using available software packages (Pajek, Ucinet) complemented by some Matlab programs developed by one of the authors. Degree distribution scaling exponents are calculated according to Clauset et al. [28].

A modularity analysis was also performed. The modularity index [29] is shown in Table III with respect to several networks. The network nodes were divided into groups according to their typology as tourism operators and to the geographical location inside the island. Moreover, the method proposed by Clauset et al. [30] was used to identify algorithmically the community structure of the network (CNM in the first column). As a comparison, the last row gives the values calculated (CNM) for

a network of the same order as the Elba network with a random distribution of links (values are averages over 10 realizations). It is important to note that the groups identified by using this method (CNM) are different in number and composition from the others (geography and type). In order to better evaluate the different results, the last column of the table contains the average modularity over the groups (modularity/number of groups). It must be added here that the majority of the modules identified by the CNM algorithm fall within the resolution limits set by Fortunato and Barthélemy [31], thus suggesting the existence of a finer structure. However, for the objectives of the present investigation, the analysis was not conducted any further.

All in all, the main findings of the analysis of the main structural characteristics of the Elba network can be summarized as follows:

- The network shows a scale-free topology (power-law behavior of the degree distribution) which is consistent with that generally ascribed to many artificial and natural complex networks, moreover it shows a certain degree of small-worldness as shown by the proximity ratio;
- The general connectivity is very low (link density) with a very large proportion of disconnected elements;
- Clustering is quite limited, as is the efficiency, both at a local and global level;
- Assortativity is negative, contrary to the general findings that show positive values for social and economic networks;

TABLE II: Values of several measurements calculated for the Elba tourism destination network.

Metric	Value
Number of nodes	1028
Number of edges	1642
Density	0.003
Disconnected nodes	37%
Diameter	8
Average path length	3.16
Clustering coefficient	0.050
Proximity ratio	34.10
Average degree	3.19
Average closeness	0.121
Average betweenness	0.001
Global efficiency	0.131
Local efficiency	0.062
Assortativity coefficient	-0.164
Degree distribution exponent	2.32

- The modularity is generally very low. In one case, by type of business, it is negative. This means that companies (e.g. an hotel) tend to connect with some other company which is not of the same business.

These results provide quantitative evidence in favor of recognizing that the community of Elban tourism operators is very fragmented in nature. There appears to be little incentive to group or cluster in a cooperative or collaborative manner as evidenced by considering the clustering and assortativity characteristics. The study of modularity further confirms this finding. Sadly, this is a quite common phenomenon in many tourism destinations. Similar tourism operators dislike each other more than trying to combine their resources (at least some) to better cope with the market. A significant example of strong competition. These conditions are also problematic for an efficient flow of information and knowledge through the social system, and this may affect its capabilities for innovation and future competitiveness. These considerations are in general agreement with previous studies performed by using more traditional qualitative techniques [10, 26].

IV. THE SUPEREDGES APPROACH TO STRUCTURE AND DYNAMICS

The above characterization of the tourism network was restricted to topological features. Because real tourism is a dynamical process, it becomes important to consider also the study of its possible *dynamics*. A comprehensive approach to investigating and relating structure and dynamics in complex systems, herein called the *superedges approach*, was reported recently [25]. This approach is founded on the treatment of a complex network as a dynamical system, considering subsets of nodes as respective input and output, as illustrated in Figure 1.

For each specific choice of input and output, the connectivity between these two sets of nodes is characterized comprehensively in terms of the number of paths with distinct lengths extending from the input to the output (other measurements, such as the properties of the nodes along the identified paths, can be also considered). Such an approach provides a substantially more comprehensive characterization of the topology of the connections than the typically used measurements of node degree and shortest paths (actually, the shortest paths are naturally incorporated into the superedges approach). Observe also that the obtained distribution of paths yields a comprehensive characterization of the *structure* of the network with respect to the chosen input and output sets. Now, the dynamics of this configuration can also be studied by adopting a specific type of dynamics (e.g. traditional random walks, self-avoiding random walks, Ising, or integrate-and-fire neuronal models). The choice of the specific type of dynamics should reflect the nature of the problem under investigation and the respective questions

TABLE III: Modularity analysis of the Elba network.

Grouping	Number of groups	Modularity	Average Modularity
Geography	9	0.047	0.0052
Type	8	-0.255	-0.0319
CNM	11	0.396	0.0360
CNM (random)	23	0.606	0.0263

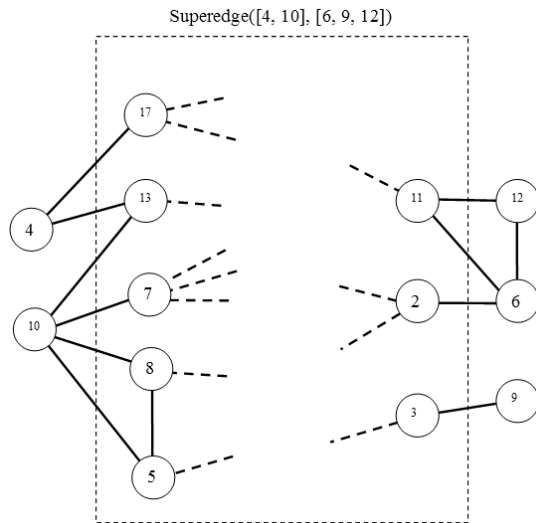

FIG. 1: Illustration of the superedge approach. Two sets of nodes are first selected as input (in this example $[4, 10]$) and output $(6, 9, 12)$. Then the connectivity between these two sets is quantified in terms of the number of paths of different lengths between those sets. The dynamics induced over the output nodes implied by stimulation of the input set (e.g. liberation of moving agents at those nodes) is also quantified in terms of a set of respective measurements. Finally, the structural and dynamical features are investigated for the identification of possible relationships (e.g. correlations).

which are being posed. Having chosen the specific dynamical rules, the network is stimulated from the input set of nodes (e.g. by liberating moving agents), while the respective effect over the output set is monitored and characterized in terms of a set of measurements. At the end of such simulations, we have a set of structural measurements and a set of measurements of the dynamics, which can then be related for instance by using Pearson correlation coefficient [19, 25].

Therefore, the superedges approach to relating structure and dynamics involves the following four basic steps: (i) selection of the input and output sets of nodes; (ii) characterization of the connectivity between these sets by considering the number of paths of distinct lengths interconnecting those sets (other complementary mea-

surements can be used); (iii) stimulating some type of dynamics through the input set and measuring the dynamics implied onto the output set; and (iv) relating the obtained structural and dynamical features. Though the superedges approach is underlain by these main steps, the specific decision about what measurement and dynamics to adopt are intrinsically related to each specific problem.

The relationship between the number of paths of a given length h between a node i and a node j (a topological measurement) and the transition probability from node i to node j (a dynamical measurement) deserves a preliminary discussion. Figure 2(a) shows a network where node $i = 1$ is connected to four other nodes (2 to 5) through several paths of length 3, more specifically: $Q_3(1, 2) = 3$; $Q_3(1, 3) = 1$; $Q_3(1, 4) = 2$; and $Q_3(1, 5) = 4$. The respective transition probabilities are: $P_3(2, 1) = 3/10$; $P_3(3, 1) = 1/10$; $P_3(4, 1) = 2/10$; and $P_3(5, 1) = 4/10$. Therefore, in case of multiple independent paths as in Figure 2(a), the transition probability will be directly proportional to the number of such paths. Consider now the network depicted in Figure 2(b). Now we have $Q_3(1, 2) = 5$; $Q_3(1, 3) = 1$; $Q_3(1, 4) = 4$; and $Q_3(1, 5) = 7$, and $P_3(2, 1) = 7/40$; $P_3(3, 1) = 1/10$; $P_3(4, 1) = 2/10$; and $P_3(5, 1) \approx 0.22$. So, it is clear that interdependencies between the paths tend to break the correlation between the number of paths and the transition probabilities. Yet another possible situation is shown in Figure 2(c), for which $Q_3(1, 2) = 3$; $Q_3(1, 3) = 1$; $Q_3(1, 4) = 2$; and $Q_3(1, 5) = 4$, and $P_3(2, 1) = P_3(3, 1) = P_3(4, 1) = P_3(5, 1) = 1/4$, i.e. though we have the same number of paths of length 2 between nodes 1 to 5 as in Figure 2(a), the respective probabilities are completely different, being determined by the first connections established by node 1. These three examples make it clear that there is no obvious relationship or correlation between the number of paths and the transition probabilities, which will ultimately be defined by additional topological details of the networks as well as the specific considered dynamics. For such reasons, the comparison of these two types of measurements presents good potential for characterizing and understanding the complex systems under analysis. For instance, a strong correlation between the number of paths and transition suggests the presence of independent paths such as in Figure 2(a).

Once the number of paths and transition probabilities

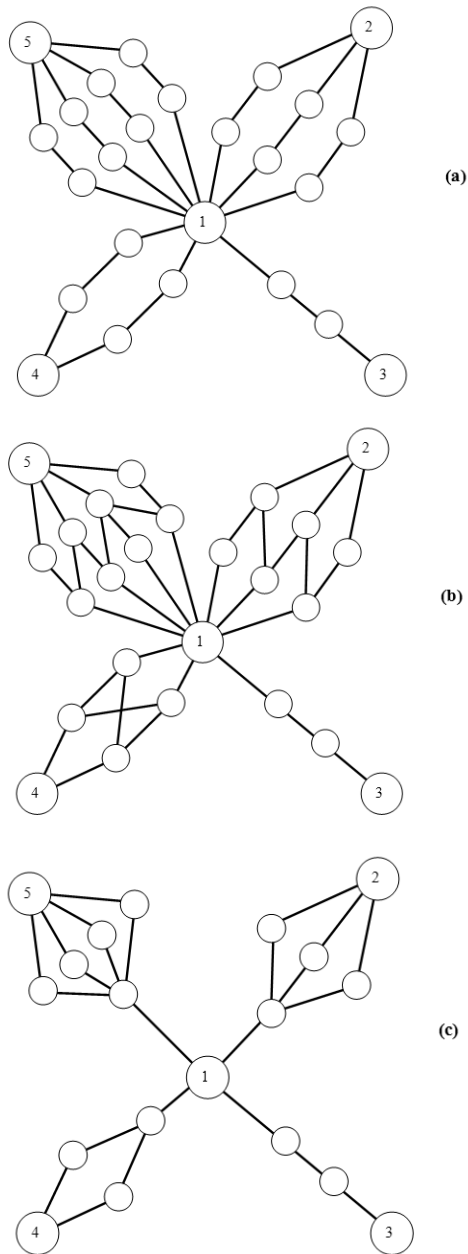

FIG. 2: Three reference situations regarding the relationship between the number of paths and transition probabilities between pairs of nodes. See text for explanation and discussion.

associated to each superedge have been calculated, it is possible to derive additional measurements such as the activation and accessibility of individual nodes [25]. More specifically, the *inward and outward activations* of a node i at length h are defined respectively as:

$$Act_{in_h}(i) = \frac{\sum_{j \in \Omega} P_h(i, j)}{N - 1}$$

$$Act_{out_h}(i) = \sum_{j \in \Omega} P_h(j, i)$$

where Ω is the set of all nodes different from i . The inward and outward activations express the intensity of accesses into and from each network node resulting from the respective topological and dynamical properties. In other words, the higher the inward accessibility of a node, the larger the number of accesses that node will receive. A similar interpretation holds for the outward activation, except that this value tends to become smaller than 1 because of the termination of paths at lengths smaller than the current h (branches leading to ‘dead-ends’). So, though the outward activation generally tends to diminish with h in a finite network, the way in which such a decrease takes place depends on the topology and dynamics in the network.

The *inward and outward accessibilities* of a node i are respectively defined as

$$Acc_{in_h}(i) = \frac{\exp(E_h(i, \Omega))}{N - 1}$$

$$Acc_{out_h}(i) = \frac{\exp(E_h(\Omega, i))}{N - 1}$$

where $E_h(\Omega, i)$ and $E_h(i, \Omega)$ are the entropies of the non-zero transition probabilities, defined as

$$E_h(i, \Omega) = - \sum_{j, P_h(i, j) \neq 0} \frac{P_h(i, j)}{N - 1} \log \left(\frac{P_h(i, j)}{N - 1} \right)$$

$$E_h(\Omega, i) = - \sum_{j, P_h(j, i) \neq 0} P_h(j, i) \log(P_h(j, i))$$

The inward and outward accessibilities quantify the effectiveness or balance of accesses into and from node i with respect to the other nodes. For instance, in case node i is connected to A nodes through paths of length h , a high outward accessibility $Acc_{out_h}(i)$ implies that the A nodes are accessed at similar frequencies. In addition, high outward accessibility also means that all the A nodes will be visited, in the average, in the shortest period of time by self-avoiding random walks initiating at node i . At the same time, a node i with high inward accessibility for a given h will tend to be equally visited by all the nodes at that distance. While the activation quantifies the intensity of directed accesses, the accessibility measures the equilibrium of such accesses. Therefore, these measurements provide complementary characterization of the dynamics of accesses unfolding in the network.

In the following section we report the configuration and application of the superedges approach to the analysis of the relationship between structure and function in tourism destination networks.

V. THE SUPEREDGES ANALYSIS OF TOURISM NETWORKS

Basically, there are four main aspects to be specified while applying the superedges approach: (a) the choice of the input and output sets; (b) the choice of the measurements of the interconnection topology; (c) the choice of the dynamics; and (d) the choice of the measurements of the dynamics. The selection of each of these aspects respectively to tourism destination networks are explained in the following.

Input/Output Selection: In order to obtain a systematic investigation of the relationship between the involved companies, we considering each possible node as input and output, implying a total of $N(N - 1)$ input-output configurations. Therefore, we will be taking into account all pairwise interactions between nodes.

Structural Measurements: In this work, we focus attention on the number of paths of distinct lengths, from $h = 1$ to 3, between each pair of node, as well as the number of nodes reachable from each node after h steps. This approach provides a comprehensive characterization of the connectivity between the nodes, intrinsically including the shortest paths. The selection of such a comprehensive set of measurements is justified because they reflect the existing potential relationship between the companies. In this work we consider the number of paths of length h between two nodes i and j , hence $Q_h(i, j) = Q_h(j, i)$, as the main topological superedge measurement.

Choice of Dynamics: The interactions between companies often take place through pairwise communication and querying, which typically induces chains of contact. For instance, one company may inquire about a service availability to another company, which in turn may contact another, and so on. Naturally, such chains of contacts avoid going through the same company more than once. In this work we model such contacting interactions in terms of self avoiding walks initiating at the input set of nodes and progressing through the network until the walk can proceed no longer or a fixed number H of steps is exceeded. Such a dynamics properly reflects the chain of contacts between companies as well as the avoidance of repeated contacts. Its main limitation is that it does not take into account possible preferential interactions between specific companies. Though preferential self-avoiding walks can be implemented in principle, we lack information about the preferential links between companies.

Dynamical Measurements: By simulating a large number of self-avoiding random walks initiating at the input node i , it is possible to estimate the transition probabilities $P(j, i)$, parametrized by the path length h , between the input and output (j) nodes. Such probabilities supply important information about the interactions resulting from the chosen dynamics, which may or not be related to the topological connectivity quantified by the superedges. Additional measurements of the outward ac-

cessibility of the nodes complements the characterization of the dynamics of communication between the companies with respect to the uniformity of contacts. More specifically, a company with high outward accessibility $Acc.out_h$ will be able to access all nodes at a distance h in the shortest period of time. In addition, the robustness of the communication of a company i and other companies at distance h tends to increase with the accessibility of i .

Figure 3 presents a hypothetical relationship between 11 tourism companies, where each column corresponds to a different *region*. The number of paths between these companies provides an important information which is not revealed by traditional measurements such as degrees, clustering coefficient and shortest paths. For instance, the fact that there are four paths (3 of length 3 and 1 of length 4) between companies 1 and 10 implies that searches for resources only found in the latter agency are much more likely to be well-succeeded than if the requested resource can only be found at company 11 (only one path exists between companies 1 and 11). Interestingly, though company 2 is linked to a single other company, in the same region, because it has access to company 1 through the path through companies 3 and 5, it will also have good chances of obtaining the services from company 10. However, a more complete picture of the interconnectivity and probability of visits between these companies requires the more systematic and comprehensive characterization provided by the superedges approach.

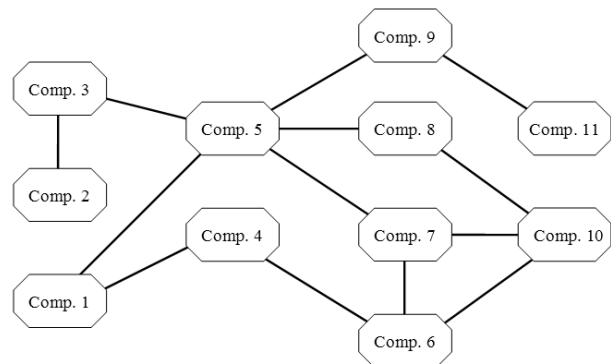

FIG. 3: Hypothetical web of connections between tourism companies.

Table IV gives the total number of companies $T_h(i)$ reached after $h = 1, 2, 3, 4$ steps from node i as well as the inward and outward activations and accessibilities for the companies in the hypothetical example in Figure 3. We have that the number of companies that can be reached for $h = 1, 2, 3, 4$ varies substantially for each node. For instance node 6 reaches 3 companies at $h = 2$ and 10 companies after $h = 4$ steps. However, the number of

companies that can be reached after h steps does not provide a good description of the interrelationship between the companies because some of them may be only rarely visited. The situation in Figure 2(b) illustrates this fact: though nodes 2, 3, 4 and 5 are all reachable from node 1 after 3 steps, node 3 will be visited only sporadically ($P_3(3, 1) = 1/10$) compared with the other nodes.

A clearer picture of the structural and dynamical interrelationships between each pair of companies can be provided by the superedges approach. From the perspective of activation, the company with the highest inward activation (the most frequently visited) is the agency 5, with $Act_{in_2}(5, \Omega) \approx 0.32$. The least frequently visited agencies are 3 and 9, with $Act_{in_2}(3, \Omega) = Act_{in_2}(9, \Omega) = 0.03$. Several companies are able to perform maximum accesses (i.e. $Act_{out_h}(i, j) = 1$) to other companies, but such a capability falls steeply for companies 3 and 9, for which $Act_{out_4}(\Omega, 3) = Act_{out_4}(\Omega, 9) = 0.38$. Such an abrupt decrease is a consequence of the fact that both nodes 3 and 9 have an initial branch leading to a dead-end (edges 3 to 2 and 9 to 11).

All companies have similar inward accessibilities, except for company 5, which presents particularly high values $Acc_{in_1}(i, \Omega) = 0.20$ and $Acc_{in_2}(i, \Omega) = 0.23$. The high inward activation and accessibility of company 5 is a consequence of its ‘centrality’ and high degree in the original network. The highest values of outward accessibility are verified for companies 4 and 10, with $Acc_{out_4}(\Omega, 4) = 0.72$ and $Acc_{out_4}(\Omega, 10) = 0.75$. Therefore, these two companies are capable of effective access to a total of 9 other companies after $h = 4$ contacts.

VI. SUPEREDGES ANALYSIS OF THE ELBA TOURISM NETWORK

Having described and discussed the structural and dynamical superedges measurements, we now proceed to their application to the real-world tourism destination of the Island of Elba. We restrict our attention to $h = 1, 2$, and 3. The isolated nodes of the original network were not considered in the superedges investigation, leaving out 644 nodes to be considered in our analysis.

We start by considering possible correlations between the number of distinct paths and the respective transition probabilities between pairs of nodes for each $h = 2$, and 3 (all transitions are equal to 1 for $h = 1$). Figure 4 shows the scatterplots obtained for these two situations, each involving a total of 414736 edges. The lack of positive correlation between these pairs of structural:dynamical measurements obtained for $h = 2$ (Fig. 4a) makes it clear that the paths of length 2 between pairs of nodes in the Elba tourism destination network are intensely interdependent (i.e. few triangles), implying situations involving several paths to have small transition probabilities because of deviations along highly interconnected paths. A different relationship was obtained for $h = 3$ (Fig. 4b), which includes two main components: a cloud of corre-

lated points and a group of points with high number of paths of length 3 and respective low transition probabilities. While the cases belonging to the former relationship are likely to correspond to relatively independent paths of length 3, the cases in the second group are related to intensely interdependent paths. Overall, the number of paths and transition probabilities between pairs of companies varied intensely, confirming great heterogeneity of the interconnections between the involved companies.

Figure 5 shows the distributions of the number of reachable companies at $h = 2$, and 3 with respect to the type, geography and size of the respective companies identified by the colors and symbols. It is clear from the scatterplots identifying the types of the companies that the number of reachable nodes at $h = 2$ and 3 depends of the type of companies. For instance, the companies of type 4 (hotels) tend to reach few companies for $h = 1$ but can reach a large number of companies after 2 steps. On the other hand, companies of types 1 and 5 (respectively associations and intermediaries) tend to reach many companies at $h = 1$. The companies of type 1, 4 and 5 are capable of reaching several other companies at $h = 3$, while organizations of type 2 (entertainment and cultural resources) can reach varying numbers of companies for this same number of steps. At the same time, no clear trends can be inferred while considering the geography of the networks. The reachability is strongly dependent of the size of the companies, with companies of size 1 (large) tending to reach many other companies for $h = 1$ and 3. Similar tendencies are verified for sizes 2 (medium) and 3 (small).

The inward and outward activations for $h = 2$ and 3 are shown in Figure 6. Again, the intrinsic activations depended strongly on the type and size of the companies, and had little relationship with the respective geographies. More specifically, companies of type 1, 4 and 5 tended to have their outward activations reduced more intensely for $h = 2$. Most types of companies underwent substantial reductions of outward activations for $h = 3$, but companies 4 and 5 exhibited markedly distinct behaviors with respect to the inward activation, with the former type of companies being characterized by smaller values of inward activations. The companies of size 1 and 2 exhibited more intense decrease of outward activation than companies of size 3 for $h = 2$, but companies of size 1 presented the highest inward activations for $h = 3$. This means that the latter sizes of companies are more likely to receive queries from other companies.

Figure 7 depicts the inward and outward accessibilities for each of the three classification schemes of companies, namely by type, geography and size, with respect to $h = 1, 2$, and 3. No clear tendencies are observed regarding the geographic types, but the inward and outward accessibilities are strongly related to the type and size of the involved companies. More specifically, companies of type 2, 3, 4 and 5 presented rather distinct accessibilities for all values of h , tending to be characterized by higher inward accessibility. This means that this type

TABLE IV: The number of reachable companies and inward and outward activations and accessibilities for $h = 1, 2, 3, 4$ with respect to the network in Figure 3.

Measurement	1	2	3	4	5	6	7	8	9	10	11
T_1	2	1	2	2	5	3	3	2	2	3	1
T_2	5	1	4	3	5	5	7	5	4	4	1
T_3	5	4	4	6	5	5	7	7	4	7	4
T_4	6	4	5	9	6	10	5	7	5	9	4
Act_in_1	0.07	0.05	0.12	0.08	0.23	0.12	0.09	0.05	0.12	0.12	0.05
Act_in_2	0.08	0.02	0.05	0.05	0.32	0.12	0.13	0.08	0.05	0.08	0.02
Act_in_3	0.10	0.05	0.05	0.10	0.13	0.08	0.13	0.12	0.05	0.11	0.05
Act_in_4	0.08	0.05	0.03	0.10	0.12	0.14	0.06	0.06	0.03	0.13	0.05
Act_out_1	1.00	1.00	1.00	1.00	1.00	1.00	1.00	1.00	1.00	1.00	1.00
Act_out_2	1.00	1.00	0.50	1.00	1.00	1.00	1.00	1.00	0.50	1.00	1.00
Act_out_3	1.00	1.00	0.50	1.00	1.00	1.00	1.00	1.00	0.50	1.00	1.00
Act_out_4	0.75	1.00	0.38	1.00	0.60	1.00	0.83	0.75	0.38	0.96	1.00
Acc_in_1	0.13	0.12	0.14	0.13	0.20	0.15	0.14	0.12	0.14	0.15	0.12
Acc_in_2	0.14	0.11	0.12	0.12	0.23	0.15	0.17	0.14	0.12	0.14	0.11
Acc_in_3	0.15	0.12	0.12	0.15	0.15	0.13	0.17	0.16	0.13	0.16	0.12
Acc_in_4	0.14	0.13	0.12	0.15	0.16	0.18	0.13	0.13	0.12	0.17	0.13
Acc_out_1	0.20	0.10	0.20	0.20	0.50	0.30	0.30	0.20	0.20	0.30	0.10
Acc_out_2	0.40	0.10	0.28	0.28	0.48	0.47	0.48	0.64	0.29	0.35	0.10
Acc_out_3	0.41	0.40	0.27	0.57	0.28	0.28	0.27	0.64	0.27	0.61	0.40
Acc_out_4	0.44	0.37	0.23	0.72	0.36	0.36	0.86	0.37	0.23	0.75	0.37

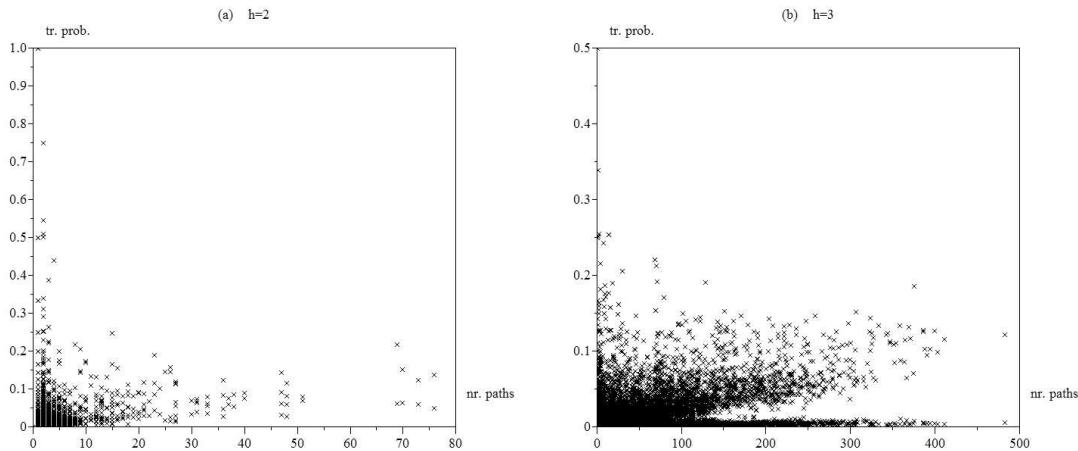

FIG. 4: The scatterplots of the number of distinct paths and transition probabilities for the Elba tourism destination network with respect to $h = 2$ (a) and 3 (b).

of companies is reached with higher efficiency by several other companies, i.e. each of these companies will be accessed more quickly by queries originating at the respective reachable companies. As observed for the number of reachable companies and inward/outward activations, the companies of size 1 tend to have a markedly dis-

tinct behavior also with respect to their inward/outward accessibilities. More specifically, this type of companies tend to be visited in a brief period of time by queries originating at the reachable companies.

All in all, in addition to the verified specific trends, the above results make it clear that the structural and

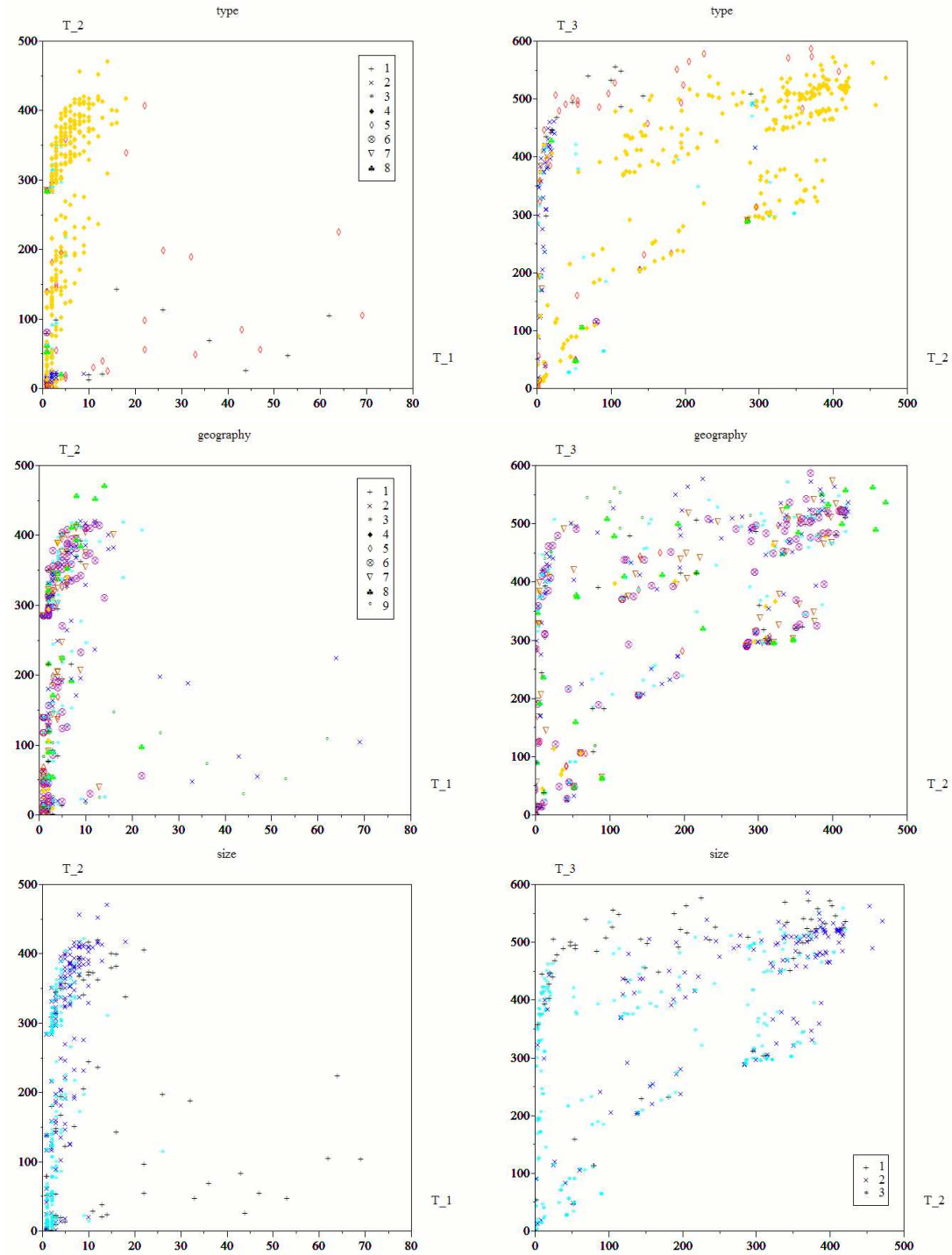

FIG. 5: The scatterplots of the number of distinct paths for the three classifications of the companies, namely *type*, *geography* and *size*.

dynamical properties of the considered companies depend strongly on their type and size, being much less affected by their respective geographical position.

By giving a 'physical' dynamical interpretation to

these results, it is possible to summarize the outcomes as follows. The geographical subdivision does not seem to have any sort of influence on the reachability of Alban tourism companies. This is in agreement with the

observed very low tendency to form ‘geographic’ communities coming from the static modularity analysis. Some companies or organizations (mainly associations and intermediaries) seem to be very active in reaching or being reached by other companies. The size of the company or organization matters, as larger entities tend to be more active than the smaller ones. This picture is in full agreement of what is known of the behaviors of tourism operators in the destination (see for example [10] or [26]). However, the identification of the specific trends exhibited by each type of company only became clearer through the superedges integration of the structural and dynamical features.

VII. CONCLUDING REMARKS

Tourism destination networks are amongst the most complex real-world systems, involving intricated structure and non-linear dynamics. Because of the economical importance of such systems, it becomes increasingly important to devise effective means for describing, characterizing and modeling these systems so that their structure and dynamics are better understood, allowing predictions, identification of possible improvements, and simulations aimed at evaluating the effects of varying scenarios and conditions. At the same time, complex networks research is now a mature area catering for all such requirements, from the characterization of the structure of the interaction between tourism companies to the relationship with the respective dynamics of interactions and information exchange. The current article has brought these two important areas together with respect to the comprehensive analysis of the Elba tourism destination network, a real-world structure which has been recently obtained through systematic and careful investigation including field data collection. The main contributions of our work are listed and discussed as follows:

Complete Real-World Example of the Superedges Approach: This work represents the very first comprehensive application of the superedges approach to a real-world network. As such, special care has been invested in order to making the respective concepts and interpretations clear from the context of the specific application, namely tourism destination structures. In particular, each of the choices which have to be made regarding the superedges methodology — including input/output, structural measurements, dynamics and dynamical measurements — have been motivated and justified with respect to the tourism application. The methodology was first illustrated with respect to a hypothetical simple network of companies, and then applied systematically to the real-world Elba tourism destination structure. As such, this first complete example can be used as a application reference guide for researchers intending to apply the superedges approach to other specific problems.

Comprehensive Structural Characterization: This work has presented one of the very first comprehensive

analysis of the topological characteristics of a tourism destination network, including traditional measurements, modularity as well as the number of distinct paths between pairs of nodes. A comparison, and the substantial similarity, of the outcomes with previous knowledge of the relationships among the tourism companies located at Elba stakeholders [10, 26] substantiates the effectiveness of our approach and results.

Comprehensive Dynamical Characterization: In addition to characterizing several structural properties of the tourism destination network, we performed a systematic investigation of a possible model of the dynamics of interactions between the involved companies, which was done by considering self-avoiding random walks. The effects of such a dynamics over the interaction between the companies has been effectively expressed in terms of the inward and outward activations and accessibilities.

Practical Implications: As for the static structural characterization, the results of the analysis conducted by using the dynamic superedges approach finds a justification and a verification in the established (qualitative) knowledge of the destination examined, its stakeholders and their behavior. This further confirms and reinforces the validity of the currently adopted approach. Although intriguing per se, the outcomes may have, at a destination management level even a bigger importance. A quantitative investigation method, with a strong theoretical basis, is able to provide descriptions and indications which, traditionally would have required long, and sometimes disputable, qualitative studies. The reliability of the conclusions one may find in combining the two approaches (qualitative and quantitative) can stand any comparison. The combination can be used in several ways, but principally in confirming or correcting a previous knowledge or the one coming from more traditional social studies. In our case, for example, we have seen it would be possible to improve the overall collaborative environment by considering our destination as a single ‘geographical entity’, disregarding any pre-set administrative division that, on the contrary, is the one normally used as a basis for the design of planning and policy actions. We have also identified, in an undisputable way, the stakeholders of this destination which would require the highest effort. It is possible, in other words, to reliably assign priorities to plans and actions and to distribute more productively resources (typically scarce) for their implementation. As many scholars in the field of tourism know, this is a crucial issue for an efficient and effective management of a destination and for favoring its socio-economic growth [1, 32].

The future works implied by our currently described research include but are not limited to the following possibilities:

Analysis of Other Destination Networks: It would be particularly interesting to apply the reported methodology to other destination networks, in order to allow comparisons between the respective structures and dynamics. Among the several related possibilities, it would

be interesting to compare the Elba network with networks obtained for tourism regions in other continents, such as America and Asia, in order to search for similar and distinct properties. The reported methodology can also be applied as a means to obtain a comparative analysis between tourism destinations in the first and third world.

Simulations: Given a network such as that analyzed in this work and its respective comprehensive characterization, it would be interesting to perform simulations involving the addition or removal of connections, in order to investigate effects of communication failures as well as the creation of new partnerships.

Inference of Growth Models: The comprehensive characterization of the Elba tourism destination network in terms of structural and dynamical features reported in this article has paved the way to attempts to obtain

growth models capable of reproducing the observed structure, possibly under the effect of the respective dynamics. For instance, after starting with a small random structure, new connections could be established while taking into account regional proximity, possibly involving the path-regular knitted network [33] to interconnect the companies according to their positions. Such growth models would allow a yet more complete understanding of tourism destination systems.

Acknowledgments

Luciano da F. Costa thanks CNPq (308231/03-1) and FAPESP (05/00587-5) for sponsorship.

-
- [1] N. Vanhove, *Economics of Tourism Destination* (Elsevier Butterworth-Heinemann, 2005).
- [2] J. Jafari, *Encyclopaedia of Tourism* (Routledge, 2000).
- [3] R. Baggio (2008), arXiv:physics/0701063.
- [4] B. Faulkner and R. Russell, *Pacif. Tour. Rev.* **1**, 93 (1997).
- [5] L. Lazzeretti and C. S. Petrillo, *Tourism Local Systems and Networks* (Elsevier, 2003).
- [6] A. Morrison, P. Lynch, and N. Johns, *Intl. J. Contemp. Hosp. Manag.* **16**, 197 (2004).
- [7] K. Pavlovich, *Tour. Manag.* **24**, 203 (2003).
- [8] N. Scott, C. Cooper, and R. Baggio, *Anns. Tour. Res.* **35**, 169 (2008).
- [9] N. Scott, R. Baggio, and C. Cooper, *Network Analysis and Tourism: From Theory to Practice* (Channel View, 2008).
- [10] V. Tallinucci and M. Testa, *Marketing per le isole* (Franco Angeli, Milano, 2006).
- [11] B. Bramwell and B. Lane, *Tourism Collaboration and Partnerships: Politics Practice and Sustainability* (Channel View, 2000).
- [12] R. Baggio, *Phys. A* **379**, 727 (2007).
- [13] C. Cooper, *Ann. Tour. Res.* **33**, 47 (2006).
- [14] N. Scott, C. Cooper, and R. Baggio, in *Advances in Tourism Marketing Conference* (Valencia, Spain, 2007).
- [15] P. J. Flory, *Journal of the American Chemical Society* **63**, 3083 (1941).
- [16] P. Erdős and A. Rényi, *Publicationes Mathematicae (Debrecen)* **6**, 290 (1959).
- [17] R. Albert and A. L. Barabási, *Rev. Mod. Phys.* **74**, 47 (2002).
- [18] M. E. J. Newman, *SIAM Rev.* **45**, 167 (2003).
- [19] L. da F. Costa, F. A. Rodrigues, G. Travieso, and P. R. V. Boas, *Adv. in Phys.* **56**, 167 (2007).
- [20] S. N. Dorogovtsev and J. F. F. Mendes, *Adv. in Phys.* **51**, 1079 (2002).
- [21] S. Boccaletti, V. Latora, Y. Moreno, M. Chavez, and D. Hwang, *Phys. Rep.* **424**, 175 (2006).
- [22] L. da F. Costa, O. N. Oliveira Jr, G. Travieso, F. A. Rodrigues, P. R. V. Boas, L. Antiqueira, M. P. Viana, and L. E. C. da Rocha (2007), arXiv:0711.3199.
- [23] H. Jeong, S. P. Mason, A. L. Barabási, and Z. N. Oltvai, *Nature* **411**, 41 (2001).
- [24] S. Lehmann, B. Lautrup, and A. D. Jackson, *Phys. Rev. E* **68**, 026113 (2003).
- [25] L. da F. Costa (2008), arXiv:0801.4068.
- [26] H. Pechlaner, V. Tallinucci, D. Abfalter, and H. Rienzner, in *Information and Communication Technologies in Tourism*, edited by A. J. Frew, M. Hitz, and P. O'Connor (Springer, Wien, 2003), pp. 105–114.
- [27] W. Olsen, in *Developments in Sociology: An Annual Review*, edited by M. Holborn (Causeway Press, Ormskirk, UK, 2004).
- [28] A. Clauset, C. R. Shalizi, and M. E. J. Newman (2007), arXiv:physics/0706.1062.
- [29] M. E. J. Newman and M. Girvan, *Phys. Rev. E* **69**, 26113 (2004).
- [30] A. Clauset, M. E. J. Newman, and C. Moore, *Phys. Rev. E* **70**, 066111 (2004).
- [31] S. Fortunato and M. Barthélemy, *Proc. Natl. Acad. Sci. USA* **104**, 3641 (2007).
- [32] J. R. B. Ritchie and G. I. Crouch, *The Competitive Destination: A Sustainable Tourism Perspective* (CABI Publishing, 2003).
- [33] L. da F. Costa (2007), arXiv:0711.2736.

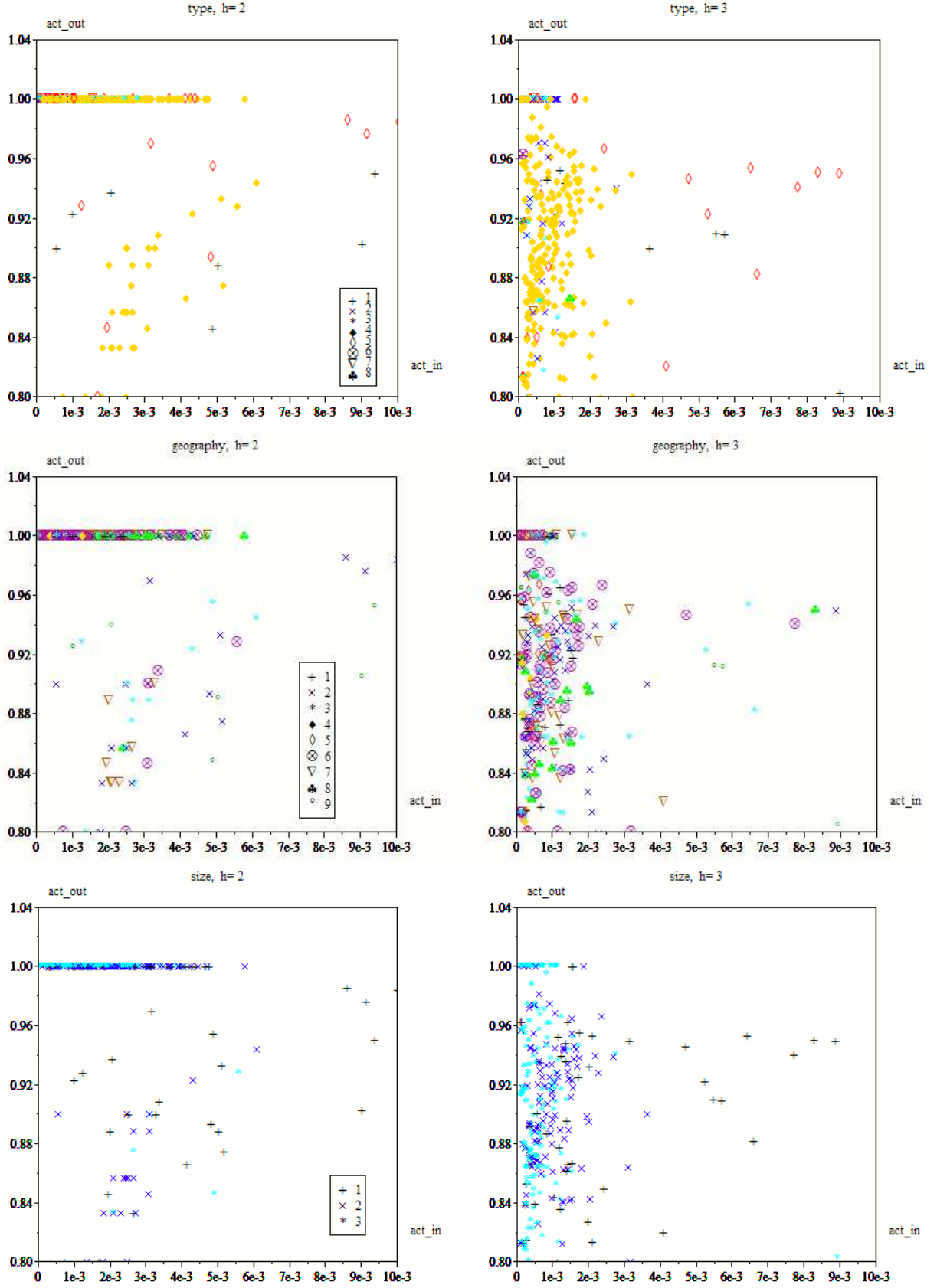

FIG. 6: The scatterplots of the inward and outward activations for the three classifications of the companies, namely *type*, *geography* and *size*.

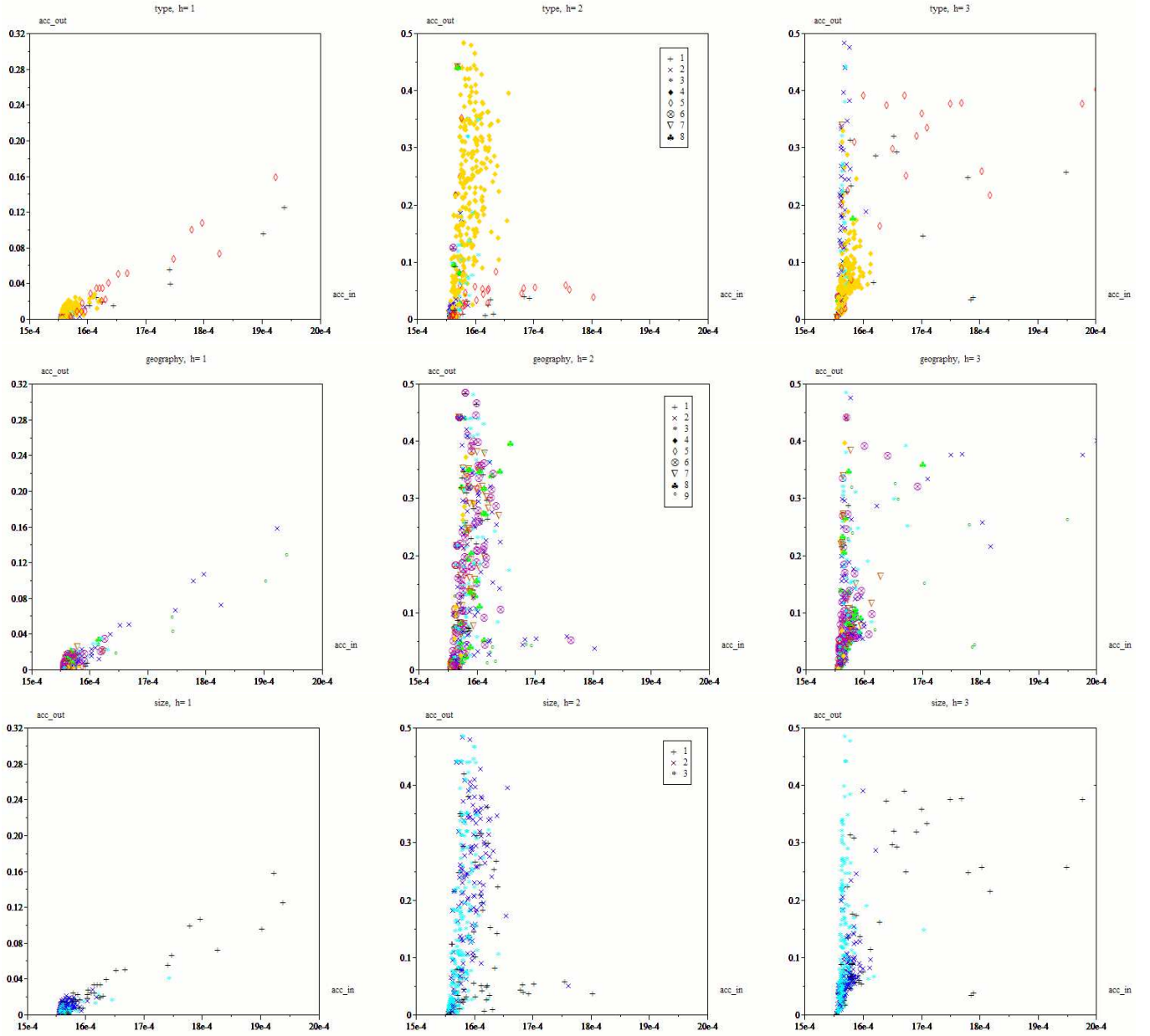

FIG. 7: The scatterplots of the inward and outward accessibilities for the three classifications of the companies, namely *type*, *geography* and *size*.